



HAL
open science

Deuteron Beam Power Ramp-Up at SPIRAL2

Angie Orduz, Marco Di Giacomo, Robin Ferdinand, Jean-Michel Lagniel,
Guillaume Normand, Didier Uriot

► **To cite this version:**

Angie Orduz, Marco Di Giacomo, Robin Ferdinand, Jean-Michel Lagniel, Guillaume Normand, et al.. Deuteron Beam Power Ramp-Up at SPIRAL2. 13th International Particle Accelerator Conference, Jun 2022, Muangthong Thani, Thailand. pp.MOPOST010, 10.18429/JACoW-IPAC2022-MOPOST010 . hal-03766865

HAL Id: hal-03766865

<https://hal.science/hal-03766865v1>

Submitted on 7 Dec 2022

HAL is a multi-disciplinary open access archive for the deposit and dissemination of scientific research documents, whether they are published or not. The documents may come from teaching and research institutions in France or abroad, or from public or private research centers.

L'archive ouverte pluridisciplinaire **HAL**, est destinée au dépôt et à la diffusion de documents scientifiques de niveau recherche, publiés ou non, émanant des établissements d'enseignement et de recherche français ou étrangers, des laboratoires publics ou privés.

DEUTERON BEAM POWER RAMP-UP AT SPIRAL2

A.K. Orduz*, M. Di Giacomo, R. Ferdinand, J-M. Lagniel, G. Normand
Grand Accélérateur National d'Ions Lourds (GANIL), Caen, France

D. Uriot, IRFU, CEA, Université Paris-Saclay, F-91191 Gif-sur-Yvette, France

Abstract

The SPIRAL2 linac commissioning started on 8 July 2019 after obtaining the authorisation to operate by the French Safety Authority. The tuning of the two Low Energy Beam Transport (LEBT), Radio Frequency Quadrupole (RFQ), Medium Energy Beam Transport (MEBT), Superconducting (SC) linac and High Energy Beam Transport (HEBT) was done with H^+ , ${}^4He^{2+}$ and D^+ beams during three periods of six months each in 2019, 2020 and 2021. The results obtained in 2021 with a D^+ beam are presented. The strategy for the tuning of the MEBT, including three rebunchers, is described. The comparison between the beam parameter measurements and reference simulations are also presented. The main results of the power ramp-up to 10 kW in the linac with a 5 mA D^+ beam are next reported. Finally, the extrapolation from the nominal power (200 kW) to the obtained results is analysed.

INTRODUCTION

SPIRAL2 is the major recent upgrade made of the GANIL facility [1]. The linear accelerator is composed of two LEBT lines, one for heavy ions ($A/Q < 3$) and one for H^+/D^+ , followed by a third one that collects the beam from the first two and matches it to the RFQ [2]. The MEBT to match the beam to the SC linac, is also designed to host a dipole to insert a heavier ion beam coming from a second injector (NEWGAIN project) [3] and includes a bunch selection system [4] allowing to inject from 1/100 to 1/1000 bunch in the linac for the Time of Flight (ToF) experiments in Neutron For Science (NFS) room.

The SC linac is composed of a low β section ($\beta = 0.07$) with 12 single-cavity cryomodules [5], and a high β section ($\beta = 0.12$) with 7 two-cavity cryomodules [6]. Finally, three HEBT lines deliver the beam to the linac Beam Dump (SAFARI) [7], NFS and S3 (Super Separator Spectrometer) experimental rooms as shown in Figure 1.

The different ions can be accelerated up to 14.5 MeV/A, 20 MeV/A and 33 MeV/A with a maximum beam power of 45 kW, 200 kW and 165 kW for mass to charge ratios (A/Q) 3, 2 and 1 respectively.

The ECR sources, LEBT lines and the RFQ were commissioned before getting the authorisation to operate the SC linac in July 2019 [2]. During the second semesters of 2019, 2020 and 2021, the MEBT, SC linac and HEBT lines were commissioned, the first NFS experiments were also done [1, 8].

The main 2020 objective was to perform a power ramp-up for a nominal current H^+ beam (5 mA) to validate the

whole accelerator before taking the risk of activating it with the deuterons. This target has been achieved on November 18, 2020, with a beam power of ~ 16 kW (4 mA, 12.6 % duty factor) [9]. Two measurements were very useful to control the beam loss variations during the power ramp-up: the pressure variations mainly along the low β section, and the count rate in the BLMs along the high β section and in the HEBT area.

The last part of the linac commissioning started in July 2021 with the tuning of the LEBT, MEBT, linac and HEBT lines for a ${}^4He^{2+}$ beam. The same tuning was then validated with a D^+ beam. The tuning was then optimised with the D^+ beam and the power was increased to 10 kW. One of the objectives for the commissioning team at this step was to increase the beam power in order to validate the tuning and detect problems (e.g. related to diagnostics or cavities).

The next section of this paper presents the strategy carried out to achieve this goal. The results obtained during the different optimization steps and their analysis are next also presented.

STRATEGY

The commissioning of SPIRAL2 in 2021 took place between July and December and was divided into four stages. In the first stage, the tuning of the LEBT, RFQ, MEBT, and linac with a ${}^4He^{2+}$ beam were carried out. The second stage consisted to drive the D^+ beam to SAFARI without optimising the linac tuning. Afterwards, the objective was to reduce the beam losses optimising the beam transport in the MEBT and SC linac before starting the power ramp-up to 10 kW with a 5 mA D^+ beam.

MEBT Tuning

The tuning of the MEBT, including the three rebunchers and the Single Bunch Selector (SBS), was carried out with a 1.2 mA ${}^4He^{2+}$ beam. The transverse rms emittance measured in the MEBT was 0.2π .mm.mrad. Two methods called “simplified” and “zero-crossing” were used for the rebuncher tunings. The simplified method uses phase measurements on the pick up at the end of the MEBT, first with the three rebunchers off and detuned. Then, the first rebuncher is turned on at its theoretical voltage value and a phase scan is performed. The cavity phase and amplitude are found comparing the phase measurements and computations done tracking a reference particle in the rebuncher field map. The process is replicated for the next two rebunchers. The issue with this method comes from phase measurement shifts induced by a strong debunching due to the long distance between the RFQ output and the pick-up, as well as between the first and second rebunchers and the pick-up.

* angie.orduz@ganil.fr

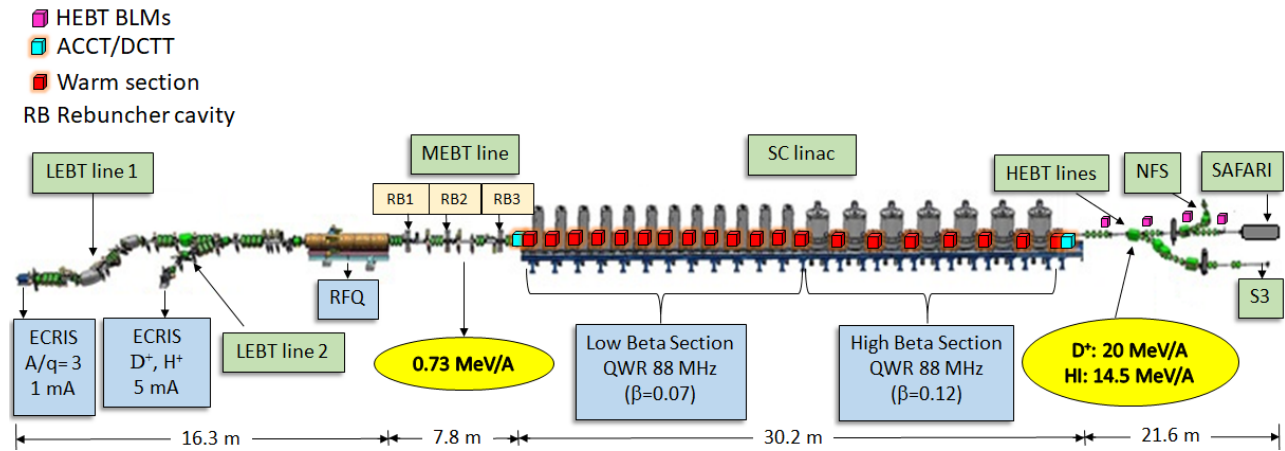

Figure 1: SPIRAL2 SC linac layout.

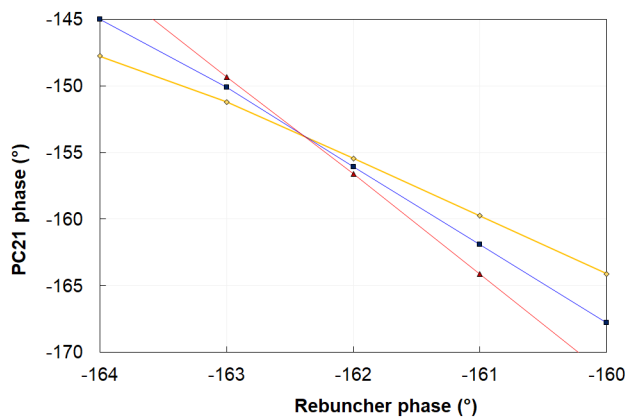

Figure 2: Phase scan for rebuncher N° 1.

For the zero-crossing method, three limited phase scans are done at nominal voltage, nominal + 20% and nominal - 20% around the buncher phase ($\phi_s = -90^\circ$). The rebuncher phase is then found from the three scan intersection point (Figure 2). In this way, the beam stays sufficiently well bunched at the pick-up position and the phase measurements are accurate.

The MEBT transverse emittances are in agreement with the expected ones for D^+ beam as is shown in Figure 3 with a measured transverse rms emittance of $0.18 \pi \cdot \text{mm} \cdot \text{mrad}$. Table 1 shows a good agreement between the measurements and TraceWin [10] reference Courant-Snyder parameters for a 5 mA D^+ beam at the emittance meter position (simulation carried out with 400000 particles).

Table 1: MEBT Simulated and Measured Courant-Snyder Parameters for 5 mA D^+

Margin	Reference	Measurement
Alpha X, X'	4.17	4.11
Beta X, X' (mm/ $\pi \cdot \text{mrad}$)	-0.23	-0.18
Alpha Y, Y'	0.92	1.07
Beta Y, Y' (mm/ $\pi \cdot \text{mrad}$)	-0.33	-0.35

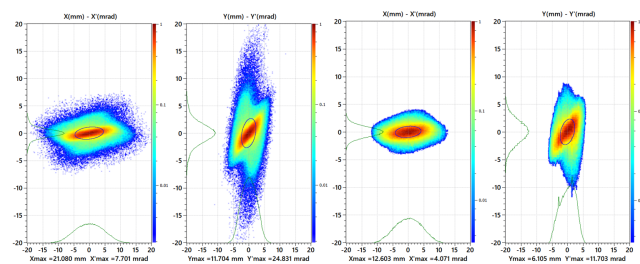

Figure 3: Transversal phase space in the MEBT for 5mA deuteron beam: reference simulation (left) and measurement (right).

Immediately after the linac tuning with $^4\text{He}^{2+}$, a deuteron beam produced by the other source was transported in the LEBT, RFQ, MEBT, linac and HEBT to SAFARI. This 5 mA D^+ beam with 1 ms pulse length at 1 Hz was accelerated on July 30, with a transmission higher than 99.8%, without any optimisation of the tuning. During the next stage, beam transport was optimised in the MEBT and the linac, mainly by making adjustments to the LLRF control.

The beam losses were minimized by monitoring the transmission from the ACCT/DCTT, the BLM count rates, the pressure variations in the linac warm sections, the alignment with the BPM, and the segmented loss ring and beam dump temperature measurements at the end of the HEBT.

POWER RAMP-UP

The power ramp-up with the deuteron beam was performed on November 16, 2021. The beam current was first increased by opening the slits of the LEBT in four steps up to 5 mA at the linac output, with 1 ms pulses at 10 Hz. The 10 kW beam power was obtained at 11:59 with 5% duty cycle at 38.3 MeV. As shown in Figure 4 the transmission during the duty cycle increase was 100%, within the error bar of 0.12% ($6 \mu\text{A}$). The beam total energy was 38.3 MeV instead of 40 MeV because the 11th cavity of high β section (cryomodule #6, cavity 1) was not used due to an amplifier failure.

Content from this work may be used under the terms of the CC BY 4.0 licence (© 2022). Any distribution of this work must maintain attribution to the author(s), title of the work, publisher, and DOI

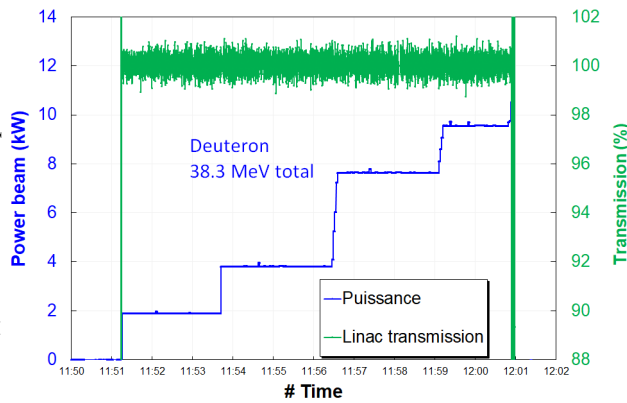

Figure 4: Beam power (blue) and transmission (green) of the 5 mA deuteron beam during the ramp-up to 10 kW.

The low β cavities #6 and #7 stripped at the duty cycle increase step from 5% to 6% because the field stability was out of the requested margin. There was a 7% decrease of cavity #6 field as shown in Figure 5. For cavity #7 the field decrease of 1.5% was due to a bad tuning of the amplifier.

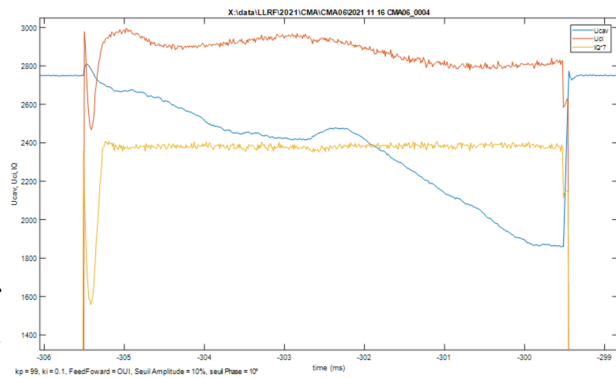

Figure 5: Cavity field (blue), RF power amplifier (orange), and amplifier power control (yellow) for cavity #6.

Figure 6 shows the beam loss measurements by the BLM at 10 kW, the linear extrapolation to 100% duty cycle and the thresholds at 1 W/m for linac operation. The margin between the extrapolation and the 1 W/m limit indicates the feasibility to work with the nominal 200 kW deuteron beam power.

Figure 7 shows the pressure variations along the SC linac with two peaks observable during the 10 kW run. The pressure variation error bars include an absolute measurement error of $\pm 30\%$ and an instrument reproducibility of 5%. The first one in warm section #6 (middle of the low β section) is weak, the second in warm section #18 (end of high β section) was attributed to the cavity #7 amplifier bad tuning. However, these losses are not problematic according to the measured transmission.

Figure 8 shows the rise in temperatures at each SAFARI thermocouple at 10 kW. The maximum temperatures in the bottom right zone indicate that the beam was not perfectly aligned, but well within the limits. The temperature rises along the beam dump shows a power deposition in agreement with the design studies [7].

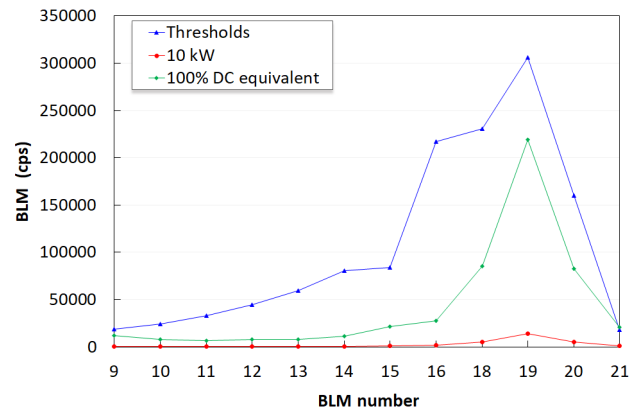

Figure 6: BLM count rate: thresholds (blue), 10 kW deuteron beam (red) and extrapolation to 200 kW (green).

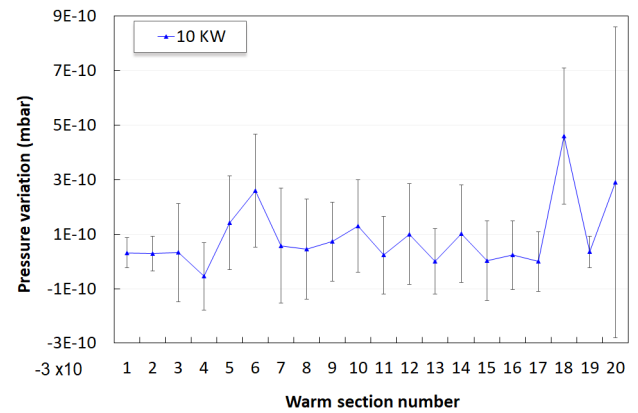

Figure 7: Pressure variation at 10 kW beam power.

CONCLUSION

The SPIRAL2 facility has been successfully commissioned with deuterons. The 2023 objective is to validate the linac with $A/Q = 3$ particles for the Super Separator Spectrometer S3 experimental room.

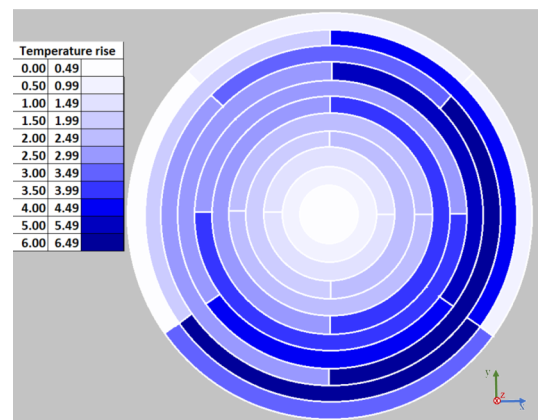

Figure 8: Temperature rise in SAFARI thermocouples at 10 kW deuteron beam.

REFERENCES

- [1] H. Goutte and N. Alahari, "Microscopes for the Physics at the Femtoscale: GANIL-SPIRAL2," *Nuclear Physics News*, vol. 31, pp. 5–12, 2021. doi:10.1080/10619127.2021.1881363
- [2] R. Ferdinand *et al.*, "Final Results of the SPIRAL2 Injector Commissioning," in *Proc. 10th Int. Particle Accelerator Conf. (IPAC'19)*, Melbourne, Australia, May 2019, pp. 848–851. doi:10.18429/JACoW-IPAC2019-MOPTS006
- [3] New Ganil Injector NEWGAIN, White Book, <https://www.ganil-spiral2.eu/scientists/ganil-spiral-2-facilities/accelerators/newgain>
- [4] M. Di Giacomo *et al.*, "Proton beam commissioning of the SPIRAL2 Single Bunch Selectors," *Journal of Instrumentation*, vol. 15, p. T12011, 2020. doi:10.1088/1748-0221/15/12/T12011
- [5] C. Marchand *et al.*, "Performances of Spiral2 Low and High Beta Cryomodules," in *Proc. 17th Int. Conf. on RF Superconductivity (SFR2015)*, MWhistler, Canada, Dec. 2015, pp. 967–972. doi:10.18429/JACoW-SRF2015-WEBA04
- [6] G. Orly *et al.*, "Spiral2 cryomodules B tests results," in *Proc. 16th Int. Conf. on RF Superconductivity (SFR2013)*, Paris, France, Sep. 2013, paper MOP010, pp. 95–99.
- [7] E. Schibler and L. Perrot, "SAFARI, an Optimized Beam Stop Device for High Intensity Beams at the SPIRAL2 Facility," in *Proc. 25th Int. Linear Accelerator Conf. (IPAC'11)*, San Sebastián, Spain, Sep. 2011, paper TUPC070, pp. 1162–1164.
- [8] A. K. Orduz *et al.*, "Beam Commissioning SPIRAL2," in *Proc. 12th Int. Particle Accelerator Conf. (IPAC'21)*, Campinas, Brazil, May 2021, pp. 2540–2543. doi:10.18429/JACoW-IPAC2021-WEXB05
- [9] A. K. Orduz *et al.*, "Commissioning of the SPIRAL2 SC Linac: Beam Power Ramp-Up," *Phys. Rev. ST Accel. Beams*, vol. 25, no. 6, p. 060101, Jun. 2022. doi:10.1103/PhysRevAccelBeams.25.060101
- [10] D. Uriot and N. Pichoff, "Status of TraceWin Code," in *Proc. 6th Int. Particle Accelerator Conf. (IPAC2015)*, Richmond, VA, United States, May 2015, pp. 92–94. doi:10.18429/JACoW-IPAC2015-MOPWA008