



HAL
open science

Methane conversion in homogeneous discharge at atmospheric pressure in Ar-CH₄ mixtures

L Magne, N Blin-Simiand, P Jeanney, S Pasquiers

► **To cite this version:**

L Magne, N Blin-Simiand, P Jeanney, S Pasquiers. Methane conversion in homogeneous discharge at atmospheric pressure in Ar-CH₄ mixtures. 25th Europhysics Conference on Atomic and Molecular Physics of Ionized Gases (ESCAMPIG), Jul 2022, Paris, France. hal-03766045

HAL Id: hal-03766045

<https://hal.science/hal-03766045v1>

Submitted on 31 Aug 2022

HAL is a multi-disciplinary open access archive for the deposit and dissemination of scientific research documents, whether they are published or not. The documents may come from teaching and research institutions in France or abroad, or from public or private research centers.

L'archive ouverte pluridisciplinaire **HAL**, est destinée au dépôt et à la diffusion de documents scientifiques de niveau recherche, publiés ou non, émanant des établissements d'enseignement et de recherche français ou étrangers, des laboratoires publics ou privés.

Methane conversion in homogeneous discharge at atmospheric pressure in Ar-CH₄ mixtures



L. Magne*, N. Blin-Simiand, P. Jeanney, S. Pasquiers

Université Paris-Saclay, CNRS, Laboratoire de Physique des Gaz et des Plasmas, 91405 Orsay, France

*lionel.magne@universite-paris-saclay.fr



AIM OF THE STUDY: this work is our first step in the study of the physico-chemical processes involved in the conversion of methane by non-thermal plasmas in Ar-CH₄ mixtures. A UV pre-ionized photo-triggered discharge reactor is used, it allows to work with an homogeneous plasma, a uniform electric field and a controllable deposition of electric energy in the plasma even at atmospheric pressure. The moderate values of the reduced electric field E/N, associated with the preceding properties, allows a 0D self-consistent physical and chemical modelling, without restrictive hypothesis on the physics of the energy deposition. Initial methane concentrations are in the range 250-1000 ppm at atmospheric pressure, chromatographic diagnostics are used to identify and quantify CH₄ and by-products.

EXPERIMENTAL SETUP

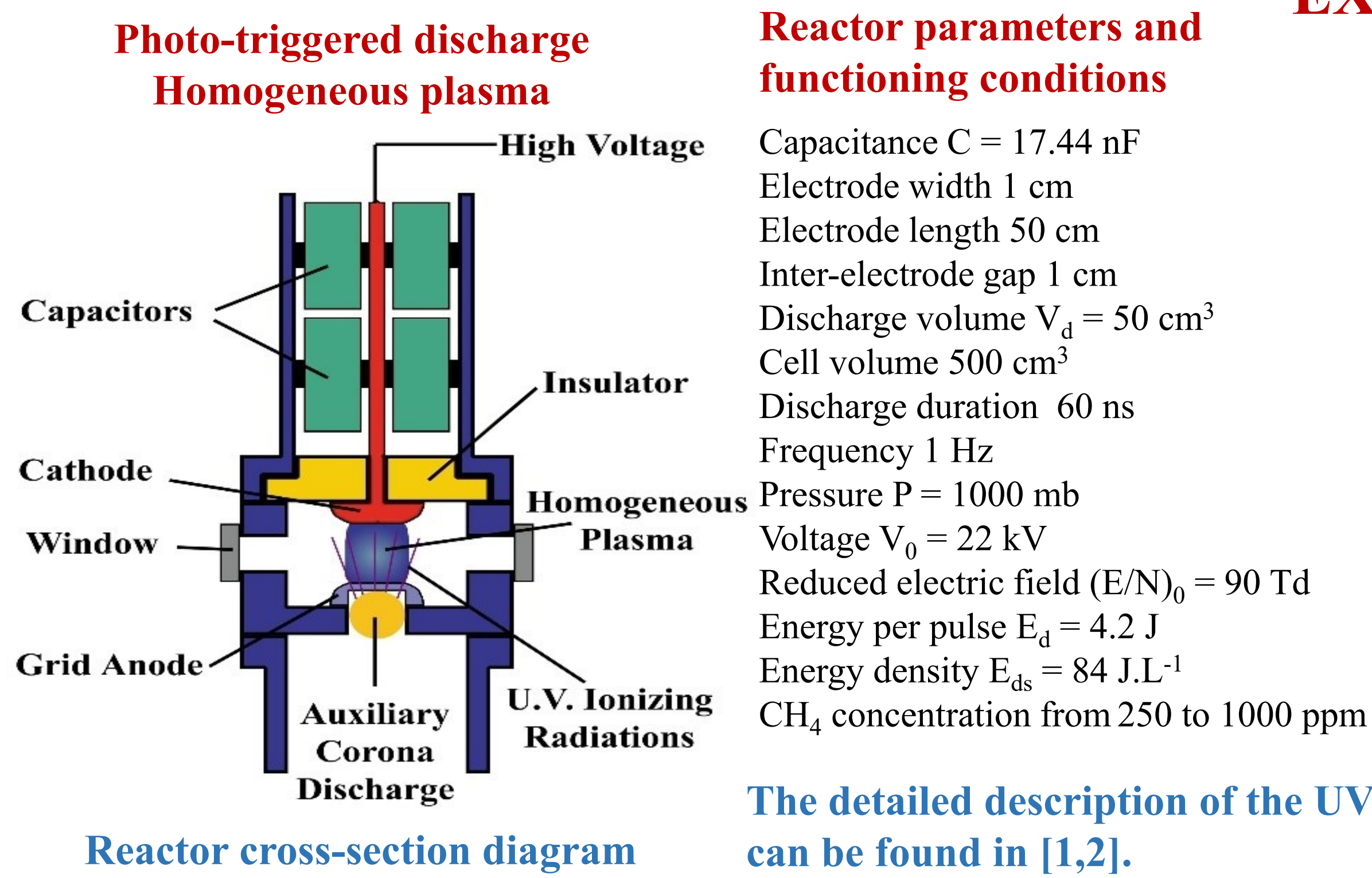

General principle of operation

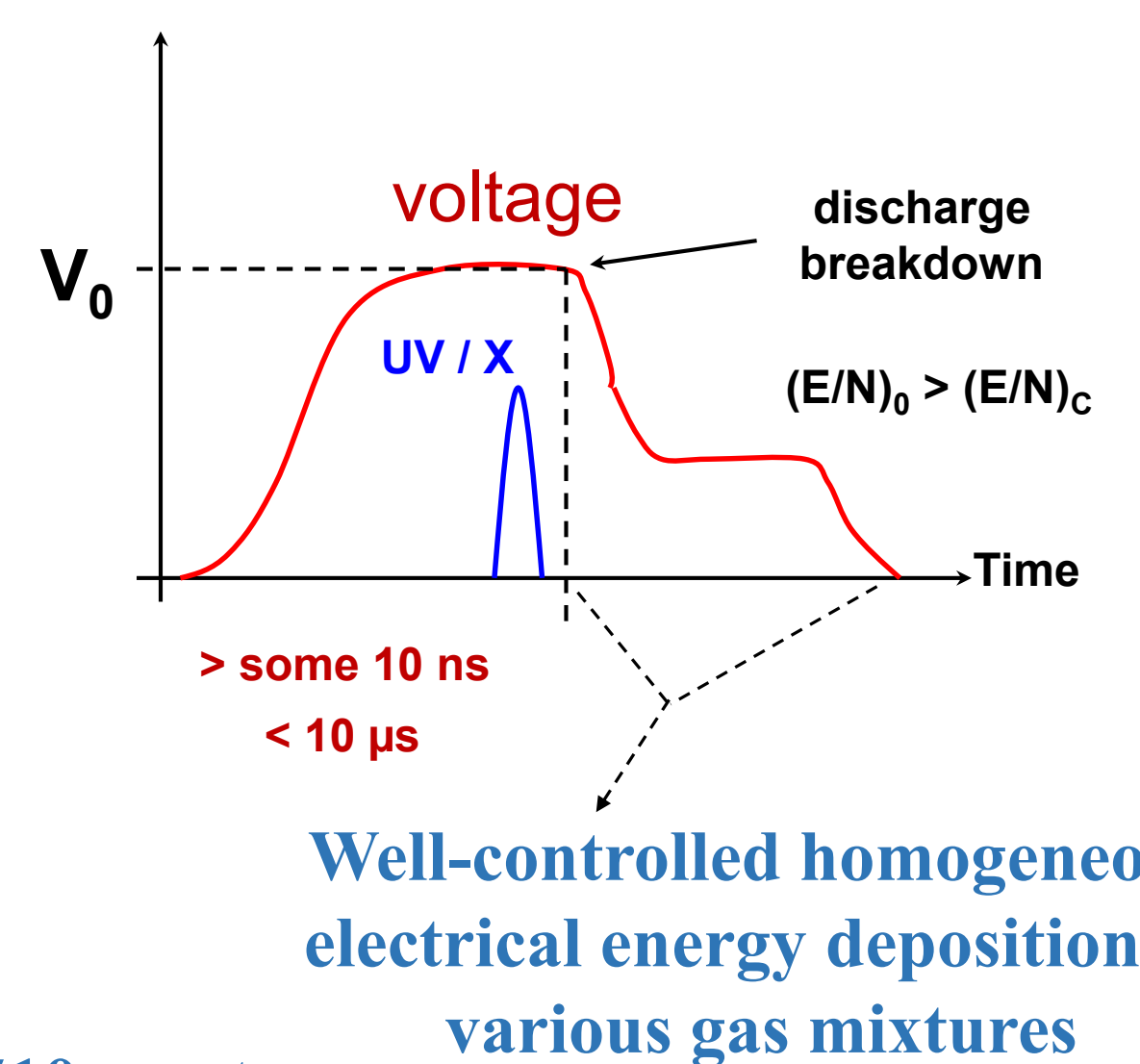

Reactor arrangement and chemical diagnostics in the closed gas circuit loop.

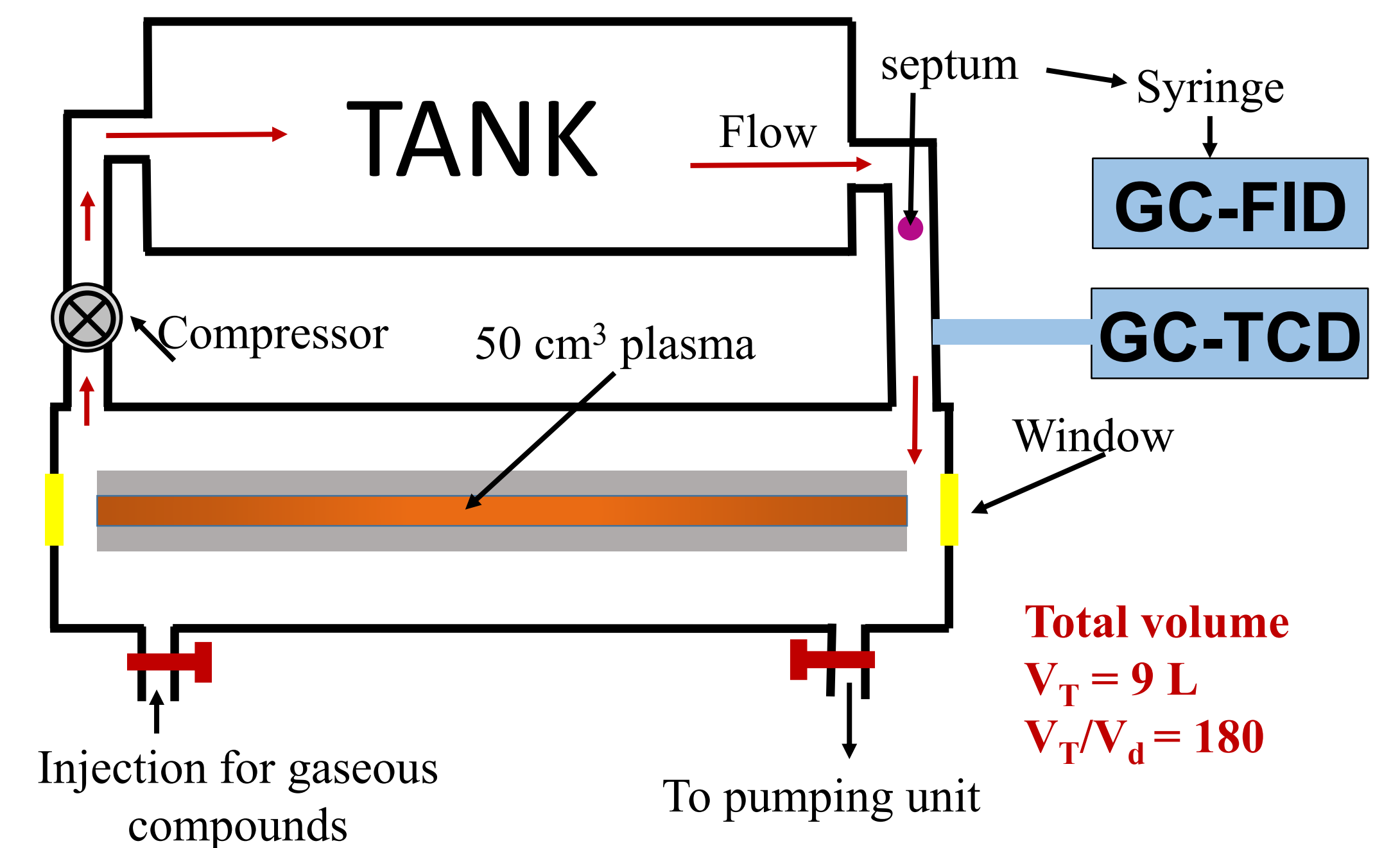

EXPERIMENTAL RESULTS

CH₄ and main by-products measurements in the gas circuit: H₂ with GC-TCD and hydrocarbons with GC-FID

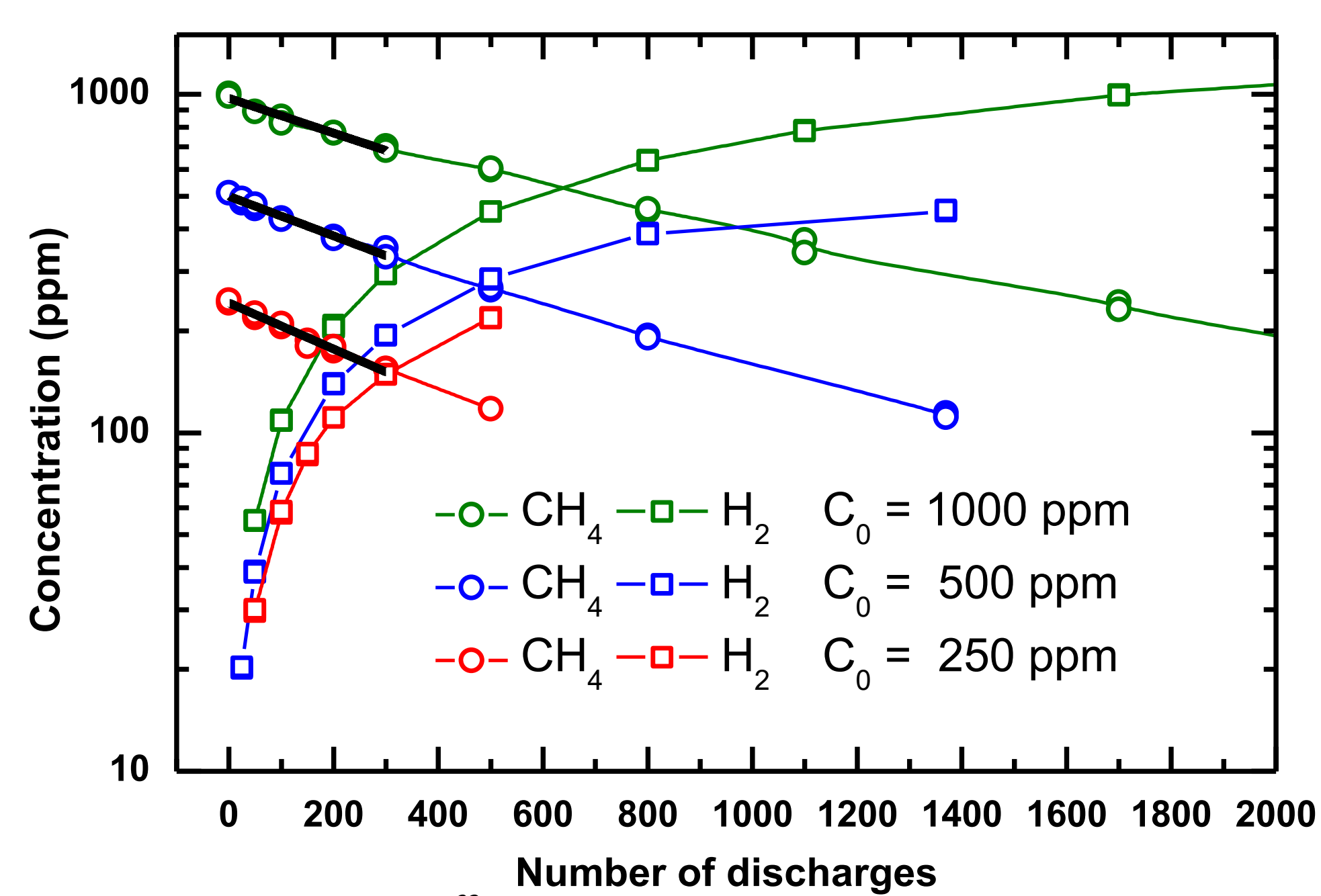

The CH₄ evolution versus the number of discharges n is fitted with an exponential law (up to n=300) to evaluate the conversion in the first pulse in the gap. This value will be compared to the results given by the self-consistent 0D model of the discharge.

C ₀ (ppm)	N _c	E _c (J.L ⁻¹)	C ₀ -CH ₄ (n=1) in the gap (ppm)
1000	844	394	213 (21%)
500	741	345	121 (24%)
250	638	298	70 (28%)

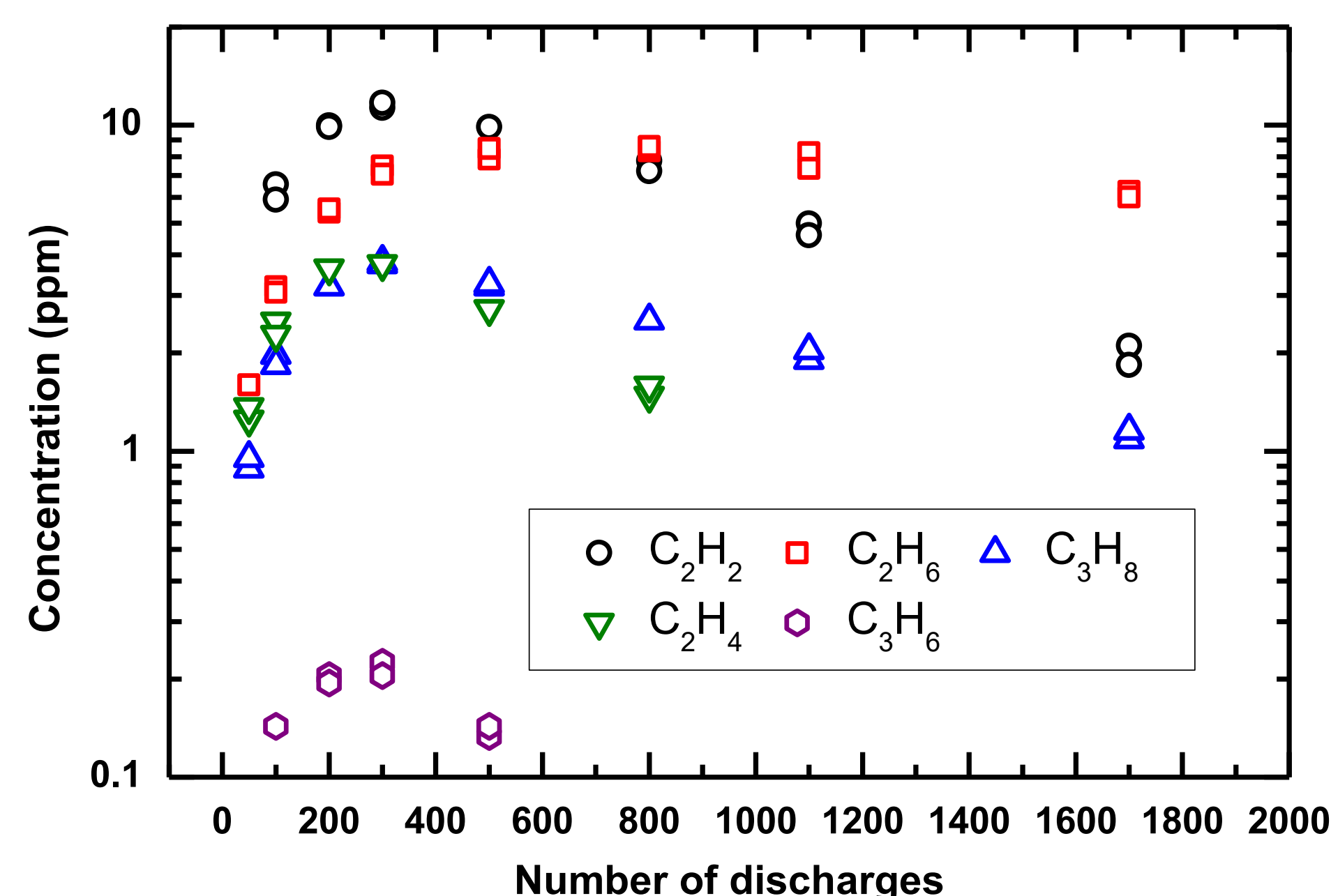

The maximum concentration of the measured by-products seems to be reached around 300 discharges. The concentration of unsaturated hydrocarbons C₂H₂, C₂H₄ and C₃H₆ decreases faster than that of saturated hydrocarbons C₂H₆ and C₃H₈.

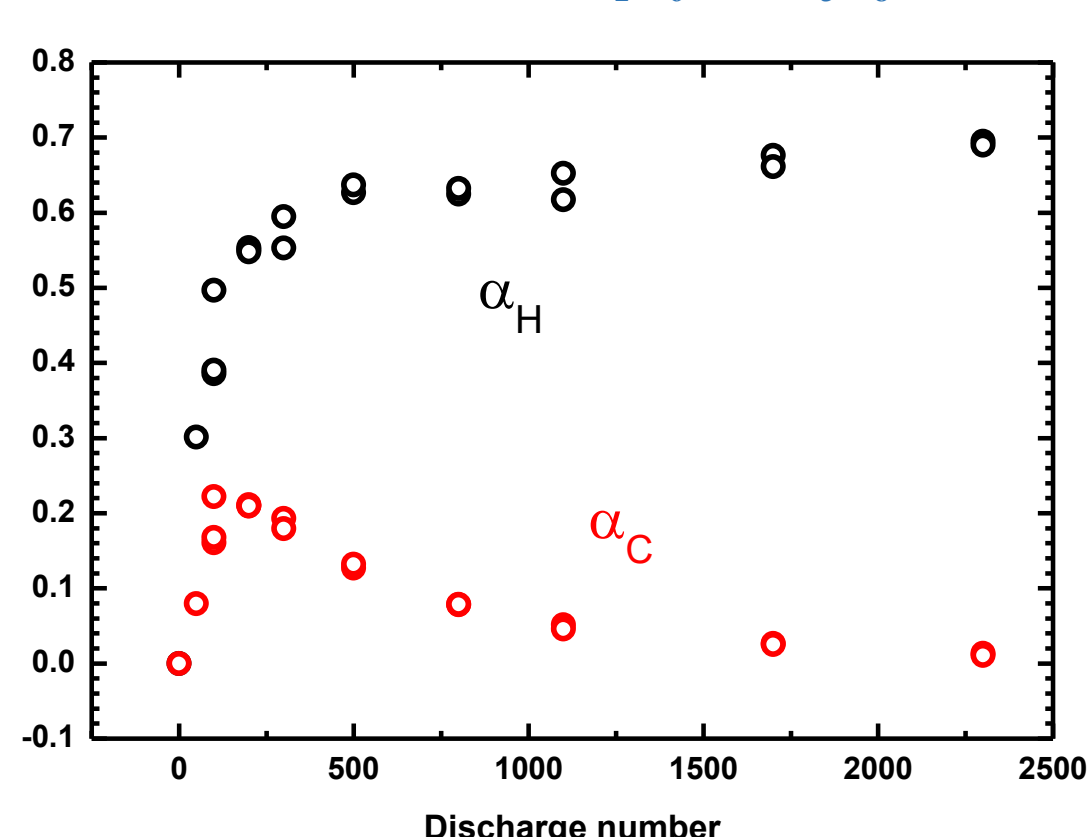

C and H balances

$$\alpha_H = \frac{2[H_2] + 2[C_2H_2] + 4[C_2H_4] + 6[C_2H_6] + 6[C_3H_6] + 8[C_3H_8]}{4([CH_4]_0 - [CH_4])}$$

$$\alpha_C = \frac{2[C_2H_2] + 2[C_2H_4] + 2[C_2H_6] + 3[C_3H_6] + 3[C_3H_8]}{[CH_4]_0 - [CH_4]}$$

Concentration of detected carbon in by-products is very small compared to the converted methane. A lack of H is also observed to a lesser extent, suggesting formations of undetected heavier hydrocarbons and/or solid compounds.

THE SELF-CONSISTENT 0D MODEL

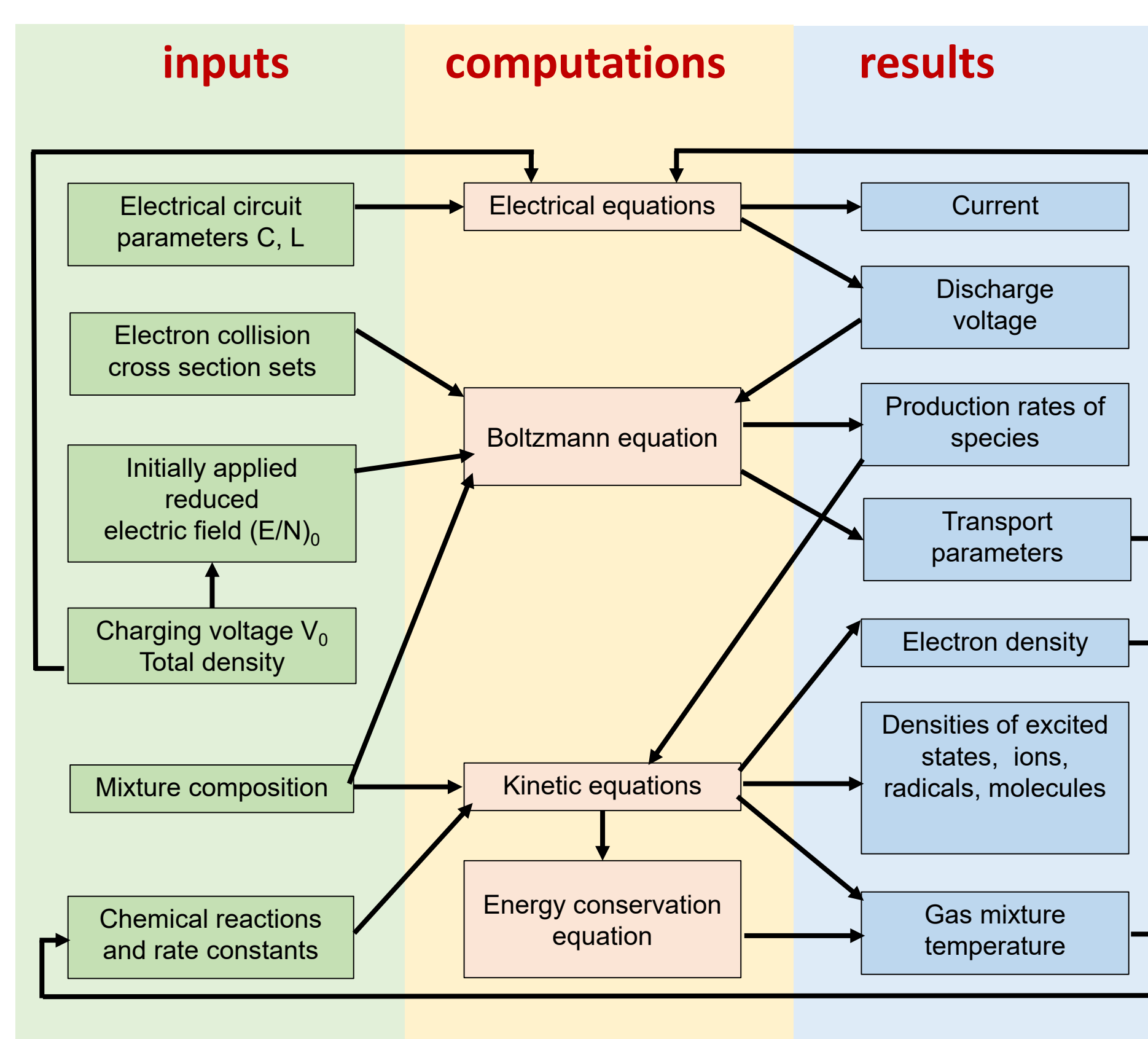

Pure argon, P = 1 bar
V₀ = 22 kV, (E/N)₀ = 90 Td

Comparison of calculated evolutions of voltage and current with the experimental signals

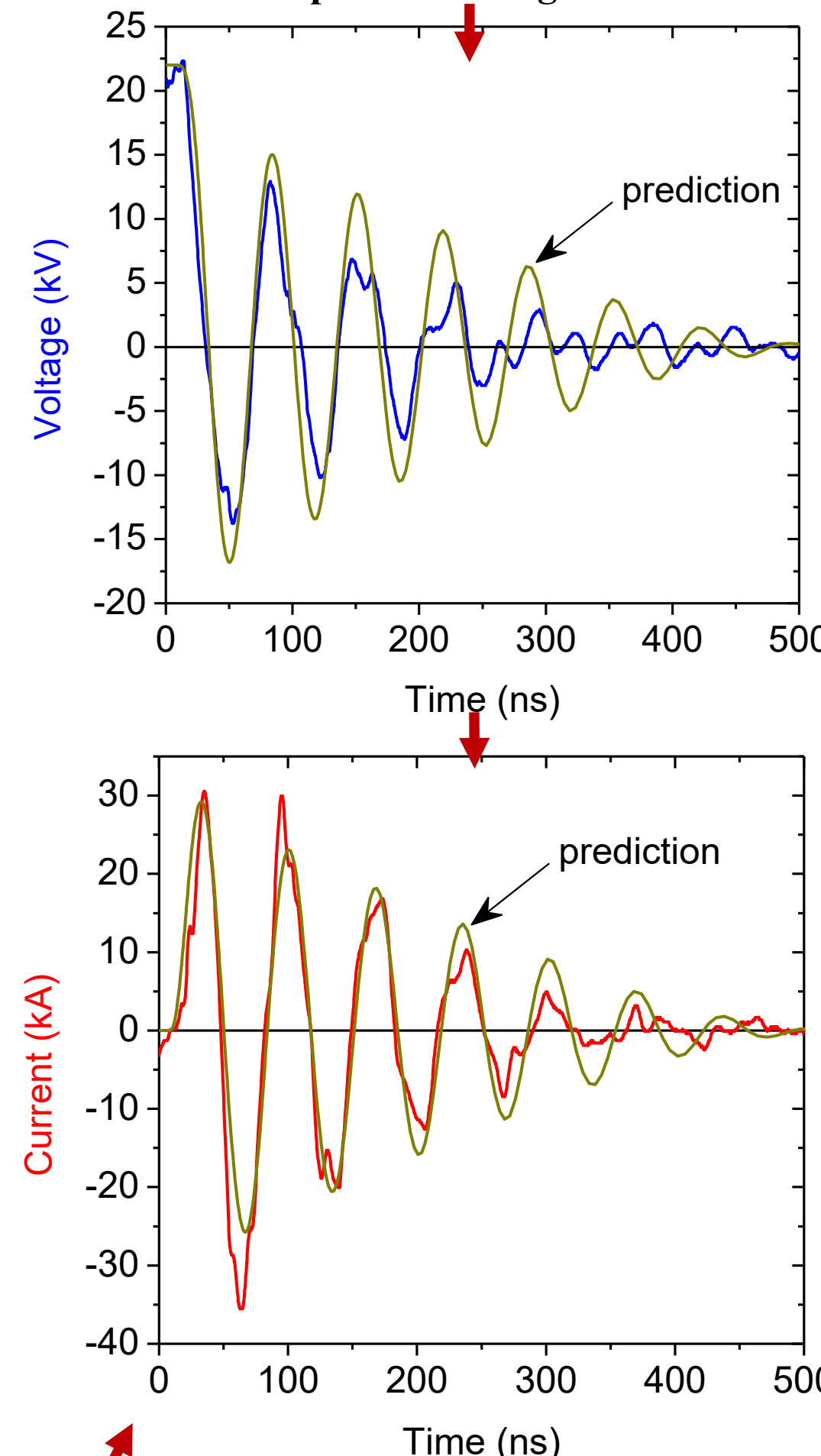

A good agreement is obtained between calculated and measured voltage and current. The agreement between calculated and measured CH₄ destruction in the gap during the first pulse is also satisfying, in spite of the simplicity of this first attempt in the modelling.

Argon states clustering

Real states	Energies (eV)	Effective state	Energy (eV)
1s ₅	11.548	4s	11.652
1s ₄	11.623		
1s ₃	11.723		
1s ₂	11.827	4p	13.17
2p ₁₀ ...	12.90...		
2p ₁	13.48	sup	14.5
all others	> 13.8		

Influence of the methane concentration on the calculated evolutions of the radiative states of Argon. P = 1 bar, V₀ = 22 kV, (E/N)₀ = 90 Td.

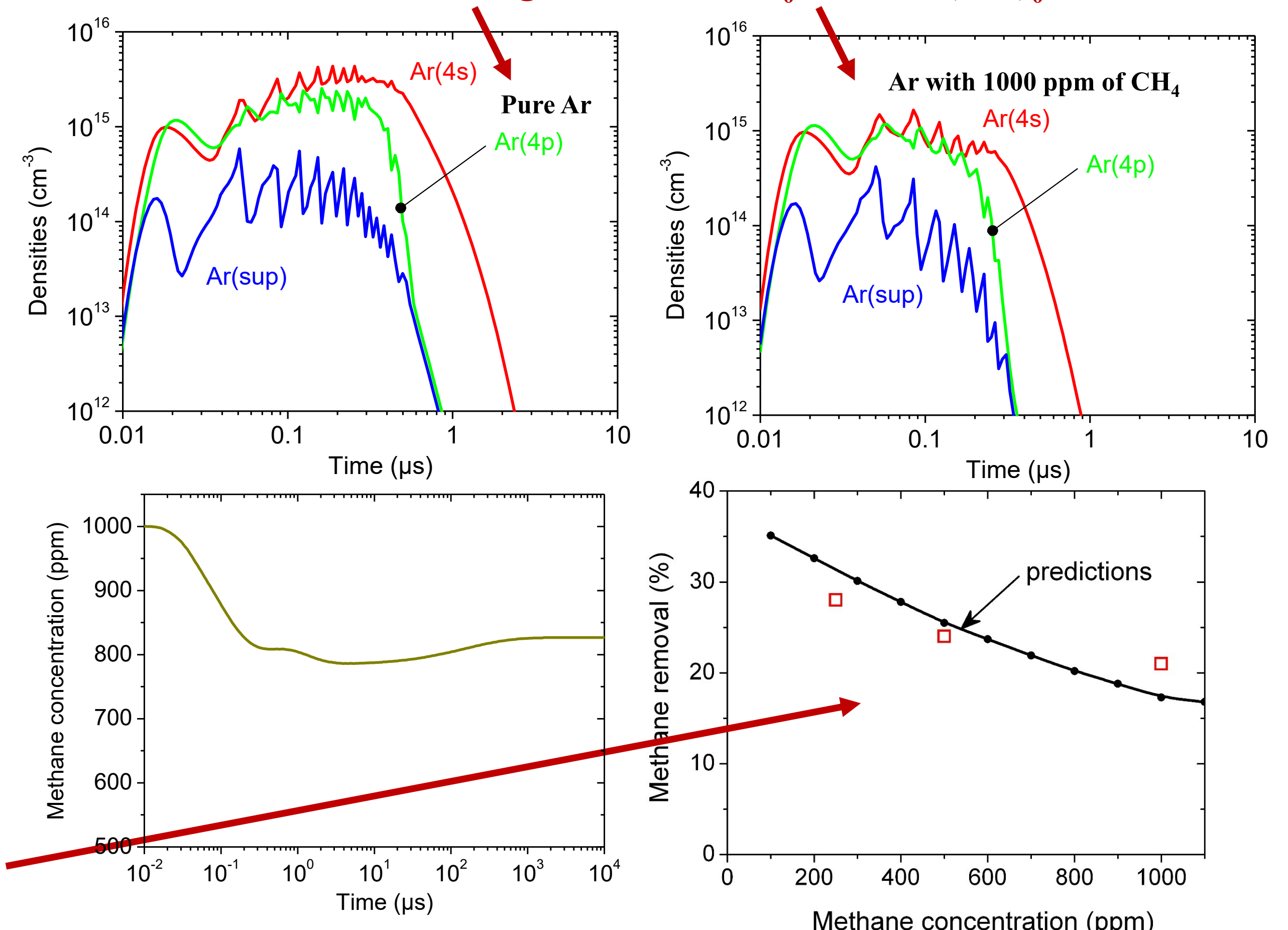

Simplified kinetics

Electronic collisions

(LXCat database: V. Puech and BSR for Ar, M.-C. Borge for CH₄)

- el + Ar : 4s, 4p, sup, Ar⁺
- el + 4s : 4p, Ar⁺
- el + 4p, sup : Ar⁺
- el + CH₄ : 2 vib. levels (0.16 eV and 0.36 eV)
 - dissociation CH₃ (10 eV)
 - ionisation CH₄⁺ (12.98 eV)
 - CH₃⁺ (14.3 eV)
 - CH₂⁺ (15.1 eV)
 - CH⁺ (22 eV)
 - H⁺ (21.89 eV)

With production of H and H₂
Super elastic collisions (4s, 4p, sup, vib. CH₄).

Heavy particles

Pennings, charge transfers, excitation transfers
excimer formation (Ar₂^{*}, Ar₂⁺), el-ion recombinations.

Chemical kinetics

(NIST Database)

H, CH, CH₂, CH₃ → C_xH_y (X=2...6, Y=2...14).

Radiative de-excitations

4p, sup, Ar₂^{*} (radiation trapping for 4s).

Methane removal processes

Ref: P. Tosi et al., Int. J. Mass Spectrom. Ion Proc. 149/150 (1995) 345-353

Quenching of the argon excited states

Ar^{*} + CH₄ → CH₃ + H + Ar

Ar^{*} + CH₄ → CH₂ + H₂ + Ar

Ar^{*} + CH₄ → CH₂ + H + H + Ar

Ar^{*} + CH₄ → CH + H₂ + H + Ar

Charge transfers

Ar⁺ + CH₄ → CH₃⁺ + H + Ar

Ar⁺ + CH₄ → CH₂⁺ + H₂ + Ar

Open question: role of Ar₂^{*} and Ar₂⁺ ?

REFERENCES

- [1] N Moreau, S Pasquiers, N Blin-Simiand, L Magne, F Jorand, C Postel and J-R Vacher, J. Phys. D: Appl. Phys. **43** (2010) 285201 (14pp)
- [2] W Faider, S Pasquiers, N Blin-Simiand and L Magne, J. Phys. D: Appl. Phys. **46** (2013) 105202 (16pp)

This work is supported by the Agence Nationale de la Recherche in the frame of the PlasBoNG project (ANR-20-GE09-0003).

