



HAL
open science

Photonic multiplexing architectures for optical neuromorphic networks

David Moss

► **To cite this version:**

David Moss. Photonic multiplexing architectures for optical neuromorphic networks. 2022. hal-03764240

HAL Id: hal-03764240

<https://hal.science/hal-03764240>

Preprint submitted on 30 Aug 2022

HAL is a multi-disciplinary open access archive for the deposit and dissemination of scientific research documents, whether they are published or not. The documents may come from teaching and research institutions in France or abroad, or from public or private research centers.

L'archive ouverte pluridisciplinaire **HAL**, est destinée au dépôt et à la diffusion de documents scientifiques de niveau recherche, publiés ou non, émanant des établissements d'enseignement et de recherche français ou étrangers, des laboratoires publics ou privés.

Photonic multiplexing architectures for optical neuromorphic networks

David J. Moss

Optical Sciences Centre, Swinburne University of Technology, Hawthorn, VIC 3122, Australia.

Abstract: The simultaneous advances in artificial neural networks and photonic integration technologies have spurred extensive research in optical computing and optical neural networks (ONNs). The potential to simultaneously exploit multiple physical dimensions of time, wavelength and space give ONNs the ability to achieve computing operations with high parallelism and large-data throughput. Different photonic multiplexing techniques based on these multiple degrees of freedom have enabled ONNs with large-scale interconnectivity and linear computing functions. Here, we review the recent advances of ONNs based on different approaches to photonic multiplexing, and present our outlook on key technologies needed to further advance these photonic multiplexing/hybrid-multiplexing techniques of ONNs.

Keywords: optical neural network, photonic multiplexing, optical computing operation, integrated optics.

1 Introduction

Artificial neural networks (ANNs) are mathematical models that emulate the biological brain, with their computing speed and capabilities determined by the underlying computing hardware. Mainstream electronics based on the von Neumann architecture has been widely employed, leading to significant breakthroughs in machine learning with unprecedented performance in computer vision, adaptive control, decision optimization, object identification and more [1-6].

However, with the ever-growing demand for processing capacity, it is clear that electronic computing alone will not be able to meet future practical requirements [7-10]. Its main limitation arises from the separation of the processing unit and memory, which requires significant energy and computing power during the reading and writing of data, which leads to limited efficiency when processing ultra-large matrices. Although advanced hardware architectures, such as graphics and tensor processing units, have enabled dramatic improvements in performance, several inherent bottlenecks of electrical digital processors still exist. For example, limited by the electronic bandwidth bottleneck, the clock frequency of traditional electrical digital processors is limited to under a few GHz [11]. Further, electronic processors with higher computational power generally need a larger circuit scale and higher integration density, which will inevitably lead to high energy consumption and heat dissipation [12]. These limitations will lead to the failure of Moore's law, thus making the realization of significantly more advanced neural networks challenging or even impossible. The development of new techniques that have the potential to overcome these limitations and achieve unprecedented computing performance are needed [13-14].

The unique advantages of light, such as its ultrawide bandwidths of up to 10's of THz, the low propagation loss and the inherent nature of its analog architecture, make optical neuromorphic computing hardware promising to address the challenges faced by their electronic counterparts [14-25]. Ultimately hybrid opto-electronic computing hardware that leverage the broad bandwidths of optics without sacrificing the flexibility of digital electronics may provide the ideal solution. Light contains multiple degrees of freedom including wavelength, amplitude, phase, mode, and polarization states, thus supporting the simultaneous processing of data in multiple dimensions via multiplexing techniques [26-35], mirroring approaches that have been widely used in optical communications. Photonic techniques have significant potential in implementing large-scale fan-in/out and weighted interconnects between neurons for optical neural networks (ONNs), thus simplifying the hardware architecture and addressing the demands for increased computing power [36-43].

Optical neural networks use light as the information carrier and can simultaneously achieve the desired computing functions while propagating through specially designed dielectric structures or free space, and so the processing and storage functions are no longer separated. This passive process effectively improves the energy efficiency [44-46] and reduces the latency of ONNs — especially for approaches based on integrated platforms [47-49]. More importantly, optical neural networks have critical advantages for certain demanding applications such as autonomous vehicles, robotics, computer vision and other emerging fields, that require extremely rapid processing of optical and image signals. For ONNs, converting the optical and image signals into digital signals before being processed can be omitted [18], thus saving considerable time and energy.

Recently, the advances in ONNs have been reviewed from a number of different perspectives [14-25], including introducing: optical field interferences for visual computing applications [18], integrated neuromorphic systems and the underlying hardware for implementing weighted interconnects and neurons [19], the training methods [21], energy consumption [22] and prospects and applications of ONNs [23]. Here, we review the most recent advances of ONNs from the perspective of the fundamental photonic multiplexing techniques that offer physical parallelism for the implementation of ONNs. These photonic multiplexing techniques include space-division multiplexing (SDM), wavelength-division multiplexing (WDM), time-division multiplexing (TDM), mode-division multiplexing (MDM), and polarization-division multiplexing (PDM). Further, we discuss the key technologies needed for the further enhancement of the computing parallelism of ONNs', which typically aim to achieve more efficient use of photonic multiplexing techniques. The paper is structured as follows. In section 2, we survey in detail how different photonic multiplexing techniques are leveraged for the parallel

signal input of vector matrix \mathbf{X} and the optical weighted interconnection of the weight matrix \mathbf{W} in ONNs. The typical structures of optical computing operations based on different multiplexing methods are outlined, which include matrix multiplication, Fourier transform, convolution. In section 3, spiking neurons and spiking neural networks based on optical multiplexing techniques are reviewed. In section 4, we discuss how to further exploit photonic multiplexing/hybrid-multiplexing techniques in ONNs. The key technologies that further enhance the computing power through the use of photonic multiplexing/hybrid-multiplexing techniques are highlighted, including integrated optical frequency comb, integrated high-speed electronic-optical interfaces and hybrid integrated technologies.

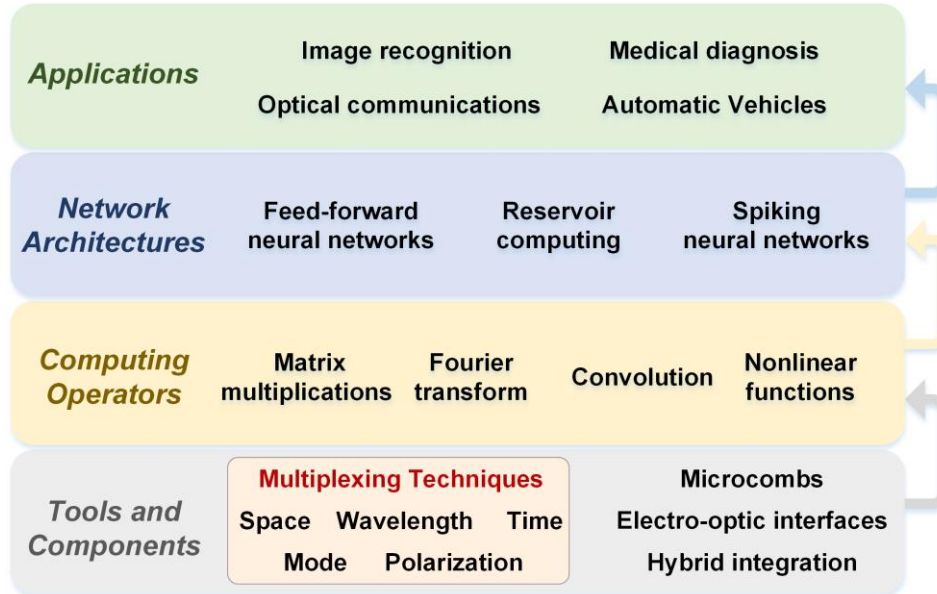
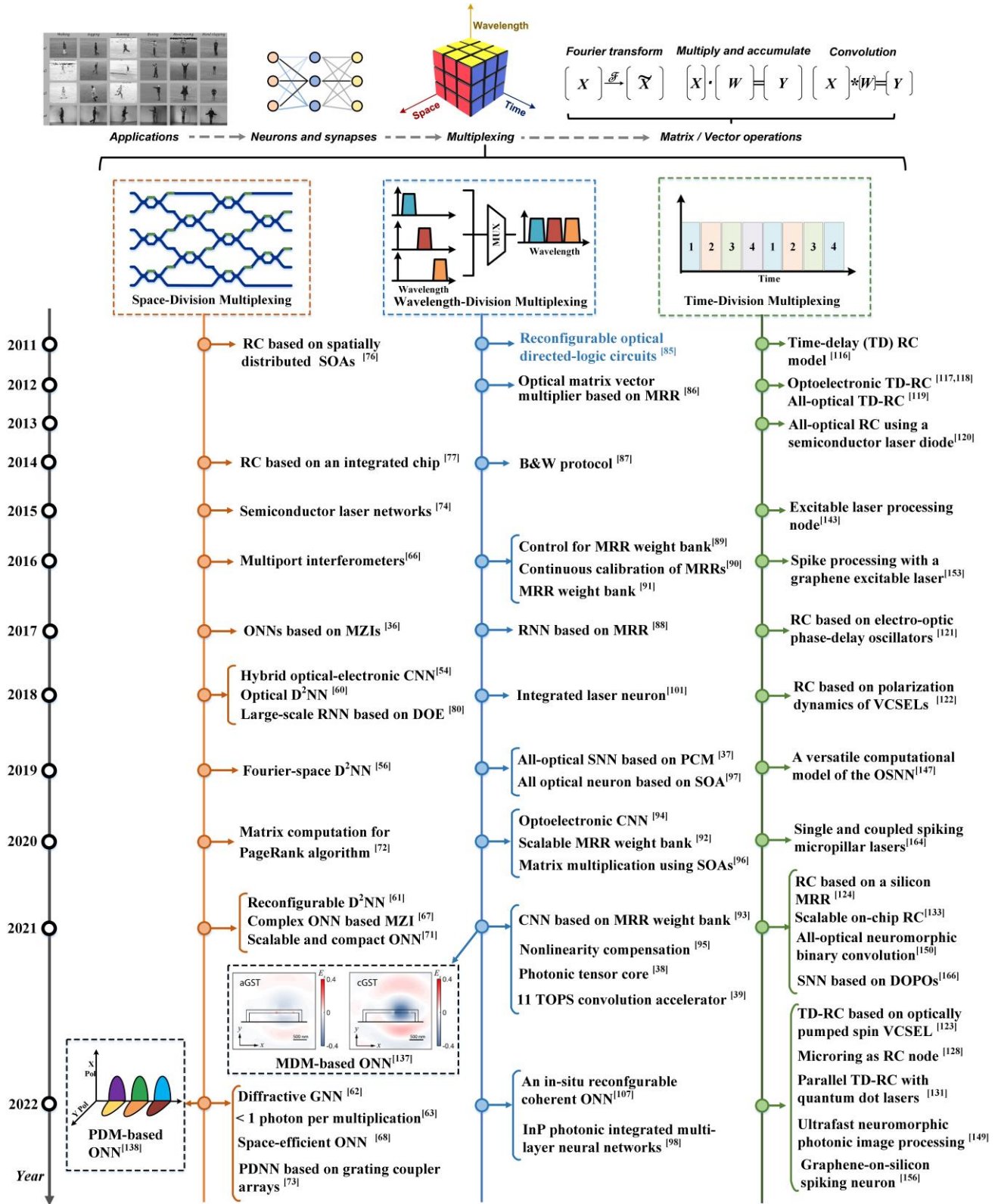

Fig. 1 The different facets of optical neural networks.

2 Multiplexing techniques for optical neural networks

Neural networks typically consist of multiple layers, each formed by multiple neurons densely interconnected by weighted synapses. Each neuron has multiple input nodes, and the signals from different input nodes \mathbf{X} are weighted via synapses \mathbf{W} and summed as $\mathbf{Y}=\mathbf{X}\cdot\mathbf{W}$. This multiply-and-accumulate operation (MAC) accounts for the majority of computations in neural networks [50-51]. The neural network's capacity to address complicated tasks is dictated by the scale of network (i.e., the number of neurons, synapses and layers), and thus the key to achieve maximum acceleration (using analog hardware) lies in achieving sufficiently high parallelisms and throughput to map \mathbf{X} (input nodes/data) and \mathbf{W} (weighted synapses) onto the practical parameters of the physical system. Analog photonics offer multiple physical degrees of freedom for multiplexing, and are thus capable of implementing large-scale fan-in/-out and synapses, with high throughput enabled by the broad optical bandwidths. Typical ONN architectures based on multiplexing techniques are introduced in this section.



2.1 ONNs based on space-division multiplexing

Spatial-division multiplexing is a fundamental approach to boost the computing parallelism and enhance the overall computing speed, as has been widely used in traditional digital computing systems [14-25]. ONNs based on SDM feature architectures where the input nodes \mathbf{X} and/or weighted synapses \mathbf{W} are mapped onto the spatial division. The weighting process is achieved via manipulating the optical fields carrying data \mathbf{X} , and the sum operation is achieved via constructive/destructive interference.

Fourier optics [52-56], using a free space lens to perform Fourier transform, is a classic example of computing based on SDM and was first proposed by K. Bieren in 1971 [52]. Thereafter, W. Goodman established the model of parallel and

high-speed optical discrete Fourier transforms (Fig. 3(A)) in 1978 [53], which have been widely used to perform matrix multiplication operations [57-59]. Subsequently, the convolution operation - a more sophisticated computing operator which takes on the heaviest computational burden of convolution neural networks - was realized optically based on the 4F system (Fig. 3(B)) by G. Wetzstein et al [54]. In that system, the encoded input signals \mathbf{X} go through a Fourier lens to perform a Fourier transform, and are then convolved with the convolution kernel \mathbf{W} encoded onto an optimized phase mask. Later, ONNs were demonstrated with Fourier optics [55-56], such as using Fourier lenses for the optical linear operations [55] and laser-cooled atoms with electromagnetically induced transparency for nonlinear functions (Fig. 3(C)).

Since classical free space optics setups are relatively bulky, novel approaches such as gradient index technology, meta-surface, diffraction structures and so on, have been exploited using SDM to achieve optical computing operators and ONNs in more compact form. In 2018, X. Lin et al. proposed an optical diffractive deep neural network (D²NN) (Fig. 3(D)) [60], in which the information was encoded onto both the amplitude and phase of optical waves. As each pixel of the diffractive lens serves as a neuron in free space, a fully connected network involving large input nodes and neurons was realized. Following this, Q. Dai et al proposed a Fourier-space D²NN (Fig. 3(E)) based on diffractive modulation layers [56]. The combination of diffractive optics and Fourier optics can achieve all-optical segmentation of the salient objects for the target scene after deep learning design of modulation layers, and obtained higher classification accuracy and a much more compact structure compared to real-space D²NN. Following this, Q. Dai et al [61] further optimized the diffractive neural network and proposed a reconfigurable optoelectronic neural network (Fig. 3(F)). The key fundamental building block was here was the reconfigurable diffractive processing unit consisting of large-scale diffractive neurons and weighted optical interconnections. The input nodes were achieved with SDM-based spatial light modulators, with the weights tuned by changing the diffractive modulation of the wavefront. Benefiting from the high parallelism of SDM-based lenses, the proposed large-scale diffractive neural network can support millions of neurons. Soon after, T. Yan applied the integrated diffractive photonic computing units to the diffractive graph neural network (Fig. 3(G)) that can perform optical message passing over graph-structured data [62], which can fulfill the recognition of skeleton-based human action. This work has inspired researchers to combine deep learning with the application-specific integrated photonic circuits design. In another example, diffractive optics were leveraged to achieve optical dot products (Fig. 3(H)) with extremely low optical energy consumption, thus experimentally proving the advantages of photonic techniques in low-power-consumption computing [63]. Further to this, a programmable D²NN based on a digital-coding metasurface array [64] was proposed (Fig. 3(I)). This D²NN consisted of multiple programmable physical layers, capable of dealing with image recognition, feature detection and multi-channel encoding and decoding in wireless communications by processing electromagnetic waves in free space.

The interference of light represents another form of SDM based on the superposition of waves, and this can also be used to achieve optical computing [65-72]. The fundamental principle is to divide coherent input light into different paths in free planar space, after which optical matrix multiplication can be achieved by appropriately designing the propagation paths of the multiply-coherent light. Typical structures to achieve interference-based computing mainly consist of Mach-Zehnder interferometers (MZIs), which are formed by beam splitters/couplers and phase shifters. In 1994, M. Reck et al. introduced a theoretical model for MZI-based meshes [65]. Later, W. Clements et al. proposed a novel universal matrix transformer in 2016 [66], with the footprint and loss further optimized. In 2017, Y. Shen et al. proposed an all-optical neural network architecture (Fig. 3(J)) based on a silicon photonic integrated circuit, in which 56 programmable MZIs were used for optical matrix multiplications [36]. In 2021, H. Zhang et al. proposed a complex neural network (Fig. 3(K)) [67] based on coherent detection, in which information was encoded on both the magnitude and phase of light. In contrast to real-valued ONNs, this work can offer an additional degree of parallelism and achieve better performance in terms of computational speed and energy efficiency. An integrated-chip diffractive neural network (Fig. 3(L)) was proposed in [68], where diffractive cells were introduced to implement discrete Fourier transforms. This chip is capable of performing Fourier transform and convolution operations, bringing prominent advantages in space-efficient and low-power-consuming implementations of large-scale photonics computational circuits for neural networks.

The reported ONNs based SDM also include those that adopt an array of grating couplers [73], spatially distributed phase-change material (PCM) meshes [38], vertical-cavity surface-emitting lasers (VCSELs) arrays [74] and so on. In [73], an integrated photonic deep neural network (Fig. 3(M)) with optoelectronic nonlinear activation functions was demonstrated, capable of directly processing optical waves impinging on an array of grating couplers and fulfilling image classification. A 5×6 array of input grating couplers distributed in free space served as input nodes to capture the image of the target object, and the weight vectors were controlled by tuning the input voltages of the PIN attenuator array. After achieving the weighted sum of the neuron inputs, the optoelectronic nonlinear response of a PN junction micro-ring modulator was used as a rectified linear unit (ReLU) which yielded the neuron's output. This work is a significant step for the implementation of fully integrated end-to-end ONNs, and experimentally proves the advantages of ONNs for directly processing optical and image signals. In [38], the spatially distributed PCM meshes served as weighted interconnections to implement the weight addition.

Finally, SDM has also been exploited for reservoir computing (RC) [74-84] with the nodes implemented with tailored optical connection topologies [75-79]. In 2011, K. Vandoorne et al. demonstrated an integrated optical RC based on spatially distributed semiconductor optical amplifiers (SOAs) [76], whose steady state characteristics implement hyperbolic tangent nonlinear functions. Later, the authors further demonstrated that RC can be achieved on an integrated silicon photonic chip (Fig. 3(N)) [77], which consists of passive elements such as optical waveguides, optical splitters and combiners. In 2015, D. Brunner and I. Fischer presented a spatially extended optical RC based on diffractive optical coupling. The diffractive-optical element (DOE), incorporated with an imaging lens, created coupling with the emitters of a laser array

[74]. Limited only by the imaging aberration, potentially much larger network scales are possible with this diffractive coupling scheme. Later, the authors further proposed a large-scale RNN (Fig. 3(O)) consisting of 2025 nonlinear network nodes via the DOE [80], which can individually or simultaneously realize spatial- and wavelength-division multiplexing of the output.

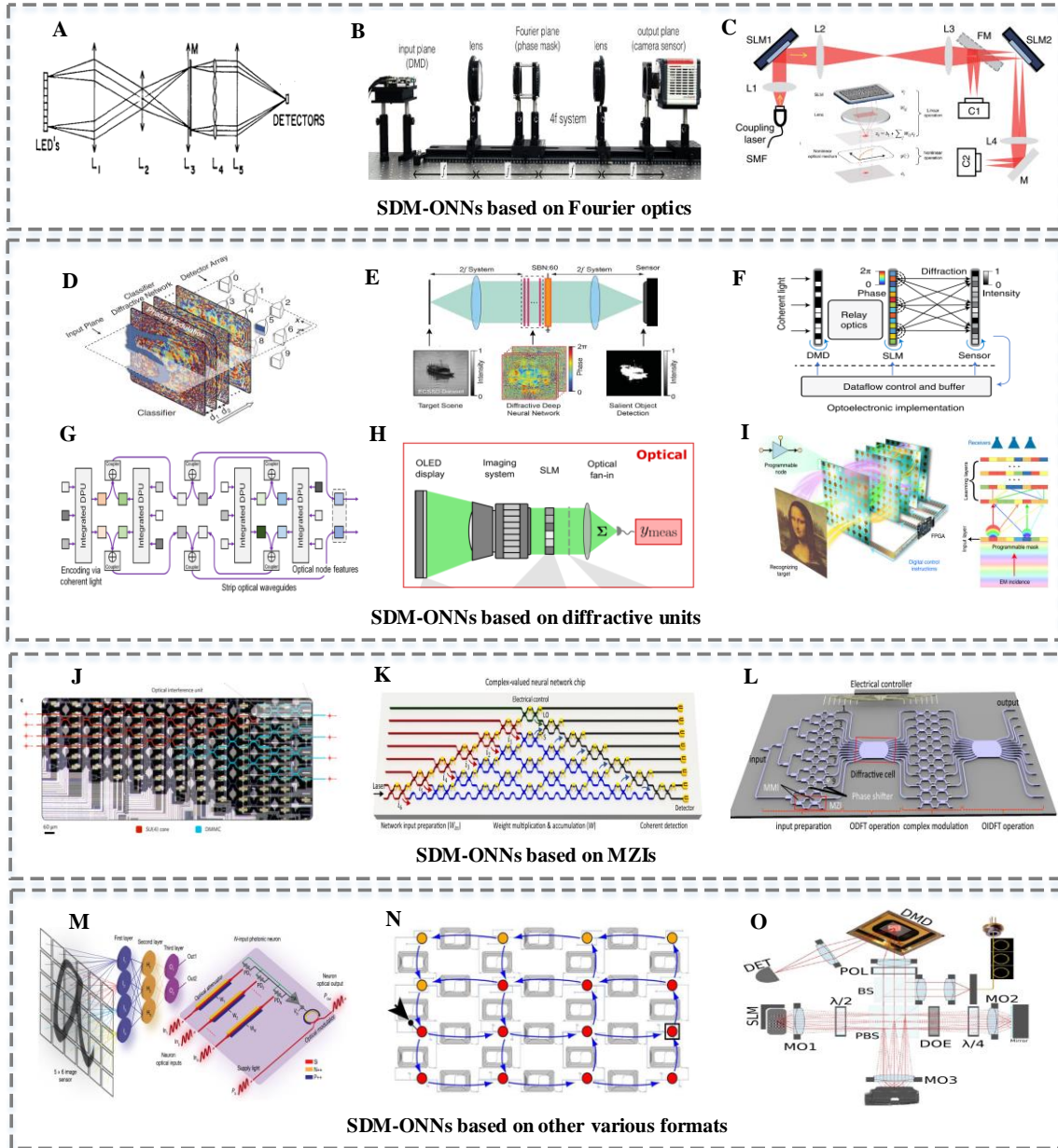

Fig. 3 Advances in SDM-based ONNs. (A) The first optical MVM system model [53]. (B) Performing optical convolution based on the 4F system [54]. (C) A fully functioning all-optical neural network based on Fourier optics [55]. (D) An optical diffractive deep neural network [60]. (E) A Fourier-space D^2NN [56]. (F) A reconfigurable diffractive neural network [61]. (G) A diffractive graph neural network [62]. (H) Performing optical dot products with extremely low optical energies [63]. (I) A programmable D^2NN based on a digital-coding metasurface array [64]. (J) An all-optical neural network architecture based on MZI meshes [36]. (K) A complex neural network based on MZI meshes and the coherent detection [67]. (L) An integrated diffractive neural network [68]. (M) An integrated photonic deep neural network based on spatially distributed array of input grating couplers [73]. (N) A spatially distributed 16-node on-chip RC [77]. (O) A large scale RNN consisting of 2025 nonlinear network nodes [80].

2.2 ONNs based on wavelength-division multiplexing

WDM is the prime embodiment of light's remarkable advantages over electronics. The wide optical bands support massive wavelength channels for implementation of parallel input nodes and weighted synapses, and potentially much higher clock rates up to 10's of GHz. Specifically, the optical computing operations based on WDM can be realized by combining multi-wavelength sources with weight bands or wavelength-sensitive elements [85-107], such as micro-ring resonators (MRRs) [85-95], SOAs [96-98], and PCMs [37-38, 99].

In 2011, Q. Xu et al. proposed a WDM circuit to perform incoherent summation by collecting light outputs of different wavelengths into a waveguide via a tunable MRR [85]. Soon after, L. Yang et al. designed an optical matrix vector multiplier (Fig. 4(A)) that was composed of an array of cascaded lasers and modulators, wavelength multiplexers/demultiplexers, an MRR matrix and photodetectors, capable of performing 8×10^7 MACs per second [86]. The input data vector was mapped onto the optical power of different wavelengths, and the element a_{ij} of the weight vector was converted to the transmittance of the MRR at row i , column j . Such structures were further investigated in [107] (Fig. 4(B)), in which the weight vector was added by the modulator, capable of supporting four different operations on the same photonic hardware: multi-layer, convolutional, fully-connected and power-saving layers.

In parallel, A. Tait et al. proposed the broadcast-and-weight protocol in 2014 [87] and further demonstrated it with an MRR weight bank in 2017 (Fig. 4(C)) [88]. This protocol broadcast input data onto all wavelength channels via electro-optic modulation, simultaneously weighting the replicas by controlling the power of the wavelength channels. Recently, C. Huang et al. implemented the WDM-based ONN with a broadcast-and-weight architecture (Fig. 4(D)) on a silicon photonic platform [95], in which the input data of difference neurons were loaded on the multiple optical wavelengths and then multiplexed on the same optical waveguide; the interconnections between the neurons were realized by using a power splitter; the weights were applied by controlling the partial transmission of the signal via an array of MRR banks. The WDM-assisted ONN can be used to compensate for fiber's nonlinearity, leading to an improved Q factor in optical communication systems.

In 2020, Indium Phosphide (InP) platforms were employed to realize a photonic feed-forward neural network (Fig. 4(E)) [96], where SOAs were employed to simultaneously compensate for losses and achieve synaptic weights. As another alternative to achieve weighted interconnects, PCM cells can make the synaptic waveguides highly transmissive or mostly absorbing by switching phase states. In 2019, J. Feldmann et al first demonstrated a spiking ONN based on PCM cells. In 2021, the authors further proposed an integrated photonic tensor core (Fig. 4(F)) to accelerate convolution operations. The employed on-chip PCM matrix [38] can implement highly parallel matrix multiplication operations, potentially at trillions of MAC operations per second.

With the recent advances in chip-scale frequency combs, wideband and low-noise integrated optical sources are readily available, greatly expanding the potential of WDM-based ONNs. Recently, an optical convolution accelerator (Fig. 4(G)) achieving a vector computing speed at 11.3 TOPS was demonstrated based on a time-wavelength interleaving technique [39], capable of extracting the features of large-scale data with scalable convolutional kernels. The schematic of the convolution accelerator is shown in Fig. 4(G). Input data was mapped onto the amplitudes of temporal waveforms via digital-to-analog converters (i.e., TDM); and the convolutional kernels' weight matrices were mapped onto the power of microcomb lines via an optical spectral shaper (i.e., WDM). After electro-optic modulation, the input data were broadcast onto multiple wavelength channels featuring progressive time delays due to second-order dispersion of the subsequent fiber spool. By setting the progressive time delay step the same as the symbol duration of the input waveform, convolution operations between the input data and convolutional kernels can be obtained after photodetection. The convolution accelerator can be further leveraged for convolutional neural networks, which feature greatly simplified parametric complexity in contrast to fully connected ONNs.

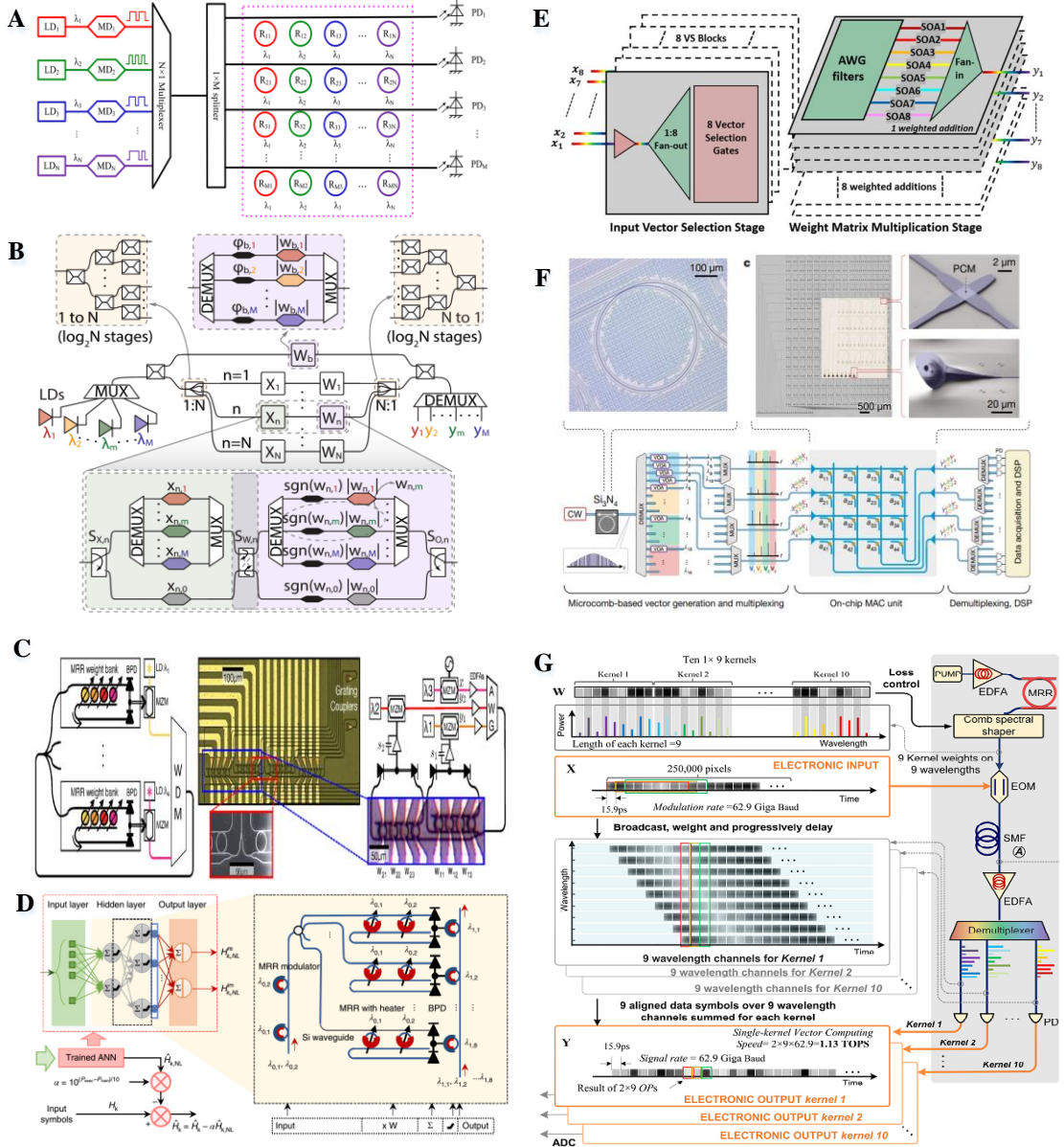

Fig. 4 Advances in WDM-based ONNs. (A) An optical matrix vector multiplier based on WDM and MRMs [86]. (B) A programmable ONN based on WDM and coherent light [107]. (C) A continuous time RNN based on WDM and MRR weight bank [88]. (D) A WDM-based ONN for compensating the fiber nonlinearity [95]. (E) A photonic feed-forward neural network based on WDM and SOAs [96]. (F) An ONN based on WDM and PCM [38]. (G) An optical convolution accelerator based on a time-wavelength interleaving multiplexing technique [39].

2.3 ONNs based on time-division multiplexing

A key advantage of ONNs is the ultra-wide bandwidths offered by optics. This yields massive numbers of wavelength channels to greatly enhance the parallelism, as introduced above for WDM-based ONNs. It also enables high data throughputs of up to 10's of Giga Baud, (corresponding to the clock rate of electronic hardware) — which requires high-speed electro-optic interfaces (i.e., modulators and photodetectors), and tailored network protocol/architecture of the input nodes employing TDM techniques [108-110]. Here, we review the fundamental building blocks, architectures, and recent advances of TDM-based ONNs.

In [39], a high throughput exceeding 11 TOPS was demonstrated by interleaving the time- and wavelength-divisions. Here, in this work, TDM has been employed to sequentially map the input nodes/data into the time domain. Assisted by high-speed electro-optic modulators and photodetectors (>25GHz analog bandwidth), the data rate reached ~62.9 Giga Baud (Fig. 5(A)).

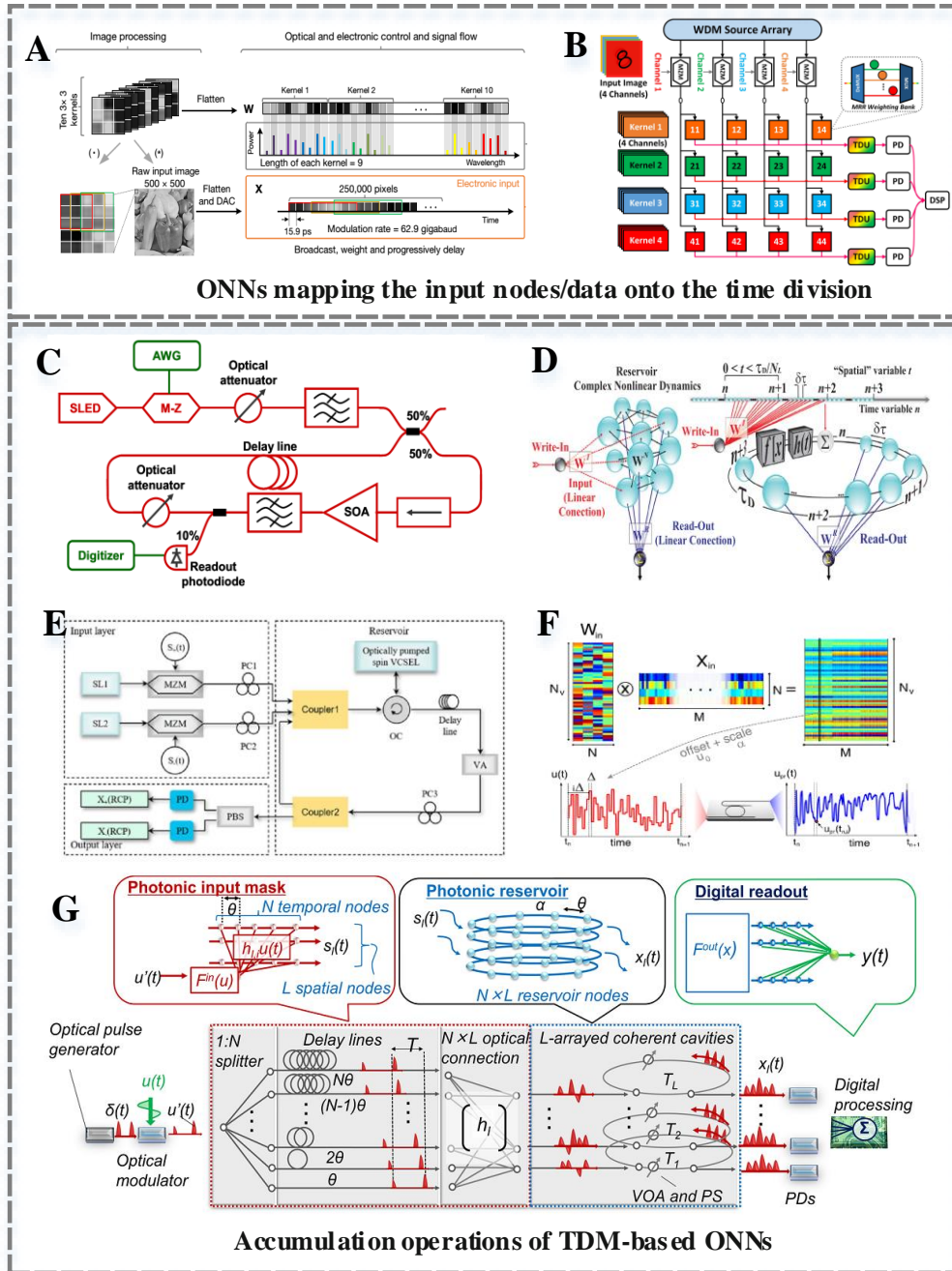

Fig. 5 Advances in TDM-based ONNs. (A, B) ONNs exploiting TDM to implement large-scale fan-in/out [39], [110]. (C) Time-delay reservoir computing (TD-RC) based on SOA [119]. (D) TD-RC based on electro-optic phase-delay oscillator [121]. (E) TD-RC based on an optically pumped spin VCSEL [123]. (F) TD-RC based on a silicon microring [124]. (G) Scalable RC on coherent linear photonic processor [133].

The accumulation operations of TDM-based ONNs are achieved generally based on interference between signals and replicas having different delays. This can be implemented using either integrated or fiber delay lines or via dispersive media. The former is widely used in RC architectures [111-112].

The concept of RC, defined by D. Verstraeten et al. [115], was derived from the echo state network (ESN) proposed by J. Herbert in 2001 [113] and the liquid state machines (LSM) reported by W. Maass in 2002 [114]. RC is a simple and efficient machine learning algorithm suitable for processing sequential signals. It consists of an input layer, a reservoir and an output layer. The input signal is first preprocessed, and then nonlinearly mapped into a high-dimension state space by the reservoir. Afterwards, the output layer generates processed results according to the node states of the reservoir and the connection weights of the output layer. Specifically, the connection weights of the input layer and the reservoir are randomly generated and remain unchanged during the training process, while only the connection weights of the output layer are trained. In 2011, L. Appeltant et al. proposed a RC network that exploited a single nonlinear node with a time-delay feedback loop that yielded a large number of virtual nodes, which simplify the hardware implementation of the reservoir [116]. In 2012, L. Larger et al. [117] and Y. Paquot et al. [118] first experimentally demonstrated RC using an electro-optical feedback loop with electrical gain nested, and F. Duport et al. implemented an all-optical RC (Fig. 5(C)) based on a time delay feedback loop with the nonlinear function achieved with a SOA [119]. In 2013, D. Brunner et al. realized an

all-optical RC using a semiconductor laser diode as the nonlinear node in the time delay feedback loop [120]. In 2017, L. Larger et al. employed electro-optic phase-delay oscillator and other traditional photonic devices to construct a photonic RC (Fig. 5(D)) that was capable of classifying a million words per second [121].

Recently, advances of optical RC hardware based on time delay feedback loops including those using the dual-polarization dynamics of a VCSEL [122], an optically pumped spin VCSEL (Fig. 5(E)) [123], a silicon MRR (Fig. 5(F)) [124], and others [125-132]. In 2021, M. Nakajima et al. reported an on-chip RC architecture (Fig. 5(G)) based on hybrid photonic architectures/devices [133]. The input data was spatially divided into multiple branches/temporal nodes, which were then progressively delayed via an array of delay lines and weighted by optical cross connecting units, thus achieving the input mask of RC for subsequent time-series forecasting and image classification.

2.4 ONNs based on mode- and polarization- division multiplexing

In addition to the approaches to ONNs introduced above, polarization- and mode-division multiplexing can also be employed to enhance the transmission capacity of optical communications [134-136] and computing parallelism of ONNs. We note that MDM and PDM are generally compatible with other multiplexing techniques, and thus can potentially lead to dramatic increases in the ONNs' computing power. Here, we review recent advances in ONNs using those two multiplexing techniques.

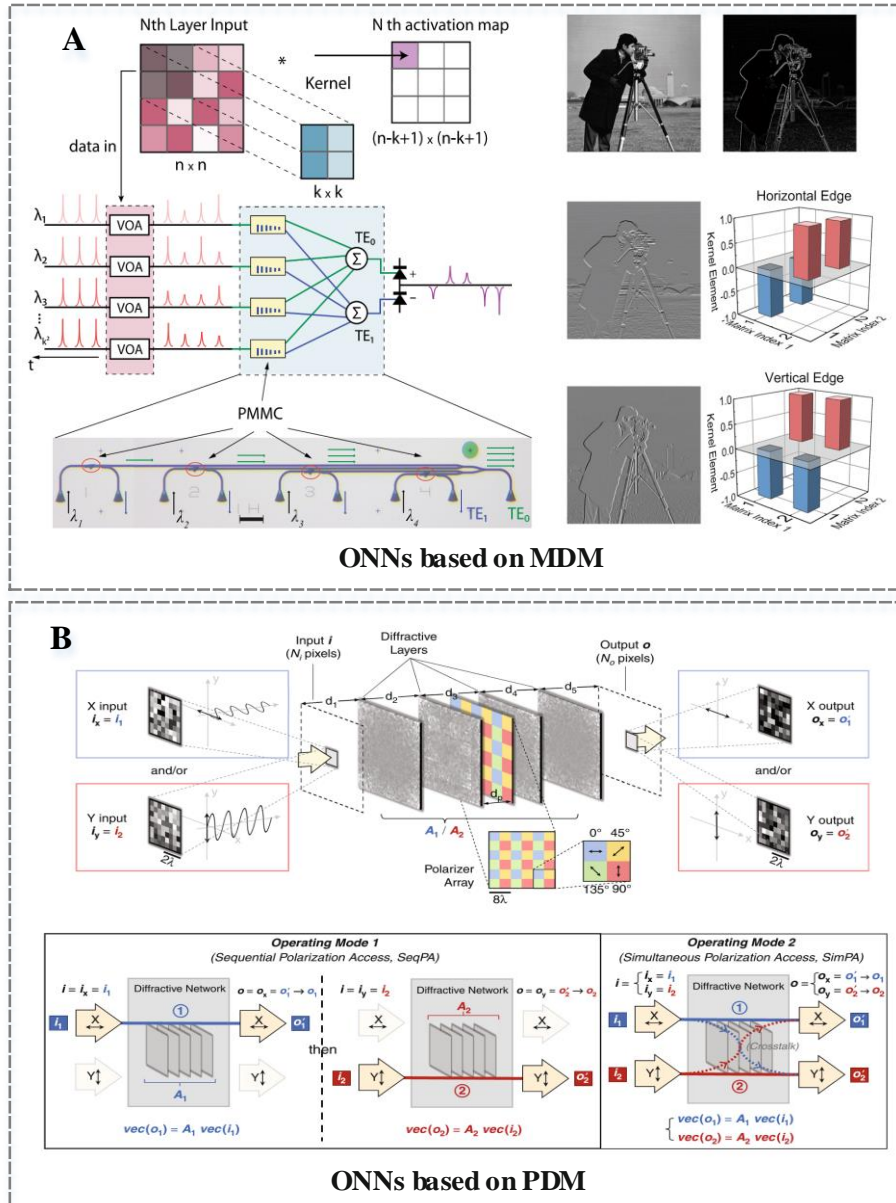

Fig. 6 Advances in PDM- and MDM-based ONNs. (A) An ONN based on MDM and WDM [137]. (B) An ONN based on PDM and SDM [138].

In order to implement on-chip ONNs based on MDM, mode multiplexers/demultiplexers with low modal crosstalk and losses are critical. As an ideal material with optical programmability, the PCM can be employed to build programmable waveguide mode converters (other than programming the synaptic weights). Specifically, the TE₀ and TE₁ modes of photonic waveguides can be converted to the other via large refractive index changes of PCM Ge₂Sb₂Te₅ (GST) during

phase transition. C. Wu et al. proposed a multimode photonic convolutional neural network (Fig. 6(A)) based on an array of programmable mode converters made from PCM in 2021 [137], as shown in Fig. 6 (A). In detail, the patches of pixels of the image were encoded onto the power of multiple wavelength channels with variable optical attenuators (i.e., WDM). The weighted data was programmed as the mode contrast coefficient of each PCM mode converter, by controlling the tunable material phases of the GST, and the transmitted results of difference modes were obtained with photodetectors.

PDM can straightforwardly double the capacity/parallelism for information transmission/processing and has been widely used in optical communications, imaging, and sensing. Recently, J. Li et al. proposed a diffractive ONN based on PDM (Fig. 6(B)), which is potentially capable of fulfilling multiple, arbitrarily-selected linear transformations [138]. In this work, the computing parallelism was improved with PDM between the input and output field-of-view of the diffractive network, where the polarization states of the light will not affect the phase and amplitude transmission coefficients of each trainable diffractive feature. 2- and 4-channel optical diffractive computing based on PDM were designed for arbitrarily-selected linear transformations.

3 Multiplexing techniques for spiking neurons

Representing the third generation of ANNs [139], spiking neural networks (SNN) operate on time-discrete spiking signals instead of continuous signals. Inspired by the biological human brain neurons, artificial spiking neurons encompass binary states (active and inactive), and are only active and output spikes at firing events. The spiking characteristics of SNNs bring about enhanced noise robustness and capabilities of processing temporally varying information, enabling the great superiority of SNNs in dealing with event-based applications. Here, we survey existing structures of optical spiking neurons, one of the most fundamental components of optical SNNs, and discuss the roles of photonic multiplexing techniques in achieving them.

TDM techniques were employed in most optical spiking neural networks, where the spikes/pulses are sequentially distributed in the time division. The model of spiking neurons was first proposed by W. Maass in [139]. Afterwards, the spiking neuron was experimentally demonstrated based on a nonlinear fiber and an SOA (Fig. 7(A)) by D. Rosenbluth et al. in 2009 [140]. The SOA and the Ge-doped nonlinear fiber can achieve leaky temporal integration of a signal with thresholding functions. Later in 2011, W. Coomans et al. designed an optical spiking neuron based on a semiconductor ring laser and demonstrated the mechanism of utilizing a single triggering spike to excite consecutive spikes [141].

Since then, various lasers have been exploited as excitable devices for spiking neurons, such as distributed feedback lasers [142-145], VCSELs [146-151], and excitable fiber lasers [152-155]. For instance, M. Nahmias et al. proposed a spiking neuron based on photodetectors and DFB lasers (with saturable absorbers inside), in which the input spiking signals were weighted by a tunable filter and summed by the photodetector, then drove the excitable laser to output spikes [142]. Later, they also embodied the saturable absorbers into VCSELs to form spiking neurons, utilizing the gain variation of VCSELs with input pulses at different wavelengths [103]. After that, S. Xiang et al. proposed a VCSEL-based SNN [147], and further presented a photonic approach for binary convolution [150]. Then they also emulated the sound azimuth detection function of the human brain based on VCSELs, in which the time interval of two spikes indicates the sound azimuth [151].

Other nonlinear optical cavities can also implement spiking dynamics [156-167]. In 2016, B. Shastri et al. experimentally verified that graphene laser-based all-optical fiber neurons (Fig. 7(B)) can implement spiking dynamics including consecutive spike generation, suppression of sub-threshold responses, refractory periods, and bursting behaviors with strong inputs [153]. A. Jha et al. proposed a spiking neuron using a graphene-on-silicon MRR, which enables spikes delivered at a high speed and improves the overall power efficiency [156]. Besides, with highly contrasting optical and electrical features between the amorphous and crystalline states, PCM can also implement spiking neurons. In 2018, I. Chakraborty et al. demonstrated an optical spiking neuron based on the phase change dynamics of GST embedded on the top of a MRR [99]. Soon after, J. Feldman et al. constructed an optical spiking neuron composed of the PCM and MRRs in 2019 [37], where the PCM unit on the ring resonator served as the excitable devices. In [149], a VCSEL-based spiking neuron with integrate-and-fire capability was demonstrated (Fig. 7(D)), achieving power summation of multiple fast input pulses. In [166], a spiking neuron network based on a degenerate optical parametric oscillator was constructed (Fig. 7(F)). It consists of a fiber-ring cavity and opto-electronic feedback system, which could accommodate more than 5000 time-domain multiplexed pulses in the 5- μ s round-trip time.

The WDM technique has also played a significant role in achieving photonic SNNs. The optical pulses encoded on to different wavelengths are inherently transmitted without crosstalk, and the weighted optical signals from different nodes can be detected/summed via photodetectors. In 2014, A. Tait et al. proposed an optical SNN (Fig. 7(C)) based on the WDM technique [87], supporting large-scale parallel interconnections among high-performance optical spiking neurons (as introduced in Section 2.2). The following year, M. Nahmias et al. presented a method to cascade DFB spiking neurons into a large-scale network [143], where the capacity of each waveguide was boosted by WDM. Afterwards, J. Feldman et al. demonstrated a WDM-based optical SNN (Fig. 7(E)), with input spikes at different wavelengths multiplexed and integrated via post-synaptic spiking neuron [37].

Compared to continuous-valued ONNs, spiking ONNs are more similar to the intuitive model of biological brains. While current research mostly focuses on building high-performance spiking neurons, the network structure, data fan-in/out, and hardware integration remains an unsolved puzzle.

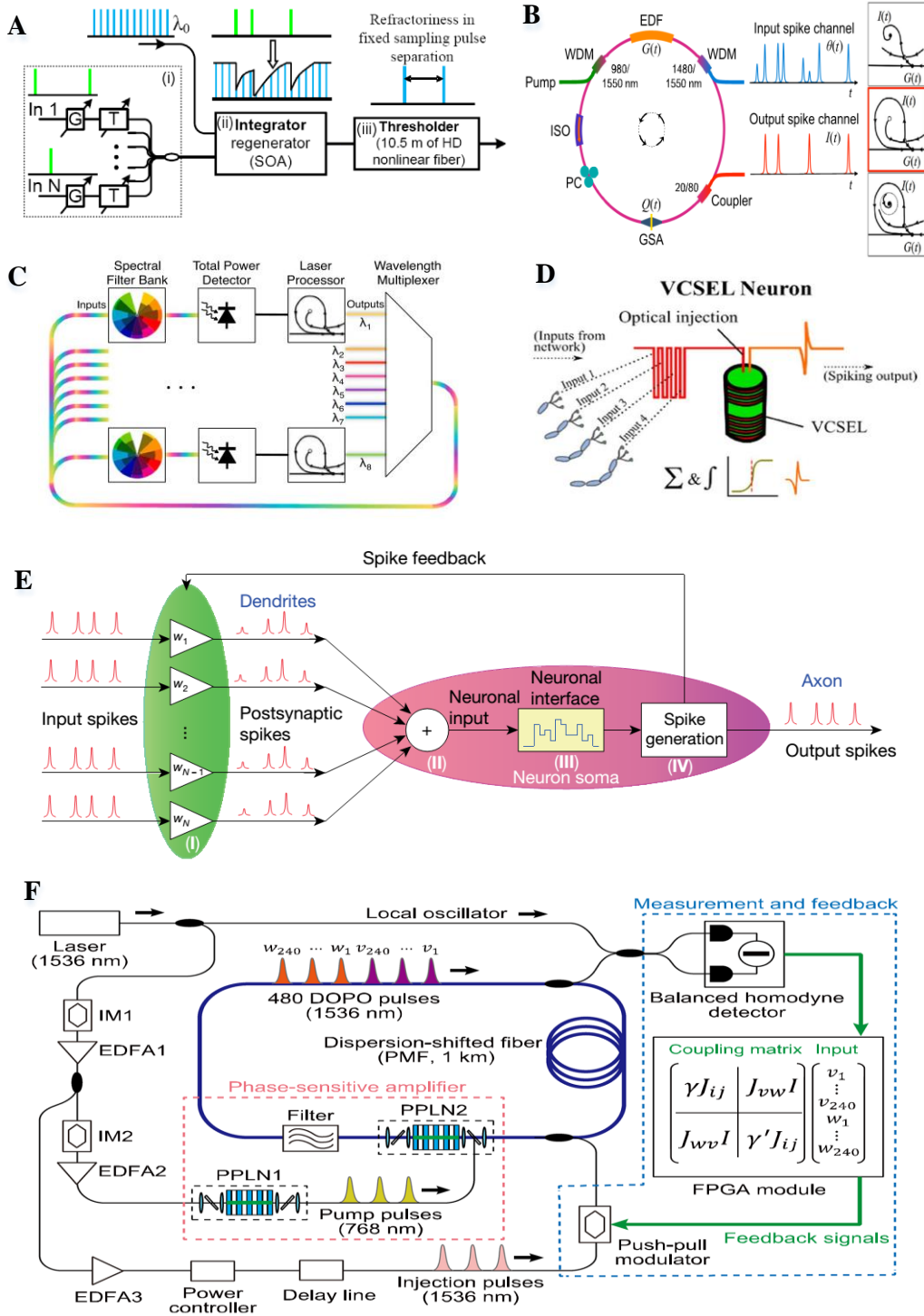

Fig. 7 Advances in optical SNNs. (A) A spiking neuron based on SOA [140]. (B) Graphene laser-based all-optical fiber neurons [153]. (C) A spiking neuron network based on WDM [87]. (D) A spiking neuron based on VCSEL and TDM [149]. (E) A spiking neuron network based on WDM and PCM [37]. (F) Schematic diagram of a DOPO neural network based on time-domain multiplexing in a 1-km fiber-ring cavity [166].

4 Outlook

The key to neuromorphic photonic computing hardware is to achieve a sufficiently large parallelism to in order to map the input nodes and synapses onto physical parameters, as the optical systems are analog, as well as to boost the overall computing speed in cooperation with high-speed electro-optic interfaces. Although significant advances have been made in neuromorphic optics, the unique advantage of optics, such as the ultra-large bandwidths and multiple dimensions for multiplexing, have yet been fully realized. Extensive progress remains to be made in terms of collectively combining existing techniques to develop devices tailored for ONNs, especially in terms of key components and integration platforms, optical computing operators/algorithms, and electro-optic hybrid logics/architectures), in order to boost the compu-

ting performance of optics, making them comparable with, and ultimately enabling them to partially replace, their electronic counterparts.

The key components and integration platforms for ONNs are mainly centred around those that are critical to implementing multiplexing techniques. SDM is implemented with massive optical devices (both passive and active) densely integrated onto a single chip, which requires: low propagation loss waveguides and crossings, such as ~ 1 dB/m achieved by SiN platforms using the Damascene reflow process [168]. Also important are heterogeneous integration techniques that enable compact footprints for computing cores involving active (ie., gain media or light sources), photodetectors, modulators and passive computing cores (such as MZI arrays) [169-171]. Finally, multi-layer photonic circuits exploiting the vertical dimension of integration, other than planar circuits [172] can also be exploited.

WDM is implemented mainly through the use of optical frequency combs that provide a large number of evenly spaced wavelength channels, and spectral shapers to manage the wavelength channels. Microcombs generated via parametric oscillation in high-Q micro-resonators, are promising optical frequency comb sources, as they offer a large number of wavelengths in integrated platforms. Significant advances have been made in microcombs, leading to a wideband, compact, high-energy-efficiency (even battery driven operation), turnkey and mass-producible comb sources for WDM-based ONNs [173-183].

TDM is implemented based on high-speed electro-optic interfaces including modulators and photodetectors, which communicate with external electronics (such as analog-to-digital converters, digital-to-analog converters, and memories). A diverse range of integrated platforms, including lithium niobate (LiNbO_3) [184], hybrid silicon and LiNbO_3 [185], thin-film LiNbO_3 -on-insulator (LNOI) [186], InP [187], and hybrid silicon polymer [188], have readily demonstrated these high-speed interface devices.

PDM and MDM are additional dimensions of optics for multiplexing, and they can greatly scale the parallelism of ONNs as they can operate together with other multiplexing techniques. The key to construct PDMs or MDM-based ONNs lies in achieving on-chip polarization/mode sensitive devices to offer suitable fan-in/-out, such as the dual-polarization LNOI modulator that can utilize two polarization states [189], and the PCM cells capable of switching supported optical modes [137]. In addition, while multiplexing techniques address the mapping of neurons' input nodes and synapses, the nonlinear functions, albeit demonstrated in [55], remains challenging for integrated platforms. They can be potentially achieved via either highly-nonlinear optical materials/structures, or electro-optic devices [73] employed in the interfaces of ONNs.

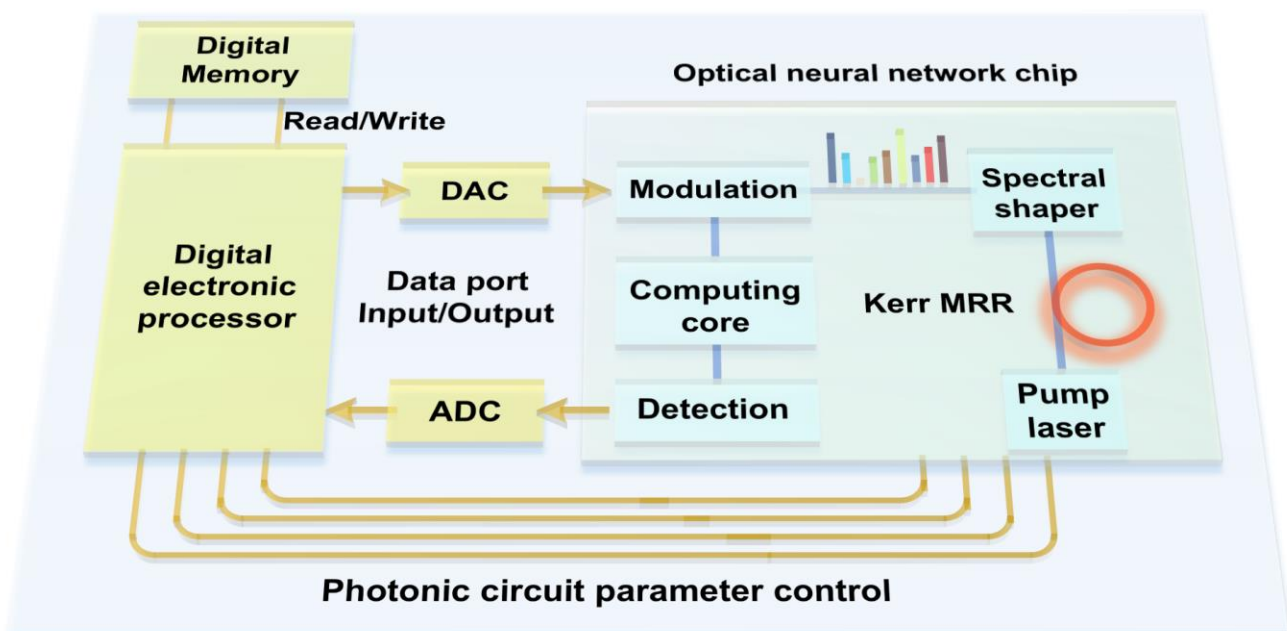

Fig. 8 Schematic of a hybrid integrated neuromorphic photonic processor architecture.

While analog optics features potentially much higher computing power and energy efficiency, they are inherently limited in terms of flexibility and versatility in contrast to digital electronics based on Von Neumann structures with distributed processors and memories. As such, hybrid opto-electronic neuromorphic hardware is a promising solution that leverages the advantages of both optics and electronics, where optics undertakes the majority of specific computing operations while electronics manages hardware parameters and data storage. Under such architectures, the optical computing cores serve as callable modules embedded in external electronic hardware, with the data rate and analog bandwidths matching each other. It is optimistically expected that, with more categories of optical computing operations, algorithms and architectures being demonstrated, ONNs can serve as a universal building block for diverse machine learning tasks [183], [190-195]. Integrated microcombs in particular have experienced dramatic advances in the past 5 years, [196-217] enabling breakthroughs in many areas including microwave photonics [218-239] and quantum optics. [240-251] These will certainly play a central role in future optical neural network systems. With the dramatically accelerated computing speed brought about by the hybrid opto-electronic computing architecture, much more complicated neural networks can be enabled, potentially leading to revolutionary advances in applications such as automated vehicles, real-time data processing, and medical diagnosis.

5 Conclusion

Photonic multiplexing techniques have remarkable capacity for implementing the optoelectronic hardware that is isomorphic to neural networks, which can offer competitive performance in connectivity and linear operation of neural network. In this review, we have presented typical architectures and the recent advances of ONNs that utilize different photonic multiplexing/hybrid-multiplexing techniques involving SDM, WDM, TDM, MDM, and PDM to achieve inter-connection and computing operations. The challenges and future possibilities of ONNs are also discussed.

Conflict of interest statement: The authors declare no conflicts of interest regarding this article.

References

- [1] Y. Lecun, Y. Bengio, and G. Hinton, "Deep learning," *Nature*, vol. 521, no.7553, pp. 436-444, 2015.
- [2] V. Mnih, K. Kavukcuoglu, D. Silver, et al., "Human-level control through deep reinforcement learning," *Nature*, vol. 518, no. 7540, pp. 529-533, 2015.
- [3] D. Silver, A. Huang, C. J. Maddison, et al., "Mastering the game of Go with deep neural networks and tree search," *Nature*, vol. 529, no.7587, pp.484-489, 2016.
- [4] P. M. R. Devries, F. Viegas, M. Wattenberg, and B. J. Meade, "Deep learning of aftershock patterns following large earthquakes," *Nature*, vol. 560, no. 7720, pp. 632-634, 2018.
- [5] S. Webb, "Deep learning for biology," *Nature*, vol. 554, no. 7693, pp. 555-557, 2018.
- [6] M. Reichstein, G. Camps-Valls, B. Stevens et al., "Deep learning and process understanding for data-driven earth system science," *Nature*, vol. 566, no. 7743, pp. 195-204, 2019.
- [7] X. Xu, Y. Ding, S. Hu, et al., "Scaling for edge inference of deep neural networks," *Nat. Electron.*, vol. 1, no. 4, pp. 216-222, 2018.
- [8] C. Toumey, "Less is Moore," *Nat. Nanotechnology*, vol. 11, no. 1, pp. 2-3, 2016.
- [9] G. D. Ronald, W. Michael, B. David, S. Dennis, and N. M. Trevor, "Near-threshold computing: reclaiming Moore's law through energy efficient integrated circuits," *Proc. IEEE*, vol. 98, no. 2, pp. 253-266, 2010.
- [10] S. Ambrogio, P. Narayanan, H. Tsai, et al., "Equivalent-accuracy accelerated neural-network training using analogue memory," *Nature*, vol. 558, no. 7708, pp. 60-67, 2018.
- [11] D. A. B. Miller, "Attojoule optoelectronics for low-energy information processing and communications," *J. Light-wave Technol.*, vol. 35, no. 3, pp. 346-396, 2017.
- [12] K. Kitayama, M. Notomi, M. Naruse, and K. Inoue, "Novel frontier of photonics for data processing—photonic accelerator," *APL Photonics*, vol. 4, no. 9, p. 090901, 2019.
- [13] M. M. Waldrop, "The chips are down for Moore's law," *Nature*, vol. 530, no. 7589, pp. 144-147, 2016.
- [14] T. F. de Lima, B. J. Shastri, A. N. Tait, M. A. Nahmias, and P. R. Prucnal, "Progress in neuromorphic photonics," *Nanophotonics*, vol. 6, no. 3, pp. 577-599, 2017.
- [15] Q. Zhang, H. Yu, M. Barbiero, B. Wang, and M. Gu, "Artificial neural networks enabled by nanophotonics," *Light Sci. Appl.*, vol. 8, no. 1, pp. 42, 2019.
- [16] T. F. de Lima, A. N. Tait, A. Mehrabian, et al., "Primer on silicon neuromorphic photonic processors: architecture and compiler," *Nanophotonics*, vol. 9, no. 13, pp. 4055-4073, 2020.
- [17] E. Goi, Q. Zhang, X. Chen, H. Luan, and M. Gu, "Perspective on photonic memristive neuromorphic computing," *Photonix*, vol. 1, no. 3, pp. 115-133, 2020.
- [18] G. Wetzstein, A. Oacan, S. Gigan, et al., "Inference in artificial intelligence with deep optics and photonics," *Nature*, vol. 588, no. 7836, pp. 39-47, 2020.
- [19] B. J. Shastri, A. N. Tait, T. F. de Lima, et al., "Photonics for artificial intelligence and neuromorphic computing," *Nat. Photonics*, vol. 15, no. 2, pp. 102-114, 2021.
- [20] K. Berggren, Q. Xia, K. Likharev, et al., "Roadmap on emerging hardware and technology for machine learning," *Nanotechnology*, vol. 32, no. 1, pp. 012002, 2021.
- [21] J. Liu, Q. Wu, X. Sui, et al., "Research progress in optical neural networks: theory, applications and developments," *Photonix*, vol. 2, no. 1, 2021.
- [22] C. Li, X. Zhang, J. Li, T. Fang, and X. Dong, "The challenges of modern computing and new opportunities for optics," *Photonix*, vol. 2, no. 1, 2021.
- [23] C. Huang, V. J. Sorger, M. Miscuglio, et al., "Prospects and applications of photonic neural networks," *Advances in Physics-X*, vol. 7, no. 1, 2022.
- [24] H. Zhou, J. Dong, J. Cheng, et al., "Photonic matrix multiplication lights up photonic accelerator and beyond," *Light Sci. Appl.*, vol. 11, no. 1, pp. 30, 2022.
- [25] D. Midtvedt, V. Mylnikov, A. Stilgoe, et al., "Deep learning in light-matter interactions," *Nanophotonics*, vol. 11, no. 14, pp. 3189-3214, 2022.
- [26] G. Pandey, A. Choudhary, A. Dixit, "Wavelength division multiplexed radio over fiber links for 5G fronthaul networks," *IEEE J. Sel. Areas Commun.*, vol. 39, no. 9, pp. 2789-2803, 2021.

- [27] A. Macho, M. Morant, R. Llorente, “Next-generation optical fronthaul systems using multicore fiber media,” *J. Lightwave Technol.*, vol. 34, no. 20, pp. 4819-4827, 2016.
- [28] L-W. Luo, N. Ophir, C. P. Chen, et al., “WDM-compatible mode-division multiplexing on a silicon chip,” *Nat. Commun.*, vol. 5, no. 1, pp. 3069, 2014.
- [29] A. Gnauck, R. W. Tkach, A. R. Chraplyvy, and T. Li, “High-capacity optical transmission systems,” *J. Lightwave Technol.*, vol. 26, no. 9, pp. 1032-1045, 2008.
- [30] D. J. Richardson, J. M. Fini, and L. E. Nelson, “Space-division multiplexing in optical fibres,” *Nat. Photonics*, vol. 7, no. 5, pp. 354-362, 2013.
- [31] P. J. Winzer, “High-spectral-efficiency optical modulation formats,” *J. Lightwave Technol.*, vol. 30, no. 24, pp. 3824-3835, 2012.
- [32] N. Cvijetic, “OFDM for next-generation optical access networks,” *J. Lightwave Technol.*, vol. 30, no. 4, pp. 384-398, 2012.
- [33] B. J. Puttnam, G. Rademacher, and R. S. Luis, “Space-division multiplexing for optical fiber communications,” *Optica*, vol. 8, no. 9, pp. 1186-1203, 2021.
- [34] F. Ren, J. Li, T. Hu, et al., “Cascaded mode-division-multiplexing and time-division-multiplexing passive optical network based on low mode-crosstalk FMF and mode MUX/DEMUX,” *IEEE Photonics J.*, vol. 7, no. 5, pp. 1-9, 2015.
- [35] X. Fang, H. Ren, and M. Gu, “Orbital angular momentum holography for high-security encryption,” *Nat. Photonics*, vol. 14, pp. 102-108, 2020.
- [36] Y. Shen, N. C. Harris, S. Skirlo, et al., “Deep learning with coherent nanophotonic circuits,” *Nat. Photonics*, vol. 11, no. 7, pp. 441-446, 2017.
- [37] J. Feldmann, N. Youngblood, C. D. Wright, H. Bhaskaran, and W. H. P. Pernice, “All-optical spiking neurosynaptic networks with self-learning capabilities,” *Nature*, vol. 569, no. 7755, pp. 208-214, 2019.
- [38] J. Feldmann, N. Youngblood, M. Karpov, et al., “Parallel convolutional processing using an integrated photonic tensor core,” *Nature*, vol. 589, no. 7840, pp. 52-58, 2021.
- [39] X. Xu, M. Tan, B. Corcoran, et al., “11 TOPS photonic convolutional accelerator for optical neural networks,” *Nature*, vol. 589, no. 7840, pp. 44-51, 2021.
- [40] H. Luan, D. Lin, K. Li, W. Meng, M. Gu, and X. Fang, “768-ary Laguerre-Gaussian-mode shift keying free-space optical communication based on convolutional neural networks,” *Opt. Express*, vol. 29, no. 13, pp. 19807-19818, 2021.
- [41] W. Xin, Q. Zhang, and M. Gu, “Inverse design of optical needles with central zero-intensity points by artificial neural networks,” *Opt. Express*, vol. 28, no. 26, pp. 38718-38732, 2020.
- [42] E. Goi, X. Chen, Q. Zhang, B. P. Cumming, S. Schoenhardt, H. Luan and M. Gu, “Nanoprinted high-neuron-density optical linear perceptrons performing near-infrared inference on a CMOS chip,” *Light Sci. Appl.*, vol. 10, no. 40, pp. 1-11, 2021.
- [43] B. P. Cumming, and M. Gu, “Direct determination of aberration functions in microscopy by an artificial neural network,” *Opt. Express*, vol. 28, no. 10, pp. 14511-14521, 2020.
- [44] D. Perez, I. Gasulla, P. Das Mahapatra, and J. Capmany, “Principles, fundamentals, and applications of programmable integrated photonics,” *Adv. Opt. Photonics*, vol. 12, no. 3, pp. 709-786, 2020.
- [45] W. Bogaerts, D. Perez, J. Capmany, et al., “Programmable photonic circuits,” *Nature*, vol. 586, no. 7828, pp. 207-216, 2020.
- [46] D. Perez, I. Gasulla, and J. Capmany, “Programmable multifunctional integrated nanophotonics,” *Nanophotonics*, vol. 7, no. 8, pp. 1351-1371, 2018.
- [47] W. Bogaerts, L. Chrostowski, “L. Silicon photonics circuit design: methods, tools and challenges,” *Laser & Photonics Reviews*, vol. 12, no. 4, 2018.
- [48] K. Nozaki, S. Matsuo, T. Fujii, et al., “Femtofarad optoelectronic integration demonstrating energy-saving signal conversion and nonlinear functions,” *Nat. Photonics*, vol. 13, no. 7, pp. 454-459, 2019.
- [49] M. A. Nahmias, T. F. de Lima, A. N. Tait, H-T. Peng, B. J. Shastri, and P. R. Prucnal, “Photonic multiply-accumulate operations for neural networks,” *IEEE J. Sel. Top. Quant.*, vol. 26, no. 1, pp. 1-18, 2020.
- [50] T. De Lima, H. Peng, A. Tait, et al. “Machine learning with neuromorphic photonics,” *J. Lightwave Technol.*, vol. 37, no. 5, pp. 1515-1534, 2019.
- [51] T. De Lima, A. Tait, H. Saeidi, et al., “Noise analysis of photonic modulator neurons,” *IEEE J. Sel. Top. Quantum Electron.*, vol. 26, no. 1, pp. 1-9, 2019.
- [52] K. von Bieren. “Lens design for optical Fourier transform systems,” *Appl. Opt.*, vol. 10, no. 12, pp. 2739-2742, 1971.
- [53] J. W. Goodman, A. R. Dias, and L. M. Woody, “Fully parallel, high-speed incoherent optical method for performing discrete Fourier transforms,” *Opt. Lett.*, vol. 2, no. 1, pp. 1-3, 1978.
- [54] J. Chang, V. Sitzmann, X. Dun, W. Heidrich, and G. Wetzstein, “Hybrid optical-electronic convolutional neural networks with optimized diffractive optics for image classification,” *Sci. Rep.*, vol. 8, no. 1, pp. 12324, 2018.
- [55] Y. Zuo, B. Li, Y. Zhao, and Y. Jiang, “All-optical neural network with nonlinear activation functions,” *Optica*, vol. 6, no. 9, pp. 1132-1137, 2019.
- [56] T. Yan, J. Wu, T. Zhou, et al., “Fourier-space diffractive deep neural network,” *Phys. Rev. Lett.*, vol. 123, no. 2, pp. 023901, 2019.

- [57] E. P. Mosca, R. D. Griffin, F. P. Pursel, and J. N. Lee, "Acoustooptical matrix-vector product processor: implementation issues," *Appl. Opt.*, vol. 28, no. 18, pp. 3843-3851, 1989.
- [58] C-C. Sun, M-W. Chang, and K. Y. Hsu, "Matrix-matrix multiplication by using anisotropic self-diffraction in BaTiO₃," *Appl. Opt.*, vol. 33, no. 20, pp. 4501-4507, 1994.
- [59] H. J. Caulfield, and S. Dolev, "Why future supercomputing requires optics," *Nat. Photonics*, vol. 4, no. 5, pp. 261-263, 2010.
- [60] X. Lin, Y. Rivenson, N. T. Yardimci, et al., "All-optical machine learning using diffractive deep neural networks," *Science*, vol. 361, no. 6406, pp. 1004-1008, 2018.
- [61] T. Zhou, X. Lin, J. Wu, and Y. Chen, et al., "Large-scale neuromorphic optoelectronic computing with a reconfigurable diffractive processing unit," *Nat. Photonics*, vol. 15, no. 5, pp. 367-373, 2021.
- [62] T. Yan, R. Yang, Z. Zheng, et al., "All-optical graph representation learning using integrated diffractive photonic computing units," *Sci. Adv.*, vol. 8, no. 24, p. 7630, 2022.
- [63] T. Wang, S. Ma, L. G. Wright, et al., "An optical neural network using less than 1 photon per multiplication," *Nat. Commun.*, vol. 13, no. 1, p. 123, 2022.
- [64] C. Liu, Q. Ma, Z. Luo, et al., "A programmable diffractive deep neural network based on a digital-coding metasurface array," *Nat. Electron.*, vol. 5, pp. 113-122, 2022.
- [65] M. Reck, A. Zeilinger, H. J. Bernstein, and P. Bertani, "Experimental realization of any discrete unitary operator," *Phys. Rev. Lett.*, vol. 73, no. 1, pp. 58-61, 1994.
- [66] W. R. Clements, P. C. Humphreys, B. J. Metcalf, et al., "Optimal design for universal multiport interferometers," *Optica*, vol. 3, no. 12, pp. 1460-1465, 2016.
- [67] H. Zhang, M. Gu, X. D. Jiang, et al., "An optical neural chip for implementing complex-valued neural network," *Nat. Commun.*, vol. 12, no. 1, pp. 1-11, 2021.
- [68] H. Zhu, J. Zou, H. Zhang, et al., "Space-efficient optical computing with an integrated chip diffractive neural network," *Nat. Commun.*, vol. 13, no. 1, p. 1044, 2022.
- [69] R. Burgwal, W. R. Clements, D. H. Smith, et al., "Using an imperfect photonic network to implement random unitaries," *Opt. Express*, vol. 25, no. 23, pp. 28236-28245, 2017.
- [70] M Y S. Fang, S. Manipatruni, C. Wierzynski, et al., "Design of optical neural networks with component imprecisions," *Opt. Express*, vol. 27, no. 10, pp. 14009-14029, 2019.
- [71] Y. Tian, Y. Zhao, S. Liu, et al., "Scalable and compact photonic neural chip with low learning-capability-loss," *Nanophotonics*, vol. 11, no. 2, pp. 329-344, 2021.
- [72] H. Zhou, Y. Zhao, G. Xu, et al., "Chip-scale optical matrix computation for PageRank algorithm," *IEEE J. Sel. Top. Quant. El.*, vol. 26, no. 2, pp. 1-10, 2020.
- [73] F. Ashtiani and A. J. Geers & F. Aflatouni, "An on-chip photonic deep neural network for image classification," *Nature*, vol. 606, no. 7914, pp. 501-506, 2022.
- [74] D. Brunner and I. Fischer, "Reconfigurable semiconductor laser networks based on diffractive coupling," *Opt. Lett.*, vol. 40, no. 16, pp. 3854-3857, 2015.
- [75] K. Vandoorne, W. Dierckx, B. Schrauwen, et al., "Toward optical signal processing using photonic reservoir computing," *Opt. Express*, vol. 16, no. 15, pp. 11182-11192, 2008.
- [76] K. Vandoorne, J. Dambre, D. Verstraeten, et al., "Parallel reservoir computing using optical amplifiers," *IEEE Trans. Neural Net.*, vol. 22, no. 9, pp. 1469-1481, 2011.
- [77] K. Vandoorne, P. Mechet, T. V. Vaerenbergh, et al., "Experimental demonstration of reservoir computing on a silicon photonics chip," *Nat. Commun.*, vol. 5, no. 1, p. 3541, 2014.
- [78] A. Katumba, M. Freiberger, P. Bienstman, and J. Dambre, "A multiple-input strategy to efficient integrated photonic reservoir computing," *Cognitive Computation*, vol. 9, no. 3, pp. 307-314, 2017.
- [79] A. Kautumba, J. Heyvaert, B. Schneider, et al., "Low-loss photonic reservoir computing with multimode photonic integrated circuits," *Sci. Rep.*, vol. 8, no. 1, p. 2653, 2018.
- [80] J. Bueno, S. Maktoobi, L. Froehly, et al., "Reinforcement learning in a large-scale photonic recurrent neural network," *Optica*, vol. 5, no. 6, pp. 756-760, 2018.
- [81] J. Dong, M. Rafayelyan, F. Krzakala, and S. Gigan, "Optical reservoir computing using multiple light scattering for chaotic systems prediction," *IEEE J. Sel. Top. Quantum Electron.*, vol. 26, no. 1, pp. 1-12, 2020.
- [82] T. Heuser, J. Große, S. Holzinger, M. M. Sommer, and S. Reitzenstein, "Development of highly homogenous quantum dot micropillar arrays for optical reservoir computing," *IEEE J. Sel. Top. Quantum Electron.*, vol. 26, no. 1, pp. 1-9, 2020.
- [83] U. Paudel, M. Luengo-Kovac, J. Pilawa, T. Justin Shaw, and G. Valley, "Classification of time-domain waveforms using a speckle-based optical reservoir computer," *Opt. Express*, vol. 28, no. 2, pp. 1225-1237, 2020.
- [84] E. Gooskens, F. Laporte, C. Ma, S. Sackesyn, J. Dambre and P. Bienstman, "Wavelength dimension in waveguide-based photonic reservoir computing," *Opt. Express*, vol. 30, no. 9, pp. 15634-15647, 2022.
- [85] Q. Xu and R. Soref, "Reconfigurable optical directed-logic circuits using microresonator-based optical switches," *Opt. Express*, vol. 19, no. 6, pp. 5244-5259, 2011.
- [86] L. Yang, R. Ji, et al., "On-chip CMOS-compatible optical signal processor," *Opt. Express*, vol. 20, no. 12, pp. 13560-13565, 2012.
- [87] A. N. Tait, et al., "Broadcast and weight: an integrated network for scalable photonic spike processing," *J. Lightwave Technol.*, vol. 32, no. 21, pp. 4029-4041, 2014.

- [88] A. N. Tait, et al., “Neuromorphic photonic networks using silicon photonic weight banks.” *Sci. Rep.*, vol. 7, no. 1, p. 7430, 2017.
- [89] A. N. Tait, et al., “Multi-channel control for microring weight banks,” *Opt. Express*, vol. 24, no. 8, pp. 8895–8906, 2016.
- [90] A. N. Tait, et al., “Continuous calibration of microring weights for analog optical networks,” *IEEE Photon. Technol. Lett.*, vol. 28, no. 8, pp. 887–890, 2016.
- [91] A. N. Tait, et al., “Microring weight banks,” *IEEE J. Sel. Top. Quantum Electron.*, vol. 22, no.6, pp. 312–325, 2016.
- [92] C. Huang, S. Bilodeau, et al., “Demonstration of scalable microring weight bank control for large-scale photonic integrated circuits,” *APL Photonics*, vol. 5, no. 4, p. 040803, 2020.
- [93] S. Xu, J. Wang, and W. Zou, “Optical convolutional neural network with WDM-based optical patching and microring weighting banks,” *IEEE Photonics Technol. Lett.*, vol. 33, no. 2, pp. 89–92, 2021.
- [94] V. Bangari, et al., “Digital electronics and analog photonics for convolutional neural networks (DEAP-CNNs),” *IEEE J. Sel. Top. Quantum Electron.*, vol. 26, no. 1, pp. 1-13, 2020.
- [95] C. Huang, et al., “A silicon photonic-electronic neural network for fibre nonlinearity compensation,” *Nat. Electron.*, vol. 4, no. 11, pp. 837-844, 2021.
- [96] B. Shi, N. Calabretta, and R. Stabile, “Deep neural network through an InP SOA-based photonic integrated cross-connect,” *IEEE J. Sel. Top. Quantum Electron.*, vol. 26, no.1, pp. 1-11, 2020.
- [97] G. Mourgias-Alexandris, A. Tsakyridis, N. Passalis, et al., “An all-optical neuron with sigmoid activation function,” *Opt. Express*, vol. 27, no. 7, p. 9620, 2019.
- [98] B. Shi, N. Calabretta, and R. Stabile, “InP photonic integrated multi-layer neural networks: Architecture and performance analysis,” *APL Photonics*, vol. 7, no. 1, p. 010801, 2022.
- [99] I. Chakraborty, G. Saha, A. Sengupta, and K. Roy, “Toward fast neural computing using all-photonic phase change spiking neurons,” *Sci. Rep.*, vol. 8, no. 1, p. 12980, 2018.
- [100] X. Li et al., “On-chip phase change optical matrix multiplication core,” *IEEE Int. Electron Devices Meet.*, pp. 7.5.1-7.5.4, 2020.
- [101] M. A. Nahmias, H. Peng, et al., “A teraMAC neuromorphic photonic processor,” *IEEE photonics Conf. (IPC)*, pp. 1–2, 2018.
- [102] J. M. Shainline, S.M. Buckley, A.N. McCaughan, J. Chiles, et al., “Circuit designs for superconducting optoelectronic loop neurons,” *J. Appl. Phys.*, vol. 124, no. 15, p. 152130, 2018.
- [103] J. Shastri, A. N. Tait, and P. R. Prucnal, “A leaky integrate-and-fire laser neuron for ultrafast cognitive computing,” *IEEE J. Sel. Top. Quantum Electron.*, vol. 19, no. 5, pp. 1-12, 2013.
- [104] A. N. Tait, J. Chang, B. J. Shastri, M. A. Nahmias, and P. R. Prucnal, “Demonstration of WDM weighted addition for principal component analysis,” *Opt. Express*, vol. 23, no. 10, pp. 12758-12765, 2015.
- [105] X. Xu, et al., “Photonic perceptron based on a Kerr microcomb for high-speed, scalable, optical neural networks,” *Laser Photonics Rev.*, vol. 14, no. 10, pp. 44-51, 2020.
- [106] G. Mourgias-Alexandris, G. Dabos, N. Passalis, A. Totović, A. Tefas and N. Pleros, “All-optical WDM recurrent neural networks with gating,” *IEEE J. Sel. Top. Quantum Electron.*, vol. 26, no. 5, pp. 1-7, 2020.
- [107] A. Totovic, G. Giamougiannis, A. Tsakyridis, et al., “Programmable photonic neural networks combining WDM with coherent linear optics,” *Sci. Rep.*, vol. 12, no. 1, p. 5605, 2022.
- [108] Y. Huang, W. Zhang, F. Yang, J. Du, and Z. He, “Programmable matrix operation with reconfigurable time-wavelength plane manipulation and dispersed time delay,” *Opt. Express*, vol. 27, no. 15, pp. 20456–20467, 2019.
- [109] S. Xu, J. Wang, and W. Zou, “Optical patching scheme for optical convolutional neural networks based on wavelength-division multiplexing and optical delay lines,” *Opt. Lett.*, vol. 45, no. 13, pp. 3689–3692, 2020.
- [110] Y. Jiang, W. Zhang, F. Yang, et al., “Photonic convolution neural network based on interleaved time-wavelength modulation,” *J. Lightwave Technol.*, vol. 39, no. 14, pp. 4592-4600, 2021.
- [111] D. Brunner, B. Penkovsky, B. A. Marquez, et al., “Tutorial: photonic neural networks in delay systems,” *Journal of Applied Physics*, vol. 124, no. 15, pp. 1-14, 2018.
- [112] G. Sande, D. Brunner, and M. Soriano, “Advances in photonic reservoir computing,” *Nanophotonics*, vol. 6, no. 3, pp. 561-576, 2017.
- [113] J. Herbert, “The echo state approach to analyzing and training recurrent neural networks,” *German National Research Center for Information Technology*, 2001.
- [114] W. Maass, T. Natschlagler, and H. Markram, “Real-time computing without stable states: a new framework for neural computation based on perturbations,” *Neural Comput.*, vol.14, no. 11, pp. 2531-2560, 2002.
- [115] D. Verstraeten, B. Schrauwen, M. D. Haene, and D. Stroobandt, “An experimental unification of reservoir computing methods,” *Neural Networks*, vol. 20, no. 3, pp. 391-403, 2007.
- [116] L. Appeltant, M. C. Soriano, G. Van der Sande, et al., “Information processing using a single dynamical node as complex,” *Nat. Commun.*, vol. 2, no. 1, p. 468, 2011.
- [117] L. Larger, M. C. Soriano, D. Brunner, et al., “Photonic information processing beyond Turing: an optoelectronic implementation of reservoir computing,” *Opt. Express*, vol. 20, no. 3, pp. 3241-3249, 2012.
- [118] Y. Paquot, F. Duport, A. Smerieri, et al., “Optoelectronic reservoir computing,” *Sci. Rep.*, vol. 2, no. 1, p. 287, 2012.
- [119] F. Duport, B. Schneider, A. Smerieri, et al., “All-optical reservoir computing,” *Opt. Express*, vol. 20, no. 20, pp. 22783-22795, 2012.

- [120] D. Brunner, M. C. Soriano, C. R. Mirasso, et al., "Parallel photonic information processing at gigabyte per second data rates using transient states," *Nat. Commun.*, vol. 4, p. 1364, 2013.
- [121] L. Larger, A. Baylón-Fuentes, R. Martinenghi, et al., "High-speed photonic reservoir computing using a time-delay-based architecture: million words per second classification," *Phys. Rev. X*, vol. 7, no. 1, 2017.
- [122] J. Vatin, D. Rontani, M. Sciamanna, et al., "Enhanced performance of a reservoir computer using polarization dynamics in VCSELs," *Opt. Lett.*, vol. 43, no. 18, pp. 4497-4500, 2018.
- [123] Y. Yang, P. Zhou, P. Mu, and N. Li, "Time-delayed reservoir computing based on an optically pumped spin VCSEL for high-speed processing," *Nonlinear Dyn.*, vol. 107, no. 395, pp. 2619-2632, 2022.
- [124] M. Borghi, S. Biasi, and L. Pavesi, "Reservoir computing based on a silicon microring and time multiplexing for binary and analog operations," *Sci. Rep.*, vol. 11, no. 1, p. 15642, 2021.
- [125] X. Liang, Y. Zhong, J. Tang, et al., "Rotating neurons for all-analog implementation of cyclic reservoir computing," *Nat. Commun.*, vol. 13, no. 1, p. 1549, 2022.
- [126] K. Sozos, C. Mesaritakis, and A. Bogris, "Reservoir computing based on mutually injected phase modulated semiconductor lasers as a monolithic integrated hardware accelerator," *IEEE J. Quantum Electron.*, vol. 57, no. 5, pp. 1-7, 2021.
- [127] J. Bueno, J. Robertson, M. Hejda, and A. Hurtado, "Comprehensive performance analysis of a VCSEL-based photonic reservoir computer," *IEEE Photonics Technol. Lett.*, vol. 33, no. 16, pp. 920-923, 2021.
- [128] D. Bazzanella, S. Biasi, M. Mancinelli, and L. Pavesi, "A microring as a reservoir computing node: memory/nonlinear tasks and effect of input non-ideality," *J. Lightwave Technol.*, early publishing, 2022.
- [129] X. Guo, S. Xiang, Y. Qu, Y. Han, A. Wen, and Y. Hao, "Enhanced prediction performance of a neuromorphic reservoir computing system using a semiconductor nanolaser with double phase conjugate feedbacks," *J. Lightwave Technol.*, vol. 39, no. 1, pp. 129-135, 2021.
- [130] D. Yue, Y. Hou, Z. Wu, C. Hu, Z. Xiao, and G. Xia, "Experimental investigation of an optical reservoir computing system based on two parallel time-delay reservoirs," *IEEE Photonics J.*, vol. 13, no. 3, pp. 1-11, 2021.
- [131] J. Tang, B. Lin, J. Yu, X. He, and C. Wang, "Parallel time-delay reservoir computing with quantum dot lasers," *IEEE J. Quantum Electron.*, vol. 58, no. 2, pp. 1-9, 2022.
- [132] J. Jin, N. Jiang, Y. Zhang, W. Feng, et al., "Adaptive time-delayed photonic reservoir computing based on Kalman-filter training," *Opt. Express*, vol. 30, no. 8, pp. 13647-13658, 2022.
- [133] M. Nakajima, K. Tanaka, and T. Hashimoto, "Scalable reservoir computing on coherent linear photonic processor," *Commun. Phys.*, vol. 4, no. 20, 2021.
- [134] J. Xiang, Z. Tao, X. Li, et al., "Metamaterial-enabled arbitrary on-chip spatial mode manipulation," *Light Sci. Appl.*, vol. 11, no. 168, pp. 1-11, 2022.
- [135] Y. Zhou, B. Braverman, A. Fyffe, et al., "High-fidelity spatial mode transmission through a 1-km-long multi-mode fiber via vectorial time reversal," *Nat. Commun.*, vol. 12, no. 1866, pp. 1-7, 2021.
- [136] W. Jiang, J. Miao, and T. Li, "Compact silicon 10-mode multi/demultiplexer for hybrid mode- and polarization-division multiplexing system," *Sci. Rep.*, vol. 9, no. 13233, pp. 1-15, 2019.
- [137] C. Wu, H. Yu, S. Lee, et al., "Programmable phase-change metasurfaces on waveguides for multimode photonic convolutional neural network," *Nat. Commun.*, vol. 12, no. 96, pp. 1-8, 2021.
- [138] J. Li, Y. Hung, O. Kulce, et al., "Polarization multiplexed diffractive computing: all-optical implementation of a group of linear transformations through a polarization-encoded diffractive network," *Light Sci. Appl.*, vol. 11, no. 153, pp. 1-20, 2022.
- [139] W. Maass, "Network of spiking neurons: the third generation of neural network models," *Transactions of the Society for Computer Simulation International*, vol. 14, no. 4, pp. 1659-1671, 1997.
- [140] D. Rosenbluth, K. Kravtsov, M. P. Fok, et al., "A high performance photonic pulse processing device," *Opt. Express*, vol. 17, no. 25, pp. 22767-22772, 2009.
- [141] W. Coomans, L. Gelens, S. Beri, et al., "Solitary and coupled semiconductor ring lasers as optical spiking neurons," *Phys. Rev. E*, vol. 84, no. 3, p. 036209, 2011.
- [142] M. A. Nahmias, A. N. Tait, B. J. Shastri, et al., "An evanescent hybrid silicon laser neuron," *IEEE Int. Conf.*, pp. 93-94, 2013.
- [143] M. A. Nahmias, A. N. Tait, B. J. Shastri, et al., "Excitable laser processing network node in hybrid silicon: analysis and simulation," *Opt. Express*, vol. 23, no. 20, pp. 26800-26813, 2015.
- [144] H. T. Peng, M. A. Nahmias, F. Thomas, et al., "Neuromorphic photonic integrated circuits," *IEEE J. Sel. Top. Quantum Electron.*, vol. 24, no. 6, pp. 1-15, 2018.
- [145] H. T. Peng, G. Angelatos, T. Lima, et al., "Temporal information processing with an integrated laser neuron," *IEEE J. Sel. Top. Quantum Electron.*, vol. 26, no. 1, pp. 1-9, 2019.
- [146] R. Joshua, T. Deng, J. Julien, et al., "Controlled inhibition of spiking dynamics in VCSELs for neuromorphic photonics: theory and experiments," *Opt. Lett.*, vol. 42, no. 8, pp. 1560-1563, 2017.
- [147] S. Xiang, Y. Zhang, J. Gong, et al., "STDP-based unsupervised spike pattern learning in a photonic spiking neural network with VCSELs and VCSOAs," *IEEE J. Sel. Top. Quantum Electron.*, vol. 25, no. 6, p. 1700109, 2019.
- [148] J. Robertson, M. Hejda, J. Bueno, et al., "Ultrafast optical integration and pattern classification for neuromorphic photonics based on spiking VCSEL neurons," *Sci. Rep.*, vol. 10, no. 6098, pp. 1-8, 2020.
- [149] J. Robertson, P. Kirkland, J. A. Alanis, et al., "Ultrafast neuromorphic photonic image processing with a VCSEL neuron," *Sci. Rep.*, vol. 12, no. 4874, pp. 1-10, 2022.

- [150] Y. Zhang, J. Robertson, S. Xiang, et al., "All-optical neuromorphic binary convolution with a spiking VCSEL neuron for image gradient magnitudes," *Photon. Res.*, vol. 9, pp. B201-B209, 2021.
- [151] Z. Song, S. Xiang, Z. Ren, et al., "Photonic spiking neural network based on excitable VCSELs-SA for sound azimuth detection," *Opt. Express*, vol. 28, pp. 1561-1573, 2020.
- [152] B. J. Shastri, M. A. Nahmias, A. N. Tait, et al., "Simulations of a graphene excitable laser for spike processing," *Opt. Quantum Electron.*, vol. 46, no. 10, pp. 1353-1358, 2014.
- [153] B. J. Shastri, M. A. Nahmias, A. N. Tait, et al., "Spike processing with a graphene excitable laser," *Sci. Rep.*, vol. 6, no. 19126, pp. 1-12, 2016.
- [154] P. Y. Ma, B. J. Shastri, T. Lima, et al., "Simultaneous excitatory and inhibitory dynamics in an excitable laser," *Opt. Lett.*, vol. 43, no. 15, pp. 3802-3805, 2018.
- [155] Y. Wei, L. Gui, F. Lin, et al., "A wavelength tunable optical neuron based on a fiber laser," *2021 Photonics & Electromagnetics Research Symposium (PIERS)*, pp. 825-833, 2021.
- [156] A. Jha, C. Huang, H. T. Peng, B. Shastri and P. R. Prucnal, "Photonic spiking neural networks and graphene-on-silicon spiking neurons," *J. Lightwave Technol.*, vol. 40, no. 9, pp. 2901-2914, 2022.
- [157] W. Coomans, S. Beri, G. V. D. Sande, et al., "Optical injection in semiconductor ring lasers," *Phys. Rev. A*, vol. 81, 2010.
- [158] L. Gelens, L. Mashal, S. Beri, et al., "Excitability in semiconductor microring lasers: experimental and theoretical pulse characterization," *Phys. Rev. A*, vol. 82, no. 6, 2010.
- [159] B. Romeira, R. Avo, J. M. L. Figueiredo, et al., "Regenerative memory in time-delayed neuromorphic photonic resonators," *Sci. Rep.*, vol. 6, no. 19510, pp. 1-12, 2016.
- [160] M. Brunstein, A. M. Yacomotti, I. Sagnes, et al., "Excitability and self-pulsing in a photonic crystal nanocavity," *Phys. Rev.*, vol. 85, no. 3, pp. 3304-3311, 2012.
- [161] K. Alexander, T. Van Vaerenbergh, M. Fiers, et al., "Excitability in optically injected microdisk lasers with phase controlled excitatory and inhibitory response," *Opt. Express*, vol. 21, no. 22, pp. 26182-26191, 2013.
- [162] F. Selmi, R. Braive, G. Beaudoin, et al., "Relative refractory period in an excitable semiconductor laser," *Phys. Rev. Lett.*, vol. 112, no. 18, p. 183902, 2014.
- [163] C. Mesaritakis, A. Kapsalis, A. Bogris, et al., "Artificial neuron based on integrated semiconductor quantum dot mode-locked lasers," *Sci. Rep.*, vol. 6, no. 39317, pp. 1-10, 2016.
- [164] V. A. Pammi, K. Alfaro-Bittne, M. G. Clearc, et al., "Photonic computing with single and coupled spiking micropillar lasers," *IEEE J. Sel. Top. Quantum Electron.*, vol. 26, no. 1, pp. 1-7, 2019.
- [165] G. Sarantoglou, M. Skontranis, and C. Mesaritakis, "All optical integrate and fire neuromorphic node based on single section quantum dot laser," *IEEE J. Sel. Top. Quantum Electron.*, vol. 26, no. 5, pp. 1-10, 2020.
- [166] T. Inagaki, K. Inaba, T. Leleu, et al., "Collective and synchronous dynamics of photonic spiking neurons," *Nat. Commun.*, vol. 12, no. 2325, pp. 1-8, 2021.
- [167] R. M. R. Adão, B. Romeira and J. B. Nieder, "Design and fabrication of 3D interconnects for photonic neuronal networks using two-photon polymerization," *2021 Conference on Lasers and Electro-Optics (CLEO)*, pp. 1-2, 2021.
- [168] J. Q. Liu et al., "High-yield, wafer-scale fabrication of ultralow-loss, dispersion-engineered silicon nitride photonic circuits," *Nat. Commun.*, vol. 12, no. 1, 2021.
- [169] J. M. Ramirez et al., "III-V-on-silicon integration: from hybrid devices to heterogeneous photonic integrated circuits," *IEEE J. Sel. Top. Quantum Electron.*, vol. 26, no. 2, pp. 1-13, 2020.
- [170] A. Y. Liu and J. Bowers, "Photonic integration with epitaxial III-V on silicon," *IEEE J. Sel. Top. Quantum Electron.*, vol. 24, no. 6, pp. 1-12, 2018.
- [171] D. Liang, G. Roelkens, R. Baets, and J. E. Bowers, "Hybrid integrated platforms for silicon photonics," *Materials*, vol. 3, no. 3, pp. 1782-1802, 2010.
- [172] F. Hoch, S. Piacentini, T. Giordani, et al., "Reconfigurable continuously-coupled 3D photonic circuit for boson sampling experiments," *npj Quantum Inf.*, vol. 8, no. 1, pp. 1-7, 2022.
- [173] J. Boggio, D. Bodenmüller, S. Ahmed, et al., "Efficient Kerr soliton comb generation in micro-resonator with interferometric back-coupling," *Nat. Commun.*, vol. 13, no. 1292, pp. 1-11, 2022.
- [174] S. Yu, E. Lucas, J. Zang, et al., "A continuum of bright and dark-pulse states in a photonic-crystal resonator," *Nat. Commun.*, vol. 13, no. 3134, pp. 1-10, 2022.
- [175] Z. Lu, H. Chen, W. Wang, et al., "Synthesized soliton crystals," *Nat. Commun.*, vol. 12, no. 1, p. 3179, 2021.
- [176] G. Lihachev, W. Weng, J. Liu, et al., "Platicon microcomb generation using laser self-injection locking," *Nat. Commun.*, vol. 13, no. 1, p. 1771, 2022.
- [177] H. Shu, L. Chang, Y. Tao, et al., "Microcomb-driven silicon photonic systems," *Nature*, vol. 605, no. 7910, pp. 457-463, 2022.
- [178] X. Xu, M. Tan, J. Wu, R. Morandotti, A. Mitchell, and D. J. Moss, "Microcomb-based photonic RF signal processing," *IEEE Photonics Technol. Lett.*, vol. 31, no. 23, pp. 1854-1857, 2019.
- [179] X. Xu, M. Tan, J. Wu, T. G. Nguyen, S. T. Chu, B. E. Little, R. Morandotti, A. Mitchell, and D. J. Moss, "Advanced adaptive photonic RF filters based on an optical micro-comb source with 80 taps," *J. Lightwave Technol.*, vol. 37, no. 4, pp. 1288-1295, 2019.
- [180] X. Xu, J. Wu, M. Shoeiby, T. G. Nguyen, S. T. Chu, B. E. Little, R. Morandotti, A. Mitchell, and D. J. Moss, "Advanced RF and microwave functions based on an integrated optical frequency comb source," *Opt. Express*, vol. 26, no. 3, pp. 2569-2583, 2018.

- [181] X. Xu, J. Wu, M. Tan, T. G. Nguyen, S. T. Chu, B. E. Little, R. Morandotti, A. Mitchell, and D. J. Moss, "Broadband microwave frequency conversion based on an integrated optical micro-comb source," *J. Lightwave Technol.*, vol. 38, no. 2, pp. 332-338, 2020.
- [182] S. Zhang, J. M. Silver, T. Bi, and P. Del'Haye, "Spectral extension and synchronization of microcombs in a single microresonator," *Nat. Commun.*, vol. 11, no. 1, p. 6384, 2020.
- [183] X. Xu, G. Ren, T. Feleppa, et al., "Self-calibrating programmable photonic integrated circuits," *Nat. Photonics*, vol. 16, no. 8, pp. 595-602, 2022.
- [184] C. Wang, M. Zhang, X. Chen, et al., "Integrated lithium niobate electro-optic modulators operating at CMOS-compatible voltages," *Nature*, vol. 562, no. 7725, pp. 101-104, 2018.
- [185] M. He, M. Xu, Y. Ren, et al., "High-performance hybrid silicon and lithium niobate Mach-Zehnder modulators for 100 Gbit s⁻¹ and beyond," *Nat. Photonics*, vol. 13, no. 5, pp. 359-364, 2019.
- [186] A. Mercante, P. Yao, S. Shi, G. Schneider, J. Murakowski, and D. Prather, "110 GHz CMOS compatible thin film LiNbO₃ modulator on silicon," *Opt. Express*, vol. 24, no. 14, pp. 15590-15595, 2016.
- [187] Y. Ogiso, J. Ozaki, et al., "80-GHz bandwidth and 1.5-V V π InP-based IQ modulator," *J. Lightwave Technol.*, vol. 38, no. 2, pp. 249-255, 2020.
- [188] G. Lu, J. Hong, F. Qiu, et al., "High-temperature-resistant silicon-polymer hybrid modulator operating at up to 200 Gbit s⁻¹ for energy-efficient datacentres and harsh-environment applications," *Nat. Commun.*, vol. 11, no. 1, p. 4224, 2020.
- [189] M. Xu, Y. Zhu, et al., "Dual-polarization thin-film lithium niobate in-phase quadrature modulators for terabit-per-second transmission," *Optica*, vol. 9, no. 1, pp. 61-62, 2022.
- [190] S. Pai, S. Fan et al., "Parallel programming of an arbitrary feedforward photonic network," *IEEE J. Sel. Top. Quantum Electron.*, vol. 26, no. 5, pp. 1-13, 2020.
- [191] M. Fard, I. Williamson, S. Fan, et al., "Experimental realization of arbitrary activation functions for optical neural networks," *Opt. Express*, vol. 28, no. 8, pp. 12138-12148, 2020.
- [192] I. Williamson, T. Hughes, M. Minkov, B. Bartlett, S. Pai, and S. Fan, "Reprogrammable electro-optic nonlinear activation functions for optical neural networks," *IEEE J. Sel. Top. Quantum Electron.*, vol. 26, no. 1, pp. 1-12, 2020.
- [193] H. Wang, W. Jin, S. Fan, et al., "Design of compact meta-crystal slab for general optical convolution," *ACS Photonics*, vol. 9, no. 4, pp.1358-1365, 2022.
- [194] Z. Yang, C. Yu, M. Buehler, "Deep learning model to predict complex stress and strain fields in hierarchical composites," *Sci. Adv.*, vol. 7, no. 15, pp.1-10, 2021.
- [195] T. Hughes, I. Williamson, M. Minkov, and S. Fan, "Wave physics as an analog recurrent neural network," *Sci. Adv.*, vol. 5, no. 12, pp.1-6, 2019.
- [196] Bao, C., et al., Direct soliton generation in microresonators, *Opt. Lett.*, **42**, 2519 (2017).
- [197] M.Ferrera et al., "CMOS compatible integrated all-optical RF spectrum analyzer", *Optics Express*, vol. 22, no. **18**, 21488 - 21498 (2014).
- [198] A. Pasquazi, et al., "Sub-picosecond phase-sensitive optical pulse characterization on a chip", *Nature Photonics*, vol. 5, no. 10, pp. 618-623 (2011).
- [199] M. Kues, et al., "Passively modelocked laser with an ultra-narrow spectral width", *Nature Photonics*, vol. 11, no. 3, pp. 159, 2017.
- [200] L. Razzari, et al., "CMOS-compatible integrated optical hyper-parametric oscillator," *Nature Photonics*, vol. 4, no. 1, pp. 41-45, 2010.
- [201] M. Ferrera, et al., "Low-power continuous-wave nonlinear optics in doped silica glass integrated waveguide structures," *Nature Photonics*, vol. 2, no. 12, pp. 737-740, 2008.
- [202] M.Ferrera et al. "On-Chip ultra-fast 1st and 2nd order CMOS compatible all-optical integration", *Opt. Express*, vol. 19, (23)pp. 23153-23161 (2011).
- [203] D. Duchesne, M. Peccianti, M. R. E. Lamont, et al., "Supercontinuum generation in a high index doped silica glass spiral waveguide," *Optics Express*, vol. 18, no. 2, pp. 923-930, 2010.
- [204] H Bao, L Olivieri, M Rowley, ST Chu, BE Little, R Morandotti, DJ Moss, ... "Turing patterns in a fiber laser with a nested microresonator: Robust and controllable microcomb generation", *Physical Review Research* 2 (2), 023395 (2020).
- [205] M. Ferrera, et al., "On-chip CMOS-compatible all-optical integrator", *Nature Communications*, vol. 1, Article 29, 2010.
- [206] A. Pasquazi, et al., "All-optical wavelength conversion in an integrated ring resonator," *Optics Express*, vol. 18, no. 4, pp. 3858-3863, 2010.
- [207] A. Pasquazi, Y. Park, J. Azana, et al., "Efficient wavelength conversion and net parametric gain via Four Wave Mixing in a high index doped silica waveguide," *Optics Express*, vol. 18, no. 8, pp. 7634-7641, 2010.
- [208] M. Peccianti, M. Ferrera, L. Razzari, et al., "Subpicosecond optical pulse compression via an integrated nonlinear chirper," *Optics Express*, vol. 18, no. 8, pp. 7625-7633, 2010.
- [209] Little, B. E. et al., "Very high-order microring resonator filters for WDM applications", *IEEE Photonics Technol. Lett.* 16, 2263-2265 (2004).
- [210] M. Ferrera et al., "Low Power CW Parametric Mixing in a Low Dispersion High Index Doped Silica Glass Micro-Ring Resonator with Q-factor > 1 Million", *Optics Express*, vol.17, no. 16, pp. 14098-14103 (2009).

- [211] M. Peccianti, et al., “Demonstration of an ultrafast nonlinear microcavity modelocked laser”, *Nature Communications*, vol. 3, pp. 765, 2012.
- [212] A. Pasquazi, et al., “Self-locked optical parametric oscillation in a CMOS compatible microring resonator: a route to robust optical frequency comb generation on a chip,” *Optics Express*, vol. 21, no. 11, pp. 13333-13341, 2013.
- [213] A. Pasquazi, et al., “Stable, dual mode, high repetition rate mode-locked laser based on a microring resonator,” *Optics Express*, vol. 20, no. 24, pp. 27355-27362, 2012.
- [214] Pasquazi, A. et al. Micro-combs: a novel generation of optical sources. *Physics Reports* **729**, 1-81 (2018).
- [215] Moss, D. J. et al., “New CMOS-compatible platforms based on silicon nitride and Hydex for nonlinear optics”, *Nature photonics* 7, 597 (2013).
- [216] H. Bao, et al., Laser cavity-soliton microcombs, *Nature Photonics*, vol. 13, no. 6, pp. 384-389, Jun. 2019.
- [217] M.Rowley, P.Hanzard, A.Cutrona, H.Bao, S.Chu, B.Little, R.Morandotti, D. J. Moss, G. Oppo, J. Gongora, M. Peccianti and A. Pasquazi, “Self-emergence of robust solitons in a micro-cavity”, *Nature* **608** (7922) 303–309 (2022).
- [218] Xu, X., et al., Photonic microwave true time delays for phased array antennas using a 49 GHz FSR integrated micro-comb source, *Photonics Research*, vol. 6, B30-B36 (2018).
- [219] M. Tan et al, “Orthogonally polarized Photonic Radio Frequency single sideband generation with integrated micro-ring resonators”, *IOP Journal of Semiconductors*, Vol. 42 (4), 041305 (2021).
- [220] X. Xu, et al., Broadband microwave frequency conversion based on an integrated optical micro-comb source”, *Journal of Lightwave Technology*, vol. 38 no. 2, pp. 332-338, 2020.
- [221] M. Tan, et al., “Photonic RF and microwave filters based on 49GHz and 200GHz Kerr microcombs”, *Optics Comm.* vol. 465,125563, Feb. 22. 2020.
- [222] X. Xu, et al., “Broadband photonic RF channelizer with 90 channels based on a soliton crystal microcomb”, *Journal of Lightwave Technology*, Vol. 38, no. 18, pp. 5116 - 5121, 2020.
- [223] X. Xu, et al., “Photonic RF and microwave integrator with soliton crystal microcombs”, *IEEE Transactions on Circuits and Systems II: Express Briefs*, vol. 67, no. 12, pp. 3582-3586, 2020.
- [224] X. Xu, et al., “High performance RF filters via bandwidth scaling with Kerr micro-combs,” *APL Photonics*, vol. 4 (2) 026102. 2019.
- [225] M. Tan, et al., “Microwave and RF photonic fractional Hilbert transformer based on a 50 GHz Kerr micro-comb”, *Journal of Lightwave Technology*, vol. 37, no. 24, pp. 6097 – 6104, 2019.
- [226] M. Tan, et al., “RF and microwave fractional differentiator based on photonics”, *IEEE Transactions on Circuits and Systems: Express Briefs*, vol. 67, no.11, pp. 2767-2771, 2020.
- [227] M. Tan, et al., “Photonic RF arbitrary waveform generator based on a soliton crystal micro-comb source”, *Journal of Lightwave Technology*, vol. 38, no. 22, pp. 6221-6226 (2020).
- [228] M. Tan, X. Xu, J. Wu, R. Morandotti, A. Mitchell, and D. J. Moss, “RF and microwave high bandwidth signal processing based on Kerr Micro-combs”, *Advances in Physics X*, VOL. 6, NO. 1, 1838946 (2021).
- [229] M. Tan, X. Xu, J. Wu, B. Corcoran, A. Boes, T. G. Nguyen, S. T. Chu, B. E. Little, R.Morandotti, A. Lowery, A. Mitchell, and D. J. Moss, “Highly Versatile Broadband RF Photonic Fractional Hilbert Transformer Based on a Kerr Soliton Crystal Microcomb”, *Journal of Lightwave Technology* vol. 39 (24) 7581-7587 (2021).
- [230] Wu, J. et al. RF Photonics: An Optical Microcombs’ Perspective. *IEEE Journal of Selected Topics in Quantum Electronics* Vol. 24, 6101020, 1-20 (2018).
- [231] T. G. Nguyen et al., “Integrated frequency comb source-based Hilbert transformer for wideband microwave photonic phase analysis,” *Opt. Express*, vol. 23, no. 17, pp. 22087-22097, Aug. 2015.
- [232] X. Xu, J. Wu, M. Shoeiby, T. G. Nguyen, S. T. Chu, B. E. Little, R. Morandotti, A. Mitchell, and D. J. Moss, “Reconfigurable broadband microwave photonic intensity differentiator based on an integrated optical frequency comb source,” *APL Photonics*, vol. 2, no. 9, 096104, Sep. 2017.
- [233] X. Xu, et al., “Broadband RF channelizer based on an integrated optical frequency Kerr comb source,” *Journal of Lightwave Technology*, vol. 36, no. 19, pp. 4519-4526, 2018.
- [234] X. Xu, et al., “Continuously tunable orthogonally polarized RF optical single sideband generator based on micro-ring resonators,” *Journal of Optics*, vol. 20, no. 11, 115701. 2018.
- [235] X. Xu, et al., “Orthogonally polarized RF optical single sideband generation and dual-channel equalization based on an integrated microring resonator,” *Journal of Lightwave Technology*, vol. 36, no. 20, pp. 4808-4818. 2018.
- [236] M.Tan, X. Xu, J. Wu, B. Corcoran, A. Boes, T. G. Nguyen, Sai T. Chu, B. E. Little, R.Morandotti, A. Mitchell, and D. J. Moss, “Integral order photonic RF signal processors based on a soliton crystal micro-comb source”, *IOP Journal of Optics* vol. 23 (11) 125701 (2021).
- [237] X. Xu, et al., “Photonic RF phase-encoded signal generation with a microcomb source”, *J. Lightwave Technology*, vol. 38, no. 7, 1722-1727, 2020.
- [238] B. Corcoran, et al., “Ultra-dense optical data transmission over standard fiber with a single chip source”, *Nature Communications*, vol. 11, Article:2568, 2020.
- [239] Maxwell Rowley, Pierre-Henry Hanzard, Antonio Cutrona, Hualong Bao, Sai T. Chu, Brent E. Little, Roberto Morandotti, David J. Moss, Gian-Luca Oppo, Juan Sebastian Totero Gongora, Marco Peccianti and Alessia Pasquazi, “Self-Emergence of Robust Micro Cavity-Solitons”, *Research Square* (2022). DOI: <https://doi.org/10.21203/rs.3.rs-468461/v1>
- [240] Kues, M. et al. Quantum optical microcombs. *Nature Photonics* **13**, (3) 170-179 (2019). doi:10.1038/s41566-019-0363-0

- [241] C. Reimer, L. Caspani, M. Clerici, et al., “Integrated frequency comb source of heralded single photons,” *Optics Express*, vol. 22, no. 6, pp. 6535-6546, 2014.
- [242] C. Reimer, et al., “Cross-polarized photon-pair generation and bi-chromatically pumped optical parametric oscillation on a chip”, *Nature Communications*, vol. 6, Article 8236, 2015. DOI: 10.1038/ncomms9236.
- [243] L. Caspani, C. Reimer, M. Kues, et al., “Multifrequency sources of quantum correlated photon pairs on-chip: a path toward integrated Quantum Frequency Combs,” *Nanophotonics*, vol. 5, no. 2, pp. 351-362, 2016.
- [244] C. Reimer et al., “Generation of multiphoton entangled quantum states by means of integrated frequency combs,” *Science*, vol. 351, no. 6278, pp. 1176-1180, 2016.
- [245] M. Kues, et al., “On-chip generation of high-dimensional entangled quantum states and their coherent control”, *Nature*, vol. 546, no. 7660, pp. 622-626, 2017.
- [246] P. Roztocki et al., “Practical system for the generation of pulsed quantum frequency combs,” *Optics Express*, vol. 25, no. 16, pp. 18940-18949, 2017.
- [247] Y. Zhang, et al., “Induced photon correlations through superposition of two four-wave mixing processes in integrated cavities”, *Laser and Photonics Reviews*, vol. 14, no. 7, pp. 2000128, 2020. DOI: 10.1002/lpor.202000128
- [248] C. Reimer, et al., “High-dimensional one-way quantum processing implemented on d-level cluster states”, *Nature Physics*, vol. 15, no.2, pp. 148–153, 2019.
- [249] P. Roztocki et al., “Complex quantum state generation and coherent control based on integrated frequency combs”, *Journal of Lightwave Technology* **37** (2) 338-347 (2019).
- [250] S. Sciara et al., “Generation and Processing of Complex Photon States with Quantum Frequency Combs”, *IEEE Photonics Technology Letters* **31** (23) 1862-1865 (2019). DOI: 10.1109/LPT.2019.2944564.
- [251] L. Caspani, C. Reimer, M. Kues, et al., “Multifrequency sources of quantum correlated photon pairs on-chip: a path toward integrated Quantum Frequency Combs,” *Nanophotonics*, vol. 5, no. 2, pp. 351-362, 2016.