

Glass surfaces: Freezing of capillary waves?

Tilo Seydel

Contents:

- **(I) Introduction**
- **(II) Liquid and glass surfaces**
- **(III) X-ray scattering:**
 - Theory & Experiment**
- **(IV) Experiments & Data analysis**
 - (a) Reflectivity and diffuse scattering**
 - (b) X-ray photon correlation spectroscopy**
- **(V) Summary + Acknowledgement**

DFG project Pr 325/9-1,2,3

Year 2000

Introduction

liquid \longrightarrow glass
ergodic \longrightarrow non-ergodic

while keeping the time-averaged structure

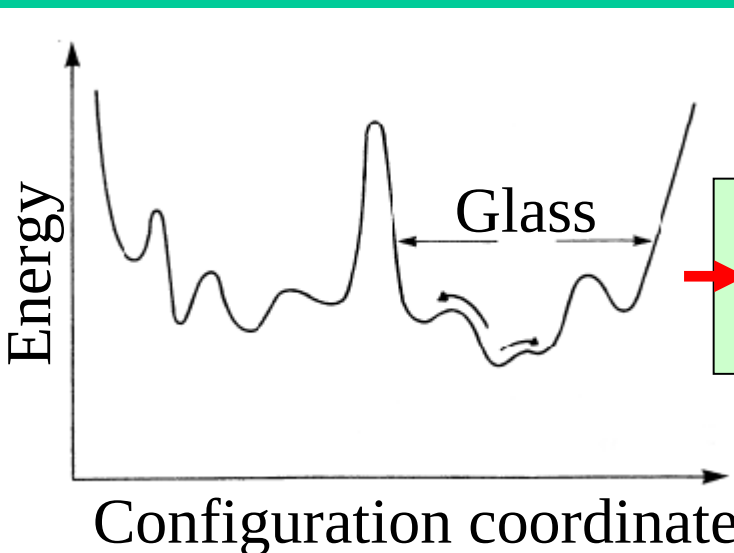
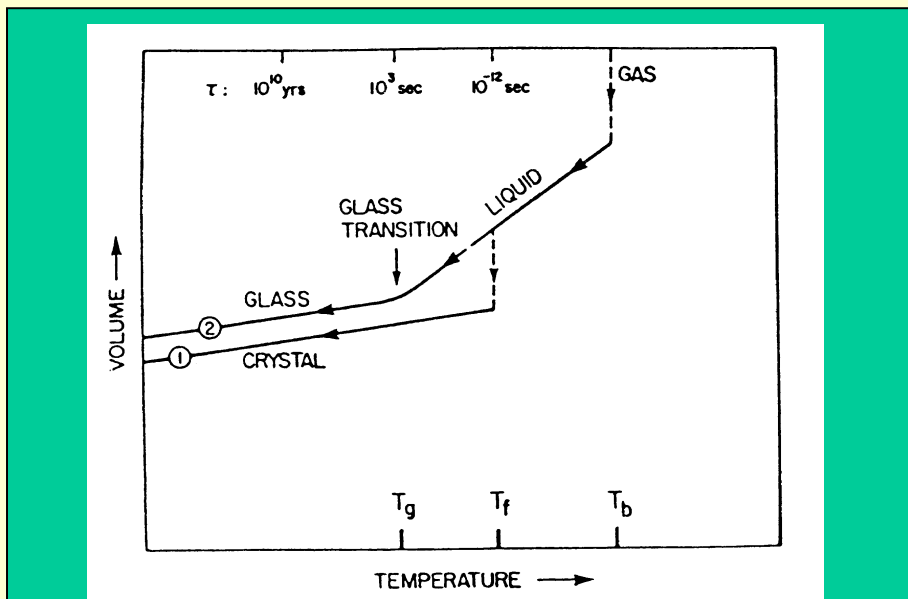

Dependence
on the
thermal history !

from:
U.Buchenau
Ferienschule
(summer school)
Jülich 2000

Waves on liquid surfaces

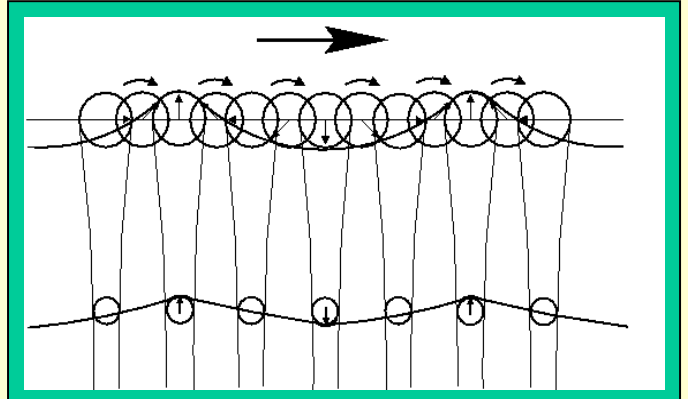

Capillary waves: thermal excitation
Surface tension → **restoring force**

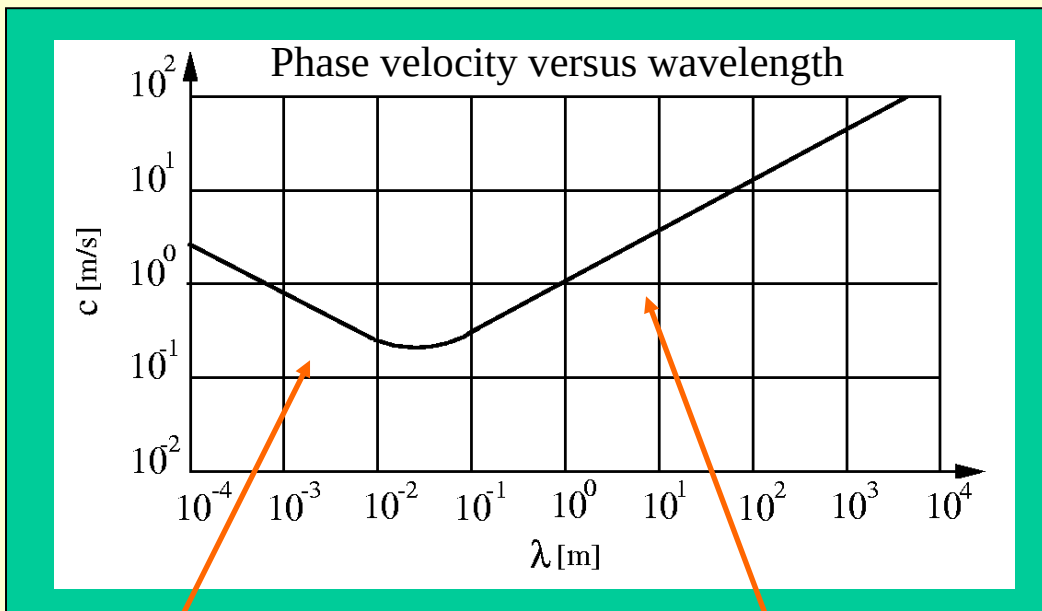

$$c_{\text{kap}} = \sqrt{\frac{2\pi\gamma}{\rho\lambda}}$$

$$c_{\text{grav}} = \sqrt{\frac{g\lambda}{2\pi}}$$

capillary
waves

$$l_c := \lambda_{\text{max}} = 2\pi \sqrt{\frac{\gamma}{\rho g}}$$

gravity
waves

Capillary waves

- Surface roughness (a few Å)
Experimental method: X-ray reflectivity
- Quasi-long range correlations
Experimental method: Diffuse X-ray scattering

Static surface structure factor:

$$S(q_{||}) = \frac{k_B T}{\rho g + \gamma q_{||}^2}$$

**Prediction for the glass surface:
no change of the
static structure factor !**

**J.Jäckle, K.Kawasaki;
J.Phys.: Cond. Matter 7, 4351 (1995)**

Glycerol - a model glass former

- Bulk behavior comprehensively studied
- Easy handling
- Low cooling rate

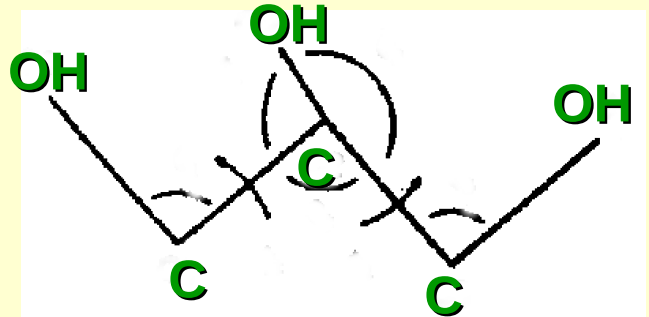

Calorimetric glass transition:

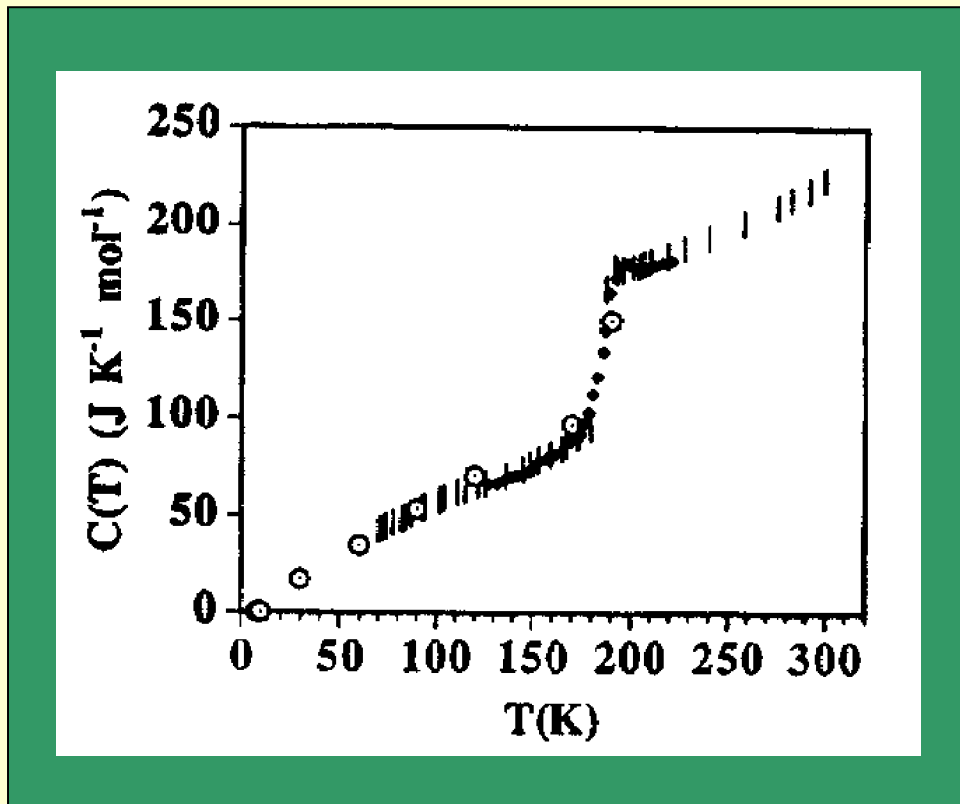

from: F.J.Bermejo et al.; PRB 53(9), 5259 (1996)

X-ray reflectivity

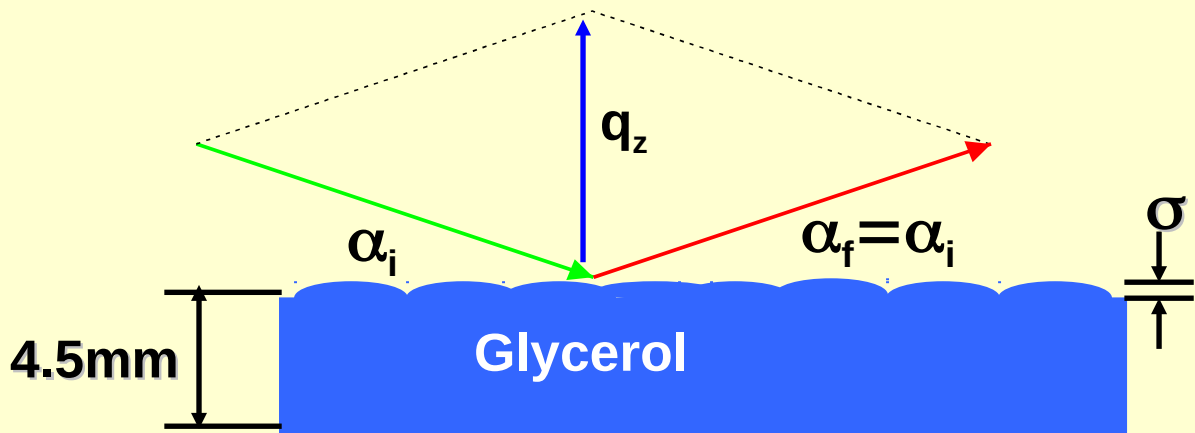

Refractive index: $n = 1 - \delta + i \beta$

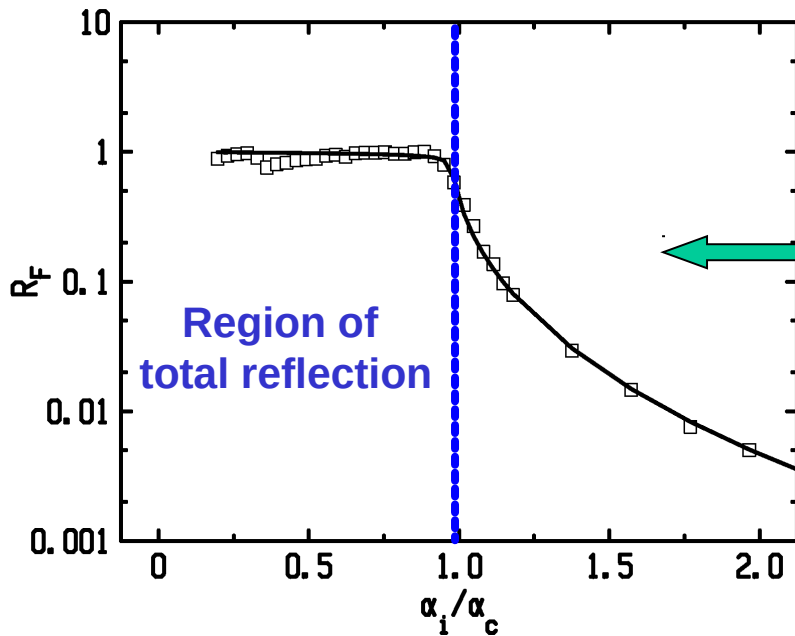

Single interface:

Fresnel - reflectivity

$\alpha_i \gg \alpha_c$
 $\approx 0.17^\circ$ (at 8keV)

$$R_F \sim \left(\frac{\alpha_c}{2\alpha_i} \right)^4$$

$$R(q_z) = R_F(q_z) \exp(-\sigma^2 q_z^2)$$

Surface roughness

Sample cell

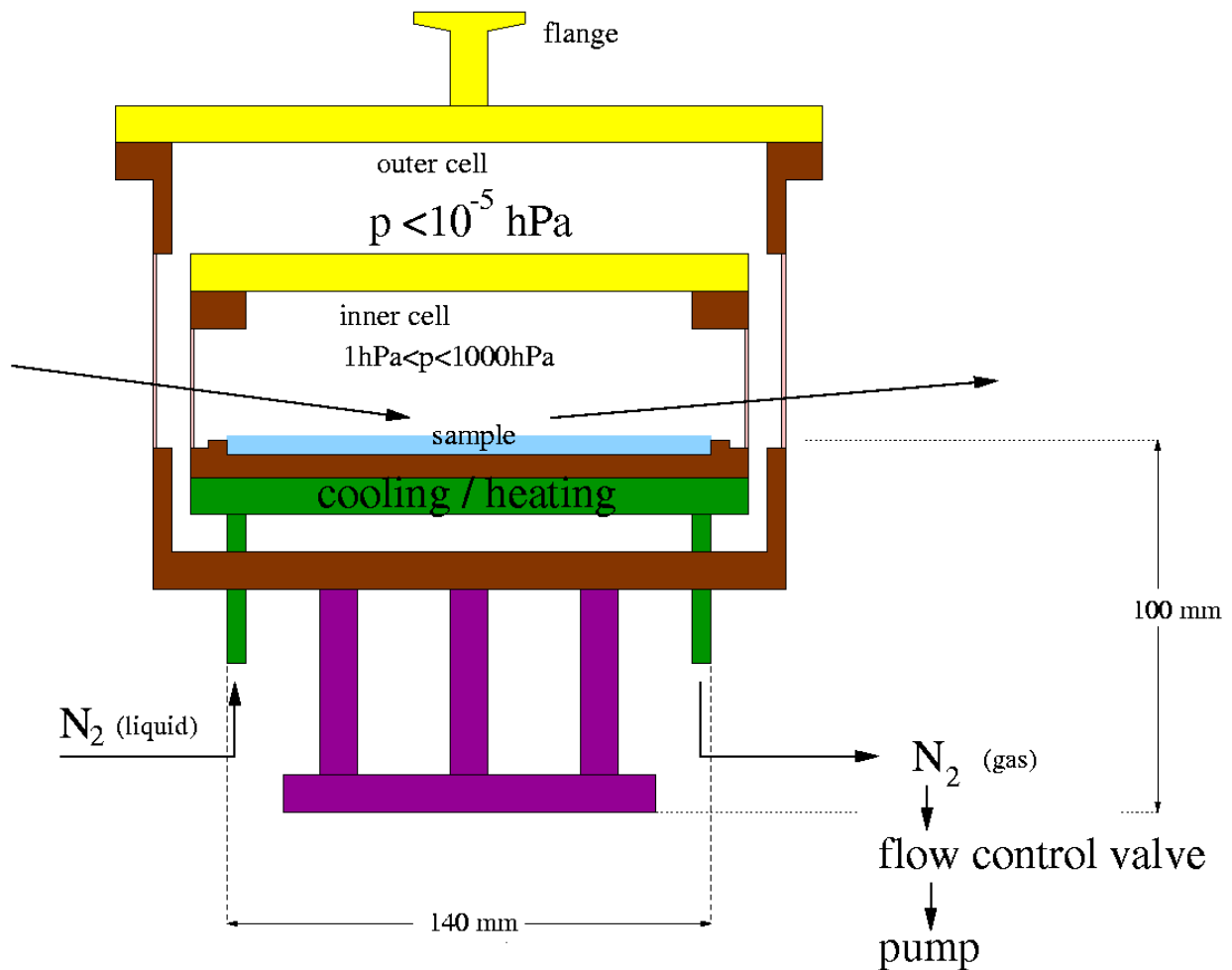

Large trough diameter (140mm) to accommodate large beam footprint at grazing angles; possibility to cool well below 200K

T.Seydel et al.; Rev.Sci.Instrum., in preparation

Boundary condition: horizontal sample surface
→ Liquid surface reflectometer

Laboratory liquid surface reflectometer required due to limited availability of reflectometers at synchrotrons

The laboratory X-ray reflectometer

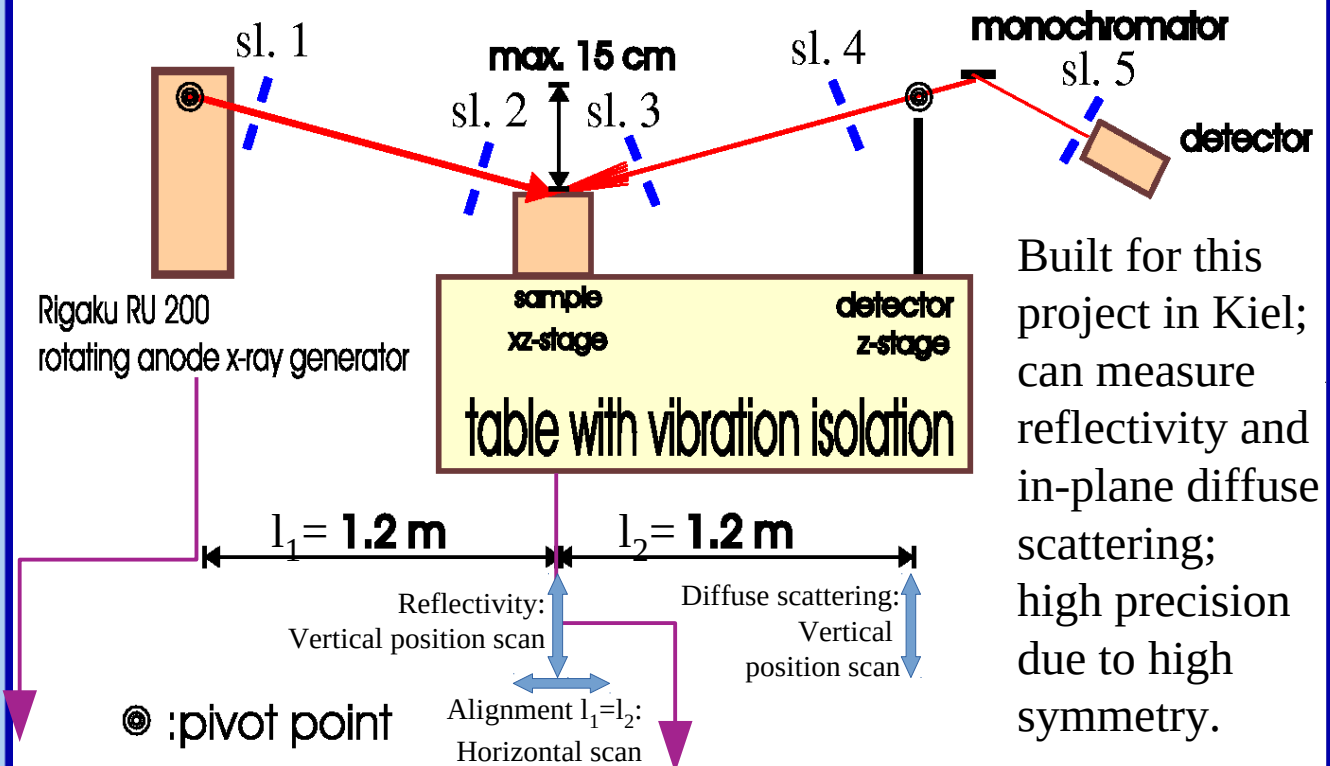

Built for this project in Kiel;
can measure reflectivity and in-plane diffuse scattering;
high precision due to high symmetry.

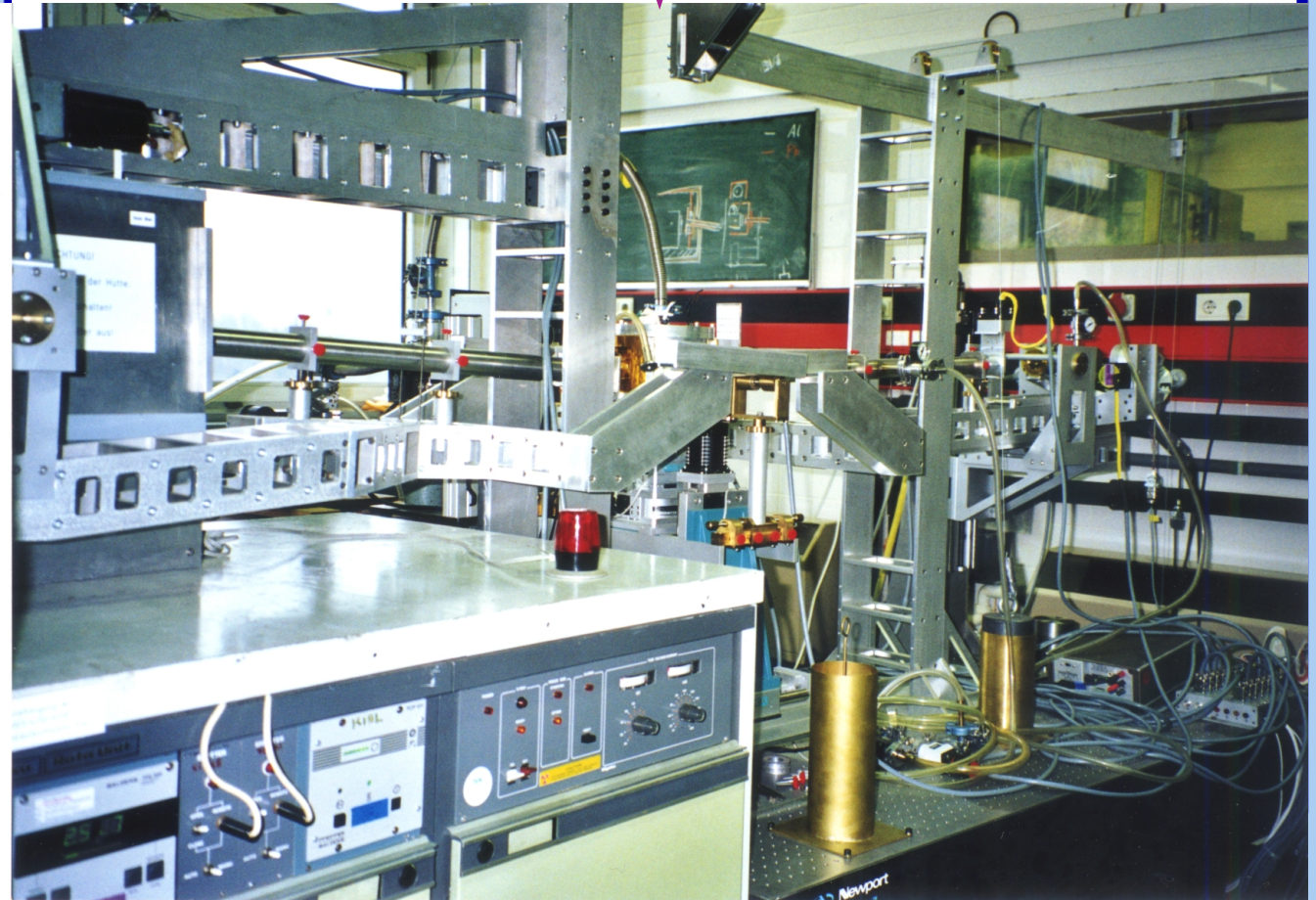

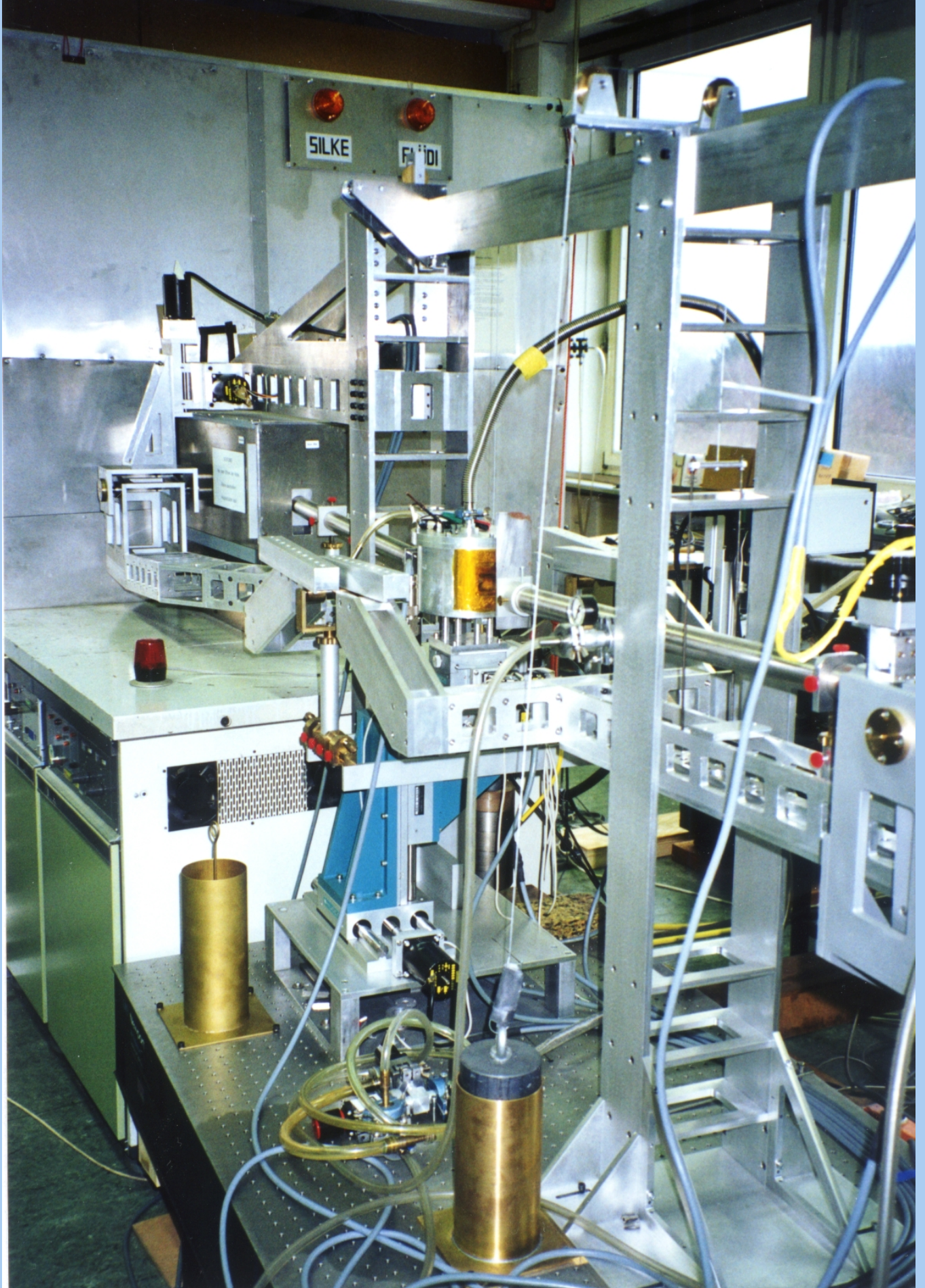

Performance of the laboratory X-ray reflectometer

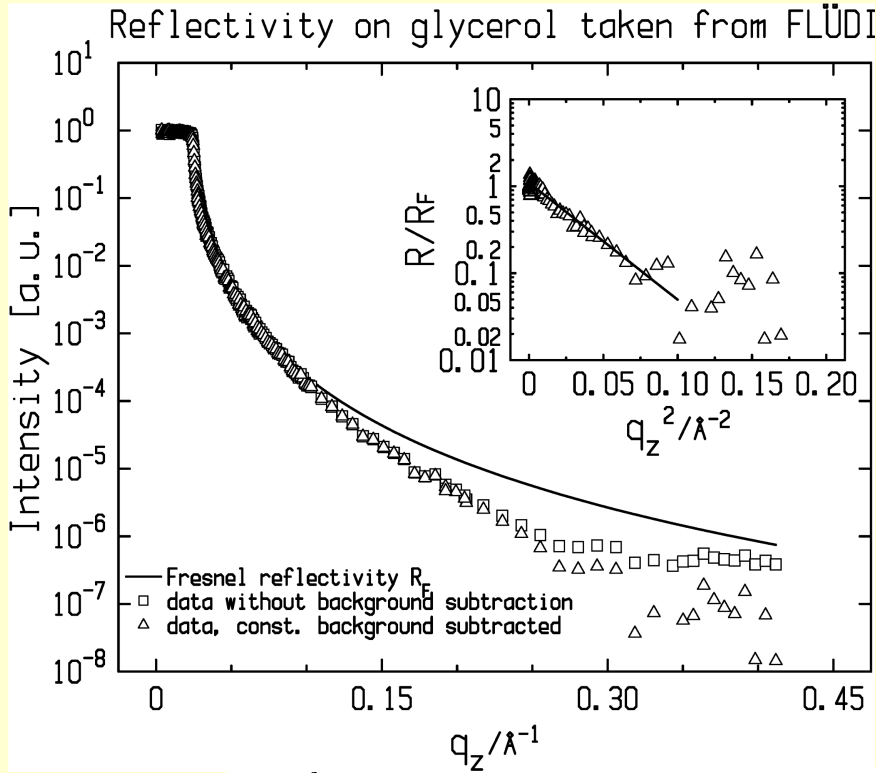

Reflectivity of a glycerol surface at ambient temperature measured using the laboratory reflectometer (denoted "FlüDi") presented on the previous slides. Up to 7 orders of magnitude below the primary beam intensity can be measured. The inset displays the reflectivity normalized to the Fresnel reflectivity subsequent to background subtraction.

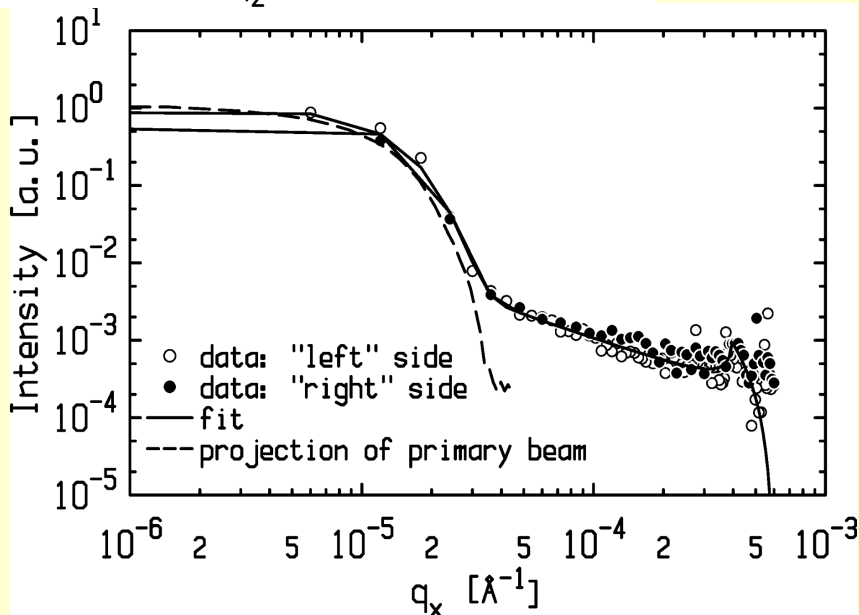

Scan of the lateral momentum transfer q_x at constant vertical transfer $q_z=0.07\text{\AA}^{-1}$ measured on a glycerol surface at ambient temperature using the laboratory reflectometer. The angular resolution of $\Delta\beta\approx 0.02^\circ$ is better than on X22B (cf. next slide). The primary beam is projected as $q_x=0.5\beta$.

Harvard/BNL-liquid surface diffractometer X22B at the NSLS/BNL

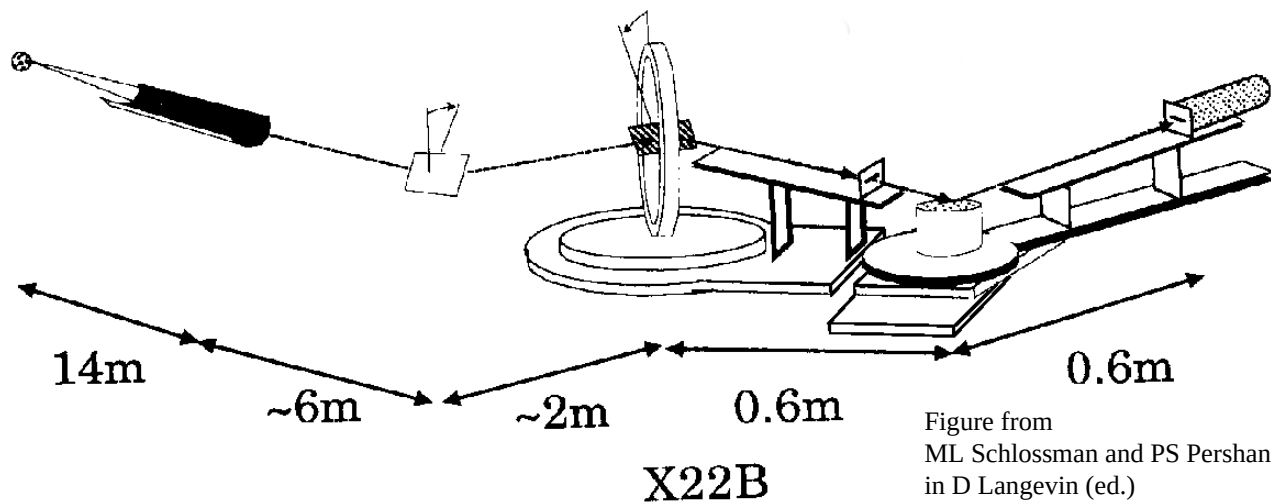
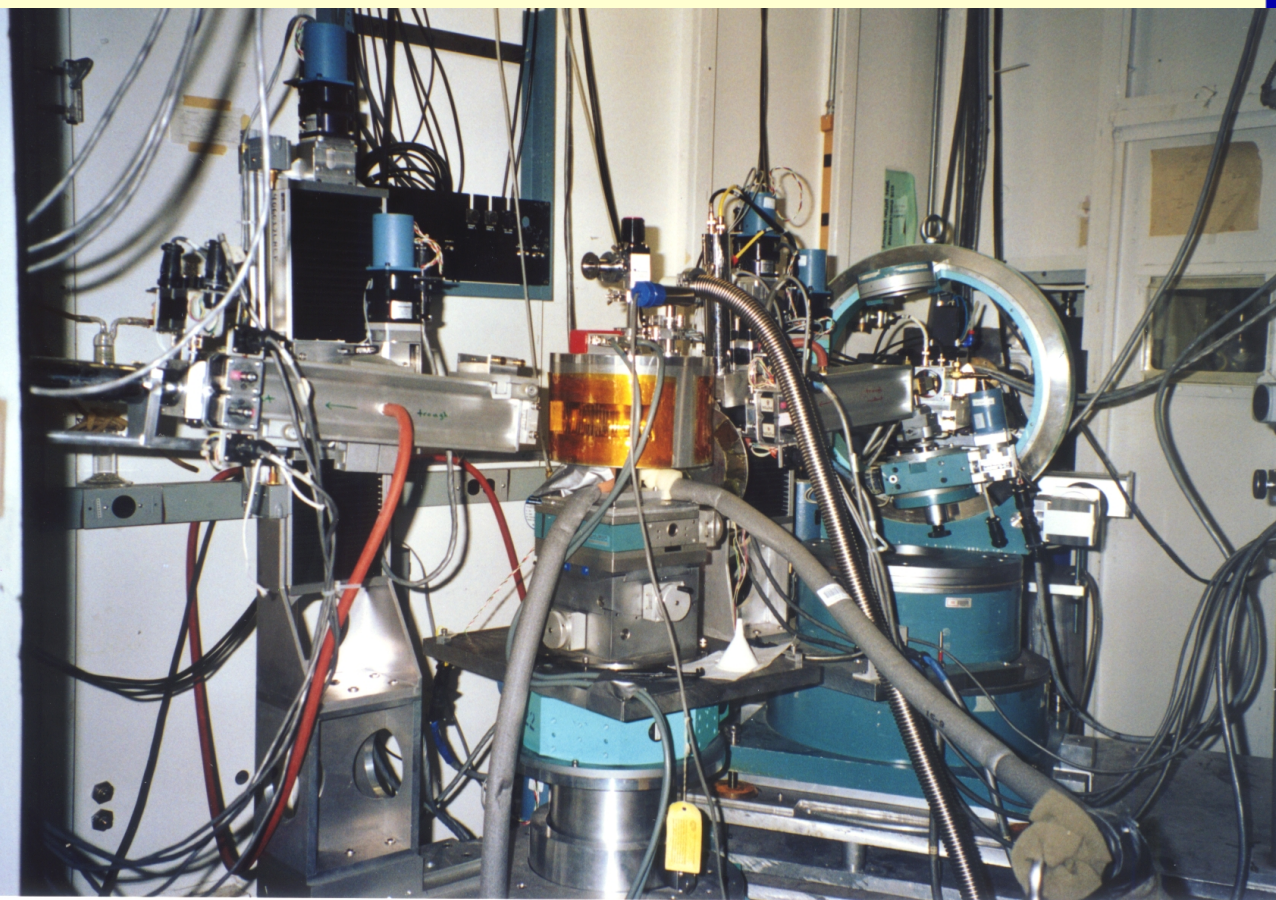

Figure from
ML Schlossman and PS Pershan;
in D Langevin (ed.)
Surfactant Science Series 1990

Below: sample cell (center) mounted on X22B

Mirror image of above schematic: Beam impinging from the right through the Eulerian cradle holding the monochromator/deflector crystal



Glass surfaces: Freezing of capillary waves?

Tilo Seydel

Contents:

- **(I) Introduction**
- **(II) Liquid and glass surfaces**
- **(III) X-ray scattering:
Theory & Experiment**
- **(IV) Experiments & Data analysis**
 - (a) Reflectivity and
diffuse scattering**
 - (b) X-ray photon
correlation spectroscopy**
- **(V) Summary + Acknowledgement**

DFG project Pr 325/9-1,2,3

Reflectivity measurements (X22B)

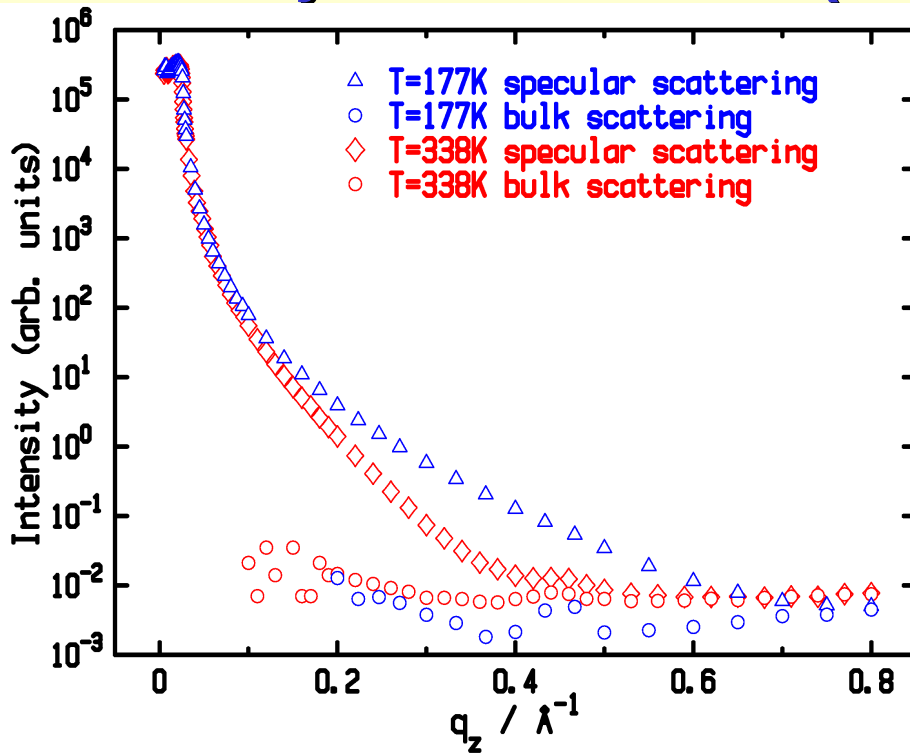

$$R = R_F \exp(-\sigma_{\text{eff}}^2 q_z^2)$$

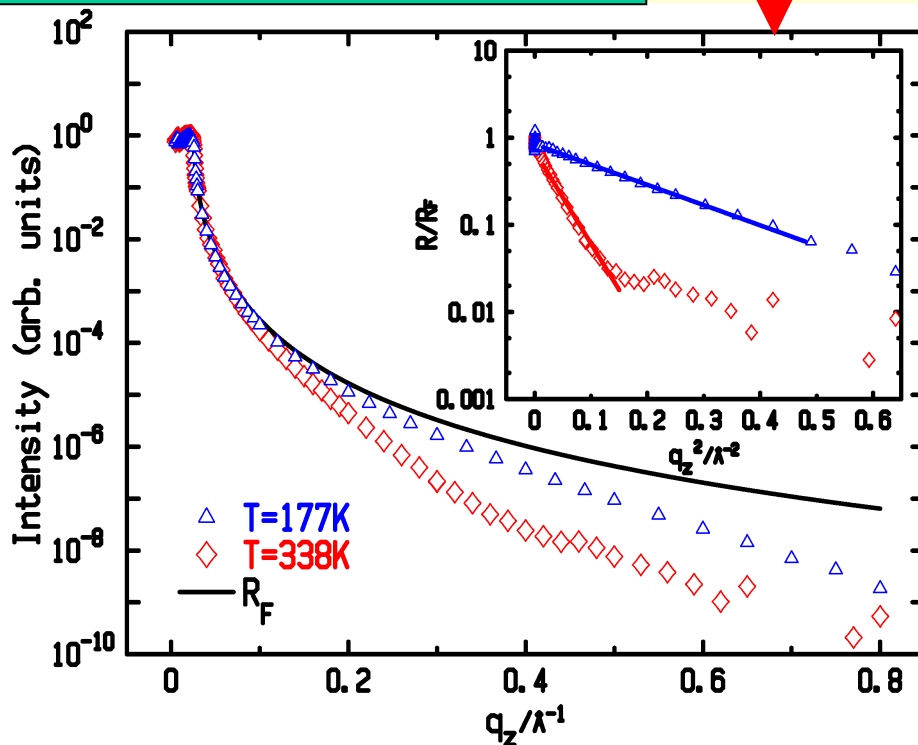

T. Seydel,
M. Tolan,
B.M. Ocko,
O.H. Seeck
R. Weber,
E. DiMasi,
W. Press;
Phys.Rev.B,
in
preparation

„Freezing“ of the roughness

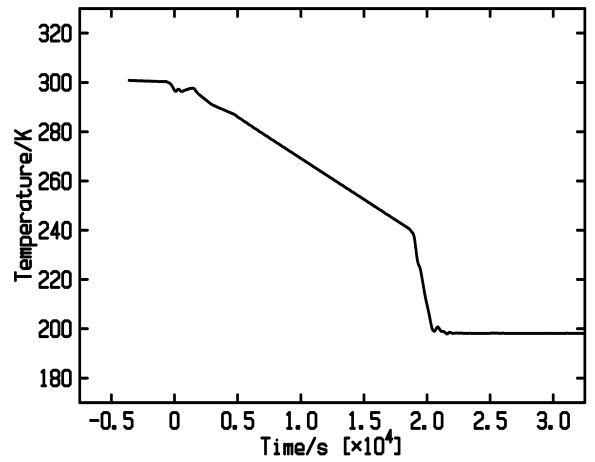
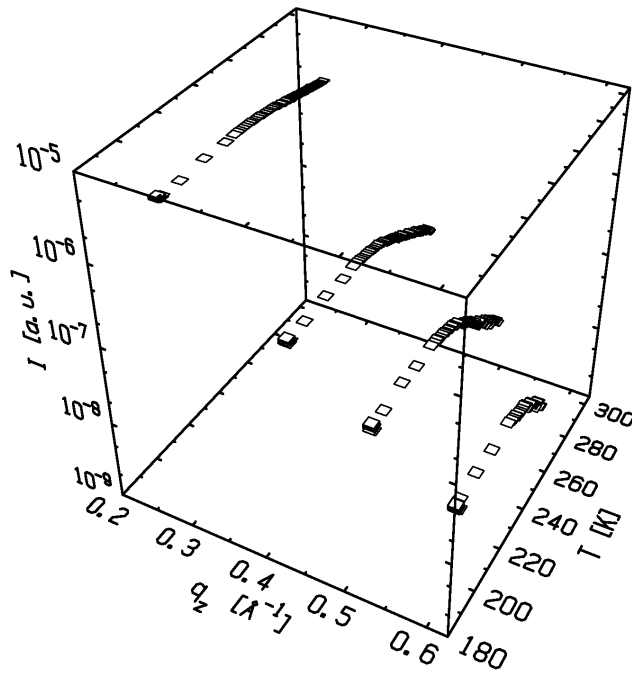

$$\sigma_{\text{eff}}^2 = -\ln(R(q_z)/R_F(q_z))/q_z^2$$

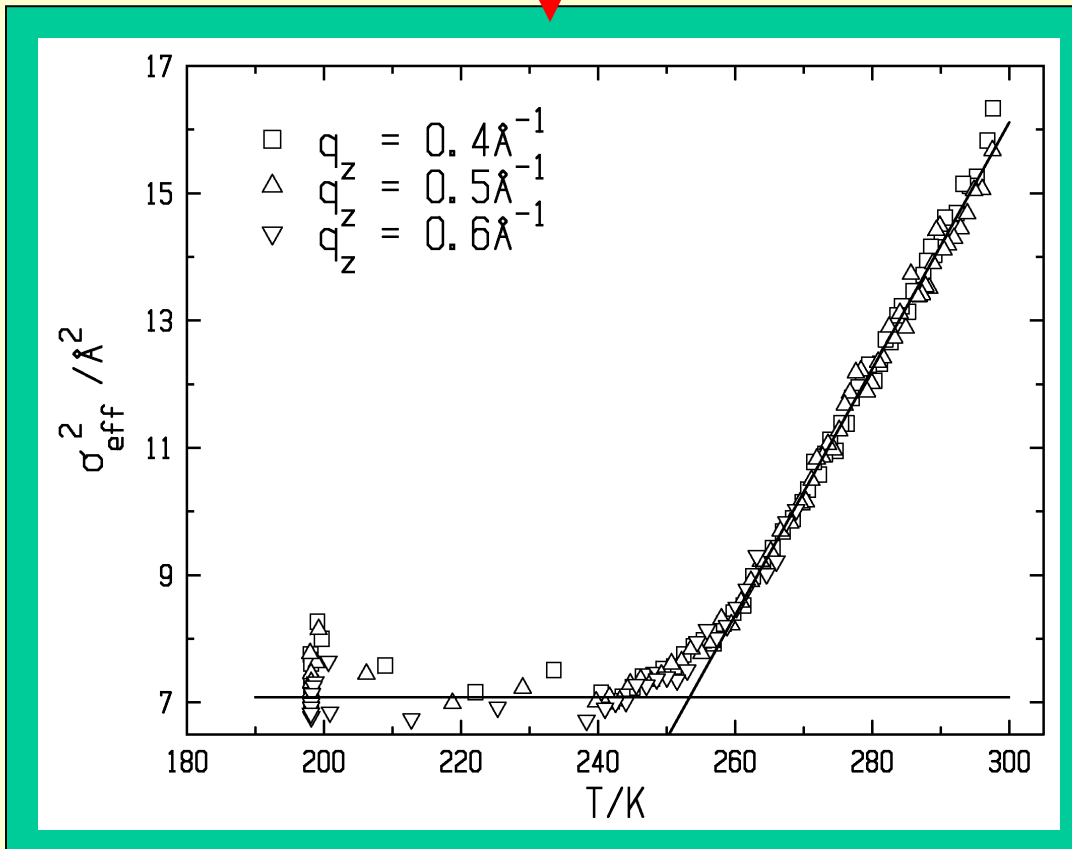

„Freezing“ of the roughness

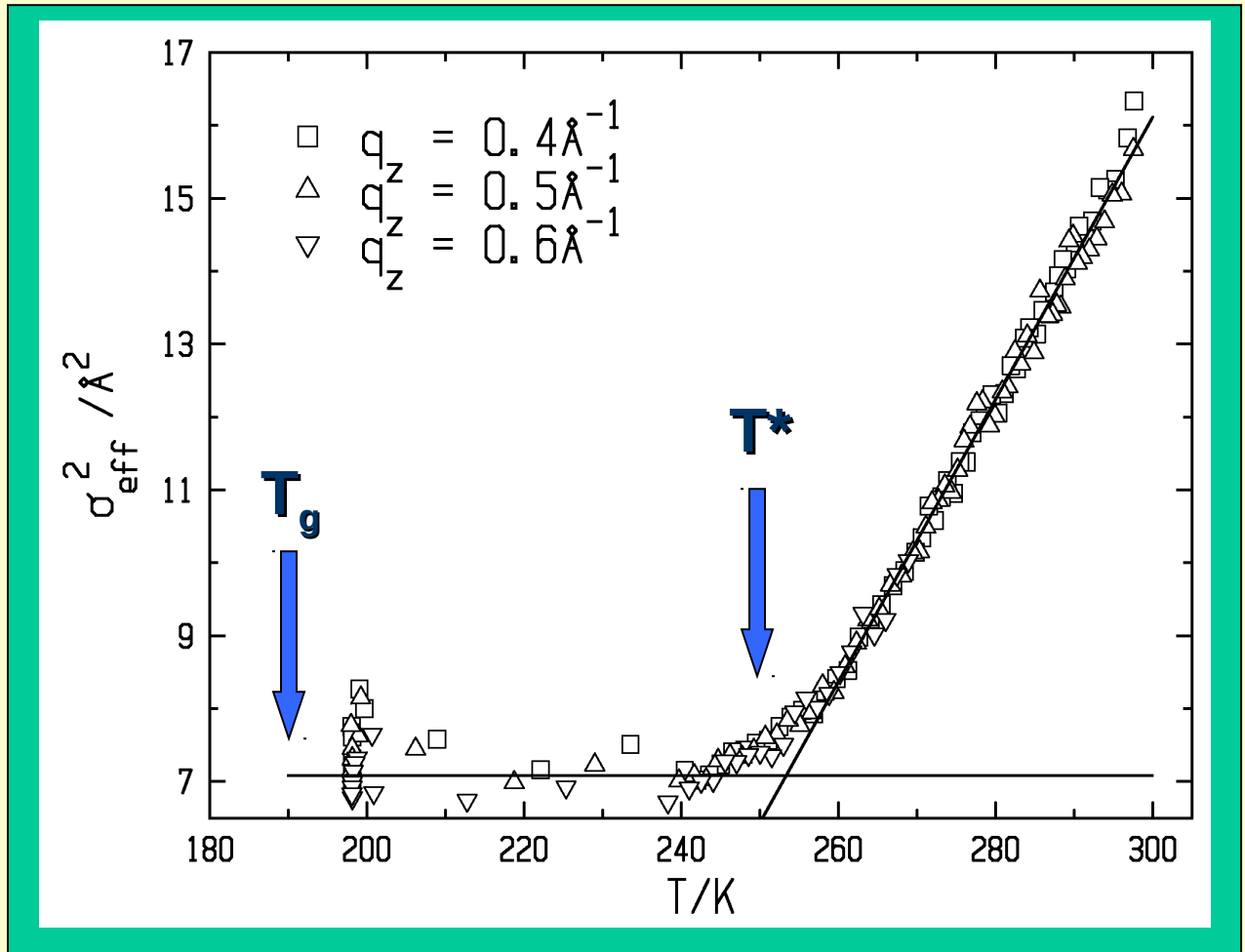

Capillary wave model:

$$\sigma_{\text{eff}}^2 = \sigma_0^2 + \frac{k_B T}{2\pi\gamma(T)} \ln\left(\frac{2q_{\text{max}}}{q_z \Delta\beta}\right)$$

for $T > T^*$

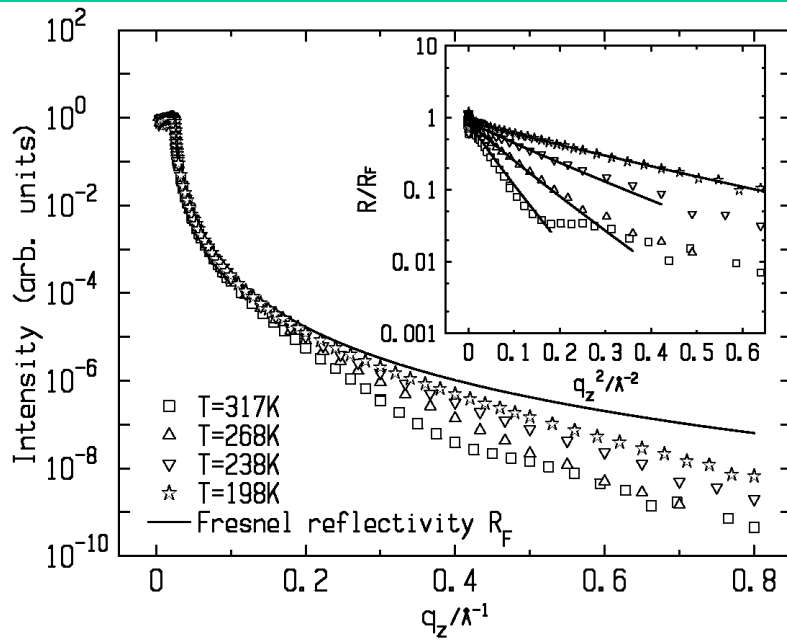

$$\sigma_{\text{eff}}^2 = \sigma_0^2 + \frac{k_B T}{2\pi\gamma(T)} \ln \left(\frac{2q_{\text{max}}}{q_z \Delta\beta} \right)$$

→ **Surface tension for low temperatures:**

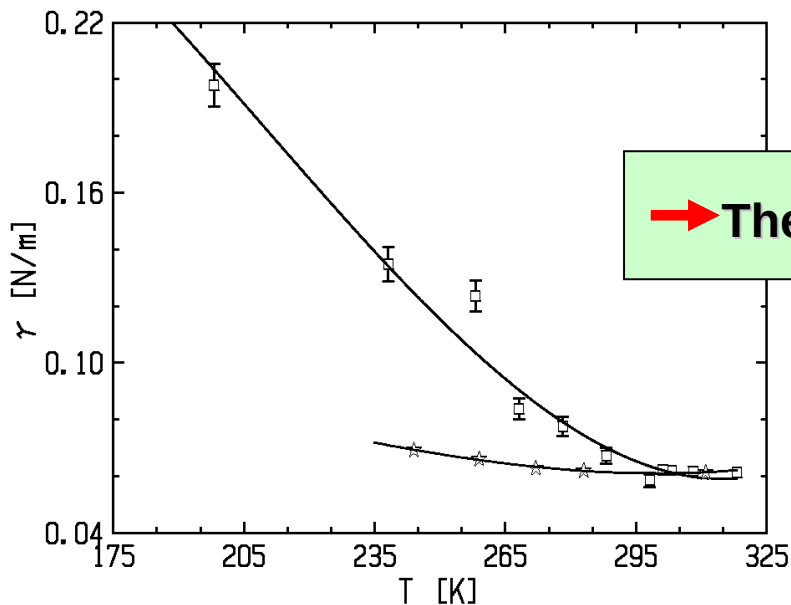

→ **Thermal history !**

Diffuse scattering:

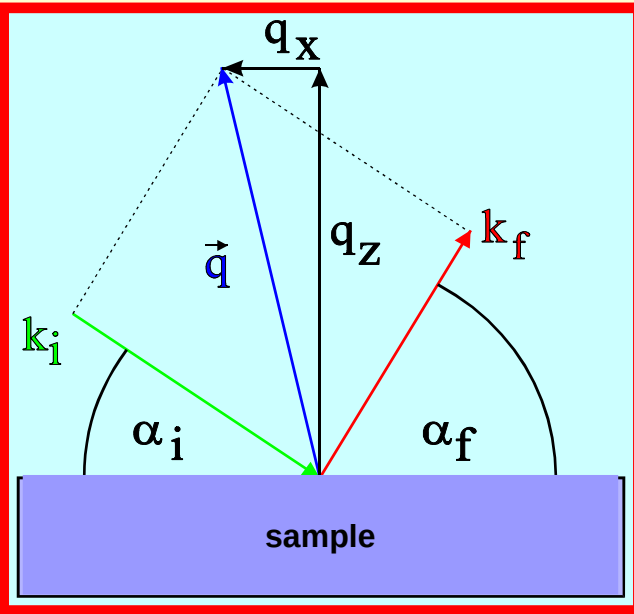

$$\alpha_i \neq \alpha_f$$

Wave vector: $q = k_f - k_i$
 "In-plane" scattering:
 $(q_x, 0, q_z)$

Capillary waves
 Power laws!

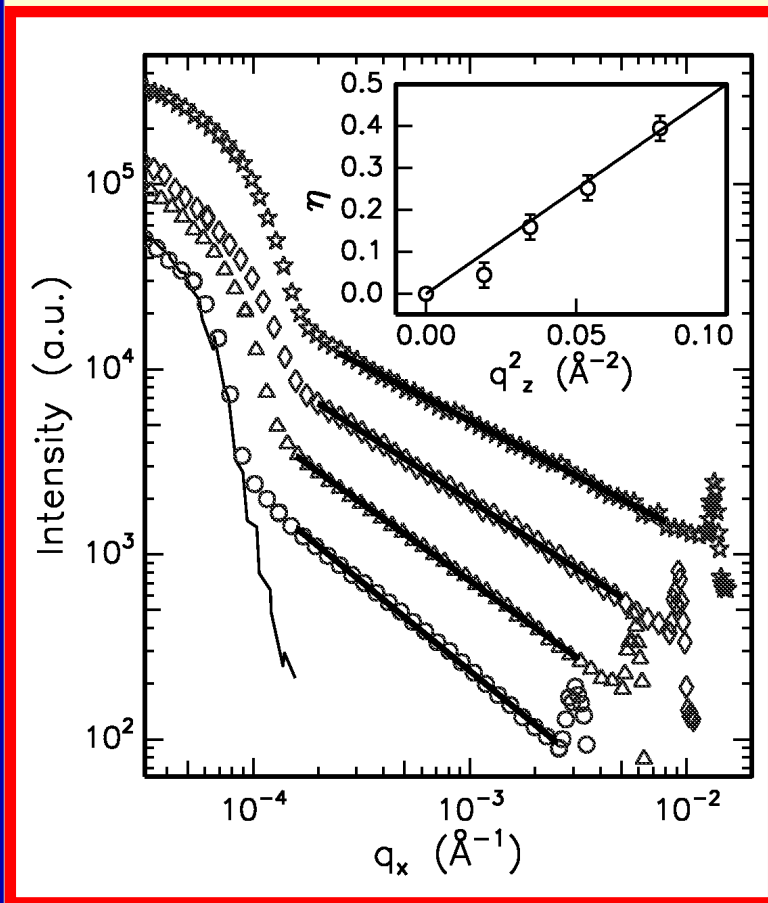

Example
 Cyclo-hexane:

film thickness
 $d = 225 \text{ \AA}$

$$q_z = 0.14 \dots 0.28 \text{ \AA}^{-1}$$

Diffuse scattering: Glycerol surface

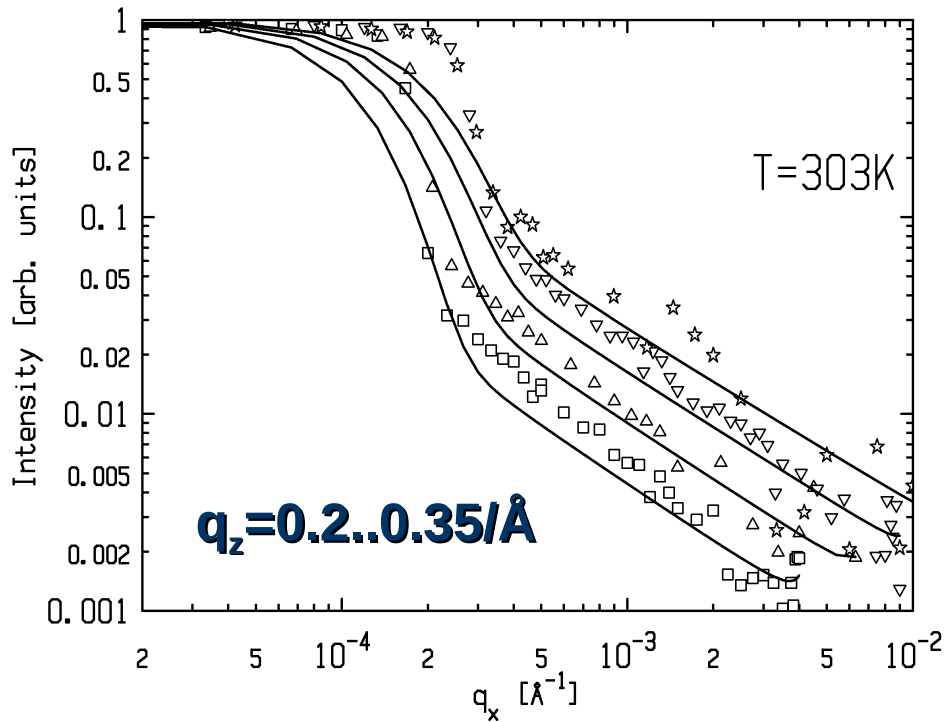

Scattering
from
capillary
waves (?)

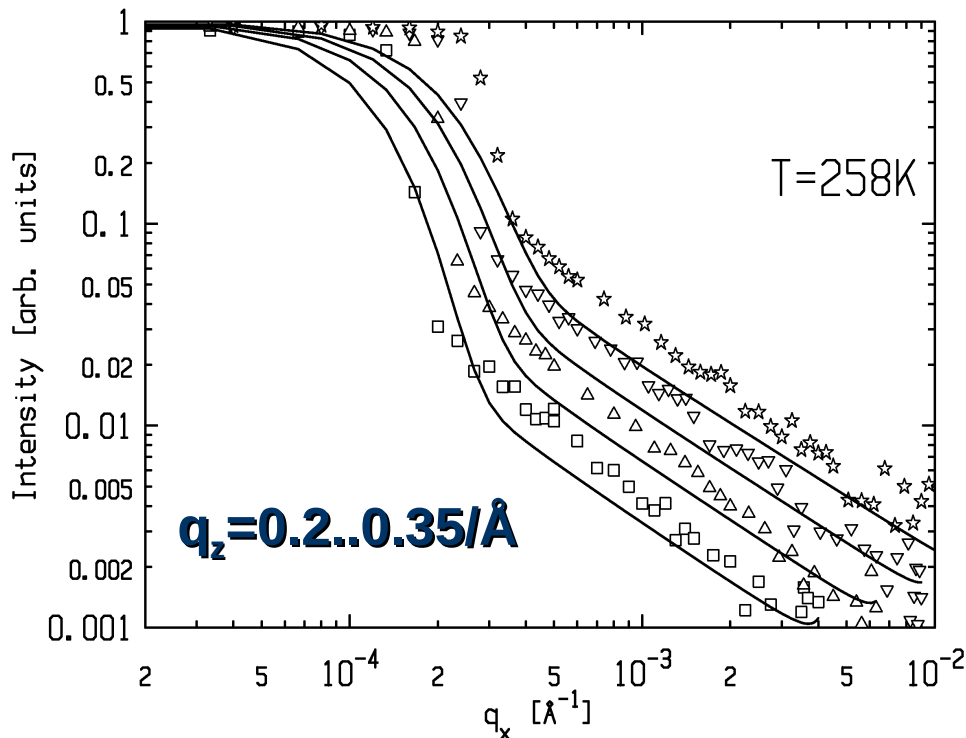

Diffuse
intensity
>
prediction

X-ray photon correlation spectroscopy (XPCS)

ESRF (Grenoble)

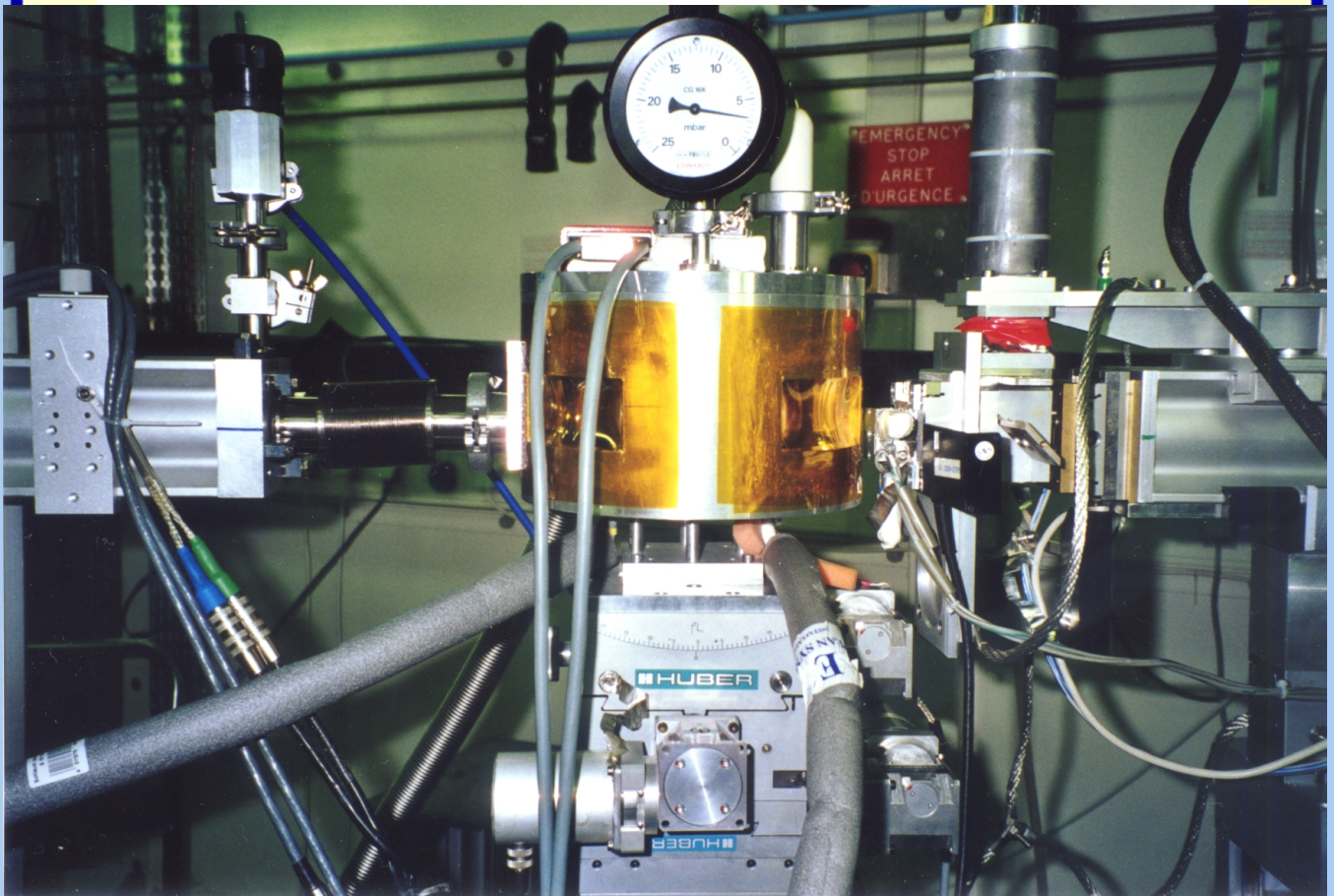
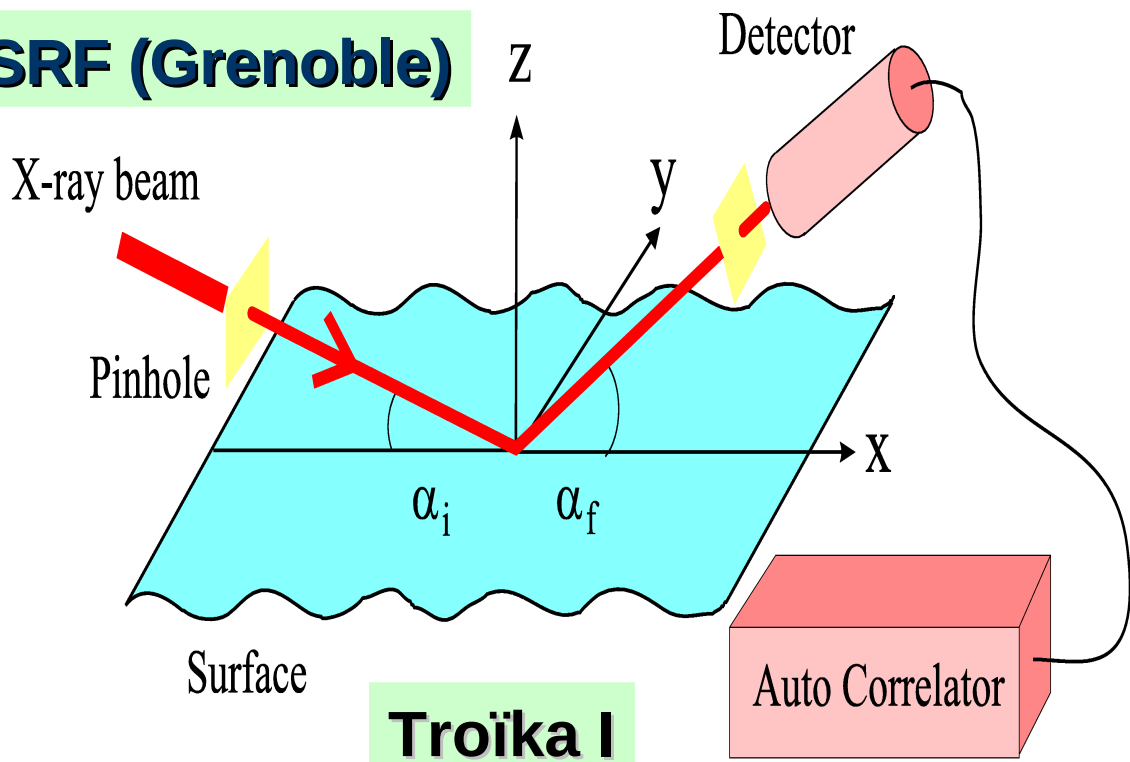

Auto-correlation function (ACF) of the intensity

$$g_2(\tau) = \frac{\langle I(t + \tau) I(t) \rangle_t}{\langle I(t) \rangle_t^2}$$

Overdamped capillary waves:

Dynamic surface structure factor

$$S(q_{\parallel}, \omega) = \frac{2k_B T}{\gamma q_{\parallel}^2} \frac{\Delta\omega}{\omega^2 + (\Delta\omega)^2}$$

J.Jäckle, K.Kawasaki;

J.Phys.: Cond. Matter 7:4351 (1995)

Fourier transformation



Expected form of the ACF:

$$g_2(\tau) = g_0 \exp\left(-\frac{\tau}{\tau_0}\right) + 1$$

with

$$\tau_0 = \frac{1}{\Delta\omega}$$

$$\Delta\omega = \frac{\gamma q_{\parallel}}{2\eta}$$

XPCS measurements

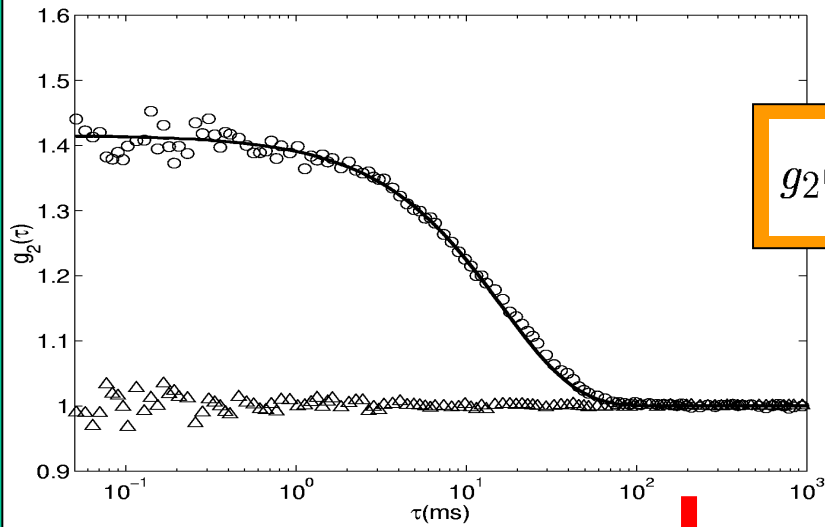

$$g_2(\tau) = g_0 \exp\left(-\frac{\tau}{\tau_0}\right) + 1$$

$$q_{||} = \frac{2\pi}{x_0}$$

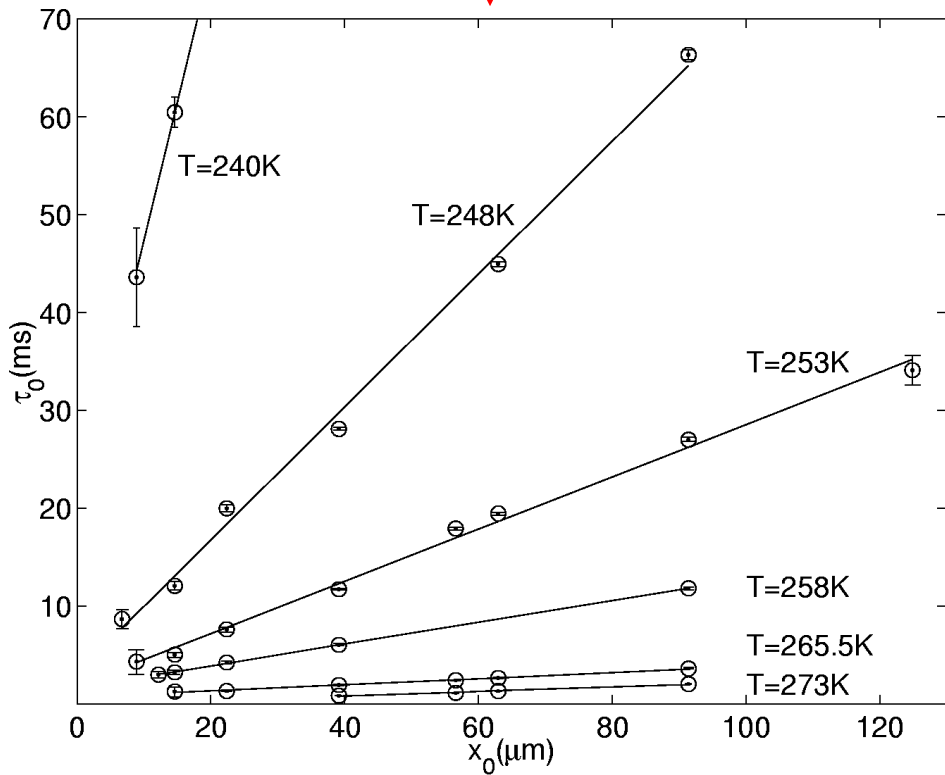

XPCS measurements

Viscosity at the surface

Theory:

$$\tau_0 = \frac{1}{\pi} \frac{\eta(T)}{\gamma(T)} x_0$$

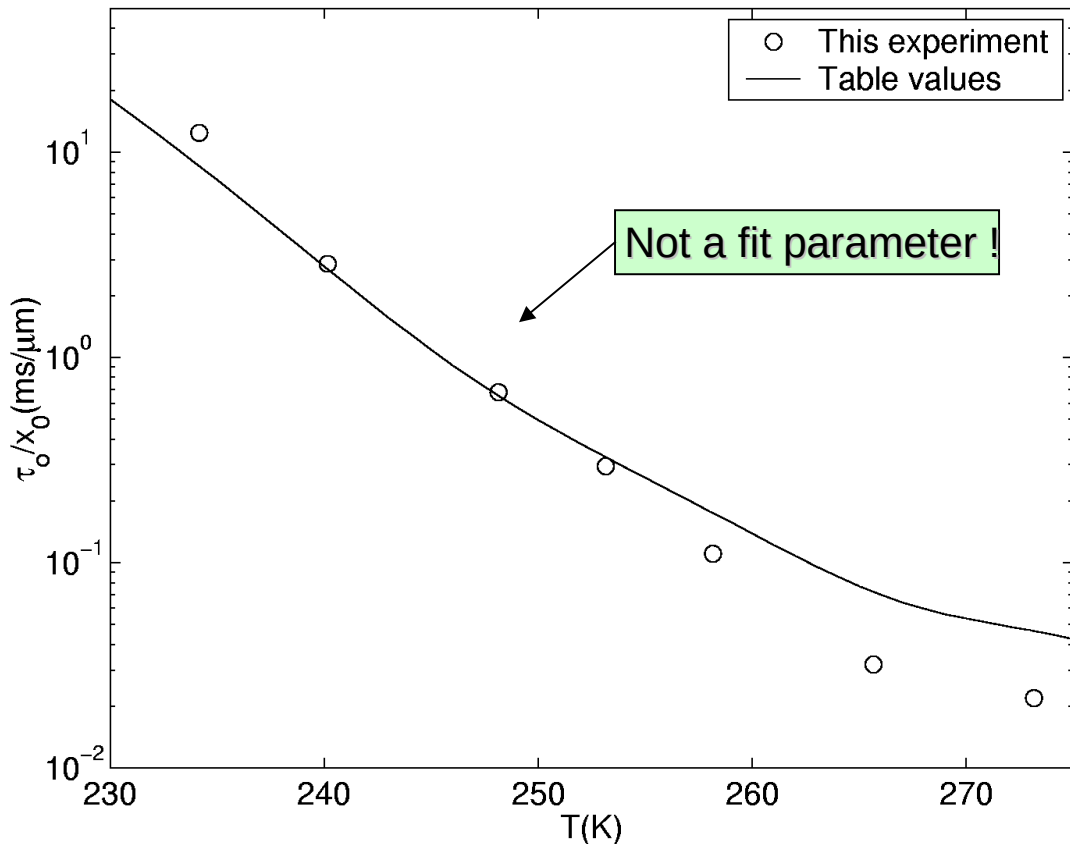

Summary

Construction of a laboratory reflectometer

Development of a sample environment



**First *in situ* investigation
of a surface during the glass transition**

**First application of XPCS to the
lateral dynamics at a surface**

**Freezing of the roughness and
overdamped capillary waves observed**

Acknowledgement

- All members of the Press group
- BNL/NSLS: B.M.Ocko, E.DiMasi, S.Coburn, B.Schoenig, W.Caliebe, M.Sprung, C.Sanchez-Hanke, U.S. Dept. of Energy

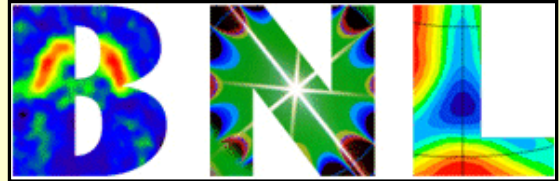

- H.Kraack (Bar-Ilan University)
- HASYLAB (BMBF)
- ESRF: A.Madsen, G.Grübel



- Deutsche Forschungsgemeinschaft
(Project ID DFG Pr 325/9-1,2,3)

•

