



**HAL**  
open science

## An approach to compare multiphase drives for automotive safety applications

Antonin Ribiere, Ngac-Ky Nguyen, Eric Semail, Christophe Espanet

► **To cite this version:**

Antonin Ribiere, Ngac-Ky Nguyen, Eric Semail, Christophe Espanet. An approach to compare multiphase drives for automotive safety applications. 2022 IEEE/AIAA TRANSPORTATION ELECTRIFICATION CONFERENCE AND ELECTRIC AIRCRAFT TECHNOLOGIES SYMPOSIUM (ITEC+EATS), Jun 2022, Anaheim, United States. 10.1109/ITEC53557.2022.9813812. hal-03761350

**HAL Id: hal-03761350**

**<https://hal.science/hal-03761350v1>**

Submitted on 26 Aug 2022

**HAL** is a multi-disciplinary open access archive for the deposit and dissemination of scientific research documents, whether they are published or not. The documents may come from teaching and research institutions in France or abroad, or from public or private research centers.

L'archive ouverte pluridisciplinaire **HAL**, est destinée au dépôt et à la diffusion de documents scientifiques de niveau recherche, publiés ou non, émanant des établissements d'enseignement et de recherche français ou étrangers, des laboratoires publics ou privés.

# An approach to compare multiphase drives for automotive safety applications

Antonin Ribière<sup>(1)(2)</sup>, Ngac-Ky Nguyen<sup>(1)</sup>, Eric Semail<sup>(1)</sup>, Christophe Espanet<sup>(2)</sup>

(1) Univ. Lille, Arts et Metiers Institute of Technology HESAM Université, Centrale Lille, Junia, ULR 2967 – L2EP, F-2500 Lille, France

(2) Moving Magnet Technologies; 1 rue Christiaan Huygens, F-25000 Besançon, France

antonin.riberie@ensam.eu, ngacky.nguyen@ensam.eu, eric.semail@ensam.eu, christophe.espanet@movingmagnet.com

**Abstract**—Automotive safety applications will be soon a standard based on market evolution trends. Actuators performing safety operations, such as steering or braking, need to be more reliable with a low manufacturing cost. Multiphase drives seem to be a good alternative to actuators redundancy, as it offers greater degrees of freedom with at a limited extra cost. These drives have been studied for a while, especially in other industries such as ship propulsion or aeronautic actuator. However, comparison between multiphase drives for a given application is rare. In this paper, a methodology is proposed to evaluate several drives for a safety automotive application. Some manufacturing assumptions have been made in order to narrow the study to five, six and seven phase permanent magnet synchronous motors (PMSM). Machines have been modeled using 2-D finite elements analysis (FEA) software in order to extract their parameters which will be used in dynamic simulations. Based on the obtained results, each drive is evaluated according to defined criteria and best solutions are highlighted. Considering a low voltage high current application, full bridge inverter topologies feeding a six-phase motor seem to be a promising solution.

## I. INTRODUCTION

Automotive industry is moving towards safer actuators in regard to future autonomous vehicles developments. Particular applications such as steering or braking need for increased reliability and require high functional safety. In case of an open phase fault, standard three phase machines cannot produce a constant torque anymore and then are not suitable for these critical applications. Redundancy using multi-motors system could be a solution, but it is not an effective one regarding a cost-oriented market such as automotive one.

On the contrary multiphase drives allow a better torque density and a fault-tolerant capability by increasing the number of phases. These drives have been widely investigated, especially for ship propulsion or aircraft applications [1]–[3]. Multiphase drives offer more numerous degrees of freedom that can be used to mitigate the impacts of a failure such as torque ripples and ensure a minimum level of functionality. Inverter could also help to improve the fault-tolerant capability of the drive, considering different configurations than the standard half-bridge (HB) voltage source inverter (VSI). Full-bridge (FB) VSI seems to be a good alternative as it offers an additional degree of freedom, suppressing the neutral point condition.

Comparisons exist between multiphase systems [4]–[8], but manufacturing cost is generally out of the scope in these

studies. However, this is a crucial aspect in automotive industry which is based on mass production. The cost of a solution is an important design criterion and must be considered from the drive design phase [9], [10]. That is why this paper proposes a methodology to design low-cost multiphase drives for automotive safety applications. The proposed analysis considers only the technical elements which are impacting significantly the cost. Of course, the final price of the actuator is depending also on non-technical considerations. Some design assumptions are made to limit the cost of the solution such as the use of concentrated tooth windings multiphase permanent magnet synchronous motors or the use of PM rectangular segments in a tangent internal permanent magnet (TIPM) rotor. Numerous solutions are then evaluated and compared, based on defined criteria including manufacturing considerations.

## II. MULTIPHASE DRIVE COMPARISON APPROACH

### A. Global approach

The aim of the study is to propose and test a methodology to compare multiphase fault-tolerant drives for automotive safety applications. Fig. 1 presents the global approach for the design. The first step is to define the scope of the study based on application requirements: such as bus voltage, dimension limitation or maximum operating point. Then, different machine topologies by varying geometric parameters are evaluated using 2-D finite elements analysis (FEA). Next step consists in eliminating some topologies that are not enough

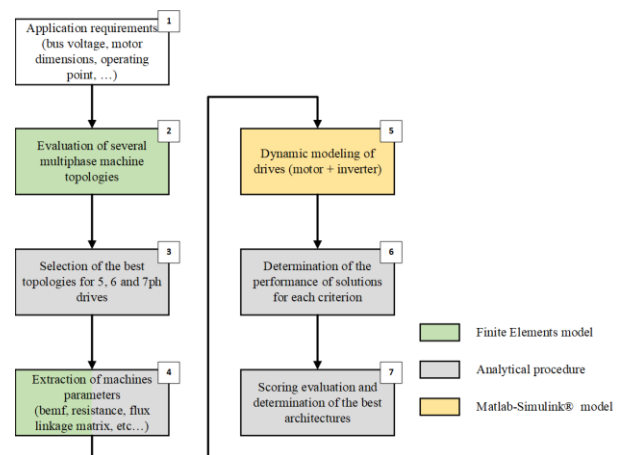

Fig. 1. Multiphase design approach

competitive regarding defined requirements. During the fourth step, parameters of the sorted machines are extracted, such as back electromotive forces (BEMF) spectrums, flux-linkage matrices and resistances. These parameters will be used in dynamic simulations during the fifth step, where both machines and inverters are modeled using Matlab-Simulink. In the sixth step, data are post-processed to evaluate each solution regarding a particular set of criteria. Finally, the last step consists in choosing the best solutions regarding criteria that are the most valuable for the given application.

This approach aims to be generic and results highly depend on which criteria are considered as important. However, it is also a good tool at a pre-design level. For instance, if final results are very tight between evaluated solutions, it could be useful to consider a wider range of topologies at step 2. It is not necessary a linear approach and back and forth between steps are possible.

### B. Applications requirements

In this study, electro-hydraulic power steering (EHPS) actuator for commercial vehicles is considered as a reference application. Compared to an electric power steering (EPS), electric actuator only drives the hydraulic pump in order to provide the assistant torque. However, it is still important to prevent any sudden lost of assist. The driver should be able to steer his truck even after a fault occurs and to continue his mission. That is why this application is well suited to evaluate different multiphase drives. Maximum operating point and integration constraints are given in Table I.

TABLE I  
MAIN APPLICATIONS REQUIREMENTS

Parameter	Symbol	Value
DC bus voltage	$U_{DC}$	24 V
Maximum motor speed	$\Omega_{max}$	4500 rpm
Maximum motor torque	$T_{max}$	15 Nm
Maximum motor height	$H_{max}$	90 mm
Maximum motor diameter	$D_{max}$	180 mm

### C. Motor design assumptions

In this study, some assumptions are made in order to focus the scope. First, only multiphase PMSM are considered. These machines generally offer better torque density compared to other technologies for this kind of application.

To reduce manufacturing complexity, concentrated tooth windings are preferred rather than distributed ones. Coils could be directly wound around the teeth that simplify the winding process, especially for high volume production. In addition, it also allows to shorten the end-winding and then reduce the length of machine and minimize copper losses. In a fault-tolerant aspect, it could be interested to use this topology as it helps to reduce magnetic and thermal coupling between coils.

For manufacturing constraint, a maximum number of 15 coils are chosen as it remains quite close to a standard 12 coils three-phase machine, as the one used in the EPS actuator from Tesla Model 3. In this condition and considering a sufficient number of phases: only five, six and seven phases machines are evaluated. Using a higher number of phases, such as nine or eleven phases motor, seems to be not worth

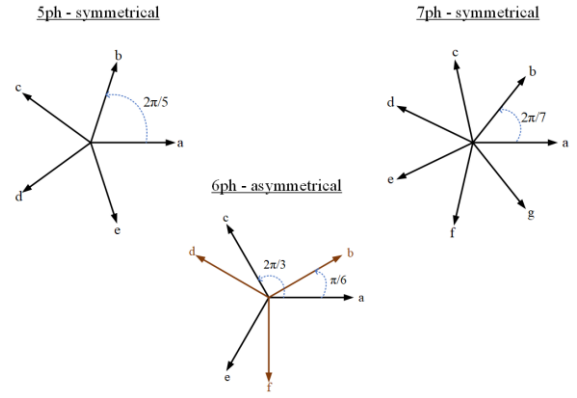

Fig. 2. Electrical angle shift between motor phase among studied topologies

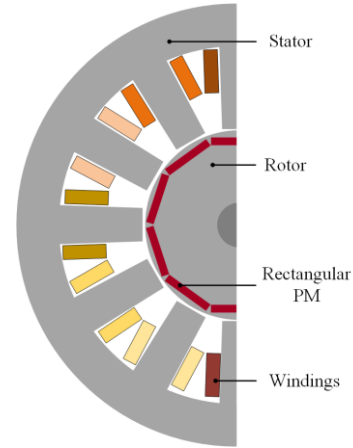

Fig. 3. Tooth-concentrated winding stator with TIPM rotor for a 12slots - 10 poles machines

compared to the additional complexity it requires. Asymmetrical configuration for six phases is used due to better torque ripple compared to symmetrical one (rank 12th harmonic compared to 6th). A representation of phasor diagrams is given in Fig. 2.

At last, tangent internal permanent magnet (TIPM) rotor is preferred. Indeed, the simple rectangular shape makes the magnets both cheaper and easier to be assembled, reducing the overall manufacturing cost. Saliency effects added by this choice will be omitted in the early steps of the study. Saturation effects will also be neglected at this stage and will be discussed latter in this paper. An illustration of motor topology is given in Fig. 3.

### D. Inverter design assumptions

Since DC bus voltage in the current application is 24V, architectures such as multi-level or multi-cellular inverters are not studied. These kinds of architectures are best suited for high-voltage applications as it reduces the constraint on transistors. That is why in this study, only two architectures are considered: HB inverter (1n-leg) and FB inverter (2n-leg), as illustrated in Fig. 4.

HB voltage source inverters are widely used and simple to be controlled, but have no-intrinsic fault-tolerant behavior. On the contrary, FB inverters are well suited for safety low-voltage applications as motor phases are electrically independent. This topology requires two legs per phase, doubling the required number of transistors. However, with

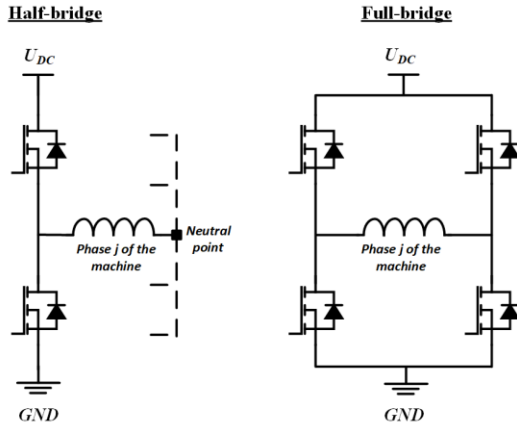

Fig. 4. HB and FB inverter topologies supplying a motor phase

FB inverter maximum allowed phase voltage is doubled compared to HB. It means that coil turns could be twice the HB case, multiplying the torque constant by two and then reducing the needed current by two for a given torque. In other words, FB inverter requires more transistors but with a lower current rating. For high current applications, the transistors used in HB are often parallelized to withstand self-heating due to losses. It means that in low-voltage and high-current applications, HB and FB could lead to the same number of transistors if coil turns are adapted.

In this study, only the power stage is considered. In particular, EMC filtering is omitted. This last point could be discussed as it could be an important part during the inverter design. However, in a pre-design level, other criteria such as current total harmonic distortion (THD) could be used in order to have an idea of the filtering effort to provide.

### III. DRIVE COMPARISON RESULTS

#### A. Drive comparison criteria

The aim is to sort studied solutions among both motor and inverter performances, as well as manufacturing cost and control complexity. Different main criteria have been selected and can be found in the upper row of Table II and Table III.

On motor side, the motor constant is defined by the mean torque divided by the square root of copper losses. It reflects the intrinsic capacity of the motor to produce torque at lower copper losses. Losses have been shared depending on their location, to have an idea of how the losses would be difficult to evacuate. Stator losses include both copper and iron losses, whereas rotor losses include both permanent magnet and iron losses at rotor. Torque ripple is also important to consider in steering application, both in a healthy configuration and after an open phase fault (OPF) occurs. Torque ripple in faulty state is given without any reconfiguration of the control laws, torque reference is kept the same.

On the inverter side, one of the main criteria to consider is the losses. It includes both transistors losses due to conduction and switching losses and also body diode losses. The total number of transistors is also important as it influences directly the bill of material (BOM) price but also the area required on the printed circuit board, that could lead to integration complexity.

In terms of control, the time required by a microcontroller to perform the regulation should not be neglected. It could

impact the BOM if a more powerful microcontroller is needed to be able to drive the motor. This aspect is approximated by the number of current closed-loop controllers required for the drive.

The final cost of an actuator is complicated to evaluate in early development. However, an approximation of a raw materials required for the motor manufacturing is presented to have a rough idea. It is defined by the sum of approximated price for iron, copper and permanent magnets based on internal feedback experiences from authors. Expressing in per unit for 1 kilogram of material, iron is 1, copper is 8 and permanent magnets are 100. Care should be taken with these numbers, as it remains approximations and could vary considering mass production volumes.

At last, carbon footprint has also been estimated using information provided by ADEME which is the French Agency of Environment and Energy Management. This institution gives a database to estimate CO<sub>2</sub> equivalent emissions per kilograms of extracted material (copper, iron and permanent magnets) as well as the impact of transportation. Only these two aspects have been considered. This criterion will probably be more and more important in the incoming years due to stricter environment standards.

#### B. Motor topologies selection

Referring to step 2 in Fig. 1, numerous motors with different poles and slots configurations have been designed. Each dot in Fig. 5 represents a design evaluation. Pareto fronts have been highlighted on magnet mass and copper losses. At this stage, the main idea is to compare the different motor topologies in order to find the best suited ones based on application requirements. That is why these two criteria have been chosen to plot Pareto fronts, as it gives a good idea of the performances of the evaluated topologies.

In 1-layer configuration, there is only one coil per slot that generally leads to poor filling coefficients. This can be seen in Fig. 5 where the two five-phase 1-layer configurations are really apart from the 2-layer ones. For a given number of phases, best configurations are the one for which winding factor is the biggest [11].

Finally, three 2-layer motor topologies are selected: 10 slots – 8 poles for five-phase, 12 slots – 10 poles for six-phase and 14 slots – 12 poles for seven-phase. Before extracting their parameters, meshing is refined for these three motor

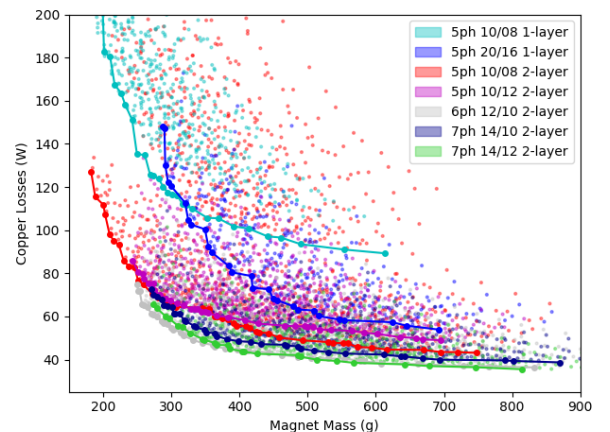

Fig. 5. Results of motor topologies comparison, copper losses versus magnet mass

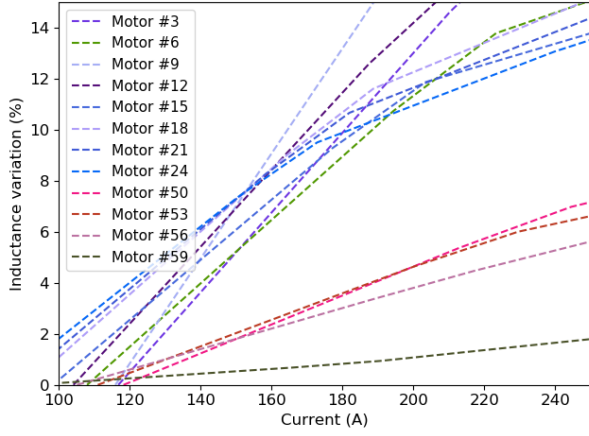

Fig. 6. Percentage of inductance variation versus phase currents for a sample of evaluated motors

topologies. Then, each designed solution is coupled with both HB and FB inverter to evaluate dynamic performances.

In Fig. 6, a sample of evaluated motors have been selected to visualize the saturation effects, by representing the variation of nominal phase motor inductance while current increasing. Depending on the inverter configuration, HB or FB, motor phase current will mostly vary between 100A and 250A. Some motors are more subjects to inductance variations. However, in most cases this variation stays below 15% even at higher currents. That is why, for a sake of simplicity, saturation effects are neglected in dynamic simulations.

### C. Dynamic modeling and evaluation of each criteria

As depicted previously, BEMF, resistances and flux linkage matrices are extracted from FEA to be used in Matlab-Simulink simulations. Generalized Concordia transformation is used in order to model the drive in each dq-planes [12]. The same method is used to tune the current PI-controllers for each drive to have a fair comparison. Drive parameters are then extracted at maximum operating point (4500rpm and 15Nm). In total, 78 motors have been selected and tested for both HB inverter and FB inverter after adapting coil turns. In Table II and Table III, for each criterion, results are normalized by the average value of the 156 evaluated solutions for the given criterion. Results presented in these tables are already the best among the evaluated solutions, based on numerical values threshold for each criterion. A color code has been added to ease the lecture of these tables. Greener the cell is, better is the drive on this particular criterion. In opposite, a red cell means the drive is one the worst for considered criterion. Table II gives the best drives among all criteria, whereas Table III gives the results with a more traditional approach, focusing on performances parameters rather than cost ones

It is also interesting to note that only three solutions are present both in Table II and Table III. These solutions seem to be a good trade-off for every considered criterion, but this is not the general case. For instance, solutions #105 and #106 have good motor constant and low losses that make them apparently ideal solutions. However, their price is a lot higher and then, they are not cost-effective solutions for a competitive mass production market.

Based on these results, six-phase PMSM driven by FB topology seems a good trade-off between performances and manufacturing cost. This architecture configuration represents half of the final selection of Table II. Five-phase FB topology with 10 slots – 8 poles should also be considered for this kind of application, as it could lead to good performances while having fewer components than six-phase architectures.

In order to deeper compare the pre-selected different drives topologies, other analysis will be necessary. As example, Fig. 7 illustrates the behavior after an OPF without control reconfiguration, for solutions #83, #128 and #74. Table IV gives the numerical value associated to Fig. 7 and especially the over currents and torque ripples due to the OPF. These three electric drives have been selected among the 11 solutions of Table II.

Drive #74 is a seven-phase motor fed by a HB inverter and therefore the currents are higher compared to both five-phase and six-phase FB architectures, leading to higher stator and inverter losses. However, on contrary to FB solution, no zero-sequence current have to be controlled with this solution. As there is no control configuration, same current references are applied and then torque ripples significantly increase as depicted in Table IV. Moreover, currents in remaining phases increase to compensate the faulty one, up to plus 57% for the five-phase drive. This paper does not present the losses after a fault occurs, but this is an important point that should not be neglected when designing functional safety actuators.

TABLE IV  
COMPARISON OF 5-PHASE (#83), 6-PHASE (#128) AND 7-PHASE (#74) DRIVES, EVALUATED AT 4500RPM – 15NM

Solution ID	Maximum peak current Healthy (A)	Maximum peak current Faulty (A)	Torque ripples Healthy (Nm)	Torque ripples Faulty (Nm)
#83	168	264 (+57%)	1.14	3.14 (+175%)
#128	137	194 (+42%)	0.73	6.05 (+728%)
#74	241	345 (+43%)	0.96	5.93 (+517%)

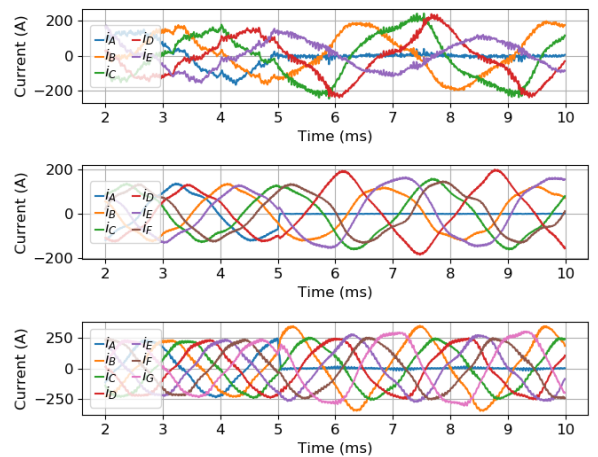

Fig. 7. Motor phase currents after an OPF event for solutions #83 (top), #128 (middle) and #74 (bottom)

TABLE II  
MULTIPHASE DRIVES COMPARISON RESULTS CONSIDERING COST CRITERIA

Solution ID	Architecture configuration	Motor constant	Stator Losses	Rotor Losses	Torque ripple Healthy	Inverter losses	Torque ripple Faulty	Total transistors number	Motor raw material price estimation	Current closed-loop controllers	Carbon footprint estimation
#23	6ph + half-bridge	1.03	0.96	0.76	0.83	1.28	1.03	0.70	1.02	0.91	1.01
#24	6ph + half-bridge	1.06	0.94	0.79	0.94	1.22	1.05	0.70	1.05	0.91	1.02
#73	7ph + half-bridge	1.09	1.06	0.87	1.00	1.14	0.91	0.82	0.97	1.10	1.03
#74	7ph + half-bridge	1.11	1.06	0.90	1.07	1.09	0.92	0.82	1.00	1.10	1.04
#83	5ph + full-bridge	1.04	0.79	1.01	1.27	0.51	0.49	0.59	1.05	0.91	1.00
#102*	6ph + full-bridge	1.03	0.96	0.76	0.74	0.64	0.93	0.70	1.02	1.10	1.01
#103*	6ph + full-bridge	1.06	0.94	0.79	0.81	0.61	0.93	0.70	1.05	1.10	1.02
#104*	6ph + full-bridge	1.09	0.94	0.81	0.88	0.59	0.92	0.70	1.08	1.10	1.03
#107	6ph + full-bridge	1.11	0.92	0.93	1.05	0.51	1.00	0.70	1.10	1.10	1.04
#128	6ph + full-bridge	1.03	0.94	1.00	0.81	0.58	0.95	0.70	0.92	1.10	0.98
#129	6ph + full-bridge	1.04	0.92	1.11	0.95	0.54	1.02	0.70	0.93	1.10	0.98

\* : shared solution with or without considering cost criteria

TABLE III  
MULTIPHASE DRIVES COMPARISON RESULTS WITHOUT CONSIDERING COST CRITERIA

Solution ID	Architecture configuration	Motor constant	Stator Losses	Rotor Losses	Torque ripple Healthy	Inverter losses	Torque ripple Faulty	Total transistors number	Motor raw material price estimation	Current closed-loop controllers	Carbon footprint estimation
#80	5ph + full-bridge	1.01	0.83	0.86	1.08	0.49	0.47	1.17	0.99	0.91	0.96
#86	5ph + full-bridge	1.06	0.84	0.76	1.15	0.47	0.46	1.17	1.14	0.91	1.02
#102*	6ph + full-bridge	1.03	0.96	0.76	0.74	0.64	0.93	0.70	1.02	1.10	1.01
#103*	6ph + full-bridge	1.06	0.94	0.79	0.81	0.61	0.93	0.70	1.05	1.10	1.02
#104*	6ph + full-bridge	1.09	0.94	0.81	0.88	0.59	0.92	0.70	1.08	1.10	1.03
#105	6ph + full-bridge	1.11	0.93	0.73	0.96	0.56	0.96	0.70	1.21	1.10	1.09
#106	6ph + full-bridge	1.14	0.93	0.75	1.03	0.54	0.96	0.70	1.25	1.10	1.10
#139	7ph + full-bridge	1.02	1.11	0.83	0.88	0.66	0.25	1.64	0.94	1.28	1.01
#146	7ph + full-bridge	1.00	1.11	0.81	0.95	0.59	0.30	1.64	0.93	1.28	1.01

\* : shared solution with or without considering cost criteria

#### IV. CONCLUSIONS

This study has presented and tested a methodology in order to consider the whole drive design from performances perspectives as well as manufacturing considerations. On the contrary, a standard approach would consist on designing motor and inverter aside. If both approaches could lead to the same results, it is generally not the case and it is important to have a cost-oriented approach, even at pre-design phase, for mass production applications.

Multiphase drives have been chosen in order to meet functional safety requirements due to their more numerous degrees of freedom. Some design assumptions have been done and the comparison has highlighted two promising architectures for EHPS application: five-phase and six-phase motors fed by FB inverter. Five-phase solutions could have less components compared to six-phase. However, six-phase has the advantage to be quite similar to two standard three-phase systems. The re-use of cost-effective integrated chip, such as three-phase gate drivers, can be a real advantage in this topology.

Some points have been omitted during this study. This is the case for saliency and saturation effects that may impact the results presented in this paper. 2-D FEA have been used to save simulation time, but 3-D analysis should be preferred

to evaluate some aspects such as end-winding losses. EMC filtering is also a point of interest that could impact directly the price of the inverter. To go deeper into the comparison, these aspects should be considered as well as the impact of a fault occurrence regarding the overall losses.

Finally, this paper focuses on a low voltage application with high currents. This has a strong impact on transistor choice and the predominant use of FB inverters. In a high voltage application with lower currents, transistors' current rating constraint will be less important and HB inverters should be competitive regarding total number of components. Results should be different with others applications, but the same approach can be applied.

#### ACKNOWLEDGMENT

The authors would like to thank Stéphane Tavernier for his great help on finite element simulations and motor designs.

#### REFERENCES

- [1] E. Levi, "Multiphase Electric Machines for Variable-Speed Applications," IEEE Trans. Ind. Electron., vol. 55, no. 5, pp. 1893–1909, May 2008, doi: 10.1109/TIE.2008.918488.
- [2] J. Xu, B. Zhang, H. Fang, and H. Guo, "Guaranteeing the fault transient performance of aerospace multiphase permanent magnet motor system:

An adaptive robust speed control approach,” *Trans. Electr. Mach. Syst.*, vol. 4, no. 2, pp. 114–122, Jun. 2020

- [3] M. Hasoun, A. El afa, and M. Khafallah, “Field Oriented Control of Dual Three-Phase PMSM Based Vector Space Decomposition for Electric Ship Propulsion,” in 2019 International Conference of Computer Science and Renewable Energies (ICCSRE), Agadir, Morocco, Jul. 2019
- [4] J. Kammermann, I. Bolvashenkov, and H.-G. Herzog, “Approach for comparative analysis of electric traction machines,” in 2015 International Conference on Electrical Systems for Aircraft, Railway, Ship Propulsion and Road Vehicles (ESARS), Aachen, Germany, Mar. 2015, pp. 1–5.
- [5] E. Fomasiero and N. Bianchi, “Slot Harmonic Impact on Rotor Losses in Fractional-Slot Permanent-Magnet Machines,” *IEEE TRANSACTIONS ON INDUSTRIAL ELECTRONICS*, vol. 59, no. 6, p. 8, 2012.
- [6] L. Zhang, Y. Fan, R. D. Lorenz, A. Nied, and M. Cheng, “Design and Comparison of Three-Phase and Five-Phase FTFSCW-IPM Motor Open-End Winding Drive Systems for Electric Vehicles Applications,” *IEEE Trans. Veh. Technol.*, vol. 67, no. 1, pp. 385–396, Jan. 2018
- [7] Y. Sui, Z. Yin, L. Cheng, J. Liu, and P. Zheng, “Comparison of Five-Phase and Three-Phase PMSMs with Identical Silicon Steel Laminations,” in 2019 22nd International Conference on Electrical Machines and Systems (ICEMS), 2019, p. 5.
- [8] A. Negahdari, A. G. Yepes, J. Doval-Gandoy, and H. A. Toliyat, “Efficiency Enhancement of Multiphase Electric Drives at Light-Load Operation Considering Both Converter and Stator Copper Losses,” *IEEE Trans. Power Electron.*, vol. 34, no. 2, pp. 1518–1525, Feb. 2019,
- [9] J. Reimers, L. Dom-Gomba, C. Mak, and A. Emadi, “Automotive Traction Inverters: Current Status and Future Trends,” *IEEE Trans. Veh. Technol.*, vol. 68, no. 4, pp. 3337–3350, Apr. 2019
- [10] L. Hao, M. Pandi, C. Mavuru, C. Namuduri, A. Omekanda, and T. Nehl, “Design and analysis of a low cost and high power density PM-assisted synchronous reluctance machine for automotive electric power management,” in 2017 IEEE Energy Conversion Congress and Exposition (ECCE), Cincinnati, OH, Oct. 2017, pp. 3583–3590.
- [11] B. Aslan, E. Semail, J. Korecki, and J. Legranger, “Slot/pole combinations choice for concentrated multiphase machines dedicated to mild-hybrid applications,” in IECON 2011 - 37th Annual Conference of the IEEE Industrial Electronics Society, Melbourne, Vic, Australia, Nov. 2011, pp. 3698–3703.
- [12] M. J. Duran and F. Barrero, “Recent Advances in the Design, Modeling, and Control of Multiphase Machines—Part II,” *IEEE Trans. Ind. Electron.*, vol. 63, no. 1, pp. 459–468, Jan. 2016.