



HAL
open science

Improvement of SI engine combustion with ammonia as fuel: Effect of ammonia dissociation prior to combustion

A. Mercier, Christine Mounaïm-Rousselle, Pierre Brequigny, J. Bouriot, C. Dumand

► To cite this version:

A. Mercier, Christine Mounaïm-Rousselle, Pierre Brequigny, J. Bouriot, C. Dumand. Improvement of SI engine combustion with ammonia as fuel: Effect of ammonia dissociation prior to combustion. Fuel Communications, 2022, 11, pp.100058. 10.1016/j.jfueco.2022.100058 . hal-03759457

HAL Id: hal-03759457

<https://hal.science/hal-03759457v1>

Submitted on 22 Jul 2024

HAL is a multi-disciplinary open access archive for the deposit and dissemination of scientific research documents, whether they are published or not. The documents may come from teaching and research institutions in France or abroad, or from public or private research centers.

L'archive ouverte pluridisciplinaire **HAL**, est destinée au dépôt et à la diffusion de documents scientifiques de niveau recherche, publiés ou non, émanant des établissements d'enseignement et de recherche français ou étrangers, des laboratoires publics ou privés.



Distributed under a Creative Commons Attribution - NonCommercial 4.0 International License

1 Improvement of SI engine combustion with ammonia as fuel: effect of ammonia dissociation
2 prior to combustion.

3 Authors: Mercier A¹., Mounaïm-Rousselle C¹., Brequigny P¹., Bouriot J²., Dumand C²¹

4 **1 Abstract:**

5 Although recent studies have shown the possibility of running ‘standard’ spark-ignition engines with
6 pure ammonia, the operating range remains limited mainly due to the unfavorable characteristics of
7 ammonia for premixed combustion and often requires the addition of a complementary fuel such as H₂
8 to extend it. As the best way to add H₂ is to crack ammonia directly on-board, this paper focuses on
9 the impact of the upstream cracking level of ammonia on the performance and emissions of a single
10 cylinder spark ignition engine. Experiments were performed over several equivalence ratios,
11 dissociation rates and load conditions. It is confirmed that only a slight rate of ammonia dissociation
12 (10%) upstream of the combustion considerably enhances the engine's operating range thanks to a
13 better combustion stability. In terms of pollutant emissions, the partial dissociation of ammonia,
14 especially for slightly lean mixtures induces a very clear trade-off between high NO_x and high
15 unburned ammonia level for high and low ammonia dissociation rates, respectively. Therefore,
16 cracking NH₃ does not only improve the operating range of ammonia-fueled spark ignition engines but
17 can also help to reduce NH₃. However, to reach the same engine output work, higher ammonia fuel
18 consumption will be necessary since the global system efficiency is lower using fuel dissociation. In
19 addition, the global warming effect is increased with dissociation level since a higher level of N₂O is
20 generated by the hydrogen contribution.

21 Keywords: ammonia; hydrogen; dissociation; NH₃ cracking; e-fuel; combustion; internal combustion
22 engine.

23

24 **2 Nomenclature**

¹Laboratoire PRISME, Université d'Orléans, Orleans, France

²Innovation Department, STELLANTIS-PSA, Paris, France

<i>SI</i>	Spark Ignition
<i>CAD</i>	Crank Angle Degree
<i>IMEP</i>	Indicated Mean Effective Pressure
<i>HRR</i>	Heat Release Rate
<i>BMF</i>	Burnt Mass Fraction
<i>CAXX</i>	CAD corresponding to XX% of FMB
<i>FTIR</i>	Fourier Transform Infrared
<i>SIT</i>	Spark Ignition Timing
<i>Pin</i>	Intake Pressure
<i>ISFC</i>	Indicated Specific Fuel Consumption
<i>LBV</i>	Laminar Burning Velocity
<i>LHV</i>	Lower Heating Value
<i>COV</i>	Covariance
<i>NRJ</i>	Energy
<i>TDC</i>	Top Dead Center

25

26 **3 Introduction**

27 To be carbon neutral by 2050, the European Union needs to move away from fossil fuels as soon as
 28 possible. Using e-fuels such as ammonia and hydrogen for transportation can be part of the tools to
 29 reach this goal since their life cycle carbon footprint is low especially when they are produced from
 30 decarbonized sources [1–3]. Furthermore, a growing interest in ammonia has been observed in recent
 31 years as it has several advantages over hydrogen, namely: lower storage cost [4]; higher volumetric
 32 energy density; an existing and certified transport and storage network; and physical properties that
 33 simplify storage and transport. Recent studies have shown that it is possible to run a spark ignition (SI)
 34 engine using only ammonia as fuel over a wide operating range. In [2], an SI engine was run with
 35 using neat ammonia in a recent EP6 PSA SI Engine until 1bar of intake pressure guaranteeing less
 36 than 3% of COV_{IMEP} and engine performances similar to those of methane. Despite satisfactory results
 37 at mid load, engine stability and combustion efficiency can be enhanced thanks to hydrogen addition
 38 [5,7]. However, in their study, Mounaïm-Rousselle *et al.* [8] indicated the limitations of pure ammonia
 39 combustion at low load for a SI engine. The minimum Indicated Mean Effective Pressure (IMEP) was
 40 limited to 5 bar using neat ammonia while 3 and 2 bars were reached with H₂ addition and a
 41 compression ratio increase respectively. Therefore, doping the engine with small amounts of hydrogen
 42 (5-10% by volume) or by increasing the compression ratio are two strategies that have been necessary
 43 so far to make the engine run stably at low load. The use of an on-board ammonia cracker can be seen

44 as a key to improving engine performance at low load for a low compression ratio engine. This was
45 tested in [9] where it was shown that it is possible to start a cold engine with less than 10% hydrogen
46 in the fuel in transient conditions. In [10], a numerical study provided an explanation for the effect of
47 NH_3 -dissociation on flame structure, combustion efficiency, maximum temperature and NO_x
48 emissions. It was found that NO_x level increases when dissociating ammonia up to a dissociation level
49 of 80% and then decreases until complete decomposition of the ammonia due to a decrease in
50 maximum temperature at a very high dissociation level that limits the formation of thermal NO while
51 fuel NO is no longer present. In addition, the same team concluded in [11] that by dissociating half of
52 the NH_3 molecule, the Laminar Burning Velocity (LBV) of the fuel mixture can reach that of methane
53 and the promoting effect of H_2 is much more significant than the inhibiting effect of N_2 even with a
54 higher H_2/N_2 ratio than the one obtained naturally from dissociation. Finally, the effect of a dissociated
55 ammonia blend with gasoline on engine performances using a real cracker was investigated in [12] and
56 compared to ammonia/gasoline blend combustion without a catalyst in an SI engine. *Ryu et al.*[12]
57 found 2 advantages of using an ammonia cracker: i) it promotes the engine combustion; ii) it reduces
58 ammonia and NO_x exhaust emissions, especially at low load due to the high conversion rate. However,
59 it was impossible to maintain a constant dissociation rate when changing the ammonia flow rate and
60 low conversion rates were used at high load due to a reduction of the residence time in the catalyst.
61 Therefore, the present study reports new data on the effect of partial NH_3 dissociation on SI engine
62 performances and exhaust polluting emissions. Eight different levels of dissociation were investigated
63 (namely from 0 to 0.4, 0 corresponding to pure NH_3) and several loads in order to define what
64 dissociation level would allow the best performances-polluting emissions trade-off for running an SI
65 Engine. In addition, to support and better understand the findings, simulations were conducted with a
66 zero-dimensional, two-zone Spark Ignition engine model of the CHEMKIN-PRO package in ANSYS,
67 based on the NH_3 reaction mechanism of Stagni *et al.* [13]. According to [11], this mechanism, which
68 contains 31 species and 203 reactions, appears to be the most accurate to predict any chemical heat
69 release and to highlight some tendencies of exhaust gases such as NO, NO_2 , N_2O and unburnt
70 emissions (NH_3 and H_2).

71

72 **4 Experimental setup**

73 Engine experiments were conducted in a single cylinder SI engine, with the specifications indicated in
74 Table 1. The geometry of the engine was modified, i.e. the stroke was increased from 85.8 mm to 115
75 mm in order to best match the engine architecture and the physical characteristics of ammonia. For
76 this, a long stroke not only increases the volumetric ratio without changing the shape of the
77 combustion chamber, thus keeping a constant surface/volume ratio at TDC but also increases the
78 internal aerodynamics of the engine. A flat piston was implemented in this study to increase the
79 compression ratio, as shown in Figure 1. The engine is driven by an electric motor at a various engine
80 speeds. The main shaft is equipped with a Kubler optical encoder for angular position monitoring with
81 a 0.1 Crank Angle Degree (CAD) resolution. A water-cooled AVL piezoelectric pressure transducer
82 with a 0.1 CAD resolution provides in-cylinder pressure measurements. Its measuring range is 0 - 25
83 MPa. Engine intake and exhaust temperature and pressure are monitored using type K thermocouples
84 and piezo-resistive absolute pressure transducers. The absolute cylinder pressure is obtained by
85 equalizing the in-cylinder pressure and the mean absolute intake pressure (P_{in}), 20 CAD in the middle
86 of the intake stroke. The spark plug used is the original one with a coil charging time set to 2 ms. For
87 all the data presented below, several operating points were recorded with several Spark Ignition
88 Timings (SIT). For each condition, the operating point with the maximum IMEP as control parameter
89 that guarantees a COV_{IMEP} below 5% was chosen. Ammonia, hydrogen (both 99.99% purity), nitrogen
90 and air gaseous flows were measured and controlled using Brooks thermal mass flowmeters with +/-
91 0.7% accuracy, preheated to the intake temperature of 323 K and premixed in an intake plenum prior
92 to injection. A scheme of the experimental setup is shown in Figure 2.

93 *Table 1: Engine characteristics*

	SI (EP6 LC)
Displaced volume(l)	0.535
Stroke (mm)	115

Bore (mm)	77
Connecting rod length (mm)	177
Compression ratio	11.75
Number of valves	4
Water and oil temperatures (°C)	80

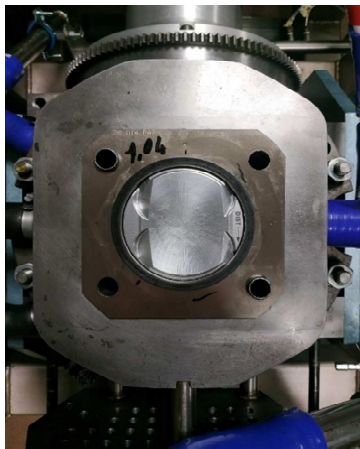

94

95 *Figure 1: Flat piston implemented for the study*

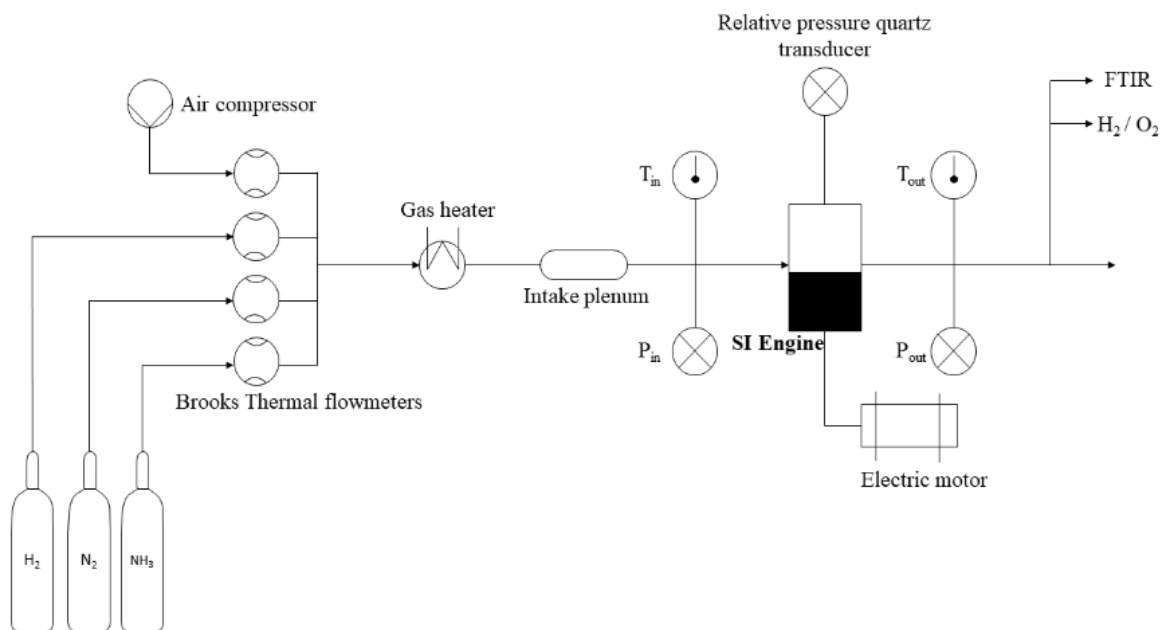

96

97 *Figure 2: Layout of the experimental setup*

98 The wet exhaust gases were analyzed using a Gasmet Fourier Transform Infrared (FTIR) spectrometer
 99 to assess H₂O, NO, NO₂, and NH₃ concentrations. To obtain simultaneous quantitative measurement
 100 of many gaseous species with a good time resolution and accuracy, the interferences between the
 101 species of interest are correctly identified and considered in the analysis settings. The analysis ranges
 102 of the species of interest can be found in Table (2). Lastly, H₂ exhaust measurement was performed
 103 using a thermal conductivity gas sensor (XEN-5320), that determines the gas composition by
 104 measuring the temperature elevation of a micromachined heater element. Its measurement range was
 105 set to 0-10% in the case of ammonia combustion.

106 *Table 2: Analysis range settings to determine exhaust species concentration from FTIR*

Species	Wave Length (cm ⁻¹)
H ₂ O	3950 - 4240
N ₂ O	2060 - 2280
NO	1850 - 2110
NO ₂	2770 - 2990
NH ₃	2990 - 3365

107 The apparent Heat Release Rate (HRR) was computed from pressure trace post processing with the
 108 first law of thermodynamics, as follows:

$$109 \quad \frac{dQ}{d\theta} = \frac{\gamma}{\gamma - 1} * P * \frac{dV}{d\theta} + \frac{1}{\gamma - 1} V * \frac{dP}{d\theta} \quad (1)$$

110 where γ is the heat capacity ratio, P, V and θ , the cylinder pressure and volume and crank angle,
 111 respectively. Note that heat losses are not considered in the calculation since they are very difficult to
 112 determine; they will be the subject of future work. The Burnt Mass Fraction (BMF) is then obtained by
 113 integrating the heat release and apparent HRR is then recalculated using the variable heat capacity
 114 ratio computed from the previous BMF. The different phases of combustion propagation were
 115 determined by estimating different characteristic timings, named CAXX, which are the Crank Angle
 116 degrees corresponding to XX% of the burnt mass fraction. The CA10, CA50 and CA90 are also used

117 as input data, for the built-in zero-dimensional, two-zone SI engine model in Chemkin Pro, to
 118 determine the best-fit Wiebe function, since the mass is transferred between the 2 zones at the rate and
 119 timing specified by the Wiebe function. In addition, The Woshni wall heat exchange model was used
 120 to estimate the energy fraction lost at the wall and the convection coefficient was optimized by
 121 changing only the C_0 value from Equation (2) until Equation (3) becomes true. Due to high modelling
 122 uncertainties the CAXX plotted in the present study were computed using apparent heat release.

$$123 \quad h_c = C_0 \left(B^{-0,2} P_{Cyl}^{0,8} \left((C_1 C_m) + \frac{C_2 C_u T_{BDC}}{P_{BDC} V_{BDC}} (P_{Cyl(\theta)} - P_{0(\theta)}) \right) \right)^{0,8} T_{Cyl}^{-0,53} \quad (2)$$

$$124 \quad \int_{SIT}^{CA90} dQ_{Comb} = 0,9 * m_{fuel} * LHV_{fuel} * \eta_{Comb} \quad (3)$$

125 4.1 Operating conditions

126 Assuming that ammonia can be dissociated in hydrogen and nitrogen by means of an on-board
 127 cracker, molar fractions of each species were defined following Equation (4), i.e. considering a
 128 constant mass; this differs from [11] where a constant volume was chosen. In addition, NH₃
 129 dissociation upstream of the combustion chamber was simulated on the test bench through flowmeters
 130 as schematized in Figure 2.

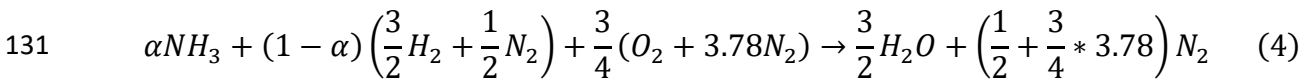

132

133 Therefore, the α coefficient represents the molar fraction of NH₃ that is not dissociated and can be
 134 defined as follows:

$$135 \quad \alpha = \frac{\frac{3}{2} * X_{NH3}}{\frac{3}{2} * X_{NH3} + X_{H2}} \quad (5)$$

136 with X the molar fraction of each species in the fuel. All operating conditions are summarized in Table

137 3.

138 For each operating condition, a Spark Ignition Timing (SIT) sweep was performed in order to find the
 139 optimal CA50 phasing for each blend. The criterion depends on both combustion stability and the best
 140 IMEP. From the equivalence ratio definition (Equation (6)), three different levels (0.9, 1 and 1.1) were
 141 investigated. All of them are close to stoichiometry in order to see the impact of mixture composition
 142 on covariance and polluting emissions without having very high levels of NO_x and NH₃ for lean and
 143 rich conditions, respectively. Therefore, to keep both equivalence ratio and intake pressure constant,
 144 volumetric air and fuel flows were adjusted as a function of the dissociation level.

$$145 \quad \phi = \frac{(\dot{V}_{H_2} + \dot{V}_{NH_3})}{\dot{V}_{air}} * AFR_{stoevol} \quad (6)$$

146 with AFR_{stoel} , the volumetric stoichiometric air/fuel ratio.

147 *Table 3: Engine operating conditions*

Engine speed (rpm)	1000
Intake temperature (°C)	50
Intake pressure (bar)	[1; 0.8; minimum]
ϕ (-)	[0.9; 1; 1.1]
α_{NH_3}	[1; 0.98; 0.95; 0.9; 0.85; 0.8; 0.7; 0.6]

148
 149 Table 4 sums up the Lower Heating Value (LHV) by mass and mole for 100 and 0% of cracked
 150 ammonia and for neat hydrogen for comparison, to highlight the decrease in energy in the case of a
 151 full dissociation of ammonia due to the presence of nitrogen. Indeed, although the LHV per mixture
 152 increases with the increase in hydrogen content, if the nitrogen is kept, the volumetric energy density
 153 drops a slightly with the level of dissociation, namely -6% between neat ammonia and fully
 154 decomposed ammonia.

155 *Table 4: Mixture LHV comparison between neat ammonia, neat hydrogen and dissociated ammonia at $\phi = 1$*

$\phi = 1$	LHV per mixture mass (kJ/kg)	LHV per mixture mol (kJ/mol)
$\alpha=1$ (Neat NH ₃)	2643	69.31
$\alpha=0$ (H ₂ +N ₂)	3026	65.11
Neat H ₂	3427	71.53

156

157 Figure 3.a) highlights the effect of NH₃ cracking on the mixture energy content – by mass and volume
 158 –, mixture density and introduced energy relative to the value obtained in the neat ammonia condition
 159 for all tested dissociation levels assuming once again that nitrogen is kept in the mixture. Mass and
 160 volume energy content behave in an opposite way due to the very low density of hydrogen. Therefore,
 161 as the filling efficiency does not change much (only subject to intake temperature variations), the
 162 energy content introduced in the engine – derived from the flow meters – drops as the NH₃
 163 dissociation level increases. However, by using the optimized Goldmann and Dinkelacker semi
 164 empirical correlation given in [14], it can be seen that the increase of nitrogen in the mixture as a
 165 function of dissociation level will not compensate the Laminar Burning Velocity (LBV) increase as
 166 plotted in Figure 3.b), where conditions at SIT for in-cylinder pressure and temperature were chosen
 167 as initial conditions for the calculation.

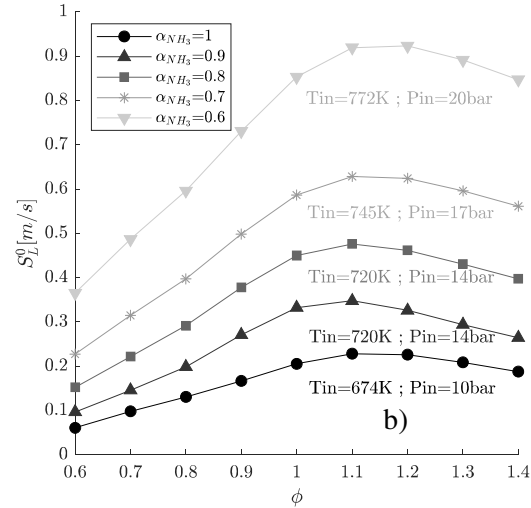
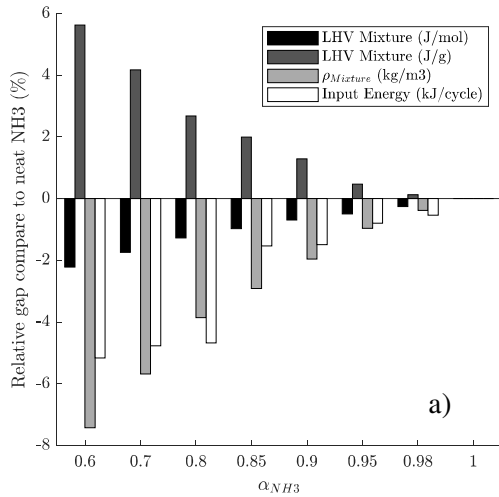

168

169 Figure 3: a) Relative effect of dissociation on mixture LHV and Input Energy; b) Dissociation effect on Laminar Burning
 170 Velocity from semi-empirical correlation [14].

171

172

173

174 5 Results and discussion

175 5.1 NH₃-dissociation effect on engine performances

176 All the results presented in section 5.1 and 5.2 were performed at a constant intake pressure of 1 bar
 177 and 1000 rpm. Since the energy mixture content is higher in neat NH₃ conditions, due to the energy
 178 molar density, for a constant intake pressure and equivalence ratio, IMEP is as expected higher as
 179 shown in Figure 4.a and therefore decreases as a function of dissociation level. The effect is less
 180 significant for slightly lean air/fuel mixtures, i.e. less than 3% for $\phi = 0.9$ in comparison to 6% for
 181 $\phi = 1.1$. Furthermore, as indicated, efficiency is relatively constant: the decrease of IMEP is of the
 182 same order of magnitude as the decrease in energy content (Figure 3a).

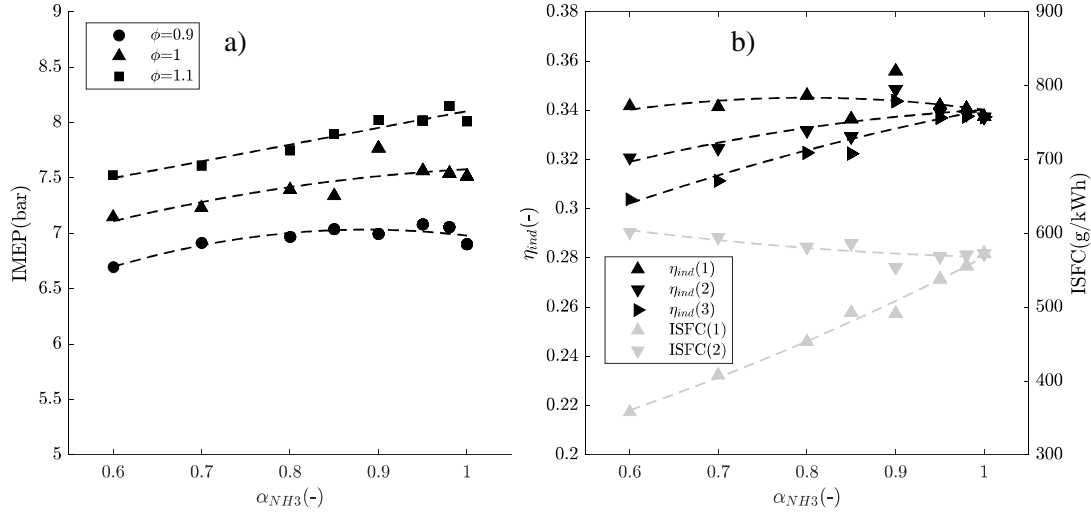

183

184 Figure 4: a) Dissociation effect on IMEP and ISFC for several equivalence ratios at 1000rpm and 1bar; b) Comparison of
 185 engine indicated efficiency and global (engine + cracker) efficiency as a function of dissociation level at $\phi = 1$, 1bar and
 186 1000 rpm.

187 However, when the LHV loss due to partial NH_3 decomposition is considered, as explained in
 188 Equations (6,7), the indicated efficiency drops much more with the increase in dissociation rate (-4%
 189 at $\alpha_{NH_3} = 0.8$). On the other hand, by considering Equation (9), Indicated Specific Fuel Consumption
 190 (ISFC) is no longer a reflection of the indicated efficiency since the LHV of the fuel changes as the
 191 degree of dissociation varies except if the neat ammonia condition is taken as a reference (Equation
 192 (10)). The way of calculating the engine efficiency in Equation (6) is interesting to understand the
 193 fundamental aspects of combustion while Equation (7) is better adapted to a system approach, i.e. with
 194 an ammonia tank and an on-board cracker. Moreover, if the external energy requirement to decompose
 195 NH_3 (NH_3 cracking NRJ presented in Equation (11)) is considered, the efficiency of the engine drops
 196 even more as the dissociation level increases, i.e. -2.3 % at $\alpha_{NH_3} = 0.8$ (Equation (8)).

197
$$\eta_{ind(1)} = \frac{W_i}{(m_{fuel} * LHV_{fuel})_{post\ cracker}} \quad (6)$$

198
$$\eta_{ind(2)} = \frac{W_i}{(m_{fuel} * LHV_{fuel})_{before\ cracker}} \quad (7)$$

199
$$\eta_{ind(3)} = \frac{W_i}{(m_{fuel} * LHV_{fuel})_{before\ cracker} + NH_{3\ cracking\ NRJ}} \quad (8)$$

$$ISFC_1 = \frac{(\dot{m}_{fuel})_{postcracker}}{Power_i} \quad (9)$$

$$ISFC_2 = \frac{(\dot{m}_{fuel})_{beforecracker}}{Power_i} \quad (10)$$

$$NH_{3crackingNRJ} = (1 - \alpha_{NH_3}) * \Delta H_f^{(298)} * X_{NH_3mixture} * \frac{Tot_{VFR} * 2}{22.4 * N} \quad (11)$$

with $X_{NH_3mixture}$ the molar fraction of ammonia in the mixture and Tot_{VFR} the total volumetric flow rate in NL/min.

$$\eta_{comb} = 1 - \frac{Q_{unburnt}}{Q_{fuel}} = 1 - \frac{\dot{m}_{H_2} * LHV_{H_2} + \dot{m}_{NH_3} * LHV_{NH_3}}{\dot{m}_{fuel} * LHV_{fuel}} \quad (12)$$

$$\eta_{thermo} = 1 - \frac{1}{CR^{\gamma-1}} \quad (13)$$

$$\eta_{shape} = \frac{\eta_{ind}}{\eta_{comb} * \eta_{thermo}} \quad (14)$$

208

Efficiency details are given in Figure 5.a and formulas in Equations (12), (13) and (14), where the combustion efficiency (η_{comb}) is improved by dissociating ammonia due to a lower combustion duration. This is also highlighted in Figure 6.b. It is induced by the laminar burning velocity and the flame temperature increase, in accordance with [7]. One can assume that engine stability does not affect combustion efficiency since at optimal SIT, it always remains under 2% of COV_{IMEP} (for intake pressure of 1 bar) as shown in Figure 5.b. On the other hand, the adiabatic constant, $\frac{c_p}{c_v}$ ratio linearly drops slightly bit in neat ammonia conditions leading to a decrease in theoretical thermodynamic efficiency (η_{th}) since the compression ratio is fixed. Finally, the reduction of combustion duration due to the laminar burning velocity increase when dissociating NH_3 leads to a Spark Ignition Timing (SIT) adjustment in order to get the best IMEP as explained in Section 4. The wall heat exchanges noted XWall and represented in Figure 5.b is defined as the ratio between the calculated energy lost at the wall and the engine input energy. It increases with dissociation due to the maximum Heat Release Rate

221 (HRR) increase, leading to a global decrease in shape efficiency (η_{shape}) with dissociation. In
 222 addition, optimal SIT is reduced by increasing the dissociation level due a decrease in both ignition
 223 delay and combustion duration noted CA10-SIT and CA90-CA10 as can be seen in Figure 6.a and b
 224 respectively.

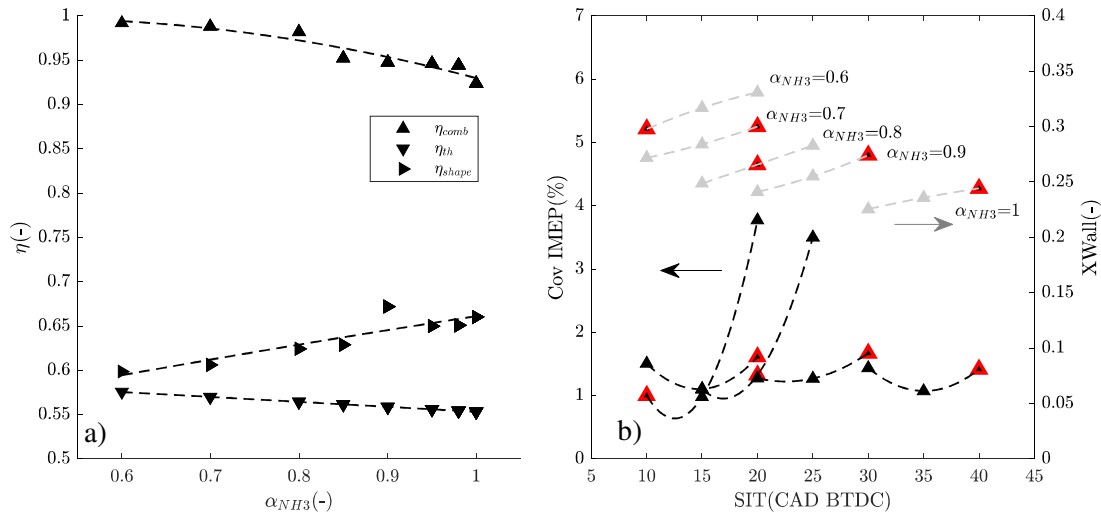

225
 226 *Figure 5: a) Effect of NH₃ dissociation on efficiencies at $\phi = 1$, 1bar and 1000 rpm; b) Wall energy lost fraction as a*
 227 *function of SIT for several dissociation levels. Optimized SIT is colored in red.*

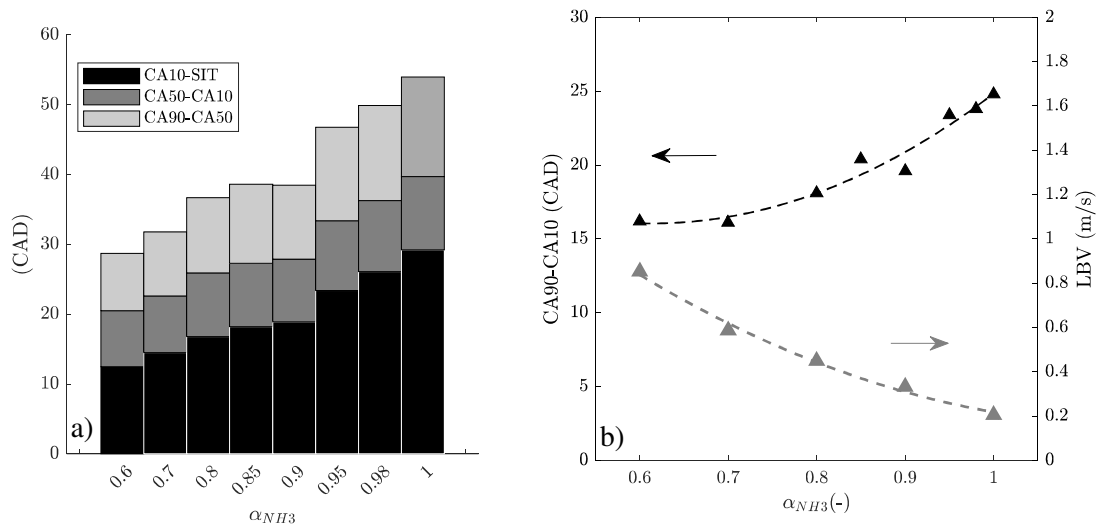

228
 229 *Figure 6: a) Durations of different phases of combustion development as a function of dissociation level at 1bar, 1000 rpm*
 230 *and $\phi = 1$; b) correlation between computed LBV and full combustion duration at 1bar and 100 0rpm.*

231

232 5.2 NH₃-dissociation effect on engine pollutant emissions

233 In Figures 7.a), NO_x emissions are presented. Both the dissociation level and the equivalence ratio
234 strongly affect these emissions. The difference between the NO_x level at $\phi = 1.1$ and $\phi = 1$ increases
235 when the dissociation degree is increased. As the NO_x level increases following the amount of H₂
236 content in the fuel and both thermal and fuel NO_x depend on temperature, this means that NO_{x_thermal}
237 increases faster than NO_{x_fuel} drops. However, the results from the 0D simulation indicate that the ratio
238 between NO_{x_thermal} and NO_{x_total} remains around 80% regardless of the level of dissociation so that
239 NO_x formation is mainly governed by Equation (15) of the Zeldovich mechanism. Furthermore,
240 Figures 7.c and 7.d show that a very good agreement can be observed, up to 15% of dissociation,
241 between simulated and measured NO_x and N₂O emission trends at the end of the cycle where almost
242 all NO_x produced during the combustion process are released at the exhaust (Figure 7.b). Also, as
243 already shown in previous studies [15], NO_x are mainly composed of NO. Finally, the NO_x level
244 obtained in neat ammonia combustion at $\phi = 0.9$ is very close to the one measured in [5] (namely 1%
245 higher) in the case of methane combustion for a similar engine type and operating conditions, which is
246 a very positive point for the feasibility of a NO_x aftertreatment system.

247

Zeldovich Mechanism:



249

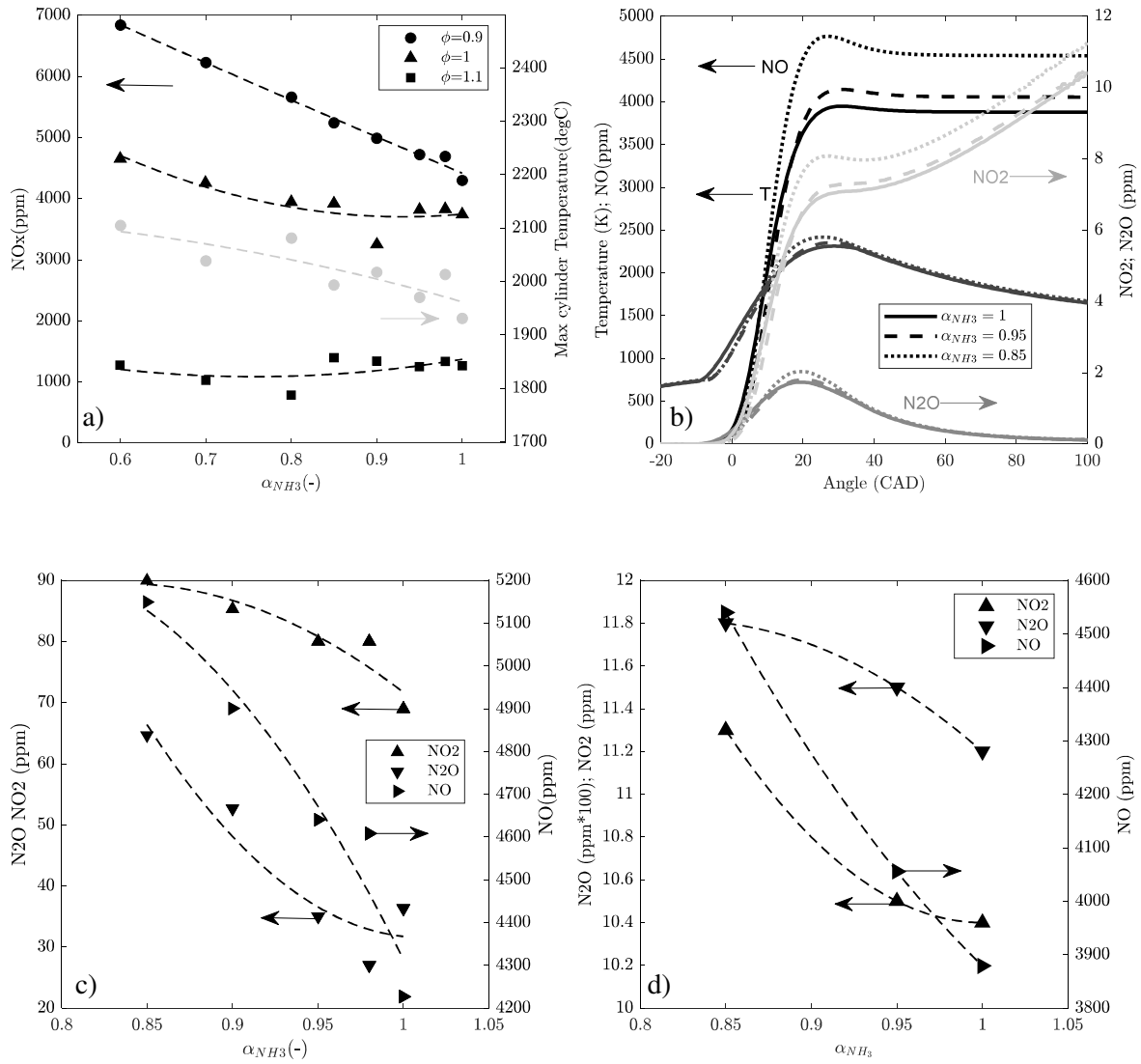

250

251

252 *Figure 7: NO_x and N_2O emissions a) NO_x emissions and maximum in-cylinder temperature as a function of dissociation*
 253 *degree and equivalence ratio – $P_{in} = 1$ bar and 1000 rpm; b) NO , NO_2 , N_2O and in-cylinder temperature trend from chemical*
 254 *kinetic simulation for 3 different dissociation levels; c) Measured exhaust emissions; d) Simulated exhaust emissions. $\phi =$*
 255 *0.9, $P_{in} = 1$ bar and 1000 rpm for b) c) and d)*

256 N_2O emissions are higher at high dissociation levels where NO concentration is also high. Therefore,
 257 since NH_3 remains the major fuel species, one can assume that the high temperature N_2O pathway is
 258 dominant in the present case study (Equation (18)) since NO is dominant species in NO_x emissions as
 259 explained in [15]. However, based on the kinetic mechanism, the latter pathway occurs mainly the
 260 reverse direction, meaning that part of the N_2O is dissociated into NO and not the contrary. Thus, the
 261 N_2O production rate is likely mainly governed by Equations (19) and (20), where production is spread
 262 equally over the two pathways as shown in Figure 8.

263

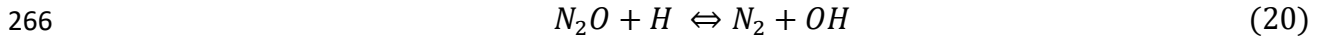
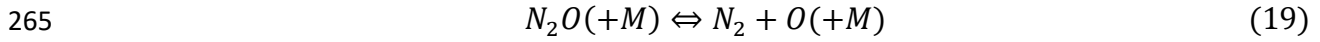

267

268

269 The above explanations and Figure 8 confirm that the dissociation effect promotes the occurrence of
 270 NO₂ NO and N₂O. Indeed, Figure 8 indicates that even though more N₂O is dissociated (Equation
 271 (18)) at $\alpha_{NH_3} = 0.85$, more N₂O is also formed (see Equation (19) and (20) resulting in a very slight
 272 increase in N₂O emissions as presented in Figure 7.b, c and d.

273

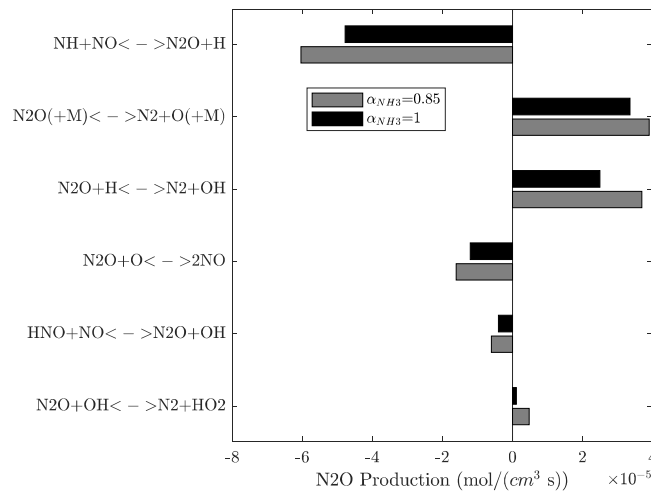

274

275 *Figure 8: N₂O production reaction pathway at the maximum production rate for 1000 rpm, 1bar.*

276

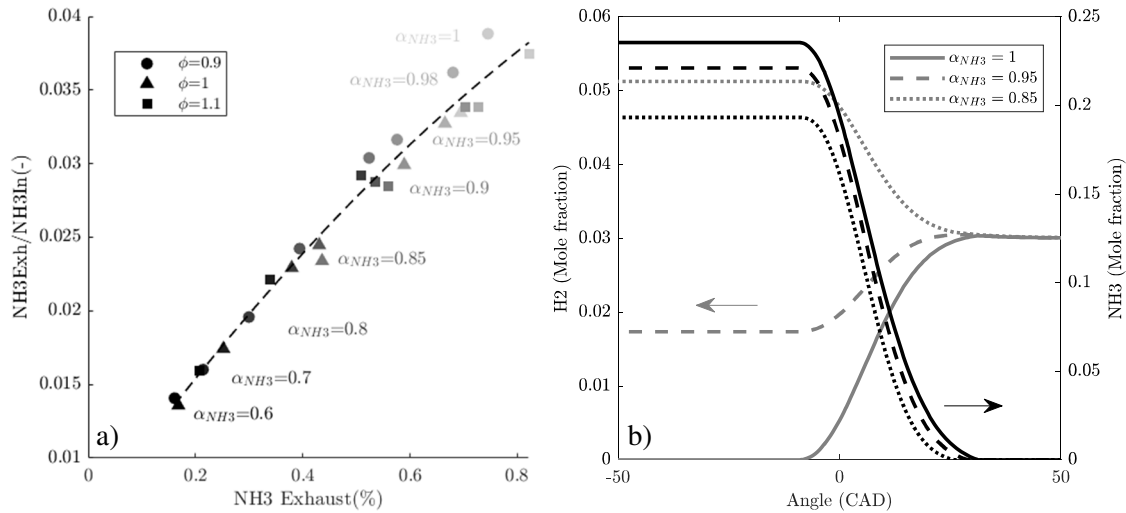

277

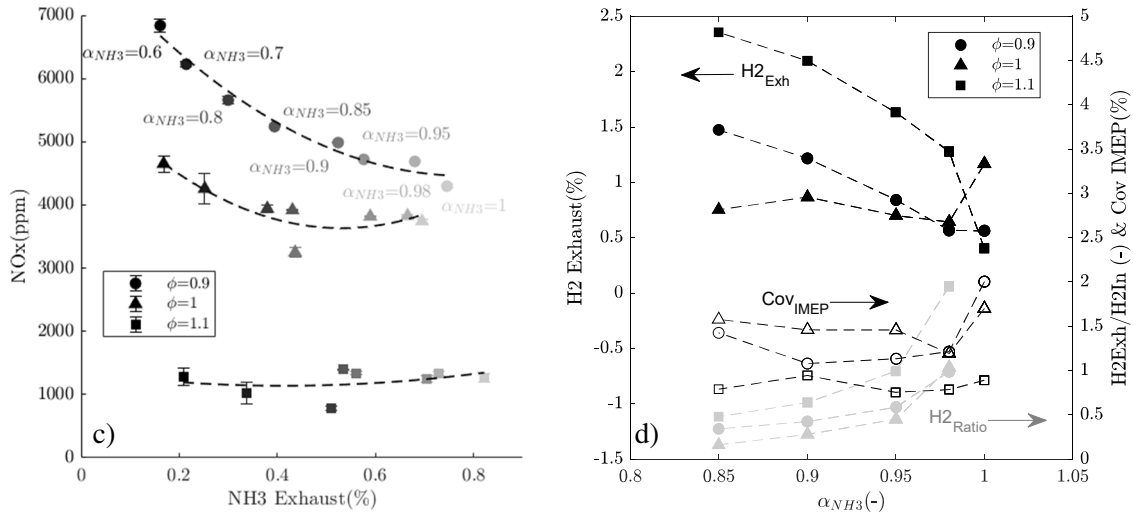

278

279 *Figure 9: Unburnt fuel emissions a) Ratio between intake and exhaust NH₃ mass flow rate as a function of exhaust NH₃*
 280 *concentration for several ϕ and α_{NH_3} ; b) example of ammonia and hydrogen molar fraction as a function of crank angle*
 281 *degree at $\phi = 1.1$ for 3 dissociation levels, obtained by simulation; c) NO_x vs NH₃ trade-off; d) Ratio between intake and*
 282 *exhaust hydrogen mass flow rate and exhaust hydrogen concentration as a function of dissociation level and equivalence*
 283 *ratio. Pin= 1bar and 1000 rpm.*

284 As mentioned earlier, ammonia dissociation enhances combustion due to H₂ production, thus
 285 improving combustion efficiency. Therefore, in the case of ammonia combustion both H₂ and NH₃
 286 species are present at the exhaust. Logically, higher quantity of ammonia and hydrogen are found for
 287 low and high dissociation levels, respectively, following the amount of H₂ and NH₃ at the intake. The
 288 combustion is very stable for every operating point at 1bar of intake pressure and 1000rpm, as shown
 289 in figure 9.d). The COV_{IMEP} always remains under 2% or even lower in slightly rich mixtures, a trend

290 also observed in [8]. Ammonia emissions did not change significantly with the change in air/fuel ratio,
 291 namely +17% and +6% in lean and rich mixtures due to the combustion stability problem and excess
 292 fuel respectively. This means that most of the measured ammonia might come from the crevice
 293 mechanism proposed by Westlye et al. [15] (Dead volumes in which the air/fuel mixture is present but
 294 cannot be burned because the flame cannot propagate).

295 On the other hand, hydrogen exhaust emissions illustrated in Figure 9.d) increase with the
 296 equivalence ratio, especially for a high dissociation level (+200% at $\alpha_{NH_3} = 0.85$). This confirms that
 297 most of the fuel which is not trapped might be converted into H₂, as predicted by the 0D simulation
 298 and presented in Figure 9.b where 3% of hydrogen is found at the exhaust and the NH₃ level is almost
 299 zero. However, this trend is no longer true experimentally in the case of neat ammonia combustion
 300 where the hydrogen exhaust level is constant as a function of the equivalence ratio while, as already
 301 mentioned, the ammonia exhaust measurement increases by 20% between stoichiometric and slightly
 302 rich mixtures ($\phi = 1.1$). In slightly rich mixtures, trapped ammonia increases sufficiently to impact
 303 the corrected equivalence ratio (ϕ_{cor}) presented in Equation (21). Its value drops by 5% and reaches a
 304 value of 1.05, meaning that a lower level unburnt H₂ level is expected at the exhaust. This could
 305 explain why hydrogen remains constant for neat ammonia operating conditions as a function of the
 306 equivalence ratio if all exhaust ammonia is considered as trapped ammonia.

$$307 \quad \phi_{cor} = \frac{\dot{m}_{fuel} - \dot{m}_{NH_3(trapped)}}{\dot{m}_{air}} * AFR_{stoe_{mass}} \quad (21)$$

308

309 On the other hand, relative to the amount of hydrogen at the intake, H₂ emissions turn out to be larger
 310 in neat ammonia combustion, as shown in Figure 9.d, following the combustion efficiency evolution.
 311 As a result, 15% of ammonia dissociation can reduce the unburnt NH₃ emissions by a factor 2
 312 whatever the equivalence ratio. Figure 9.c shows a clear tradeoff between NO_x and NH₃ in lean and in
 313 stoichiometric mixture as a function of the dissociation level. For a slightly rich mixture, since NO_x
 314 emissions are very low, the level is no longer affected by dissociation contrary to NH₃ emissions.

315 As a result, NO_x emissions were strongly reduced by adjusting the equivalence ratio: for example, a
 316 decrease of 70% or 80% from $\phi = 0.9$ to 1.1, for $\alpha_{NH_3} = 1$ or $\alpha_{NH_3} = 0.6$ respectively, while
 317 ammonia emissions could be managed by using dissociation level, giving a decrease of 100% from
 318 $\alpha_{NH_3} = 1$ to $\alpha_{NH_3} = 0.6$ whatever the equivalence ratio.

319 5.3 Low load operating range extension

320 The use of ammonia cracking is also one means to extend the low load operating condition range of
 321 the engine as highlighted in Figure 10.a. The stability criterion, i.e. 5% of IMEP covariance is reached
 322 for lower and lower inlet pressures as the dissociation level increases. Keeping 85% of ammonia in the
 323 fuel provides around 2 bars of IMEP, namely the same value as in a high compression ratio engine [8],
 324 which is near to engine output work at idle condition. The intake pressure map (Figure10.b) globally
 325 indicates once again the advantage of running the engine in a slightly rich mixture to guarantee stable
 326 condition at low load.

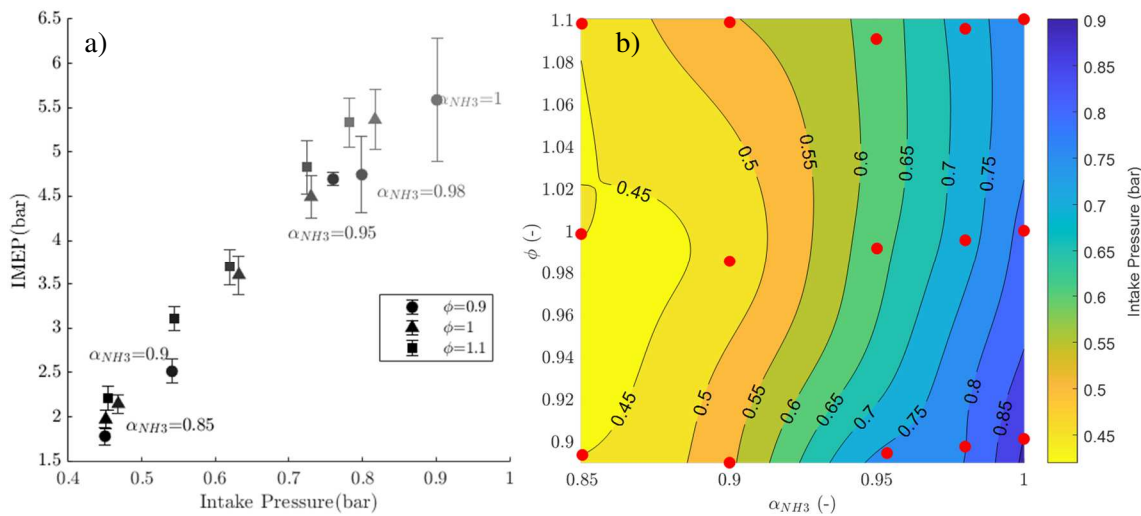

327
 328 *Figure 10: a) minimum IMEP vs minimum intake pressure at 1000rpm and Cov IMEP<5% showed through error bars as a*
 329 *function of both equivalence ratio and dissociation level; b) minimum intake pressure MAP as a function of both equivalence*
 330 *ratio and dissociation level.*

331 .

332 6 Conclusion

333 The present study has focused on the potential effect of ammonia dissociation on SI engine
334 performances and exhaust emissions in steady state conditions where both hydrogen and nitrogen were
335 kept in the mixture after ammonia dissociation. Firstly, this study shows that cracking ammonia
336 reduces the mixture energy content at the intake and therefore the energy output. Despite a constant
337 indicated efficiency where combustion efficiency improvement is globally balanced by higher wall
338 heat losses, the global efficiency is reduced due to a drop in the fuel Lower Heating Value and even
339 more if the energy required to dissociate ammonia is considered. Secondly as the dissociation
340 enhances combustion efficiency, it reduces unburnt ammonia emissions at the expense of hydrogen
341 emissions, which increase in absolute value. Even though the hydrogen level remains under 2% in the
342 exhaust emissions, it has to be considered since recent studies showed the potential indirect global
343 warming effect of hydrogen [16]. The N₂O level also has to be considered since it doubles when
344 dissociating 15% of upstream ammonia, reaching 60 ppm, which represents roughly 1.5% of CO₂,
345 therefore doubling the greenhouse gas emissions without counting the indirect effect of the H₂
346 previously mentioned. This study confirms that the best equivalence ratio to run the engine is a
347 slightly rich one since low NO_x are emitted and unburnt ammonia is mainly due to trapped ammonia.
348 NO_x emissions could be strongly reduced by adjusting the equivalence ratio, while ammonia
349 emissions could be managed by adapting the dissociation level and are not significantly impacted by
350 the equivalence ratio. Finally, as expected, even with a small fraction of nitrogen in the mixture,
351 ammonia cracking improves combustion stability and extends the operating range of the engine at low
352 load, i.e., achieving low-load operating conditions similar to those of a high-compression ratio engine
353 (of the spark-ignition assisted diesel type [8]). However, there is much less unburned ammonia due to
354 the optimized engine geometry for premixed combustion.

355

356 **7 Acknowledgements**

357 This project received support from the European Union's Horizon 2020 research and innovation
358 program under grant agreement No. 862482 (ARENHA project).

359

360 **8** **References**

- 361 [1] Vezina G, Bicer Y, Dincer I, Zamfirescu C, Raso F. Key Life Cycle Assessment Numbers for
362 NH₃ , Green and Brown Energy 2016.
- 363 [2] Boero AJ, Kardux K, Kovaleva M, Salas DA, Mooijer J, Mashruk S, et al. Environmental life
364 cycle assessment of ammonia-based electricity. *Energies* 2021;14.
365 <https://doi.org/10.3390/en14206721>.
- 366 [3] Bicer Y, Dincer I. Life cycle assessment of ammonia utilization in city transportation and
367 power generation. *J Clean Prod* 2018;170:1594–601.
368 <https://doi.org/10.1016/j.jclepro.2017.09.243>.
- 369 [4] Valera-Medina A, Amer-Hatem F, Azad AK, Dedoussi IC, De Joannon M, Fernandes RX, et
370 al. Review on ammonia as a potential fuel: From synthesis to economics. *Energy and Fuels*
371 2021;35:6964–7029. <https://doi.org/10.1021/acs.energyfuels.0c03685>.
- 372 [5] Lhuillier C, Brequigny P, Contino F, Rousselle C. Combustion Characteristics of Ammonia in
373 a Modern Spark-Ignition Engine. *SAE Tech Pap* 2019. <https://doi.org/10.4271/2019-24-0237>.
- 374 [6] Koike M, Suzuoki T. In-line adsorption system for reducing cold-start ammonia emissions
375 from engines fueled with ammonia and hydrogen. *Int J Hydrogen Energy* 2019;44:32271–9.
376 <https://doi.org/10.1016/j.ijhydene.2019.10.105>.
- 377 [7] Lhuillier C, Brequigny P, Contino F, Rousselle C. Performance and Emissions of an Ammonia-
378 Fueled SI Engine with Hydrogen Enrichment. *SAE Tech Pap* 2019;2019-Septe.
379 <https://doi.org/10.4271/2019-24-0137>.
- 380 [8] Mounaïm-Rousselle C, Mercier A, Brequigny P, Dumand C, Bouriot J, Houillé S. Performance
381 of ammonia fuel in a spark assisted compression Ignition engine. *Int J Engine Res* 2021;1–12.
382 <https://doi.org/10.1177/14680874211038726>.
- 383 [9] Koike M, Suzuoki T, Takeuchi T, Homma T, Hariu S, Takeuchi Y. Cold-start performance of
384 an ammonia-fueled spark ignition engine with an on-board fuel reformer. *Int J Hydrogen*

- 385 Energy 2021;46:25689–98. <https://doi.org/10.1016/j.ijhydene.2021.05.052>.
- 386 [10] Wang Z, Ji C, Wang D, Hou R, Zhang T, Wang S. Experimental and numerical study on
387 premixed partially dissociated ammonia mixtures. Part II: Numerical study of premixed
388 combustion characteristics. Fuel 2021;306:121660.
389 <https://doi.org/10.1016/J.FUEL.2021.121660>.
- 390 [11] Ji C, Wang Z, Wang D, Hou R, Zhang T, Wang S. Experimental and numerical study on
391 premixed partially dissociated ammonia mixtures. Part I: Laminar burning velocity of
392 NH₃/H₂/N₂/air mixtures. Int J Hydrogen Energy 2021.
393 <https://doi.org/10.1016/j.ijhydene.2021.10.269>.
- 394 [12] Ryu K, Zacharakis-Jutz GE, Kong SC. Performance enhancement of ammonia-fueled engine
395 by using dissociation catalyst for hydrogen generation. Int J Hydrogen Energy 2014;39:2390–
396 8. <https://doi.org/10.1016/j.ijhydene.2013.11.098>.
- 397 [13] Stagni A, Cavallotti C, Arunthanayothin S, Song Y, Herbinet O, Battin-Leclerc F, et al. An
398 experimental, theoretical and kinetic-modeling study of the gas-phase oxidation of ammonia.
399 React Chem Eng 2020;5:696–711. <https://doi.org/10.1039/c9re00429g>.
- 400 [14] Lhuillier C, Brequigny P, Lamoureux N, Contino F, Mounaïm-Rousselle C. Experimental
401 investigation on laminar burning velocities of ammonia/hydrogen/air mixtures at elevated
402 temperatures. Fuel 2020;263. <https://doi.org/10.1016/j.fuel.2019.116653>.
- 403 [15] Westlye FR, Ivarsson A, Schramm J. Experimental investigation of nitrogen based emissions
404 from an ammonia fueled SI-engine. Fuel 2013;111:239–47.
405 <https://doi.org/10.1016/j.fuel.2013.03.055>.
- 406 [16] Sand M, Myhre G, Sandstad M, Skeie RB. Atmospheric Impacts of Hydrogen as an Energy
407 Carrier, 2020.
- 408