

Experimental setup and numerical tools for the development of a photothermal therapy for the treatment of glioblastomas

Antoine Capart¹, Khaled Metwally^{1,2}, Chiara Bastiancich³ and Anabela Da Silva¹,

"Glioblastoma Risk Attrition by Vectorized Thermo-therapy - GRAVITY" project funded by the ITMO "Plan Cancer 2014–2019" INSERM program



Background

Number of brain cancer cases increasing with years + high mortality rate

	2018	2020
# of brain cancer cases	296,851	308,102
# of death	241,037	251,329
Mortality rate	81.2%	81.6%

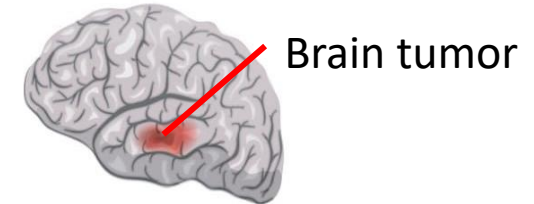

*Brain cancer's incidence and mortality rate in the world.
Values from Global Cancer Observatory (GLOBOCAN) databases*

Treatments options : surgery, chemotherapy, radiotherapy
= Important strain for the patients

➡ Need for alternative innovative therapies :

GRAVITY (Glioblastoma Risk Attrition by Vectorized ThermoTherapY) project :
photothermal therapy

Experimental setup + numerical tool

GRAVITY: Glioblastoma Risk Attrition by Vectorized ThermoTherapy

Objectives:

→ To develop new therapeutic strategy for glioblastomas treatment:

1. By **improving drug delivery** by targeted and temporary **permeabilization of the Blood Brain Barrier (BBB)** with **Focused UltraSound (FUS)**.

2. By proposing **Photo-Thermal Therapy (PTT)** with **drug-loaded inorganic NP** (Au, Si, **TiN**) as photo-absorbers for induced hyperthermia in the tumor.

3. By **local temperature monitoring with PhotoAcoustics (PA)** and possibly performing imaging of NPs biodistribution.

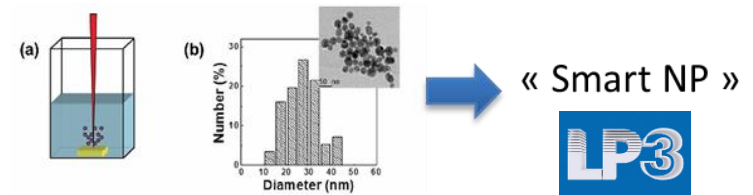
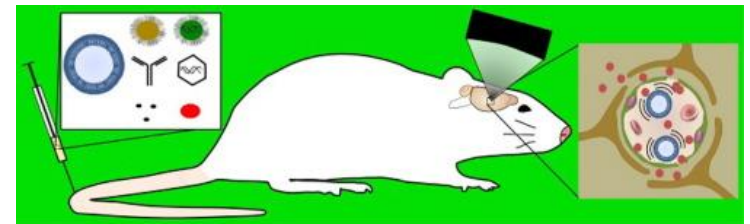
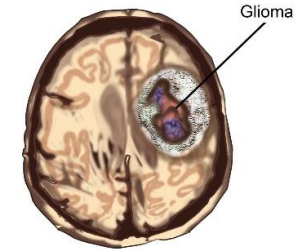

Popov et al., Sc. Reports 2019

$$p_0(\mathbf{r}) = \Gamma(\mathbf{r}) \mu_a(\mathbf{r}) \Phi(\mathbf{r}, \mu_a(\mathbf{r}), D(\mathbf{r}))$$
$$\Gamma(\mathbf{r}) = \frac{\beta v_s^2}{C_p} = f(T)$$

Setup @



Development of a multimodal system

1. Injection of μ bubbles+Injection of NPs (TiN) +BBB Opening
2. PTT: CW laser (LD 830 nm, 2W) irradiation 10 min;
3. During PTT, PA Temperature Monitoring (Nd:Yag, 1064 nm, frequency doubled by a KTP crystal at 532 nm, 330 mJ, 5 ns, 10 Hz)

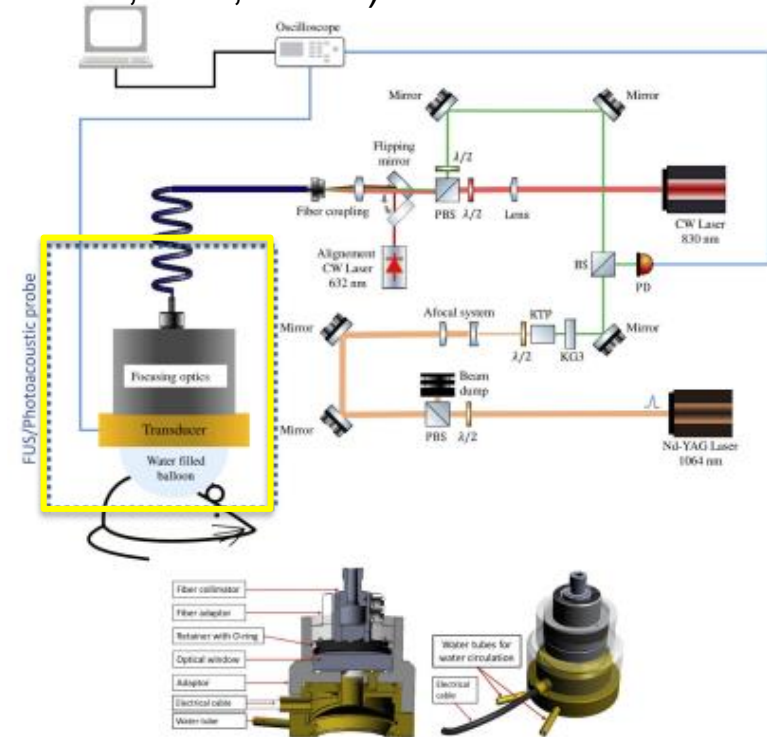
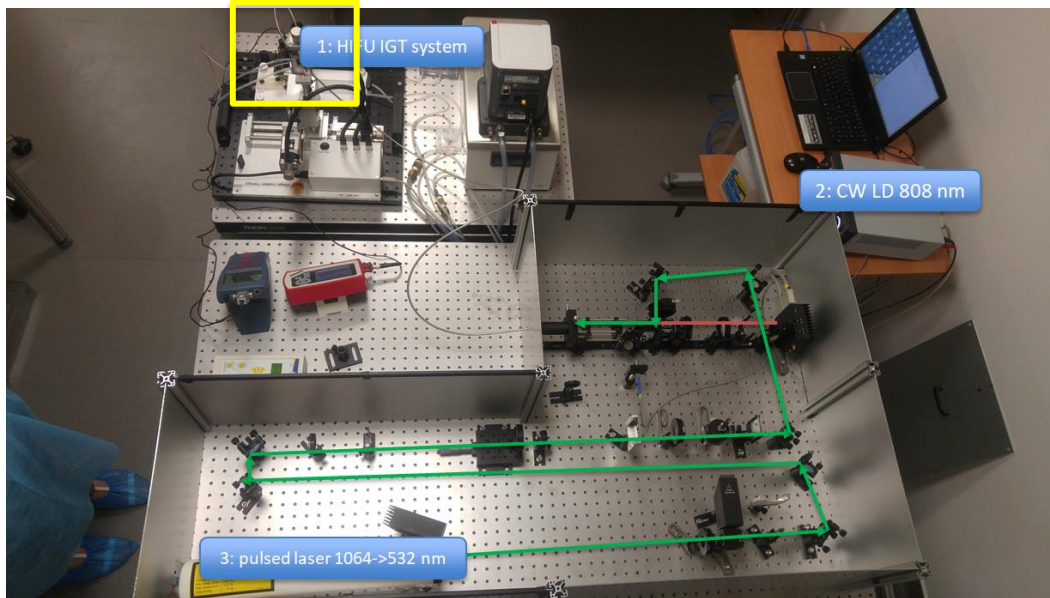
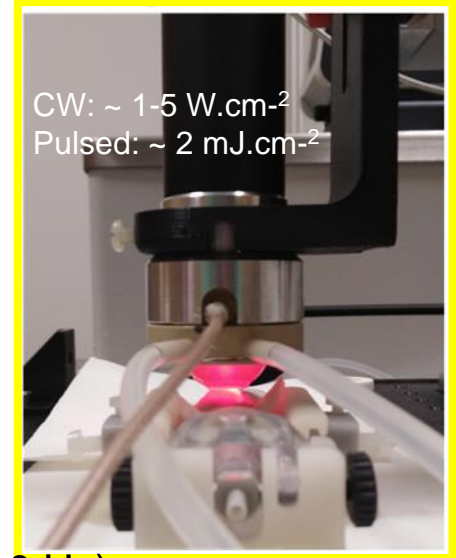

Metwally, *et al.*, Biomedical Optics Express **12**(4), 2021.

Blood-Brain Barrier (BBB) Opening

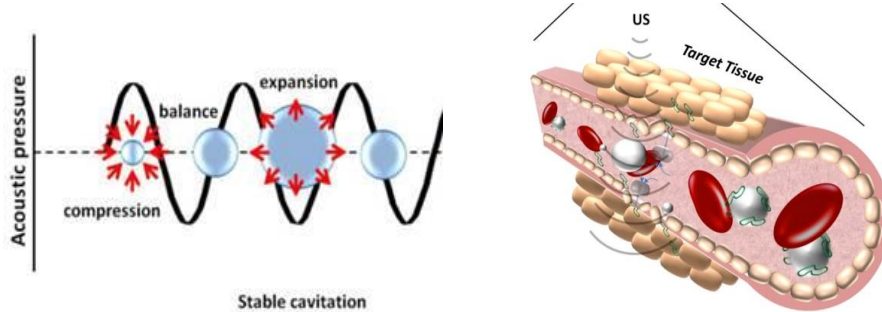

MRI @ **NeuroSpin**

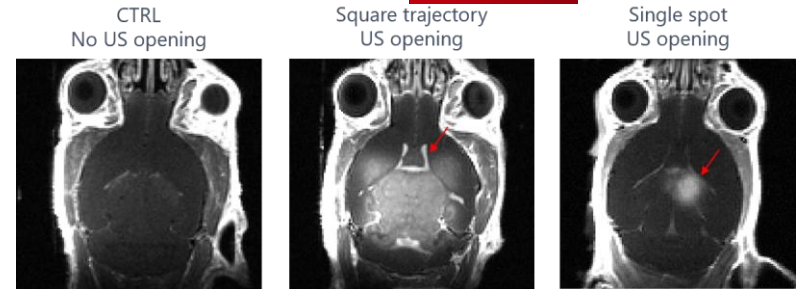

PTT and PA Temperature monitoring

Preliminary in vivo study
(subcutaneous)

Temperature monitoring with PA with NPs

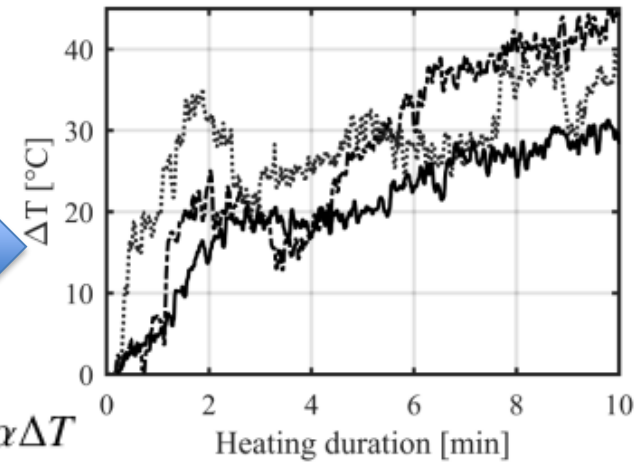

$$p_0(\mathbf{r}) = \Gamma(\mathbf{r})\mu_a(\mathbf{r})\Phi(\mathbf{r}, \mu_a(\mathbf{r}), D(\mathbf{r}))$$

$$\Gamma(\mathbf{r}) = \frac{\beta v_s^2}{c_p} = f(T) = A + B \times T \quad \Leftrightarrow \quad \frac{\Delta P}{P_0} = \alpha \frac{\Delta \Gamma}{\Gamma_0} = \alpha \Delta T$$

Numerical tool : Building of a realistic phantom of a mouse's head...

Objective : estimation of important parameters of a successful therapy

Creation of the phantom through coregistration methods of open-sources atlases [1,2,3,4]

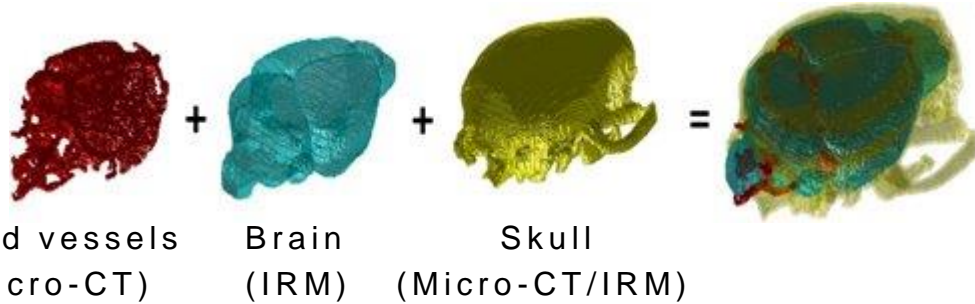

Possibility to mimic experimental setup's configuration

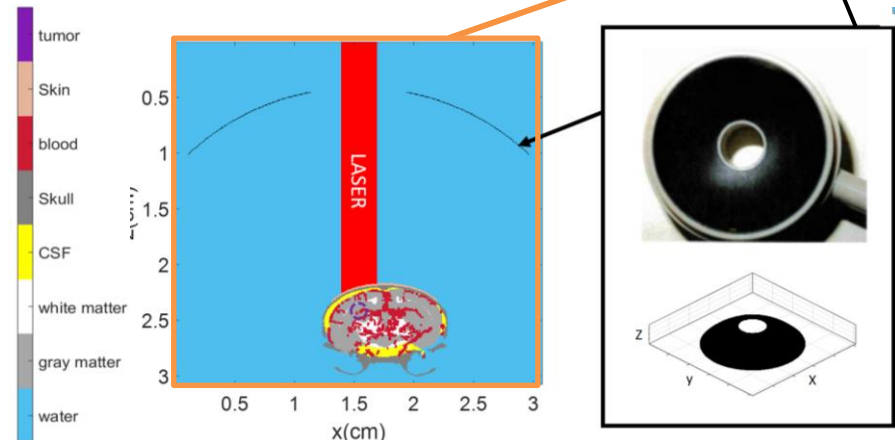
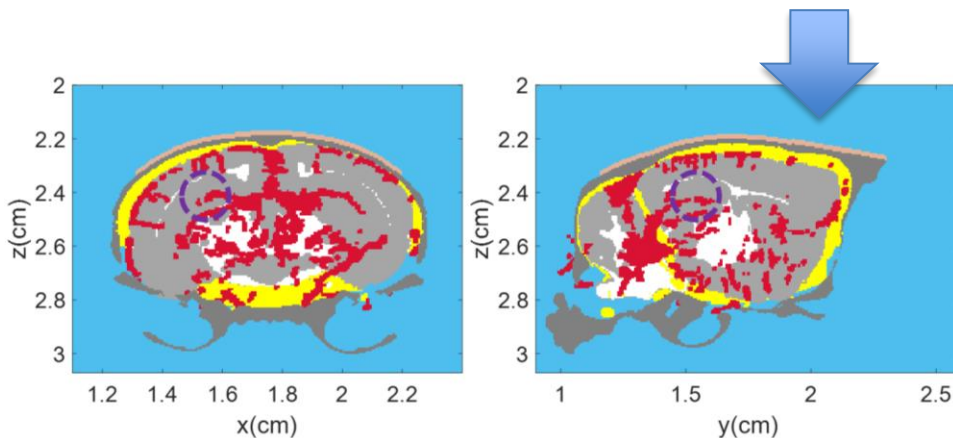
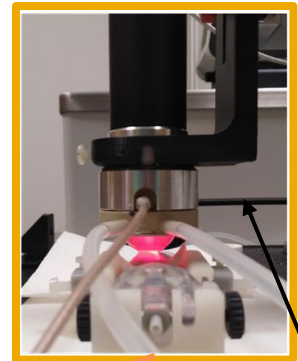

1. Y. Ma et al., Neuroscience135, 1203–1215 (2005)
2. Liu, Yuming et al., Biomedical Optics Express 6, no 12 (1 December 2015): 4859.
3. E. Chan et al., Neuroscience144, 604–615 (2007).
4. A. Dorr et al., NeuroImage35, 1409–1423 (2007).

... which allow for multi-physical simulations

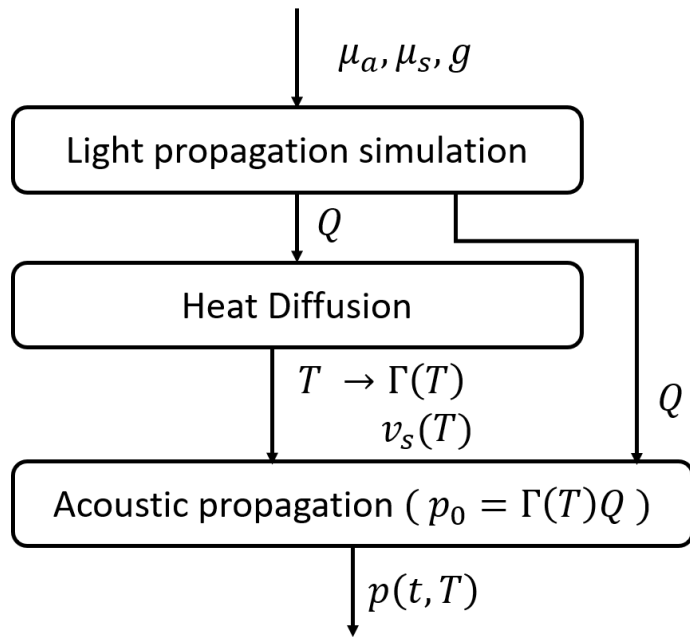

Flow chart of simulations

Monte Carlo (mcxyz.c [1]) for light propagation simulations / k-wave toolbox [2] for heat simulations and acoustic waves propagation

Multi-physical parameters for simulations

Optical + acoustic + thermal parameters taken from multiple sources in literature

Temperature dependent parameters were taken into account

$$\Gamma(T) = \frac{\beta(T)v_s^2(T)}{C_p}$$

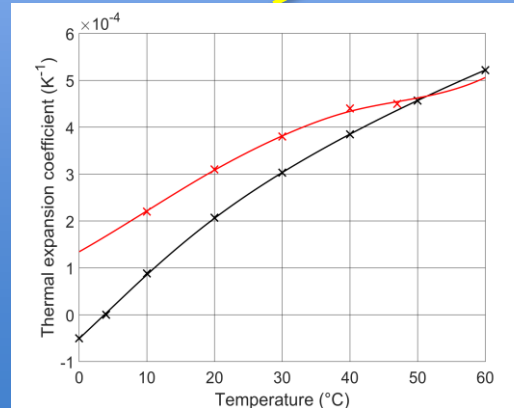

Thermal expansion coefficient for blood (red) and water (black)

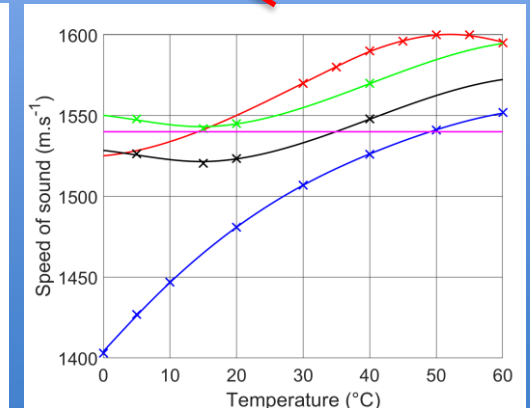

Speed of sound in tissues of the phantom

[1] : S. L. Jacques, Photoacoustics2, 137-142 (2014)
 [2] : B. E. Treeby et al., J. Biomed. Opt.15, 021314 (2010)

Example of simulations' results

1. Modelling temperature evolution

Heat deposition rates calculated from light propagation simulations with NPs effect

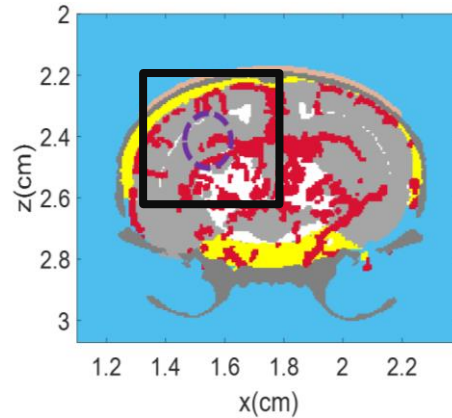

Allows calculation of

Temperature evolution at the surface of the tumor calculated from heat diffusion simulations

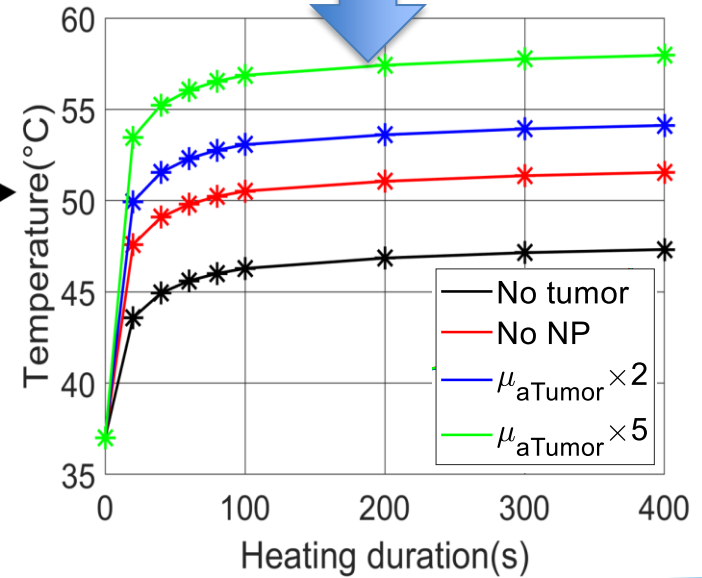
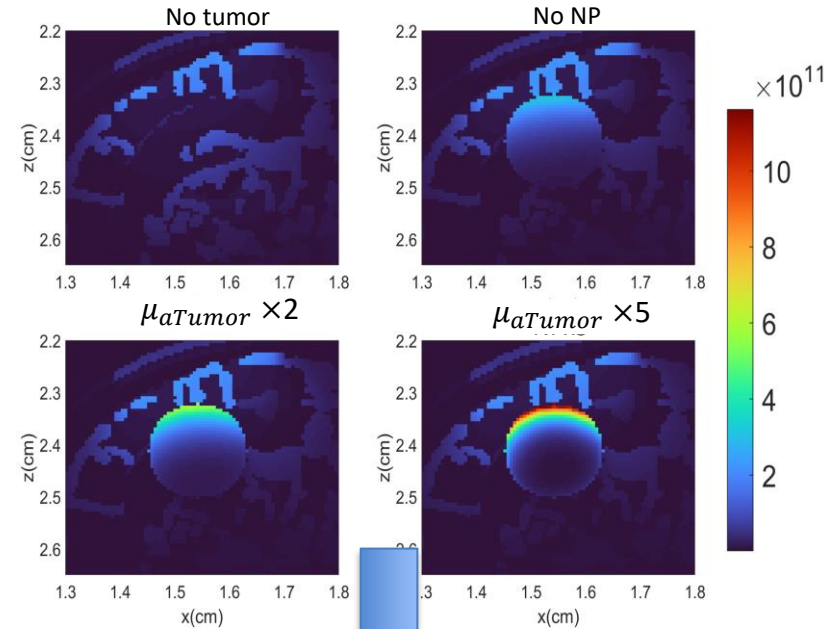
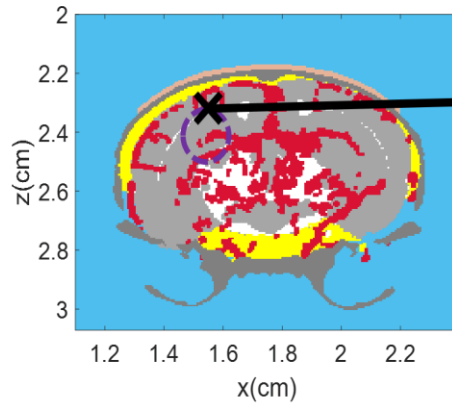

2. Quantify thermal damages

Thermal doses calculated (CEM43 units):
if reach thermal threshold = tissue burnt

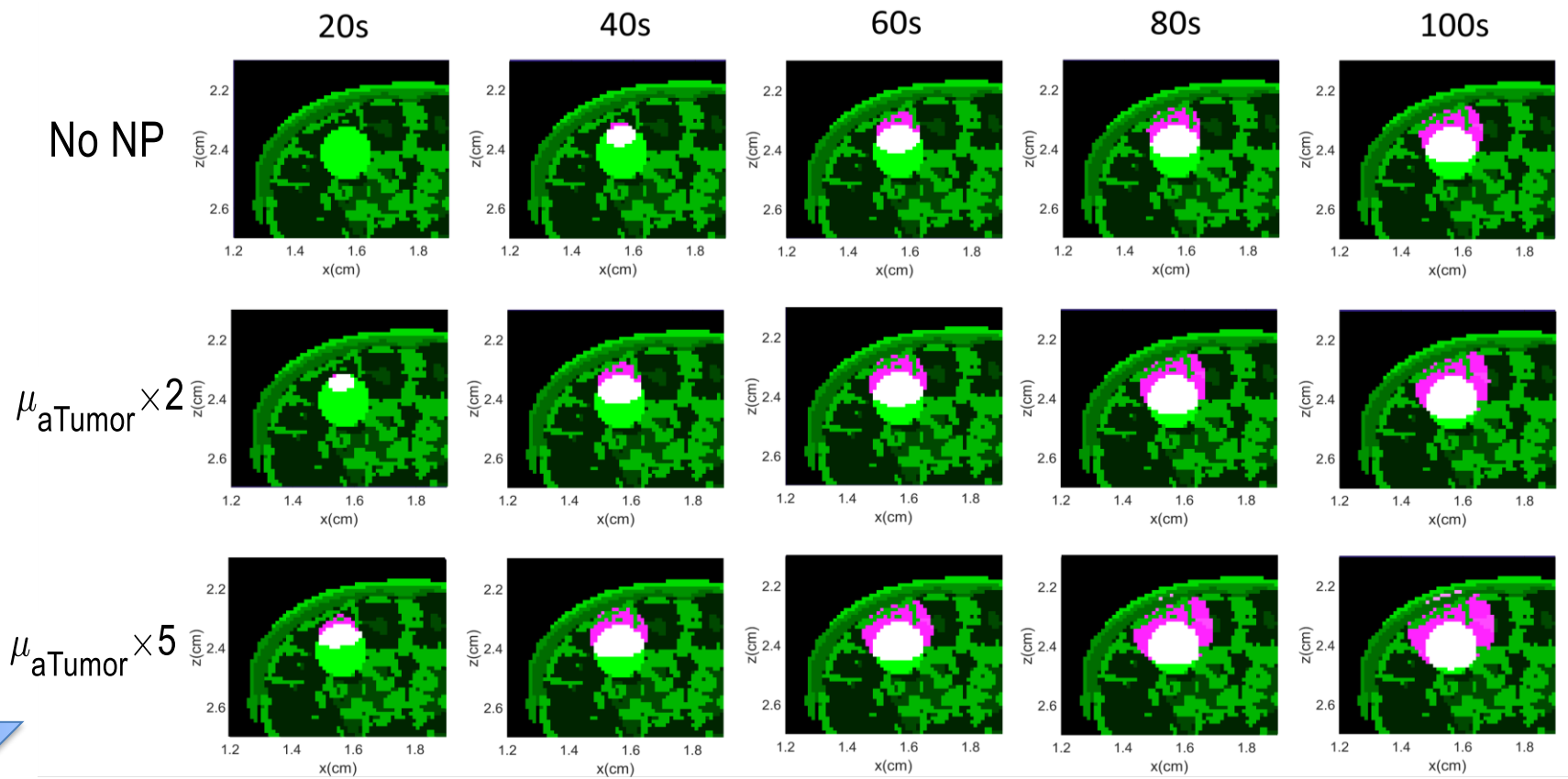

3. Photoacoustic temperature monitoring

Pressure rise in the phantom at the beginning of therapy:

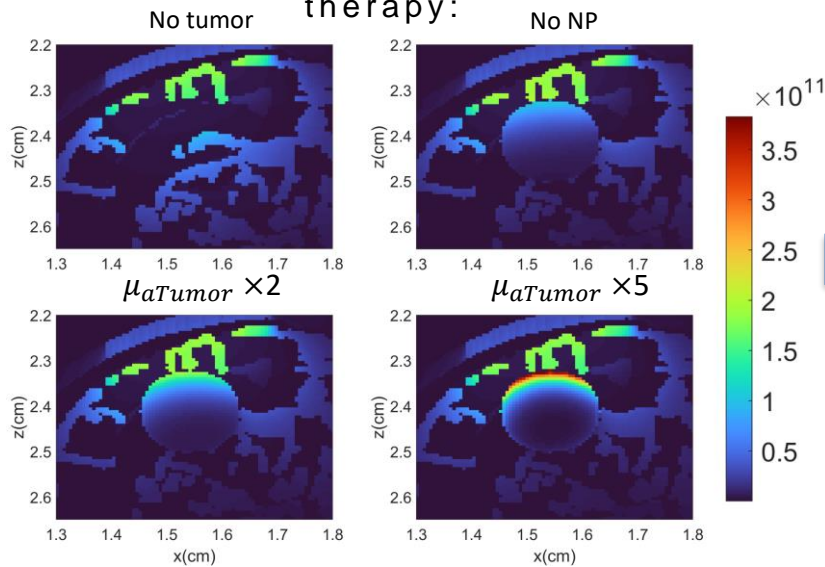

Associated photoacoustic signals obtained:

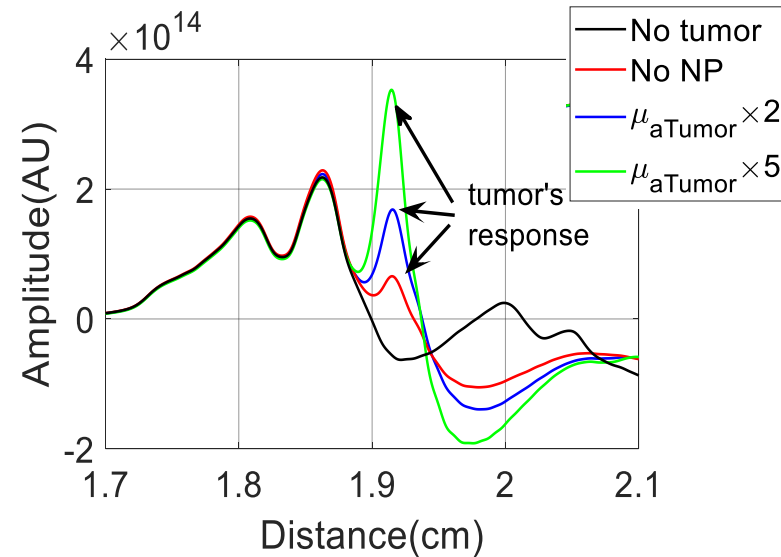

Therapy begins => $T \uparrow$ => PA signals variations

Tumor temperature monitoring results

$$\frac{\Delta p}{p_0} = \alpha \Delta T$$

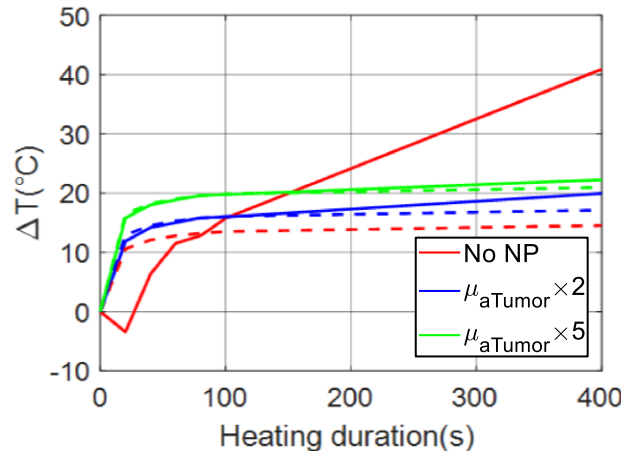

Not accurate without NP !

Conclusions

- An original multipurpose integrated setup has been developed for PTT of the glioblastoma in small animals: BBB Opening+PTT+PA temperature monitoring.

⇒ Khaled Metwally et al., “Development of a Multi-Functional Preclinical Device for the Treatment of Glioblastoma,” *Biomedical Optics Express* 12, no. 4 (April 1, 2021): 2264

- A useful numerical tool to help guide photothermal therapies in the choices of the key parameters.

⇒ Antoine Capart et al., “Multiphysical Numerical Study of Photothermal Therapy of Glioblastoma with Photoacoustic Temperature Monitoring in a Mouse Head,” *Biomedical Optics Express* 13, no. 3 (March 1, 2022): 1202

- Future improvements of the numerical model :

- Change of optical properties as PTT progresses (necrosis...)
- Regrowth of the tumor considered (in the case of multiple PTT illuminations periods)
- NPs' effect on the scattering properties of the tumor addressed
- ...

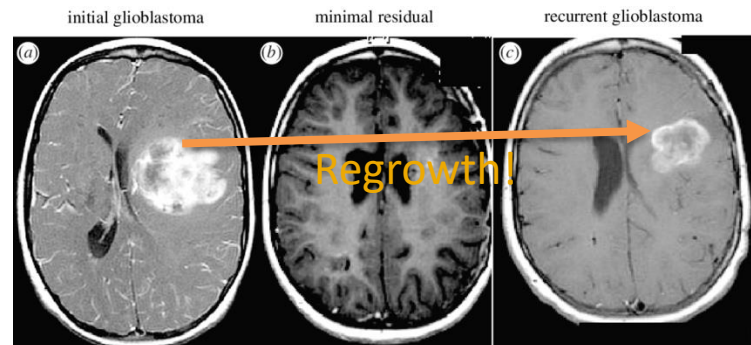
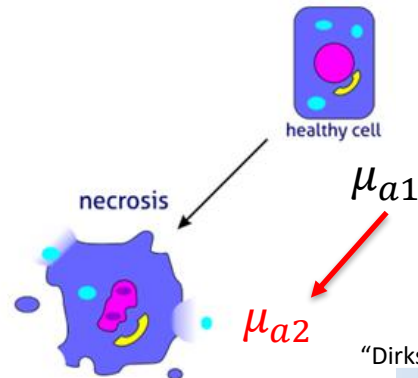

“Dirks, Peter, *Philosophical transactions of the Royal Society of London. Series B, Biological sciences* (2008).”