



HAL
open science

Funicularity of conics

Xavier Tellier, Cyril Douthe, Laurent Hauswirth, Olivier Baverel

► **To cite this version:**

Xavier Tellier, Cyril Douthe, Laurent Hauswirth, Olivier Baverel. Funicularity of conics. *Acta Mechanica*, 2021, 232 (8), pp.3179-3191. 10.1007/s00707-021-02987-6 . hal-03750177

HAL Id: hal-03750177

<https://hal.science/hal-03750177v1>

Submitted on 11 Aug 2022

HAL is a multi-disciplinary open access archive for the deposit and dissemination of scientific research documents, whether they are published or not. The documents may come from teaching and research institutions in France or abroad, or from public or private research centers.

L'archive ouverte pluridisciplinaire **HAL**, est destinée au dépôt et à la diffusion de documents scientifiques de niveau recherche, publiés ou non, émanant des établissements d'enseignement et de recherche français ou étrangers, des laboratoires publics ou privés.

Funicularity of conics

Xavier TELLIER*^{a b}, Cyril DOUTHE^a, Laurent HAUSWIRTH^b, Olivier BAVEREL^{a c}

*^a Laboratoire Navier, Ecole des Ponts, CNRS, Université Gustave Eiffel
77455 Champs-sur-Marne - France

xavier.tellier@enpc.fr

^b Laboratoire d'Analyse et de Mathématiques Appliquées, UGE, UPEC, CNRS, Champs-sur-Marne, France

^c GSA / ENS Architecture Grenoble, France

Abstract

Funicular structures can resist a given load with pure axial forces, and therefore tend to use material very efficiently. One main challenge in their design is the form-finding, which often requires advanced numerical methods. In this article, we show analytically that a very common family of curves, conics, is funicular for a particular load case: a uniform radial load emanating from a focus (Figure 1). The result is a generalization of the well-known funicularity of parabolas and arcs of circles, respectively under uniform vertical load and constant normal pressure. It can be used to design self-stressed structures by hand without the need for calculations. Portions of conics can be combined to obtain original shapes.

Keywords: Funicular structures, conics, self-stressed structures, tensegrity, spoke wheel

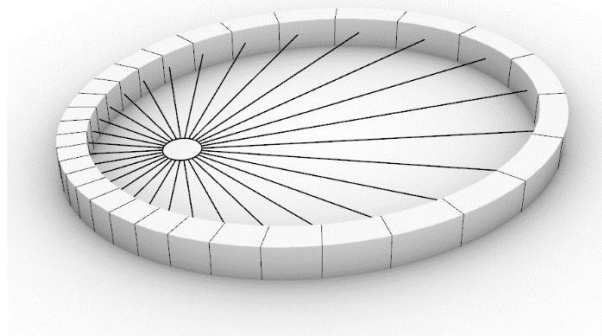

Figure 1: An elliptical arch tensioned by radial cables emanating from a focal point, with constant cable tension and constant angle between cables, is funicular.

1. Introduction

Funicular structures have been abundantly researched since the XVIIIth century and Hook's hanging chain. As they are able to resist a given load without bending or shear, they tend to use less material, thus minimizing cost and embodied energy. With materials such as masonry or cables, funicularity is necessary due to the low bending resistance.

Funicular curves

Even though the research on funicular structures focuses nowadays on structures with complex connectivity (Lee *et al.* 2015; Ohlbrock and Schwartz 2016), or complex geometry such as shells (Block 2009; Vouga *et al.* 2012; Liu *et al.* 2013; Tellier *et al.* 2018, 2020), a historical problem has been the design of funicular line elements. This question is of particular importance for the design of suspension cables and masonry arches (Heyman 1997). The most common method to draw funicular curves for a

33 particular load configuration is graphic statics, using the reciprocal force diagram (Cremona 1890). This
34 method can be done by hand drawing or by scripting a parametric CAD software, and is still commonly
35 used to teach structures in architecture schools.

36 Analytical funicular curves are widely used by designers, especially in conceptual design phases. The most
37 well-known examples are the circles, parabolas and catenaries, which are respectively funicular for a
38 uniform normal pressure, a constant vertical load, and self-weight (in the case of a constant section).
39 These primitives sometimes serve directly as the geometry of the final structure. For example, the Gateway
40 arch in Saint Louis, Missouri, is a modified catenary, and the arch of the Bixby Creek Bridge in California
41 is a parabola (Figure 3). These primitives are however also often used as mechanical models. For example,
42 it is common to approximate arches and sagging cables as parabolas to estimate internal forces.

43 Analytical funicular curves can be found for a wide variety of loading configurations, beyond the ones of
44 the circles, parabola and catenary. (Dennis 1994) shows that these three curves are solutions of a same
45 one-parameter family of differential equations. By varying this parameter, he obtains a new curve which
46 is funicular for a peculiar load case. Funicular curves for hydrostatic pressure were investigated in (Gavin
47 and Reilly 2000; Wang and Wang 2002; Fung 2003), a potential application being section design for a
48 tunnel lying on the seabed. (Wang and Wang 2015) considered a superposition of a uniform vertical load
49 with self-weight. The shape of a cable dragged by two boats and subject only to viscous forces was found
50 in (Simpson and Tabarrok 1976) to be a catenary. (Hill *et al.* 1979) derived the shape of an arch which is
51 funicular under self-weight and with constant axial stresses: the solution has varying section depth, and
52 is therefore not a catenary.

53 **Self-stressed structures**

54 Funicular structures are often lightweight. As a consequence, their dead load is in general not dominant
55 in comparison to live loads, including in particular wind suction and asymmetrical load scenarios. A
56 common solution to maintain stability under such conditions is prestressing. In structures such as cable
57 nets or membranes, prestressing is also necessary to obtain sufficient stiffness. This is particularly true
58 for tensegrity structures, which are especially effective for long span envelopes. A notable example is the
59 185m-wide roof of the Georgia dome in Atlanta (Figure 2), built in 1992, or the more recent Bao'an
60 stadium in Shenzhen.

61 (Todisco and Corres 2018) highlight another potential use for self-stressing in arches. For architectural
62 purposes, the shape of an arch might not be funicular under self-weight. The traditional solution is then
63 to resort to bending resistant systems. However, if external loads are added to the arch, a pure
64 compression state can be achieved, such that it can be built in masonry. A famous example is the Pavilion
65 of the Future at the 1992 Sevilla Expo, designed by Peter Rice (Figure 2, right): Circular arches, which are
66 not funicular under self-weight, have been made funicular by superimposing a state of self-stress.

67 Form-finding of self-stressed structures is challenging as the load path is not linear anymore. Numerical
68 tools such as force density (Schek 1974) or dynamic relaxation (Otter *et al.* 1966) are often required.
69 However, analytical models are also commonly used at conceptual design stages. One common analytical
70 model is the spoke-wheel diaphragms: circular arches can be prestressed funicularly by radial spokes with
71 constant tension. Such a system is used notably to brace the gridshell of the Hamburg history museum
72 (Schober 2015). A graphical construction method to obtain other shapes than circles in a spoke-wheel
73 structure is proposed in (Tamai 2019).



Figure 2: Self-stressed structures. Left: Pavilion of the Future at the 1992 Sevilla Expo. Right: Georgia dome

Conics

Circles and parabolas, discussed earlier, are special types of conics: they correspond to sections of cones by planes. Conics are commonly used in design. For example, Paris subway stations have an elliptical cross section. Ellipses can be constructed geometrically with a pen and a piece of rope, a property which was highly valuable before the advent of digital tools. They are however still used today, for example in the geometry of the beams of the Hangar-7 in Salzburg (Figure 3). The minimum thickness of an elliptical masonry arch subject to self-weight is studied in (Alexakis and Makris 2013). Ellipses can also be obtained by applying an affine transformation to a circle. As affine transformations transform a self-stressed geometry into another self-stressed geometry (Rankine 1858), one simple way to obtain a self-stressed elliptical arch is to apply an affine transformation to a circular spoke-wheel (i.e. applying a “1D-scaling”). More generally, any projective transformation of a funicular structure conserves its equilibrium, a point that was recently explored for design applications in (Fivet 2016). Applying such deformations to spoke-wheels, one obtains an elliptical wheel in which spokes converge to a point which is not the ellipse centroid.

Hyperbolas also often appear in double-curvature structures. They are the cross sections of hyperboloids of revolution, such as the Water Tank in Novgorod (Figure 3), which popularity is due to the fact that they can be built from straight beams.



Figure 3: Examples of conics in architecture, respectively ellipses, parabola, and hyperbolas

Left: Hangar-7, Salzburg (tilted ellipsoid) (©F412)

Middle: Bixby Creek Bridge, California (©Reverie Rambler)

Right: Water Tank in Novgorod by Vladimir Shokhov

Contributions

Section 2 of this paper shows how the well-known funicularity of circles and parabolas can be generalized to any conic. This funicularity is obtained for a particular load, called a uniform radial load. Axial forces can be obtained from a simple analytical formula. Section 3 shows how this result can be applied to discrete conics, with a direct application to cable fan diaphragms. Section 4 demonstrates how these

103 results can be used for the conceptual design of self-stressed structures. Finally, section 5 discusses the
 104 limitations and potential future work.

105 2. Funicularity

106 2.1 Geometry of conics

107 In this section, we briefly review the geometry of conics. A thorough exploration of conics properties can
 108 be found for example in (Glaeser *et al.* 2016). As illustrated in Figure 4, a conic can be parametrized in
 109 polar coordinates as follows:

$$r(\theta) = \frac{p}{1 + e \cos \theta} \quad (1)$$

110 Where:

- 111 • The point $r = 0$ is a focus of the conic;
- 112 • p is the distance between this focus and the point at angle $\pi/2$: $p = r(\pi/2)$;
- 113 • e is the eccentricity. Its value determines the type of the conic. More precisely, the conic is:
 - 114 ▪ A circle if $e = 0$;
 - 115 ▪ An ellipse if $0 < e < 1$;
 - 116 ▪ A parabola if $e = 1$;
 - 117 ▪ A hyperbola if $e > 1$.

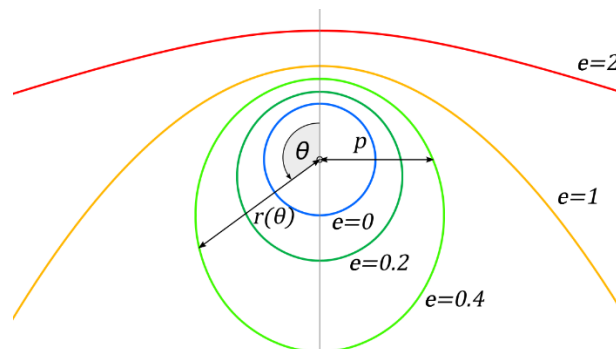

118
 119 **Figure 4: Geometry of conics**

120 2.2 Equilibrium

121 This article considers a particular type of load, defined as follows:

122 **Definition**

123 A *uniform radial load* centered on a point F is a load distributed on a curve such that:

- 124 • At any point, the load direction is aligned with the line between this point and F;
- 125 • The angular pressure q (in kN/rad) from the focal point is constant. This means that the load
 126 amplitude on an elementary segment of aperture $d\theta$ is $qd\theta$ (see Figure 5).

127 The core of the contribution is the following proposition:

128 **Proposition 1**

129 A cable with conic geometry is funicular under a uniform radial load centered on a focus. The tension
 130 force in the cable is given, for a conic of eccentricity e , by:

$$T = q\sqrt{e^2 + 2e \cos \theta + 1} \quad (2)$$

131 where θ is defined as in equation (1). The tension does not depend on the value of p .

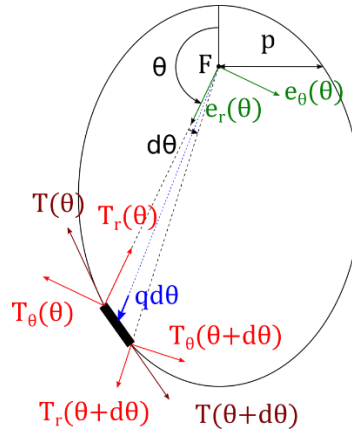

132

133

Figure 5: Equilibrium of an elementary segment of ellipse under a focal load.

134 **Proof:**

135 Let us consider a cable for which the reference curve is a conic given by equation (1). We introduce the
136 local orthogonal frame polar frame $(\mathbf{e}_r, \mathbf{e}_\theta)$.

137 Let us consider a uniform radial load emanating from a focal point: a segment of aperture $d\theta$ is subjected
138 to a load $q d\theta \mathbf{e}_r$ where q is constant. We look for an admissible tension field \mathbf{T} in the cable, of amplitude
139 T . We decompose the tension into its radial part T_r and its orthoradial part T_θ , such that
140 $\mathbf{T} = T_r \mathbf{e}_r + T_\theta \mathbf{e}_\theta$.

141 Notation

142 For functions depending on θ , we omit the mention of θ when they are evaluated at θ : $r(\theta) = r$. When
143 evaluating the function at a first-order angle increment $\theta + d\theta$, we write the first order development
144 $r(\theta + d\theta) = r + dr$

145 Analysis

146 Let us look at the equilibrium of an infinitesimal portion of arch of aperture $d\theta$. The tension field must
147 verify equilibrium of moments about the focal point. Keeping only the first order terms, this equilibrium
148 reads:

$$149 \quad r T_\theta = (r + dr)(T_\theta + dT_\theta)$$

$$150 \quad \frac{dT_\theta}{T_\theta} = -\frac{dr}{r}$$

151 After integration:

$$152 \quad T_\theta = \frac{C}{r}$$

153 Where C is a constant, homogenous to a torque.

154 The tension field must also verify the radial equilibrium (i.e. the equilibrium projected on \mathbf{e}_r), which reads
155 at first order:

$$156 \quad q d\theta + T_r(\theta + d\theta) - T_r(\theta) - T_\theta(\theta + d\theta)d\theta = 0$$

$$157 \quad dT_r = (T_\theta(\theta) - q) d\theta$$

158 Using equation (1):

$$159 \quad dT_r = \left(\frac{C}{p} (1 + e \cos \theta) - q \right) d\theta$$

160 Integrations yields:

$$T_r = T_0 + \left(\frac{C}{p} - q\right)\theta + \frac{Ce}{p} \sin \theta$$

Where T_0 is a constant. To obtain a periodic tension field, we must have $C = qp$. As a result:

$$T_r = T_0 + qe \sin \theta$$

And T_θ must be of the form $T_\theta = q(1 + e \cos \theta)$

Finally, the tension must fulfill the orthoradial equilibrium (i.e. the equilibrium projected on \mathbf{e}_θ). Again, we discard all second order terms:

$$\begin{aligned} -T_\theta(\theta) + T_\theta(\theta + d\theta) + T_r(\theta + d\theta)d\theta &= dT_\theta + T_r d\theta \\ &= (-qe \sin \theta + T_0 + qe \sin \theta)d\theta \end{aligned}$$

We have equilibrium if $T_0 = 0$.

Synthesis

We have found a tension field $\mathbf{T} = T_r \mathbf{e}_r + T_\theta \mathbf{e}_\theta$ with:

$$\begin{aligned} T_r &= qe \sin \theta \\ T_\theta &= q(1 + e \cos \theta) \end{aligned}$$

This field is at equilibrium with the load. Let us now check that it is aligned with the cable. The cable orientation is given by the tangent vector, which is given in polar coordinates by:

$$\mathbf{t} = \frac{dr}{d\theta} \mathbf{e}_r + r \mathbf{e}_\theta = \frac{e \sin \theta}{1 + e \cos \theta} r \mathbf{e}_r + r \mathbf{e}_\theta$$

We check collinearity by calculating the cross product:

$$\|\mathbf{T} \wedge \mathbf{t}\| = \left\| qe \sin \theta r - (q(1 + e \cos \theta)) \frac{e \sin \theta}{1 + e \cos \theta} r \right\| = 0$$

The tension field is indeed aligned with the cable.

The value of the tension is given by $T^2 = T_r^2 + T_\theta^2$, such that we recover equation (2):

$$T = q\sqrt{e^2 + 2e \cos \theta + 1}$$

We remark that the square root is always well defined:

$$e^2 + 2e \cos \theta + 1 \geq e^2 - 2e + 1 = (e - 1)^2 \geq 0 \quad \blacksquare$$

Case of the circle

We remark that this formula yields the classical results for tension in circles, for which $e = 0$. Indeed, we then get $T = q$. We can convert the angular load q into a normal line load μ (in kN/m) by considering at a portion of arc of length ds :

$$\mu ds = q d\theta \Rightarrow \mu = q \frac{d\theta}{ds} = q/R$$

Where R is the curvature radius. We obtain: $T = \mu R$, a well-known formula.

Hyperbolas

Hyperbolas have two branches. In formula (1), the branch closest to the focal point is reached with a positive radius, while the other branch corresponds to a negative radius (Figure 6). For this last branch, because of the negative radius, the repulsive radial force actually acts as an attracting load. The formula (2) gives a tension force which corresponds to this attracting load. If we consider the actual repulsive load, the force in equation (2) corresponds to a compression force in the bottom branch.

Discussion

The proposition is formulated for a repulsive load, which gives a conic in tension. It can also be applied to an attracting force, in which case the conic is in compression, with a compression amplitude given by (2).

This proposition implies that any non-circular conic is funicular under two different load cases, one for each focal point. Ellipses and hyperbolas have two well defined foci. The parabola has only one. However, the well-known case of a uniform vertical load can be seen as a uniform radial load emanating from a focus at infinity.

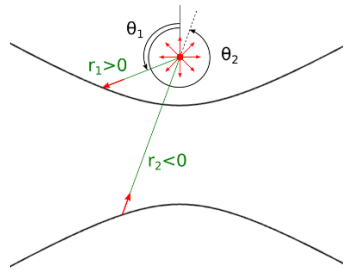

Figure 6: The two branches of a hyperbola

2.3 Force distribution

This section discusses the distribution of axial forces given by equation (2). Figure 7 shows this distribution for ellipses of various eccentricities. On a circle, a uniform radial load results in uniform tension. As the eccentricity is increased, tension at the apex closest to the focus increases, while tension at the opposite apex decreases. For a parabola, the tension is maximum at the apex, and decreases, with a limit of 0 at infinity (which corresponds to $\theta = \pi$). This behavior is opposite to the case of a uniform vertical loading, for which the axial force is minimal at the apex.

Hyperbolas are shown in Figure 8. The two branches have opposite curvature signs. As a result, the branch closer the focal point resist the load in tension, while the one further away works in compression. As the eccentricity is increased, the axial force becomes more and more uniform, but with an increasing amplitude.

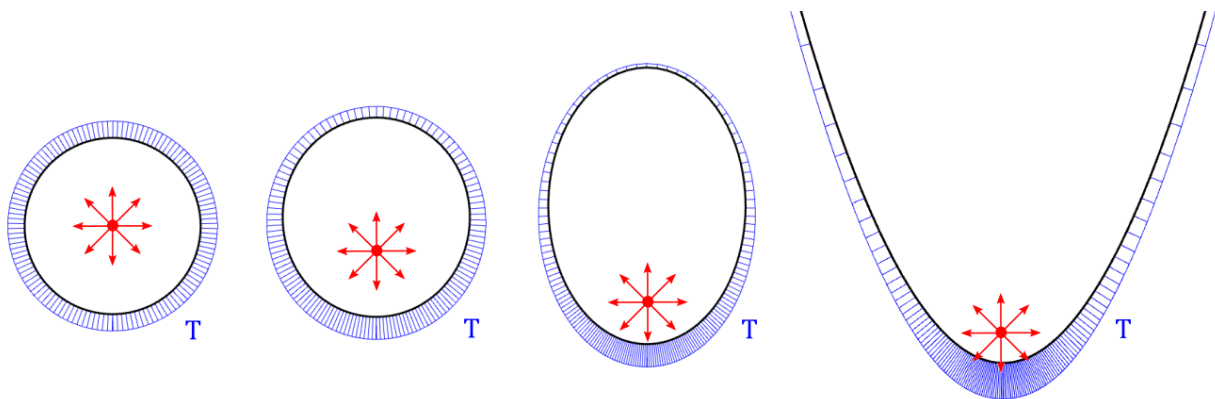

Figure 7: Distribution of tension for ellipses of various eccentricities and for a parabola

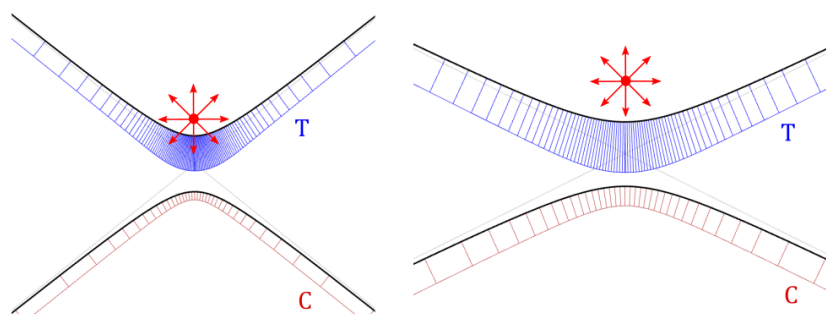

Figure 8: Distribution of tension and compression in hyperbolas with two different eccentricities

3. Discrete model

A uniform radial load is a rather abstract load case. However, it can be readily applied in a discrete form with a radial fan of cables with constant angle between two adjacent cables and constant cable tension. This discretization naturally introduces the discrete conic model of (Tsukerman 2015): As showed in Figure 9, the vertices of a discrete conic are defined as the intersection points of a smooth conic with rays emanating from a focal point with constant angle between adjacent rays. It turns out that this discrete conic model yields a simple discretization of the result of section 2:

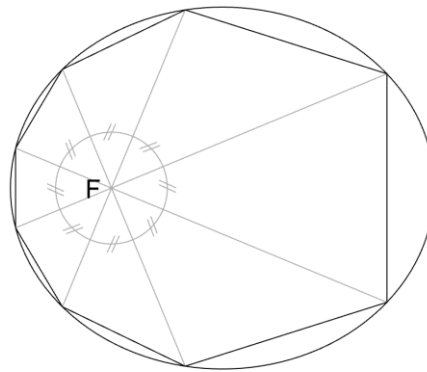

Figure 9: Discrete conic model

Proposition 2

Let us considered a polygon with vertices V_i inscribed in an conic of focus F, F° , such that the angles $\widehat{V_i F V_{i+1}}$ are constant (Figure 10). The polygon $V_1 \dots V_n$ is then funicular for a uniform tension applied in cables $V_i F$ (proper support still needs to be provided at the polygon extremities if it not closed).

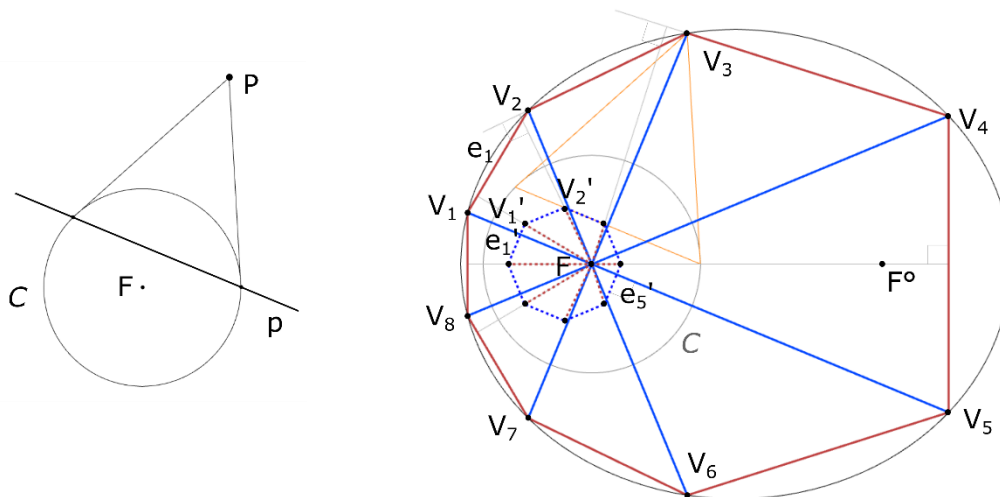

Figure 10: Left : Reciprocal duality. Right: a discrete conic (solid red)

Proof:

We base our proof on the approach and results of (Tsukerman 2015). We use the concept of reciprocal duality with respect to a circle. Referring to Figure 10 (left), a reciprocal duality transforms a point P into a line p, and reciprocally the line p into the point P, such that the line p is the one passing through the tangency points of the tangents to the circle passing through P. The construction is also defined via inversions if the point is insider the circle – see (Tsukerman 2015). An important aspect is that, in any

244 case, the line p is perpendicular to the line (PF) . We define the reciprocal duality d with respect to a circle
 245 C centered at the focus F of the conic – the radius of the circle is arbitrary. As shown by Tsukerman, the
 246 reciprocal dual lines of the vertices V_i define the edges of a regular polygon $V_1' \dots V_n'$, in which V_j' is the
 247 reciprocal dual of the edge e_j of the discrete conic. The construction of edge e_3' from V_3 is shown in orange.

248 By construction: the line (FV_i) is perpendicular to e_i' for any i , and the edge e_j is perpendicular to the line
 249 FV_j' for any j . Hence, up to rotation of 90° , the polygon $V_1' \dots V_n'$ and the segments FV_j' form a valid
 250 reciprocal force diagram. The axial force in a ray FV_i is represented by the length of the edge e_i' . Since
 251 $V_1' \dots V_n'$ is a regular polygon, the axial force in the rays FV_i is hence constant. ■

252 **Remark 1:** In a more general way, the application of reciprocal dualities for structural design is explored
 253 in (Konstantatou *et al.* 2018)

254 **Remark 2:** As proven in (Micheletti 2008), the reciprocal diagram of a self-stressed structure also
 255 corresponds to the geometry of a self-stressed system. Consequently, the regular polygon $V_1' \dots V_n'$ with
 256 the rays FV_j' form together a self-stressed structure.

257 4. Design applications

258 Radial loads are not encountered in nature: self-weight, snow, or wind loads rarely correspond to this
 259 distribution. However, as discussed in section 3, they do correspond to the tension induced by radial
 260 cables with constant tension and constant angle, such as the spokes of a bike wheel. As detailed in section
 261 1, the design of prestressed systems is usually a complex task, which requires iterative numerical analysis.
 262 The result showed in sections 2 and 3 allows to design the equilibrium state of a certain family of self-
 263 stressed structures without any computational effort.

264 A first example is the elliptical arch showed in Figure 1. It is funicular under a prestressing imposed by
 265 cables emanating from a focal point – with constant angle between the cables and constant cable tension.
 266 Compression forces in the arch can be directly estimated from equation (2). The fact that cable tension is
 267 constant can simplify the prestressing procedure: If cables are connected to a circular cable, a simple way
 268 to insure that the radial tension is uniform is to check that the center cable is circular.

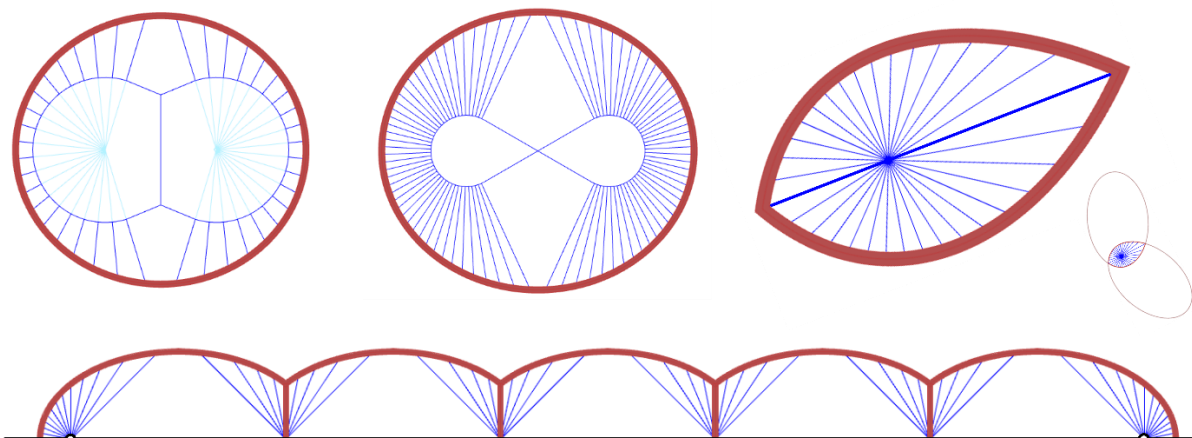

269

270

271

Figure 11: Self-stressed funicular structures composed of elliptical arches.
Red: Compression elements. Dark blue: Tension elements. Black: Supports

272 The fact that ellipses are funicular under two different load cases is used in Figure 11 (top left) to design a
 273 funicular arch prestressed from the two focal points. We use the fact that the two loads cases (one for each

274 focus) give the same axial force at the apex: this allows to pretension the left half from the left focus, and
 275 the right half from the right focus. An intermediate vertical cable is necessary to close the circular cables.
 276 For the sole purpose of structural delight, this geometry can be adjusted such that this vertical cable is not
 277 necessary – closing of cables being realized as an 8-loop (top middle image).

278 Arches from ellipses sharing a common focus but with axes at different angles can be joined as shown in
 279 the top right image. The two arches press against each other with the same force because of the symmetry.
 280 At the junction of the two arches, because of the lateral push of the arches, the cable takes more tension
 281 than its neighbours (it is hence depicted with a thicker blue line). Remarkably, this lateral push has the
 282 same value at both ends, despite their different slope. This is due to the fact that the projected tension on
 283 a radial axis (T_r) as a π -periodic amplitude. This allows the structure to be self-stressed without support.
 284 The bottom picture shows how ellipses can be joined in series. Bottom of piles are located at focal points.
 285 Only the extreme two foci need to withstand lateral loads. An interesting aspect of the proposition is that
 286 these structures were designed with simple geometrical rules.

287 The proposition also implies that parabolas are funicular for two load cases: the well-known uniform
 288 vertical force, and a radial load emanating from their focal point. The parabolic arch showed in Figure 12
 289 (top-left) is for example pretensioned radially from the focus. This allows the arch to resist live loads. As
 290 in Figure 1, radial cables are connected to a circular cable, which allows circulation under the arch.

291 Figure 12 (bottom left) shows a hyperbolic arch, prestressed by a hyperbolic cable. The two hyperbolas
 292 have a common focal point. Figure 12 (right) shows an arch composed of four arcs of hyperbola, with C1
 293 junctions. Each arc is funicularly prestressed by radial cables emanating from its focus. Thanks to the
 294 symmetry, the resultant forces at each cable fan can be balanced by the resultant at the opposite corner
 295 via a diagonal cable.

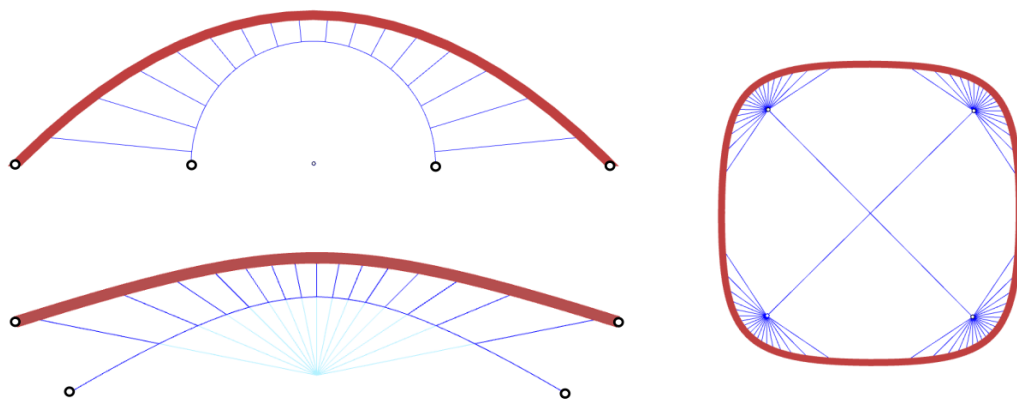

296
 297 **Figure 12: Self-stressed funicular structures composed of parabolas, hyperbolas and circles.**
 298 **Red: Compression elements. Dark blue: Tension elements. Black: Supports**

299 Tensegrity

300 The proposition can also be used to design non-planar self-stressed structures. Figure 13 shows two roof
 301 structures based on the tensegrity Geiger system, a typology for example used in the Olympic Fencing
 302 stadium in Seoul, Korea (1986) and in the Georgia dome shown in Figure 2. The left one is based on two
 303 ellipses with a common focus. The inner ellipse is offset vertically twice (once up, once down), and joined
 304 by vertical struts. Radial cables from the common focus are drawn with equal angles. This structure is
 305 funicular provided that the tension in the radial cables, once projected on the horizontal plane, is constant
 306 (as shown in the inset in Figure 13 left). The vertical equilibrium is guaranteed by the symmetry.

307 The right pictures on Figure 13 shows a more complex arrangement, based on three ellipses. Each ellipse
 308 shares a focus with the adjacent ellipses, but they do not have the same axis orientation. Contrary to the
 309 left structure, radial cables are spaced such that their anchor points on the outer compression ring are

310 equidistant. In order to obtain an equivalent smooth uniform radial load acting on the compression ring,
 311 the tension in the radial cables must be inversely proportional to the angle between the two adjacent
 312 spokes – tensions are hence not constant anymore. For the middle ellipse to remain in tension, the tension
 313 in the outer axial cables must be significantly higher than in the radial cables spanning between the small
 314 and the medium ellipse.

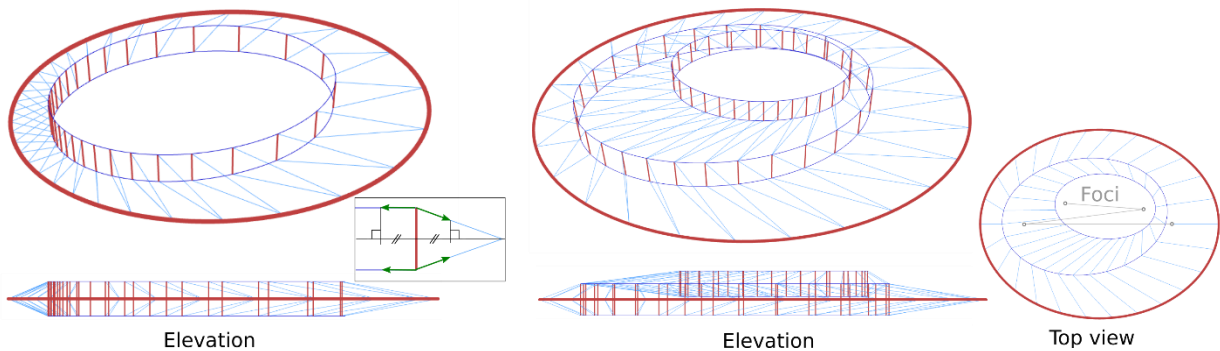

315

Elevation

Elevation

Top view

316

Figure 13: Tensegrity Geiger roof structures generated from conics sharing a focus.

317

Red: compression elements. Blue: tension elements.

318 **Line of thrust**

319 Proposition 2 allows to construct the thrust line representing the funicular equilibrium of a conic. It is of
 320 particular interest for the design of masonry arches, as simple rules can be applied to insure stability of
 321 the vaults (Heyman 1997). In particular, one can check that the thrust line remains within the middle
 322 third of the section under main load case.

323 This is demonstrated on the parabolic arch showed in Figure 14. A parabola is discretized by intersecting
 324 it with cables emanating from the focus at constant angles. This yields the red parabolic polyline (the
 325 thrust line), which is funicular for a constant tension from the cables. The initial parabola is then offset
 326 to create the geometry of masonry blocs of constant length. The arch is tied and simply supported on two
 327 columns. The vertical force which is necessary to balance the tension in the cable fan is symbolized by a
 328 hanging block. A system of pulleys is schematically suggested to insure that the tension in the eight top
 329 cables is constant.

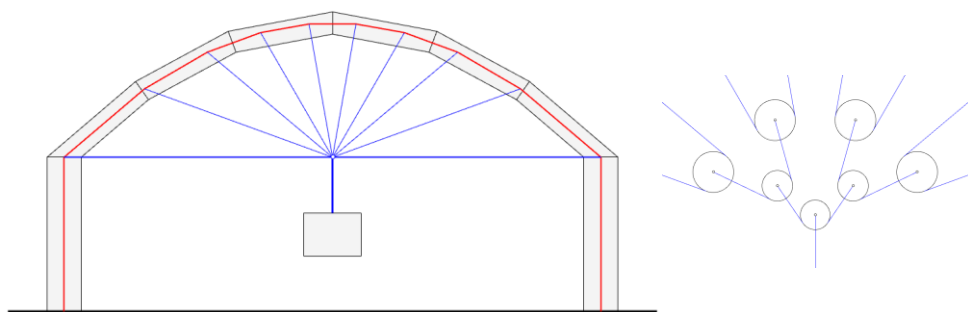

330

331 **Figure 14: A self-stressed parabolic masonry arch, and a system of pulleys that insures that cables have equal tension**

332 **Analogy with optics**

333 The proposed result evokes strongly the optical properties of mirrors shaped as conics. Inspired by this
 334 analogy, Figure 15 proposes a system to convert a radial fan of cables into an array of parallel cables. The
 335 junction can be realized by a funicular arc of parabola. Radial cables have constant tension and constant
 336 angle, parallel ones have constant spacing and constant tension (different from the radial cables tension).

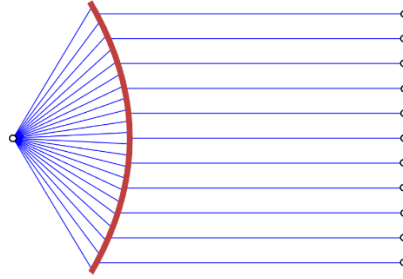

337
338 **Figure 15: Analogy with optics: reorienting radial cables into a parallel array with a parabolic funicular arch**

339 5. Discussion

340 This section discusses the scope and limitations of the present work and gives suggestions for future
341 research.

342 **Stability**

343 We have considered in this article only the axial forces under a prestressing load case. This information
344 gives a lower-bound on the cross-sectional area of the components. However, for a final design, stability
345 must be accounted for in the design of the compression elements.

346 Firstly, one needs to take into account for varying load conditions. In particular, one would need to obtain
347 a proper bending resistance. For a masonry arch, a sufficient thickness would also be needed to avoid the
348 apparition of a mechanism between the blocks.

349 Secondly, buckling should also be considered. In this respect, similarly to the case of the circular arc
350 subjected to uniform pressure treated in (Timoshenko and Gere 1961), proposition 1 might be used to
351 obtain analytical formulas for the buckling of conic-shaped arches. However, the result is likely to involve
352 elliptic integrals.

353 **Use in numerical solvers**

354 Another path to pursue would be to use the proposed analytical formula as an initialization for numerical
355 form-finding methods, a point which might help or speed-up convergence.

356 **Design abacus**

357 In order to design by hand conics and combinations of conics such as the ones showed in section 4, it is
358 useful to have a chart of confocal ellipses and hyperbolas, such as the one showed in Figure 16. Rays with
359 constant angle emanating from a focus are shown, such than one can visualize in one single figure a wide
360 variety of self-stressed structures. The potential of this method could be explored in future work or in
361 student workshops.

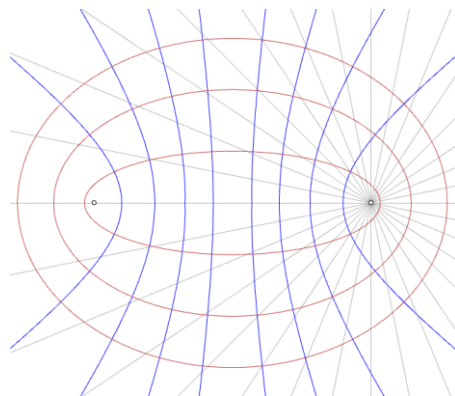

362
363 **Figure 16: A chart of confocal ellipses and hyperbolas**

6. Conclusion

364
365 Conics have a fascinating array of geometrical properties and physical applications. This article adds a
366 mechanical one to the list: Conics are funicular for a uniform radial load emanating from a focal point.
367 This result can be used to design a wide array of self-stressed funicular systems. These can be obtained by
368 hand, without calculation, which makes the result useful at conceptual design phases.

Declarations

Funding

370
371 This work is supported by Labex MMCD (<http://mmcd.univ-parisest.fr/>).

Conflict of interest/Competing interests

372
373 The authors have no conflict of interest to disclose.

Availability of data and material

374
375 Not applicable

Code availability

376
377 Not applicable

References

- 378
379 Alexakis, H., Makris, N. (2013) 'Minimum thickness of elliptical masonry arches', *Acta Mechanica*, 224,
380 2977–2991.
- 381 Block, P. (2009) *Thrust Network Analysis. Exploring Three-Dimensional Equilibrium*.
- 382 Cremona, L. (1890) *Graphical Statics: Two Treatises on the Graphical Calculus and Reciprocal Figures*
383 *in Graphical Statics*, Clarendon Press.
- 384 Dennis, N. (1994) 'On the formation of funicular curves', *International Journal of Mechanical Science*,
385 36(3), 183–188.
- 386 Fivet, C. (2016) 'Projective transformations of structural equilibrium', *International Journal of Space*
387 *Structures*, 31(2–4), 135–146.
- 388 Fung, T.C. (2003) 'Shapes of submerged funicular arches.', *Journal of engineering mechanics*, 129(1),
389 120–125.
- 390 Gavin, H.P., Reilly, K.J. (2000) 'Submerged funicular arches', *Journal of Structural Engineering*,
391 126(May), 627–629.
- 392 Glaeser, G., Stachel, H., Odehnl, B. (2016) *The Universe of Conics*, Springer Spektrum.
- 393 Heyman, J. (1997) *The Stone Skeleton: Structural Engineering of Masonry Architecture*, Cambridge
394 University Press.
- 395 Hill, R.D., Rozvany, G.I.N., Ming, W.C., Hwa, L.K. (1979) 'Optimization , Spanning Capacity , and Cost
396 Sensitivity of Fully Stressed Arches', *Journal of Structural Mechanics*, 7(4), 375–410.
- 397 Konstantatou, M., D'Acunto, P., McRobie, A. (2018) 'Polarities in structural analysis and design: n-
398 dimensional graphic statics and structural transformations', *International Journal of Solids and*
399 *Structures*, 152–153(July), 272–293, available: <https://doi.org/10.1016/j.ijsolstr.2018.07.003>.
- 400 Lee, J., Fivet, C., Mueller, C. (2015) 'Grammar-based generation of equilibrium structures through graphic
401 statics', in *Proceedings of the International Association for Shell and Spatial Structures*
402 *Symposium (IASS)*.
- 403 Liu, Y., Snyder, J., Wang, W. (2013) 'Computing Self-Supporting Surfaces by Regular Triangulation', *ACM*

- 404 *Transactions on Graphics*, 32(4).
- 405 Micheletti, A. (2008) 'On generalized reciprocal diagrams for self-stressed frameworks', *International*
406 *Journal of Space Structures*, 23(3), 153–166.
- 407 Ohlbrock, P.O., Schwartz, J. (2016) 'Combinatorial equilibrium modeling', *International Journal of*
408 *Space Structures*, 31(2–4), 177–189.
- 409 Otter, J., Cassel, A., Hobbs, R. (1966) 'Dynamic relaxation', in *Proceedings of the Institution of Civil*
410 *Engineers*, 633–656.
- 411 Rankine, W.J.M. (1858) *A Manual of Applied Mechanics*, London; Glasgow: Marion R Griffin & Co.
- 412 Schek, H.J. (1974) 'The force density method for form finding and computation of general networks',
413 *Computer Methods in Applied Mechanics and Engineering*, 3(1), 115–134.
- 414 Schober, H. (2015) *Transparent Shells: Form, Topology, Structure*, Ernst & Sohn.
- 415 Simpson, A., Tabarrok, B. (1976) 'Chain subjected to uniform fluid flow in a horizontal plane',
416 *International Journal of Mechanical Science*, 18, 91–94.
- 417 Tamai, H. (2019) 'Geometric approach to form finding of a spoke wheel system: Mathematical
418 explanations', in *Proceedings of the IASS Annual Symposium*, 692–699.
- 419 Tellier, X., Douthe, C., Hauswirth, L., Baverel, O. (2020) 'Linear-Weingarten membranes with funicular
420 boundaries', *Structural Concrete*, 1–14.
- 421 Tellier, X., Hauswirth, L., Douthe, C., Baverel, O. (2018) 'Discrete CMC surfaces for doubly-curved
422 building envelopes', in *Advances in Architectural Geometry*, 166–193.
- 423 Timoshenko, S.P., Gere, J.M. (1961) *Theory of Elastic Stability*, McGraw-Hill Books Company, New York
424 and London.
- 425 Todisco, L., Corres, H. (2018) 'New opportunities for the conceptual design of material-efficient
426 antifunicular structures', *Hormigón y Acero*, 69(284), 83–88.
- 427 Tsukerman, E. (2015) 'Discrete Conics as Distinguished Projective Images of Regular Polygons', *Discrete*
428 *and Computational Geometry*, 53(4), 691–702, available: <http://dx.doi.org/10.1007/s00454-015-9669-y>.
429
- 430 Vouga, E., Mathias, H., Wallner, J., Pottmann, H. (2012) 'Design of Self-supporting Surfaces', *ACM Trans.*
431 *Graph.*, 31(4).
- 432 Wang, C.M., Wang, C.Y. (2002) 'Funicular Shapes for Submerged Arches', *Journal of Structural*
433 *Engineering*, 128(2), 266–270.
- 434 Wang, C.Y., Wang, C.M. (2015) 'Closed-form solutions for funicular cables and arches', *Acta Mechanica*,
435 2226, 1641–1645.
- 436
- 437
- 438