



HAL
open science

Wind Turbine Tower Thickness and Blade Pitch Control Co-Design Optimization

Juan López Muro, Xianping Du, Jean-Philippe Condomines, Onur Bilgen,
Laurent Burlion

► **To cite this version:**

Juan López Muro, Xianping Du, Jean-Philippe Condomines, Onur Bilgen, Laurent Burlion. Wind Turbine Tower Thickness and Blade Pitch Control Co-Design Optimization. AIAA SCITECH 2022 Forum, Jan 2022, San Diego, United States. 10.2514/6.2022-1150 . hal-03746394

HAL Id: hal-03746394

<https://hal.science/hal-03746394>

Submitted on 7 Aug 2022

HAL is a multi-disciplinary open access archive for the deposit and dissemination of scientific research documents, whether they are published or not. The documents may come from teaching and research institutions in France or abroad, or from public or private research centers.

L'archive ouverte pluridisciplinaire **HAL**, est destinée au dépôt et à la diffusion de documents scientifiques de niveau recherche, publiés ou non, émanant des établissements d'enseignement et de recherche français ou étrangers, des laboratoires publics ou privés.

Wind Turbine Tower Thickness and Blade Pitch Control Co-Design Optimization

Juan López Muro^{*1,2}, Xianping Du^{†1}, Jean-Philippe Condomines^{‡2}, Onur Bilgen^{§1}, and Laurent Burlion^{¶1}

¹Rutgers, The State University of New Jersey, New Brunswick, NJ, 08901, USA

²ENAC, Université de Toulouse, Toulouse, 31055, France

Wind energy production is still a challenge, and improving the engineering practices in wind turbine design is crucial to overcome it. In a control co-design approach, as opposed to sequential design, one considers the interaction between subsystems and applies control concepts in the design process to obtain an optimal solution. This paper investigates control co-design optimization of a wind turbine blade and tower, where the power efficiency is aimed to be maximized while minimizing the system's total mass. Furthermore, bounds on the design parameters are defined to constrain structural loads to admissible values. The power efficiency can be improved by reducing the root mean squared value of the generator speed tracking error, and the mass can be modified by the tower thickness. A mixed control architecture of H_∞ and reference governors is proposed to design the wind turbine control system. The H_∞ technique reduces structural loads, and the use of reference governors improves the system's power efficiency and addresses actuator limitations. Finally, the benefits of the control co-design optimization method are shown.

I. Nomenclature

β	=	blade pitch angle	(deg)
λ	=	tip-speed ratio	(-)
ω_g	=	generator angular velocity	(rad/s)
ρ	=	air density	(kg/m ³)
θ_g	=	generator angular position	(rad)
θ_r	=	rotor angular position	(rad)
A_r	=	rotor swept area	(m ²)
b_b	=	blade damping coefficient	(Ns/m)
b_s	=	shaft torsional damping coefficient	(Nms/rad)
b_t	=	tower damping coefficient	(N/m)
C_q	=	torque coefficient	(-)
C_t	=	thrust coefficient	(-)
F_t	=	aerodynamic thrust force	(N)
h_t	=	tower top height	(m)
I_g	=	generator inertia	(kg.m ²)
k_b	=	blade stiffness coefficient	(Ns/m)
k_s	=	shaft torsional stiffness coefficient	(Nm/rad)
k_t	=	tower stiffness coefficient	(N/m)
k_t	=	tower stiffness coefficient	(N/m)
m_b	=	blade mass	(kg)
m_h	=	hub mass	(kg)
m_n	=	nacelle mass	(kg)
m_t	=	tower mass	(kg)

*Graduate Research Assistant, MAE Department, juan.lopezmuro(at)rutgers.edu

†Postdoctoral Researcher, MAE Department, xianping.du(at)rutgers.edu

‡Assistant Professor, Automatic Control, jean-philippe.condomines(at)enac.fr

§Associate Professor, MAE Department, o.bilgen(at)rutgers.edu, AIAA Member.

¶Assistant Professor, MAE Department, laurent.burlion(at)rutgers.edu, AIAA Senior Member.

N_g	=	gear ratio	(-)
r_b	=	blade radius	(m)
r_p	=	rotor center to blade center of pressure radius	(m)
T_g	=	generator electrical torque	(Nm)
T_r	=	rotor aerodynamic torque	(Nm)
v	=	wind speed	(m/s)
x_b	=	blade tip axial displacement	(m)
x_t	=	tower top axial displacement	(m)

II. Introduction

IN the last few decades, wind energy has become an attractive source of renewable energy. The interest and investment in wind turbine development have gained relevance and turned the wind energy into the fastest-growing energy source across the world. Nonetheless, the high cost of wind energy production is still a challenge, and improving engineering practices is crucial to overcome it [1].

An increasing number of authors have been investigating different wind turbine aspects, such as low- and mid-fidelity aerodynamic modeling [2], low- and high-fidelity structural analyses [3], and control co-design [4] for rotor blades of floating offshore wind turbines.

At present, the sequential design approach, by which one designs and optimizes each subsystem independently and progressively, predominates in engineering design. When considering a control co-design (CCD) approach, as opposed to the sequential, one takes into account the interaction between subsystems and applies control concepts in the design process, obtaining an optimal solution that may not be attainable by a sequential design [5].

The classic control strategy for wind turbine power production relies on the design of two independent controllers, namely the generator-torque and the collective blade-pitch controllers. For the design of these controllers, only the speed of the generator ω_g is of interest [6]. Therefore, a first-order model like the one in Eq. (1) considering the rotational inertia of the turbine J and both aerodynamic T_r and electrical T_g applied torques is sufficient [7].

$$\dot{\omega}_g = \frac{N_g}{J} (T_r - N_g J T_g) \quad (1)$$

Various methods have been shown to be successful in alleviating structural loads of the tower after designing model-based controllers [8] relying on such simple first-order model. However, these models do not consider the tower, and the load mitigation is usually a posteriori verification of the closed-loop system.

As opposed to the aforementioned classic control design strategy, the control co-design approach proposed in this paper not only aims to optimize the power efficiency but also to mitigate the loads on the structure. For this reason, a representative fourth-order model that also describes the dynamics of the main structural components of the wind turbine is derived. The proportional-integral (PI) legacy controller [9] is used to test the derived model in a closed-loop. Simulations with wind speeds varying in the 4 – 25 m/s range are performed and compared with OpenFast [10] simulations to validate the model.

In this paper, a mixed control architecture of the H_∞ method [11] and reference governors (RG) [12], [13] is proposed to co-design the control system of a wind turbine. Appropriate design of the weighting functions is crucial to synthesize a H_∞ controller that rejects external wind perturbations. Success in this challenging task reduces the system's structural vibrations and leads to lightweight structures. In addition, the effective use of RG's improves the system's power efficiency, and addresses actuator limitations.

The rest of this paper is structured in the following manner. Section III describes the modeling of the wind turbine. Section IV details the control architecture adopted for the CCD. The optimization problem is set up in Section V. The results are analyzed in Section VI. Finally, Section VII summarizes conclusions and discusses some future work on this topic.

III. Wind Turbine Model

As mentioned in Section II, a reduced-order model of the wind turbine is derived to be used through the controller synthesis. In III.A the traditional wind turbine model is described, and in III.B the model that is used to obtain the tower lumped parameters as a function of the tower cross-section thickness is explained.

A. The Wind Turbine Model

Based on the Euler-Lagrange equations, a four degree-of-freedom analytical model of a 5-MW reference wind turbine [9] is derived. Euler-Lagrange's equations are written in terms of the kinetic energy T in the form of Eq. (2). The values of Q_k contain contributions of both conservative and non-conservative forces [14].

$$\frac{d}{dt} \left(\frac{\partial T}{\partial \dot{q}_k} \right) - \frac{\partial T}{\partial q_k} = Q_k \quad (2)$$

The four generalized coordinates q_k considered are the fore-aft displacement of the top of the tower x_t , the flap-wise displacements of the tip of the blades x_b , the rotor angular position θ_r , and the generator angular position θ_g . Figure 1 depicts a sketch of the coordinates mentioned above and the main elements that constitute the wind turbine model.

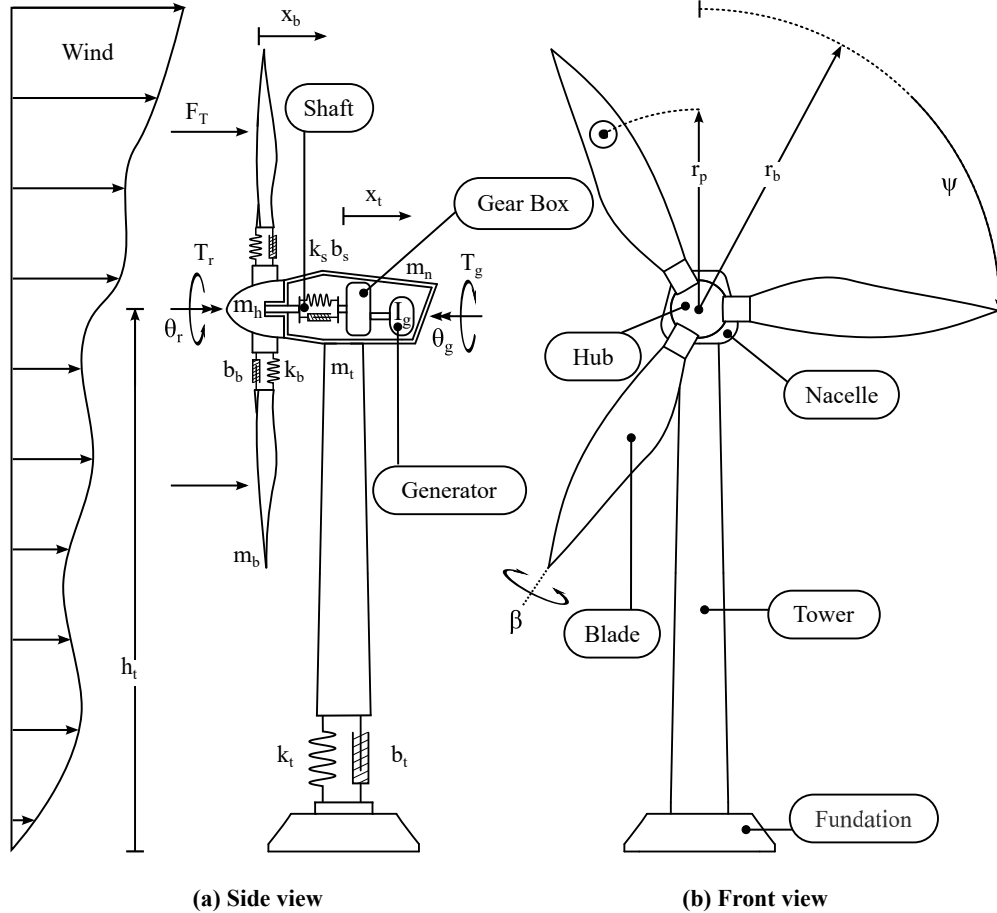

Fig. 1 Assumed model of the wind turbine including the rotor, the drive-train, the generator, and the tower.

The thrust force and aerodynamic torque developed by the rotor blades due to the wind and the torque applied to the generator are the external forces and moments that are considered in the generalized forces formulation. The thrust forces and aerodynamic torques can be expressed by Eq. (3) and (4), respectively, where the coefficients depend on the blade design, and are functions of the blade pitch angle β and the tip-speed ratio λ . Figure 2 shows the thrust and torque coefficients of the 5-MW NREL Reference Wind Turbine [9], obtained using AeroDyn [15].

$$F_t = \frac{1}{2} \rho v^2 A_r C_t(\lambda, \beta) \quad (3)$$

$$T_r = \frac{1}{2} \rho v^2 A_r r_b C_q(\lambda, \beta) \quad (4)$$

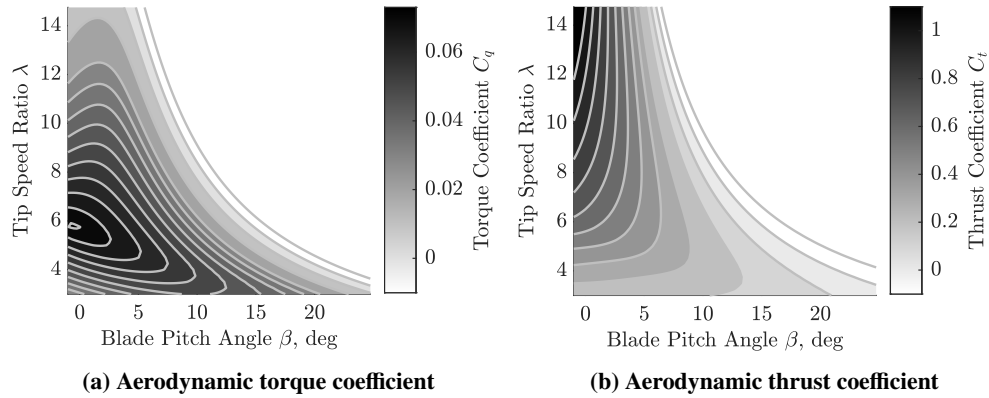

Fig. 2 Thrust and torque coefficients as a function of the pitch angle and the tip-speed ratio.

In the modeling stage, it is essential to take into account the system actuators. Regarding the blade pitch actuator, its second-order dynamics ($\omega_n = 2\pi$, $\xi = 0.7$) is considered. The position and rate saturation of the blade pitch actuator are also taken into account, with values of $[0; 90]$ deg and $[-8; 8]$ deg/s, respectively. Concerning the generator torque actuator, magnitude and rate saturation are implemented with values of $[0; 4.74 \cdot 10^4]$ Nm and $[-15000; 15000]$ Nm/s respectively.

B. The Tower Model

The tower of the wind turbine has been modeled as a hollow cylindrical cross-section clamped-free beam. The external diameter of the tower is defined as a constant, leaving its thickness t as a single geometric variable parameter for the control co-design optimization problem setup. The tower mass and the tower translational fore-aft stiffness coefficient, lumped-parameters that model the dynamics of the tower, are non-linear functions of t .

Figure 3 depicts the tower cross-section. The factor t/t_0 represents the ratio of the mentioned thickness variable to the thickness of a reference tower t_0 . Upper and lower bounds are defined on this ratio, such that the solution of the CCD optimization is found in the range $0.5 \leq t/t_0 \leq 1.5$.

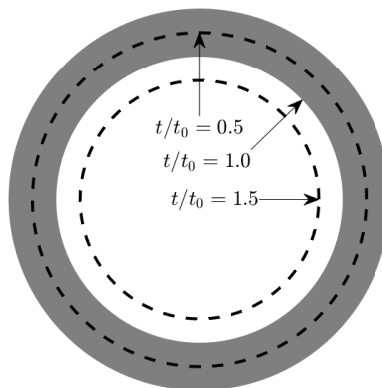

Fig. 3 Hollow cylindrical cross-section of the wind turbine tower.

IV. Control Architecture

The objective of the control system is twofold: To track the reference generator speed, and to mitigate structural vibrations under the presence of wind perturbations [8]. The first specification for the controller design is to minimize

the reference generator speed steady-state tracking error. Therefore, the controller includes an integral term.

A. Structured H_∞ Problem Formulation

When formulating the H_∞ control design problem, the configuration shown in Fig. 4 is assumed. Then, the terms displayed in Table 1 are defined. The control problem is to find the controller with sensed inputs that generate a control signal (blade-pitch-angle command) that minimizes the closed-loop norm from the exogenous inputs to the exogenous outputs and, consequently, minimizes the impact of the wind speed on the exogenous outputs [16].

Structured H_∞ synthesis is a concept that allows the control engineer to choose the structure of the H_∞ controller [11].

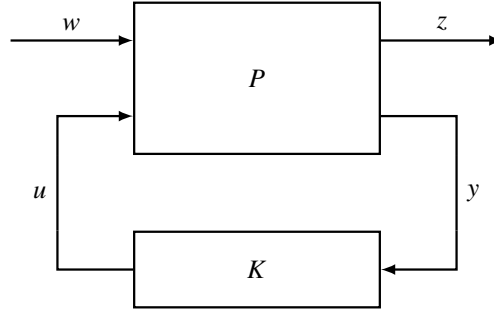

Fig. 4 Closed loop system configuration for the structured H_∞ problem formulation.

The order of the controller could potentially be an additional variable in the CCD optimization, but for the sake of simplicity, a static proportional controller K has been considered.

In the design process, requirements on four specific transfers of the system are defined. The first one (Req. 1) on the closed-loop transfer function from the commanded rotational speed of the generator $\dot{\theta}_{g,c}$ to the rotational speed of the generator $\dot{\theta}_g$ to ensure the reference tracking. Next, requirements on the closed-loop transfer function from the wind speed to the exogenous outputs are chosen to reduce the resonance peaks associated with the tower bending mode (Req. 2) and the blade bending mode (Req. 3). The last one (Req. 4) is specified on the transfer function from the wind speed perturbation to the rotational speed of the generator $\dot{\theta}_g$, in view of minimizing the effect of the wind on the tracking of the generator speed.

Table 1 Definition of terms for the closed-loop system.

Generalized wind turbine model	P
Controller	K
Exogenous inputs	w
<i>Wind speed</i>	v
<i>Rotational speed of the generator, command</i>	$\dot{\theta}_{g,c}$
Exogenous outputs	z
<i>Rotational speed of the generator</i>	$\dot{\theta}_g$
<i>Fore-aft deflection of the tower top</i>	x_t
<i>Out-of-plane tip deflection of the blade</i>	x_b
Control signals	u
<i>Blade-pitch-angle, command</i>	β_c
Sensed outputs	y
<i>Rotational speed of the generator</i>	$\dot{\theta}_g$
<i>Integral term of the controller</i>	$\int \dot{\theta}_{g,c} - \dot{\theta}_g dt$
<i>Fore-aft deflection of the tower top</i>	x_t
<i>Out-of-plane tip deflection of the blade</i>	x_b

Tuning goals for the design of the controller K are chosen to improve the existing legacy PI controller. The weighting functions are calculated based on transfers from the nominal closed-loop system (i.e., the system that is obtained when the legacy controller is used), aiming to both facilitate and automatize the tuning process. Then, these transfers are multiplied by a scalar weight.

B. The Reference Governor

Reference governors are add-on schemes for dealing with constrained systems [12], [13]. So far, only a few researchers have considered combining a structured H_∞ controller (or observer) with a reference governor [17]. Such a combination allows the closed-loop system to both effectively satisfy command tracking requirements despite disturbance uncertainties and to fulfill constraint requirements that limit specific variables of the system. In this paper, a standard reference governor is combined with the linear H_∞ controller to account for actuator nonlinearities, specifically magnitude and rate saturations of blade pitch actuators, and address limitations imposed on the generator speed tracking error. The control strategy adopted is illustrated in Figure 5. Wind disturbance is assumed to be measured. The reference governor is computed at each operating point and is only active when one of the constraints is prone to be violated.

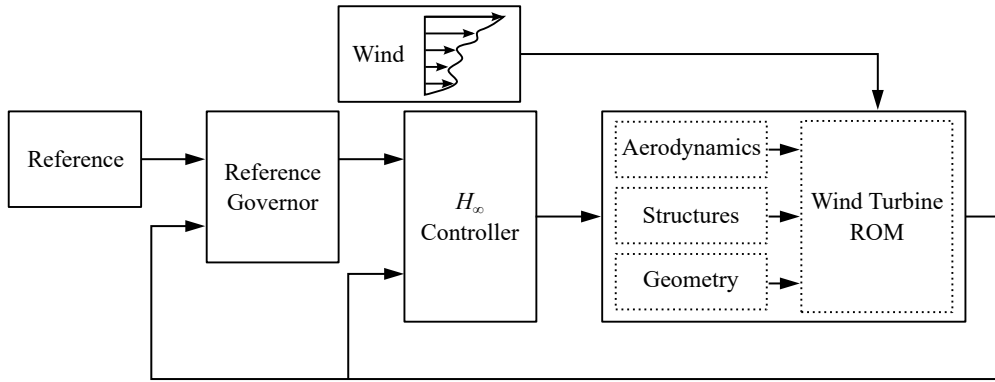

Fig. 5 Reference governor applied to closed loop system.

V. Optimization Problem Setup

In this control co-design optimization problem, not only the controller but also the tower of the wind turbine are designed. To obtain preliminary results, this process has been carried out at a single operating point in the above-rated region with a wind speed $v = 15m/s$. As explained in Section III, the thickness t of the tower is the single geometric variable parameter for the problem setup. Although the architecture of the controller is fixed, as mentioned in Section IV, the gains of the controller K are also variable parameters in the problem setup.

The cost function for this problem is defined as follows, $J = \text{RMS}(\delta\dot{\theta}_g) \cdot M/M_0$. On the right-hand side, the first term, the root mean squared value of the difference between the generator speed and the reference generator speed, accounts for the power efficiency. The second term accounts for the total mass M with respect to the reference wind turbine mass M_0 .

In the optimization process, feasible solutions that lead to an undesired response of the system might be obtained. Transient structural vibrations are desired to remain below certain limits since they lead to structural fatigue. The total variation of the tower top displacement in the fore-aft direction $\text{TV}(TTD_{spFA})$ is a metric that reflects the tower structural fatigue. Therefore, one can add a constraint to the optimization problem to obtain solutions below a particular total variation threshold value, $\text{TV}(TTD_{spFA}) \leq 0.65$.

Then, in this control co-design optimization problem, the minimization of the cost function, which accounts for power efficiency and equivalent mass, at a single operating point in the above-rated region $v = 15m/s$, subject to a fatigue associated constraint and bounds for the design variables is sought. The design variables are the gains of the collective blade pitch controller and the tower thickness.

Finally, the optimization problem can be formulated as Eq. (5).

$$\begin{aligned}
& \underset{K, t}{\text{minimize}} && J = \text{RMS}(\delta\dot{\theta}_g) \cdot M/M_0 \\
& \text{subject to} && 0.5 \leq t/t_0 \leq 1.5, \\
& && \text{TV}(\text{TTD}_{spFA}) \leq 0.65
\end{aligned} \tag{5}$$

VI. Results

Figure 6 shows the time response of the exogenous outputs and the control signal to a 1-m/s step input in wind speed for the system operating in the above-rated region with a wind speed of $v = 15\text{m/s}$. In this particular case the ratio $t/t_0 = 1$.

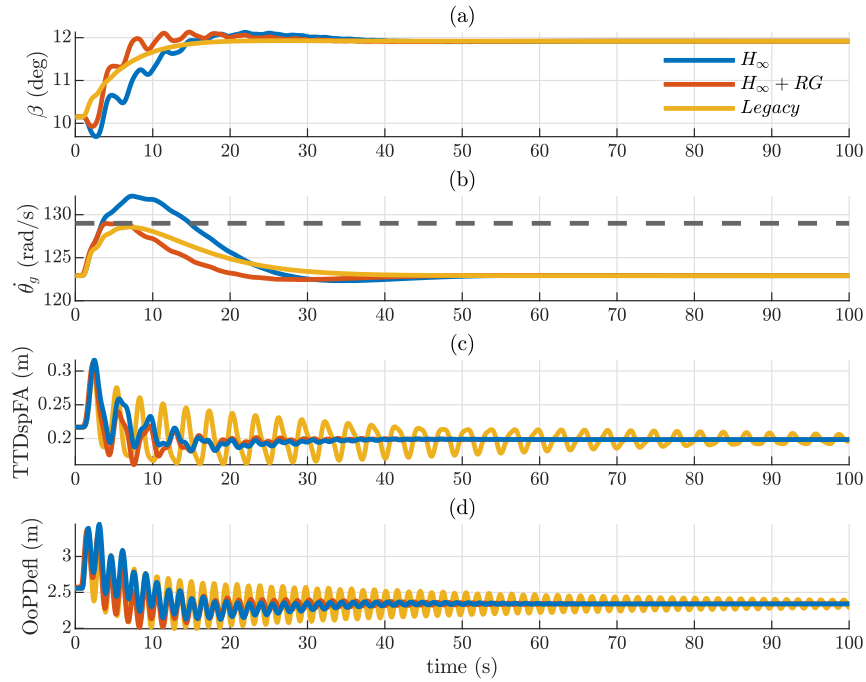

Fig. 6 Time response to a 1-m/s step input in wind speed for a land-based wind turbine. (a) Blade-pitch angle. (b) Generator speed. (c) Tower top fore-after deflection. (d) Blade tip out-of-plane deflection.

For the sake of comparison, results are also plotted for the Legacy controller. To illustrate the improvement added to the controller by the reference governor, results for both H_∞ and $H_\infty + RG$ controllers are shown.

The proposed H_∞ controller not only seeks to track the reference of the generator's speed, but also aims to improve the power generation and reduce the structural loads when the system is perturbed. A reference governor is added to ensure that the blade pitch actuators do not exceed their maximum angle and that the generator speed does not exceed the value of 129 rad/s. This last design specification is depicted in Figure 6b with a dashed line. The limitation on the speed of the generator can also be considered an additional variable to be tuned. Then, the parameters of the RG would also be design variables in the optimization problem setup.

Figures 6c and 6d show that when using the H_∞ controller, the oscillatory response of both tower and blades can be considerably mitigated. Therefore, their fatigue can be reduced. The price to pay is a more significant overshoot of the generator speed response, as shown in Figure 6a. The overshoot of the H_∞ is more considerable, leading to a larger RMS value. Nevertheless, by the effective use of the reference governor, the system original performance can be improved, compared to the Legacy controller. Adding a reference governor, the overshoots of the generator speed can be reduced and the generator speed error can be bounded by the defined constraint. In terms of tower deflection, Figure 6c shows that the oscillations when using a reference governor increase slightly with respect to the H_∞ controller alone.

Though, they are better damped and remain smaller compared to the tower oscillations for the system controlled by the Legacy controller. It is worth noting that the reduction of vibrations in the structure is accomplished through higher control activity. This can be observed in 6a.

Figure 7 depicts the control co-design optimization process. For each t/t_0 ratio a linear wind turbine model is derived, and the ratio M/M_0 is computed as seen in Fig. 7d. Then, both H_∞ and $H_\infty + RG$ are synthesized. The closed-loop system time response to a 1-m/s step input in wind speed is used to compute the $\text{RMS}(\delta\dot{\theta}_g)$ and the $\text{TV}(TTD_{spFA})$. These values are evaluated and compared in Fig. 7a and Fig. 7c respectively. The RMS and TV values are normalized with the maximum value obtained using both H_∞ and $H_\infty + RG$ controllers.

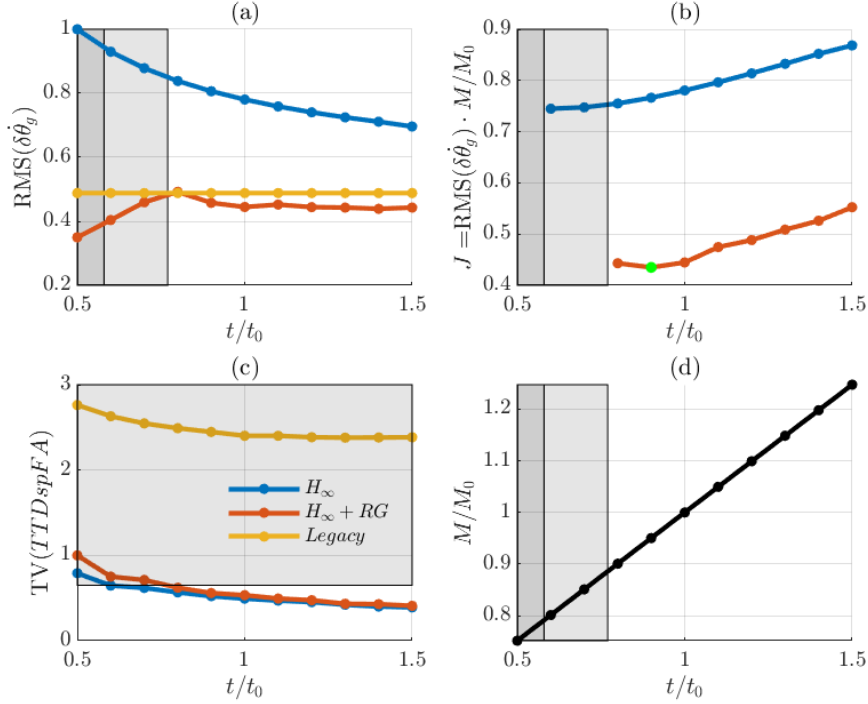

Fig. 7 Control co-design optimization problem. (a) RMS of delta generator speed. (b) Cost function. (c) TV of tower top deflection. (d) Wind turbine mass to reference mass ratio.

As already mentioned, the use of the H_∞ controller can considerably reduce the $\text{TV}(TTD_{spFA})$ compared to the Legacy controller but in exchange, the $\text{RMS}(\delta\dot{\theta}_g)$ increases. Nonetheless, this metric can be reduced when implementing the RG to ensure that the generator speed does not exceed 129 rad/s. When the RG is applied, the $\text{RMS}(\delta\dot{\theta}_g)$ is reduced without significantly increasing the $\text{TV}(TTD_{spFA})$.

Figure 7d shows how M/M_0 varies when varying the t/t_0 ratio in the admissible range. Figure 7c shows, for each t/t_0 , the total variation of the tower top transient deflection due to a step input in the wind speed. In can be seen in the shaded gray area the designs that violate the constraint $\text{TV}(TTD_{spFA}) \leq 0.65$. In particular, all the solutions obtained using the legacy controller and the solutions obtained for low t/t_0 ratios using H_∞ controllers violate this constraint.

Figure 7a shows, for each t/t_0 , the root mean squared value of the difference between the generator speed and the reference generator speed due to a step input in the wind speed. The shaded areas show the non-feasible solutions again due to violation of the constraint mentioned above. Finally, Fig. 7b shows the evaluation of the cost function for the feasible solutions. The minimum is achieved for a ratio $t/t_0 = 0.9$.

VII. Conclusion and Future Work

This paper has explored the benefits of the CCD optimization method to simultaneously design the controller and tower of a wind turbine system.

Compared to the reference wind turbine, a design in which the mass of the tower is reduced by 10% is achieved,

leading to a total mass reduction of 5% . The RMS of the generator speed error due to a wind speed step input is reduced by 7%, improving the power efficiency. The TV of the tower displacement in the fore-aft direction due to a wind speed step input is reduced by 75%, reducing the loads, mitigating the vibrations of the structure, and satisfying the imposed constraint.

These improvements are accomplished by employing a mixed control architecture of H_∞ and reference governor that allows to reject wind perturbations and addresses limitations imposed by the actuators.

Offshore wind turbines have an extra layer of complexity compared to land-based wind turbines due to the additional degrees of freedom of the system and the combination of a diverse source of perturbations. In the future, CCD optimization applied to an offshore wind turbine will be carried out. Load mitigation analysis will also be extended by computing damage equivalent loads (DEL) using OpenFast, in addition to the computation of the TV of the tower top displacement. The DEL of the blades, the control effort, and the platform motion will also be considered when setting up the optimization problem. Finally, design load cases for offshore wind turbines will be used as inputs to the control co-design optimization process.

Acknowledgments

This research is supported by the Department of Energy (DOE) Advanced Research Projects Agency-Energy (ARPA-E) Program award DE-AR0001186 entitled “Computationally Efficient Control Co-Design Optimization Framework with Mixed-Fidelity Fluid and Structure Analysis.” The authors thank DOE ARPA-E Aerodynamic Turbines Lighter and Afloat with Nautical Technologies and Integrated Servo-control (ATLANTIS) Program led by Dr. Mario Garcia-Sanz. Special thanks to the entire ATLANTIS Team for their support.

References

- [1] Garcia-Sanz, M., and Houppis, C. H., *Wind energy systems : control engineering design*, CRC Press, Boca Raton, Florida ;, 2012. Includes bibliographical references.
- [2] Zhang, K., and Bilgen, O., “Multi-Fidelity Aerodynamic Modeling of a Floating Offshore Wind Turbine Rotor,” *ASME 2020 International Mechanical Engineering Congress and Exposition*, Vol. Volume 10: Fluids Engineering, V010T10A061, 2020, pp. 1–5. <https://doi.org/10.1115/imece2020-24608>, URL <https://doi.org/10.1115/IMECE2020-24608https://asmedigitalcollection.asme.org/IMECE/proceedings-abstract/IMECE2020/84584/V010T10A061/1099517>.
- [3] Yaghmaie, R., and Bilgen, O., “High-Fidelity Structural Analysis of a 10 MW Offshore Floating Wind Turbine Rotor Blade,” *ASME 2020 International Mechanical Engineering Congress and Exposition*, Vol. Volume 7B: Dynamics, Vibration, and Control, V07BT07A047, 2020, pp. 1–7. <https://doi.org/10.1115/imece2020-24619>, URL <https://doi.org/10.1115/IMECE2020-24619https://asmedigitalcollection.asme.org/IMECE/proceedings-abstract/IMECE2020/84553/V07BT07A047/1099298>.
- [4] Du, X., Burlion, L., and Bilgen, O., “Control Co-Design for Rotor Blades of Floating Offshore Wind Turbines,” *ASME 2020 International Mechanical Engineering Congress and Exposition*, Vol. Volume 7A: Dynamics, Vibration, and Control, V07AT07A052, 2020, pp. 1–9. <https://doi.org/10.1115/imece2020-24605>, URL <https://doi.org/10.1115/IMECE2020-24605https://asmedigitalcollection.asme.org/IMECE/proceedings-abstract/IMECE2020/84546/V07AT07A052/1099255>.
- [5] Garcia-Sanz, M., “Control Co-Design: An engineering game changer,” *Advanced control for applications*, Vol. 1, No. 1, 2019, pp. e18–n/a. <https://doi.org/10.1002/adc2.18>, uSDOE.
- [6] Pao, L. Y., and Johnson, K. E., “Control of Wind Turbines,” *IEEE Control Systems Magazine*, Vol. 31, No. 2, 2011, pp. 44–62. <https://doi.org/10.1109/MCS.2010.939962>, URL <https://ieeexplore.ieee.org/document/5730721/>.
- [7] Lenfest, E., Goupee, A., Wright, A., and Abbas, N., “Tuning of Nacelle Feedback Gains for Floating Wind Turbine Controllers Using a Two-DOF Model: Preprint,” *ASME 2020 39th International Conference on Ocean, Offshore and Arctic Engineering*, Research Org.: National Renewable Energy Lab. (NREL), Golden, CO (United States), Sponsor Org.: USDOE Office of Energy Efficiency and Renewable Energy (EERE), Wind Energy Technologies Office (EE-4W), pp. 1–10. URL <https://www.osti.gov/biblio/1669567https://www.osti.gov/servlets/purl/1669567>.
- [8] Wang, S., and Seiler, P. J., “Gain Scheduled Active Power Control for Wind Turbines,” *32nd ASME Wind Energy Symposium*, 2014. <https://doi.org/10.2514/6.2014-1220>, URL <https://arc.aiaa.org/doi/abs/10.2514/6.2014-1220>.
- [9] Jm, J., Butterfield, S., Musial, W., and Scott, G., “Definition of a 5MW Reference Wind Turbine for Offshore System Development,” *National Renewable Energy Laboratory (NREL)*, 2009. <https://doi.org/10.2172/947422>, URL <https://www.nrel.gov/docs/fy09osti/38060.pdf>.

- [10] Buhl, M., Hayman, G., Jonkman, J., Jonkman, B., Mudafort, R., Platt, A., and Sprague, M., “OpenFAST;” , 2021. URL <https://github.com/OpenFAST/openfast>.
- [11] Apkarian, P., and Noll, D., “Nonsmooth H_∞ Synthesis,” *IEEE transactions on automatic control*, Vol. 51, No. 1, 2006, pp. 71–86. <https://doi.org/10.1109/TAC.2005.860290>, URL <https://ieeexplore.ieee.org/document/1576856/>.
- [12] Kolmanovsky, I., Garone, E., and Di Cairano, S., “Reference and command governors: A tutorial on their theory and automotive applications,” , 2014. <https://doi.org/10.1109/ACC.2014.6859176>, URL <https://ieeexplore.ieee.org/document/6859176/>.
- [13] Garone, E., Di Cairano, S., and Kolmanovsky, I., “Reference and command governors for systems with constraints: A survey on theory and applications,” *Automatica (Oxford)*, Vol. 75, 2017, pp. 306–328. <https://doi.org/10.1016/j.automatica.2016.08.013>, URL <https://www.sciencedirect.com/science/article/abs/pii/S0005109816303715?via%3Dihub>.
- [14] Baruh, H., *Analytical Dynamics*, WCB/McGraw-Hill, 1999. URL <https://books.google.com/books?id=oANZKAAACAAJ>.
- [15] Moriarty, P. J., and Hansen, A. C., “AeroDyn Theory Manual,” Report, National Renewable Energy Laboratory, 2005. <https://doi.org/10.2172/15014831>, URL <https://www.osti.gov/biblio/15014831https://www.osti.gov/servlets/purl/15014831>.
- [16] Skogestad, S., and Postlethwaite, I., *Multivariable Feedback Control: Analysis and Design*, John Wiley & Sons, Inc., 2005.
- [17] Bourdelle, A., Biannic, J.-M., Evain, H., Pittet, C., Moreno, S., and Burlion, L., “Modeling and control of propellant slosh dynamics in observation spacecraft,” *8th European Conference for Aeronautics and Space Sciences, (EUCASS)*, 2019, pp. 1–15.