



**HAL**  
open science

## Process-based LCA of ultrafiltration for drinking water production

Flavie Prézéus, L. Tiruta-Barna, Jean-Christophe Remigy, Christelle Guigui

► **To cite this version:**

Flavie Prézéus, L. Tiruta-Barna, Jean-Christophe Remigy, Christelle Guigui. Process-based LCA of ultrafiltration for drinking water production. *Water Research*, 2021, 199, 10.1016/j.watres.2021.117156 . hal-03743382

**HAL Id: hal-03743382**

**<https://hal.science/hal-03743382>**

Submitted on 2 Aug 2022

**HAL** is a multi-disciplinary open access archive for the deposit and dissemination of scientific research documents, whether they are published or not. The documents may come from teaching and research institutions in France or abroad, or from public or private research centers.

L'archive ouverte pluridisciplinaire **HAL**, est destinée au dépôt et à la diffusion de documents scientifiques de niveau recherche, publiés ou non, émanant des établissements d'enseignement et de recherche français ou étrangers, des laboratoires publics ou privés.

# 1 **Process-based LCA of ultrafiltration for drinking water production**

2 Flavie Prézéus<sup>a,b</sup>, Ligia Tiruta-Barna<sup>b</sup>, Jean-Christophe Remigy<sup>a</sup>, Christelle Guigui<sup>b,\*</sup>

3

4 <sup>a</sup> Laboratoire de Génie Chimique, Université de Toulouse, CNRS, INPT, UPS, Toulouse, France

5 <sup>b</sup> TBI, Université de Toulouse, CNRS, INRAE, INSA, Toulouse, France

6

7 \* Corresponding author:

8 E-mail address: guigui@insa-toulouse.fr (C. Guigui)

## 9 **Abstract**

10 Researchers and industrials need decision-making tools to make informed decisions on  
11 environmental mitigation strategies and proceed with the overall ecodesign of processes. In  
12 this study, a tool that couples membrane filtration process modelling and life cycle analysis  
13 has been developed, for which material and energy flows are calculated for variable  
14 operating conditions and are the basis for environmental impact assessment. The resulting  
15 generic model has been applied to dead-end ultrafiltration of ground and surface waters for  
16 drinking water production with cellulose triacetate hollow fibers. Operating strategies have  
17 been investigated to mitigate environmental impacts of the two major hotspots (electricity  
18 and backwash cleaning chemical consumptions). Adjusting filtration cycle duration and  
19 filtration flux has shown to be a promising lever. The developed model is sufficiently flexible  
20 and modular for its adaptation to other membrane materials, filtration configurations (*i.e.*  
21 cross-flow) as well as to other applications.

## 22 **Highlights**

- 23 - Novel decision-making tool for filtration developed at a unit operation level.
- 24 - Extensive operating conditions and input water categories as model variables.
- 25 - Environmental impacts as sensitive to operating conditions as to electricity mix.
- 26 - Easy combination possible with existing fabrication model for cradle-to-grave LCA.

## 27 **Keywords**

28 Process modelling; environmental assessment; membrane filtration; hollow fiber; cellulose  
29 triacetate; drinking water

30 **1. Introduction**

31 As of the 1980s, limitations of conventional drinking water production have led  
32 researchers to investigate on the use of membranes to treat ground and surface waters  
33 (Bersillon et al., 1989; Cabassud et al., 1991; Clark and Heneghan, 1991; Jacangelo et al.,  
34 1997). In 1988, the first ultrafiltration (UF) drinking water plant was inaugurated in France  
35 (Amoncourt, 10 m<sup>3</sup> h<sup>-1</sup>). Nowadays membrane technology for drinking water applications is a  
36 mature technology notably owing to its compacity, the physical nature of the treatment  
37 (thereby limiting chemical inputs and formation of disinfection by-products) and, more  
38 importantly, the constant and high quality of water obtained.

39 The production target of drinking water plants entails an operation at constant flow  
40 rate and, by extension, a constant filtration flux (L h<sup>-1</sup> m<sup>-2</sup>). A near-constant number of UF  
41 modules are indeed maintained in filtration mode to limit any downtime. As ground or  
42 surface water is treated, retained matter accumulates and fouls the membrane surface and  
43 its porous structure, thereby increasing the driving force that is transmembrane pressure  
44 (TMP); membrane permeability falls. Keeping membrane permeability at an acceptable level  
45 in terms of energy consumption for pumping requires curative cleaning techniques, the two  
46 principal ones carried out industrially being backwashing and cleaning-in-place (Chang et al.,  
47 2017; Regula et al., 2014). Backwashing is the mechanical action whereby a reversed flow is  
48 pumped from the permeate to the intake side of a membrane, whereas cleaning-in-place  
49 consists in a chemical solution being pumped in the membrane module without displacing it  
50 from its rack. These techniques not only consume water and chemicals but also energy for  
51 pumping.

52 Membrane performances (*i.e.* permeability, water recovery rate) depend on the  
53 quality of input water to be filtered. In particular, the complexity of fouling as a  
54 phenomenon arises in part from the complex matrix of input water. Particulate and colloidal  
55 matter have been identified as major foulants that remain loosely attached on the  
56 membrane surface and can therefore be easily removed by hydraulic washing procedures  
57 (Howe and Clark, 2002; Peiris et al., 2010). More problematic foulants are those that are  
58 tightly bound to the membrane, typically natural organic matter fractions, and thus require  
59 chemical action for their removal (Mallevalle et al., 1996). Interactions between foulants  
60 add to the complexity of fouling. Particulate and organic matter interactions have for  
61 example been documented to form a combined fouling layer, and calcium ions to cross-link

62 with negatively charged functional groups present in organic matter (Alresheedi et al., 2019;  
63 Peldszus et al., 2011; Jermann et al., 2008).

64 With the ever-increasing awareness of environmental issues, research efforts on drinking  
65 water production have transcended purely technical considerations and have begun to focus  
66 on the environmental footprint of production processes. Environmental assessment tools  
67 are necessary for this, a notable example being Life Cycle Assessment (LCA). This  
68 internationally recognized and standardized tool consists of four interdependent phases  
69 (ISO, 2006). Firstly, the LCA goal and scope are defined. Then, material and energy flows  
70 from and to the environment are listed and quantified in a life cycle inventory (LCI). In a third  
71 phase, inputs and outputs previously identified are transformed into potential  
72 environmental impacts with life cycle impact assessment (LCIA) methodologies. In the final  
73 interpretation phase, the first three phases are reviewed and improvement strategies as well  
74 as recommendations are made.

75 Membrane-based systems for drinking water production from ground and surface waters  
76 have been dealt with in LCA studies, notably with UF as the central unit of a treatment  
77 process chain (Friedrich, 2001; Igos et al., 2014), as a pretreatment for nanofiltration (Ribera  
78 et al., 2014) or polishing stage of a clarification–sand filtration–ozonation process (Vince et  
79 al., 2008) (see Table 1). The environmental assessments are carried out at a process level  
80 and relative contributions of unit operations are identified. For example, Vince et al. (2008)  
81 point out that the UF operation is the greatest electrical consumer of the drinking water  
82 production process (remineralization, coagulation-flocculation-settling, sand filtration,  
83 ozonation, activated carbon filtration, UF, chlorination) dedicated to treat surface water with  
84 high organic content and low hardness. To the best of our knowledge, no information is  
85 found on how to specifically operate at a unit operation level, including UF, for  
86 environmental impact mitigation; these studies are predominantly carried out under fixed  
87 site-specific operating conditions. As shown in Table 1, exceptions consider variable  
88 operating conditions with limited values. For example, Friedrich (2001) examines three  
89 design parameters (*i.e.* membrane filtration flux, module length and number of modules per  
90 rack), each of which can have two different values. The considered production process  
91 (prefiltration, UF, chlorination) produces 200,000 m<sup>3</sup> of potable water per day from surface  
92 water. Results show a greater sensitivity of environmental impacts to filtration flux and  
93 module arrangement than module length. Vince et al. (2008) go beyond specific cases and

94 have developed black-box models for drinking water unit operations to calculate the LCI and  
95 output water characteristics from three types of input parameters: equipment design (*e.g.*  
96 type of membrane), local conditions (*e.g.* energy supply, plant location) and feed water  
97 characteristics (*i.e.* quality, flow rate). Unfortunately, no further detail is given on model  
98 equations or the specific influence of operating conditions.

99 Interestingly, Mery et al. (2013) combined LCA with process modelling for the ecodesign  
100 of conventional drinking water plants. The developed tool is based on models of unit  
101 operations that calculate environmental impacts from design facts, equipment sizing and  
102 operating conditions. Unit operations include coagulation, granular activated carbon  
103 filtration and ozonation but membrane filtration has not been examined. To the best of our  
104 knowledge, such methodological approach has never been undertaken for membrane  
105 filtration in the field of drinking water production from ground and surface water, in  
106 particular for ultrafiltration.

107 It is thus legitimate to consider that operating conditions have an influence on  
108 environmental impacts and can thus be an action lever to reduce them. Not only can existing  
109 drinking water plants go through upgrades, but plants that are yet to be designed can be  
110 involved in such an ecodesign approach. A second point is that cause-effect relationships  
111 between operating conditions and environmental impacts are far from straightforward and  
112 are to be further investigated, notably by taking into account the specificity and complexity  
113 of the system under study at a unit operation level. For membrane filtration, it would for  
114 example entail examining fouling and remediation methods.

115 What is ultimately pointed out is the relevance of going beyond specific cases and  
116 developing flexible and modular decision-making tools that consider the unit operation level  
117 with the associated operating conditions. The generic process modelling-LCA approach used  
118 in this study follows this objective. Given the complexity of fouling and its remediation, this  
119 approach is applied to membrane filtration only in this work. A previous study has  
120 considered membrane fabrication (Prézéus et al., 2020) and membrane end-of-life is out of  
121 the scope. The aims of this study are: (1) to develop an original model and simulation tool of  
122 dead-end UF as a unit operation for drinking water production, (2) to evaluate the  
123 contribution of inputs and outputs on environmental impacts, and (3) to assess the influence  
124 of operating conditions, leading to possible improvements. In the first part of our study, the  
125 model development for dead-end inside-out hollow fiber filtration is explained and LCA

126 information is detailed. In the second part, a case study of the operation of cellulose  
127 triacetate (CTA) UF membranes is examined.

128

129

130

131

132

133

134

135

**Table 1** LCA studies of membrane-based systems for drinking water production from ground and surface waters

<b>LCA goal and scope</b>	<b>Membrane filtration</b>	<b>Variable operating condition</b>	<b>Observations on UF operation</b>	<b>Reference</b>
Comparison of conventional and UF water production	UF	filtration flux, number of modules per rack, module length	Greater sensitivity of environmental impacts to filtration flux and number of modules per rack than module length	Friedrich, 2001
Comparison of water supply systems	MF, UF, NF <sup>a</sup>	feed water quality, flow rate, local conditions (energy supply, plant location)	Greatest electrical consumer of the production process; fourth contributor to global warming potential of the process life cycle	Vince et al., 2008
Comparison of water treatment plants	MF, NF <sup>a</sup>	drinking water quality, electricity source	-	Bonton et al., 2012
Environmental assessment of two complex water treatment plants	UF	-	Main electrical consumer (along with input water pumping) of both production processes	Igos et al., 2014
Comparison of water purification systems	NF <sup>a</sup>	type of membrane, membrane lifetime, operational electricity consumption	-	Manda et al., 2014

Environmental impacts of NF integration in a drinking water treatment plant <sup>a</sup>	UF, NF <sup>a</sup>	-	Minor contributor of production processes compared to conventional and NF operation and construction for six selected impact categories	Ribera et al., 2014
--	---------------------	---	---	---------------------

<sup>a</sup> MF microfiltration, NF nanofiltration



116 **2. Material and methods**

117

118 First of all, the process and global framework of the model are explained along with  
119 the underlying model hypotheses. All model equations are specifically given in Appendix A.  
120 Focus is then given on LCA information.

121

122 **2.1. Process description**

123 The drinking water production process considered in this study concerns only the UF  
124 unit operation, which consists in the succession of operating cycles (*i.e.* alternation of  
125 filtration and backwash (BW) cycles concluded by a clean-in-place (CIP) cycle). The process  
126 can be described according to its three lines (see Fig. 1.).

127 The UF line consists in input water transferred by the intake pump through the  
128 prefilter and UF modules into the permeate tank for storage. Input water either refers to  
129 ground and surface waters or water having undergone a previous pre-treatment. The UF  
130 modules are made up of inside-out hollow fiber membranes operating in a dead-end  
131 configuration.

132 In the BW line, water is transferred by the BW pump from the permeate tank to the  
133 UF modules and prefilter with a reversed flow (outside-in). A BW chemical is injected at the  
134 permeate tank outlet to avoid microbial proliferation in the UF modules. The BW waste is  
135 decanted: clear liquid is sent back to the prefilter and the sludge is sent to a wastewater  
136 treatment plant (WWTP).

137 In the CIP line, several chemical solutions are first successively prepared in a CIP tank  
138 with water from the permeate tank and injected CIP chemicals. These solutions are  
139 successively fed into the UF modules in the same direction as for filtration (inside-out).  
140 Liquid waste containing CIP chemicals is sent to a WWTP, whereas rinsing water from the  
141 final CIP phase is discharged to a surface waterbody (Coelho et al., 2019).

142 Environmental impacts in this study are calculated as a function of 1 m<sup>3</sup> of  
143 ultrafiltered produced water, which corresponds to a net volume after deduction of  
144 permeate water used up during backwashing and cleaning-in-place.

145

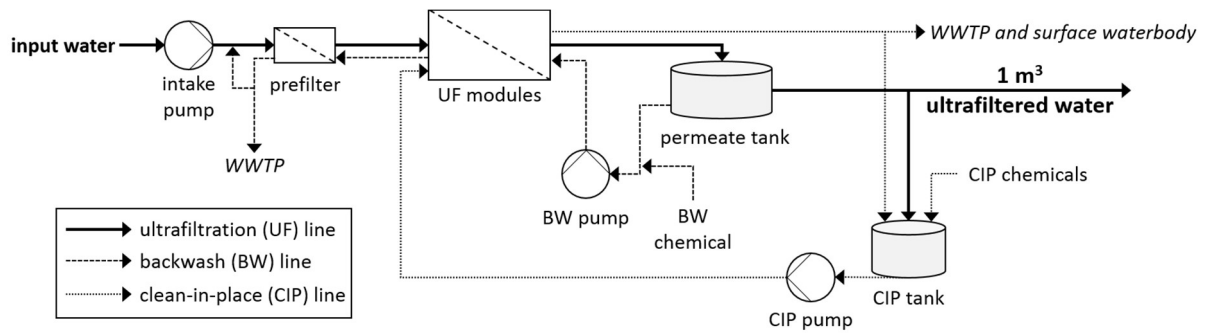

146  
147 **Fig. 1.** Flowsheet of UF drinking water production process  
148

149 **2.2. Model framework**

150 The model is valid for a hollow fiber membrane unit in a dead-end configuration with  
151 a defined daily output water flow rate. The model considers non-stop membrane operation,  
152 once the initial start-up phase of the membrane unit is over. Membrane manufacturers  
153 indeed observe that permeability falls from an initial value (*e.g.* ultra-pure water  
154 permeability) to a lower value (noted  $L_{p1,1,1}$  in what follows) due to the shift from ultra-pure  
155 to more fouling real water (Inge, 2014).

156 The model calculates consumptions and waste, and provides engineering design data  
157 (relative permeability, module operating life, *etc.*) from both intrinsic and user-defined input  
158 parameters (see zoom on UF model in Fig. 2.). As a first step, these parameters are  
159 considered as constant over the module operating life.

160 Intrinsic parameters are defined as imposed upon drinking water operators and plant  
161 designers, such as the membrane fouling rate or thresholds defined by previous conducted  
162 research. In particular, the membrane fouling rate stems from choices made on membrane  
163 material, operating conditions and input water quality. Operators and designers have no  
164 action on these input parameters, unlike user-defined parameters that can be changed and  
165 adapted on site or during design. Examples of user-defined parameters include operating  
166 conditions and engineering design data (*e.g.* number of modules, their arrangement in  
167 blocks, head loss). Input water quality can also be altered by adjusting the operation of  
168 upstream unit operations according to variable ground or surface water quality. Input  
169 parameters have been divided in this way to distinguish parameters that can be acted upon  
170 and serve as levers of action for operational and design strategies from parameters that  
171 cannot. A detailed list of parameters is given in Table 2 and the exhaustive list can be found  
172 in Tables A.1 and A.2 in Appendix A.

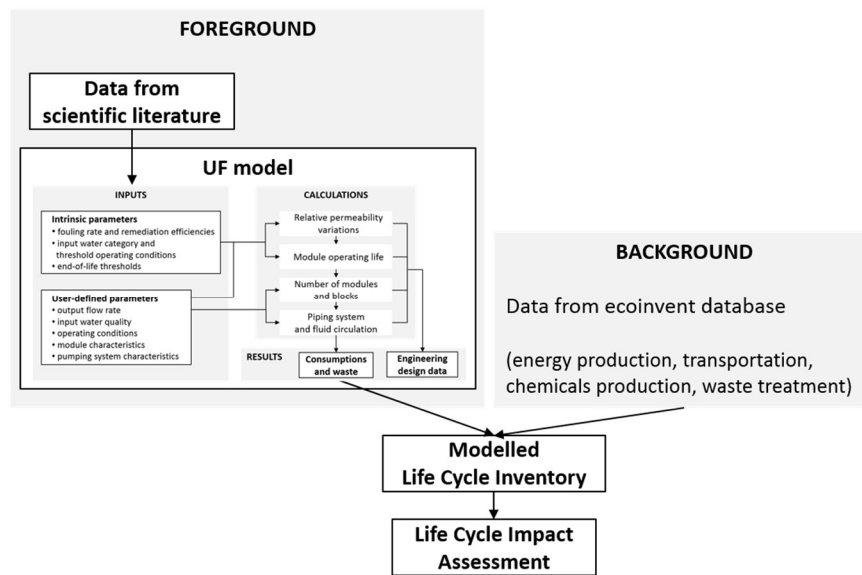

Fig. 2. Model framework for UF operation

174

175

176

### 177 2.2.1. Intrinsic parameters

#### 178 2.2.1.1. Input water category and threshold operating conditions

179 Consideration of input water quality in the model is based on industrial practices.  
 180 Due to the complexity of fouling and the difficulty to model it, water suppliers have adopted  
 181 a pragmatic approach of categorization so as to give guidance on how to conduct UF as a  
 182 function of input water quality. Input water can be categorized according to two global easy-  
 183 to-measure analytical parameters that have shown to be discriminating as regards fouling:  
 184 turbidity and total organic carbon (TOC) (Coelho et al., 2019; Crozes, 1994). For example,  
 185 category 0 corresponds to high-quality input water with low levels of turbidity and TOC,  
 186 whereas category 3 corresponds to low-quality input water with high turbidity and TOC  
 187 values. Each input water category is associated with recommended threshold operating  
 188 conditions (*i.e.* filtration flux, BW and CIP frequency) specific to each water supplier and  
 189 derived from industrial case studies.

190 In accordance with these industrial practices, the definition of input water categories  
 191 is inserted as intrinsic parameters of the model. Other intrinsic parameters are the three  
 192 associated thresholds: maximum filtration flux, minimum BW and CIP frequencies. User-  
 193 defined parameters and model calculations must never exceed these thresholds.

194

195 2.2.1.2. *Intrinsic parameters: fouling rate and remediation efficiencies*

196 The model, and in particular relative permeability variations, hinges on three key  
197 intrinsic parameters: fouling rate during filtration cycles, BW efficiency and CIP efficiency. In  
198 this work, the fouling rate during filtration ( $v_F$ ) is defined as the decline rate of relative  
199 permeability  $\left(\frac{Lp}{Lp_{1,1,1}}\right)_F$  per unit of permeate volume (V) per membrane surface area (S) and  
200 expressed in  $m^{-1}$ :

201

$$202 \quad v_F = \frac{d\left(\frac{Lp}{Lp_{1,1,1}}\right)_F}{d\left(\frac{V}{S}\right)} \quad (1)$$

203 By way of reminder,  $Lp_{1,1,1}$  is the permeability once the initial start-up phase of the  
204 membrane unit is over. An interesting feature of fouling rate described as in Equation (1) is  
205 to eliminate dependency on filtration flux, thereby lowering the number of degrees of  
206 freedom. Indeed, for a given membrane material, there is one fouling rate value per input  
207 water quality. When both filtration flux and input water quality are held constant, the  
208 fouling rate per unit of  
209 permeate volume can be readily converted to a fouling rate per unit of time.

210 As illustrated in Fig. 3.(a), BW efficiency ( $\%_{BW}$ ) is defined as the ratio of relative  
211 permeability recovery during a BW cycle  $\left[\left(\Delta\frac{Lp}{Lp_{1,1,1}}\right)_{BW}\right]$  to relative permeability decline  
212 between the start and end of the preceding filtration cycle  $\left[\left(\Delta\frac{Lp}{Lp_{1,1,1}}\right)_F\right]$ .

213 CIP efficiency ( $\%_{CIP}$ ) is defined as the ratio of relative permeability recovery during a  
214 CIP cycle  $\left[\left(\Delta\frac{Lp}{Lp_{1,1,1}}\right)_{CIP}\right]$  to relative permeability decline between the start of the ongoing  
215 operating cycle and the start of the CIP cycle  $\left[\left(\Delta\frac{Lp}{Lp_{1,1,1}}\right)_{OP}\right]$  (see Fig. 3(b)).

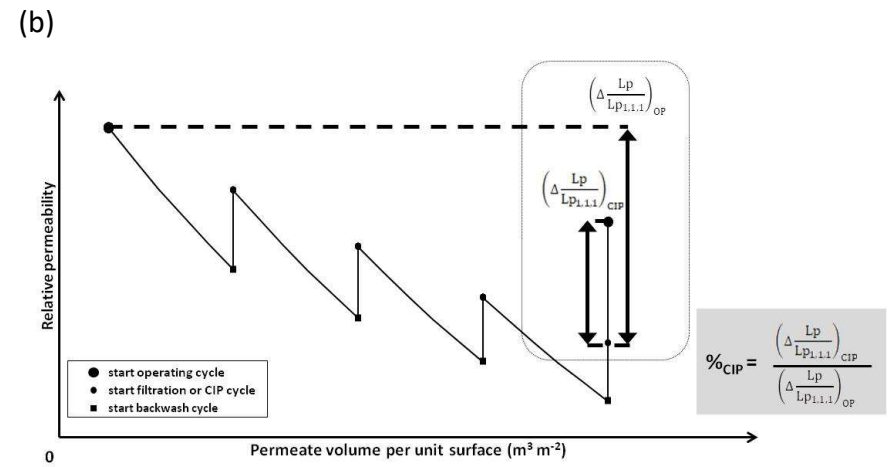
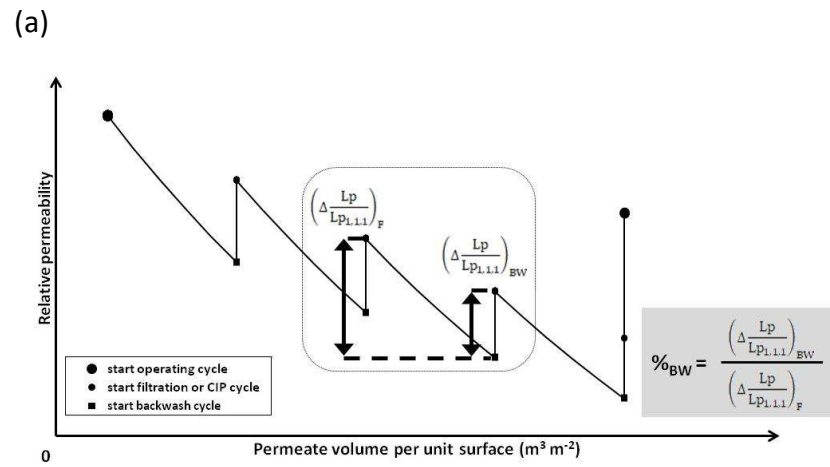

**Fig. 3.** (a) Backwash efficiency ( $\%_{\text{BW}}$ ) (b) Clean-in-place efficiency ( $\%_{\text{CIP}}$ )

216 In a first approach, all three intrinsic parameters are assumed to be constant. Studies  
217 have highlighted the variability over time of membrane properties and process behaviour,  
218 including CIP efficiency (Porcelli and Judd, 2010). CIP efficiency can increase over time due to  
219 more permeable membranes as a result of their chemical degradation during CIP amplified  
220 by mechanical stress of BWs (Pellegrin et al., 2013). It has also been hypothesized that the  
221 chemical ageing of membranes account for a greater sensitivity to fouling compared to virgin  
222 membranes (Touffet et al., 2015). Such opposite effects of membrane ageing on  
223 permeability make it difficult to quantitatively predict the evolution of parameters such as  
224 fouling rate, BW or CIP efficiencies. Integrating such effects in the model would require a  
225 complete dataset of TMP over time of the UF unit. By default, BW and CIP efficiencies have  
226 been initialized with parameters having true constant values: membrane operating life,  
227 initial and final permeabilities. Industrial values can readily be found in the literature  
228 (Bersillon et al., 1989; Clark et Heneghan, 1991; Coelho et al., 2019; Mallevalle et al., 1996).  
229 The fouling rate can then be inferred from the BW and CIP efficiencies.

230 Another possible approach, beyond the scope of this study, would be to implement a  
231 statistical analysis to process large sets of industrial or laboratory data (Teychene et al.,  
232 2018), which could result in regression functions suggested for the three intrinsic  
233 parameters as a function of input water quality (*e.g.* turbidity, TOC), membrane  
234 characteristics and operating conditions (*e.g.* BW and CIP conditions). A prerequisite for this  
235 semi-empirical approach is access to a large set of industrial values over a long period of  
236 time (*e.g.* a year). Results from such an analysis as well as those from specific research  
237 studies on membrane ageing, for example, can be later integrated in the developed model.

238

### 239 *2.2.1.3. Intrinsic parameters: end-of-life thresholds*

240 The end of life of any given membrane module is reached when at least one of four  
241 conditions has been met: maximum operating life, minimum productivity, maximum  
242 chemical resistance and maximum mechanical resistance. The last three conditions imply  
243 membrane ageing. Note should be taken that it can be difficult to distinguish between  
244 chemical and physical ageing of membranes since consequences on membrane  
245 performances, *e.g.* permeability, may be similar (Rouaix et al., 2006).

246 Maximum operating life corresponds to a defined duration that has been reached.  
247 This duration can for example correspond to the membrane manufacturer's warranty, after

248 which breakdowns are not insured anymore or to the membrane manufacturer's  
249 recommendation to systematically renew modules after a given period of time for  
250 precautionary measures.

251 In the case of minimum productivity, a defined permeability is reached after a BW  
252 cycle. Below this minimum permeability, the module is considered unproductive, unless an  
253 unacceptably high TMP is applied.

254 In this study, the maximum chemical resistance corresponds to a defined “c x t” value  
255 that has been reached for one of the chemicals used for backwashing or cleaning-in-place. It  
256 expresses the chemical intensity in ppm.day and corresponds to the chemical’s  
257 concentration (c) multiplied by the contact time (t) with the membrane surface. To maintain  
258 the chemical integrity of the membrane and the module as a whole, a maximum tolerable  
259 number of CIP cycles is determined for each chemical (Arkhangelsky et al., 2008; Levitsky et  
260 al., 2012; Mallevalle et al., 1996).

261 As for maximum mechanical resistance, a defined number of BW cycles has been  
262 reached. BWs have an effect on the physical integrity of membranes. A maximum number of  
263 BW cycles is thus defined to stop operating modules before fibers are too fragile to  
264 mechanical stress (Mallevalle et al., 1996).

265

### 266 **2.2.2. User-defined parameters**

267 As shown in Fig.2., user-defined parameters are inputs of the model. The output flow  
268 rate is defined as the average daily output flow rate and accounts for permeate loss during  
269 backwashes (BW) and clean-in-places (CIP).

270 Following industrial practices and as explained in section 2.2.1., turbidity and TOC are  
271 considered in the model as user-defined parameters for input water quality characterization.  
272 Both are average values during the membrane facility’s operating life, which provides the  
273 advantage in a first approach to smooth the effect of temporary variations of input water  
274 quality.

275 Operating conditions include filtration flux, BW conditions (*i.e.* flux, permeate volume  
276 per unit of membrane surface, chemical concentration and injection time fraction) and CIP  
277 conditions (*i.e.* chemical concentration, filtration and soaking duration, and filtration and  
278 rinsing fluxes). Module characteristics refer to the membrane filtration surface, initial  
279 permeability and void volume to be filled during CIPs. Pumping system characteristics

280 include pump efficiencies, pipe dimensions and minor loss coefficients of the pumping  
281 system (pipes common to all blocks, prefilter and pipes within a rack).

282

### 283 **2.2.3. Model calculations**

284 In order to calculate consumptions and waste, the model is based on the  
285 determination of relative permeability variations during the modules' operating life. Relative  
286 permeability compares permeability at any given time to  $L_{p1,1,1}$ , the initial permeability. The  
287 latter varies from one module to another and from one membrane material to another, thus  
288 making it difficult to compare absolute permeability values of modules with one another.  
289 Relative permeability allows this comparison to be made.

290 Membrane modules are considered to respond in an equivalent manner to given  
291 operating conditions. Permeability variations and operating lifespan are for example  
292 identical from one module to another in the same membrane unit. In reality, there may be  
293 modules of different ages due to module replacement, for example if too many broken  
294 fibers are present (Brehant et al., 2009). The behaviour of modules calculated by the model  
295 corresponds to an average behaviour in the UF unit. Similarly, hydraulic distribution in the  
296 piping system is never perfectly equal and hydraulic conditions may vary from one module  
297 to another depending on their position in the membrane unit. Due to lower head losses,  
298 modules closest to the intake pump are subject to input water at a higher TMP than the  
299 furthest modules. However, it can be considered that hydraulic variations between  
300 membrane units are similar and hydraulic conditions given by the model corresponds to  
301 average conditions in the membrane facility.

302 Module consumption may be derived from the number of modules needed to satisfy  
303 the daily output water flow rate and the operating life. Chemical consumption during CIPs  
304 and head loss both depend on module arrangement in blocks. The module arrangement in  
305 the model is based on industrial practices, according to which the membrane system is  
306 composed of several identical blocks: two racks of two rows each containing the same  
307 number of modules (Inge, 2014). An example of a possible module arrangement is given in  
308 Appendix B.

309 Energy consumption linked to pumping in part depends on the membrane facility's  
310 configuration and inherent minor head losses. Linear head loss is neglected in pumping  
311 calculations because negligible compared to minor head loss. As an order of magnitude,



312 linear head loss is at most a tenth of minor head loss for rack lengths smaller or equal to  
313 14m, which corresponds to 80 modules per rack (module diameter and space between  
314 modules are equal to 30 and 5 cm, respectively). Racks are backwashed successively whilst  
315 the others remain in the filtration mode: a first rack is cleaned, then a second, *etc.* Whereas  
316 material consumption of the BW chemical injection is taken into account, its pumping is  
317 neglected in energy consumption calculations because negligible compared to BW water  
318 pumping (<0.01%). Racks are also cleaned-in-place successively. A CIP cycle is composed of  
319 maximum 5 phases, of which up to 3 phases consist in inside-outside filtration with a  
320 chemical solution followed by a soaking period. Chemical injection in the CIP tank is  
321 neglected in energy consumption calculations because negligible compared to tank filling  
322 with permeate water (<0.9%). In a fourth phase, permeate water used in a closed circuit is  
323 filtered inside-outside. The fifth phase is a final rinsing step during which the permeate goes  
324 directly to waste. Further precisions on fluid circulation and rack rotations for BW and CIP  
325 executions can be found in Appendix C.

326 Modelling equations used for consumption and waste calculation, as well as engineering  
327 design data can be found in Appendix A.

328

## 329 **2.3. Life Cycle Assessment (LCA)**

### 330 **2.3.1. Goal and scope**

331 The goal of LCA is to evaluate: (1) the contribution of consumptions and generated  
332 waste on environmental impacts; (2) the influence of operating conditions; and (3) lever  
333 actions for improving environmental performances. For our case study, the UF unit is  
334 considered to be located in France and intended for drinking water production. The  
335 functional unit is 1 m<sup>3</sup> of ultrafiltered water.

336 The system boundaries consider membrane operation only, including prefiltering,  
337 ultrafiltering, backwashing and cleaning-in-place (see Fig. 1.). Energy and chemical  
338 consumptions are considered for these four unit processes. Transport of chemicals and  
339 waste from and to the UF unit, and treatment of BW and CIP liquid waste are also  
340 considered. The fabrication and end of life of membranes are out of the scope of this study:  
341 the former has been dealt with in one of our previous studies (Prézéus et al., 2020) and the  
342 latter will be included in our forthcoming study. The construction and decommissioning of  
343 infrastructure and equipment are not included in the environmental assessment. Indeed, the

344 modelling of each life cycle phase first needs to be developed before being able to consider  
345 the entire life cycle of membranes with the corresponding infrastructure.

346 Umberto NXT software and ecoinvent 3.4 database are used with the allocation at  
347 the point of substitution for background processes (*i.e.* energy production, transportation,  
348 chemicals production, waste treatment, *etc.*).

349

### 350 **2.3.2. Life Cycle Inventory (LCI)**

351 The flowchart for LCA calculation is presented in Fig. 2. The foreground is the UF  
352 drinking water production process as described in section 2.1., with input data collected  
353 from the scientific literature. In this work, the input data and the resulting modelled  
354 inventory are valid for an UF unit composed of CTA hollow fiber modules operating in a  
355 French drinking water production context.

356 Ideally, a parametric model is needed to express the fouling rate of a given  
357 membrane as a function of at least turbidity and TOC. Environmental assessments require  
358 that this model be based on industrial data from drinking water plants, as opposed to  
359 theoretical or research data. A considerable effort would then be needed to process data  
360 with advanced numerical tools (*e.g.* artificial intelligence). It was not possible to collect  
361 sufficient data to adjust such a parametric model due to the difficulty in obtaining such data,  
362 which is sometimes confidential, and due to the fact that drinking water plants do not  
363 always collect them (in particular as regards BW and CIP efficiency). In such circumstances,  
364 the literature has been used to obtain information for specific ranges and for different time  
365 spans of a membrane's operating life. The choice has been made to verify the model of  
366 membrane operation by first defining a baseline scenario based on real data and then  
367 verifying the obtained inventory against literature values.

368 The baseline scenario has been defined as the dead-end filtration at  $100 \text{ L h}^{-1} \text{ m}^{-2}$  of a  
369 high-quality input water (*i.e.*  $1 \text{ NTU}$ ,  $1 \text{ mg TOC L}^{-1}$ ) with CTA hollow fibers having an initial  
370 permeability of  $230 \text{ L h}^{-1} \text{ m}^2 \text{ bar}^{-1}$ . The entire dataset of the baseline scenario is given in Table  
371 2. For this scenario, literature values indicate a maximum membrane operating life (*i.e.* 15  
372 years) and a minimum final productivity (*i.e.*  $100 \text{ L h}^{-1} \text{ m}^2 \text{ bar}^{-1}$ ) (Laîné, 2000). For this  
373 scenario, high remediation efficiencies (*i.e.* 95% for both BW and CIP) have been suggested  
374 in consistency with the high-quality input water. The two values for ( $\%_{\text{BW}}$ ,  $\%_{\text{CIP}}$ ) along with  
375 the literature values allow to evaluate the fouling rate ( $v_F$ ). The fouling rate (*i.e.*  $-7.9 \cdot 10^{-3} \text{ m}^{-1}$ )

376 actually corresponds to a decline in permeability equal to  $0.18 \text{ L h}^{-1} \text{ m}^2 \text{ bar}^{-1}$  per filtration  
377 cycle of 60 min at  $100 \text{ L h}^{-1} \text{ m}^2$ . It should be pointed out that such a low permeability decline  
378 in a drinking water plant can only be detected over a significant number of filtration cycles,  
379 which makes its validation from real data impossible. In this context, it was deemed relevant  
380 to have an order of magnitude of the percentage of fouled surface and to put it in  
381 perspective with the fouling rate. Its low value is in line with the low values of deposited  
382 turbidity and TOC during a filtration cycle as defined in the baseline scenario (100 NTU and  
383  $100 \text{ mg per m}^2$  of membrane surface, respectively). The turbidity deposit can be assimilated  
384 to  $330 \text{ mg}$  of bentonite (dry density  $2,500 \text{ kg m}^{-3}$ , particle size  $4 \mu\text{m}$ ), which means that only  
385 5% of the membrane surface is covered by bentonite particles at the end of a filtration cycle.  
386 This is coherent with the high-quality input water. Concerning the BW line, it is considered  
387 that 100% of the BW waste is sent back to the prefilter; the volume taken up by the sludge  
388 after decantation is supposed to be zero in the baseline scenario.

389         The full list of parameter values and their literature references are found in Table 2.  
390 For sake of clarity, input water quality categories and associated thresholds are provided in  
391 Appendix A (Table A.6).

392

393 **Table 2** User-defined and intrinsic parameters of the baseline scenario

<b>User-defined parameters</b>					
<b>Category</b>	<b>Input parameter</b>	<b>Unit</b>	<b>Literature reference</b>	<b>Suggested range</b>	<b>Baseline scenario</b>
<b>Output flow rate</b>	Specification output flow rate	m <sup>3</sup> day <sup>-1</sup>	>10,000 (Lainé et al., 2000)	>20,000	36,000
<b>Input water quality</b>	Input water turbidity	NTU	0-25 (Lainé et al., 2000)	0-500	1
	Input water TOC	mg L <sup>-1</sup>	-	0-20	1
<b>Module characteristics</b>	Module surface	m <sup>2</sup>	7-125 (Colas et al., 2002)	7-125	55
	Module void volume	m <sup>3</sup>	0-0.4 (Colas et al., 2002)	0-0.4	0.06
	Initial permeability (after initial decline)	L h <sup>-1</sup> m <sup>-2</sup> bar <sup>-1</sup>	230 (Bessiere, 2005)	200-270	230
	Specification filtration cycle duration	min	30-180 (Mallevalle et al., 1996), 10-60 (Chang et al., 2017)	0-180	60
<b>Filtration operating conditions</b>	Specification relative permeability decline during a filtration cycle	no unit	-	0-1	-
	Specification operating cycle duration	year	>5 (Lainé et al., 2000)	0.08-2	1
	Specification relative permeability decline during an operating cycle	no unit	-	0-1	-0.35
	Specification filtration flux	L h <sup>-1</sup> m <sup>-2</sup>	60-100 (Glucina et al., 1998), 50-200 mainly 80-100 (Lainé et al., 2000)	0-130	100
<b>BW operating conditions</b>	BW flux	L h <sup>-1</sup> m <sup>-2</sup>	140-270 (Chang et al., 2017)	140-350	250
	Volume per BW per unit surface	L m <sup>-2</sup>	5 (Glucina et al., 1998)	4-6	4.5
	BW chemical concentration	ppm	NaOCl: 5 (Glucina et al., 1998), 5 (Panglisch et al., 1998)	0-10	5
	BW chemical injection percentage	%	50 (Glucina et al., 1998)	0-100	50
<b>CIP operating conditions</b>	Number of CIP chemical phases	N/A	-	1-5	1
	CIP chemical concentration (phases 1-3)	g L <sup>-1</sup>	citric acid: 0.5% (Mallevalle et al., 1996),	0-5	1.5

			pH 3.5-4.0 (Eurofins, 2019)		
	CIP flux (phases 1-5) <sup>a</sup>	L h <sup>-1</sup> m <sup>-2</sup>	-	0-50	30
	CIP duration per rack (phases 1-3)	h	-	0-2	1
	CIP soak duration per rack (phases 1-3)	h	citric acid: 3 (Mallevalle et al., 1996)	0-5	2
	CIP phase 4 duration per rack per filling	h	-	0-2	1
	CIP phase 4 number of fillings per rack	N/A	-	0-6	5
	CIP volume per phase 5 per unit surface	L m <sup>-2</sup>	90 (Phase4+5) (Mallevalle et al., 1996)	0-50	20
<b>Pump efficiencies</b>	Pump efficiency (intake, BW, CIP)	%	70-90 (Méry, 2012)	70-90	70
	BW common pipe diameter	m	-	0-0.50	0.25
	CIP common pipe diameter	m	-	0-0.50	0.15
	Rack pipe diameter	m	<i>expert opinion</i>	0-0.50	0.25
<b>Piping system</b>	Rack pipe length between modules	m	<i>expert opinion</i> module diameter: 0-0.45 (Colas et al., 2002)	0-0.60	0.40
	CIP common pipe length to first block	m	-	0-10	5
	CIP common pipe length between blocks	m	<i>expert opinion</i> module diameter: 0-0.45 (Colas et al., 2002)	0-2	1.5
<b>Minor loss coefficients</b>	Common minor loss coefficient	no unit	0-30 (Idel'Cik, 1986)	0-30	15
	Prefilter minor loss coefficient	no unit	0-20 (Idel'Cik, 1986)	0-20	10
	Rack minor loss coefficient	no unit	0-15 (Idel'Cik, 1986)	0-15	8
<b>Intrinsic parameters</b>					
<b>Fouling rate and remediation efficiencies</b>	Fouling rate <sup>b</sup>	m <sup>-1</sup>	-7-0 (Delgrange, 2000), -5-0 (Lee et al., 2004)	-7-0	-7.9 10 <sup>-3</sup>
	BW efficiency <sup>c</sup>	%	0-100 (Bessiere, 2005; Remize, 2006)	0-100	95
	CIP efficiency <sup>c</sup>	%	-	0-100	95
	End-of-life operating life	year	>10 (Lainé et al., 2000)	3-15	15

<b>End-of-life conditions</b>	End-of-life permeability	L h <sup>-1</sup> m <sup>-2</sup> bar <sup>-1</sup>	<i>expert opinion</i>	100-200	100
	End-of-life number of BW cycles	N/A	100,000-200,000 (Mallevalle et al., 1996)	50,000-200,000	200,000
	End-of-life cxt for chlorine	g L <sup>-1</sup> h	5-20 (Arkangelsky et al., 2008), 5 (Gitis et al., 2006), >100 (Mallevalle et al., 1996)	5-100	100

---

394

395 <sup>a</sup> There is only one chemical phase in the baseline scenario. Parameter values (*e.g.* duration, chemical concentration) of phases 2 and 3 are thus  
396 equal to zero.

397 <sup>b</sup> In the baseline scenario, the fouling rate is not an intrinsic parameter but a parameter calculated from the BW and CIP efficiencies.

398 <sup>c</sup> In the baseline scenario, BW and CIP efficiencies are defined according to two conditions: a maximum operating life of 15 years and a  
399 minimum final productivity of 100 L h<sup>-1</sup> m<sup>-2</sup>.

400

401 **2.3.3. Life Cycle Impact Assessment (LCIA)**

402 Two recognized evaluation methods are used to calculate environmental impacts  
403 with the LCA software Umberto NXT: (1) IPCC's GWP100a that specifically evaluates the  
404 topical subject of climate change at midpoint (units in kg CO<sub>2</sub>-eq) and (2) ReCiPe endpoint  
405 method that consists in 17 impact categories (*e.g.* agricultural land occupation, human  
406 toxicity, fossil depletion, *etc.*) grouped in 3 areas of protection (*i.e.* ecosystem quality,  
407 human health and resource depletion) (units in points). Scores of these 17 categories can be  
408 aggregated into a unique score. The hierarchist cultural perspective is taken as ReCiPe  
409 default model.

410

411 **2.3.4. Interpretation**

412 A sensitivity analysis of environmental scores of the baseline scenario is carried out  
413 on the electricity mix. The nuclear-based electricity taken as reference is compared to  
414 French renewable electricity sources: hydropower, wind, biomass and solar. The precise  
415ecoinvent unit processes used are to be found in Appendix D.

416 The sensitivity of environmental scores to variations in several parameters for  
417 membrane operation is also studied through scenarios and trends that can be identified. The  
418 scenario-based approach is based on the same premise as the LCA approach developed in  
419 this work: process-oriented thinking for a realistic and physical representation of the studied  
420 system. As such, four plausible scenarios are elaborated based on the baseline scenario. As a  
421 reminder, the fouling rate, BW and CIP efficiencies in the baseline scenario have been  
422 adjusted by setting the membrane operating life, and initial and final permeabilities. In the  
423 four scenarios, the fouling rate and remediation efficiencies are hypothesized based on the  
424 defined operating conditions, and initial and final permeabilities; module operating life is not  
425 set anymore but calculated. Values defined for operating conditions and permeabilities are  
426 within the ranges found in the literature (see Table 2). Hypotheses need to be made on  
427 fouling rate and remediation efficiencies since no specific industrial or laboratory data is  
428 available. Qualitative information is however available in the literature that indicates the  
429 direction of change of these three intrinsic parameters as a function of operating conditions:  
430 a greater BW efficiency for a greater BW flux (Nakatskuka et al., 1996), a greater fouling rate  
431 for a lower quality input water (Mallevalle et al., 1996), a greater CIP efficiency for a greater  
432 CIP chemical concentration (Bird & Bartlett, 2002)...

433 Scenario A considers an operating strategy whereby BW flux is increased from 250 to  
434  $300 \text{ L h}^{-1} \text{ m}^{-2}$ . Given that an asymptotic-like behavior has been observed for BW efficiency  
435 increase with BW pressure (Nakatsuka et al., 1996; Kennedy et al., 1998), the hypothesis of  
436 BW efficiency increasing from 95 to 97% makes sense. In Scenario B, filtration flux is  
437 increased from 100 to  $130 \text{ L h}^{-1} \text{ m}^{-2}$ . The choice is made to adapt the filtration cycle duration  
438 from 60 to 46 min so as to maintain constant the deposited mass during a filtration cycle:  
439 since filtration flux is multiplied by 1.3, filtration cycle duration is divided by 1.3. The relative  
440 permeability decline during a filtration cycle thus also remains the same, and so does BW  
441 efficiency. Scenario C considers a degraded input water quality ( $2 \text{ mg TOC L}^{-1}$ ), thereby not  
442 only contributing to fouling but also making hydraulic removal by backwashing difficult  
443 (Alresheedi et al., 2019; Peiris et al., 2010; Peldszus et al., 2011; Teychene et al., 2018).  
444 These observations lead to suggest a lower fouling rate (*i.e.*  $-8.1 \cdot 10^{-3} \text{ m}^{-1}$ ) and BW efficiency  
445 (*i.e.* 93%). In scenario D, the same conditions as those for scenario C are taken, with the  
446 exception of a greater CIP chemical concentration (3 instead of  $1.5 \text{ g L}^{-1}$ ). Studies clearly  
447 indicate an influence of CIP chemical concentration on CIP efficiency (Bird and Bartlett, 2002;  
448 Nigam et al., 2008; Väisänen et al., 2002), hence the hypothesis of CIP efficiency increasing  
449 from 95 to 97%. Values that differ between the four aforementioned scenarios and the  
450 baseline scenario are summarized in Table 3.

451



452 **Table 3** Parameters of scenarios A to D compared to the baseline scenario (bold values differ  
 453 from the baseline scenario)

Input parameter			Scenario				
Category	User-defined parameter	Unit	Baseline	A	B	C	D
<b>Input water quality</b>	Input water TOC	mg L <sup>-1</sup>	1	1	1	<b>2</b>	<b>2</b>
<b>Filtration operating conditions</b>	Specification filtration cycle duration	min	60	60	<b>46</b>	60	60
	Specification filtration flux	L h <sup>-1</sup> m <sup>-2</sup>	100	100	<b>130</b>	100	100
<b>BW operating conditions</b>	BW flux	L h <sup>-1</sup> m <sup>-2</sup>	250	<b>300</b>	250	250	250
<b>CIP operating conditions</b>	CIP chemical concentration (Phase 1)	g L <sup>-1</sup>	1.5	1.5	1.5	1.5	<b>3</b>
Intrinsic parameter							
<b>End-of-life conditions</b>	End-of-life operating life	year	15	no max	no max	no max	no max

Regression function	Parameter	Unit	Scenario				
			Baseline	A	B	C	D
<b>Fouling rate</b>	v <sub>F</sub>	m <sup>-1</sup>	-7.9 10 <sup>-3</sup>	-7.9 10 <sup>-3</sup>	-7.9 10 <sup>-3</sup>	<b>-8.1 10<sup>-3</sup></b>	<b>-8.1 10<sup>-3</sup></b>
<b>BW efficiency</b>	% <sub>BW</sub>	%	95	<b>97</b>	95	<b>93</b>	<b>93</b>
<b>CIP efficiency</b>	% <sub>CIP</sub>	%	95	95	95	95	<b>97</b>

454

### 455 **3. Results**

#### 456 **3.1. LCI analysis and model verification**

457 The modelled inventory and the ecoinvent unit processes used for each input and  
 458 waste treatment are given in Appendix E. In what follows, calculated values found in this  
 459 table are compared to literature values for model verification, in particular for electricity  
 460 consumption and liquid waste (see Table 4).

461 It can be seen that the modelled value (kWh) for electricity consumption is  
 462 consistently lower than literature values. This is expected for Friedrich's (2001) value range  
 463 since it includes electricity consumptions of sand filtration and chlorination on top of UF,  
 464 which is moreover carried out in a cross-flow configuration as opposed to the less energy-  
 465 intensive dead-end filtration in our study (Glucina, 1998). Amongst the listed references,  
 466 Lipp et al.'s (1998) conditions are the most similar to ours in terms of filtration configuration,  
 467 membrane material and filtration operating conditions. The TMP is 28% higher than the  
 468 average TMP of the baseline scenario (0.6 bar), which in part explains that electricity values  
 469 are 3 to 4 times greater than the modelled value (kWh). The remaining difference may come  
 470 from the real-life context of Lipp et al.'s (1998) study, most importantly as regards

471 fluctuating input water quality; real surface water was either sand filtered or microstrained  
472 before being used as input to the pilot-scale ultrafiltration plant, leading to varying fouling  
473 rate and permeability decline. In contrast, a constant input water quality is considered in the  
474 baseline scenario of our study. More generally, our study considers constant filtration flux  
475 and a lack of shutdowns. The former model simplification removes pressure variations due  
476 to hydraulic shocks, whilst the latter implies no extra electricity for pump restart. As a result,  
477 electricity consumptions are underestimated as opposed to real-life measurements on pilot-  
478 or industrial-scale drinking water treatment plants, such as those in Chew et al.'s (2015,  
479 2016) and Glucina et al.'s (1998) studies. As regards Igos et al.'s (2014) and Liu and Mauter's  
480 (2020) work, absent details of operating conditions hinders complete analysis.

481           Relatively low discrepancies are obtained for water recovery, which is defined as the  
482 percentage of input water that leaves the UF unit as ultrafiltered water (see Table 4). The  
483 modelled value (95.2%) is similar to those found by Lipp et al. (1998) and Friedrich (2001).  
484 Given this correct order of magnitude and that concentrations of chemicals (*i.e.* sodium  
485 hypochlorite, citric acid, ammonia and sodium hydroxide) are based on literature values (see  
486 Table 2), it can be inferred that modelled values for chemical consumption are also in the  
487 correct order of magnitude.

488

489

490

**Table 4** Baseline scenario – Consumption and waste comparison with literature studies on ultrafiltration of surface water

Reference	Electricity		Water recovery (%)	Input water	Membrane material
	Value (kWh m <sup>-3</sup> )	Comment			
Baseline scenario	0.034	TMP 0.43-1.0 bar (average 0.6), 1h dead-end filtration cycles at 100 L h <sup>-1</sup> m <sup>-2</sup> , CIP every 365 days.	95.2	Surface water (1 NTU, 1 mg TOC L <sup>-1</sup> )	CTA
Lipp et al., 1998	0.10-0.15	1h dead-end filtration cycles at 100 L m <sup>-2</sup> h <sup>-1</sup> . TMP 0.77 bar, CIP after 390 days	92.5-95.0	Ozonated and sand filtered surface water (0.1 NTU)	Cellulose derivative
Friedrich, 2001	0.50-0.72	Total consumption of sand filtration, UF and chlorination. Cross-flow filtration (50 and 100 L m <sup>-2</sup> h <sup>-1</sup> ). Max TMP 0.8-1.0, CIP every 15 days,	95 <sup>a</sup>	Sand filtered surface water	Polysulfone

		unknown BW frequency.			
Igos et al., 2014	0.097 and 0.16	N/A	N/A	Ozonated and sand filtered surface water	N/A
Glucina et al., 1998	0.22	30 min dead-end filtration cycles at 100 L m <sup>-2</sup> h <sup>-1</sup> . TMP 0.61 bar, no CIP.	90	Prefiltered (200 mm) surface water	N/A
Chew et al., 2015; Chew et al., 2016	0.099	30 min dead-end filtration at 81 L m <sup>-2</sup> h <sup>-1</sup> , CIP every 24 filtration sequences.	89 <sup>b</sup>	Sand filtered surface water (1-4 NTU)	Modified polyethersulfone
Liu and Mauter, 2020	0.2-0.3	National survey of 3,728 plants.	N/A	N/A	N/A

N/A non available

<sup>a</sup> assumption (Friedrich, 2001)

<sup>b</sup> cumulated value for UF and sand filtration

449 **3.2. Impacts of the baseline scenario**

450 In the baseline scenario, the operation of hollow fiber membranes for the production  
451 of 1 m<sup>3</sup> of ultrafiltered water generates impacts amounting to 4.1 10<sup>-3</sup> kg CO<sub>2</sub>-eq and 4.5 10<sup>-4</sup>  
452 points for IPCC GWP100a and ReCiPe endpoint scores respectively. Process inputs and waste  
453 are grouped in clusters for the study of their respective contributions (see Appendix E). The  
454 cluster “CIP chemicals” for example aggregates citric acid, ammonia and sodium hydroxide.  
455 More than 99% of both IPCC GWP100a and ReCiPe scores are attributable to the BW  
456 chemical and electricity production. Indeed, BW chemical production contributes to 57% and  
457 54% of IPCC GWP100a and ReCiPe scores, respectively. Electricity production contributes to  
458 43% and 45% of respective scores (see Appendix F for further results). In particular, intake  
459 pumping accounts for the major part (90%) of electricity consumption, whereas BW  
460 pumping accounts for the remaining 10%. The contribution of CIP pumping to energy  
461 consumption is negligible. These relative contributions are in line with the average TMP and  
462 cumulative duration of each operating mode (filtration, BW and CIP).

463 It can further be noted that annual cleaning-in-place has very insignificant impacts  
464 (<2%). Not only is pumping during CIP phases negligible (<0.01%) compared to total  
465 electricity consumption but negligible impacts are also observed for CIP chemicals and waste  
466 treatment.

467 The detailed ReCiPe results are presented in Fig. 4. for all impact categories and by  
468 cluster. Three endpoint impact categories account together for around 70% of total  
469 endpoint impacts: fossil depletion, climate change for human health and climate change for  
470 ecosystem quality. It is to be noted that climate change results with the ReCiPe endpoint  
471 method correspond to damages (expressed in points) due to temperature elevation,  
472 whereas IPCC GWP100a results consider radiative forcing to express climate change at  
473 midpoint in kg CO<sub>2</sub>-eq.

474 For each impact category, distributions between the clusters “BW chemical” and  
475 “electricity” are between 55 and 57% for the former, and between 42 and 44% for the latter.  
476 These distributions for specific ReCiPe impact categories are similar to those for total ReCiPe  
477 endpoint scores. The dominant impacts of fossil depletion, climate change, particulate  
478 matter formation and ionizing radiation are correlated with each other since they  
479 correspond to impacts of energy production and consumption (i.e. electricity used in the  
480 foreground process and energy used for chemical production).

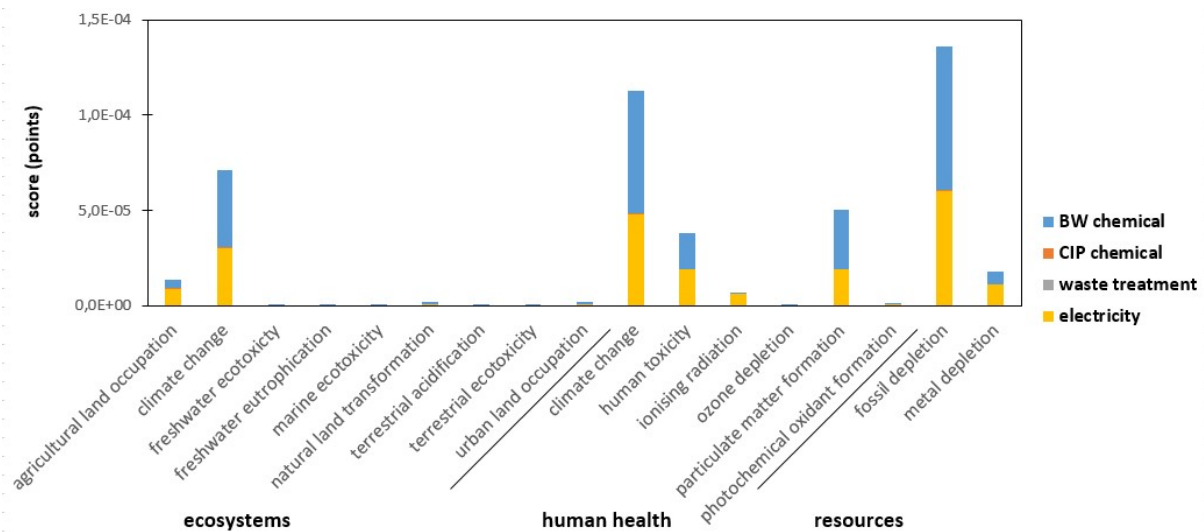

482

483 **Fig. 4.** Baseline scenario – Contribution of process inputs and waste of membrane operation  
 484 to ReCiPe endpoint impact categories (normalized to the functional unit)

485

486 The important contribution of electricity consumption in environmental results leads  
 487 to ponder on the influence of the electricity source. In this work, the assumedecoinvent unit  
 488 process relates to a French electricity mix composed of 71% nuclear, 10% hydropower, 6%  
 489 natural gas, 4% wind, 2% coal and 7% other (including oil, biomass, biogas). Given the  
 490 ongoing sustainable developments of the sector, French renewable electricity sources are  
 491 considered for a sensitivity analysis: hydropower, wind, biomass and solar. Total life cycle  
 492 IPCC GWP100a results are 40%, 36%, 20% and 10%, respectively, lower compared to that of  
 493 the baseline scenario with French electricity mix. Total life cycle ReCiPe endpoint results are  
 494 42%, 35%, 8% lower for system with hydropower, wind and solar respectively compared to  
 495 the system using French electricity mix. Total life cycle impacts are however 1050% greater  
 496 for system with biomass cogeneration due to predominant impacts on urban land  
 497 occupation. This sensitivity analysis clearly points out the influence of the electricity mix on  
 498 environmental impacts.

### 499 3.3. Influence of operating conditions

500 As a reminder, four scenarios are considered to study the sensitivity of environmental  
 501 scores to variations of operating conditions (see Table 3 for parameter values).

502 For these four scenarios, values of calculated parameters are coherent with changes  
 503 in input parameters (see Appendix G for extensive values). For scenario A, the module  
 504 operating life increases by 36% compared to the baseline scenario (from 15.0 to 23.5 years)

505 due to increased BW efficiency by 2%. The end-of-life condition is not the minimum  
506 permeability ( $100 \text{ L h}^{-1} \text{ m}^{-2} \text{ bar}^{-1}$ ) anymore but the maximum number of BW cycles, which  
507 has been reached and set at 200,000. This is the top value in the suggested range (see Table  
508 2). Without the end-of-life condition on mechanical resistance, the module operating life  
509 would have been 37.9 years, which is unrealistic. In scenario A, the final permeability equals  
510  $151 \text{ L h}^{-1} \text{ m}^{-2} \text{ bar}^{-1}$ . The filtration average permeability is thus greater than in the baseline  
511 scenario, which in part explains the lower filtration average TMP (0.54 instead of 0.60 bar).  
512 The second reason is the greater BW efficiency (97 instead of 95%), meaning that there is  
513 more permeability recovery at the end of a BW cycle. It follows that energy consumption  
514 falls. Sodium hypochlorite consumption remains constant however since injection conditions  
515 (duration, volume, frequency) of the BW chemical are the same. In scenario A, the change in  
516 BW flux impacts on the BW efficiency only, not on the injected volume of sodium  
517 hypochlorite since the volume used during each BW cycle is unchanged. CIP chemical  
518 consumption varies by 4.5% since a CIP occurs every 1.02 year (23 CIPs in 23.5 years)  
519 compared to every 1.07 years for the baseline scenario (14 CIPs in 15.0 years).

520 For scenario B, the number of modules is 192 compared to 252 in the baseline  
521 scenario, and the average TMP during filtration rises from 0.60 to 0.79 bar. These variations  
522 are proportional to the increased filtration flux. The operating cycle duration (i.e. CIP  
523 frequency) is also impacted and falls from 365 to 296 days. Whereas CIPs in the baseline  
524 scenario start when the maximum operating cycle duration is reached, CIPs in scenario B  
525 start when the maximum relative permeability decline during an operating cycle is reached.  
526 It has been defined as equal to  $-0.35$  in all scenarios, which is equivalent to a permeability of  
527  $150 \text{ L h}^{-1} \text{ m}^{-2}$  for the first operating cycle. This threshold permeability is reached sooner in  
528 scenario B because the relative permeability decline of  $-7.9 \cdot 10^{-4}$  during a filtration cycle  
529 occurs after 46 min only, as compared to 60 min in the baseline scenario. Like for scenario A,  
530 no change in sodium hypochlorite consumption is observed: injection conditions are the  
531 same. Indeed, sodium hypochlorite is still injected every  $100 \text{ L m}^{-2}$  even if backwashing  
532 occurs every 46 min instead of 60 min. Despite more frequent CIPs, the consumption of CIP  
533 chemicals decreases by 11% due to a lower number of blocks (4 instead of 7) and modules  
534 per row (12 instead of 9). On a per module basis, the volume needed to fill pipes is reduced  
535 to  $1.04 \text{ m}^3$ .

536 In scenario C, the operating life falls from 15.0 to 10.2 years due to decreased BW  
537 efficiency and fouling rate. These unfavourable conditions first lead to shorter operating  
538 cycles (265 instead of 365 days). Like for scenario B, the maximum relative permeability  
539 decline during an operating cycle is reached before the maximum operating cycle duration.  
540 The greater CIP frequency leads to a 37% increase in CIP chemical consumption. Then, the  
541 end-of-life condition of minimum permeability ( $100 \text{ L h}^{-1} \text{ m}^{-2} \text{ bar}^{-1}$ ) is reached. Given that the  
542 initial and final permeabilities are the same as for the baseline scenario, the filtration  
543 average TMP does not significantly change: 0.60 bar.

544 In scenario D, the increased CIP efficiency offsets the decreased BW efficiency.  
545 Indeed, the operating life (*i.e.* 16.0 years) is greater than in the baseline scenario and  
546 scenario C. Operating cycles still last 265 like in scenario C since values for the fouling rate  
547 and BW efficiency are identical. CIPs start due to the maximum relative permeability decline  
548 during an operating cycle being reached. As expected, CIP chemical consumption increases  
549 proportionally with respect to the CIP chemical concentration (from 1.5 to  $3.0 \text{ g L}^{-1}$ ).

550 The question that arises now is whether these variations are significant from an  
551 environmental point of view. Environmental scores and contributions of cluster process  
552 inputs and waste for membrane operation only are very similar between scenarios A, C and  
553 D and the baseline scenario: percentage changes are 2% at the most (see Table 5 and Fig. 5.).  
554 This is not surprising since average TMP during filtration, BW frequency and duration are  
555 similar or identical. It is furthermore known from model calculations that intake pumping  
556 contributes to more than 90% to electricity consumption and that the two clusters  
557 “electricity” and “BW chemical” are the greatest contributors to environmental scores. Not  
558 only are electricity and BW chemical consumptions similar between these scenarios, water  
559 recovery rates are too (*i.e.* 95%). As shown in Table 5, specific electricity and BW chemical  
560 consumptions are thus also similar (maximum 5.7% of absolute difference).

561 Unlike in scenario B, it can be concluded that environmental scores are insensitive to  
562 the studied variations of ( $v_F$ , %<sub>BW</sub>, %<sub>CIP</sub>) in scenarios A, C and D, that is for a cut-off of 2% in  
563 absolute values. This should however not be generalized since other operating conditions  
564 could lead to these same variations of ( $v_F$ , %<sub>BW</sub>, %<sub>CIP</sub>) but to different environmental scores.  
565 For example, differences in final permeability, and consequently in average TMP during  
566 filtration, may be observed when the limiting end-of-life condition is different. This is the  
567 case for scenario A for which the module operating life is determined by the maximum



568 number of BW cycles. Moderate changes in environmental impacts are observed (2% in  
 569 absolute values), which could moreover be more significant if a threshold lower than  
 570 200,000 BW cycles were to be defined. The filtration cycle duration in all three scenarios is  
 571 also the same as in the baseline scenario. Changing this filtration cycle duration would  
 572 impact on BW efficiency, as well as on specific consumptions. The influence of ( $v_F$ , %<sub>BW</sub>, %<sub>CIP</sub>)  
 573 on environmental impacts should then be reassessed under these other operating  
 574 conditions. In short, a first prerequisite is to determine precisely the end-of-life thresholds  
 575 (e.g. minimum permeability, maximum number of BW cycles). A second prerequisite is to  
 576 determine the influence of filtration cycle duration on BW efficiency.

577 In scenario B, a high sensitivity of environmental scores to changes in filtration flux  
 578 and filtration cycle duration is observed; depending on the considered evaluation method,  
 579 scores are 29 or 31% greater in scenario B compared to the baseline scenario (see Table 5).  
 580 Contributions of electricity production rise at the expense of BW chemical fabrication: from  
 581 42-45% in the baseline scenario to 56-59% in scenario B. It can be concluded that the  
 582 influence of the increased filtration flux in scenario B is greater than that of the increased  
 583 BW frequency, regardless of the evaluation method or ReCiPe endpoint impact category.  
 584

585 **Table 5** Percentage change in environmental scores compared to the baseline scenario

Environmental scores or consumptions	Percentage change (%) compared to the baseline scenario			
	Scenario			
	A	B	C	D
IPCC GWP100a	-2	29	0	1
ReCiPe endpoint	-2	31	0	1
Electricity	-5.7	72	0.4	0.1
BW chemical	0.6	-2.0	-0.1	-0.1
CIP chemicals	4.5	-11	37	181

586

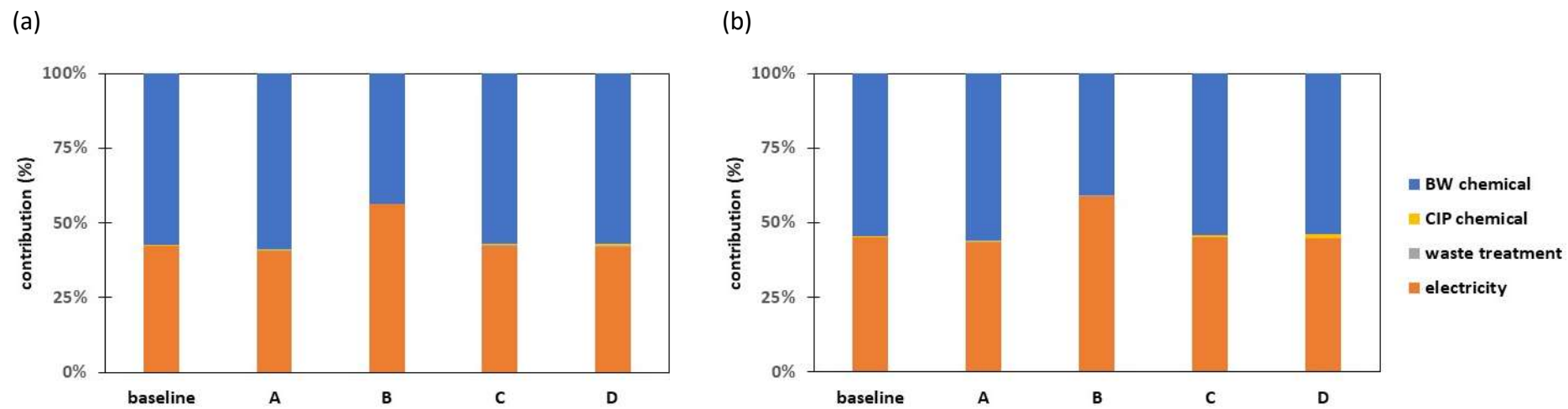

**Fig. 5.** Contribution of cluster process inputs and waste for membrane operation to (a) IPCC GWP100a and (b) ReCiPe endpoint results

615 **3.4. Analysis of global trends**

616 The study confirms that electricity and BW chemical production are two major points of  
617 interest for mitigating environmental impacts of the ultrafiltration stage with CTA inside-out  
618 hollow fibers. Mitigating impacts from BW chemical consumption can first of all consist in  
619 adjusting BW operating conditions (*i.e.* injection time, concentration) to avoid overconsumption  
620 due to precautionary measures; variations in environmental scores are sensitive to these  
621 adjustments. For example, halving the BW chemical concentration from 5 to 2.5 ppm in the  
622 baseline scenario decreases GWP100 and ReCiPe endpoint scores by 29 and 27%, respectively.  
623 Microbial proliferation prevention strategies can also be considered, such as using better suited  
624 materials to biofouling for membrane and module components. Chemical compounds with a  
625 lower environmental footprint than sodium hypochlorite can also be investigated. Mitigation  
626 strategies related to electricity consumption can consist in fabricating more permeable and/or  
627 low-fouling membranes: the initial permeability and fouling rate would respectively be higher  
628 and lower, thereby providing a higher average permeability. Given that intake pumping  
629 accounts for the majority of electricity consumption in all considered scenarios (*i.e.* a minimum  
630 of 88% for scenario B), it is also particularly impactful to focus on filtration sequences when it  
631 comes to adjusting operating conditions. In this respect, the comparison between the baseline  
632 scenario and scenario B shows filtration flux as a relevant operating condition to act on: the  
633 percentage variation in environmental scores is inversely proportional to the percentage  
634 variation in filtration flux. The sensitivity analysis on the electricity mix also shows that using  
635 renewable energy sources (especially hydropower and wind energy) can mitigate  
636 environmental impacts to the same extent as lowering filtration flux. By extension, these two  
637 measures combined have the potential to halve these impacts, provided necessary structural  
638 adaptations are made. Hydropower requires falling or fast-running water near the drinking  
639 water plant, as well as appropriate infrastructure. Wind energy requires favorable local  
640 conditions and its fluctuating nature implies using storage and/or at least one controllable  
641 source of energy. As for lower filtration fluxes, the greater number of modules to be installed  
642 implies capital expenditure and extra floor area in the drinking water plant itself. Such changes  
643 (if technically feasible) call for long-term planning whereas acting on BW chemical consumption

644 can be based on simple trial and error tests followed by a swift implementation, which seems  
645 adapted as a first-line optimization strategy given limited resources.

646 As regards the developed model, this study has showed that operating conditions have  
647 an influence on both process parameters and environmental impacts. In particular, the high  
648 sensitivity of module operating life and the number of filtration cycles to operating conditions  
649 (see Appendix G) calls for a detailed knowledge of the three key intrinsic parameters: fouling  
650 rate, BW and CIP efficiencies. Finding relevant and complete datasets of these parameters in  
651 the literature is compromised by the long time scale (several years) and the confidentiality of  
652 industrial values. Ideally, TMP values over time for different qualities of input water could serve  
653 as a basis for a statistical analysis and modelling of these three parameters as a function of  
654 input water quality, membrane material and operating conditions. Access and analysis of such  
655 data would represent an improvement over the pragmatic approach of associating threshold  
656 operating conditions to input water quality categories based on turbidity and TOC.

657 The dependency of the number of modules and their operating life to operating  
658 conditions reveals that module consumption varies from one scenario to another. The  
659 associated environmental impacts are related to the fabrication stage of the modules' life cycle.  
660 A previous study specifically considered a generic process modelling and LCA approach for UF  
661 membrane fabrication (Prézéus et al., 2020). Although this stage is beyond the scope of this  
662 study, taking it into account opens up prospects on the eco-design of membrane modules on a  
663 life cycle scale. New questions that arise are the relative impacts of fabrication, operation and  
664 end of life, and the key operating conditions of each stage for environmental mitigation. The  
665 underlying objective is not only to ecodesign membrane filtration as a unit operation but to  
666 ecodesign sequences of unit operations making up an entire production process. Ultimately,  
667 membrane-based production processes can be compared from an environmental point of view  
668 to conventional ones, and serve as criteria in the decision-making of design for drinking water  
669 production from ground or surface water.

#### 670 **4. Conclusion**

671 The methodological novelty of this study, whereby process modelling is coupled with  
672 LCA, is of importance for the scientific community since the influence of operating conditions

673 on environmental impacts can be fully investigated and serve as a basis for impact mitigation.  
674 The generic model that has been developed following this approach addresses the complexity  
675 and specificity of membrane operation, especially regarding fouling and remediation methods.  
676 Variations of relative permeability are calculated from key model parameters (*i.e.* fouling rate,  
677 BW and CIP efficiencies). The model could moreover be improved by correlating these three  
678 parameters to relevant operating conditions such as input water quality, BW and CIP  
679 conditions. A statistical analysis of a large dataset would be an appropriate tool.

680         The initial results obtained with the generic process modelling–LCA model put forth the  
681 predominant contributions of electricity production and BW chemical fabrication to GWP100a  
682 and ReCiPe endpoint scores. Mitigation strategies include further reducing total dynamic head  
683 of the system and fine tuning BW operating conditions. LCA results also confirm that  
684 environmental impacts may be sensitive to changes in operating conditions, notably when  
685 considering filtration flux and filtration cycle duration. This demonstrates the relevance of such  
686 a parameterized model of the membrane operation stage, as compared to conducting a LCA  
687 with fixed operating conditions.

688         The flexibility and modularity of the developed generic model allow its use beyond the  
689 presented case study. Membrane materials other than CTA can for example be examined by  
690 adapting values of material-specific parameters such as initial permeability, fouling rate and CIP  
691 conditions. The same holds for other applications, such as direct filtration of low input water  
692 quality (e.g. higher TOC and turbidity) with an online addition of a coagulant. It would involve,  
693 among other things, new values for input water quality and thresholds associated with input  
694 water categories, as well as the integration of the coagulant in the life cycle inventory. The  
695 model could also be adapted to a cross-flow configuration; recirculation would need to be  
696 taken into account with an additional pump, a modified piping system and included in input  
697 water quality calculations. Lastly, other types of filtration (*e.g.* microfiltration, nanofiltration)  
698 can be considered.

699         As regards the integration of environmental evaluation in membrane science and  
700 technology, our model development for membrane operation is only but a first step since the  
701 same approach must be carried out on the other life cycle's stages, namely membrane

702 fabrication and end of life. In this way, it will be possible to fully ecodesign membranes by  
703 determining key mitigation parameters and strategies, and compare membrane-based  
704 production processes to conventional ones on a rigorous basis.

#### 705 **Conflicts of interest**

706 There are no conflicts to declare.

#### 707 **Acknowledgments**

708 This work was financially supported by Université Fédérale de Toulouse (PRES) and Région  
709 Occitanie/Pyrénées-Méditerranée, France. The authors would like to thank Aquasource (SUEZ)  
710 for its technical expertise and Dr. Philippe Aptel for his comments and suggestions.

#### 711 **References**

712

713 Alresheedi, M.T., Barbeau, B., Basu, O.D., 2019. Comparisons of NOM fouling and cleaning of  
714 ceramic and polymeric membranes during water treatment. *Sep. Purif. Technol.* 209, 452-460.

715

716 Arkhangelsky, E., Goren, U., Gitis, V., 2008. Retention of organic matter by cellulose acetate  
717 membranes cleaned with hypochlorite. *Desalination* 223(1-3), 97-105.

718

719 Bersillon, J.L., Anselme, C., Mallevalle, J., Aptel, P., Fiessinger, F., 1989. L'ultrafiltration  
720 appliquée au traitement de l'eau potable : le cas d'un petit système. *Eau Ind. Nuis.* 1, 61-64.

721

722 Bessiere, Y., 2005. Filtration frontale sur membrane : mise en évidence du volume filtré critique  
723 pour l'anticipation et le contrôle du colmatage (Doctoral dissertation). Université Paul Sabatier,  
724 Toulouse III.

725

726 Bessiere, Y., Bacchin, P., Jefferson, B., 2005. Dead-end filtration of natural organic matter:  
727 experimental evidence of critical conditions. *Desalination* 175(1), 29-36.

728

729 Bird, M.R., Bartlett, M., 2002. Measuring and modelling flux recovery during the chemical  
730 cleaning of MF membranes for the processing of whey protein concentrate. *J. Food Eng.* 53(2),  
731 143-152.  
732

733 Bonton, A., Bouchard, C., Barbeau, B., Jedrzejak, S., 2012. Comparative life cycle assessment of  
734 water treatment plants. *Desalination* 284, 42-54.  
735

736 Brehant, A., Glucina, K., Le Moigne, I., Laine, J.M., 2009. Risk management approach for  
737 monitoring UF membrane integrity and experimental validation using Ms2-phages.  
738 *Desalination Water Treat.* 9(1-3), 195-200.  
739

740 Cabassud, C., Anselme, C., Bersillon, J.L., Aptel, P., 1991. Ultrafiltration as a nonpolluting  
741 alternative to traditional clarification in water treatment. *Filtr. Separat.* 28(3), 194-198.  
742

743 Chang, H., Liang, H., Qu, F., Liu, B., Yu, H., Du, X., Li, G., Snyder, S.A., 2017. Hydraulic  
744 backwashing for low-pressure membranes in drinking water treatment: A review. *J. Membrane*  
745 *Sci.* 540, 362-380.  
746

747 Chew, C.M., Aroua, M.K., Hussain, M.A., Ismail, W.W., 2015. Practical performance analysis of  
748 an industrial-scale ultrafiltration membrane water treatment plant. *J. Taiwan Instt. Chem. E.* 46,  
749 132-139.  
750

751 Chew, C.M., Aroua, M.K., Hussain, M.A., Ismail, W.M.Z.W., 2016. Evaluation of ultrafiltration  
752 and conventional water treatment systems for sustainable development: an industrial scale  
753 case study. *J. Clean. Prod.* 112, 3152-3163.  
754

755 Clark, M.M., Heneghan, K.S., 1991. Ultrafiltration of lake water for potable water production.  
756 *Desalination* 80(2-3), 243-249.  
757

758 Coelho, F., Leclerc, J., Bourdiol, D., Valentin A.C., Sauvade, P., 2019. 30 years of evolution in  
759 ultrafiltration systems and processes for drinking water production. IWA MTC, Toulouse.  
760

761 Colas, F., Bonn elye, V., Abidine, N., 2002. Development of a new hollow-fiber module for large  
762 ultrafiltration plants. *Desalination* 148(1-3), 389-394.  
763

764 Crozes, G., 1994. Contribution   l' tude du colmatage irr versible en ultrafiltration appliqu e au  
765 traitement d'eau potable (Doctoral dissertation). Institut National des Sciences Appliqu es de  
766 Toulouse.  
767

768 Delgrange, N., 2000. Mod lisation par r seaux de neurones et conduite d'un pilote  
769 d'ultrafiltration pour la production d'eau potable (Doctoral dissertation). INSA de Toulouse.  
770

771 Eurofins, 2019. List of filtration membranes with an ACS Certificate. Retrieved April 1, 2020  
772 from [https://www.eurofins.fr/environnement/analyses/expertises/alimentarite%20-%20des-](https://www.eurofins.fr/environnement/analyses/expertises/alimentarite%20-%20des-mat%20-%20riaux/)  
773 [mat%20-%20riaux/](https://www.eurofins.fr/environnement/analyses/expertises/alimentarite%20-%20des-mat%20-%20riaux/).  
774

775 Friedrich, E., 2001. The Use of Environmental Life Cycle Assessment for the Production of  
776 Potable Water (Masters dissertation). School of Chemical Engineering, University of Natal,  
777 Durban, South Africa.  
778

779 Gitis, V., Haught, R.C., Clark, R.M., Gun, J., Lev, O., 2006. Application of nanoscale probes for the  
780 evaluation of the integrity of ultrafiltration membranes. *J. Membrane Sci.* 276(1-2), 185-192.  
781

782 Glucina, K., La n , J.M., Durand-Bourlier, L., 1998. Assessment of filtration mode for the  
783 ultrafiltration membrane process. *Desalination* 118(1-3), 205-211.  
784

785 Howe, K.J., Clark, M.M., 2002. Fouling of microfiltration and ultrafiltration membranes by  
786 natural waters. *Environ. Sci. Technol.* 36(16), 3571-3576.



787

788 Idel’Cik, I.E. (Ed.), 1986. Mémento des Pertes de Charges : Coefficients de Pertes de Charges  
789 Singulières et de Pertes de Charge. Editions Eyrolles, Paris.

790

791 Igos, E., Dalle, A., Tiruta-Barna, L., Benetto, E., Baudin, I., Mery, Y., 2014. Life Cycle Assessment  
792 of water treatment: what is the contribution of infrastructure and operation at unit process  
793 level? J. Clean. Prod. 65, 424-431.

794

795 Inge GmbH, 2014. Operator's Manual 2.1.

796

797 International Organization for Standardization, 2006. ISO 14040:2006 Environmental  
798 management - Life Cycle Assessment - Principles and framework. Geneva, Switzerland.

799

800 Jacangelo, J.G., Trussell, R.R., Watson, M., 1997. Role of membrane technology in drinking  
801 water treatment in the United States. Desalination 113(2-3), 119-127.

802

803 Jermann, D., Pronk, W., Kägi, R., Halbeisen, M., Boller, M., 2008. Influence of interactions  
804 between NOM and particles on UF fouling mechanisms. Water Res. 42(14), 3870-3878.

805

806 Kennedy, M., Kim, S.M., Mutenyo, I., Broens, L., Schippers, J., 1998. Intermittent crossflushing  
807 of hollow fiber ultrafiltration systems. Desalination 118(1-3), 175-187.

808

809 Laîné, J.M., Vial, D., Moulart, P., 2000. Status after 10 years of operation—overview of UF  
810 technology today. Desalination 131(1-3), 17-25.

811

812 Lee, N., Amy, G., Croue, J.P., Buisson, H., 2004. Identification and understanding of fouling in  
813 low-pressure membrane (MF/UF) filtration by natural organic matter (NOM). Water Res.  
814 38(20), 4511-4523.

815

816 Levitsky, I., Naim, R., Duek, A., Gitis, V., 2012. Effect of time in chemical cleaning of  
817 ultrafiltration membranes. *Chem. Eng. Technol.* 35(5), 941-946.  
818

819 Lipp, P., Baldauf, G., Schick, R., Elsenhans, K., Stabel, H.H., 1998. Integration of ultrafiltration to  
820 conventional drinking water treatment for a better particle removal—efficiency and costs?.  
821 *Desalination* 119(1-3), 133-142.  
822

823 Liu, Y., Mauter, M.S., 2020. Assessing the demand response capacity of US drinking water  
824 treatment plants. *Appl. Energ.* 267, 114899.  
825

826 Mallevalle, J., Odendaal, P.E., Wiesner, M.R., 1996. *Water Treatment Membrane Processes*.  
827 Mc-Graw-Hill, New York.  
828

829 Manda, B.K., Worrell, E., Patel, M.K., 2014. Innovative membrane filtration system for  
830 micropollutant removal from drinking water—prospective environmental LCA and its integration  
831 in business decisions. *J. Clean. Prod.* 72, 153-166.  
832

833 Méry, Y., 2012. Development of an integrated tool for Process Modelling and Life Cycle  
834 Assessment-Ecodesign of process plants and application to drinking water treatment (Doctoral  
835 dissertation). INSA de Toulouse.  
836

837 Mery, Y., Tiruta-Barna, L., Benetto, E., Baudin, I., 2013. An integrated “process modelling-life  
838 cycle assessment” tool for the assessment and design of water treatment processes. *Int. J. Life  
839 Cycle Ass.* 18(5), 1062-1070.  
840

841 Nakatsuka, S., Nakate, I., Miyano, T., 1996. Drinking water treatment by using ultrafiltration  
842 hollow fiber membranes. *Desalination* 106(1-3), 55-61.  
843

844 Nigam, M.O., Bansal, B., Chen, X.D., 2008. Fouling and cleaning of whey protein concentrate  
845 fouled ultrafiltration membranes. *Desalination* 218(1-3), 313-322.  
846

847 Panglisch, S., Dautzenberg, W., Kiepke, O., Gimbel, R., Gebel, J., Kirsch, A., Exner, M., 1998.  
848 Ultra- and microfiltration pilot plant investigations to treat reservoir water. *Desalination* 119(1-  
849 3), 277-287.  
850

851 Peiris, R.H., Budman, H., Moresoli, C., Legge, R.L., 2010. Understanding fouling behaviour of  
852 ultrafiltration membrane processes and natural water using principal component analysis of  
853 fluorescence excitation-emission matrices. *J. Membrane Sci.* 357(1-2), 62-72.  
854

855 Peldszus, S., Hallé, C., Peiris, R.H., Hamouda, M., Jin, X., Legge, R.L., Budman, H., Moresoli, C.,  
856 Huck, P.M., 2011. Reversible and irreversible low-pressure membrane foulants in drinking  
857 water treatment: Identification by principal component analysis of fluorescence EEM and  
858 mitigation by biofiltration pretreatment. *Water Res.* 45(16), 5161-5170.  
859

860 Pellegrin, B., Gaudichet-Maurin, E., Causserand, C., 2013. Mechano-chemical ageing of PES/PVP  
861 ultrafiltration membranes used in drinking water production. *Water Sci. Technol.* 13(2), 541-  
862 551.  
863

864 Prézéus, F., Tiruta-Barna, L., Guigui, C., Remigy, J.C., 2020. A generic process modelling–LCA  
865 approach for UF membrane fabrication: Application to cellulose acetate membranes. *J.*  
866 *Membrane Sci.* 618, 118594.  
867

868 Porcelli, N., Judd, S., 2010. Effect of cleaning protocol on membrane permeability recovery: A  
869 sensitivity analysis. *J. Am. Water Works Ass.* 102(12), 78-86.  
870

871 Regula, C., Carretier, E., Wyart, Y., Gésan-Guiziou, G., Vincent, A., Boudot, D., Moulin, P., 2014.  
872 Chemical cleaning/disinfection and ageing of organic UF membranes: a review. *Water Res.* 56,  
873 325-365.

874

875 Remize, P.J., 2006. Étude des rétrolavages assistés par l'air et contrôle du colmatage résiduel.  
876 Application à la production d'eau potable en filtration frontale (Doctoral dissertation). INSA de  
877 Toulouse.

878

879 Ribera, G., Clarens, F., Martínez-Lladó, X., Jubany, I., Martí, V., Rovira, M., 2014. Life cycle and  
880 human health risk assessments as tools for decision making in the design and implementation  
881 of nanofiltration in drinking water treatment plants. *Sci. Total Environ.* 466, 377-386.

882

883 Rouaix, S., Causserand, C., Aimar, P., 2006. Experimental study of the effects of hypochlorite on  
884 polysulfone membrane properties. *J. Membrane Sci.* 277(1-2), 137-147.

885

886 Teychene, B., Touffet, A., Baron, J., Welte, B., Joyeux, M., Gallard, H., 2018. Predicting of  
887 ultrafiltration performances by advanced data analysis. *Water Res.* 129, 365-374.

888

889 Touffet, A., Baron, J., Welte, B., Joyeux, M., Teychene, B., Gallard, H., 2015. Impact of  
890 pretreatment conditions and chemical ageing on ultrafiltration membrane performances.  
891 Diagnostic of a coagulation/adsorption/filtration process. *J. Membrane Sci.* 489, 284-291.

892

893 Väisänen, P., Bird, M.R., Nyström, M., 2002. Treatment of UF membranes with simple and  
894 formulated cleaning agents. *Food Bioprod. Processing* 80(2), 98-108.

895

896 Vince, F., Aoustin, E., Bréant, P., Marechal, F., 2008. LCA tool for the environmental evaluation  
897 of potable water production. *Desalination* 220(1-3), 37-56.

898

899

900

901 **Appendices**

902 **A – Model parameters and modelling equations**

903 **A.1. Data Description**

904 In a first section, model parameters and equations of material and energy balances are given.  
905 Table A.1 lists user-defined parameters, whereas Table A.2 lists phenomenological parameters.  
906 Modelling equations are then given according to the calculation sequence (see Fig. A.1.), which  
907 corresponds to the following chronological order:

- 908 - Input water category and associated thresholds (no equations);
- 909 - Relative permeability variations (equations 1 to 10);
- 910 - Module operating life subject to end-of-life conditions (equations 11 to 31, and Table A.3);
- 911 - Number of modules and blocks (equations 32 to 39, and Table A.4);
- 912 - Piping system and fluid circulation (equations 40 to 70);
- 913 - Consumptions and waste (equations 71 to 80).

914

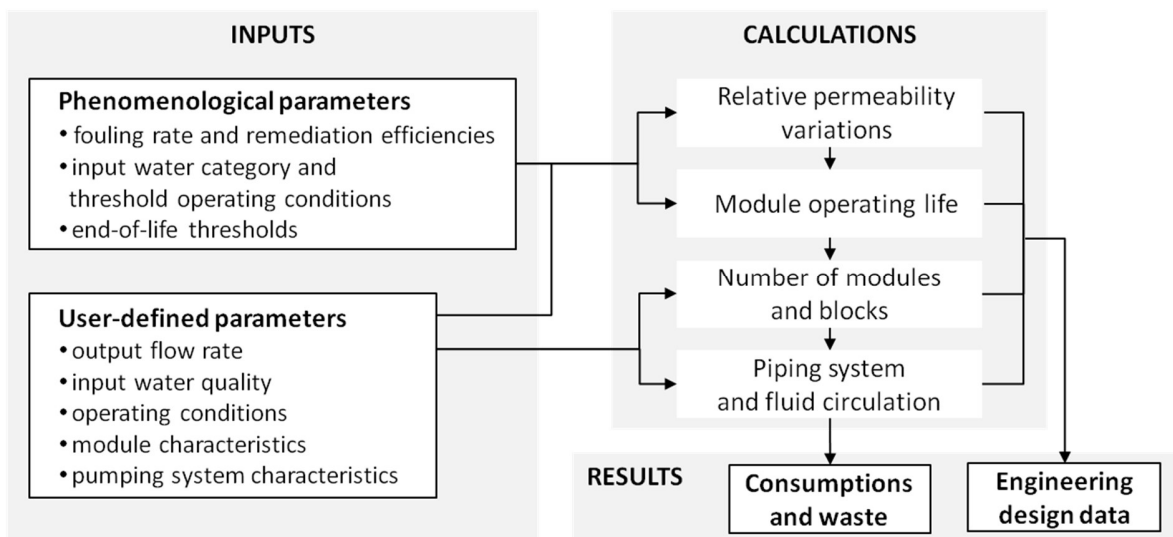

915

916 **Fig. A.1.** Model framework for UF operation

917

918 In a second section, value ranges and specific initialization values are suggested for model  
919 parameters appearing in the previous modelling equations: Table A.5 for model initialization,  
920 Table A.6 for input water quality categories, Table A.7 for backwash volume and Table A.8 for  
921 intake pipe diameter.

922

923

924 **A.1.1. Modelling equations of material and energy balances**

925

926 **A.1.1.1. Phenomenological user-defined parameters**

927

928 The nomenclature used for model input parameters is inspired from work of Méry [1] in view of  
 929 the model's integration in EVALEAU.

930

931 **Table A.1** User-defined parameters

Category	Programming name	Unit
<b>Output flow rate</b>	Specification_Output_Flow_Rate	m <sup>3</sup> day <sup>-1</sup>
<b>Input water quality</b>	Input_Water_Turbidity	NTU
	Input_Water_TOC	g L <sup>-1</sup>
<b>Module characteristics</b>	Module_Surface	m <sup>2</sup>
	Module_Void_Volume	m <sup>3</sup>
	Permeability_After_Initial_Decline	L h <sup>-1</sup> m <sup>2</sup> bar <sup>-1</sup> at 20°C
<b>Filtration operating conditions</b>	<b>either</b> Specification_Decline_Filtration <sup>a</sup>	-
	<b>or</b> Specification_Filtration_Cycle_Duration	min
	<b>either</b> Specification_Decline_Operating <sup>b</sup>	-
	<b>or</b> Specification_Operating_Cycle_Duration	day
	Specification_Filtration_Flux	L h <sup>-1</sup> m <sup>-2</sup> at 20°C
<b>BW operating conditions</b>	BW_Flux	L h <sup>-1</sup> m <sup>-2</sup> at 20°C
	Volume_Per_BW_Per_Unit_Surface	L m <sup>-2</sup> per BW
	BW_Chemical_Concentration	ppm

	BW_Chemical_Injection_Time_Fraction	-
	Number_Of_CIP_Chemical_Phases	-
	CIP_Chemical1_Concentration	ppm
	CIP_Phase1_Flux	L h <sup>-1</sup> m <sup>-2</sup> at 20°C
	CIP_Phase1_Duration_Per_Rack	H
	CIP_Phase1_Soak_Duration_Per_Rack	H
	CIP_Chemical2_Concentration	ppm
	CIP_Phase2_Flux	L h <sup>-1</sup> m <sup>-2</sup> at 20°C
	CIP_Phase2_Duration_Per_Rack	h
	CIP_Phase2_Soak_Duration_Per_Rack	h
<b>CIP operating conditions</b>	CIP_Chemical3_Concentration	ppm
	CIP_Phase3_Flux	L h <sup>-1</sup> m <sup>-2</sup> at 20°C
	CIP_Phase3_Duration_Per_Rack	h
	CIP_Phase3_Soak_Duration_Per_Rack	h
	CIP_Phase4_Flux	L h <sup>-1</sup> m <sup>-2</sup> at 20°C
	CIP_Phase4_Duration_Per_Rack_Per_Filling	h
	CIP_Phase4_Number_Of_Fillings_Per_Rack	-
	CIP_Phase5_Flux	L h <sup>-1</sup> m <sup>-2</sup> at 20°C
	CIP_Volume_Per_Phase5_Per_Unit_Surface	L m <sup>-2</sup> for CIP Phase5
	Intake_Pump_Efficiency	-
<b>Pump efficiencies</b>	BW_Pump_Efficiency	-
	CIP_Pump_Efficiency	-
	Intake_Common_Pipe_Diameter	m
<b>Piping system</b>		



	BW_Common_Pipe_Diameter	m
	CIP_Common_Pipe_Diameter	m
	Rack_Pipe_Diameter	m
	Rack_Pipe_Length_Between_Modules	m
	CIP_Common_Pipe_Length_To_First_Block	m
	CIP_Common_Pipe_Length_Between_Blocks	m
<b>Minor loss coefficients</b>	Common_Minor_Loss_Coefficient	-
	Prefilter_Minor_Loss_Coefficient	-
	Rack_Minor_Loss_Coefficient	-

932 <sup>a</sup> abbreviation for Specification\_Relative\_Permeability\_Decline\_A\_During\_Filtration\_Cycle.

933 <sup>b</sup> abbreviation for Specification\_Relative\_Permeability\_Decline\_During\_An\_Operating\_Cycle.

934

935

936 **Table A.2** Phenomenological parameters

Category	Programming name	Unit
<b>Fouling rate and remediation efficiencies</b>	Fouling_Rate	m <sup>-1</sup>
	BW_Efficiency	-
	CIP_Efficiency	-
<b>Threshold operating conditions</b>	Max_Filtration_Flux	L h <sup>-1</sup> m <sup>-2</sup> at 20°C
	Max_Filtration_Cycle_Duration	min
	Max_Operating_Cycle_Duration	day
<b>End-of-life conditions</b>	End_Of_Life_Operating_Life	year
	End_Of_Life_Permeability	L h <sup>-1</sup> m <sup>-2</sup> bar <sup>-1</sup> at 20°C
	End_Of_Life_Number_Of_BW_Cycles	-
	BW_Chemical_End_Of_Life_c_x_t	ppm day
	CIP_Chemical1_End_Of_Life_c_x_t	ppm day
	CIP_Chemical2_End_Of_Life_c_x_t	ppm day
	CIP_Chemical3_End_Of_Life_c_x_t	ppm day

937

938 **A.1.1.2. Input water category and associated thresholds**

939 Input water turbidity and TOC define the input water quality category. For each category, there  
 940 are three phenomenological parameters: maximum allowable filtration flux, filtration and  
 941 operating cycle durations. The corresponding programming names are:

942

- 943 - Max\_Filtration\_Flux [L h<sup>-1</sup> m<sup>-2</sup> at 20°C]
- 944 - Max\_Filtration\_Cycle\_Duration [min]
- 945 - Max\_Operating\_Cycle\_Duration [day]

946 **A.1.1.3. Relative permeability variations**

947 *A.1.1.3.1 Initialization filtration flux*

948 The initialization filtration flux equals the lowest value of the specification value and the  
 949 maximum allowable filtration flux associated with the input water category.

950

**If** Specification\_Filtration\_Flux > Max\_Filtration\_Flux  
**Then** Initialization\_Filtration\_Flux = Max\_Filtration\_Flux  
**Else** Initialization\_Filtration\_Flux = Specification\_Filtration\_Flux

951

952 *A.1.1.3.2 Filtration cycle duration and relative permeability decline during a filtration cycle*

953 Either Decline\_Filtration or Filtration\_Cycle\_Duration is specified by the user. In any case,

954 Filtration\_Cycle\_Duration must not exceed Max\_Filtration\_Cycle\_Duration.

955

956 **Case 1** – user-defined Specification\_Decline\_Filtration

957

$$\text{Calculated\_Filtration\_Cycle\_Duration} = \frac{\text{Specification\_Decline\_Filtration} \cdot 60 \cdot 10^3}{\text{Specification\_Filtration\_Flux} \cdot \text{Fouling\_Rate\_During\_A\_Filtration\_Cycle}}$$

[min] (1)

958

**If** Calculated\_Filtration\_Cycle\_Duration > Max\_Filtration\_Cycle\_Duration  
**Then** Filtration\_Cycle\_Duration = Max\_Filtration\_Cycle\_Duration  
**And** Decline\_Filtration is calculated in **case 2**.

**Else**

Filtration\_Cycle\_Duration = Calculated\_Filtration\_Cycle\_Duration

**And** Decline\_Filtration = Specification\_Decline\_Filtration

959

960

961 **Case 2** – user-defined Specification\_Filtration\_Cycle\_Duration or

962 Calculated\_Filtration\_Cycle\_Duration set following **case 1**

963

**If** Specification\_Filtration\_Cycle\_Duration > Max\_Filtration\_Cycle\_Duration  
**Or** Calculated\_Filtration\_Cycle\_Duration > Max\_Filtration\_Cycle\_Duration (see **case 1**)  
**Then** Filtration\_Cycle\_Duration = Max\_Filtration\_Cycle\_Duration

**Else** Filtration\_Cycle\_Duration = Specification\_Filtration\_Cycle\_Duration

964

$$\text{Decline\_Filtration} = \frac{\text{Initialization\_Filtration\_Flux} \cdot \text{Filtration\_Cycle\_Duration} \cdot \text{Fouling\_Rate\_During\_A\_Filtration\_Cycle}}{60 \cdot 10^3} \quad [\text{no unit}] \quad (2)$$

965 *A.1.1.3.3 BW duration per rack*

$$\text{BW\_Duration\_Per\_Rack} = \frac{\text{Volume\_Per\_BW\_Per\_Unit\_Surface} \cdot 60 \cdot 60}{\text{BW\_Flux}} \quad [\text{sec}] \quad (3)$$

966

967 *A.1.1.3.4 CIP duration per operating cycle*

$$\text{CIP\_Phase5\_Duration\_Per\_Rack} = \frac{\text{CIP\_Volume\_Per\_Phase5\_Per\_Unit\_Surface}}{\text{CIP\_Phase5\_Flux}} \quad [\text{h}] \quad (4)$$

968

969 Just as BWs, CIPs are also operated by rack. For CIP phases 1 to 3, the soak period of one rack is  
 970 done during the recirculation period of the second rack. For CIP phases 4 and 5, racks are rinsed  
 971 alternatively. The immobilization time for any given module due to a CIP cycle is thus longer  
 972 than the actual CIP sequence for the concerned module (see factor 2 in the equation below).

973

$$\begin{aligned} \text{CIP\_Duration\_Per\_Operating\_Cycle} = & \frac{1}{24} \cdot [(2 \cdot \text{CIP\_Phase1\_Duration\_Per\_Rack}) + \\ & \text{CIP\_Phase1\_Soak\_Duration\_Per\_Rack} + (2 \cdot \text{CIP\_Phase2\_Duration\_Per\_Rack}) + \\ & \text{CIP\_Phase2\_Soak\_Duration\_Per\_Rack} + (2 \cdot \text{CIP\_Phase3\_Duration\_Per\_Rack}) + \\ & \text{CIP\_Phase3\_Soak\_Duration\_Per\_Rack} + (2 \cdot \text{CIP\_Phase4\_Number\_Of\_Fillings\_Per\_Rack} \cdot \\ & \text{CIP\_Phase4\_Duration\_Per\_Rack\_Per\_Filling}) + (2 \cdot \text{CIP\_Phase5\_Duration\_Per\_Rack})] \end{aligned} \quad [\text{day}] \quad (5)$$

974 *A.1.1.3.5 Operating cycle duration and relative permeability decline during an operating cycle*

975 Either Decline\_Operating or Operating\_Cycle\_Duration is specified. In any case,

976 Operating\_Cycle\_Duration must not exceed Max\_Operating\_Cycle\_Duration.

977

978 **Case 1** – user-defined Specification\_Decline\_Operating

$$\text{Number\_Of\_Filtration\_Cycles\_Per\_Operating\_Cycle} = \frac{\text{Specification\_Decline\_Operating}}{\text{Decline\_Filtration} \cdot (1 - \text{BW\_Efficiency})} \quad [\text{no unit}] \quad (6)$$

979

$$\text{Calculated\_Operating\_Cycle\_Duration} = \text{CIP\_Duration\_Per\_Operating\_Cycle} + \text{Number\_Of\_Filtration\_Cycles\_Per\_Operating\_Cycle} \cdot \left( \frac{\text{Filtration\_Cycle\_Duration}}{60 \cdot 24} + \frac{2 \cdot \text{BW\_Duration\_Per\_Rack}}{60 \cdot 60 \cdot 24} \right)$$

[day] (7)

980

**If** Calculated\_Operating\_Cycle\_Duration > Max\_Operating\_Cycle\_Duration

**Then** Operating\_Cycle\_Duration = Max\_Operating\_Cycle\_Duration

**And** Decline\_Operating is calculated in **case 2**.

**Else** Operating\_Cycle\_Duration = Calculated\_Operating\_Cycle\_Duration

**And**

Decline\_Operating = Specification\_Decline\_Operating

981

982

983 **Case 2** – user-defined Specification\_Operating\_Cycle\_Duration or

984 Calculated\_Operating\_Cycle\_Duration set following **case 1**

985

**If** Specification\_Operating\_Cycle\_Duration > Max\_Operating\_Cycle\_Duration

**Or** Calculated\_Operating\_Cycle\_Duration > Max\_Operating\_Cycle\_Duration

**Then** Operating\_Cycle\_Duration = Max\_Operating\_Cycle\_Duration

**Else** Operating\_Cycle\_Duration = Specification\_Operating\_Cycle\_Duration

986

$$\text{Number\_Of\_Filtration\_Cycles\_Per\_Operating\_Cycle} = \frac{\text{Operating\_Cycle\_Duration} - \text{CIP\_Duration\_Per\_Operating\_Cycle}}{\left( \frac{\text{Filtration\_Cycle\_Duration}}{60 \cdot 24} + \frac{2 \cdot \text{BW\_Duration\_Per\_Rack}}{60 \cdot 60 \cdot 24} \right)}$$

[no unit] (8)

987

988

$$\text{Decline\_Operating} = \text{Number\_Of\_Filtration\_Cycles\_Per\_Operating\_Cycle} \cdot \text{Decline\_Filtration} \cdot (1 - \text{BW\_Efficiency})$$

[no unit] (9)

989

990 In both cases 1 and 2:

991

Number\_Of\_BW\_Cycles\_Per\_Operating\_Cycle = Number\_Of\_Filtration\_Cycles\_Per\_Operating\_Cycle

[no unit] (10)

992

993

994

995 **A.1.1.4. Module operating life subject to end-of-life conditions**

996 *A.1.1.4.1 Number of operating cycles*

997 Modules run simultaneously and have the same operating life. Each of the following conditions  
 998 marks the module’s end of operating life and corresponds to a hypothetical number of  
 999 operating cycles.

1000

1001 **Table A.3** End-of-life conditions and associated phenomenological parameters

End-of-life condition	Phenomenological end-of-life parameter
Maximum module operating life is reached	End_Of_Life_Operating_Life
Minimum productivity is reached after a BW cycle	End_Of_Life_Relative_Permeability
Maximum chemical resistance is reached for one of the chemicals used during BWs or CIPs	End_Of_Life_c_x_t
Maximum mechanical resistance is reached	End_Of_Life_Number_Of_BW_Cycles

1002 *Condition 1*

$$\text{Condition1\_Number\_Of\_Operating\_Cycles} = \frac{\text{End\_Of\_Life\_Operating\_Life} \cdot 365.25}{\text{Operating\_Cycle\_Duration}} \quad [\text{no unit}] \quad (11)$$

1003 *Condition 2*

$$\text{Condition2\_Number\_Of\_Operating\_Cycles} = \frac{\text{End\_Of\_Life\_Relative\_Permeability} - 1}{(1 - \text{CIP\_Efficiency}) \cdot \text{Decline\_Operating}} \quad [\text{no unit}] \quad (12)$$

1004 *Condition 3*

1005 First, the “c x t” value per operating cycle is calculated for each chemical.

1006

$$\text{BW\_Chemical\_c\_x\_t\_Per\_Operating\_Cycle} = \text{BW\_Chemical\_Concentration} \cdot \frac{\text{BW\_Duration\_Per\_Rack}}{60 \cdot 60 \cdot 24} \cdot \text{BW\_Chemical\_Injection\_Time\_Fraction} \cdot \text{Number\_of\_BW\_Cycles\_Per\_Operating\_Cycle}$$

[ppm.day] (13)

1007

1008 X in ChemicalX and PhaseX equals 1, 2 or 3.

$$\text{CIP\_ChemicalX\_c\_x\_t\_Per\_Operating\_Cycle} = \frac{\text{CIP\_ChemicalX\_Concentration} \cdot (\text{CIP\_PhaseX\_Duration\_Per\_Rack} + \text{CIP\_PhaseX\_Soak\_Duration\_Per\_Rack})}{24}$$

[ppm.day] (14)

1009

1010 For each chemical, the hypothetical number of operating cycles is calculated with the “c x t”  
1011 value per operating cycle and the associated threshold input parameter.

1012

1013 Case 1 – BW chemical same as a CIP chemical (*i.e.* ChemicalX where X = 1, 2 or 3)

$$\text{BW\_Chemical\_c\_x\_t\_Number\_Of\_Operating\_Cycles} = \frac{\text{BW\_Chemical\_End\_Of\_Life\_c\_x\_t}}{\text{BW\_Chemical\_c\_x\_t\_Per\_Operating\_Cycle} + \text{CIP\_ChemicalX\_c\_x\_t\_Per\_Operating\_Cycle}}$$

[no unit] (15)

1014

$$\text{CIP\_ChemicalX\_c\_x\_t\_Number\_Of\_Operating\_Cycles} = \text{BW\_Chemical\_c\_x\_t\_Number\_Of\_Operating\_Cycles}$$

[no unit] (16)

1015

1016 **Case 2** – BW chemical different from CIP chemicals

$$\text{BW\_Chemical\_c\_x\_t\_Number\_Of\_Operating\_Cycles} = \frac{\text{BW\_Chemical\_End\_Of\_Life\_c\_x\_t}}{\text{BW\_Chemical\_c\_x\_t\_Per\_Operating\_Cycle}}$$

[no unit] (17)

1017

1018 X in ChemicalX equals 1, 2 or 3.

$$\text{CIP\_ChemicalX\_c\_x\_t\_Number\_Of\_Operating\_Cycles} = \frac{\text{CIP\_ChemicalX\_End\_Of\_Life\_c\_x\_t}}{\text{CIP\_ChemicalX\_c\_x\_t\_Per\_Operating\_Cycle}}$$

[no unit] (18)

1019



1020 The limiting “c x t” condition relates to the chemical with the lowest hypothetical number of  
1021 operating cycles.

1022

$$\begin{aligned} \text{Condition3\_Number\_Of\_Operating\_Cycles} = & \\ & \min(\text{BW\_Chemical\_c\_x\_t\_Number\_Of\_Operating\_Cycles}; \\ & \text{CIP\_Chemical1\_c\_x\_t\_Number\_Of\_Operating\_Cycles}; \\ & \text{CIP\_Chemical2\_c\_x\_t\_Number\_Of\_Operating\_Cycles}; \\ & \text{CIP\_Chemical3\_c\_x\_t\_Number\_Of\_Operating\_Cycles}; \\ & \text{CIP\_Chemical4\_c\_x\_t\_Number\_Of\_Operating\_Cycles}) \end{aligned}$$

[no unit] (19)

1023 *Condition 4*

$$\text{Condition4\_Number\_Of\_Operating\_Cycles} = \frac{\text{End\_Of\_Life\_Number\_Of\_BW\_Cycles}}{\text{Number\_Of\_BW\_Cycles\_Per\_Operating\_Cycle}}$$

[no unit] (20)

1024

1025 *Limiting condition: actual number of operating cycles*

$$\text{Number\_Of\_Operating\_Cycles} = \min(\text{Condition1\_Number\_Of\_Operating\_Cycles}; \text{Condition2\_Number\_Of\_Operating\_Cycles}; \text{Condition3\_Number\_Of\_Operating\_Cycles}; \text{Condition4\_Number\_Of\_Operating\_Cycles}) \quad [\text{no unit}] \quad (21)$$

1026

$$\text{Number\_Of\_CIP} = \text{Integer}(\text{Number\_Of\_Operating\_Cycles}) \quad [\text{no unit}] \quad (22)$$

1027

1028 *Number of filtration cycles in last operating cycle*

1029 **Case 1 – condition 1 as limiting condition**

$$\text{Number\_Of\_Filtration\_Cycles\_In\_Last\_Operating\_Cycle} = \text{Integer} \left[ \frac{\text{End\_Of\_Life\_Operating\_Life} \cdot 365.25 - (\text{Number\_Of\_CIP} \cdot \text{Operation\_Cycle\_Duration})}{\frac{\text{Filtration\_Cycle\_Duration}}{60 \cdot 24} + 2 \cdot \frac{\text{BW\_Duration\_Per\_Rack}}{60 \cdot 60 \cdot 24}} \right] \quad [\text{no unit}] \quad (23)$$

1030

1031 **Case 2 – condition 2 as limiting condition**

$$\text{Number\_Of\_Filtration\_Cycles\_In\_Last\_Operating\_Cycle} = \text{Integer} \left[ \frac{\text{End\_Of\_Life\_Relative\_Permeability} - 1 - \text{Number\_Of\_CIP} \cdot \text{Decline\_Operating} \cdot (1 - \text{CIP\_Efficiency})}{\text{Decline\_Filtration} \cdot (1 - \text{BW\_Efficiency})} \right] \quad [\text{no unit}] \quad (24)$$

1032

1033 **Case 3 – condition 3 as limiting condition**

1034 **If BW chemical is the limiting chemical and different from CIP chemicals**

$$\text{Number\_Of\_Filtration\_Cycles\_In\_Last\_Operating\_Cycle} = \text{Integer} \left[ \frac{\text{BW\_Chemical\_End\_Of\_Life\_c\_x\_t} - (\text{Number\_Of\_CIP} \cdot \text{BW\_Chemical\_c\_x\_t\_Per\_Operating\_Cycle})}{\text{BW\_Chemical\_Concentration} \cdot \frac{\text{BW\_Duration\_Per\_Rack}}{60 \cdot 60 \cdot 24}} \right] \quad [\text{no unit}] \quad (25)$$

1035

1036 **If BW chemical is the limiting chemical and same as CIP chemicalX where X is either 1, 2 or 3**

$$\text{Number\_Of\_Filtration\_Cycles\_In\_Last\_Operating\_Cycle} = \text{Integer} \left[ \frac{\text{BW\_Chemical\_End\_Of\_Life\_c\_x\_t} - \text{Number\_Of\_CIP} \cdot (\text{BW\_Chemical\_c\_x\_t\_Per\_Operating\_Cycle})}{\text{BW\_Chemical\_Concentration} \cdot \frac{\text{BW\_Duration\_Per\_Rack}}{60 \cdot 60 \cdot 24}} \right] \quad [\text{no unit}] \quad (26)$$

1037

1038 **If** CIP chemicalX is the limiting chemical where X is 1, 2 or 3

$$\text{Number\_Of\_Filtration\_Cycles\_In\_Last\_Operating\_Cycle} = 0 \quad [\text{no unit}] \quad (27)$$

1039

1040 **Case 4** – condition 4 as limiting condition

$$\begin{aligned} \text{Number\_Of\_Filtration\_Cycles\_In\_Last\_Operating\_Cycle} &= \text{End\_Of\_Life\_Number\_Of\_BW\_Cycles} - \\ &(\text{Number\_Of\_CIP} \cdot \text{Number\_Of\_BW\_Cycles\_Per\_Operating\_Cycle}) \end{aligned} \quad [\text{no unit}] \quad (28)$$

1041 *A.1.1.4.2 Module operating life and final permeability*

$$\begin{aligned} \text{Total\_Number\_Of\_Filtration\_Cycles} &= (\text{Number\_Of\_CIP} \cdot \\ &\text{Number\_Of\_Filtration\_Cycles\_Per\_Operating\_Cycle}) + \\ &\text{Number\_Of\_Filtration\_Cycles\_In\_Last\_Operating\_Cycle} \end{aligned} \quad [\text{no unit}] \quad (29)$$

1042

$$\begin{aligned} \text{Module\_Operating\_Life} &= \frac{1}{365.25} \left[ (\text{Operating\_Cycle\_Duration} \cdot \text{Number\_Of\_CIP}) + \right. \\ &\left. \text{Number\_Of\_Filtration\_Cycles\_In\_Last\_Operating\_Cycle} \cdot \left( \frac{\text{Filtration\_Cycle\_Duration}}{60 \cdot 24} + \frac{2 \cdot \text{BW\_Duration\_Per\_Rack}}{60 \cdot 60 \cdot 24} \right) \right] \end{aligned} \quad [\text{year}] \quad (30)$$

1043

$$\begin{aligned} \text{Final\_Permeability} &= \text{Initial\_Permeability} \cdot [1 + \text{Decline\_Operating} \cdot \text{Number\_Of\_CIP} \cdot (1 - \\ &\text{CIP\_Efficiency}) + \text{Decline\_Filtration} \cdot \text{Number\_Of\_Filtration\_Cycles\_In\_Last\_Operating\_Cycle} \cdot (1 - \\ &\text{BW\_Efficiency})] \end{aligned} \quad \begin{aligned} &[\text{L h}^{-1} \text{ m}^{-2} \\ &\text{bar}^{-1} \\ &\text{at } 20^\circ\text{C}] \end{aligned} \quad (31)$$

1044

1045 **A.1.1.5. Number of modules and blocks**

1046 The theoretical number of modules is calculated by considering the volumes of water filtered  
1047 and used on-site during a module’s operating life. The operating life is the same for all modules.

1048

1049 *A.1.1.5.1 Output volume as required by the specifications*

1050 Specification\_Output\_Flow\_Rate is the daily flow of drinking water required by the  
1051 specifications and that must be guaranteed by the drinking water treatment plant.

1052

1053 Specification\_Output\_Volume is the drinking water volume that must be guaranteed by all  
1054 modules, as a whole, during their operating life.

1055

$$\text{Specification\_Output\_Volume} = \text{Specification\_Output\_Flow\_Rate} \cdot \text{Module\_Operating\_Life} \cdot 365.25$$

[m<sup>3</sup>] (32)

1056

1057 *A.1.1.5.2 Specification intake volume*

$$\text{Specification\_Intake\_Volume\_Per\_Module} = \frac{\text{Initialization\_Filtration\_Flux}}{10^3} \cdot \frac{\text{Filtration\_Cycle\_Duration}}{60} \cdot$$

[m<sup>3</sup> module<sup>-1</sup>] (33)

Module\_Surface · Total\_Number\_Of\_Filtration\_Cycles

1058 *A.1.1.5.3 BW volume*

$$\text{BW\_Volume\_Per\_Module} = \frac{\text{Volume\_Per\_BW\_Per\_Unit\_Surface}}{10^3} \cdot \text{Total\_Number\_Of\_Filtration\_Cycles} \cdot$$

[m<sup>3</sup> module<sup>-1</sup>] (34)

Module\_Surface

1059

1060 *A.1.1.5.4 CIP volume*

1061 As opposed to permeate and BW volumes, CIP volumes for phases 1 to 4 are not expressed by  
1062 unit of membrane surface but as volumes for the entire CIP recirculation system, composed of:

1063

1064 - the main recirculation pipes that blocks have in common;

1065 - the recirculation pipes within each rack;

1066 - the modules.

1067

1068 The latter two can be expressed per module (*i.e.* CIP\_Rack\_Pipe\_Volume\_Per\_Module and

1069 Module\_Void\_Volume). The former depends on the pipe length between the CIP pump and the

1070 block being cleaned, and thus on the number of blocks which for the moment is unknown. This  
 1071 volume is thus omitted to calculate the theoretical number of modules but is later considered  
 1072 to calculate the actual flux.

1073

1074 Within a rack, there are two modules at each interconnection (see factor 1/2 in equation  
 1075 below).

$$\text{CIP\_Rack\_Pipe\_Volume\_Per\_Module} = \frac{1}{2} \cdot \left( \frac{\pi \cdot \text{Rack\_Pipe\_Diameter}^2}{4} \cdot \text{Rack\_Pipe\_Length\_Between\_Modules} \right) \quad \text{[m}^3 \text{ module}^{-1}] \quad (35)$$

1076

1077 The factor 2 in the equation below considers both the input and output rack pipes to the  
 1078 module.

1079

$$\text{Estimated\_CIP\_Recirculation\_Volume\_Per\_Module\_Per\_Phase} = \text{Number\_Of\_CIP} \cdot (2 \cdot \text{CIP\_Rack\_Pipe\_Volume\_Per\_Module} + \text{Module\_Void\_Volume}) \quad \text{[m}^3 \text{ module}^{-1} \text{ per CIP Phase]} \quad (36)$$

1080

1081 During CIP phase 5, water is not recirculated but goes directly to waste. The user specifies the  
 1082 volume that passes through each unit of membrane surface.

1083

$$\text{CIP\_Phase5\_Volume\_Per\_Module} = \frac{\text{CIP\_Volume\_Per\_Phase5\_Per\_Unit\_Surface}}{10^3} \cdot \text{Module\_Surface} \cdot \text{Number\_Of\_CIP} \quad \text{[m}^3 \text{ for CIP Phase 5 module}^{-1}] \quad (37)$$

1084 *A.1.1.5.5 Theoretical number of modules*

1085 The numerator of the equation below is the output volume expressed for the entire  
 1086 ultrafiltration system. The denominator is composed of volumes expressed per module. It is the  
 1087 intake volume minus the volume used for cleaning sequences (BW fluid, CIP Phase 5 fluid, and  
 1088 fluid filling up modules and pipes during CIP Phases 1 to 4).

1089 
$$\text{Theoretical\_Number\_Of\_Modules} = \frac{\text{Specification\_Output\_Volume}}{\text{Specification\_Intake\_Volume\_Per\_Module} - \text{BW\_Volume\_Per\_Module} - [\text{Estimated\_CIP\_Recirculation\_Volume\_Per\_Module\_Per\_Phase} \cdot (\text{Number\_Of\_CIP\_Chemical\_Phases} + \text{CIP\_Phase4\_Number\_Of\_Fillings\_Per\_Rack})] - \text{CIP\_Phase5\_Volume\_Per\_Module}}$$

1090 [no unit] (38)

1091

1092 *A.1.1.5.6 Number of modules and number of blocks*

1093 Each row contains the same number of modules. The theoretical number of modules is  
 1094 rounded to the nearest possible module arrangement. If two configurations are possible (e.g. 3  
 1095 blocks of 12 modules per row or 4 blocks of 9 modules per row to obtain 144 modules), the  
 1096 configuration with the lowest number of blocks is taken.

1097

1098 **Table A.4** Module arrangement in blocks

<b>Nr. Modules</b>	<b>Nr. blocks</b>	<b>Nr. modules per row</b>	<b>Nr. modules</b>	<b>Nr. blocks</b>	<b>Nr. modules per row</b>
72	2	9	280	5	14
80	2	10	288	6	12
88	2	11	308	7	11
96	2	12	312	6	13
104	2	13	320	8	10
108	3	9	324	9	9
112	2	14	336	6	14
120	3	10	352	8	11
132	3	11	360	9	10
144	3	12	364	7	13
156	3	13	384	8	12

160	4	10	392	7	14
168	3	14	396	9	11
176	4	11	400	10	10
180	5	9	416	8	13
192	4	12	432	9	12
200	5	10	440	10	11
208	4	13	448	8	14
216	6	9	468	9	13
220	5	11	480	10	12
224	4	14	484	11	11
240	5	12	504	9	14
252	7	9	520	10	13
260	5	13	528	11	12
264	6	11			

---

1099

1100 The final module arrangement gives two input parameters: Number\_Of\_Modules and  
 1101 Number\_Of\_Blocks.

1102

$$\text{Number\_Of\_Modules\_Per\_Row} = \frac{\text{Number\_Of\_Modules}}{4 \cdot \text{Number\_Of\_Blocks}} \quad [\text{no unit}] \quad (39)$$

1103

1104 **A.1.1.6. Piping system and fluid circulation**

1105 *A.1.1.6.1 Volumes*

1106 *CIP volume in common pipes for recirculation*

1107 Since the number of blocks is now known, the volume in recirculation pipes that blocks have in  
 1108 common can be calculated. The CIP common pipe length depends on which block is being  
 1109 cleaned: the furthest the block from the CIP pump, the greater the common pipe length.

1110

1111 **Theoretical note:** the average CIP pipe length for blocks equals:

1112 
$$\text{Length\_From\_CIP\_Pump\_To\_First\_Block} + \frac{(\text{Number\_Of\_Blocks}-1)}{2} \cdot \text{Length\_Between\_Blocks}$$

1113

1114

$$\text{CIP\_Common\_Pipe\_Volume\_Per\_Module} = \frac{\pi \cdot \text{CIP\_Common\_Pipe\_Diameter}^2}{4} \cdot \frac{[\text{CIP\_Common\_Pipe\_Length\_To\_First\_Block} + \frac{(\text{Number\_Of\_Blocks}-1)}{2} \cdot \text{CIP\_Common\_Pipe\_Length\_Between\_Blocks}]}{4 \cdot \text{Number\_Of\_Modules\_Per\_Row}} \quad [\text{m}^3 \text{ module}^{-1}] \quad (40)$$

1115

1116 The factor 2 in the below equation corresponds to both the input and output CIP common pipes  
 1117 to blocks.

1118

$$\text{CIP\_Recirculation\_Volume\_Per\_Module\_Per\_Phase} = (2 \cdot \text{CIP\_Common\_Pipe\_Volume\_Per\_Module} \cdot \text{Number\_Of\_CIP}) + \text{Estimated\_CIP\_Recirculation\_Volume\_Per\_Module\_Per\_Phase} \quad [\text{m}^3 \text{ module}^{-1} \text{ per CIP Phase}] \quad (41)$$

1119 *Filtration flux*

1120 *Filtration\_Flux =*

1121 
$$\frac{60 \cdot 10^3 \cdot \left[ \frac{\text{Specification\_Output\_Volume}}{\text{Number\_Of\_Modules}} + \text{BW\_Volume\_Per\_Module} + ((\text{Number\_Of\_CIP\_Chemical\_Phases} + \text{CIP\_Phase4\_Number\_Of\_Fillings\_Per\_Rack}) \cdot \text{CIP\_Recirculation\_Volume\_Per\_Module\_Per\_Phase}) + \text{CIP\_Phase5\_Volume\_Per\_Module} \right]}{\text{Filtration\_Cycle\_Duration} \cdot \text{Module\_Surface} \cdot \text{Total\_Number\_Of\_Filtration\_Cycles}} \quad [\text{L h}^{-1} \text{ m}^{-2}] \quad (42)$$

1122

1123 The calculated flux value is compared to the initialization value (*i.e.*

1124 Initialization\_Filtration\_Flux). If different, the new initialization flux is the calculated flux. If the



1125 calculated flux does not equal the initialization flux, even after several calculation loops, then  
 1126 there is no solution for this flux.

1127 *Intake volume*

$$\text{Intake\_Volume} = \frac{\text{Specification\_Intake\_Volume\_Per\_Module} \cdot \text{Number\_Of\_Modules} \cdot \text{Filtration\_Flux}}{\text{Initialization\_Filtration\_Flux}} \quad [\text{m}^3] \quad (43)$$

1128

1129 *BW volume*

$$\text{BW\_Volume} = \text{BW\_Volume\_Per\_Module} \cdot \text{Number\_Of\_Modules} \quad [\text{m}^3] \quad (44)$$

1130

1131 *CIP volume*

$$\text{CIP\_Recirculation\_Volume\_Per\_Phase} = \text{CIP\_Recirculation\_Volume\_Per\_Module\_Per\_Phase} \cdot \text{Number\_Of\_Modules} \quad [\text{m}^3 \text{ per CIP Phase}] \quad (45)$$

1132

$$\text{CIP\_Phase5\_Volume} = \text{CIP\_Phase5\_Volume\_Per\_Module} \cdot \text{Number\_Of\_Modules} \quad [\text{m}^3] \quad (46)$$

1133

1134 *Output volume*

$$\text{Output\_Volume} = \text{Intake\_Volume} - \text{BW\_Volume} - \text{CIP\_Recirculation\_Volume\_Per\_Phase} \cdot (\text{Number\_Of\_CIP\_Chemical\_Phases} + \text{CIP\_Phase4\_Number\_Of\_Fillings\_Per\_Rack}) - \text{CIP\_Phase5\_Volume} \quad [\text{m}^3] \quad (47)$$

1135

1136 *Output\_Volume* can be compared with *Specification\_Output\_Volume* to verify that they are  
 1137 equal.

1138

1139 *A.1.1.6.2 Pressures*

1140 *Intake pumping – minor head loss*

$$\text{Intake\_Flow} = \frac{\text{Filtration\_Flux} \cdot \text{Module\_Surface} \cdot \text{Number\_Of\_Modules}}{10^3} \quad [\text{m}^3 \text{ h}^{-1}] \quad (48)$$

1141

$$\text{Intake\_Velocity\_In\_Common\_Pipe} = \frac{4 \cdot \text{Intake\_Flow}}{\pi \cdot \text{Intake\_Common\_Pipe\_Diameter}^2 \cdot 60 \cdot 60} \quad [\text{m s}^{-1}] \quad (49)$$

1142

$$\text{Intake\_Velocity\_In\_Rack\_Pipe} = \frac{4 \cdot \left( \frac{\text{Intake\_Flow}}{2 \cdot \text{Number\_Of\_Blocks}} \right)}{\pi \cdot \text{Rack\_Pipe\_Diameter}^2 \cdot 60 \cdot 60} \quad [\text{m s}^{-1}] \quad (50)$$

1143

$$\text{Intake\_Head\_Loss} = \frac{\text{Water\_Density}}{2 \cdot 10^5} \cdot [((\text{Common\_Minor\_Loss\_Coefficient} + \text{Prefilter\_Minor\_Loss\_Coefficient}) \cdot \text{Intake\_Velocity\_In\_Common\_Pipe}^2) + (\text{Rack\_Minor\_Loss\_Coefficient} \cdot \text{Intake\_Velocity\_In\_Rack\_Pipe}^2)] \quad [\text{bar}] \quad (51)$$

1144

1145 *Intake pumping – average pressure*

1146 The average TMP needed for energy consumptions of pumping (filtration, BW, CIP) is taken as  
1147 the average of the average for each cycle.

1148

$$\text{Filtration\_Average\_Relative\_Permeability\_Of\_Complete\_Operating\_Cycles} = 1 + \frac{\text{Decline\_Filtration}}{2} \cdot [1 + \text{Number\_Of\_Filtration\_Cycles\_Per\_Operating\_Cycle} \cdot (1 - \text{BW\_Efficiency})] + \frac{\text{Decline\_Operating}}{2} \cdot (\text{Number\_Of\_CIP} - 1) \cdot (1 - \text{CIP\_Efficiency}) \quad [\text{no unit}] \quad (52)$$

1149

$$\text{Filtration\_Average\_Relative\_Permeability\_Of\_Last\_Operating\_Cycle} = 1 + \frac{\text{Decline\_Filtration}}{2} \cdot [1 + \text{Number\_Of\_Filtration\_Cycles\_In\_Last\_Operating\_Cycle} \cdot (1 - \text{BW\_Efficiency})] + \text{Decline\_Operating} \cdot \text{Number\_Of\_CIP} \cdot (1 - \text{CIP\_Efficiency}) \quad [\text{no unit}] \quad (53)$$

1150

1151 The average permeability during a membrane's operating life is a weighted average calculated  
1152 according to the number of filtration cycles per operating cycle.

1153

$$\text{Fraction\_Of\_Filtration\_Cycles\_In\_Last\_Operating\_Cycle} = \frac{\text{Number\_Of\_Filtration\_Cycles\_In\_Last\_Operating\_Cycle}}{\text{Total\_Number\_Of\_Filtration\_Cycles}} \quad [\text{no unit}] \quad (54)$$

1154

$$\begin{aligned} \text{Filtration\_Average\_Relative\_Permeability} = & (\text{Fraction\_Of\_Filtration\_Cycles\_In\_Last\_Operating\_Cycle} \cdot \\ & \text{Filtration\_Average\_Relative\_Permeability\_Of\_Last\_Operating\_Cycle}) + [(1 - \\ & \text{Fraction\_Of\_Filtration\_Cycles\_In\_Last\_Operating\_Cycle}) \cdot \\ & \text{Filtration\_Average\_Relative\_Permeability\_Of\_Complete\_Operating\_Cycles}] \end{aligned}$$

[no unit] (55)

1155

$$\begin{aligned} \text{Filtration\_Average\_Permeability} = & \text{Filtration\_Average\_Relative\_Permeability} \cdot \text{Initial\_Permeability} \\ & \text{[L h}^{-1} \text{ m}^{-2} \\ & \text{bar}] \end{aligned}$$

(56)

1156

$$\begin{aligned} \text{Filtration\_Average\_TMP} = & \frac{\text{Filtration\_Flux}}{\text{Filtration\_Average\_Permeability}} \\ & \text{[bar]} \end{aligned}$$

(57)

1158

$$\begin{aligned} \text{Pumping\_Elec\_Cons\_Per\_Intake} = & \frac{(\text{Filtration\_Average\_TMP} + \text{Intake\_Head\_Loss}) \cdot 10^5}{\text{Intake\_Pump\_Efficiency} \cdot 60 \cdot 60 \cdot 10^3} \\ & \text{[kWh m}^{-3} \\ & \text{intake}] \end{aligned}$$

(58)

1159 *BW pumping – minor head loss*

$$\begin{aligned} \text{BW\_Flow} = & \frac{2 \cdot \text{Number\_Of\_Modules\_Per\_Row} \cdot \text{BW\_Flux} \cdot \text{Module\_Surface}}{10^3} \\ & \text{[m}^3 \text{ h}^{-1}] \end{aligned}$$

(59)

1160

$$\begin{aligned} \text{BW\_Velocity\_In\_Common\_Pipe} = & \frac{4 \cdot \text{BW\_Flow}}{\pi \cdot \text{BW\_Common\_Pipe\_Diameter}^2 \cdot 60 \cdot 60} \\ & \text{[m s}^{-1}] \end{aligned}$$

(60)

1161

$$\begin{aligned} \text{BW\_Velocity\_In\_Rack\_Pipe} = & \frac{4 \cdot \text{BW\_Flow}}{\pi \cdot \text{Rack\_Pipe\_Diameter}^2 \cdot 60 \cdot 60} \\ & \text{[m s}^{-1}] \end{aligned}$$

(61)

1162

$$\begin{aligned} \text{BW\_Head\_Loss} = & \frac{\text{Water\_Density}}{2 \cdot 10^5} \cdot [(\text{Common\_Minor\_Loss\_Coefficient} \cdot \\ & \text{BW\_Velocity\_In\_Common\_Pipe}^2) + (\text{Rack\_Minor\_Loss\_Coefficient} \cdot \text{BW\_Velocity\_In\_Rack\_Pipe}^2)] \\ & \text{[bar]} \end{aligned}$$

(62)

1163

1164 *BW pumping – average pressure*

1165 **Theoretical note:** There is continuity of permeability from one operation to the other. For  
1166 example, permeability at the end of a filtration cycle equals the permeability at the beginning  
1167 of the succeeding BW cycle. The average of the permeability during BW cycles is taken as the  
1168 average permeability during filtration cycles:

1169

$$1170 \text{ BW\_Average\_Permeability} = \frac{\text{BW\_Flux}}{\text{BW\_Average\_TMP}} = \text{Filtration\_Average\_Permeability}$$

1171

$$\text{BW\_Average\_TMP} = \frac{\text{BW\_Flux}}{\text{Filtration\_Average\_Permeability}} \quad [\text{bar}] \quad (63)$$

1172

1173

$$\text{Pumping\_Elec\_Cons\_Per\_BW} = \frac{(\text{BW\_Average\_TMP} + \text{BW\_Head\_Loss}) \cdot 10^2}{\text{BW\_Pump\_Efficiency} \cdot 60 \cdot 60} \quad \begin{matrix} [\text{kWh m}^{-3} \\ \text{per BW}] \end{matrix} \quad (64)$$

1174

1175 *CIP pumping – minor head loss*

1176 X in PhaseX equals 1 to 5.

$$\text{CIP\_PhaseX\_Flow} = \frac{2 \cdot \text{Number\_Of\_Modules\_Per\_Row} \cdot \text{CIP\_PhaseX\_Flux} \cdot \text{Module\_Surface}}{10^3} \quad [\text{m}^3 \text{ h}^{-1}] \quad (65)$$

1177

$$\text{CIP\_PhaseX\_Velocity\_In\_Common\_Pipe} = \frac{4 \cdot \text{CIP\_PhaseX\_Flow}}{\pi \cdot \text{CIP\_Common\_Pipe\_Diameter}^2 \cdot 60 \cdot 60} \quad [\text{m s}^{-1}] \quad (66)$$

1178

$$\text{CIP\_PhaseX\_Velocity\_In\_Rack\_Pipe} = \frac{4 \cdot \text{CIP\_PhaseX\_Flow}}{\pi \cdot \text{Rack\_Pipe\_Diameter}^2 \cdot 60 \cdot 60} \quad [\text{m s}^{-1}] \quad (67)$$

1179

$$\text{CIP\_PhaseX\_Head\_Loss} = \frac{\text{Water\_Density}}{2 \cdot 10^5} \cdot [(\text{Common\_Minor\_Loss\_Coefficient} \cdot \text{CIP\_PhaseX\_Velocity\_In\_Common\_Pipe}^2) + (\text{Rack\_Minor\_Loss\_Coefficient} \cdot \text{CIP\_PhaseX\_Velocity\_In\_Rack\_Pipe}^2)]$$

[bar] (68)

1180 *CIP pumping – average pressure*

1181 **Theoretical note:** There is continuity of permeability from one operation to the other. For  
 1182 example, permeability at the end of a CIP cycle equals the permeability at the beginning of the  
 1183 following filtration cycle. The average permeability during CIP cycles is taken as the average  
 1184 permeability during filtration cycles:

1185

$$\text{CIP\_Phase\_Average\_Permeability} = \frac{\text{CIP\_Phase\_Flux}}{\text{CIP\_Average\_TMP}} = \text{Filtration\_Average\_Permeability}$$

1187

1188 X in PhaseX equals 1 to 5.

$$\text{CIP\_PhaseX\_Average\_TMP} = \frac{\text{CIP\_PhaseX\_Flux}}{\text{Filtration\_Average\_Permeability}}$$

[bar] (69)

1189

$$\text{Pumping\_Elec\_Cons\_Per\_CIP\_PhaseX} = \frac{(\text{CIP\_PhaseX\_Average\_TMP} + \text{CIP\_PhaseX\_Head\_Loss}) \cdot 10^5}{\text{CIP\_Pump\_Efficiency} \cdot 60 \cdot 60 \cdot 10^3}$$

[kWh m<sup>-3</sup>  
CIP PhaseX] (70)

1190

1191

1192 **A.1.1.7. Consumptions and waste**

1193 *A.1.1.7.1 Material consumption*

1194 *BW chemical specific mass*

$$\text{BW\_Chemical\_Spec\_Mass\_Cons} = \frac{\text{BW\_Chemical\_Injection\_Time\_Fraction} \cdot \text{BW\_Chemical\_Concentration} \cdot \text{BW\_Volume}}{\text{Output\_Volume} \cdot 10^3}$$

[kg BW  
Chemical m<sup>-3</sup>  
output] (71)

1195 *CIP chemicalX specific mass*

1196 X in ChemicalX equals 1, 2 or 3.

1197

$$\text{CIP\_ChemicalX\_Spec\_Mass\_Cons} = \frac{\text{CIP\_ChemicalX\_Concentration} \cdot \text{CIP\_Recirculation\_Volume\_Per\_Phase}}{\text{Output\_Volume} \cdot 10^3} \quad \begin{array}{l} \text{[kg CIP} \\ \text{ChemicalX m}^{-3} \\ \text{output]} \end{array} \quad (72)$$

1198

1199 *Module specific mass*

$$\text{Module\_Spec\_Cons} = \frac{\text{Number\_Of\_Modules}}{\text{Output\_Volume}} \quad \begin{array}{l} \text{[module} \\ \text{m}^{-3} \text{ output]} \end{array} \quad (73)$$

1200

1201 *A.1.1.7.2 Energy consumption*

1202 *Specific energy consumption for intake pumping*

$$\text{Intake\_Spec\_Elec\_Cons} = \text{Pumping\_Elec\_Cons\_Per\_Intake} \cdot \frac{\text{Intake\_Volume}}{\text{Output\_Volume}} \quad \begin{array}{l} \text{[kWh m}^{-3} \\ \text{output]} \end{array} \quad (74)$$

1203 *Specific energy consumption for BW pumping*

$$\text{BW\_Spec\_Elec\_Cons} = \text{Pumping\_Elec\_Cons\_Per\_BW} \cdot \frac{\text{BW\_Volume}}{\text{Output\_Volume}} \quad \begin{array}{l} \text{[kWh m}^{-3} \\ \text{output]} \end{array} \quad (75)$$

1204 *Specific energy consumption for CIP pumping*

1205 In the following equation, X in PhaseX equals 1, 2, 3 or 5.

1206

$$\text{CIP\_PhaseX\_Spec\_Elec\_Cons} = \text{Pumping\_Elec\_Cons\_Per\_CIP\_PhaseX} \cdot \frac{2 \cdot \text{CIP\_PhaseX\_Duration\_Per\_Rack} \cdot \text{Number\_Of\_Blocks} \cdot \text{Number\_Of\_CIP\_CIP\_PhaseX\_Flow}}{\text{Output\_Volume}} \quad \begin{array}{l} \text{[kWh m}^{-3} \\ \text{output]} \end{array} \quad (76)$$

1207

$$\text{CIP\_Phase4\_Spec\_Elec\_Cons} = \frac{\text{Pumping\_Elec\_Cons\_Per\_CIP\_Phase4} \cdot 2 \cdot \text{CIP\_Phase4\_Number\_Of\_Fillings\_Per\_Rack} \cdot \text{CIP\_Phase4\_Duration\_Per\_Rack\_Per\_Filling} \cdot \text{Number\_Of\_Blocks} \cdot \text{Number\_Of\_CIP} \cdot \text{CIP\_Phase4\_Flow}}{\text{Output\_Volume}} \quad \begin{matrix} [\text{kWh m}^{-3} \\ \text{output}] \end{matrix} \quad (76)$$

1208

1209 *A.1.1.7.3 Waste*

1210 *BW waste specific mass*

$$\text{BW\_Spec\_Volume\_Cons} = \frac{\text{BW\_Volume}}{\text{Output\_Volume}} \quad \begin{matrix} [\text{m}^3 \text{m}^{-3} \\ \text{output}] \end{matrix} \quad (77)$$

1211 *CIP waste specific mass*

1212 In the following equation, X in PhaseX equals 1, 2 or 3.

1213

$$\text{CIP\_PhaseX\_Spec\_Volume\_Cons} = \frac{\text{CIP\_Recirculation\_Volume\_Per\_Phase}}{\text{Output\_Volume}} \quad \begin{matrix} [\text{m}^3 \text{m}^{-3} \\ \text{output}] \end{matrix} \quad (78)$$

1214

$$\text{CIP\_Phase4\_Spec\_Volume\_Cons} = \frac{\text{CIP\_Phase4\_Number\_Of\_Fillings\_Per\_Rack} \cdot \text{CIP\_Recirculation\_Volume\_Per\_Phase}}{\text{Output\_Volume}} \quad \begin{matrix} [\text{m}^3 \text{m}^{-3} \\ \text{output}] \end{matrix} \quad (79)$$

1215

$$\text{CIP\_Phase5\_Spec\_Volume\_Cons} = \frac{\text{CIP\_Phase5\_Volume}}{\text{Output\_Volume}} \quad \begin{matrix} [\text{m}^3 \text{m}^{-3} \\ \text{output}] \end{matrix} \quad (80)$$

1216

1217

1218 **A.1.2. Data collection**

1219 In the following section, values of the parameters found in the above modelling equations are  
1220 given. In Table A.5, model initialization values of both user- and phenomenological parameters  
1221 are given, as well as their suggested ranges and corresponding references from the literature.  
1222 For sake of clarity, input water quality categories and associated thresholds (phenomenological  
1223 parameters) are provided in Table A.6. In Table A.7, values for BW volume per unit membrane  
1224 surface according to the input water quality category are suggested. In Table A.8, values are  
1225 suggested for the diameter of the intake common pipe according to the number of blocks.



### 1.2.1. User-defined and phenomenological parameters

Table A.5 Model initialization of user- defined and phenomenological parameters

User-defined parameters					
Category	Input parameter	Unit	Literature reference	Suggested range	Baseline scenario
<b>Output flow rate</b>	Specification_Output_Flow_Rate	m <sup>3</sup> day <sup>-1</sup>	>10,000 [2]	>20,000	30,000
<b>Input water quality</b>	Input_Water_Turbidity	NTU	0-25 [2]	0-500	1
	Input_Water_TOC	mg L <sup>-1</sup>	-	0-20	1
<b>Module characteristics</b>	Module_Surface	m <sup>2</sup>	7-125 [3]	7-125	55
	Module_Void_Volume	m <sup>3</sup>	0-0.4 [3]	0-0.4	0.06
	Permeability_After_Initial_Decline	L h <sup>-1</sup> m <sup>-2</sup> bar <sup>-1</sup>	230 [4]	200-270	230
	Specification_Filtration_Cycle_Duration	min	30-180 [5], 10-60 [6]	0-180	60
<b>Filtration operating conditions</b>	Specification_Operating_Cycle_Duration	year	>5 [2]	0.08-2	1
	Specification_Decline_Filtration	N/A	-	0-1	-
	Specification_Decline_Operating	N/A	-	0-1	-
	Specification_Filtration_Flux	L h <sup>-1</sup> m <sup>-2</sup>	60-100 [7], 50-200 mainly 80-100 [2]	0-130	100
<b>BW operating conditions</b>	BW_Flux	L h <sup>-1</sup> m <sup>-2</sup>	140-270 [6]	140-350	250
	Volume_Per_BW_Per_Unit_Surface	L m <sup>-2</sup>	5 [7]	4-6	4.5
	BW_Chemical_Concentration	ppm	NaOCl: 5 [7], 5 [8]	0-10	5
	BW_Chemical_Injection_Time_Fraction	-	0.5 [7]	0-1	0.5
<b>CIP operating conditions</b>	Number_Of_CIP_Chemical_Phases	N/A	-	1-5	1
	CIP_Chemical_Concentration (phases 1-3)	g L <sup>-1</sup>	citric acid: 0.5% [5], pH 3.5-4.0 [8]	0-5	1.5
	CIP pH (phase 1)	-	-	4	4 <sup>b</sup>

	CIP_Flux (phases 1-5)	L h <sup>-1</sup> m <sup>-2</sup>	-	0-50	30
	CIP_Duration_Per_Rack (phases 1-3)	h	-	0-2	1
	CIP_Soak_Duration_Per_Rack (phases 1-3)	h	citric acid: 3 [5]	0-5	2
	CIP_Phase4_Duration_Per_Rack_Per_Filling	h	-	0-2	1
	CIP_Phase4_Number_Of_Fillings_Per_Rack	N/A	-	0-6	5
	CIP_Volume_Per_Phase5_Per_Unit_Surface	L m <sup>-2</sup>	90 (Phase4+5) [5]	0-50	20
<b>Pump efficiencies</b>	Pump_Efficiency (intake, BW, CIP)	-	0.7-0.9 [1]	0.7-0.9	0.7
	BW_Common_Pipe_Diameter	m	-	0-0.50	0.25
	CIP_Common_Pipe_Diameter	m	-	0-0.50	0.15
	Rack_Pipe_Diameter	m	<i>confidential reference</i>	0-0.50	0.25
<b>Piping system</b>	Rack_Pipe_Length_Between_Modules	m	<i>confidential reference</i> module diameter: 0-0.45 [3]	0-0.60	0.40
	CIP_Common_Pipe_Length_To_First_Block	m	-	0-10	5
	CIP_Common_Pipe_Length_Between_Blocks	m	<i>confidential reference</i> module diameter: 0-0.45 [3]	0-2	1.5
<b>Minor loss coefficients</b>	Common_Minor_Loss_Coefficient	-	0-30 [9]	0-30	15
	Prefilter_Minor_Loss_Coefficient	-	0-20 [9]	0-20	10
	Rack_Minor_Loss_Coefficient	-	0-15 [9]	0-15	8
<b>Phenomenological parameters</b>					
<b>Fouling rate and remediation efficiencies</b>	Fouling_Rate	m <sup>-1</sup>	-7-0 [10], -5-0 [11]	-7-0	-7.9 10 <sup>-3</sup>
	BW_Efficiency	-	0-1 [5, 14]	0-1	0.95
	CIP_Efficiency	-	<i>confidential reference</i>	0-1	0.95

			>10 [2]		
	End_Of_Life_Operating_Life	year	-	3-15	15
<b>End-of-</b>	End_Of_Life_Permeability	L h <sup>-1</sup> m <sup>-2</sup> bar <sup>-1</sup>	100,000-200,000 [5]	0-200	100
<b>life conditions</b>	End_Of_Life_Number_Of_BW_Cycles	N/A	5-20 [12],	50,000-200,000	N/A
	End_Of_Life_c_x_t for chlorine	g L <sup>-1</sup> h	5 [13], >100 [5]	5-100	N/A

<sup>a</sup> Calculation detail:  $(Lp_0 - Lp_{\text{start CIP}})/Lp_0 = (260-200)/260 = 0.3$

<sup>b</sup> Calculation detail for ammonia concentration to obtain desired pH:  $[\text{ammonia}] = M_{\text{ammonia}} \cdot ([\text{citric acid}]/M_{\text{citric acid}} - 10^{\text{pKa}_1 - 2\text{pH}})$

where  $\text{pKa}_1$  is the  $\text{pKa}$  of citric acid ( $\text{AH}_3/\text{AH}_2^-$ ) and  $M$  are the molar masses.

**Table A.6** Input water quality categories and threshold operating conditions [14]

Category	Water characteristics		Filtration conditions		Operating cycle
	Turbidity	TOC	Max. flux	Max. duration	Max. duration
no unit	NTU	mg L <sup>-1</sup>	L h <sup>-1</sup> m <sup>-2</sup>	min	Year
0	0-1	0-1	130	180	1
1	0-5	0-2	100	90	1
2	0-30	0-3	90	75	N/A
3	>30	>3	80	60	N/A

1210

**Table A.7** Suggested BW volume per unit membrane surface

<b>Input water quality category</b>	<b>BW volume per unit surface</b> L m <sup>-2</sup>
0	4.3
1	5.0
2	5.3
3	5.7

1211

1212

**Table A.8** Suggested diameter of intake common pipe

<b>Number of blocks</b>	<b>Intake common pipe diameter</b> Mm
2	400
3	500
4	500
5	600
6	700
7	700
8	700
9	800
10	800
11	900

1213

1214 **References**

1215

1216 [1] Y. Méry, Development of an integrated tool for Process Modelling and Life Cycle  
 1217 Assessment-Ecodesign of process plants and application to drinking water treatment  
 1218 (Doctoral dissertation), INSA de Toulouse, Toulouse, 2012.

1219

- 1220 [2] J.M. Laîné, D. Vial, P. Moulart, Status after 10 years of operation—overview of UF  
1221 technology today, *Desalination* 131 (2000) 17-25.  
1222
- 1223 [3] F. Colas, V. Bonnelye, N. Abidine, N., Development of a new hollow-fiber module for large  
1224 ultrafiltration plants, *Desalination* 148 (2002) 389-394.  
1225
- 1226 [4] Y. Bessiere, Filtration frontale sur membrane: mise en évidence du volume filtré critique  
1227 pour l'anticipation et le contrôle du colmatage (Doctoral dissertation), Université Paul  
1228 Sabatier Toulouse III, Toulouse, 2005.  
1229
- 1230 [5] J. Mallevialle, P.E. Odendaal, M.R. Wiesner, *Water Treatment Membrane Processes*, Mc-  
1231 Graw-Hill, New York, 1996.  
1232
- 1233 [6] H. Chang, H. Liang, F. Qu, B. Liu, H. Yu, X. Du, G. Li, S.A. Snyder, Hydraulic backwashing for  
1234 low-pressure membranes in drinking water treatment: A review. *J. Membrane Sci.* 540  
1235 (2017) 362-380.  
1236
- 1237 [7] K. Glucina, J.M. Laîné, L. Durand-Bourlier, Assessment of filtration mode for the  
1238 ultrafiltration membrane process, *Desalination* 118 (1998) 205-211.  
1239
- 1240 [8] Eurofins, List of filtration membranes with an ACS Certificate.  
1241 <https://www.eurofins.fr/environnement/analyses/expertises/alimentarite%3%A9-des->  
1242 [mat%3%A9riaux/](https://www.eurofins.fr/environnement/analyses/expertises/alimentarite%3%A9-des-mat%3%A9riaux/), 2019 (accessed 1 April 2020).  
1243
- 1244 [9] I.E. Idel’Cik, *Mémento des Pertes de Charges: Coefficients de Pertes de Charges Singulières*  
1245 *et de Pertes de Charge*, Editions Eyrolles, Paris, 1986.  
1246
- 1247 [10] N. Delgrange, *Modélisation par réseaux de neurones et conduite d’un pilote*  
1248 *d’ultrafiltration pour la production d’eau potable* (Doctoral dissertation), INSA de Toulouse,  
1249 Toulouse, 2000.  
1250

1251 [11] N. Lee, G. Amy, J.P. Croue, H. Buisson, Identification and understanding of fouling in  
1252 low-pressure membrane (MF/UF) filtration by natural organic matter (NOM), Water Res. 38  
1253 (2004) 4511-4523.

1254

1255 [12] E. Arkhangelsky, U. Goren, V. Gitis, Retention of organic matter by cellulose acetate  
1256 membranes cleaned with hypochlorite, Desalination 223 (2008) 97-105.

1257

1258 [13] V. Gitis, R.C. Haught, R.M. Clark, J. Gun, O. Lev, Application of nanoscale probes for the  
1259 evaluation of the integrity of ultrafiltration membranes, J. Membrane Sci. 276 (2006) 185-192.

1260

1261 [14] Coelho, F., Leclerc, J., Bourdiol, D., Valentin A.C., Sauvade, P., 2019. 30 years of  
1262 evolution in ultrafiltration systems and processes for drinking water production. IWA MTC,  
1263 Toulouse.

1264 **B – Example of a module arrangement**

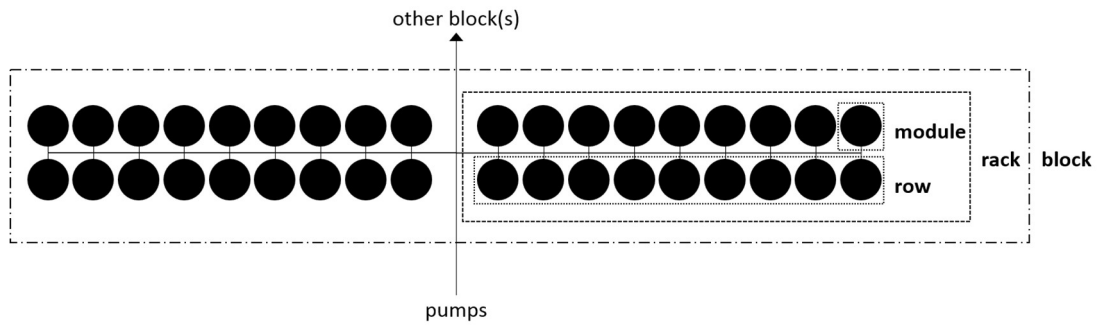

1265

1266

**Fig. B.1.** Module arrangement in rows, racks and blocks

1267

1268 **C – Piping system and fluid circulation**

1269

1270 **Set piping system and fluid circulation**

1271 Intake, BW and CIP pumps are common to all blocks and grouped in a same location,  
 1272 in a dedicated pump room for example. There is one of each for a given membrane facility  
 1273 regardless of the number of blocks. Furthermore, the membrane piping system is composed  
 1274 of six pipes common to all blocks and three pipes per rack. The six common pipes (intake,  
 1275 permeate, BW inlet and outlet, CIP inlet and outlet) are connected to each rack. The  
 1276 diameter of the common intake pipe depends on the number of installed blocks. The three  
 1277 rack pipes connect the top, bottom and permeate side of each module within a given rack.  
 1278 They have identical diameters because they are used interchangeably for filtration, BW and  
 1279 CIP, which moves in the direction of pipe standardization. As regards pipe lengths, Fig. C.1  
 1280 illustrates those involved during CIPs.

1281 Minor head loss is considered to calculate intake, BW and CIP pumping  
 1282 consumptions. There are three associated user-defined parameters for minor head loss  
 1283 coefficients (see Table C.1): in pipes common to all blocks, due to the prefilter placed at the  
 1284 outlet of the intake pump and in pipes within a rack. These coefficients are for example  
 1285 available from equipment manufacturers (*e.g.* suppliers for prefilters, valves, 90° bend...).

1286

1287 **Table C.1** User-defined parameters: pump efficiencies, piping system and minor loss

1288 coefficients

Category	Input parameter	Unit
<b>Pump efficiencies</b>	Intake pump efficiency	%
	BW pump efficiency	%
	CIP pump efficiency	%
<b>Piping system</b>	BW common pipe diameter	m
	CIP common pipe diameter	m
	Rack pipe diameter	m
	Rack pipe length between modules	m
	CIP common pipe length to first block	m
	CIP common pipe length between blocks	m



<b>Minor loss coefficients</b>	Common minor loss coefficient	no unit
	Prefilter minor loss coefficient	no unit
	Rack minor loss coefficient	no unit

1289

1290

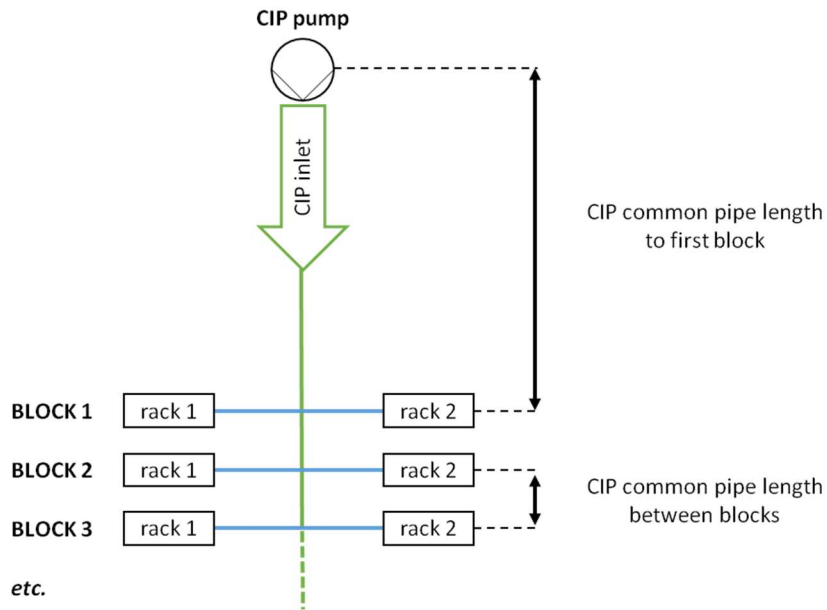

1291

1292

**Fig. C.1** CIP common pipe lengths

1293

**Execution of sequenced BW cycles**

1294 A BW cycle is composed of one phase during which a volume of permeate water per  
 1295 unit of membrane surface is pumped at a defined flux from the outside to the inside of  
 1296 hollow fibers. A chlorine-releasing compound may be injected during the first part of the BW  
 1297 phase. Modules are washed during the second part with only permeate water in order to  
 1298 eliminate any remaining compound in membrane pores (see Fig. C.2). The respective names  
 1299 of the above mentioned parameters are given in Table C.2.

1300

1301

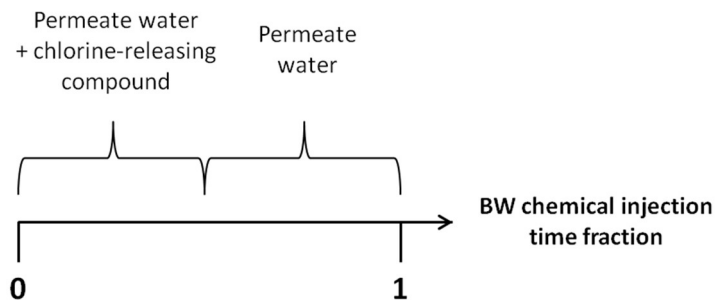

1302

1303

**Fig. C.2** BW chlorine-releasing compound injection time fraction

1304

1305

**Table C.2** User-defined parameters – BW operating conditions

Category	Input parameter	Unit
<b>BW operating conditions</b>	BW flux	L h <sup>-1</sup> m <sup>-2</sup> at 20°C
	Volume per BW per unit surface	L m <sup>-2</sup> per BW
	BW chemical concentration	ppm
	BW chemical injection time fraction	%

1306

1307

Racks are backwashed successively whilst the others are in the filtration mode: a first rack is cleaned, then a second, *etc.* Given flow values during BW cycles, this assumption is necessary to have reasonable pipe diameters (*i.e.* 0.25 m).

1310

For a given block during a BW cycle, a first rack is backwashed whilst the second is in stand-by mode. Then the first rack is set in stand-by mode whilst the second is backwashed. The immobilization duration of a given module due to backwashing is thus twice the BW duration applied to the module: the BW duration for the module's rack added to the BW duration for the second rack in the block (*i.e.* 2 $t_{BW}$  in Fig. C.3).

1315

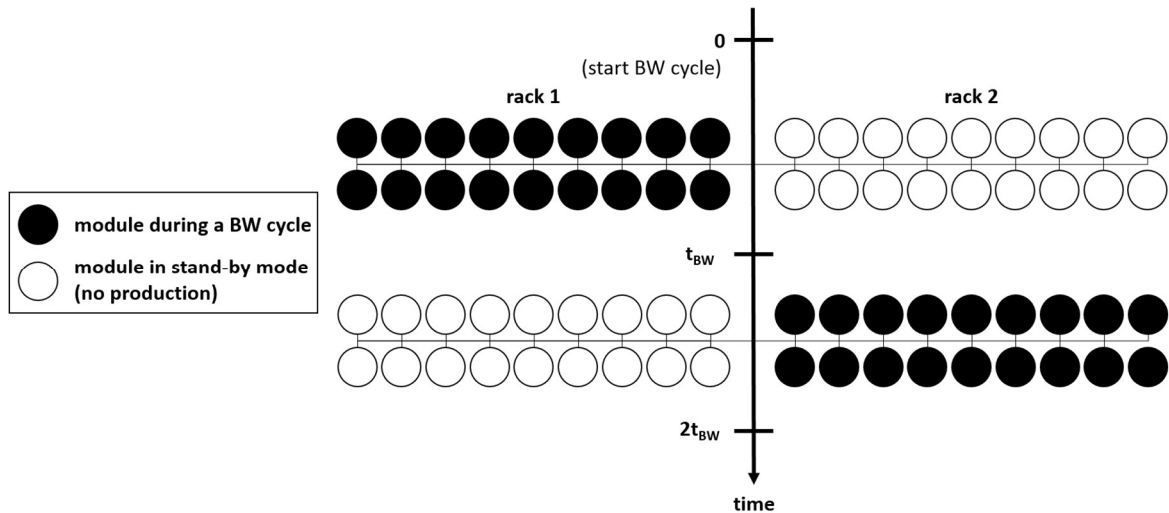

**Fig. C.3** Rack rotation for BW execution

**Execution of sequenced CIP cycles**

1320 A CIP cycle is composed of five phases (see Table C.3). There can be up to three  
 1321 phases (*i.e.* phases 1 to 3) during which a chemical solution (*i.e.* composed of chemical 1 to  
 1322 chemical 3) is filtered inside-outside of hollow fibers during a defined duration and then left  
 1323 to soak during another defined duration. As listed in Table C.4, the number of CIP phases  
 1324 involving a chemical solution is user-defined. Chemical concentrations, filtration fluxes and  
 1325 durations for each phase are also defined.

1326 In phase 4, permeate water is filtered inside-outside a defined number of times to  
 1327 dilute remaining chemical solution in membrane pores. Each filling of a rack lasts a defined  
 1328 amount of time. During phases 1 to 4, permeate is pumped back to the CIP tank.

1329 Phase 5 is a final rinsing step during which the permeate goes directly to waste. A  
 1330 defined volume per unit of membrane surface is filtered at a defined flux.

1332

**Table C.3** Five-phase CIP sequence

Consecutive CIP phase	CIP chemical solution	CIP flow direction
Phase 1	Permeate water + Chemical1	inside-outside, permeate back to CIP tank
Phase 1 soak		no flow
Phase 2	Permeate water + Chemical2	inside-outside, permeate back to CIP tank
Phase 2 soak		no flow
Phase 3	Permeate water + Chemical3	inside-outside, permeate back to CIP tank
Phase 3 soak		no flow
Phase 4	Permeate water	inside-outside, permeate back to CIP tank
Phase 5	Permeate water	inside-outside, permeate to waste

1333

1334

**Table C.4** User-defined parameters: CIP operating conditions

Category	Programming name	Unit
<b>CIP operating conditions</b>	Number of CIP chemical phases	no unit
	CIP chemical1 concentration	ppm
	CIP phase 1 flux	L h <sup>-1</sup> m <sup>-2</sup> at 20°C
	CIP phase 1 duration per rack	h
	CIP phase 1 soak duration per rack	h
	CIP chemical 2 concentration	ppm
	CIP phase 2 flux	L h <sup>-1</sup> m <sup>-2</sup> at 20°C
	CIP phase 2 duration per rack	h
	CIP phase 2 soak duration per rack	h
	CIP chemical 3 concentration	ppm
	CIP phase 3 flux	L h <sup>-1</sup> m <sup>-2</sup> at 20°C
	CIP phase 3 duration per rack	h
	CIP phase 3 soak duration per rack	h
	CIP phase 4 flux	L h <sup>-1</sup> m <sup>-2</sup> at 20°C
	CIP phase 4 duration per rack per filling	h
	CIP phase 4 number of fillings per rack	no unit
	CIP phase 5 flux	L h <sup>-1</sup> m <sup>-2</sup> at 20°C

CIP volume per phase 5 per unit surface

L m<sup>-2</sup> for CIP

Phase5

1335

1336

Racks are cleaned-in-place successively whilst others are in the filtration and BW

1337

modes: a first rack is cleaned, then a second, *etc.* Given flow values, this assumption is

1338

necessary to have reasonable CIP tank size (between 5 and 22 m<sup>3</sup> for racks between 18 and

1339

28 modules).

1340

For CIP phases 1 to 3, the phase's chemical solution fills the first rack and is then

1341

filtered whilst the second rack is in stand-by mode. During the soak period of the first rack,

1342

the chemical solution fills the second rack and is filtered. The soak period of the second rack

1343

can begin and finishes after the soak period of the first rack. The immobilization duration of

1344

a given module due to a CIP phase is thus twice the filtration duration plus one soak period

1345

(*i.e.*  $2t_{\text{CIP Phase}} + t_{\text{CIP Phase,soak}}$  in Fig. C.4). For CIP phase 4, each rack is filled one after the other:

1346

the immobilization duration of a given module is twice the filling duration applied to the

1347

module. The same applies for CIP phase 5. The total immobilization duration ( $t_{\text{CIP}}$ ) of a given

1348

module due to all five phases equals:

1349

$$t_{\text{CIP}} = (2 \cdot t_{\text{CIP Phase1}} + t_{\text{CIP Phase1,soak}}) + (2 \cdot t_{\text{CIP Phase2}} + t_{\text{CIP Phase2,soak}}) + (2 \cdot t_{\text{CIP Phase3}} + t_{\text{CIP Phase3,soak}}) + (2 \cdot t_{\text{CIP Phase4}}) + (2 \cdot t_{\text{CIP Phase5}}) \quad (\text{C.1})$$

1350

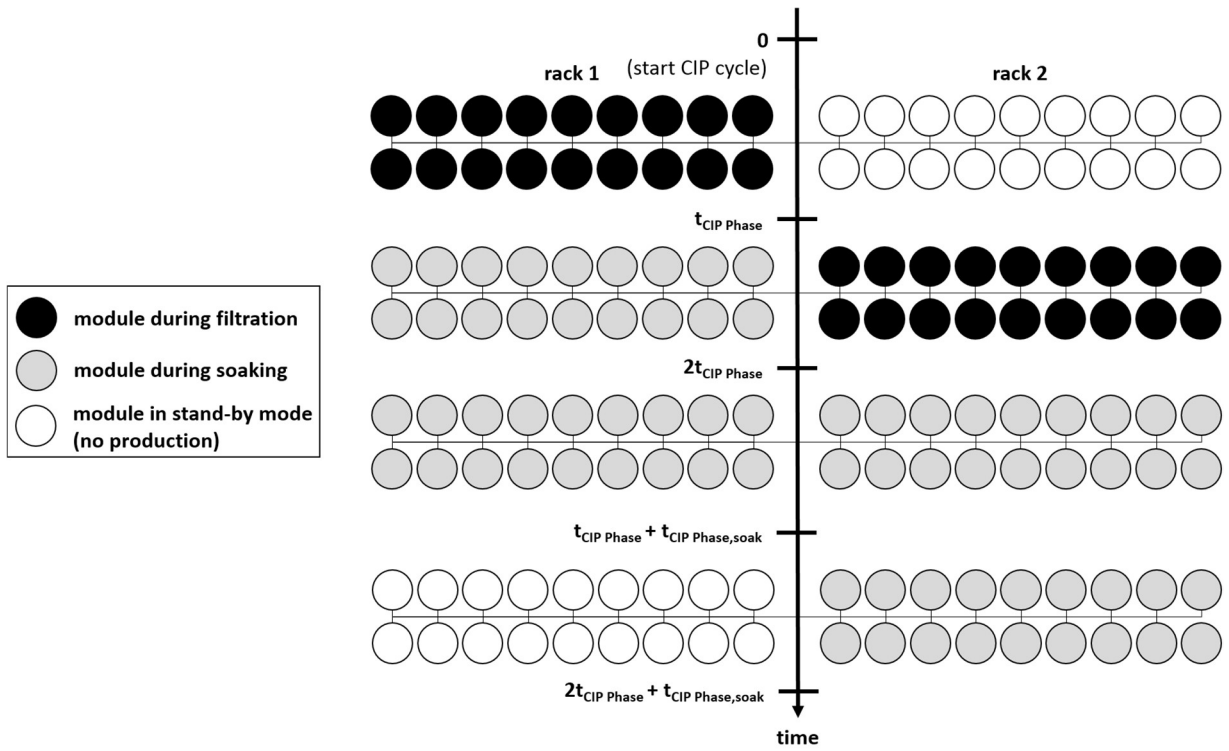

1351

1352

1353

**Fig. C.4** Rack rotation for CIP Phases 1 to 3 execution

1354 **D – Ecoinvent unit process for sensitivity analysis on electricity mix**

1355

1356 **Table D.1** Ecoinvent unit process for sensitivity analysis on electricity mix

<b>Electricity source</b>	<b>Ecoinvent unit process</b>
Hydropower	Electricity production, hydro, run-of-river
Wind	Electricity production, wind, <1MW turbine, onshore [FR]
Biomass	Heat and power co-generation, wood chips, 6667 kW, state-of-the-art 2014 [FR]
Solar	Electricity production, photovoltaic, 3kWp slanted-roof installation, multi-Si, panel, mounted

1357

1358 **E – Inventory for baseline scenario**

1359

1360 **Table E.1** Baseline scenario – Inventory and ecoinvent unit processes of membrane operation

Cluster	Process inputs and waste	Quantity (per m <sup>3</sup> ultrafiltered water)	Ecoinvent v3.4 unit process
<b>BW chemical</b>	Sodium hypochlorite (kg)	1.2 10 <sup>-4</sup>	Market for sodium hypochlorite, without water, in 15% solution state [GLO]
<b>CIP chemical</b>	Citric acid (kg)	2.9 10 <sup>-6</sup>	Citric acid production [RER]
	Ammonia (kg)	5.2 10 <sup>-7</sup>	Market for ammonia, liquid [RER]
	Sodium hydroxide (kg)	6.0 10 <sup>-7</sup>	Market for sodium hydroxide, without water, in 50% solution state [GLO]
<b>Waste</b>	CIP Phase 1 to 4 liquid waste (m <sup>3</sup> )	1.1 10 <sup>-5</sup>	Treatment of wastewater, average, capacity 4.7E10L/year [CH]
<b>Electricity</b>	Electricity (kWh)	3.4 10 <sup>-2</sup>	Market for electricity, medium voltage [FR]

1361

1362



1363 **F – Results for baseline scenario – Contribution of process inputs and waste**  
1364

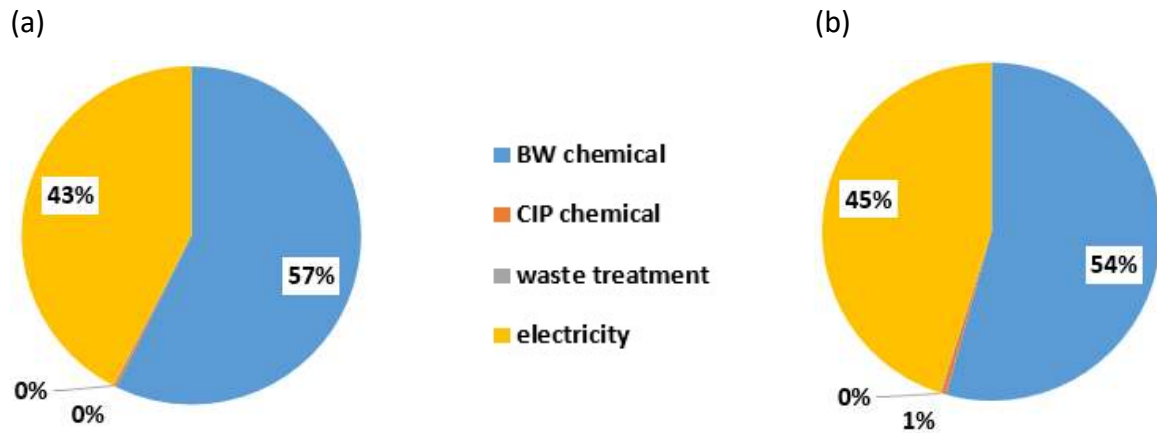

1365

1366 **Fig. F.1.** Baseline scenario – Contribution of process inputs and waste of membrane  
1367 operation to (a) IPCC GWP100a and (b) ReCiPe endpoint results

1368

1369

1370 **G – Scenario key parameters**

1371

1372 **Table G.1.** Scenario key parameters

Parameter	Scenario				
	Baseline	A	B	C	D
Operating cycle duration <sup>a</sup> (day)	365	365	296	265	265
Module operating life (year)	15.0	23.5	11.3	10.2	16.0
Number of filtration cycle (-)	126,529	200,000	123,039	85,701	134,893
Number of modules (-)	252	252	192	252	252
Filtration average TMP (bar)	0.60	0.54	0.79	0.60	0.60
End-of-life condition (-)	Lp <sup>b</sup>	n <sub>BW</sub> <sup>c</sup>	Lp <sup>b</sup>	Lp <sup>b</sup>	Lp <sup>b</sup>
<i>Consumptions</i>					
Electricity (kWh m <sup>-3</sup> )	0.034	0.032	0.058	0.034	0.034
<i>Filtration (kWh m<sup>-3</sup>)</i>	0.030	0.028	0.054	0.030	0.030
<i>BW (kWh m<sup>-3</sup>)</i>	0.003	0.004	0.004	0.003	0.003
<i>CIP (10<sup>-6</sup> kWh m<sup>-3</sup>)</i>	1.9	1.8	1.9	2.6	2.6
Sodium hypochlorite (10 <sup>-4</sup> kg m <sup>-3</sup> )	1.2	1.2	1.2	1.2	1.2
Citric acid (10 <sup>-6</sup> kg m <sup>-3</sup> )	2.9	3.0	2.6	3.9	8.1
Ammonia (10 <sup>-7</sup> kg m <sup>-3</sup> )	5.2	5.5	4.7	7.2	14
Sodium hydroxide (10 <sup>-7</sup> kg m <sup>-3</sup> )	6.0	6.2	5.3	8.2	17

1373 <sup>a</sup> Equivalent to CIP frequency

1374 <sup>b</sup> minimum productivity reached: final permeability (100 L h<sup>-1</sup> m<sup>-2</sup> bar<sup>-1</sup>)

1375 <sup>c</sup> maximum mechanical resistance reached: number of BW cycles (200,000)

1376