



**HAL**  
open science

# Revealing Evolutionary Patterns Behind Homogeneity: the Case of the Palaeolithic Assemblages from Notarchirico (Southern Italy)

Valentin Rineau, Marie-Hélène Moncel, Valéry Zeitoun

► **To cite this version:**

Valentin Rineau, Marie-Hélène Moncel, Valéry Zeitoun. Revealing Evolutionary Patterns Behind Homogeneity: the Case of the Palaeolithic Assemblages from Notarchirico (Southern Italy). *Journal of Archaeological Method and Theory*, 2022, 10.1007/s10816-022-09558-6 . hal-03741899

**HAL Id: hal-03741899**

**<https://hal.science/hal-03741899v1>**

Submitted on 2 Aug 2022

**HAL** is a multi-disciplinary open access archive for the deposit and dissemination of scientific research documents, whether they are published or not. The documents may come from teaching and research institutions in France or abroad, or from public or private research centers.

L'archive ouverte pluridisciplinaire **HAL**, est destinée au dépôt et à la diffusion de documents scientifiques de niveau recherche, publiés ou non, émanant des établissements d'enseignement et de recherche français ou étrangers, des laboratoires publics ou privés.

## Revealing evolutionary patterns behind homogeneity: the case of the Palaeolithic assemblages from Notarchirico (Southern Italy).

\*<sup>a</sup>Valentin Rineau, <sup>b</sup>Marie-Hélène Moncel, and <sup>c</sup>Valéry Zeitoun

<sup>a</sup>Center for Theoretical Study, Charles University & Czech Academy of Sciences, Jilská 1, 110 00 Praha 1, Czech Republic. ORCID: 0000-0001-8929-5201.

<sup>b</sup>CNRS, Histoire naturelle de l'Homme préhistorique (UMR 7194 HNHP), 1 rue René Panhard, 75013, Paris, France.

<sup>c</sup>CNRS, Centre de Recherche en Paléontologie - Paris (UMR 7207 CR2P), 4 place Jussieu, barre 46-56 5ème étage, case 104, 75005 Paris, France.

\*Corresponding author. E-mail: valentin.rineau@gmail.com

### Abstract

Notarchirico is at a nodal point in time and space for understanding the settlement of Europe in terms of migration or in situ evolution. Former technological analyses have not shown significant differences between the different lithic assemblages at Notarchirico. Our approach here is to produce a phylogenetic analysis of the lithic assemblages taken as the terminal of the analysis and interpreted as cultural units. In the cladistic framework, characters are hypotheses of relationships between lithic assemblages, and homologies are hypotheses of relationships between lithic objects; cores, flakes, nodules. To effectively grasp informative lithic innovations in the assemblages, we formalise cladistic hypotheses as hierarchical characters in the framework of three-item analysis, and propose a new algorithm to remove the high number of repeated terminals among trees inherent to a cladistic analysis of assemblages. Beyond the classic distinction of the presence or absence of bifaces, our analysis of the five Notarchirico layers, dated between 670 and 700 ka, highlights a well-supported cladogram grounded on complex hierarchical characters on lithic artefacts. This cladogram shows a paralogy event between the flakefree layer H, representing short-term occupancy, and the other layers representing long-term settlements. The resulting cladogram shows that relationships between lithic assemblages at Notarchirico do not follow the stratigraphy. Moreover, the Notarchirico lithic assemblages cannot be explained in an entirely local way, but seem to be part of a more complex European history.

**Keywords:** Lower Palaeolithic, Notarchirico, Europe, Cladistics, Three-item analysis, paralogy.

### 1. Introduction

While the earliest evidence of hominin occupations in Western Europe is currently dated back to around 1.4-1.2 Ma (Arzarello et al., 2007), from 900 to 700 ka, lithic assemblages record behavioural and technological innovations (biface production), suggesting arrivals of new populations attributed to *Homo heidelbergensis*, or local evolution (i.e., *Homo antecessor*), leading to the 'neanderthalisation' of the European population. Four sites are emblematic of this phase. The earliest one is the site of Barranc de la Boella in Spain, with some crudely-made bifaces dated to around 900 ka (Vallverdú et al., 2014) (Fig. 1). Then there is a chronological gap with three penecontemporaneous sites located both in southern and northern latitudes; Moulin Quignon in the Somme Valley (Northwest France), dated to 670 ka (Antoine et al., 2019), la Noira, Loire Basin (Centre of France), dated to 700 ka (Moncel et al., 2020a) and Notarchirico, Venosa basin (Italy), with a long sequence dated between 610 and 695 ka (Moncel et al., 2020b; Pereira et al., 2015). These three sites yield elaborate Large Cutting Tools (LCTs), including bifaces, and evidence of the Acheulean. At la Noira, better core management is also visible, attesting to a cognitive shift among some hominin groups around 700 ka. No transitional industries have been found so far between 900 and 700 ka and an abrupt introduction of new traditions with a rapid dispersal throughout Western Europe is the currently held hypothesis (Moncel et al., 2015). At the same time, several sites yield assemblages without bifaces, with only a large pebble tool component and evidence of core-and-flake debitage. The site of Isernia-la-Pineta (Italy), dated to 590 ka (Gallotti & Peretto, 2015; Pereira et al., 2015), is characteristic of this. The meaning behind the diversity of the composition of lithic assemblages remains obscure. It could reflect evidence of various traditions, some with bifaces, or rather depend on site function and raw material availability. Such a question has been addressed from the point of view of site seasonality by Binford and Binford (1966), but it was under discussion in relation to a characterisation of the sites by Bordes (1961) in the form of the

identification of typological facies of assemblages. The notion of the Levallois concept and the use of ‘chaîne opératoire’ (Mauss, 1947; Leroi-Gourhan, 1964) renders this old discussion obsolete, at least in the terms of the time.



**Fig. 1** Regional map with major sites dated from 1.2 Ma to 600 ka, some of which are penecontemporaneous with Notarchirico. Star: site without handaxes; diamond: site with handaxes

The site of Notarchirico is unique because it displays a long sequence of more than 15 occupation phases. Some of them yield bifaces while others are only composed of cores, flakes and pebble tools. Hominins moved along water channels, on beds of pebbles, possibly for scavenging large mammal carcasses, as many large herbivore broken bone remains are found associated with cores, flakes and LCTs in fine-grained siliceous stones and limestone, available in situ (Moncel et al., 2020b; Piperno, 1999). The new excavations provided access to the hitherto unknown base of the sequence, dated between 670 and 700 ka (Moncel et al., 2020b).

In the early levels of the site, we can thus distinguish the dichotomy observed elsewhere on different sites. At Notarchirico, layers F and G (670-680 ka) contain bifaces whereas layers H, I1 and I2 (680-695 ka) do not. What these successive phases of occupation have in common is the presence of cores and flakes, attesting to in situ debitage activities on the various available raw materials. The period concerned by our sequence covers around 30 ka, between 670 and 695 ka, and the time duration between each occupation phase is difficult to estimate.

Classical technological analyses of the core technology and end-products recorded in all the layers do not reveal clear differences between the layers with (layers F and G) or without bifaces (layers H, I1 and I2) (Moncel et al., 2020b). Moncel et al. (2020b) observe the same diversity of debitage methods and the quantitative and qualitative features do not seem relevant for differentiating occupation phases. Classical analyses thus point to stability despite minor technological differences without clear behavioural meaning. The end-products (i.e., flakes) are similar and the nodules collected for retouch show the same types of manufacture in most of the layers. Core technology does not seem to have been affected by the introduction of biface production and does not reveal a technological and cognitive shift between layers G and H, illustrating either different populations or a technological gap reached by previous populations.

However, the analysis of the diversity of traditions in the framework of cultural evolution can reveal patterns among the different phases of occupation (Santoro et al., 2020). Such patterns cannot be highlighted by classical analyses and require specific methods. Andrefsky and Godale (2015) cite Dunnell (1978), Meltzer (1981) or Neiman (1995) as pioneers in using evolutionary approaches to solve cultural questions on archaeological

material. In the following decades, archaeology became increasingly interested in the identification of historical patterns using methods traditionally applied in biology (e.g., Buchanan & Collard, 2008, 2007; Cochrane & Lipo, 2010; de Voogt et al., 2013; Jennings & Waters, 2014; Lycett, 2015, 2009, 2007; Lycett et al., 2009; Manem, 2020; Marwick, 2012; O'Brien et al., 2014, 2001). Other examples of applications were also used in ethnology (Jordan & Shennan, 2003; Le Bomin et al., 2016; Tehrani & Collard, 2002; Tehrani, 2013) or in linguistics (Ben Hamed et al., 2005; Gray & Atkinson, 2003; Gray & Jordan, 2000; Holden, 2002; Pagel et al., 2007; Rexová et al., 2003).

Traditions are the result of transmission processes – vertical, but also horizontal or oblique (e.g. Biro et al., 2003; Bryden et al., 2018; Moya et al., 2015; Nielsen et al., 2012; Ram et al., 2018) – which do not only affect modern humans (e.g. Brown & Laland, 2003; Cavalli-Sforza et al., 1982; Heyes, 1994; Krützen et al., 2005; Laland, 2004; Poole et al., 2005; van Schaik 2010). According to Willey (1953: 363): ‘typological similarity is an indicator of cultural relatedness, [...] such relatedness carries with it implications of a common or similar history’ but, as pointed out by O'Brien and Lyman (2000), it is necessary to distinguish between a resemblance resulting from relatedness – due to vertical transmission, or, in other terms, to descent with modifications (Gallay, 2012) – and a resemblance that is not. This refers to our understanding of homology (and accordingly, to analogy), one of the central concepts of cladistics. In prehistory, the analogy is carried by a comparatism between archaeology and ethnology according to which ‘the use of ethnologically documented mechanisms, such as diffusion and enculturation, helped explain the typological similarities in the archaeological record’ (O'Brien et al. 2001 : 1116). Such an analogy designates a particular type of inferential argument and inferring specific meaning from an abstract design on an artifact by analogy to a design of known context when there is no demonstrable continuity would be more likely to be false (Binford 1967). The problem with ethnographic analogy has been discussed many times in the past (Dunnell, 1971, 1978; Longacre, 1970; Sabloff et al., 1973; MacWhite 1956; Slotkin, 1952; Gould & Watson, 1982; Wylie 1985) implying how the analogy is drawn (Ascher, 1961; Binford, 1967). It is not our subject here to debate this or even to recognise the functions or nature of an archaeological object in relation to what exists in ethnographic examples, nevertheless, ‘Functional traits can be either homologous or analogous. In other words, functional traits – those that by definition affect the fitness of the bearer – can show up in two different lineages as a result of either common ancestry or convergence’ (O'Brien & Bentley, 2020 : 264). Regarding processional mechanisms of transmission, Shennan (2020) indicates that selection also depends on transmission in a space – and time-specific manner, depending on environmental pressures that may also lead to convergence, but justified analytical descriptions allow us to track transmitted variation by minimising the possibility of not identifying convergence. We are dealing with data that are very largely decoupled from any memory unlike American archaeology and, furthermore, several human taxa are potentially involved in the spatiotemporal dimension we are dealing with. We do not have, at least at this stage of our analytical proposal, the possibility of approaching the question of transmission in terms of process, as is possibly the case with actualist data or when approaching relatively recent periods. The question of the mode of appearance, independent in this case, which is not the subject of the comparatism between ethnology and archaeology is on the other hand ours. The idea that technological convergences can obscure population history is regularly raised (Binford & Binford, 1966; Binford, 1973; Boëda, 1997; Crassard et al., 2020; Lycett, 2007; McBrearty, 2003; Otte, 2003; Schmidt, 2020). It is therefore worth distinguishing whether this acceptance of convergence is identical between archaeologist/ethnologists and biologists (O'Brien et al., 2018). According to Otte (2003: 183) ‘Some forms were produced by multiple independently developed technological processes across the time span of human history in which they were used [...]. Certain well-known, but incorrect, interpretations are actually based on the results of convergent processes’ and, according to Lycett (2007): “the teardrop shape occurs repeatedly in the archaeological record in cases where there is no evidence of ‘phylogenetic’ relation [...] (Bifaces) from Africa, Europe, the Near East, and even the New World have similar plan forms, but there is clearly no ‘phylogenetic’ relationship among them”. The confusion is due to the morphological similarity of the objects and the uncertainty about their functionality. Several authors (Dunnell, 1978; Lycett, 2007; O'Brien et al., 2001; O'Brien & Lyman, 2003) thus emphasise the need to avoid the danger of interpreting all potential affinities in terms of homology because of convergence. However, convergence (and more generally, homoplasy) is only identifiable a posteriori in cladistics.

While it is still necessary to demonstrate the existence of links between Palaeolithic archaeological variability and fossil hominin taxa (Moncel et al., 2018), considerable behavioural differences between groups of Primates have been observed, the cause of which was assumed to be cultural or genetic (van Schaik et al, 2003; Whiten et al., 2005). Lycett et al. (2009) conducted cladistic analyses showing that the culture of the East African subspecies of chimpanzee is adaptive but that this was not the case when Eastern and Western subspecies were combined. This cultural diversity in the divergence of subspecies lends credence to the notion that variability in Palaeolithic material culture may, to some extent, reflect species and subspecies variations in hominin populations. Delagnes and Roche (2005) also suggest that early hominids displayed distinct technical competencies and technoeconomic patterns of behaviour, thus pointing to intra-site complexity and inter-site diversity. Foley (1987) suggested that earlier hominids appeared to use technology in far more limited ways, and variability was greatly

constrained. Indeed, it is possible that the use of tools among these taxa was constrained to the same extent and by the same means as physical, morphological attributes. However, as admitted by Foley (1987), at a finer scale, mismatches occur in such a global trend. Indeed, several human species or subspecies (Modern versus Neanderthal) share the same lithic toolkit in the Near East during the Middle Palaeolithic, suggesting horizontal transmission, and, during the Upper Palaeolithic in Europe, several material cultures existed within distinct modern human populations. As far as we are concerned, Notarchirico is at an intermediate level. Can we recognise evolution in practices between species such as *Homo heidelbergensis* and *Homo neanderthalensis* or different practices among populations belonging to an anthropological group in the process of becoming Neanderthal?

Thus, our aim is to use a new approach to test whether an evolutionary pattern is detectable in Notarchirico in relationships between lithic assemblages beyond the mere presence or absence of bifaces. The additional use of cultural attributes to contribute to the elaboration of the biological phylogeny of hominids was proposed by Foley in 1987 in the field of palaeoanthropology, then theorised by Foley and Lahr (2003), and corresponds to what we are interested in here, i.e., distinguishing different behaviours that could be historically related. However, unlike those authors, our aim is not to establish a global phylogenetic construction based on isolated artefacts or general technical modalities, but to analyse all of the lithic material present in the different layers of the same site in order to try to recognise nuanced variations or changes that could be attributed to particular practices or skills, that may or may not be interpreted as the signatures of different populations. We propose to apply a cladistic framework which considers the assemblages themselves as the objects of analysis, by reconstructing their evolution over time and classifying them in a qualitative approach by analysing the emergence of behavioural innovations in them. In this sense, we follow the approach implemented by Jennings and Waters (2014), based on previous work by Buchanan and Collard (2008) on lithic assemblages. But, if according to Lyman and O'Brien (1998: 616), 'In evolutionary archaeology, the population is artifacts, which are viewed as phenotypic features, and it is the differential representation of variation at all scales among artifacts for which it seeks explanations', the differential representation of variation can concern changes in proportions (quantitative) or the appearance of evolutionary innovations (qualitative) in the population. Here, we will deal with this second point. We propose a new approach where hypotheses of relationships between assemblages and between lithic artefacts are methodologically equivalent to characters and to homologies, respectively. In this framework, we use the three-item analysis method (3ia hereafter; Nelson & Platnick, 1991), where the characters are formalised as hierarchies, in conjunction with a method derived from Nelson & Ladiges (1996) in order to reveal relationships between the different Notarchirico assemblages.

## 2. Notarchirico

Notarchirico site (Venosa Basin) was discovered in 1979 and mainly excavated by Marcello Piperno. The site yielded a 7-m-thick sequence of fluvial sediments including 11 archaeological layers, five of which contain bifaces (Piperno, 1999). A hominin femur fragment was found in the upper part of the sequence (layer  $\alpha$ ), dated to 610 ka, and attributed to *Homo heidelbergensis*.  $^{40}\text{Ar}/^{39}\text{Ar}$  ages and ESR dates revised the chronology of the sequence excavated by Piperno (1999) and constrained archaeological layers alpha to F between ca. 610 and 675 ka, i.e., coeval with a glacial stage, MIS 16 (Pereira et al., 2015). The faunal assemblages from the upper layers A and  $\alpha$  can be attributed to the Isernia faunal unit. The archaeological material is associated with the remains of large herbivore carcasses on pebble and cobble beds representing shallow paleochannels (Santagata et al., 2020). The recent revision of the bifaces from the Piperno excavations demonstrated the Acheulean features of the LCTs made on limestone, quartzite and flint pebbles and nodules (Moncel et al., 2019).

New fieldwork initiated in 2016 concerned the poorly-known bottom of the sequence, below layer F. Five layers were found (G, H, I1, I2 and J), and all but layer J contain archaeological evidence of hominin occupations (Moncel et al., 2020b). Bifaces were found in layer G, pushing back the dates of the earliest known LCTs and the onset of the Acheulean in Italy and Western Europe. Layers H, I1 and I2 did not yield bifaces, but contained cores and flakes, and pebble tools. Layer J contains sparse artefacts, some of which are clearly not in situ. This series has thus been discarded from the study (Fig. 2). The lithic assemblages are composed of large tools made on pebbles (pebble tools, some cleavers and bifaces) and small thin or thick flakes mostly produced by core technologies. Some flakes are retouched on one or several edges or to shape a pointed tool. Hominins also selected small cubic nodules in diverse siliceous rocks (various colours and qualities of diverse petrographic types) to retouch them by denticulate and abrupt retouch. The bottom of the sequence is dated by  $\text{Ar}^{40}/\text{Ar}^{39}$  on tephras and ESR on sediments to 670 to 695 ka, attributing the whole sequence to the end of MIS 17 (temperate event) and the beginning of MIS 16 (cold event) (Moncel et al., 2020b). The lithic and bone material is dispersed on and included in 10-30 cm-thick beds of pebbles-cobbles, remains of lakeshores or water channels. Palaeontological analyses of the fragmented faunal material have revealed the presence of new species, including *Macaca* during MIS 17 (Mecozzi et al., 2021). In the South of Europe, paleoenvironmental data indicate that glacial and interglacial events were not really differentiated, with limited climatic variations. This would explain continuity in occupations in the South of Europe, and at Notarchirico. Our sequence in this paper only concerns MIS 17 and the transition to MIS 16 in layer F.

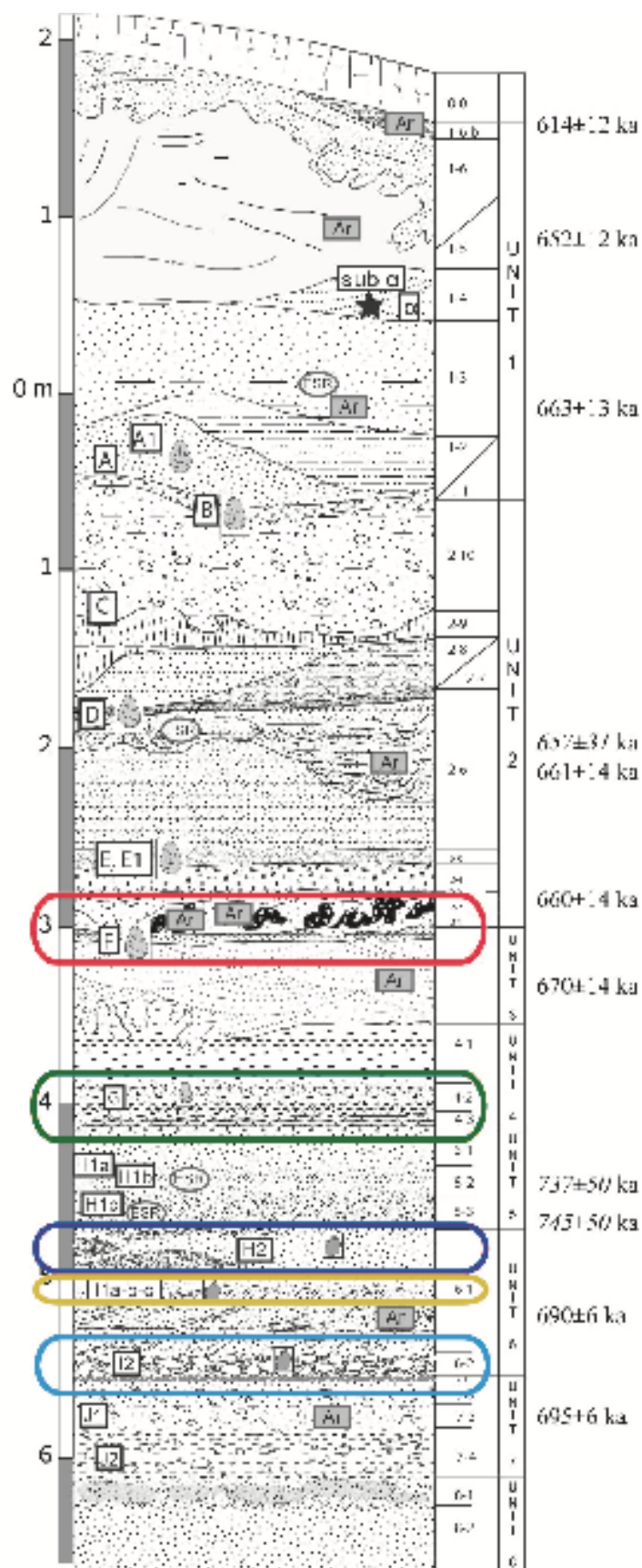

**Fig. 2** Schematic log of the total sequence of Notarchirico. Dates in italics by ESR-U-Th. Other dates by  $Ar^{39}/Ar^{40}$ . The layers excavated at the bottom of the sequence are indicated in colour, from layer F to layer I2

### 3. Material and methods

#### 3.1. Material

Our study focuses on layers F, G, H, I1 and I2. Layer F was excavated over 10 m<sup>2</sup>, layer G over 11 m<sup>2</sup>, layer H over 8 m<sup>2</sup>, layer I1 over 14 m<sup>2</sup> and layer I2 over 20 m<sup>2</sup>. Layers F and I2 contain dense beds of pebbles in situ (Fig. 3). Layer G consists of remains of partially disturbed beds of pebbles. Layer H is a deposit with sparse pebbles and dispersed bones and artefacts. The hypothesis is that layer H records short-term and sporadic passages of hominins while the other layers record recurrent occupations (Table 1 and 2). However, we know nothing about the actual size of the surface occupied by hominins along the water channels. The size of the excavated area is small and bifaces could have been worked elsewhere (areas of activities), with hominins possibly occupying large surfaces along water channel banks. Excavations at La Noira over 100 m<sup>2</sup> have demonstrated that hominins moved

and relocated artefacts over a large area (Despriée et al., 2016; Moncel et al., 2021). The small size of the excavations at Notarchirico may thus bias the analysis of lithic assemblages and the identification of strategies. As underlined by Jennings and Waters (2014) and O' Brien et al. (2014), in the same way as site function differences and the quantities of artefacts discarded at a site, discussions should also encompass the layer level. The different layers, which are probable palimpsests, can be made up of a more or less important mixtures of workshops, camps or hunting stands. The period concerned by our sequence covers around 30 ka, between 670 and 695 ka and the time duration between each phase of occupation is difficult to estimate.

For all the occupations, the raw materials selected by hominins are composed of fine-grained stones including siliceous stones (nodular chert, flysch chert, radiolarite). Most of them are small natural nodules of 10-50 cm. Hominins also selected limestone pebbles/cobbles and occasionally quartzite pebbles. Pebbles were sporadically used to produce some flakes, but were mainly

used for pebble tools and the rare bifaces. The fine grained stones were above all collected in situ for producing very small flakes on small cores. Hominins also collected very small fine-grained stone nodules (10-15 mm in length) for direct retouch. The diversity of external colours suggests limited selection criteria, probably focusing

on shape and size. The nodules are slightly rolled, cubic, and are from nearby primary formations and found directly on the site. Core technology is mostly simple, using the natural shape of the nodules with one knapping surface or orthogonal surfaces, and few removals. The striking platform is rarely prepared. Flakes are small (less than 20 mm long) on account of the small size of the nodules. Backed flakes are common as a result of the use of the core edge to facilitate debitage. The frequent use of very small and cubic nodules (10-15 mm long) for direct retouch is also noteworthy. Classical technological analyses of the assemblages did not underline differences between layers, either for core technologies or for end products and retouch.

Layer	J	I2	II	H	G	F
Unifacial convergent LCT tools		2			6	5
Bifaces					2	4
Unifacial pebble tools	2	5	9	1	15	34
Bifacial pebble tools		1	2		2	6
Pointed unifacial pebble tools			2		6	10
Pointed bifacial pebble tools/LCTs			1			4
Trifacial pebble tools			1		1	
Rabots on pebbles		1			2	5
Quadrangular unifacial tools						2
Broken pebbles with impacts + isolated removals			1		31	52
Flakes		2	2		7	46
Other stone products		1	5	1		4

**Table 1.** Heavy-duty component on limestone pebbles per archaeological layer (number) and flakes in other stones.

Layer	J	I2	II	H	G	F
Unretouched flakes	5 (4)	40 (18)	98 (9)	21 (7)	78 (33)	177 (29)
Broken flakes-debris		9 (3)	95 (10)	19 (6)	78 (23)	66 (7)
Retouched nodules		4	21	1	50	12
Cores	1	6	10		25	10
Bifacial tools					1	1
Bifaces						1

**Table 2.** The toolkit on fine-grained stones: total number of flakes, fragments of flakes, retouched nodules and heavy-duty tools per archaeological layer, with the number of retouched elements in parentheses.

## 3.2. Methods

### 3.2.1. Cladistics and archaeology

Cladistic theory is the theory of evolutionary patterns, which are built as rooted trees called cladograms. Cladistic theory can be applied to various disciplinary fields on three conditions: (i) the entities under study can be generalised into clades with intrinsic properties, (ii) these clades form a unique hierarchy and (iii) an explanatory theory, such as Darwinian (Mesoudi et al., 2004; Mesoudi 2016) or neutral evolution for example, can make historical sense of the reconstructed cladogram (Ung et al., 2016). More generally, the framework must allow for variations in the object pool studied (i.e., evolutionary innovations), and some of those variations must be heritable by vertical transmission (Zaragüeta i Bagils, 2011). In this framework, the tree-like structure of the cladogram represents the degree of kinship relationship interpreted through the notions of variation and inheritance which are at the source of the appearance of new taxa. All of these points justify the use of cladistics to reconstruct kinship relationships between cultural entities (e.g., Dunnell, 1978; Lyman & O'Brien, 1997; O'Brien & Lyman, 2000, 2003; O'Brien et al., 2012; Shennan, 2011, 2008, 2002), recently repeated and discussed (Lycett, 2015; Mesoudi, 2016; Straffon, 2016).

Cladistic theory comes with a method, cladistic analysis, which aims to reconstruct cladograms using characters. In order to explain the specificities of the cladistic method, we will briefly present its six main principles. The statement of these six principles will help us to understand how we can manage lithic objects in cladistics:

(i) Analysis of the whole, synthesis of the parts (Cao et al., 2007; Hennig, 1966; Nelson, 1994; Zaragüeta i Bagils & Pécaud, 2016). The search for kinship relationships between objects is a complex problem. Cladistic analysis works by decomposing the complex problem of kinship relationships between objects into sub-problems of kinship relationships between parts of objects. Hypotheses of relatedness between parts of objects (i.e., homologies) are the source of hypotheses of relatedness between objects (i.e., characters), the synthesis of which generates the final cladogram.

(ii) Non-circularity (Nelson, 1994; de Pinna, 1991). The justification for each character must be found outside the cladistic method. The characters are necessarily independent of each other.

(iii) Comparison (Prin, 2012). Comparison is the empirical source of knowledge in cladistics. Comparison is the source of arguments for constructing characters.

(iv) Grouping rule (Hennig, 1965; Nelson & Platnick, 1981). Homology hypotheses are generated by generalising the observations made during the comparison of objects. Generalisation allow to group objects in classes.

(v) Congruence maximisation (Farris, 1983; Hennig, 1965, 1966; Nelson, 1994; Patterson, 1982; de Pinna 1991). Since a hypothesis cannot be rejected without arguments, and a hypothesis can only be rejected on the basis of the existence of another contradictory hypothesis, the cladogram is the solution that retains the maximum number of hypotheses, i.e., the one that rejects the minimum number of hypotheses formulated upstream. The congruence between independent characters allows for the detection of a common history.

(vi) Logical analysis (Cao et al., 2007). The general solution (i.e., the cladogram) says nothing more than the aggregation of all the partial solutions (i.e., the characters). This rule therefore implies that the cladogram and the characters must share the same mathematical structure, i.e., an inclusive hierarchy.

The resulting cladogram is thus an evolutionary pattern obtained from the comparison of objects. Cladistics makes no a priori assumptions about the processes responsible for distribution patterns. In cultural studies, conceptual entities such as tales (Tehrani, 2013), games (de Voogt et al., 2013), musical practices (Le Bomin et al., 2016), chaînes opératoires (Manem, 2020) or languages (Ben Hamed et al., 2005; Gray & Atkinson, 2003; Gray & Jordan, 2000; Holden, 2002; Jordan & O'Neill, 2010; Pagel et al., 2007; Rexová et al., 2003) have been used as objects (entities for which the cladistic analysis makes it possible to highlight relationships), reflecting a set of practices with character hypotheses grounded on manufactured objects, behaviours, or both (Jordan & Shennan, 2003). Cladistics can also be directly applied to complex manufactured objects (Cochrane et al., 2013; Collard et al., 2006; Lycett 2007, 2009, 2015; Marwick, 2012; O'Brien et al., 2001, 2014; Tehrani & Collard, 2002), taken as terminals of the analysis (i.e., Operational Taxonomic Units). However, it is not these objects that are the target of selection but rather the human practices leading to their production. This has led Buchanan and Collard (2008, 2007) and Jennings and Waters (2014) to code assemblages of objects instead of objects themselves. They used cladistic analysis for assessing potential relationships between cultural entities. Jennings and Waters (2014), following Buchanan and Collard (2008), worked on assemblages from different sites but, according to those authors: ' [...] similarities provide evidence for shared behaviors and technological decisions, while differences hint at important behavioral and technological distinctions' (p. 31). In this respect, we must ask ourselves the question (cf. O'Brien and Lyman 2002) of the nature of the assemblages taken into account. Are they proxies of (chronological) phases, of (cultural) components, or do they represent delimited empirical units, or archaeological constructions arbitrarily extracted from a more or less continuous register of variability and/or covering activities more or less associated with a season? Dunnell (1980) suggested that the archaeological record should be viewed as a paleontologist would view a fossil bed, i.e. "as a population of 'things' that represent the



hard parts of past phenotypes” . We are not in the context of sites that allow an instantaneous ‘ photographic’ reading of fixed activity or activities but in a vertical, stratigraphic reading of the evolution of a single Lower Pleistocene site. We considered archaeological layers materially delimited according to sedimentary components.



**Fig. 3 a.** Photography with the layers of the new excavations on slope ill outside M. Piperno’s fieldwork building.  
**b.** Details of the pebble-cobble ‘pavement’ in layer I2

The layers, the units of our analysis, remain palimpsests. Thus, each archaeological layer is, in our approach, comparable to an individual, each lithic element being one of its ‘ anatomical’ components. Each component is described according to the perception of the prehistorians and then transcribed in the form of a coding of information. It is only at the end of the cladistic analysis that hypotheses can be proposed as to the recognition of recorded activity or activities, changes in the management of raw materials, the production of objects transposed into different behaviors or not.

One of the main aims of this paper is to show the equivalence between assemblage analysis in cladistics and cladistic biogeography, and the heuristic power of this connection. Cladistic analysis can be applied to taxa by coding characters of their parts (e.g., limbs) to produce a phylogeny. Biogeography is a meta-analysis that focuses not on taxa but on biogeographic areas. It proposes that biogeographic information can only come from its constituents, i.e., taxa. If areas evolve, as areas are defined by a set of taxa, then taxa also evolve, and phylogenetic relationships between taxa constitute the source of knowledge of cladistic relationships between biogeographic areas. In this context, the phylogenies, i.e. hypotheses of relatedness between taxa (theoretically equivalent to homologies) are the source of hypotheses of relatedness between areas (i.e., characters), the synthesis of which generates the final cladogram (Nelson & Platnick, 1981; Platnick & Nelson, 1978). We consider that the items to be classified are occupation layers, or assemblages, and that the source of knowledge of these layers is

their constituents, i.e., the lithic objects found in these layers. The hypotheses of relatedness between lithic objects are the source of hypotheses of relatedness between layers. Therefore, building hypotheses of relationships between lithic objects corresponds to the formalisation of homologies. From these homologies, we can propose character hypotheses on the basis that if assemblages (as proxies of cultural traditions) have evolved, then their constituents, contained in these layers, also have evolved. The approach used herein can thus be constructively compared to cladistic biogeography where biogeographic areas and their constituents, the taxa, evolve in a concerted fashion. This proposal has very strong practical consequences for the methods and techniques from cladistics that can be used to reconstruct a cladogram of lithic assemblages. To this end, in the cladistic framework, we show in the next part that 3ia (Nelson & Platnick, 1991; Zaragüeta i Bagils et al., 2012) is a powerful method for achieving this objective with a new method derived from Nelson and Ladiges (1996) work.

### 3.2.2. Three-item analysis

Several different methods of cladistic analysis exist. The currently most widely used method is parsimony (Farris, 1970, 1977; Fitch, 1971; Kluge & Farris, 1969). However, this method has many theoretical and methodological flaws, some examples of which we will present here. (i) Characters are coded as partitions (collections of mutually exclusive states; Colless, 1985; Farris, 1970; Pimentel & Riggins, 1987; Pogue & Mickevich, 1990). If the aim of cladistic analysis is to reconstruct hierarchical trees and the source of knowledge for these trees is the characters, then mathematically the characters should be of the same form (Williams & Ebach, 2006). (ii) Parsimony during the optimisation process allows nodes in the tree to be supported by losses where absence was not originally coded as a potentially informative state. As a result, parsimony generates unwanted hypotheses and involves supporting nodes with absence, which cladistics criticised for seeking to group by global similarity as in phenetics (De Laet & Smets, 1998; Siebert & Williams, 1998), whereas the cladistic revolution was to select only derived states (Hennig, 1966). However, we emphasise that criticism about the use of absences to support nodes does not imply the negation of the existence of reversals. (iii) In parsimony, missing data (i.e., all states are possible), polymorphism (i.e., several states are true at the same time) and non-applicable data (i.e., all states are impossible) are all handled by the same procedure, the optimisation of transformation steps on the tree to select only one state for the specified taxon. However, this single approach addresses three opposite problems in the same way by optimisation during analysis to the post-parsimonious state (which circumvent the non circularity rule). (iv) Maximising congruence, i.e., retaining the maximum number of synapomorphies (a synapomorphy being an homolog supporting a clade) is not equivalent to minimising incongruence, i.e. minimizing the number of steps (de Pinna, 1991). These criticisms against Parsimony apply equally to Bayesian inference and Maximum Likelihood, which also use mathematically formalised characters as partitions, which are thus affected by the same issues.

The 3ia is an alternative cladistic method to parsimony (Nelson et al., 2003; Zaragüeta i Bagils et al., 2012). The method necessitates to encode each character as a set of nested classes – resulting in a hierarchical tree – where each character state is a class in the hierarchy. Each character tree is then decomposed into minimal relationship hypotheses, the three-item statements (3is hereafter). The optimal trees resulting from the analysis are those that minimise the number of rejected hypotheses. 3ia addresses all these criticisms in a relevant way: characters are hierarchical (Cao et al., 2007), clades cannot be supported by losses (De Laet & Smets, 1998; Rineau et al., 2015), specific procedures exist for each abovementioned problem (Faure-Brac et al., 2020; Zaragüeta i Bagils & Bourdon, 2007), and maximising congruence (retaining the maximum number of 3is) is equivalent to minimising incongruence (minimising the number of rejected 3is). Furthermore, several examples have been proposed in the literature to show the preferable behaviour of 3ia over parsimony (Nelson, 1996; Nelson & Platnick, 1991). Moreover, recent simulations have empirically shown the efficiency of 3ia (Rineau et al., 2015, 2018, 2021). A general review of 3ia is available in Rineau (2017).

In particular for our study, 3ia can be adapted very simply to the analysis of lithic objects (Fig. 4). Cladistic analysis decomposes the object to analyse its parts. This is the case in phylogenetics where the taxa are decomposed into their (e.g., morphoanatomical) parts or in biogeography where biogeographic areas are decomposed into their taxa (Nelson & Platnick, 1981). We are not seeking to reconstruct a phylogeny of the tools themselves e.g., cores, flakes or nodules. Our approach is to consider lithic elements as features of assemblages (here layers F, G, H, I1, and I2) which are considered to be equivalent to taxa. Thus, homologies on lithic elements can allow us to deduce characters from layers. The justification of the part-whole analysis is the same as in phylogenetics: if layers evolve, then the cores, flakes and nodules included within them must also evolve, and congruence maximisation should reveal kinship relationships between layers.

Finally, several advantages of 3ia are particularly important for this analysis. There is no basal trichotomy due to the a priori rooting of traits, which is useful given the low number of terminals used in our analysis. Complete freedom is given by the method to define rooting: using outgroups for the entire set of characters, using a different outgroup for each character, etc. Moreover, only three terminals are required to form an informative character  $a, (b, c)$  which specifies that  $b$  and  $c$  are more related to each other than to  $a$ . On the contrary, four instances are needed in parsimony due to the basal trichotomy. Finally, it is possible to consider all states as derived

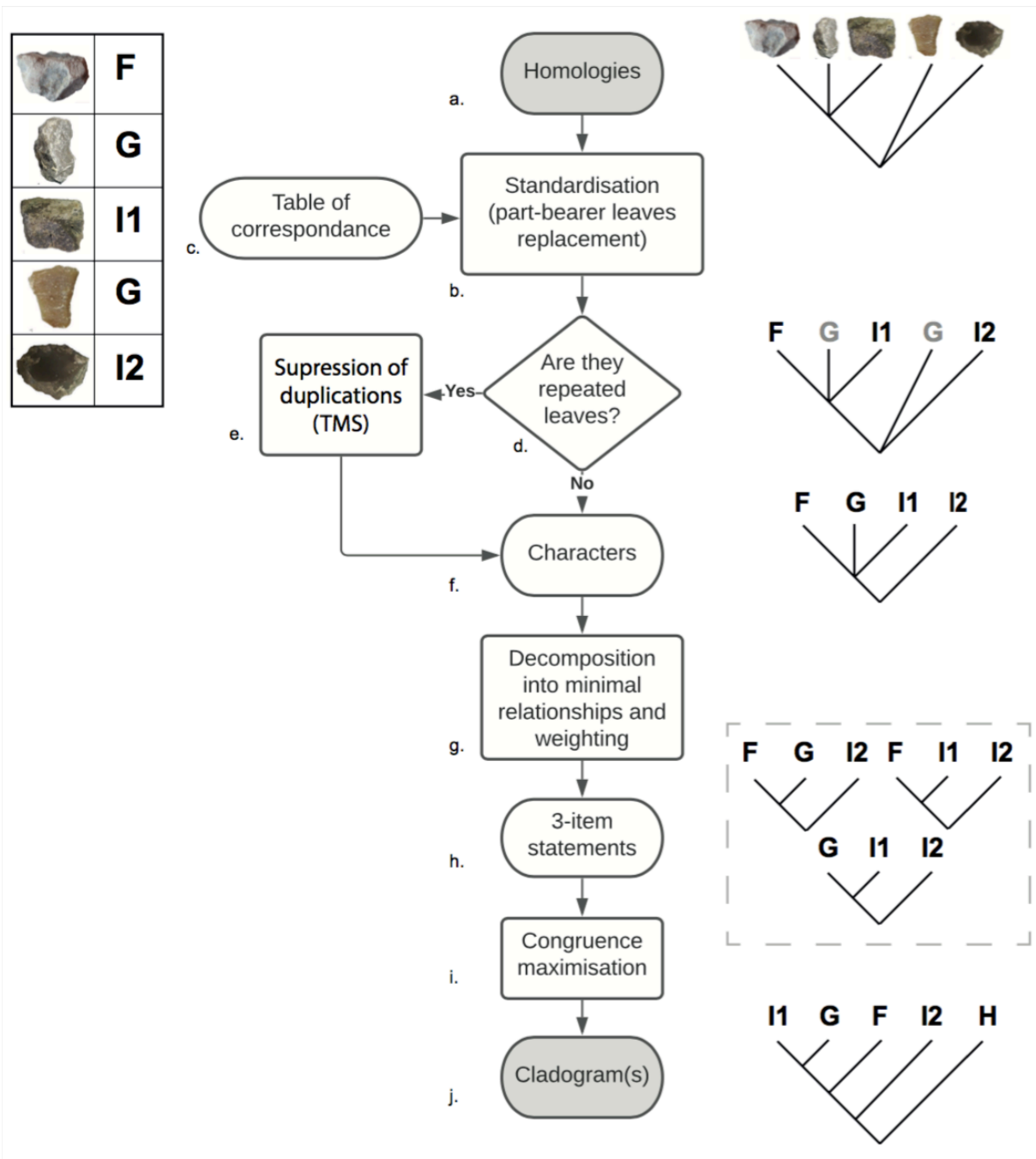

**Fig. 4** Flowchart of a standard three-item analysis and examples with layer analysis using lithic assemblages. **a.** Homologies. Hypotheses of relationships between lithic objects coded in trees. **b.** Standardisation. Replacement of the leaves from homologies to their corresponding layers with a table of correspondance. **c.** Table of correspondance between lithic objects and layers. **d.** Are they repeated leaves? If true, then a procedure must remove repetitions before the main analysis. **e.** Triplet Maximisation Subtree analysis. Procedure of repetition removal by traversing the tree, deleting leaves and cutting the tree into subtrees. **f.** Characters. Hypotheses of relationships between layers coded in trees from the standardization of homologies. **g.** Decomposition. Each tree is decomposed in 3is to ensure precise and efficient congruence maximization procedure. A weight reflecting its information content is attached to each 3is. **h.** 3-item statements. Set of minimal trees deduced from characters stating that two layers are more closely related between them than any is to a third. **i.** Congruence maximization. Procedure aiming to find the maximal set of compatible 3is. It is therefore possible that several sets of compatible 3is are optimal (leading to several optimal cladograms) **j.** Cladogram(s). Result of the cladistic analysis. Most congruent tree(s) stating the cladistic relationships between the studied layers.

states in 3ia, e.g., ((small),(large)), leading to more possibilities of hypotheses formalisation for the researcher. Hence, in the absence of elements to distinguish between plesiomorphic and apomorphic states, we consider that each of the classes is potentially useful for grouping terminals. A non-ordered character in parsimony is not equivalent because it is not possible to have an unassigned state using this method. Theoretically, these issues in parsimony are due to the mathematical structure of characters, defined as partitions (see above), i.e., a collection of mutually exclusive states (Colless, 1985; Farris, 1970; Pimentel & Riggins, 1987; Pogue & Mickevich, 1990), and preclude the formalisation of characters as hierarchies in the same way as cladograms.

### 3.2.3. Homologies on lithic objects

The 3ia is used here to produce an analysis of the relationships between the Notarchirico layers based on the presence of innovations in the lithic assemblages. Our approach is qualitative; we consider that the presence of one innovative object is sufficient to consider that the whole layer presents the innovation. We consider that variations in the choice of certain materials or in the way lithic artefacts are knapped reflect a behavioural variation that allows us to characterise the evolution of human practices. Each layer has been characterised by the characteristics of the cores, flakes, and nodules it contains because these three categories reflect specific management strategies of available raw materials.

We sought to maximise the number of possible states. Then, we grouped these states into more general states when possible and relevant. We considered any variation detected by comparison between lithic objects as potentially interesting to produce hypotheses of cladistic relationships. In the end, 27 homology hypotheses were formulated in the form of hierarchical classifications of lithic objects (Online Resource 1-5). Variations on the type of raw material selected, on global morphology, on the presence of cortex or the angle of removals are common to cores, flakes and nodules. Variations on the blank, type and location of removals are coded for cores and flakes, and the type and location of retouch for flakes and nodules. The type of cortex is coded for cores only, and the number of removals, type and angle for flakes. Finally, the presence of cores and nodules allows all layers to be grouped together relatively to H, where the lithic assemblage is composed only of flakes.

These homologies are constructed using qualitative (e.g., the type of removal of cores) or quantitative comparisons (e.g., the angle of removals of cores). For variations in the distribution of a single variable, such as angle measurements, angle platform and number of removals, the Jenks natural break optimisation method (Jenks, 1967) was used to discriminate two groups of homologies each time. For the morphology of lithic objects, consisting of the variable's length, width and thickness, we conducted a PCA analysis to detect covariation between the three variables in order to treat them independently or not. Due to strong covariation, we conducted a clustering analysis on the three variables by k-means (MacQueen, 1967) using the silhouette method (Rousseeuw, 1987) to find the optimal number of clusters. For all quantitative characteristics, we were never able to distinguish an obvious separation that would allow us to create groups. We therefore minimised the number of states to two each time to avoid giving too much weight to the characters, given the difficulty in distinguishing groups.

In general, it was impossible to find strong support for polarity. We thus used an interesting property of 3ia which allowed us to hypothesise all states as potentially derived. For example, we can build a tree of small/large flakes while hypothesising that small is ancestral and large is derived (small),(large)). But contrary to parsimony, it is also possible to code ((small),(large)) and then to allow the program to group flakes for both states. This procedure was applied to all homologies except the absence/presence of cores, nodules, retouch in nodules, where only the presence is considered as significant. Homologies are detailed (Online Resource 1) and coded in hierarchical matrices (Cao et al., 2007) (Online Resource 2-4), equivalent to traditional taxon/character matrices but with specification in an additional line of the hierarchical structure of each character. Identical rows in the hierarchical matrices were merged to optimize computation time.

### 3.2.4. Assemblage analysis.

Once the homologies are encoded in a hierarchy, we replace the parts (e.g., lithic objects) by their bearers (i.e., the layers) in order to obtain characters (Fig. 4, Online Resource 5) using a correspondence table (Online Resource 6). Due to the specificity of our protocol for obtaining characters, there are many repeated leaves for each tree. These repetitions must be removed according to a specific procedure. Here we propose a new algorithm named Triplet Maximisation Subtree (TMS) derived from Nelson and Ladiges (1996). We specifically developed the TMS algorithm to remove repeated leaves from rooted trees while maximising the amount of 3is (the triplets) kept in a coherent way.

The TMS algorithm is as follows: all informative nodes in the tree are traversed from the least inclusive to the most inclusive nodes. As soon as a node contains repeated leaves, if it is not a symmetrical node (i.e., a node including more than one internal node), for each taxon we only keep one leaf located in the least inclusive node and prune the others. As we are working with inclusive hierarchies, if A is a group included in group B, an element of A is necessarily also an element of B by inclusion. If the node is symmetric, we create a copy of the tree for each node included in the symmetric node. For each node included in the symmetric node, we take a copy of the

initial tree, delete all informative nodes except the node included in the symmetric node and all the nodes included in it. We delete the internal nodes included in the symmetric node in the original tree and continue traversing.

In this way, the maximum number of groups and relationships are preserved (Figure 5). Consider the case of  $(a, (b, ((c, d), (e, (f, d))))))$ . It is not known which repeated instance of  $d$  to delete. The application of the TMS algorithm leads to three subtrees,  $(a, b, (c, d), e, f, d))$ ,  $(a, b, c, d, e, (f, d))$ ,  $(a, (b, (c, d, e, f, d)))$ . This method is different from Nelson and Ladiges (1996) to avoid the overweighting of nodes between the root and the symmetric node. It allows also us to keep the symmetric node as we consider that it displays information in contexts where we do not know what causes repetitions (not necessarily a paralogy event). We present below a formal version of the TMS algorithm. For a tree  $T$ ,  $L(v_i)$  is the set of leaves included in a node  $v_i$ ,  $D(v_i)$  is the set of subtrees directly connected to a node  $v_i$  that are not leaves,  $postorder$  indicates the way to iterate the nodes of the tree from the least inclusive internal nodes to the most inclusive ones, and  $duplication(L(v_i))$  is a function that takes a set of leaves and returns a set containing only leaves that are repeated more than once.

**Algorithm: Triplet Maximisation Subtree**

input:  $T$  – a hierarchical tree with repeated leaves  
output:  $S$  – a set of one or several trees without repeated leaves

```

 $S \leftarrow \emptyset$ 
for  $v_i$  in  $T$  (postorder) do
    if  $duplication(L(v_i))$ 
        if  $|D(v_i)| \leq 1$ 
            for  $l$  in  $L(v_i)$  do
                if  $l \in duplication(L(v_i))$ 
                    delete  $l$  from  $T$ 
        if  $|D(v_i)| \geq 2$ 
            for  $v_{ij}$  in  $D(v_i)$  do
                 $s \leftarrow T$ 
                for  $w_k$  in  $s$  (postorder) do
                    if  $L(w_k) \not\subseteq L(v_{ij})$ 
                        delete  $w_k$  from  $s$ 
                 $S \leftarrow S \cup \{s\}$ 
            for  $x_l$  in  $T$  (postorder) do
                if  $L(x_l) \subset L(v_i)$ 
                    delete  $x_l$  from  $s$ 
 $S \leftarrow S \cup \{T\}$ 
return  $S$ 

```

Then we remove non-informative character trees. In 3ia, for a character to be informative, it must be able to minimally state that two objects are more related between them than to a third. Once the characters without repetitions are generated, they are broken down into minimum 3-item statements, the 3is (Fig. 4), following the weighting procedure of Rineau et al. (2021). Then cladograms are constructed using the 3is maximisation criterion. The character states are mapped on the cladogram (Cao, 2008; Rineau, 2017) and retention indices (RI) are calculated globally and for each character (Kitching et al., 1998). The analysis and calculation of the RI was carried out using Lisbeth 1.0. The input .3ia file is available in Online Resource 7.

Then we carried out a statistical analysis in order to ascertain whether the tree obtained was statistically different or not from a tree obtained from random characters. For each of the 100 analyses, we take the hierarchical characters and we randomly shuffle the leaves. Then we produced the analysis and calculated the RI.

Finally, to test if layers could be discriminated statistically or not, we also carried out Non-Metric Multidimensional Scaling (NMDS) analyses on the five layers for cores, flakes, and nodules. For each set of lithic objects, we took the original matrix and split all complex characters into sets of absence-presence characters. The resulting analyses try to maximise inter-group variation and to minimise intra-group variation.

#### 4. Results

The result of the 3ia analysis is a single fully resolved tree (Fig. 6) constructed from 9 homologies on cores, 11 on flakes and 7 on nodules, for a total of 27. The tree is entirely asymmetric. The homologies contain 128 derived states. After the replacement of elements by their layers and subsequent repetition deletion, 74 out of 128 character states are not informative. Fifty-four states were therefore decomposed into 3is and accepted or rejected by the congruence maximisation procedure. Of the 54 states, 7 do not contribute at all to the optimal cladogram (RI: 0%), 31 are fully accepted (RI: 100%) and 16 are partially accepted (1 at 16.67%, 4 at 33.33%, 8 at 50%, 3 at 66.67%). The overall retention index is 0.71, which implies that 71.09% of the weighted 3is produced

were used to build the tree. The analysis was also re-run by removing the absence/presence characters on cores and flakes, which did not change the topology.

The distribution of character states on the tree has a specific pattern. Node 1 is mainly supported by flakes; the number of characters on flakes supporting node 1 is much higher (13) than for nodes 2 (2) and 3 (1). The random shuffle analysis indicates that the resulting tree is significantly different from a tree obtained by chance (value; Fig. 7). While 3ia gave a well-supported hierarchical pattern, all of the three NMDS analyses were inconclusive without any possible statistical distinction of layers by their lithic content, which appears completely homogenous.

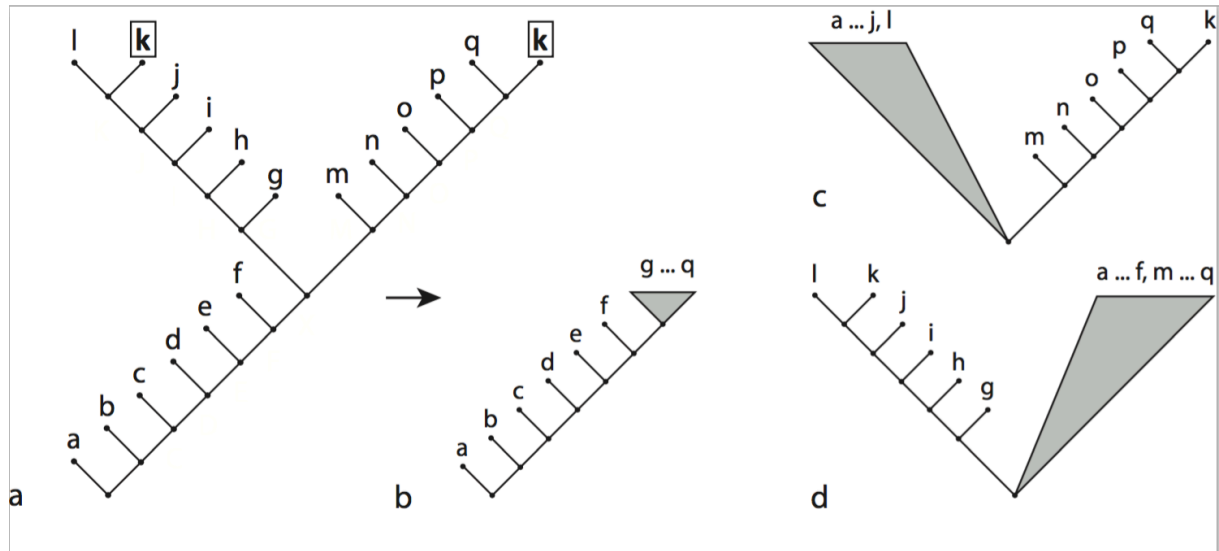
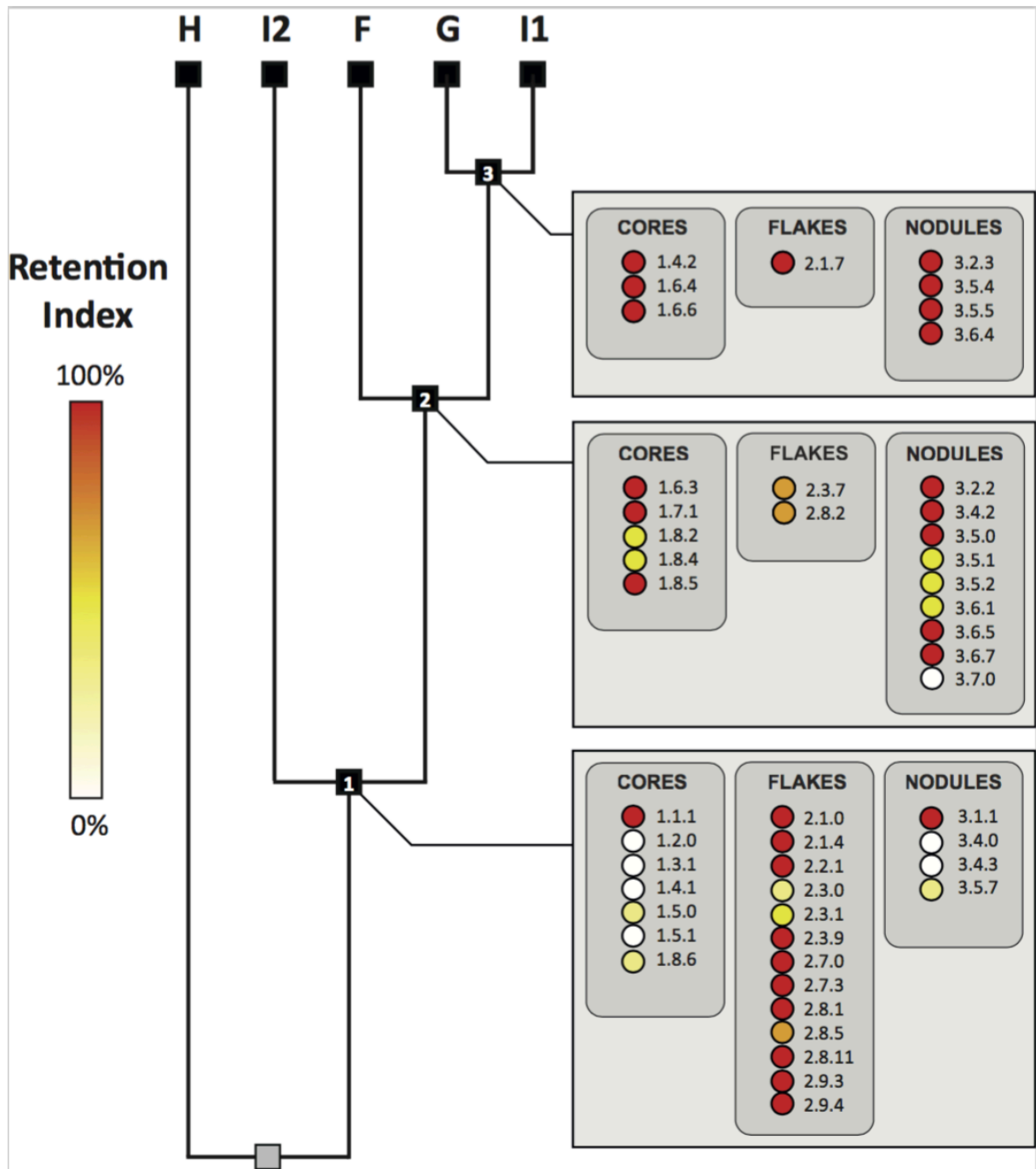

**Fig. 5** Example of decomposition of a tree with repeated leaves following the new algorithm TMS presented herein. **a.** pseudo-character with the leaf k repeated twice in two exclusive nodes. **b, c, d.** resulting subtrees without repeated leaves with maximal number of 3is preserved

## 5. Discussion

### 5.1. Lithic assemblage cladogram

Traditional statistical methods, such as NMDS here or classical technology analysis (Moncel et al., 2020b), are unable to detect significant statistical variations between layers in Notarchirico. The aim of the detection of cladistic relationships is however completely different. As small-scale behavioural changes can generate significant changes in artefact manufacture (Schillinger et al., 2017), the translation to archaeological lithic assemblages, for which multiple factors are involved, points to socially learned behavioural differences that vary between different communities of individuals. The aim of the present analysis was to highlight if a pattern in terms of vertical transmission of innovations on lithic elements could be interpreted. The question of innovation and its transmission is raised throughout the animal kingdom (Galef, 2003; Brown & Laland, 2003; Krützen et al., 2005; Poole et al., 2005) with a particular focus on primates (van Noordwijk et al., 2006; Biro et al., 2003; Whiten et al., 2009). Even in a favorable context of direct observation, functional innovation can be misleading (Hardus et al., 2009) or subject to geographic bias (van Schaik et al., 2003). The issue is more complicated to address in the archaeological record. Several works have attempted to define cultural transmission mechanisms mathematically and model their effect over time (Bentley, 2005; Bentley & Shennan, 2003; Mesoudi & Lycett, 2009). According to Shennan (2020), over time a drift occurs through the loss of variants during transmission, and a contribution through the generation of new variations as a result of innovation according to the effective size of the cultural population. Thus, however elaborate the description of the objects concerned, they may lack information about the history of their transmission. Bettinger and Eerkens (1999) associate an innovation, its adoption and its maintenance, in this case archery, with a particular hunting practice in a given geographical area over several periods that remain short. In doing so, in order to demonstrate the advent of an innovation, they mention the conflict between two ‘good’ typologies. From our point of view as systematists, this work, if it addresses the question of the adoption and maintenance of innovation, puts forward above all the problem mentioned above of not confusing analogy with homology. If the shape of a point, because of resharpening, looks more like a characteristic arrow point but is not one, then there is a risk of unduly inferring a practice, as the authors acknowledge (Bettinger and Eerkens, 1999: 234). For our part, as is the case for all prehistorians whose memorial link between object and object function has not been demonstrated by tracing or a discourse collected by ethnography, we have attempted, independently of the knowledge of functional significance of the objects



**Fig. 6** Cladogram of relationships between layers obtained in 3ia. All character states are displayed on the tree. Due to the testing procedure, all states appear only once. For each character state, the colour depicts its specific retention index. Each code represents type number, character number, and character state number. States are sorted between cores, flakes, and nodules. Only synapomorphies on informative nodes are represented

described to identify whether the pattern of relationship between certain objects could relate a link between layers that would be decoupled or not from their chronological arrangement. However, we are dealing with the evolution of successive layers of the same site, and therefore a priori with verticality in the strict sense of the term. The production of lithic artefacts depends on learned behaviour and therefore on cultural transmission. Production methods have a significant heritability that can be distinguished from the choice of raw materials and re-sharpening (Shennan, 2020). If they are made up of products of social learning, lithic assemblages do not have a composition determined by transmission alone. Site function, adaptation to the site environment, and even taphonomic processes are also involved. Insofar as these situations are repeated, there may be strong similarities between assemblages or, the central tenet of cladistics is that not all similarities are equally useful for

reconstructing cladistic relationships. In doing so, our approach will have captured some features that support the hypothesis of a relationship between these layers from certain points of view.

The cladistic analysis of the five Notarchirico layers produced a single optimal cladogram of relationships between assemblages on the basis of the comparative anatomy of lithic items. The retention index shows congruence in the characters with almost three-quarters of the relationship hypotheses accepted. Moreover, the randomised analysis allows us to conclude in the same way that the cladogram cannot be the result of a random distribution of lithic objects. The cladogram therefore reflects a pattern of vertical cultural transmission. However, we note that this pattern is not consistent with the stratigraphy of Notarchirico (Fig. 2). The present cladistic analysis rejects the hypothesis of transmission from the oldest to the most recent populations. It highlights a more complex and general evolutionary history taking place either on a local scale (diversity of groups and functions of the site), or on a European scale (diversity and penecontemporaneity of evolution and traditions). Indeed, the history of the Notarchirico lithic assemblages cannot be explained in an entirely local way. In particular, more distant localities (for example, La Noira in France) could be closely related to some Notarchirico lithic assemblages analysed in this paper in terms of common knapping rules and bifaces (Moncel et al., 2021; Moncel et al., 2020a).

Thus, the cladogram obtained by three-taxon analysis shows a pattern which must be carefully interpreted while taking into account sampling issues and multiple spatio temporal scales. In the following paragraphs, we describe in detail each of the four informative nodes of the optimal cladogram obtained (Fig. 6) and potential archaeological interpretations.

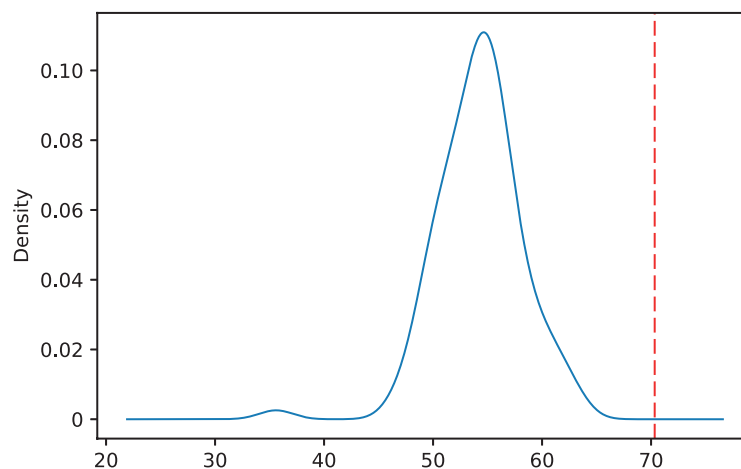

**Fig. 7** Density plot of the retention index of the 100 random analyses. The red dotted bar indicates the retention index of the 3ia analysis presented herein (71%), showing that the optimal cladogram is unlikely to be obtained by chance

### 5.1.1. Node 1

Node 1 groups layers F, G, I1 and I2 with layer H as a sister group. Node 2 is mainly supported by character states on flakes (13 synapomorphies), 10 of which have a retention index of 100%:

- presence of flakes in limestone and grey fine-grained rocks (#2.1.0 and #2.1.4 respectively),
- large flakes (> 20 mm long) (#2.2.1),
- flakes with distal cortical back (#2.3.9),
- cortical striking platforms (#2.7.0),
- dihedral striking platforms, (#2.7.3)
- denticulate retouch (#2.8.1),
- abrupt retouch (#2.8.11),
- peripheral retouch (#2.9.3),
- semi-peripheral retouch (#2.9.4).

Finally, the presence of cores (#1.1.1) and retouched nodules (#3.1.1) are important synapomorphies of node 1 with a RI = 100% for each of them. Cores and retouched nodules are present in layers F, G, I1 and I2, but not in layer H, which only contains flakes. However, when looking at the repartition of all the synapomorphies supporting node 1, those concerning cores and retouched nodules (7 and 4 synapomorphies respectively) are less numerous and have lower retention indices than synapomorphies on flakes.

The first dichotomy of the tree leads to the separation of layer H from the other layers, layer H being drastically different from the other layers due to its lithic material content composed solely of flakes from debitage (i.e., cores). Cores are lacking and small retouched nodules (collected for direct retouch) are very rare. The distribution of synapomorphies on the tree shows that the character states related to flakes support mainly node 1 (13 synapomorphies), compared to the other nodes 2 (2 synapomorphies) and 3 (1 synapomorphy). Thus, flakes



are mainly useful to distinguish layer H from the other levels. Moreover, layer H is the only assemblage which contains only flakes, and its flake assemblage is also less diverse than layers F, G, I1 and I2. A less heterogeneous and less diversified assemblage denotes less investment during possibly short-term occupations and/or specialized occupations. Layer H probably reflects specific and sporadic occupations or areas of activity, perhaps occasional activities near carcasses (remains of Elephantidae and other herbivores associated with flakes in this layer). The features of flakes indicate incomplete and partial reduction sequences, with part of the small flakes remaining unretouched. On retouched flakes, retouch is partial, on an edge or a tip. The composition of layer H might reflect a toolkit deployed during short-term occupation or an action of rare intensity in contrast with the other more heterogeneous layers for longer term and recurrent occupations where a greater diversity of objects is required. This layer is the only one in the whole sequence of the site to yield this type of assemblage, the others yield a combination of cores, flakes and diverse categories of tools (Moncel et al., 2019; Santagata et al., 2020).

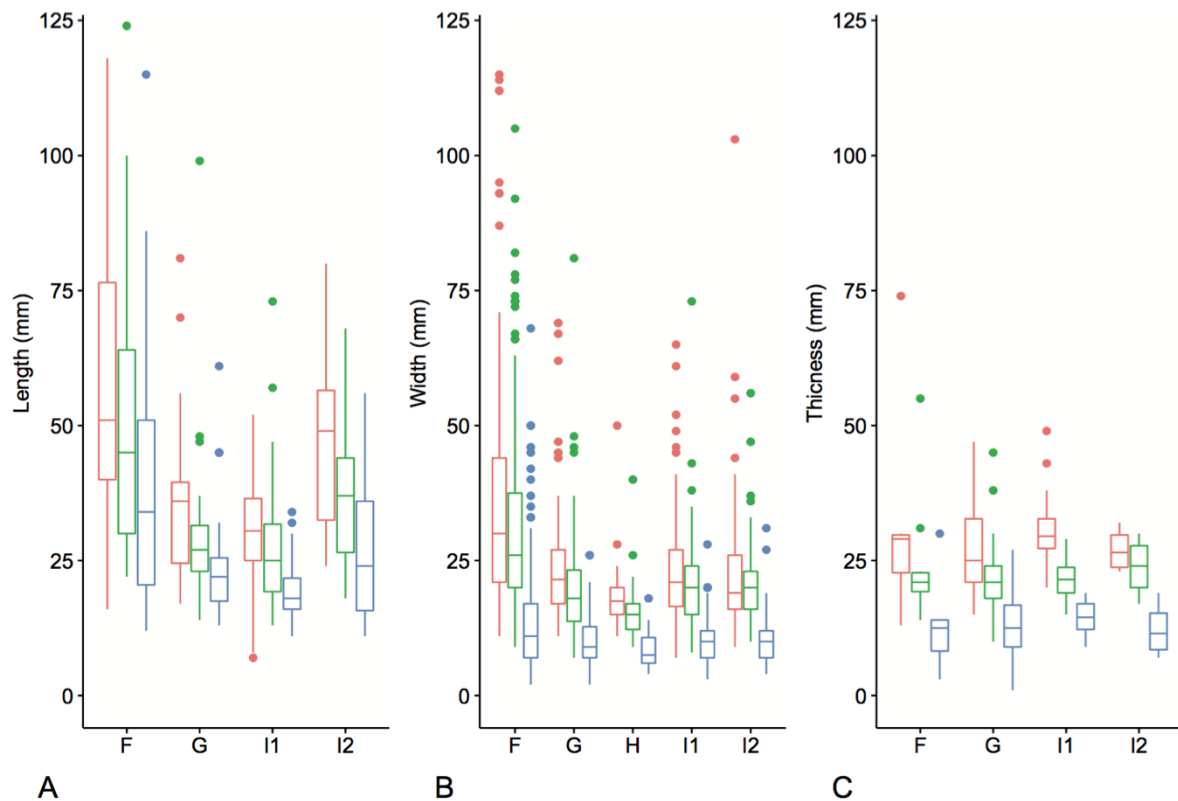

**Fig. 8** Boxplot diagrams of length, width, thickness in cores, flakes, and nodules per layer. **a.** Cores. **b.** Flakes. **c.** Nodules

### 5.1.2. Node 2

Node 2 groups together layers F, G, and I1, with layer I2 as a sister group. In contrast to node 1, node 2 is not mainly supported by character states on flakes (2 synapomorphies), but rather by states on cores (5 synapomorphies, 3 of which have a RI = 100%) and retouched nodules (9 synapomorphies, 5 with RI = 100%). Major synapomorphies, with maximal retention index, are for cores:

- orthogonal/SSDA methods of debitage (#1.6.3),
- centripetal removals (#1.7.1),
- semi-peripheral/bilateral removals (#1.8.5), and for retouched nodules:
- more grey-coloured fine-grained stones (nodular chert) selected for nodules (#3.2.1),
- large cortical patches left on retouched nodules (more than 50% of the surface) (#3.4.2),
- denticulate retouch (#3.5.0),
- bilateral retouch on cutting edges (#3.6.5),
- convergent retouched edges and retouched points (#3.6.7).

I2 discriminates from the others above all by innovations on cores and more productive methods such as orthogonal/SSDA (alternate debitage of two orthogonal surfaces), and cortical backed flakes. Node 2 assemblages are more diversified with evidence of complete and in situ reduction sequences. Both flakes and small nodules are retouched with one or more retouched edges and pointed tools. The diversity of the toolkit is also visible in the

diversity of the retouched types and angles, from sharp edges to abrupt and denticulated retouched edges. Layers F and I2 share both large and small cores, as seen on figure 8, while layers G and I1 yield small cores, which cannot be explained by raw material availability, but rather by human selection and choices which would have generated homoplasy (i.e., homoplasy instances occurs when character states are rejected from the analysis, when they do not fit to the optimal cladogram) in this analysis. Despite the fact that hominins in layer I2 used large cores, they only produced small flakes added to small retouched nodules, suggesting specific behavioural modifications in production size. Moreover, as layer F from the MIS 16 transition is grouped with MIS 17 layers here, a simple environmental interpretation of the cladogram is not possible.

### 5.1.3. Node 3

Node 3 is an apical node (i.e., a node including only leaves), grouping layers G and I1, with layer F as a sister group. The proportion of synapomorphies for this clade is structured in the same way as for node 2 with most synapomorphies concerning cores (3 synapomorphies) and retouched nodules (4 synapomorphies). Node 3 is supported by:

- cores on flakes (#1.4.2),
- pyramidal and bipyramidal cores (discoid-type) (#1.6.4 and #1.6.6 respectively),
- selection of brown coloured fine-grained stones (nodular chert and flysch chert) for retouched nodules (#3.2.3),
- marginal (#3.5.4), oblique (#3.5.5), and semi-peripheral retouch on flakes (#3.6.4),
- presence of red/purple-coloured fine-grained stones (radiolarite) for flakes (#2.1.7).

These two layers also share small flakes and cores while large nodules and pebbles are available. This group indicates more differentiated behaviour with higher debitage productivity (cores on flakes and pyramidal/bipyramidal cores), in addition to perhaps a higher recognition and selection of good-quality stones such as radiolarites, which are however always rare on the site.

To complete the interpretation of the cladogram, we note that the presence of bifaces, which has only been attested in layers G and F (Moncel et al., 2020b), is not consistent with the phylogeny. There is an incongruence between the presence of bifaces linking layer G with layer F, and the characters on lithic assemblages linking layer G with layer I1. In the context of the Notarchirico assemblages, bifaces may have existed in layer I1 but have not been found due to the small size of the excavations or the lack of needs for the occupations.

## 5.2. Character relevance

With only 74 informative characters out of 128 potential characters, almost half of the variations on the analysed lithic objects did not lead to the formulation of character hypotheses on layers stating that several assemblages are more closely related between them than others. Only half of the heterogeneity of lithic objects in Notarchirico is therefore a source of cladistic information at this scale. This high number might be due to the specific nature of lithic assemblages with inherent mass homologies. The high number of items in each layer leads to multiple repetitions which can blur a cladistic pattern. The TMS analysis is thus useful to filter potentially relevant homologies.

We note that most quantitative characters have little relevance for cladistic analysis. More precisely, most quantitative characters are uninformative after applying the TMS algorithm. The low relevance of quantitative characters is mainly due to the difficulty in discretising these characters. Quantitative characters concern the morphology of the lithic objects (width, length and thickness together, because of strong covariation revealed by PCA) and angle removals for all items, and the number of removals and angle platforms specifically for flakes. For each of these binary characters formulated as ((small),(large)), most of the derived states were present in all layers, which made the characters de facto non-informative. Only three character states, the presence of large cores (#2.2.1), large flakes (#2.3.1) and small angle removals (#3.7.0) were informative. However, their unstraightforward discretisation casts doubt on their relevance. For Notarchirico, statistical variations do not seem to be relevant to infer cladistic hypotheses due to discretisation problems, whether the lithic objects or the layers are analysed (Jennings & Waters, 2014). On the contrary, qualitative characters structure the cladogram with the appearance of technological innovations during the evolution of the analysed layers.

## 5.3. Taxic paralogy in cultural analyses

In a cladistic analysis of lithic assemblages, we expect to identify cladistic relationships between different cultural traditions. However, the first dichotomy in the cladogram separating layer H from the other layers, based on their compositions, does not reflect a cladogenesis, but a more complex event distinguishing between sporadic and long-term settlements.

In the same way as a taxon is composed of several parts (e.g., limbs, head, etc.), a cultural tradition is made up of several types of assemblages in keeping with the function of the site and the duration of occupations. Layer H could have recorded short-term and specialised occupations while the other layers could be longer and more diversified domestic occupations, as suggested by in situ reduction sequences and the diversity of assemblages. Thus, the present situation might hide a repetition of terminals (Fig. 9). Layer H possibly belongs

to the same cultural entity as one of the other assemblages, e.g., layers H and F could be two manifestations of the same tradition, one assemblage reflecting sporadic occupations and the other longer and recurrent occupations (Fig. 9c).

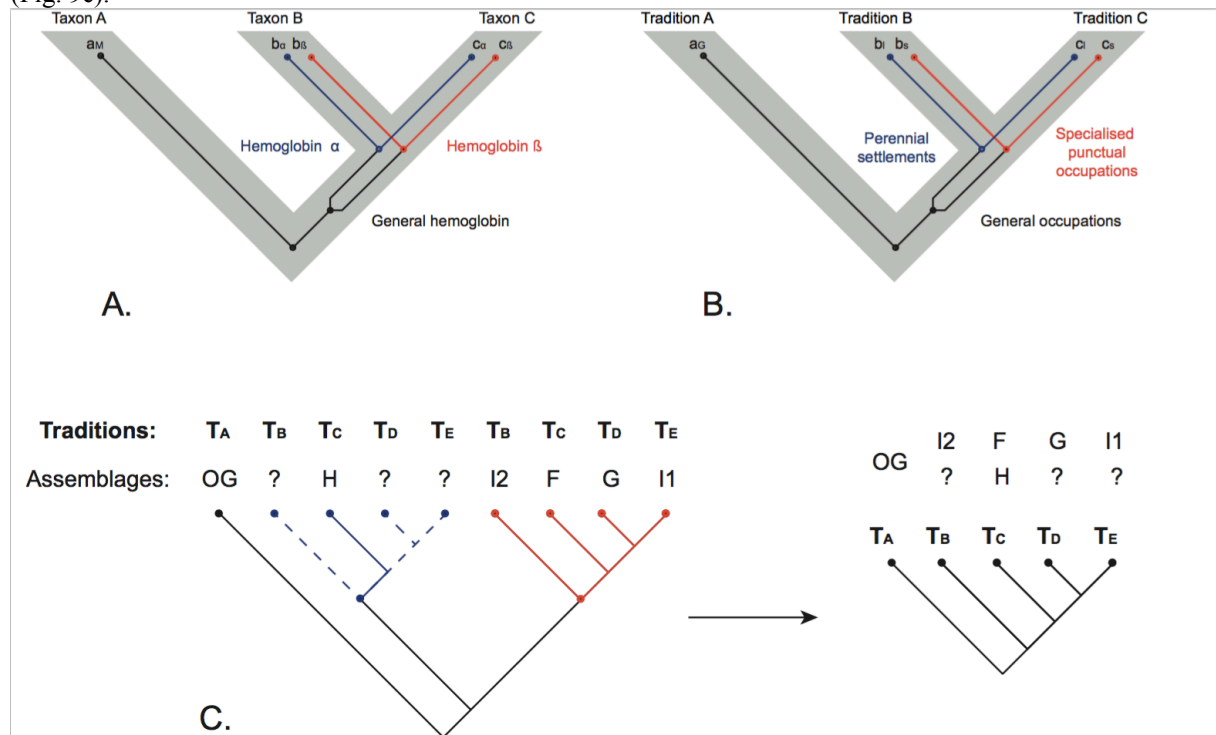

**Fig. 9 a.** Canonical example of paralogy in hemoglobins. The hemoglobin gene is duplicated without speciation and leads to two paralog copies of the hemoglobin,  $\alpha$  and  $\beta$ . **b.** Transposition of the concept of paralogy in archaeological traditions. At some point in the evolution of traditions, the assemblages are differentiated into sporadic specialised occupations and perennial settlements without differentiation of traditions. **c.** Hypothetical exhaustive assemblage tree (left) with missing sporadic assemblages represented with quotation marks, and putative traditions associated with them. The cladogram of traditions (right) is hypothesised from a putative cladogram of assemblages with repetitions due to a paralogy event

We suspect a phenomenon homologous to that of taxic paralogy in our results (Fitch, 1970; Nelson, 1994; Nelson & Ladiges, 1996; Zaragüeta i Bagils et al., 2004). An event of paralogy can be defined as a duplication of parts without duplication of the whole (fig. 9a), and eventually lead to duplications. In molecular phylogenetic analyses, parts are genes and taxa are wholes; here, cores, flakes and nodules are parts, and cultural traditions interpreted from lithic assemblages are wholes. As paralogous copies can be found in genes duplicated in the same taxon without speciation, paralogous copies can be found in assemblages that belong to the same cultural tradition. This phenomenon is found in the same way in morphological characters (Nelson, 1994). In the specific case of lithic assemblages, paralogy events are not as obvious as in genetic paralogy. This is due to difficulties in defining ‘operational cultural units’ that would be equivalent to operational taxonomic units which must be defined prior to cladistic analysis. It can be difficult to gather different sporadic and perennial occupations in the same cultural tradition. Therefore, the present cladogram should be read according to this phenomenon of paralogy which precludes a classical analysis of the cladogram. Adding new assemblages from the upper part of sequence would make it possible to understand the evolution of perennial settlements on the one hand, and the evolution of sporadic occupations on the other, as well as to evaluate the impact of environmental changes and the resulting effects on hominin habits and practices. Finally, we highlight the fact that if it is not possible to define cultural units grouping several kinds of assemblages, separate analyses of each identified kind of assemblage could give interesting results and would allow the comparison of cultural cladistic patterns from several independent records.

## 6. Conclusion

By interpreting the characteristics of lithic assemblages as reflecting the technical abilities and choices of individuals transmitted through social learning, the characteristics reflect a transmission mechanism and are an expression of variation resulting from transmission errors and recombination due to several factors, one of which could be the cognitive ability of a group or taxon. In this way, we approach the points of convergence evoked by Perlès (2016) with respect to American scholars and the latest developments of the French school of prehistory. The approach we have taken is historico-cultural in its aim, and both qualitative and quantitative for the definition

of characters in 3ia in its method. Using cladistics, our approach is hypothetico-deductive and is inspired by the procedures used by the different American schools, but the final results are qualitative and are not intended to be the basis of theorisation. Following the French school of prehistory, they are qualitative results for an empirical answer to a specific question on cultures construed as unique historical entities.

The changes observed over time in the case of Notarchirico suggest that cladistic analysis is indeed capable of detecting a phylogenetic signal, unlike statistical methods. Phylogenetic analysis represents a departure from more traditional approaches for understanding the archaeological record. Phylogenetic analysis emphasizes hereditary continuity/discontinuity in terms of shared homologous relationships and allows for the separation of homologous and analogous traits.

In cladistics, the choice of terminals is related to the scientific question we want to answer. In this study we were not limited to individual classes of objects. Our purpose was to take assemblages as terminals of the analysis, which is a rare but potentially fruitful approach in cultural studies (Buchanan and Collard, 2008, Jennings and Waters, 2014). The main challenge of this approach is to embrace the variation within the assemblage to propose cladistic hypotheses. In this article, we have shown how cladistic theory provides a useful framework for defining what are homologies, characters, terminals, and new procedures for building hierarchical trees of terminals from homologies. Lithic assemblages are equivalents of terminal taxa, and innovations on lithic objects are homologies. Moreover, the concept of paralogy integrated into cladistics also makes it possible to understand the status of assemblages assimilated here to cultural entities. Paralogy arises in Notarchirico assemblages because of insufficient information for the definition of cultural units, with assemblages reflecting both sporadic and perennial settlements that may be part of the same cultural unit. We have also shown that the 3ia method, never used before for cultural analyses, is particularly relevant in the context of cladistic analyses of all kinds of cultural entities, both from a theoretical and methodological point of view. The 3ia method is the only cladistic method adapted to the complete handling of hierarchical characters. In this framework, we proposed a new algorithm for removing repetitions while maximising the initial information. With this algorithm, we constructed characters from lithic innovations in assemblages with an efficient filtering of the innovations that are irrelevant for the construction of hypotheses of degree of relationship between assemblages. The interest of this method for lithic assemblages is even more important in view of the fact that the very large number of repetitions that can be assimilated is close to the concept of mass homology (Patterson, 1982), as with hairs in mammals or cells in metazoans.

The main result of our analysis was to show that while traditional technological analyses could not show significant differences between assemblages, the methods we employed reveal a clear cladistic pattern between assemblages, even if these assemblages may represent a palimpsest of occupations that could obscure certain patterns and influence comparisons. The cladogram obtained highlights a complex history of lithic assemblages, rather than a simple history based solely on chronology or the environment. We show how this pattern is significant in relation to random assemblages. We also demonstrate interesting heterogeneity in the differential distribution of flake, core, and nodule characters between the nodes of the tree. The analysis also confirmed the functional status of one of the layers (temporary butchery workshops) based on archaeozoological data. The other layers are not arranged according to the stratigraphy from the older to the younger assemblages but reflect complex links between the different lithic assemblages. If the climatic environment of the period under consideration is not strongly marked by drastic changes that could explain behavioural evolutions, the nature of the phylogenetic arrangement between the different layers remains difficult to attribute to a biological (e.g., a particular taxonomic attribution) or cultural hypothesis. However, we can put forward the hypothesis that the sequence records common technological behaviours with a progressive differentiation of the basic technology, with or without bifaces in terms of "know how", but above all with contrasting productions: flakes from different production media such as cores, which are associated with flakes, but also with retouched nodules, which are completely independent of them. In the future, new tests of the proposed method will be carried out at different scales (e.g., synchronous lithic assemblages from different geographical localities) to test the hypothesis of cultural paralogy.

### **Acknowledgements**

We thank M. O'Brien and two anonymous reviewers for their comments. The analyses were supported by the ANR Neandroots (ANR-19-CE27-0011-01, 2020-2024), coordinated by M-H. Moncel. Fieldwork at Notarchirico was carried out with the financial and scientific support of the Leakey Foundation ("Early Evidence of Acheulean bifacial technology in Europe" grant, 2015-2016 and 2019-2021) and the National Museum of Natural History, Paris, France (ATM Action Transversale du Muséum, 2016-2018). We thank the Soprintendenza of Basilicata (Italy) for their scientific support, especially Dr. T.E. Cinquantaquattro, Dr. F. Canestrini, Dr. R. Pirraglia, and Dr. S. Mutino. We also thank the Venosa Museum, the city of Venosa and the mayor, and Dr. A. Mantrisi for their assistance for the fieldwork. Finally, we thank Louise Byrne for correcting the English of the manuscript.

## 7. Funding

The analyses were supported by the ANR Neandroots (ANR-19-CE27-0011-01, 2020-2024) coordinated by M-H. Moncel. Fieldwork at Notarchirico was carried out with the financial and scientific support of the Leakey Foundation (“Early Evidence of Acheulean bifacial technology in Europe” grant, 2015-2016 and 2019-2021) and the National Museum of Natural History, Paris, France (ATM Action Transversale du Muséum, 2016-2018).

## 8. Competing interests

The authors have no relevant financial or non-financial interests to disclose.

## 9. References

Andrefsky, W., & Goodale, N. (2015). Lithic technological systems and evolutionary theory. In W. Andrefsky & N. Goodale (Eds.), *Lithic technological systems and evolutionary theory. Interpreting Lithic Technology under the Evolutionary Tent* (pp. 1–26). Cambridge University Press.

Antoine, P., Moncel, M.-H., Voinchet, P., Lochet, J.-L., Amselem, D., Hérison, D., et al., (2019). The earliest evidence of Acheulean occupation in Northwest Europe and the rediscovery of the Moulin Quignon site, Somme valley, France. *Scientific Reports*, 9(13091), 1–12. <https://doi.org/10.1038/s41598-019-49400-w>

Arzarello, M., Marcolini, F., Pavia, G., Pavia, M., Petronio, C., Petrucci, M., et al., (2007). Evidence of earliest human occurrence in Europe: the site of Pirro Nord (Southern Italy). *Naturwissenschaften*, 94 (2), 107–112. <https://doi.org/10.1007/s00114-006-0173-3>

Ascher, R. (1961). Analogy in archaeological interpretation. *Southwestern Journal of Anthropology*, 17 (4), 317–325.

Ben Hamed, M., Darlu, P., & Vallée, N. (2005). On Cladistic Reconstruction of Linguistic Trees through Vowel Data. *Journal of Quantitative Linguistics*, 12 (1), 79– 109. <https://doi.org/10.1080/09296170500055467>

Bentley, R. (2005). Academic copying, archaeology and the English language. *Antiquity*, 80 (307), 196– 201. <https://doi.org/10.1017/S0003598X00093364>

Bentley, R., & Shennan, S. (2003). Cultural transmission and stochastic network growth. *American Antiquity*, 68 (3), 459– 485. <https://doi.org/10.2307/3557104>

Bettinger, R., & Eerkens, J. (1999). Point typologies, social transmission and the introduction of bow and arrow technology in the Great Basin. *American Antiquity*, 64 (2), 231– 242. <https://doi.org/10.2307/2694276>

Binford, L. (1973). Interassemblage variability: the Mousterian and the functional argument. In C. Renfrew (Ed.), *The Exploration of Culture Change* (pp. 227– 254). University of Pittsburgh Press.

Binford, L., & Binford, S. (1966). A preliminary analysis of functional variability in the Mousterian of Levallois facies. *American Anthropologist*, 68 (2), 238– 295.

Biro, D., Inoue-Nakamura, N., Tonooka, R., Yamakoshi, G., Sousa, C., & Matsuzawa, T. (2003). Cultural innovation and transmission of tool use in wild chimpanzees: evidence from field experiments. *Animal Cognition*, 6 (4), 213– 223.

Boëda, E. (1997). *Technogenèse de systèmes de production lithique au Paléolithique inférieur et moyen en Europe occidentale et au Proche-Orient* (Habilitation à diriger des Recherches). Université Paris-Nanterre.

Bordes, F. (1961). Mousterian cultures in France. *Science*, 134 (3482), 803– 810.

Buchanan, B., & Collard, M. (2007). Investigating the peopling of North America through cladistic analyses of Early Paleoindian projectile points. *Journal of Anthropological Archaeology*, 26 (3), 366– 393. <https://doi.org/10.1016/j.jaa.2007.02.005>

Buchanan, B., & Collard, M. (2008). Phenetics, cladistics, and the search for the Alaskan ancestors of the Paleoindians: a reassessment of relationships among the Clovis, Nenana, and Denali archaeological complexes. *Journal of Archaeological Science*, 35 (6), 1683– 1694. <https://doi.org/10.1016/j.jas.2007.11.009>

- Brown, C., & Laland, K. (2003). Social learning in fishes: a review. *Fish and Fisheries* , 4 (3), 280–288. <https://doi.org/10.1046/j.1467-2979.2003.00122.x>
- Bryden, J., Wright, S.P., & Jansen, V.A.A. (2018). How humans transmit language: horizontal transmission matches word frequencies among peers on Twitter. *Journal of the Royal Society Interface* , 15 (39), 20170738. <https://doi.org/10.1098/rsif.2017.0738>
- Cao, N. (2008). Analyse à trois éléments et anatomie du bois des Fagales Engl. (PhD thesis). Muséum national d'histoire naturelle.
- Cao, N., Zaragüeta i Bagils, R., & Vignes-Lebbe, R. (2007). Hierarchical representation of hypotheses of homology. *Geodiversitas* , 29 (1), 5–15.
- Cavalli-Sforza, L., Feldman, M., Chen, K., & Dornbush, S. (1982). Theory and Observation in Cultural Transmission. *Science* , 218 (4567), 19–27.
- Cochrane, E. E., & Lipo, C. P. (2010). Phylogenetic analyses of Lapita decoration do not support branching evolution or regional population structure during colonization of Remote Oceania. *Philosophical Transactions of the Royal Society B: Biological Sciences* , 365 (1559), 3889–3902. <https://doi.org/10.1098/rstb.2010.0091>
- Cochrane, E. E., Rieth, T. M., & Dickinson, W. R. (2013). Plainware ceramics from Sāmoa: Insights into ceramic chronology, cultural transmission, and selection among colonizing populations. *Journal of Anthropological Archaeology* , 32 (4), 499–510. <https://doi.org/10.1016/j.jaa.2013.08.005>
- Collard, M., Shennan, S. J., & Tehrani, J. J. (2006). Branching, blending, and the evolution of cultural similarities and differences among human populations. *Evolution and Human Behavior* , 27 (3), 169–184. <https://doi.org/10.1016/j.evolhumbehav.2005.07.003>
- Colless, D. H. (1985). On “Character” and related terms. *Systematic Zoology* , 34 , 229–233.
- Crassard, R., Charpentier, V., McCorriston, J., Vosges, J., Bouzid, S., & Petraglia, M. (2020). Fluted-point technology in Neolithic Arabia: An independent invention far from the Americas. *PLoS one* , 15 (8), e0236314. <https://doi.org/10.1371/journal.pone.0236314>
- De Laet, J., & Smets, E. (1998). On the three-taxon approach to parsimony analysis. *Cladistics* , 14 (4), 363–381.
- De Voogt, A., Dunn-Vaturi, A.-E., & Eerkens, J. W. (2013). Cultural transmission in the ancient Near East: twenty squares and fifty-eight holes. *Journal of Archaeological Science* , 40 (4), 1715–1730. <https://doi.org/10.1016/j.jas.2012.11.008>
- Delagnes, A., & Roche, H. (2005). Late Pliocene hominid knapping skills: The case of Lokalalei 2C, West Turkana, Kenya. *Journal of Human Evolution* , 48 (5), 435–472. <https://doi.org/10.1016/j.jhevol.2004.12.005>
- Despriée, J., Courcimault, G., Moncel, M.-H., Voinchet, P., Tissoux, H., Puaud, S., et al., (2016). The Acheulean site of la Noira (Centre region, France): Characterization of materials and alterations, choice of lacustrine millstone and evidence of anthropogenic behaviour. *Quaternary International* , 411 , 144–159. <https://doi.org/10.1016/j.quaint.2015.12.101>
- Dunnell, R. (1971). *Systematics in Prehistory* . Free Press.
- Dunnell, R. C. (1978). Style and Function: A Fundamental Dichotomy. *American Antiquity* , 43 (2), 192–202. <https://doi.org/10.2307/279244>
- Dunnell, R. (1980). Evolutionary theory and archaeology. In M.B. Schiffer (Ed.), *Advances in Archaeological Method and Theory* (vol. 3, pp. 35–99). New York, Academic press.
- Farris, J. S. (1970). Methods for Computing Wagner Trees. *Systematic Zoology* , 19 (1), 83–92. <https://doi.org/10.2307/2412028>

- Farris, J. S. (1977). Phylogenetic Analysis Under Dollo's Law. *Systematic Zoology* , 26 (1), 77. <https://doi.org/10.2307/2412867>
- Farris, J. S. (1983). The logical basis of phylogenetic analysis. *Advances in cladistics* , 2 , 7– 36.
- Faure-Brac, M. G., Rineau, V., & Bagils, R. Z. (2020). Rethinking Pleijel's (1995) characters under a hierarchical point of view. *BioRxiv* . Preprint. <https://doi.org/10.1101/2020.10.19.345330>
- Fitch, W. M. (1970). Distinguishing homologous from analogous proteins. *Systematic Zoology* , 19 (2), 99– 113.
- Fitch, W. M. (1971). Toward Defining the Course of Evolution: Minimum Change for a Specific Tree Topology. *Systematic Biology* , 20 (4), 406– 416. <https://doi.org/10.1093/sysbio/20.4.406>
- Foley, R. (1987). Hominid species and stone-tool assemblages: how are they related? *Antiquity* , 61 (233), 380– 392. <https://doi.org/10.1017/S0003598X00072938>
- Foley, R., & Lahr, M. M. (2003). On stony ground: Lithic technology, human evolution, and the emergence of culture. *Evolutionary Anthropology: Issues, News, and Reviews* , 12 (3), 109– 122. <https://doi.org/10.1002/evan.10108>
- Galef, B., (2003). Social learning: promoter or inhibitor of innovation. In S. M. Reader, K. N. Laland (Eds.), *Animal Innovation* (pp. 137– 152). Oxford University Press. <https://doi.org/10.1093/acprof:oso/9780198526223.003.0006>
- Gallotti, R., & Peretto, C. (2015). The Lower/early Middle Pleistocene small débitage productions in Western Europe: New data from Isernia La Pineta t.3c (Upper Volturno Basin, Italy). *Quaternary International* , 357 , 264– 281. <https://doi.org/10.1016/j.quaint.2014.06.055>
- Gould, R., & Watson, P. (1982). A dialogue on the meaning and use of analogy in ethnoarchaeological reasoning. *Journal of Anthropological Archaeology* , 1 (4), 355– 381.
- Gray, R. D., & Atkinson, Q. D. (2003). Language-tree divergence times support the Anatolian theory of Indo-European origin. *Nature* , 426 (6965), 435– 439. <https://doi.org/10.1038/nature02029>
- Gray, R. D., & Jordan, F. M. (2000). Language trees support the express-train sequence of Austronesian expansion. *Nature* , 405 (6790), 1052– 1055. <https://doi.org/10.1038/35016575>
- Hardus, M., Lameira, A., van Schaik, C., & Wich, S. (2009). Tool use in wild orang-utans modifies sound production: a functionally deceptive innovation? *Proceeding of the Royal Society B* , 276 (1673), 3689– 3694. <https://doi.org/10.1098/rspb.2009.1027>
- Hennig, W. (1965). Phylogenetic systematics. *Annual Review of Entomology* , 10 (1), 97– 116.
- Hennig, W. (1966). *Phylogenetic Systematics* . University of Illinois Press.
- Heyes, C. (1994). Social learning in animals: categories and mechanisms. *Biological Review* , 69(2), 207– 231.
- Holden, C. J. (2002). Bantu language trees reflect the spread of farming across sub-Saharan Africa: a maximum parsimony analysis. *Proceedings of the Royal Society of London. Series B: Biological Sciences* , 269 (1493), 793– 799. <https://doi.org/10.1098/rspb.2002.1955>
- Jenks, G. F. (1967). The Data Model Concept in Statistical Mapping. *International Yearbook of Cartography* , 7 , 186– 190.
- Jennings, T. A., & Waters, M. R. (2014). Pre-Clovis Lithic Technology at the Debra L. Friedkin Site, Texas: Comparisons to Clovis through Site-Level Behavior, Technological Trait-List, and Cladistic Analyses. *American Antiquity* , 79 (1), 25– 44. <https://doi.org/10.7183/0002-7316.79.1.25>
- Jordan, P., & O'Neill, S. (2010). Untangling cultural inheritance: language diversity and long-house architecture

- on the Pacific northwest coast. *Philosophical Transactions of the Royal Society B: Biological Sciences* , 365 (1559), 3875– 3888. <https://doi.org/10.1098/rstb.2010.0092>
- Jordan, P., & Shennan, S. (2003). Cultural transmission, language, and basketry traditions amongst the California Indians. *Journal of Anthropological Archaeology* , 22 (1), 42– 74. [https://doi.org/10.1016/S0278-4165\(03\)00004-7](https://doi.org/10.1016/S0278-4165(03)00004-7)
- Kitching, I. J., Forey, P. L., Humphries, C. J., & Williams, D. (1998). *Cladistics: the theory and practice of parsimony analysis* (2nd ed.). Oxford University Press.
- Kluge, A. G., & Farris, J. S. (1969). Quantitative Phyletics and the Evolution of Anurans. *Systematic Zoology* , 18 (1), 1– 32. <https://doi.org/10.2307/2412407>
- Krützen, M., Mann, J., Heithaus, M., Connor, R., Bejder, L., & Sherwin, W. (2005). Cultural transmission of tool use in the bottlenose dolphins. *Proceedings of the National Academy of Science* , 102 (), 8939– 8943.
- Laland, K. (2004). Social learning strategies. *Learning and Behavior*, 32 (1), 4– 14.
- Le Bomin, S., Lecoindre, G., & Heyer, E. (2016). The Evolution of Musical Diversity: The Key Role of Vertical Transmission. *PLOS ONE* , 11 (3), 1– 17. <https://doi.org/10.1371/journal.pone.0151570>
- Leroi-Gourhan, A. (1964). *Le geste et la parole. Technique et langage* . Albin Michel.
- Longacre, W. (1970) Current thinking in American archaeology. *American Anthropological Association Bulletin* 3 (3), 126– 138.
- Lycett, S. J. (2007). Why is there a lack of Mode 3 Levallois technologies in East Asia? A phylogenetic test of the Movius– Schick hypothesis. *Journal of Anthropological Archaeology* , 26 (4), 541– 575. <https://doi.org/10.1016/j.jaa.2007.07.003>
- Lycett, S. J. (2009). Are Victoria West cores “proto -Levallois”? A phylogenetic assessment. *Journal of Human Evolution* , 56 (2), 175– 191. <https://doi.org/10.1016/j.jhevol.2008.10.001>
- Lycett, S. J. (2015). Cultural evolutionary approaches to artifact variation over time and space: basis, progress, and prospects. *Journal of Archaeological Science* , 56 , 21– 31. <https://doi.org/10.1016/j.jas.2015.01.004>
- Lycett, S. J., Collard, M., & McGrew, W. C. (2009). Cladistic analyses of behavioural variation in wild Pan troglodytes : exploring the chimpanzee culture hypothesis. *Journal of Human Evolution* , 57 (4), 337– 349. <https://doi.org/10.1016/j.jhevol.2009.05.015>
- Lyman, R. L., & O’Brien, M. J. (1997). The Concept of Evolution in Early Twentieth-Century Americanist Archaeology. *Archeological Papers of the American Anthropological Association*, 7(1), 21 –48. <https://doi.org/10.1525/ap3a.1997.7.1.21>
- Lyman, R. L., & O’Brien, M. J. (1998). The Goals of Evolutionary Archaeology: History and Explanation. *Current Anthropology*, 39(5), 615 –652. <https://doi.org/10.1086/204786>
- McBrearty, S. (2003). Patterns of technological change at the origin of Homo sapiens. *Before Farming*, 3(9), 1-5.
- MacQueen, J. B. (1967). Some Methods for classification and Analysis of Multivariate Observations. *Proceedings of 5th Berkeley Symposium on Mathematical Statistics and Probability*, 1, 281 –297.
- MacWhite, E. (1956). On the Interpretation of Archeological Evidence in Historical and Sociological Terms 1. *American Anthropologist*, 58(1), 3-25.
- Manem, S. (2020). Modeling the Evolution of Ceramic Traditions Through a Phylogenetic Analysis of the Chaînes Opératoires: the European Bronze Age as a Case Study. *Journal of Archaeological Method and Theory*, 27(4), 1 –48.
- Marshall-Pescini, S., & Whiten, A. (2008). Chimpanzees (Pan troglodytes ) and the question of cumulative culture: an experimental approach. *Animal cognition* , 11 (3), 449-456. <https://doi.org/10.1007/s10071-007-0135-y>



- Marwick, B. (2012). A Cladistic Evaluation of Ancient Thai Bronze Buddha Images: Six Tests for a Phylogenetic Signal in the Griswold Collection. In M. L. Tjoa-Bonatz, A. Reinecke, & D. Bonatz (Eds.), *Connecting Empires and States: Selected Papers from the 13th International Conference of the European Association of Southeast Asian Archaeologists* (pp. 159–176). NUS Press. <https://doi.org/10.2307/j.ctv1ntg9b>
- Mauss, M. (1947). *Manuel d'ethnographie*. Payot.
- Mecozzi, B., Iannucci, A., Sardella, R., Curci, A., Daujeard, C., & Moncel, M.-H. (2021). Not only cranial remains: the ulna of Barbary macaque from the Middle Pleistocene site of Notarchirico (Venosa, southern Italy). *Journal of Human Evolution*, 153, 1–7.
- Meltzer, D. J. (1981). A Study of Style and Function in a Class of Tools. *Journal of Field Archaeology*, 8 (3), 313–326.
- Mesoudi, A. (2016). Cultural Evolution: A Review of Theory, Findings and Controversies. *Evolutionary Biology*, 43 (4), 481–497. <https://doi.org/10.1007/s11692-015-9320-0>
- Mesoudi, A., & Lycett, S. J. (2009). Random copying, frequency-dependent copying and culture change. *Evolution and Human Behavior*, 30 (1), 41–48. <https://doi.org/10.1016/j.evolhumbehav.2008.07.005>
- Moncel M.-H., Arzarello, M., Boëda, E., Bonilauri, S., Chevrier, B., Gaillard, C., Forestier, H., Yinghua, L., Sémah, F., & Zeitoun, V. (2018). The assemblages with bifacial tools in Eurasia. What is going on at the East? Data on India, Eastern Asia and South-East Asia. *Comptes rendus Palevol*, 17, 61–76.
- Moncel, M.-H., Chacón, M. G., Vettese, D., Courty, M.-A., Daujeard, C., Eixea, A., et al., (2021). Late Neanderthal short-term and specialized occupations at the Abri du Maras (South-East France, level 4.1, MIS 3). *Archaeological and Anthropological Sciences*, 13 (3), 1–28. <https://doi.org/10.1007/s12520-021-01285-5>
- Moncel, M.-H., Despriée, J., Courcimaut, G., Voinchet, P., & Bahain, J.-J. (2020a). La Noira site (Centre, France) and the technological behaviours and skills of the earliest Acheulean in Western Europe between 700 and 600 kyrs. *Journal of Paleolithic Archeology*, 3 (3), 255–301.
- Moncel, M.-H., Santagata, C., Pereira, A., Nomade, S., Bahain, J.-J., Voinchet, P., & Piperno, M. (2019). Biface production at Notarchirico (Southern Italy) before 600 ka? Contribution to the earliest evidence of the European Acheuleans. *PLOS ONE*, 14 (9), 1–32.
- Moncel, M.-H., Santagata, C., Pereira, A., Nomade, S., Voinchet, P., Bahain, J.-J., et al., (2020b). The origin of early Acheulean expansion in Europe 700 ka ago: new findings at Notarchirico (Italy). *Scientific Reports*, 10 (1), 1–16. <https://doi.org/10.1038/s41598-020-68617-8>
- Moya, C., Boyd, R., & Henrich, J. (2015). Reasoning about cultural and genetic transmission: Developmental and cross-cultural evidence From Peru, Fiji, and the United States on how people make inferences about trait transmission. *Topics in cognitive science*, 7 (4), 595–610. <https://doi.org/10.1111/tops.12163>
- Neiman, F. D. (1995). Stylistic Variation in Evolutionary Perspective: Inferences from Decorative Diversity and Interassemblage Distance in Illinois Woodland Ceramic Assemblages. *American Antiquity*, 60 (1), 7–36. <https://doi.org/10.2307/282074>
- Nelson, G. (1994). Homology and systematics. In B. K. Hall (Ed.), *Homology: The Hierarchical Basis of Comparative Biology* (pp. 101–149). Academic Press.
- Nelson, G. (1996). *Nullius in Verba*. Self-published.
- Nelson, G. J., & Ladiges, P. Y. (1996). Paralogy in cladistic biogeography and analysis of paralogy-free subtrees. *American Museum novitates*, 3167, 1–58.
- Nelson, G., & Platnick, N. (1981). *Systematics and Biogeography: Cladistics and Vicariance*. Columbia University Press.

- Nelson, G., & Platnick, N. (1991). Three-Taxon Statements: A More Precise Use of Parsimony? *Cladistics*, 7 (4), 351– 366.
- Nelson, G., Williams, D. M., & Ebach, M. C. (2003). A question of conflict: Three- item and standard parsimony compared. *Systematics and Biodiversity*, 1 (2), 145– 149. <https://doi.org/10.1017/S1477200003001130>
- O'Brien, M. J., & Bentley, R. A. (2020). Learning strategies and population dynamics during the Pleistocene colonization of North America. In *Culture History and Convergent Evolution* (pp. 261-281). Springer, Cham. [https://doi.org/10.1007/978-3-030-46126-3\\_13](https://doi.org/10.1007/978-3-030-46126-3_13)
- O'Brien, M. J., Boulanger, M. T., Buchanan, B., Collard, M., Lee Lyman, R., & Darwent, J. (2014). Innovation and cultural transmission in the American Paleolithic: Phylogenetic analysis of eastern Paleoindian projectile-point classes. *Journal of Anthropological Archaeology*, 34, 100– 119. <https://doi.org/10.1016/j.jaa.2014.03.001>
- O'Brien, M. J., Buchanan, B., Collard, M., & Boulanger, M. T. (2012). Cultural Cladistics and the Early Prehistory of North America. In P. Pontarotti (Ed.), *Evolutionary Biology: Mechanisms and Trends* (pp. 23– 42). Springer Berlin Heidelberg. [https://doi.org/10.1007/978-3-642-30425-5\\_2](https://doi.org/10.1007/978-3-642-30425-5_2)
- O'Brien, M. J., Buchanan, B., Eren, M. (2018). Issues in Archaeology studies of convergence. In M. O'Brien, B. Buchanan, M. Eren (Eds.), *Convergent evolution in stone-tools technology* (p. 3 –21). The MIT Press Cambridge.
- O'Brien, M. J., & Lyman, R. L. (2000). *Applying evolutionary archaeology: a systematic approach*. Kluwer Academic.
- O'Brien, M. J., & Lyman, R. L. (2003). *Cladistics and archaeology*. University of Utah Press.
- O'Brien, M. J., Darwent, J., & Lyman, R. L. (2001). Cladistics Is Useful for Reconstructing Archaeological Phylogenies: Palaeoindian Points from the Southeastern United States. *Journal of Archaeological Science*, 28(10), 1115 –1136. <https://doi.org/10.1006/jasc.2001.0681>
- Nielsen, M., Subiaul, F., Galef, B., Zentall, T., & Whiten, A. (2012). Social learning in humans and nonhuman animals: theoretical and empirical dissections. *Journal of Comparative Psychology*, 126(2), 109. <https://doi.org/10.1037/a0027758>
- van Noordwijk, M. A., van Schaik, C. P., & Wich, S. A. (2006). Innovation in wild Bornean orangutans (*Pongo pygmaeus wurmbii*). *Behaviour*, 143 (7), 839-876.
- Otte, M. (2003). The pitfalls of using bifaces as cultural markers. In M. Soressi, & H. L. Dibble (Eds.), *Multiple approaches to the study of bifacial technologies* (pp. 183– 192). University of Pennsylvania Museum of Archaeology and Anthropology.
- Pagel, M., Atkinson, Q. D., & Meade, A. (2007). Frequency of word-use predicts rates of lexical evolution throughout Indo-European history. *Nature*, 449 (7163), 717– 720. <https://doi.org/10.1038/nature06176>
- Patterson, C. (1982). Morphological characters and homology. In K. A. Joysey & E. Friday (Eds.), *Problems of Phylogenetic Reconstruction* (Vol. 21, pp. 21– 74). Academic Press.
- Pereira, A., Nomade, S., Voinchet, P., Bahain, J. J., Falguères, C., Garon, H., et al., (2015). The earliest securely dated hominin fossil in Italy and evidence of Acheulian occupation during glacial MIS 16 at Notarchirico (Venosa, Basilicata, Italy): Earliest Acheulian Occupation of Italy. *Journal of Quaternary Science*, 30 (7), 639– 650. <https://doi.org/10.1002/jqs.2809>
- Perlès, C. (2016). La technologie lithique, de part et d'autre de l'Atlantique. *Bulletin de la Société préhistorique française*, 113 (2), 221-240.
- Pimentel, R. A., & Riggins, R. (1987). The Nature of Cladistic Data. *Cladistics*, 3 (3), 201– 209. <https://doi.org/10.1111/j.1096-0031.1987.tb00508.x>

- Pinna, M. C. de (1991). Concepts and tests of homology in the cladistic paradigm. *Cladistics* , 7 (4), 367– 394.
- Piperno, M. (1999). Notarchirico. Un sito del Pleistocene medio iniziale nel bacino di Venosa . Edizioni Osanna.
- Platnick, N., & Nelson, G. (1978). A Method of Analysis for Historical Biogeography. *Systematic Zoology* , 27 (1), 1– 16. <https://doi.org/10.2307/2412808>
- Pogue, M. G., & Mickevich, M. F. (1990). Character definitions and character state delineation: the bête noire of phylogenetic inference. *Cladistics* , 6 (4), 319– 361.
- Poole, J. H., Tyack, P. L., Stoeger-Horwath, A. S., & Watwood, S. (2005). Elephants are capable of vocal learning. *Nature* , 434 (7032), 455-456. <https://doi.org/10.1038/434455a>
- Prin, S. (2012). Structure mathématique des hypothèses cladistiques et conséquences pour la phylogénie et l'évolution. Avec une perspective sur l'analyse cladistique (PhD thesis). Muséum national d'histoire naturelle.
- Ram, Y., Liberman, U., & Feldman, M. W. (2018). Evolution of vertical and oblique transmission under fluctuating selection. *Proceedings of the National Academy of Sciences* , 115 (6), E1174-E1183. <https://doi.org/10.1073/pnas.1719171115>
- Rexová, K., Frynta, D., & Zrzavý, J. (2003). Cladistic analysis of languages: Indo-European classification based on lexicostatistical data. *Cladistics* , 19 (2), 120– 127. <https://doi.org/10.1111/j.1096-0031.2003.tb00299.x>
- Rineau, V. (2017). Un nouveau regard cladistique sur l'anatomie comparée, la phylogénie, la systématique et la paléocologie des rudistes (Bivalvia, Hippuritida) (PhD thesis). Université Pierre et Marie Curie.
- Rineau, V., Grand, A., Zaragüeta i Bagils, R., & Laurin, M. (2015). Experimental systematics: sensitivity of cladistic methods to polarization and character ordering schemes. *Contributions to Zoology* , 84 (2), 129– 148.
- Rineau, V., Zaragüeta i Bagils, R., & Bardin, J. (2021). Information content of trees: three-taxon statements, inference rules and dependency. *Biological Journal of the Linnean Society* , 133(4), 1152– 1170.
- Rineau, V., Zaragüeta i Bagils, R. Z. I., & Laurin, M. (2018). Impact of errors on cladistic inference: simulationbased comparison between parsimony and three-taxon analysis. *Contributions to Zoology* , 87 (1), 25– 40.
- Rousseeuw, P. J. (1987). Silhouettes: a Graphical Aid to the Interpretation and Validation of Cluster Analysis. *Computational and Applied Mathematics* . 20, 53– 65.
- Sabloff, J. A., Beale, T. W., & Kurland Jr, A. M. (1973). Recent developments in archaeology. *The Annals of the American Academy of Political and Social Science* , 408 (1), 103-118.
- Santagata, C., Moncel, M.-H., & Piperno, M. (2020). Bifaces or not bifaces? Role of raw materials in the Middle Pleistocene. The example of levels E-E1, B and F (610– 670 ka) at Notarchirico (Italy). *Journal of Archaeological Science: Reports* , 33 (102544), 1– 19. <https://doi.org/10.1016/j.jasrep.2020.102544>
- Santoro, F. R., Chaves, L. S., & Albuquerque, U. P. (2020). Evolutionary aspects that guide the cultural transmission pathways in a local medical system in Northeast Brazil. *Heliyon* , 6 (6), e04109. <https://doi.org/10.1016/j.heliyon.2020.e04109>
- van Schaik, C. P. (2010). Social learning and culture in animals. In P. Kappeler (Ed.), *Animal behaviour: Evolution and mechanisms* (pp. 623-653). Springer, Berlin, Heidelberg.
- Van Schaik, C. P., Ancrenaz, M., Borgen, G., Galdikas, B., Knott, C. D., Singleton, I., ... & Merrill, M. (2003). Orangutan cultures and the evolution of material culture. *Science* , 299 (5603), 102-105. <https://doi.org/10.1126/science.1078004>
- Schillinger, K., Mesoudi, A., & Lycett, S. J. (2017). Differences in Manufacturing Traditions and Assemblage-

Level Patterns: the Origins of Cultural Differences in Archaeological Data. *Journal of Archaeological Method and Theory* , 24 (2), 640– 658. <https://doi.org/10.1007/s10816-016-9280-4>

Schmidt, P. (2020). Culture, environmental adaptation or specific problem solving? On convergence and innovation dynamics related to techniques used for stone heat treatment. In H. Groucutt (Ed.), *Culture History and Convergent Evolution* (pp. 283-290). Springer, Cham.

Shennan, S. (2002). *Genes, memes and human history. Darwinian archaeology and cultural evolution.* Thames & Hudson.

Shennan, S. (2008). Evolution in Archaeology. *Annual Review of Anthropology* , 37 (1), 75– 91. <https://doi.org/10.1146/annurev.anthro.37.081407.08515>

Shennan, S. (2011). Descent with modification and the archaeological record. *Philosophical Transactions of the Royal Society B: Biological Sciences* , 366 (1567), 1070– 1079. <https://doi.org/10.1098/rstb.2010.0380>

Shennan, S. (2020). Style, function and cultural transmission. In H. Groucutt (Ed.), *Culture history and convergent evolution* (pp. 291– 298). Springer, Cham.

Siebert, D. J., & Williams, D. M. (1998). Recycled. *Cladistics* , 14 (4), 339– 347.

Slotkin, J. S. (1952). Some basic methodological problems in prehistory. *Southwestern Journal of Anthropology* , 8 (4), 442-443.

Straffon, L. M. (2016). The Applications and Challenges of Cultural Phylogenetics in Archaeology: An Introduction. In L. Mendoza Straffon (Ed.), *Cultural Phylogenetics* (Vol. 4, pp. 1– 15). Cham: Springer International Publishing. [https://doi.org/10.1007/978-3-319-25928-4\\_1](https://doi.org/10.1007/978-3-319-25928-4_1)

Tehrani, J. (2013). The Phylogeny of Little Red Riding Hood. *PLoS ONE* , 8 (11), 1– 11. <https://doi.org/10.1371/journal.pone.0078871>

Tehrani, J., & Collard, M. (2002). Investigating cultural evolution through biological phylogenetic analyses of Turkmen textiles. *Journal of Anthropological Archaeology* , 21 (4), 443– 463. [https://doi.org/10.1016/S0278-4165\(02\)00002-8](https://doi.org/10.1016/S0278-4165(02)00002-8)

Ung, V., Zaragüeta i Bagils, R., & Williams, D. M. (2016). Comparative biogeography of Southeast Asia and the West Pacific region. *Biological Journal of the Linnean Society* , 117 (2), 372– 385. <https://doi.org/10.1111/bij.12670>

Vallverdú, J., Saladié, P., Rosas, A., Huguet, R., Cáceres, I., Mosquera, M., et al., (2014). Age and Date for Early Arrival of the Acheulian in Europe (Barranc de la Boella, la Canonja, Spain). *PLoS ONE* , 9 (7), 1– 15. <https://doi.org/10.1371/journal.pone.0103634>

Wiley, G. R. (1953). *Archaeological theories and interpretation: New World.* Anthropology Today, University of Chicago Press, Chicago , 361-385.

Williams, D., & Ebach, M. C. (2006). The data matrix. *Geodiversitas* , 28 (3), 409– 420. Whiten, A., Horner, V., & de Waal, F. (2005). Conformity to cultural norms of tool use in chimpanzees. *Nature* , 437 (7059), 737-740. <https://doi.org/10.1038/nature04047>

Wylie, A. (1985). The reaction against analogy. In *Advances in archaeological method and theory* (pp. 63-111). Academic Press.

Zaragüeta i Bagils, R. (2011). Ancêtres. In V. Malécot, N. Léger, & P. Tassy (Eds.), *Biosystema 28, L'arbre du vivant existe-il?* (pp. 41– 62). Editions Matériologiques.

Zaragüeta i Bagils, R., & Bourdon, E. (2007). Three-item analysis: Hierarchical representation and treatment of missing and inapplicable data. *Comptes Rendus Palevol* , 6 (6– 7), 527– 534. <https://doi.org/10.1016/j.crpv.2007.09.013>

Zaragüeta i Bagils, R., Lelièvre, H., & Tassy, P. (2004). Temporal paralogy, cladograms, and the quality of the fossil record. *Geodiversitas* , 26 (3), 381– 389.

Zaragüeta i Bagils, R., & Pécaud, S. (2016). Why should cladograms be dichotomous? In D. Williams, M. Schmitt, & Q. Wheeler (Eds.), *The Future of Phylogenetic Systematics: The Legacy of Willi Hennig* (pp. 230–257). Cambridge.

Zaragüeta i Bagils, R., Ung, V., Grand, A., Vignes-Lebbe, R., Cao, N., & Ducasse, J. (2012). LisBeth: New cladistics for phylogenetics and biogeography. *Comptes Rendus Palevol*, 11 (8), 563–566.  
<https://doi.org/10.1016/j.crpv.2012.07.002>

**Supplementary Information.**

Online Resource 1. List, codes and coding of hierarchical homology hypotheses on lithic objects.

Online Resource 2. Hierarchical matrix on flakes.

Online Resource 3. Hierarchical matrix on cores.

Online Resource 4. Hierarchical matrix on nodules.

Online Resource 5. Table showing homologies with and without repetition removal, deduced characters, retention index and codes.

Online Resource 6. Correspondence table between lithic objects and layers.

Online Resource 7. 3ia file for computing the cladistic analysis of layers on Lisbeth 1.0.

**Journal of Archaeological Method and Theory**

<https://doi.org/10.1007/s10816-022-09558-6>