



HAL
open science

Hybrid Ageing Model of a Proton Exchange Membrane Fuel Cell (PEMFC)

Abdelkadder Detti, Nadia Yousfi-Steiner, Laurent Bouillaut, Allou Same,
Samir Jemei

► **To cite this version:**

Abdelkadder Detti, Nadia Yousfi-Steiner, Laurent Bouillaut, Allou Same, Samir Jemei. Hybrid Ageing Model of a Proton Exchange Membrane Fuel Cell (PEMFC). *International Journal of Energy and Power Engineering*, 2022, 11 (1), pp.17-29. 10.11648/j.ijepe.20221101.12 . hal-03741280

HAL Id: hal-03741280

<https://hal.science/hal-03741280>

Submitted on 30 Sep 2022

HAL is a multi-disciplinary open access archive for the deposit and dissemination of scientific research documents, whether they are published or not. The documents may come from teaching and research institutions in France or abroad, or from public or private research centers.

L'archive ouverte pluridisciplinaire **HAL**, est destinée au dépôt et à la diffusion de documents scientifiques de niveau recherche, publiés ou non, émanant des établissements d'enseignement et de recherche français ou étrangers, des laboratoires publics ou privés.

Hybrid Ageing Model of a Proton Exchange Membrane Fuel Cell (PEMFC)

Abdelkader Detti^{1,2}, Nadia Yousfi Steiner^{1,2}, Laurent Bouillaut^{3,*}, Allou Badara Samé³, Samir Jemei^{1,2}

¹Frache-Comté Electronics Mechanics Thermal Science and Optics – Sciences and Technologies, University of Bourgogne Franche-Comte, Belfort, France

²Fuel Cell Laboratory, University of Bourgogne Franche-Comte, Belfort, France

³Engineering of Surface Transportation Networks and Advanced Computing Laboratory, University Gustave Eiffel, Marne-la-Vallée, France

Email address:

haidar.detti@gmail.com (A. Detti), nadia.steiner@femto-st.fr (N. Y. Steiner), laurent.bouillaut@univ-eiffel.fr (L. Bouillaut), allou.same@univ-eiffel.fr (A. B. Samé), samir.jemei@femto-st.fr (S. Jemei)

*Corresponding author

To cite this article:

Abdelkader Detti, Nadia Yousfi Steiner, Laurent Bouillaut, Allou Badara Samé, Samir Jemei. Hybrid Ageing Model of a Proton Exchange Membrane Fuel Cell (PEMFC). *International Journal of Energy and Power Engineering*. Vol. 11, No. 1, 2022, pp. 17-29.

doi: 10.11648/j.ijepe.20221101.12

Received: December 8, 2021; **Accepted:** December 21, 2021; **Published:** February 25, 2022

Abstract: Today the world is full of time-dependent phenomena in all fields: physics, chemistry, mechanics and many others. Time acts on the performance of any system whatever its nature is. When a system operates over time, aging becomes a real concern. Regarding fuel cells, several degradation phenomena can occur in a short or long term. Short-term phenomena are generally referred to as reversible degradations, these degradations are of the order of the microsecond and can go up to hours and sometimes to days, such as problems related to water management. The long term degradations are usually called irreversible degradations; it can be defined as aging. This phenomenon is of the order of a day and can increase up to months. In order to mitigate the impact of aging on the fuel cell system performance, good corrective actions must be taken. To do so, the performance prediction during the aging of the fuel cell system must be conducted. In this paper a verified and tested prognosis approach applicable to fuel cells is presented. The novelty in the approach used is linked to its modular structure. In fact, this approach has three phases. The first one aims to identify the internal physical parameters of the stack using an optimization algorithm on experimental data and a static fuel cell model. The second one predicts the temporal evolution of these parameters using a prediction algorithm. Finally, the reconstruction phase consists in the prediction of parameters that are re-injected into the model to reconstruct polarization curves and thus reflect the performance degradation of the fuel cell. The reliability and repeatability of the proposed approach have been successfully validated on two data sets from two different experimental campaigns.

Keywords: Proton Exchange Membrane Fuel Cell, Aging, Prognosis, ARMA Model, Stack Internal Parameters

1. Introduction

In the context of global warming and the development of intermittent renewable energies, the hydrogen energy vector can be considered as a key alternative to the existing energy sources. The hydrogen vector can be used with fuel cells to produce a green energy. Indeed, the fuel cell is a promising alternative regarding its high power conversion efficiency, zero pollution emission, low operating temperature and

reduced noise [1, 2].

Despite its use in several fields, such as portable devices, stationary power supply, military equipment and transportation vehicles [3], its cost remains higher than the conventional energy sources. In order to achieve a larger industrial deployment, the fuel cell system has to be competitive in terms of cost, durability and reliability [4, 5].

Regarding durability, The PEMFC remains quite limited due to the various degradation phenomena occurring during its operation [6, 7]. A viable solution, defined as Prognosis and Health Management (PHM), aims to reduce the performance degradation of the PEMFC and so, extend its lifetime. It allows the monitoring, diagnosis and prognosis of a system in order to plan a preventive maintenance using degradation indicators. The prognosis is the key process to predict the future behavior and the remaining useful life (RUL) of the fuel cell system. Three main approaches can be identified 1) model-based approach: it consists on using empirical or physical degradation models 2) data-based approach: it does not require a prior knowledge of the system, based on black box models such as artificial intelligence or signal processing and needs a large amount of data 3) hybrid approach: it combines the two previous ones. [8]

PEMFCs are multiphysics & multiscale systems which makes their behavior modeling difficult. Moreover, a behavioral model contains several parameters which some of them are impossible to monitor. This makes the behavioral or physical model hardly exploitable for practical applications. However, physical models vary according to their purpose. Indeed, not the same models are requested for diagnosis, system command or prognosis.

A data-based approach is presented by Wu Y *et al.* where the authors predict the voltage decrease of a fuel cell stack using Relevance Vector Machine (RVM) [9], Bressel *et al.* [10] also used this approach and applied an extended Kalman filter to predict the performance degradation of a PEMFC. The developed empirical model could accurately predict the state of health of the fuel cell.

Another degradation model, where a deep understanding of PEMFC degradation phenomena and a comprehensive analysis of degradation mechanisms is proposed by two papers from Jouin M *et al.* [8, 12]. It has shown that electrodes and membrane are the most sensitive components in PEMFC degradation. The degradation model developed perfectly corresponds to the experimental results. The use of fuel cells in the transportation field exposes the membrane to intensive conditions that reduce their lifetime by exposing them to chemical and mechanical damage. Macauley *et al.* [11] suggested an empirical life model for heavy-duty fuel cell systems. The proposed empirical model is based on accelerated durability tests of the membrane. This model takes into consideration the effects of temperature, oxygen concentration and humidity. To obtain a good estimation of the remaining useful life of the fuel cell, a deep understanding of the degradation phenomenon is required to take the good corrective actions and extend the fuel cell lifetime. However, it is not an easy task due to the nature of the various degradation phenomena, which can be chemical, mechanical or thermal [13].

A good prediction is based on the choice of adequate degradation indicators that give information about the state of health of the studied system. Regarding fuel cells, several degradation indicators were used such as parameters that can be identified from characterizations, polarization curves and impedance spectra, [14] fuel cell stack or cell voltage / power [13-18] which are the most common. Indeed, the wide use of the voltage as a degradation indicator is due to the fact that it is easily measurable and also the performance decay is immediately observed on the stack voltage.

Based on the fact that most of publications on fuel cell prognosis use stack voltage as a degradation indicator combined to a data-based approach [19], which can be limiting in terms of physical knowledge, needs a large amount of data and has no physical meaning, in this paper a novel prognosis approach is presented. An approach which is both modular and integrates a part of the physical knowledge of the fuel cell using new degradation indicators. On the one hand, the use of these degradation indicators allows, first, the prediction of the performance degradation of the fuel cell. Secondly, it gives information on the state of degradation of the most sensitive internal components of the fuel cell. On the other hand, the modular structure of the proposed approach presents an ease of use where the algorithms used can be replaced by others. The structure of the approach is based on three supports. The first one represents the phase of identification of the internal physical parameters of the stack, used as indicators of degradation, through the application of an optimization algorithm on experimental polarization curves and the static model of the fuel cell. The second one represents the prediction phase, where the identified parameters are modeled and predicted using a prediction algorithm, in this case an AutoRegressive Moving Average (ARMA) model. The third one represents the reconstruction phase, where the prediction of the parameters is injected into the static model in order to reconstruct forecasted polarization curves.

The rest of the manuscript is organized as follows: first, a brief presentation of the operating of a PEMFC and the different characterizations. Then, the proposed prognosis approach is presented explaining its different phases. Then comes the data generation with experimental protocols and finally the results.

2. Proton Exchange Membrane Fuel Cell PEMFC

A fuel cell is an electro-chemical device, which converts chemical energy from hydrogen to electrical energy. The proton exchange membrane fuel cell (PEMFC), in figure 1, consists of two electrodes (anode and cathode) separated by a polymeric membrane.

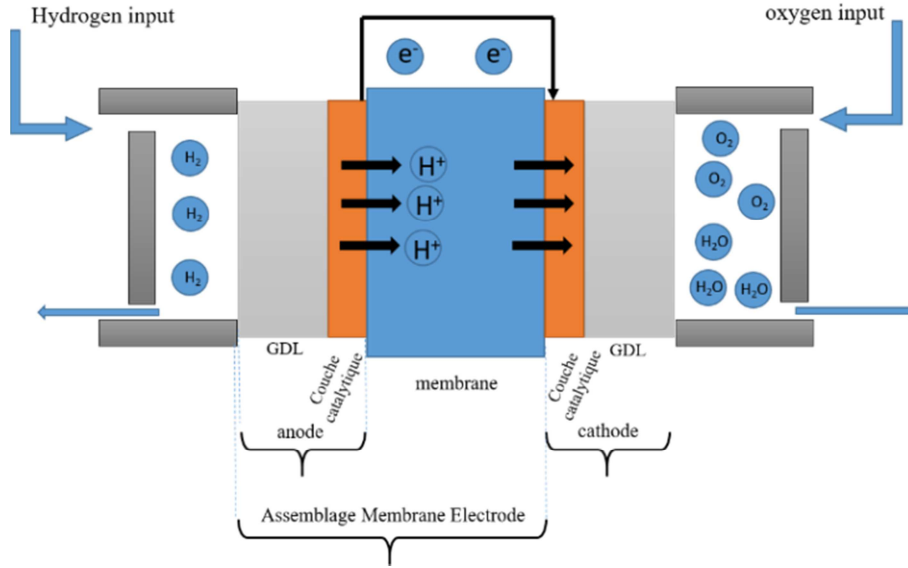

Figure 1. Operating principle of a PEMFC.

Each electrode is composed of two layers: a catalytic layer and gas diffusion layer (GDL).

At the anode side, the reaction of reduction of the hydrogen takes place. In the presence of platinum, the hydrogen is dissociated of its electrons according to the following equation:



The ions H^+ , arrived through the membrane, to the cathode side reacts with electrons e^- arrived from the electrical circuit and the oxygen. The reaction between these chemical components produces water and heat, according to the following half oxidation equation:

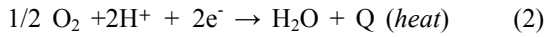

Which gives the redox equation:

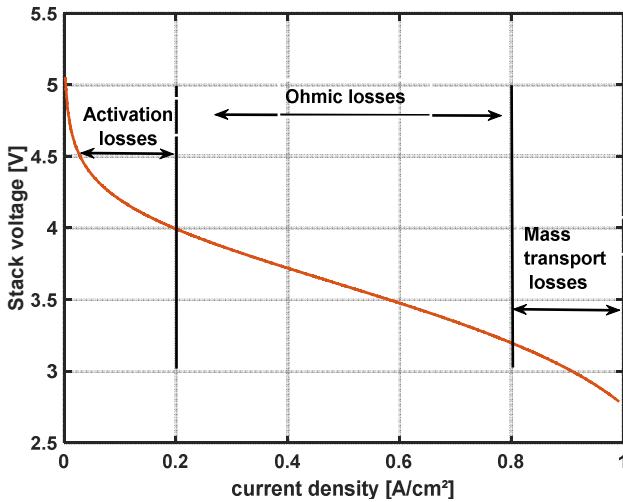
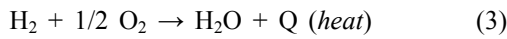

Figure 2. Polarization curve.

A PEMFC can be characterized in different ways; the most

common are the polarization curve, represented in figure 2, and the electrochemical Impedance Spectroscopy (EIS). The polarization curve represents the voltage evolution versus the current. It models the losses that impact the reversible cell voltage E_{rev} . Three main parts can be identified representing three voltage drops according to their dominance and depending on the current density; activation, ohmic and mass transport voltage losses (also called concentration losses), respectively η_{act} , η_{ohm} , η_{conc} . Each voltage loss can be modeled according to the following equations.

$$E = E_{rev} + \eta_{act} + \eta_{ohm} + \eta_{conc} \quad (4)$$

The activation voltage loss, represented by the equation (5) is due to the slowness of the electrochemical reactions at the catalytic layer.

$$\eta_{act} = \frac{RT}{2\alpha F} \ln \left(\frac{j+j_n}{j_0} \right) \quad (5)$$

Where the parameters α , R , T , j , J_n , J_0 respectively represent the charge transfer coefficient, the perfect gaz constant, the operating temperature [k], the current density [A/cm^2], the cross-over current density [A/cm^2], the internal current density [A/cm^2].

The ohmic losses are due to the electrical resistance of the electrodes and the ionic resistance of the membrane.

$$\eta_{ohm} = j \times R_{int} \quad (6)$$

Where R_{int} represents the internal resistance [Ω].

Mass transport losses, also known as concentration losses are due to the incapability to supply enough reactants at high current density, leading to a drop of their concentration on the surface of the electrodes.

$$\eta_{conc} = \frac{RT}{2F} \ln \left(1 - \frac{j}{j_l} \right) \quad (7)$$

Where J_l represents the limit current density.

The EIS is a powerful tool for providing information on the state of health of a fuel cell. It can be used to identify faulty operating conditions or a performance deterioration. Kurz *et al.* [20] could detect flooding conditions using EIS before they can be observed on the polarization curves. They have proven that an impedance measurement performed at only at high and

low frequencies can be sufficient to predict the voltage drop due to flooding or drying failure conditions. In the work of Rubio *et al.* [21] the time evolution of ohmic resistances give information on the overall degradation of the component, since the ohmic resistance is linked to water content of the membrane and is significantly affected by aging [22].

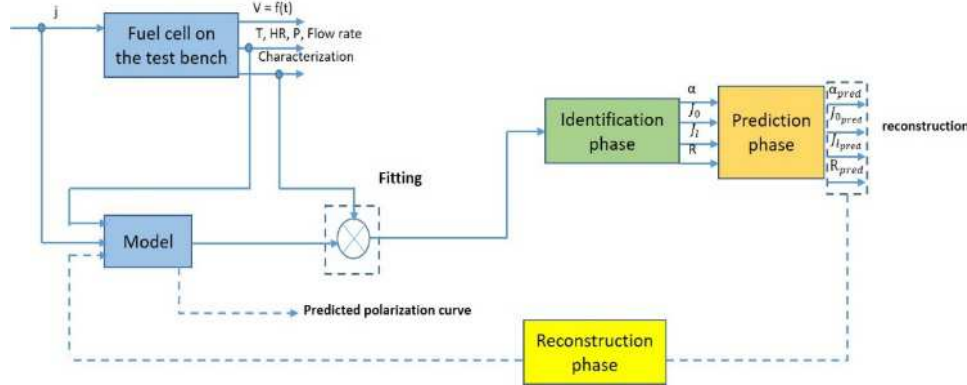

Figure 3. Proposed prognosis process.

3. The Prognosis Approach

The fuel cell performance degradation can be observed on the stack/cell voltage temporal evolution but also on characterizations, (EIS) and polarization curves (IV). The proposed prognostic approach for PEMFCs, illustrated in figure 3, uses the identified internal parameters of the stack from losses modeling to predict the fuel cell ageing. and consists of three phases. The first one aims to identify the internal parameters of the stack using an optimization algorithm. The second phase uses a prediction algorithm for the modeling and forecasting of the identified parameters. The third one combines the parameter's prediction and a fuel cell static model in order to reconstruct polarization curves.

The identification phase is based on the model presented in our previous work [38] combined with experimental polarization curves, then, their time evolution is modeled and predicted using an ARMA model. Thus, predicted polarization curves are reconstructed from the prediction of the parameters and will represent the performance degradation of the fuel cell.

3.1. The Identification Phase

The parameters to be identified have been chosen according to their dependence with the components likely to be degraded during the fuel cell operation, in particular the catalyst layer and the membrane. The identified parameters, namely, charge transfer coefficient, internal current density, internal resistance and limit current density, are directly related to the stack components. The evolution of one of these parameters indicates a change in the component associated with this parameter.

The charge transfer coefficient is the proportion of the electrical energy applied that is harnessed in changing the rate of an electrochemical reaction. It indicates the state of the active layer. And so, when hydrogen cross over occurs during which one molecule of hydrogen cross from the anode to the

cathode side, two electrons are wasted and cross internally, it is called internal current density. This phenomenon leads to an increase of activation voltage losses.

The internal resistance represents the resistance of the electrodes and the resistance of the ions in the electrolyte and affects the ohmic losses. The limit current density is the current at which the fuel is used up at a rate equal to its maximum supply speed. The current density cannot exceed this value, because the fuel gas cannot be supplied at a greater rate. It depends on the catalytic surface and affects the mass transport losses.

These parameters vary during the stack aging. Assuming an exponential, linear or another trend of their evolution as it is presented in [35], gives an information about the state of the component, but remains limiting in the case where an unexpected fault occurs during the fuel cell operation. Basing on this, one of our main contributions of this work is the ability to predict the fuel cell performance degradation while having a part of physical knowledge related to the stack components.

The identification of the internal parameters is processed through the fitting of the experimental polarization curves and the modeled one using a genetic algorithm. The use of this algorithm instead of a classic optimization algorithm was adopted because of its properties. The fact that the objective function in equation 8, is not linear this promotes the use of a metaheuristic method. In addition, it is important to find the value of the global minimum, since the parameters to be identified will reflect physical parameters related to the components of the stack. The objective function is defined as the mean square error between the two curves. The Ga function of the Matlab optimization toolbox was used and the default parameters of the algorithm were kept.

$$fun = \frac{1}{n} \sum_{i=1}^n (y - \hat{y}_i)^2 \quad (8)$$

Where n , y and \hat{y} respectively represent the number of samples, the modeled and experimental values.

The charge transfer coefficient, internal current density and limit current density of the two test campaigns and the internal resistance of the first test campaign, were identified according to the lower and upper bounds represented in table 1. However, the internal resistance of the second test campaign was identified using EIS.

Table 1. Optimisation lower and upper bounds.

Parameters	α	J_0	J_1	r
Lower bound	0.3	$1e^{-6}$	4	$1e^{-4}$
Upper bound	0.55	$1e^{-3}$	0.9	$1e^{-2}$

3.2. Prediction Phase: Auto-Regressive Moving Average Process

A time series is a finite sequence of time-indexed data. The time index may be expressed depending on the case, in seconds, minutes, hours or years. Time series analysis occupies an important place in the fields of observation and data collection. Their analysis has undergone a great development since its highlighting, through several research works, namely the statistical relationship between air pollution indicators and population state of health indicators [23]. Time series analysis is also widely used for predicting future data. This field has many applications, in finance, medicine, econometrics, meteorology and many other fields. The purpose is to take a sample of data and build the best model that fits it and then predict future values basing on the previous ones. Several tools are used to model and predict time series such as black box models (neural networks, support vector machine, fuzzy inference systems etc), time series linear models (linear regression models), etc.

The Auto-Regressive Moving Average (ARMA) model is one of the most widely used time series models. This stochastic process describes stationary processes varying with time. The future values of an observation are described as a linear function that depends on the past observations, and random errors. The first ARMA process has been used by Box et al. [24] for time series prediction.

The ARMA model is composed of two processes, the Auto Regressive (AR) and the Moving Average (MA) processes. The first use of the Autoregressive process was done by Yule [25] where he modeled the number of sunspot time series. The AR(p) model describes a variable at time "t" as a combination of past values and a white noise, where the "p" represents the order of the AR model. The moving average process has been introduced by Slutsky [26]. These two models can be described mathematically as follows:

$$\text{AR}(p) : X_t = \sum_{k=1}^p \varphi_k X_{t-k} + \varepsilon_t \quad (9)$$

$$\text{MA}(q) : X_t = \sum_{k=1}^q \theta_k \varepsilon_{t-k} \quad (10)$$

$$\text{ARMA}(p,q) = \varepsilon_t + \sum_{k=1}^p \varphi_k X_{t-k} + \sum_{k=1}^q \theta_k \varepsilon_{t-k} \quad (11)$$

$$\hat{x}_{t+h} = \varphi_p \hat{x}_{t-p+h} + \theta_q \varepsilon_{t-q+h} \quad (12)$$

where, φ_k and θ_k are respectively, the autoregressive and moving-average models parameters, X_{t-k} is the observation k

time-units before the current time t , ε_t is a white Gaussian noise and h is the step ahead point forecast.

The ARMA model has proven its reliability and effectiveness in several fields, through a good prediction efficiency and limited computing resources. Indeed, it has proven its reliability in electronics, financial, mechanical, medical, chemistry and engineering domains [27 – 38].

The satisfactory and accurate results obtained using the ARMA model to predict time series in several fields partly motivated us to use it in our work. The lack, according to our research, of publications aimed to predict the performance of fuel cells using this approach is the second motivating factor to carry out this work. Thirdly, the use of this prediction algorithm is due to its implementation simplicity as well as the reduced computation time.

Before using the ARMA model, the parameter's time series stationarity must be checked first. To do this, the Augmented Dickey-Fuller test (ADF) and Kwiatkowski-Phillips-Schmidt-Shin (KPSS) will be computed on the parameter's time series. The ADF procedure allows to detect the stationarity of a time series. It tests whether the estimator of one of the roots of the autoregressive polynomial is significantly close to 1. To enhance the conclusion of the ADF test, it is necessary to conduct a complementary test to detect the non-stationarity.

4. Experimental Tests

To study the PEMFC's aging, two experimental campaigns were carried out. The first one of a duration of 2250 hours was conducted on a 5 cells stack of 250cm² of active layer and a limit current density of 4A/cm², under constant operating conditions, presented in table 2.

Table 2. First test campaign operating conditions.

Parameter	Value
Cathode stoichiometry	1.7
Cathode flow [l/min]	62.89
Cathode inlet pressure [Bar]	1.00171
Cathode inlet temperature [°C]	76.63
Anode flow [l/min]	15.601
Anode inlet pressure [Bar]	1.0034

The results are derived from the tests carried out within the framework of the project GIANTLEAP [40].

During the tests, the stack was characterized (polarization curve) each 250h. The second one, of a duration of 750 hours, was carried out on a 5 cell stack of 100cm² of active layer under wide Worldwide harmonized light duty driving Test Cycle (WLTC) load profile. The tests were carried out under constant, temperature, relative humidity and stoichiometry, presented in table 3, however the reactants flow rate was regulated according to the current demand.

The development of the WLTC, illustrated in figure 4, was carried out under a program launched by the World Forum for the Harmonization of Vehicle Regulations (WP.29) of the United Nations Economic Commission for Europe (UN-ECE) through the working party on pollution and energy transport

program (GRPE). The aim of this project was to develop a World-wide harmonized Light duty driving Test Cycle (WLTC), to represent typical driving characteristics around the world, to have the basis of a legislative worldwide harmonized type certification test and to develop a gearshift procedure which simulates representative gearshift operation for light duty vehicle.

Table 3. Second campaign operating conditions.

Parameter	Value
Cathode stoichiometry	3
Cathode inlet pressure [Bar]	1.3
Cathode inlet temperature [°C]	60
Anode inlet pressure [Bar]	1.3

Each cycle lasts 1200 seconds, the cycles were repeated 70 times (sequence of cycles) to reach 20 hours of consecutive operation, the stack was characterized after each sequence of cycles (polarization curve and Electrochemical Impedance Spectroscopy (EIS)).

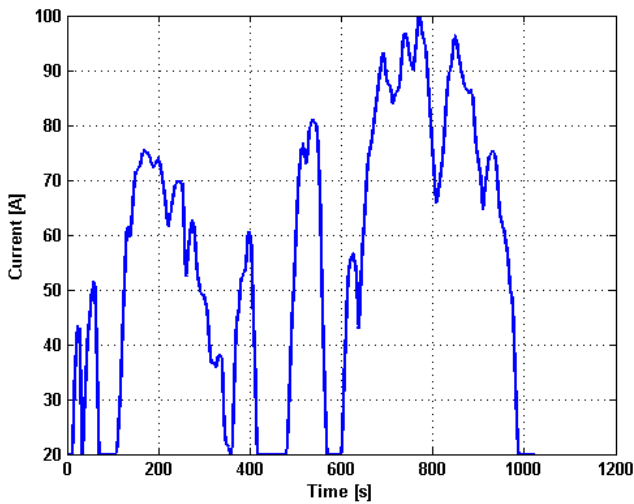

Figure 4. WLTC load profile.

This work is based on three assumptions: 1) no fault during the tests (only irreversible degradation linked to ageing), that means that no fault was caused to study the fuel cell reversible degradation but only its aging, 3) the internal cross-over current density was fixed due to its small variation during the fuel cell aging, which makes its identification difficult.

5. Results and Discussion

Due to the constant load profile of the first test campaign, only irreversible degradations were observed on the polarization curves, in figure 5, which is not the case for the second test campaign. Indeed, it was carried out under a dynamic load profil, reversible degradations can occur such as drying out or flooding of the membrane. Therefore, it is visible on the characterizations as a performance recovery. Reason why, in this work, only the polarization curves and impedance spectra representing aging are considered, illustrated in figure 6, 7, in other words, the characterizations before performance

recovery will not be taken into account.

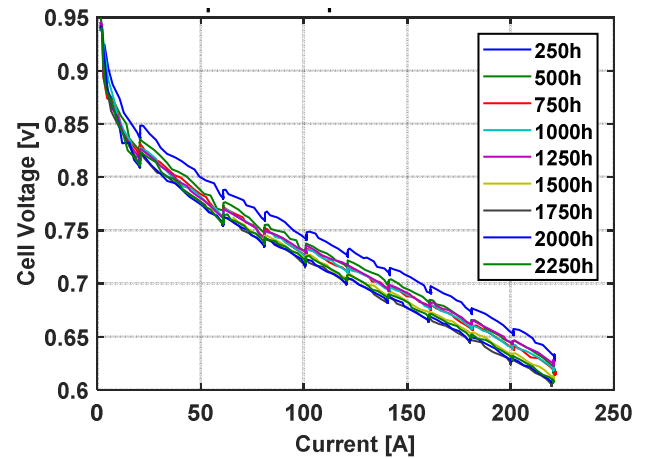

Figure 5. First campaign test polarization curves.

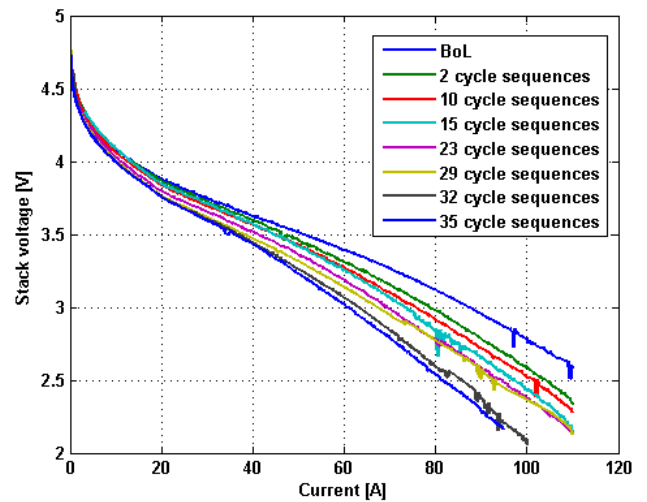

Figure 6. Second test campaign polarization curves.

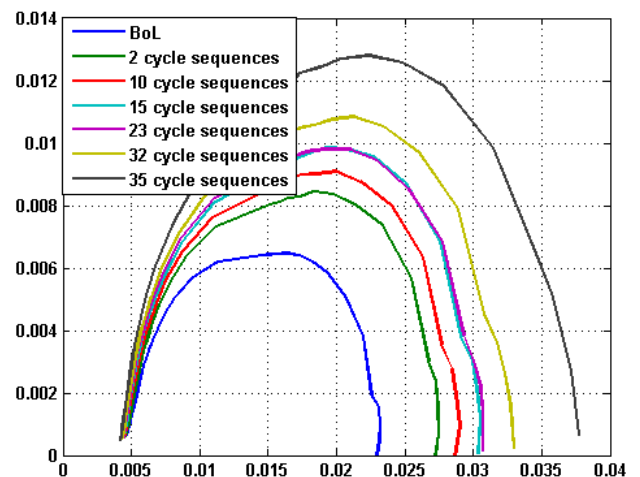

Figure 7. EIS during the second test campaign.

The time evolution of the identified parameters of the two test campaigns, in figures 8 and 9, corresponds to the expected results. Indeed, during the fuel cell operation, its internal components deteriorate over time.

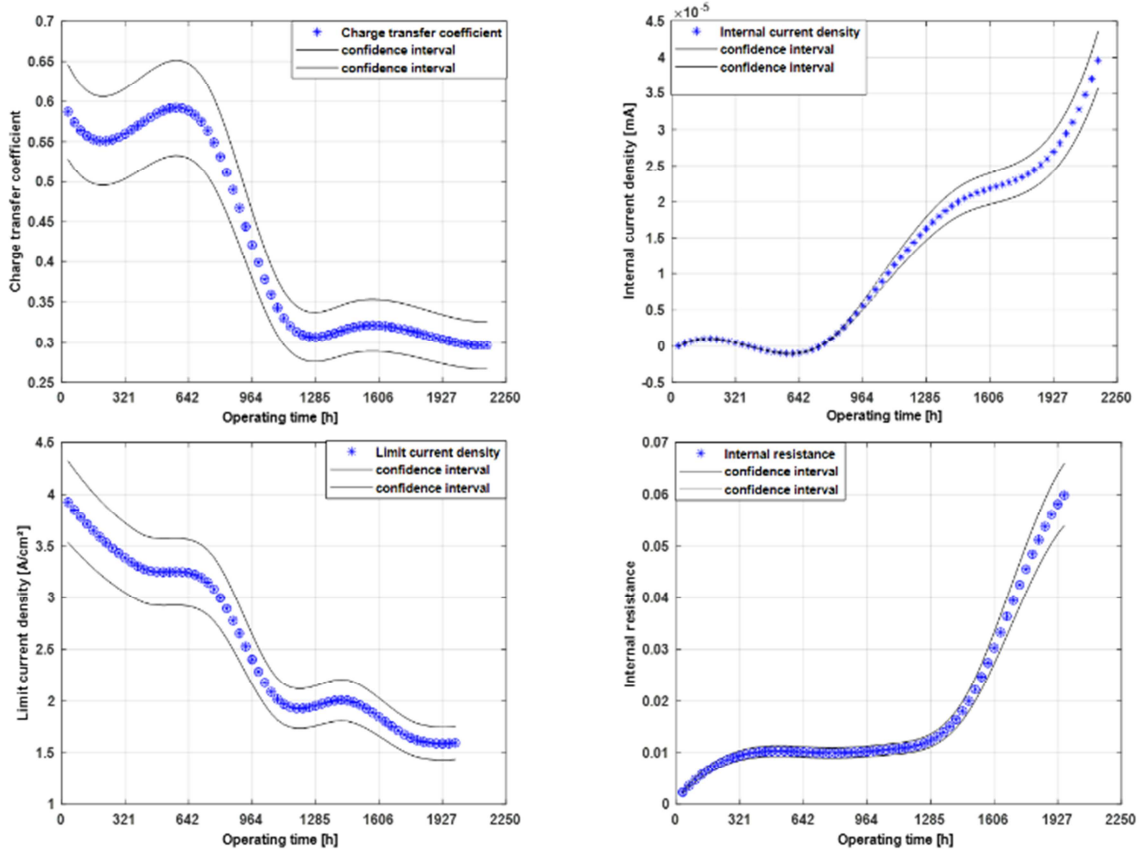

Figure 8. Internal parameters time evolution of the first test campaign.

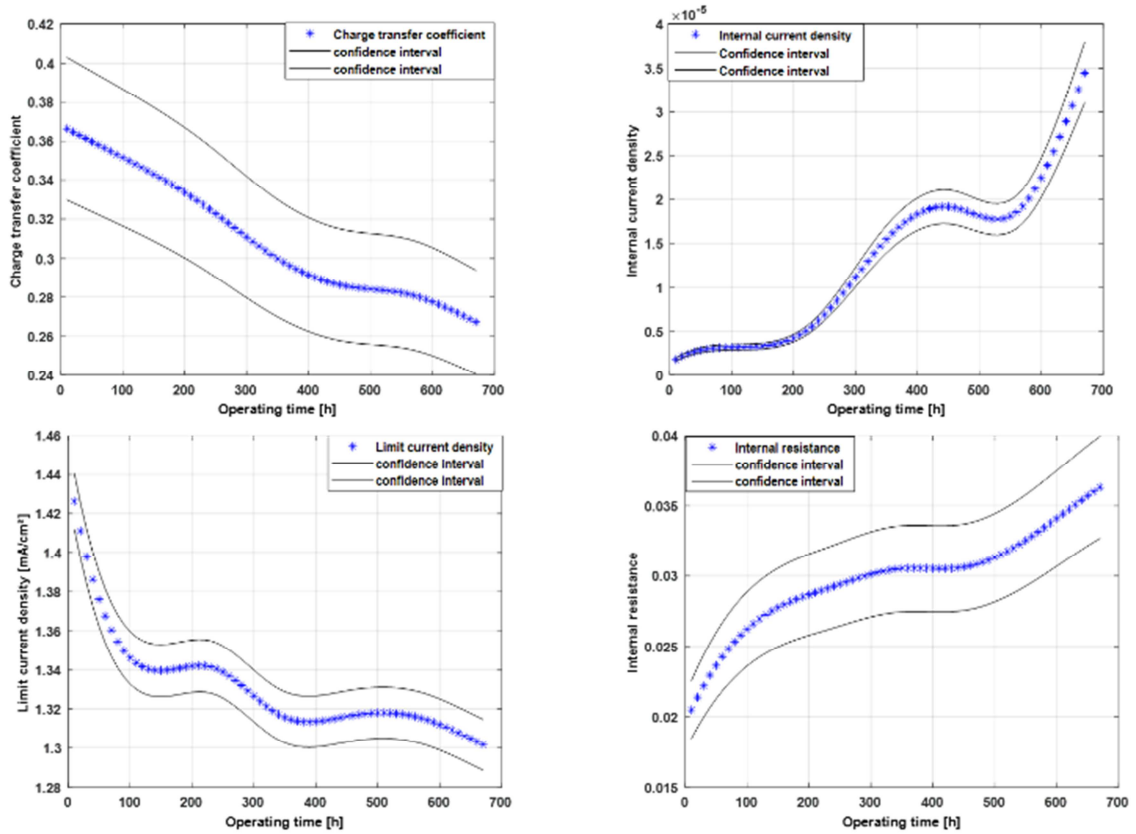

Figure 9. Internal parameters time evolution of the first test campaign.

The charge transfer coefficient and the limit current density are direct indicators of the state of the active layer. Their decrease proves the degradation of the catalyst layer and leads to the stack performance degradation. The degradation of the catalyst layer is often linked to the platinum particles sintering, dissolution, migration... etc. Regarding the internal resistance and internal current density are related to the degradation of the membrane. Their increase can be interpreted as the increase of the ionic resistance of the membrane and the increase of the electrodes resistance; this may be due to the dehydration of the membrane or its mechanical degradation, pinholes formation or appearance of micro cracks, or even its chemical degradation caused by a poisoning. The same trends in the

time series of each parameter are observed on the results obtained over the two test campaigns.

Each parameter's evolution affects the voltage losses. Indeed, the decrease of the charge transfer coefficient and the increase of the internal current density lead to an increase of the activation losses according to Eq (5). The increase of the internal resistance leads to the increase of the ohmic losses according to Eq (6) and the decrease of the internal limit current density leads to the increase of the mass transport losses according to Eq (7). When the losses increase, it consequently leads to a deterioration of the fuel cell performance.

The time evolution of the internal parameters allows us to write the aging model of the fuel cell stack as follows:

$$E(t) = E_{rev} + \frac{RT}{2\alpha(t)F} \ln\left(\frac{j+j_n}{j_0(t)}\right) + j \times R_{int}(t) + \frac{RT}{2F} \ln\left(1 - \frac{j}{j_l(t)}\right) \quad (13)$$

In order to validate the fitting results, identified values of each parameter will be used in the static model and compared with the corresponding experimental polarization curves, two

of them are represented in figures 10, 11. The fitting results give a Mean Square Error (MSE) of 0.005%, which is quite satisfying.

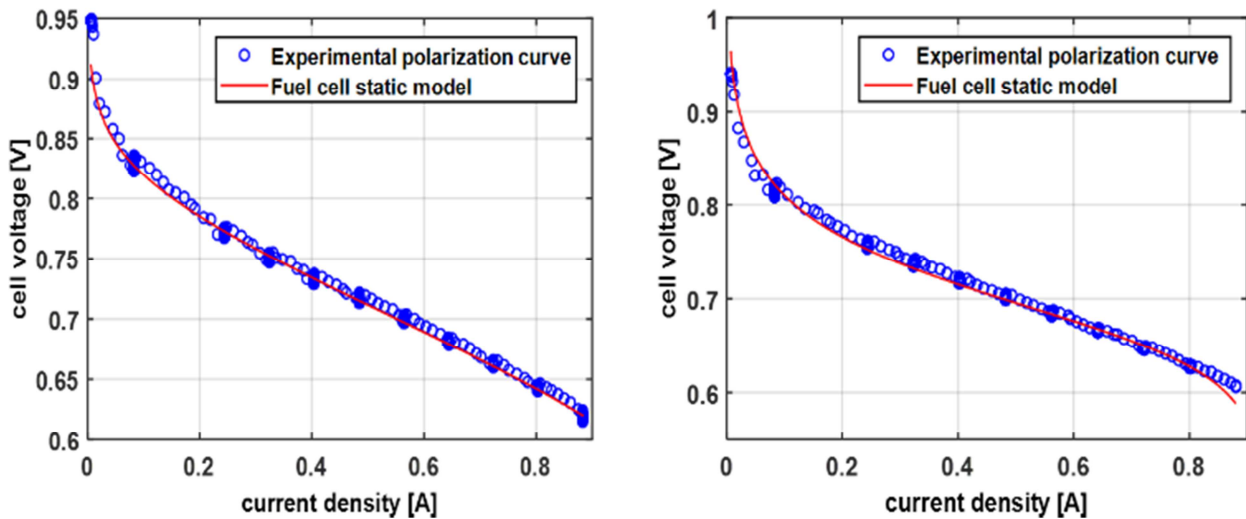

Figure 10. Fitting result: polarization curve at 500 and 2000 operating hours (first test campaign).

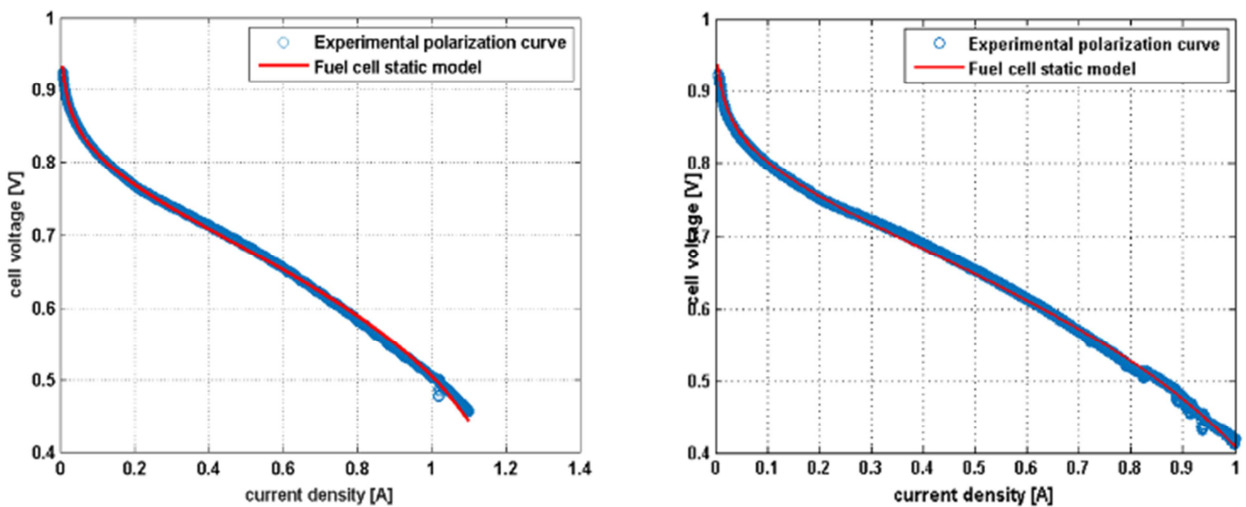

Figure 11. Fitting result: polarization curve at 10 and 29 cycle sequences (second test campaign).

The next step of the process consists on testing each parameter's time series stationarity using the ADF and KPSS tests. To do this, the "adftest" and "kpss", Matlab functions are used. The test rejection decision is returned as a logical value $h = [1, 0]$. If $h = 0$ (ADF) & $h = 1$ (KPSS), the time series has a unit root so it is admitted not stationary. If $h = 1$ (ADF) & $h = 0$ (KPSS), the time series does not have a unit root so it is admitted stationary. The tests were conducted on the four parameters with three difference-lagged terms. Indeed, a time series can be unstationary but the same time series lagged with two or three terms might be stationary. The results are shown in the following table. The tests were processed using the Matlab® daftest & kpstest functions.

Table 4. Test stationarity results.

	ADF		KPSS	
Charge transfer coeff. α	1	0	0	1
Internal resistance r	0	1	0	1
Limit current density J_l	0	0	1	0
Internal current density J_0	0	0	1	0

The results, presented in table 4, show that the four parameters time series are stationary. charge transfer coefficient is strictly stationary, the internal resistance, limit current density and the internal current density are of low stationarity. According to the obtained results we can conclude that an ARMA process can model and predict the parameters evolution.

Despite the fact that an AR and MA models can be adapted to model a time series, in some cases, it may be necessary to estimate a large number of parameters to adjust the model. According to [39], the combination of an AR and MA models can predict any time series as long as the orders p and q are well chosen. Indeed, the model order remains rather sensitive to have a good time series prediction. A model with a large order can lead to an over or under adjustment of the model and thus give compromising results. In order to avoid these problems, two information criteria, Akaike's Information Criterion (AIC) and Bayesian Information Criterion (BIC), are used for the selection of the model order (explained in appendix).

The model was adjusted on 75% of each time series of the two test campaigns, called learning base, illustrated as, model adjustment, and the forecasting was computed on the remaining 25%, called testing base, and then a prediction over the testing base was computed as shown in figures 12 and 13. The adjustment and prediction errors are presented in tables 5 and 6.

Table 5. Adjustment and prediction errors of the first test campaign.

Parameters	α	J_0	J_l	r
Lower bound	2	0.07	0.8	0.04
Upper bound	0.01	0.001	5	0.05

Table 6. Adjustment and prediction errors of the second test campaign.

Parameters	α	J_0	J_l	r
Lower bound	0.001	0.002	0.001	0.004
Upper bound	0.006	0.08	0.002	0.001

In order to check the reliability of the model the prediction is computed with 5 steps ahead during the adjustment and testing phases, which represents 165 hours of operation. Indeed, a one step ahead is usually not a good test for validating the model over the time span of the data. So a poor model may give good results for a one step ahead prediction.

In a first time, the prediction computed on the testing base matches the real values of each parameter with an average MSE of the four parameters of 1.26%. The obtained results correspond to our expectations. The first test campaign was conducted under fixed operating conditions. Long-term operation implies aging, in other words, the absence of reversible losses. In fact, long-term operation can cause irreversible losses generally linked to water management. Flooding can occur increasing therefore the relative humidity and forming water droplets on the membrane. Their formation leads to a local pressure increase on the membrane, thus causing the appearance of microcracks that can spread along the membrane causing its failure. The increase of the relative humidity also dangerous for the components of the stack. Indeed, when it occurs it may lead to the corrosion of the carbon support and degradation of the catalytic layer through migration and agglomeration of the catalyst. These degradation phenomena are harmful for the stack and are the direct causes of the decrease of its lifespan.

The second test campaign was conducted under dynamic load profile, this involves operating phases at the open circuit and sudden current solicitations, which is harmful for the stack and can cause more severe degradation than those observed during the first test campaign. The operation at the open circuit ca leads to the degradation of the membrane manifested in the pinholes formation or microcracks, and also the corrosion of the bipolar plate, whose resulting ions are harmful to the membrane as well as the catalyst layer. Sudden current solicitation can lead to the dissolution of the catalyst. Indeed, the electrical dynamics are faster than the fluidic ones, the delay during the delivery of the reactants inevitably leads to the dissolution of the catalyst. The dissolution will then contaminate the membrane leading to its degradation.

All these degradation phenomena lead to the performance decay observed on the characterizations carried out. The evolution of the internal parameters illustrated in figures 12 and 13 perfectly reflects these degradation phenomena. The internal resistance and internal current density are strongly linked to the state of health of the membrane, their increase demonstrates its deterioration. Regarding charge transfer coefficient and the limit current density, their decrease indicates the deterioration of the catalyst layer due to the degradation phenomena.

To validate the prediction computed on the testing base, predicted and known polarization curves will be compared. To do this, predicted parameters are used in the fuel cell model to reconstruct "predicted polarization curve" which will be compared to the known ones "interpolated polarization curves". The results are shown in figures 14 & 15.

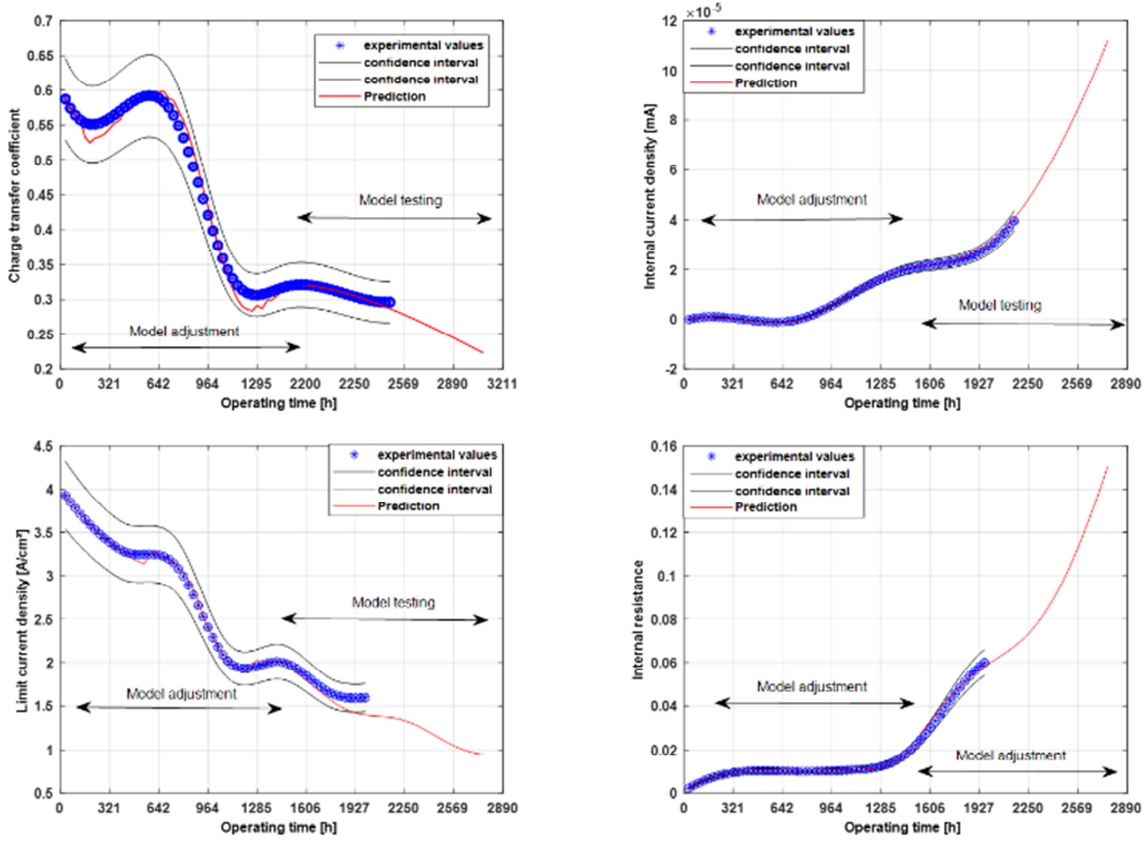

Figure 12. Internal parameters prediction of the first test campaign.

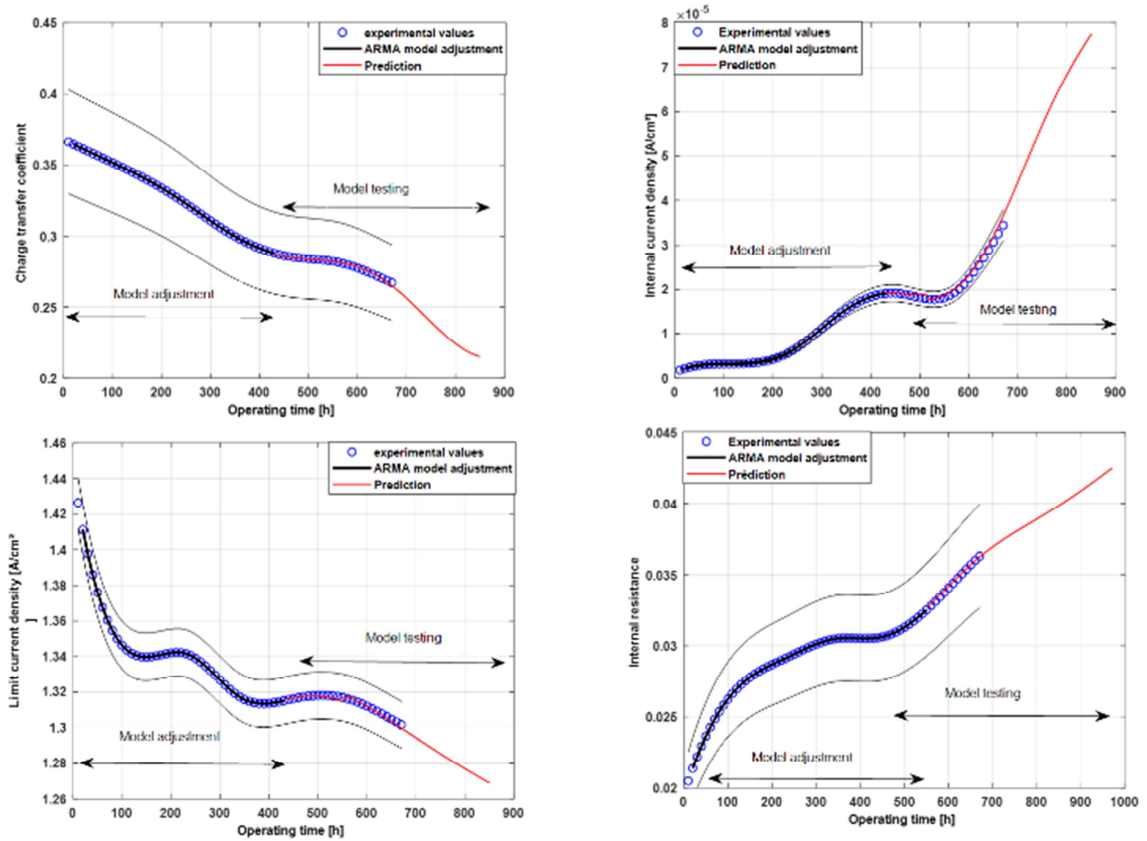

Figure 13. Internal parameters prediction of the second test campaign.

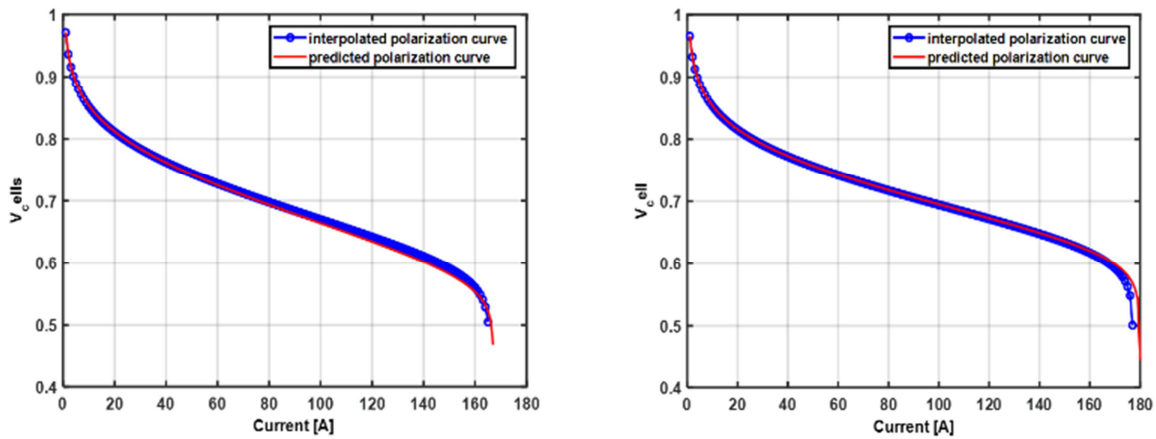

Figure 14. Prediction validation on polarization curves of the first test campaign.

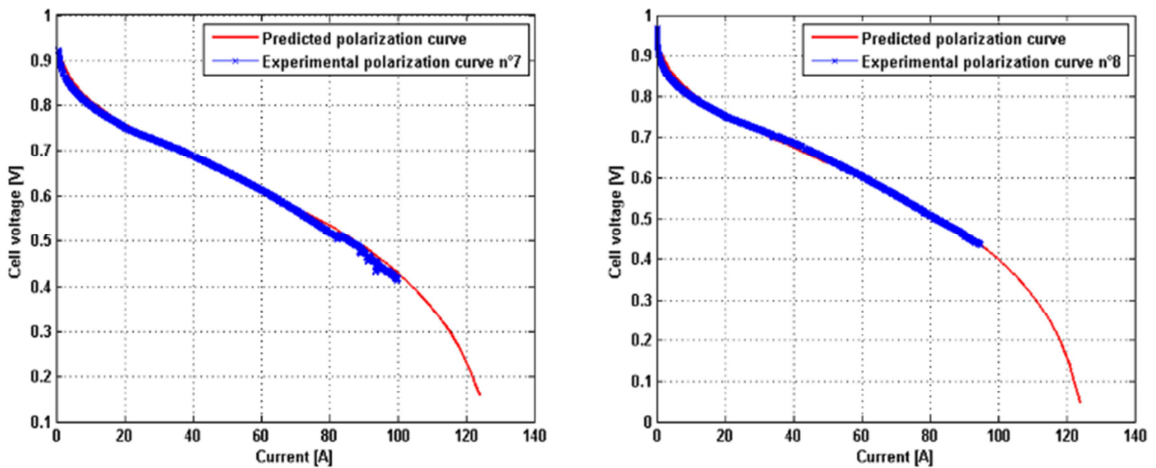

Figure 15. Prediction validation on polarization curves of the second test campaign.

The predicted values of each parameter beyond the known 250 operating hours, will be used in the fuel cell model in order to reconstruct “predicted polarization curves” figure 16.

The last known polarization curve remains above the predicted polarization curves at the ohmic and diffusion losses. Visually, the predicted polarization curves prove the

performance degradation of the stack. Physically, the performance degradation can be deduced at the ohmic losses. Indeed, the results obtained previously indicate an increase of the internal resistance which consequently lead to an increase of the ohmic losses. Their dominance in the polarization curve make the degradation more visible.

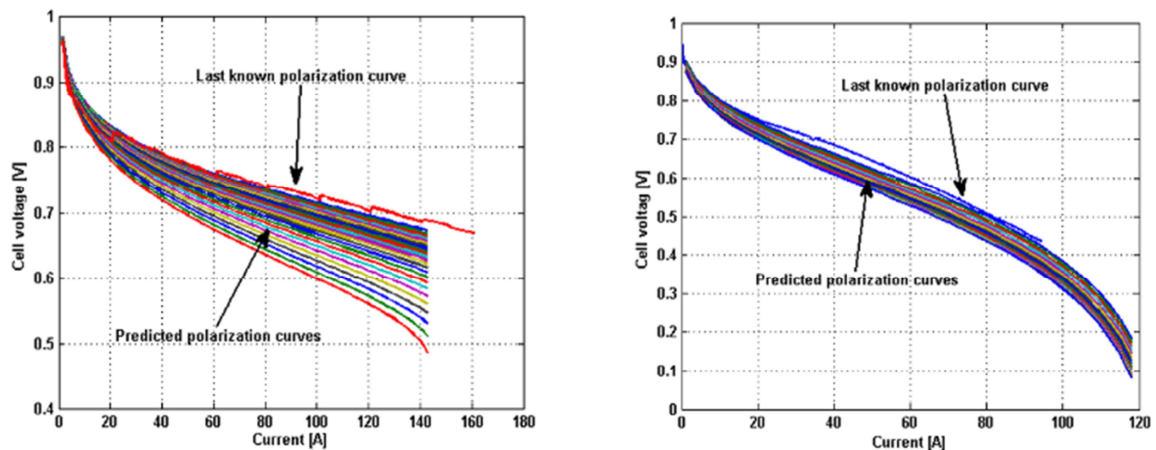

Figure 16. Predicted polarization curves of the first and second test campaign left to right.

6. Conclusions and Prospects

In this paper a novel prognosis approach is used to predict the performance degradation of a fuel cell stack. The degradation indicator used to predict the performance degradation of a fuel cell is usually the stack or the cell voltage/power, however it does not give precise information about the physical phenomena occurring in the stack. In this work, the physical knowledge of the stack is used to predict its performance degradation. Two test campaigns were conducted, the first one under constant load profile and operating conditions, the second one under WLTC load profile. Static and dynamic characterizations were performed to monitor the performance decay of the PEMFC.

A static model is combined with the experimental polarization curves to identify the internal parameters of the stack that vary over time and therefore reflect its aging, namely, charge transfer coefficient, internal current density, internal resistance, and limiting current density. EIS was performed during the second test campaign which allows the identification of the internal resistance. Each parameter depends on a component of the stack and its degradation. Although the two test campaigns and their load profile are different, there are strong similarities between the trend of their time evolution. The time series of the identified parameters were modeled and then predicted using an ARMA model. First a validation step is required, the model was adjusted on 75% of the time series of each parameter and then predicted on the remaining 25% and further more. The prediction on the remaining 25% gives satisfying results according to the resulted MSE. Secondly, the predicted values of each parameter over the known values are used to reconstruct the “predicted polarization curves” and then compared to the last one known. The results show that the predicted polarization curves remain under the last one known as expected. The performance degradation observed on the polarization curves indicates the aging of the stack through the degradation of the internal membrane and active layer.

The satisfactory and consistent results obtained on the two test campaigns and the fact that the parameters evolve in an almost similar way, despite the difference between the two test campaigns, can confirm the effectiveness and the repeatability of the applied method. Despite the simplicity of the used identification and prediction algorithms the results are satisfactory, other algorithms can replace those used in order to improve the results in terms of prediction accuracy.

Acknowledgements

This project has received funding from the Fuel Cells and Hydrogen 2 Joint Undertaking under grant agreement No 700101. This Joint Undertaking receives support from the European Union Horizon 2020 research and innovation program and Hydrogen Europe and N. ERGHY. Nadia Yousfi Steiner acknowledges the support from the EIPHI Graduate School (contract "ANR-17-EURE-0002").

References

- [1] Seyhan M, Akansu YE, Murat M, Korkmaz Y, Akansu So (2017). *Performance prediction of PEM fuel cell with wavy serpentine flow channel by using artificial neural network*. International Journal on Hydrogen Energy, Vol. 42 (40).
- [2] Zhang X, Yang D, Luo M, Dong Z (2017). *Load profile based empirical model for the lifetime prediction of an automotive PEM fuel cell*. International Journal on Hydrogen Energy, Vol. 42 (16).
- [3] Mao L, Jackson L, Davies B (2018). *Investigation of PEMFC fault diagnosis with consideration of sensor reliability*. International Journal on Hydrogen Energy, Vol. 43 (35).
- [4] Steiner N. Y., Hissel D., Moçotéguy P., Candusso D. (2011), *Diagnosis of polymer electrolyte fuel cells failure modes (flooding & drying out) by neural networks modeling*, International Journal on Hydrogen Energy, Vol. 36, pp. 3067–3075.
- [5] Mohammadi A, Djerdir A, Steiner N, Khaburi D. (2015). *Advanced diagnosis based on temperature and current density distributions in a single PEMFC*. International Journal on Hydrogen Energy, Vol. 40 (45).
- [6] Baik K. D., Kong I. M., Hong B. K., Kim S. H., Kim M. S. (2013). *Local measurements of hydrogen crossover rate in polymer electrolyte membrane fuel cells*, Applied Energy, Vol. 101, pp. 560-566.
- [7] Jung G. B., Chuang K. Y., Jao T. C., Yeh C. C., Lin C. Y. (2012). *Study of high voltage applied to the membrane electrode assemblies of proton exchange membrane fuel cells as an accelerated degradation technique*, Applied Energy, Vol. 100, pp. 81-86.
- [8] Jouin M., Gouriveau R., Hissel D., Pera M. C., Zerhouni N. (2015). *PEMFC aging modeling for prognosis and health assessment*, 9th IFAC Symposium on Fault Detection, Supervision and Safety for Technical Processes SAFEPROCESS 2015, pp. 790–795.
- [9] Wu Y., Breaz E., Gao F., Miraoui A. (2015). *Prediction of PEMFC Stack Aging Based On Relevance Vector Machine*, IEEE Transportation Electrification Conference ITEC'2015.
- [10] Bressel M., Hialiret M., Hissel D., Ould Bouamama B. (2016). *Extended Kalman filter for prognostic of proton exchange membrane fuel cell*, Applied Energy, Vol. 164, pp. 220-227.
- [11] Macauley N., Watson M., Lauritzen M., Knights S., Gary Wang G., Kjeang E. (2016). *Empirical membrane lifetime model for heavy duty fuel cell systems*, Journal of Power Sources, Vol. 336, pp. 240-250.
- [12] Jouin M., Gouriveau R., Hissel D., Pera M. C. and Zerhouni N. (2016). *Degradations analysis and aging modeling for health assessment and prognostics of PEMFC*, Reliability Engineering and System Safety, Vol. 148, pp. 78–95.
- [13] Pei P., Chen H. (2014). *Main factors affecting the lifetime of proton exchange membrane fuel cells in vehicle applications: A review*, Applied Energy, Vol. 125, pp. 60-75.

- [14] Jouin M, Gouriveau R, Hissel D, Pera M, Zerhouni N. (2014). *Prognostics of PEM fuel cell in a particle filtering framework*. International Journal on Hydrogen Energy, Vol. 39, pp. 481–94.
- [15] Blunier B., Miraoui A. (2010). *Proton Exchange Membrane Fuel Cell Air Management in Automotive Applications*, Journal of Fuel Cell Science and Technology, Vol. 7 (4).
- [16] Morando S., Jemei S., Hissel D., Gouriveau R., and Zerhouni N. (2015). *ANOVA method applied to Proton Exchange Membrane fuel cell ageing forecasting using an echo state network*, Mathematics and Computers in Simulation, Vol. 131, pp. 1–12.
- [17] Silva, R. E., Gouriveau R., Jemei S., Hissel D., Boulon L., Agbossou K. (2014). *Proton exchange membrane fuel cell degradation prediction based on Adaptive Neuro-Fuzzy Inference Systems*. International Journal on Hydrogen Energy, Vol. 39 (21).
- [18] Morando S., Jemei S., Hissel D., Gouriveau R. and Zerhouni N. (2017). *Proton exchange membrane fuel cell ageing forecasting algorithm based on echo state network*. International Journal on Hydrogen Energy, Vol. 42 (2).
- [19] Robin C., Gerard M., Franco A. A., Schott P. (2013). *Multi-scale coupling between two dynamical models for PEMFC aging prediction*. International Journal on Hydrogen Energy, Vol. 38 (11), pp. 4675–4688.
- [20] Kurz T., Hakenjos A., Krämer J., Zedda M., Agert C. (2008). *An impedance-based predictive control strategy for the state-of-health of PEM fuel cell stacks*. Journal of Power Sources, Vol. 180, pp. 742–747.
- [21] Rubio M. A., Urquia A., Dormido S. (2010). *Diagnosis of performance degradation phenomena in PEM fuel cells*. International Journal on Hydrogen Energy, Vol. 35.
- [22] Fouquet N., Doulet C., Nouillant C., Dauphin-Tanguy G. and Ould-Bouamama B. (2006). *Model based PEM fuel cell state-of-health monitoring via ac impedance measurements*. Journal of Power Sources, Vol. 159, pp. 905–1013.
- [23] Schwartz J. (1994). *Air pollution and hospital admissions for the elderly in Birmingham, Alabama*. American Journal of Epidemiology, Vol. 139, pp. 589-598.
- [24] Box G. E. P. and Jenkins G. M. (1970). *Time series analysis: Forecasting and control*. Wiley Series in Probability and Statistics, Wiley Ed.
- [25] Yule U. (1927). *On a method of investigating periodicities in disturbed series, with special reference to wolfer's sunspot numbers*. Philosophical Transactions of the Royal Society, Vol. 226.
- [26] Slutsky E. (1927). *The summation of random causes as the source of cyclic processes*. Econometrica, Vol. 5, pp. 105–146.
- [27] Erdem E., Shi J. (2011). *ARMA based approaches for forecasting the tuple of wind speed and direction*, Applied Energy, Vol. 88, pp. 1405–1414.
- [28] Hao Y., Tian C. (2019). *A novel two-stage forecasting model based on error factor and ensemble method for multi-step wind power forecasting*, Applied Energy, Vol. 238, pp. 368–383.
- [29] Loi T. S. A., Ng J. L. (2018). *Anticipating electricity prices for future needs – Implications for liberalized retail markets*, Applied Energy, Vol. 212, pp. 244–264.
- [30] David M., Ramahatana F., Trombe P. J. and Lauret P. (2016). *Probabilistic forecasting of the solar irradiance with recursive ARMA and GARCH models*, Solar Energy, Vol. 133, pp. 55–72.
- [31] Wang X., Huang L. and Yang C. (2018). *Prediction model of slurry pH based on mechanism and error compensation for mineral flotation process*, Chinese Journal of Chemical Engineering, Vol. 26, pp. 1766–1772.
- [32] Ervural B. C., Beyca O. F. and Zaim S. (2016). *Model estimation of ARMA using genetic algorithms: A case study of forecasting natural gas consumption*, Procedia - Social and Behavioral Sciences, Vol. 235, pp. 537–545.
- [33] Klepsch J., Klüppelberg C. and Wei T. (2017). *Prediction of functional ARMA processes with an application to traffic data*, Econometrics and Statistics, Vol. 1, pp. 128–149.
- [34] Ying Z., Rui K. and Shihong X., *Research on Glucose Concentration Predicting Based on ARMA Model* (2014). Prognostics and System Health Management Conference PHM'2014, Hunan, China.
- [35] Kexin W., Mingxing D. (2010). *A Temperature Prediction Method of IGBT Based on Time Series Analysis*, The 2nd International Conference on Computer and Automation Engineering ICCAE'10.
- [36] Dang P., Zhang H., Yun X. and Ren H. (2017). *Fault prediction of rolling bearing based on ARMA model*, International Conference on Computer Systems, Electronics and Control ICCSEC'17.
- [37] Ning C. X., Wang, J. S. (2015). *Auto Regressive Moving Average (ARMA) prediction method of bank cash flow time series*, proceedings of the 34th Chinese Control Conference, Hangzhou, China.
- [38] Detti A. H., Jemei S. and Yousfi Steiner N. (2018). *Proton exchange membrane fuel cell model for prognosis*, 2018 IEEE Vehicle Power and Propulsion Conference VPPC'18, Chicago, USA.
- [39] Wold H. (1938). *A study in the Analysis of Stationary Time Series*. Almqvist and Wiksell.
- [40] <http://giantleap.eu/>