



**HAL**  
open science

# Thermodynamic performance's analysis of a cold production by hybrid compressor-based thermochemical sorption processes using ammoniated salts

Antoine Perrigot, Maxime Perier-Muzet, Pascal Ortega, Driss Stitou

## ► To cite this version:

Antoine Perrigot, Maxime Perier-Muzet, Pascal Ortega, Driss Stitou. Thermodynamic performance's analysis of a cold production by hybrid compressor-based thermochemical sorption processes using ammoniated salts. *Energy Conversion and Management*, 2022, 267, pp.115931. 10.1016/j.enconman.2022.115931 . hal-03738950

**HAL Id: hal-03738950**

**<https://hal.science/hal-03738950v1>**

Submitted on 26 Jul 2022

**HAL** is a multi-disciplinary open access archive for the deposit and dissemination of scientific research documents, whether they are published or not. The documents may come from teaching and research institutions in France or abroad, or from public or private research centers.

L'archive ouverte pluridisciplinaire **HAL**, est destinée au dépôt et à la diffusion de documents scientifiques de niveau recherche, publiés ou non, émanant des établissements d'enseignement et de recherche français ou étrangers, des laboratoires publics ou privés.

1           **Thermodynamic performance's analysis of a cold production by hybrid compressor-based**  
2                           **thermochemical sorption processes using ammoniated salts.**

3  
4 PERRIGOT Antoine <sup>a,\*</sup>, PERIER-MUZET Maxime <sup>a,b</sup>, ORTEGA Pascal <sup>c</sup>, STITOU Driss <sup>a</sup>

5  
6 a CNRS-PROMES laboratory, Tecnosud, Rambla de la thermodynamique, 66100 Perpignan, France

7 b UPVD Université de Perpignan Via Domitia, 52 Avenue Paul Alduy, 66100 Perpignan, France

8 c GEPASUD Laboratory, University of French Polynesia, BP 6570, 98702 Tahiti, French Polynesia

9 \* Corresponding author : antoine.perrigot@promes.cnrs.fr

10  
11 **Keywords :** Hybrid thermochemical system, compressor, efficiency, cold production

12  
13 **Abstract**

14           Many developments in recent years concern the hybridization of sorption systems with a mechanical  
15 compressor. This paper presents an assessment study of different hybrid thermochemical systems used to ensure a cold  
16 production. A screening over more than 100 ammonia salts have been done to investigate the different compressor  
17 configurations. The compressor can be used to assist the decomposition phase, the synthesis phase or both phases.  
18 Two major points are tackled : the modification of the operating range and of the performances of such hybrid  
19 systems. This article is intended to be a thermodynamic tool for selecting the most suitable ammoniated salt and  
20 compressor operating configuration for a targeted cooling application. Compression-assisted decomposition has  
21 already been studied in the scientific literature for thermochemical systems, but not the compression-assisted synthesis  
22 for a low-temperature cold production. This latter hybridization extends the operating range of the thermochemical  
23 process quite the same way as the assisted decomposition but brings better average performances over the operating  
24 range compared to a fully thermally driven system, with higher COP (+8 %), exergetic efficiency (+2 %) and primary  
25 energy efficiency (+4 %). The possibility to use a compressor in both phases leads to very interesting performances  
26 over a largely extended operating range. In this case, the average exergetic efficiency can be 32 % higher than the  
27 average exergetic efficiency of a fully thermally driven system.

Variables		Acronyms, subscripts, and superscripts	
q	Specific heat ( $\text{J}\cdot\text{mol}^{-1}$ )	cond	Condensation
w	Specific mechanical work ( $\text{J}\cdot\text{mol}^{-1}$ )	vap	Vaporization/Vapor
T	Temperature (K)	liq	Liquid
P	Pressure (Pa)	synt	Synthesis
COP	Coefficient of performance	dec	Decomposition
$\overline{\text{COP}}$	Average COP	amb	Ambient
s	Specific entropy ( $\text{J}\cdot\text{mol}^{-1}\cdot\text{K}^{-1}$ )	is	Isentropic
h	Specific enthalpy ( $\text{J}\cdot\text{mol}^{-1}$ )	fus	Fusion
c	Molar heat capacity ( $\text{J}\cdot\text{mol}^{-1}\cdot\text{K}^{-1}$ )	comp	Compressor
<b>Greek symbols</b>		vol	Volumetric
$\Delta_r H^\circ$	Standard enthalpy of reaction ( $\text{J}\cdot\text{mol}^{-1}$ )	eq	Equilibrium
$\Delta_r S^\circ$	Standard entropy of reaction ( $\text{J}\cdot\text{mol}^{-1}\cdot\text{K}^{-1}$ )	ref	Reference
$\nu$	Stoichiometric coefficient	$S_0$	Salt discharged in gas
$\theta$	Carnot factor	$S_1$	Salt charged in gas
$\Delta T$	Temperature gap (K)	$T_{\text{cold}}$	Cold temperature
$\eta_{\text{ex}}$	Exergetic efficiency	$T_{\text{hot}}$	Hot temperature
$\overline{\eta_{\text{ex}}}$	Average exergetic efficiency	$T_{\text{amb}}$	Ambient temperature
$\eta_{\text{pri}}$	Primary energy efficiency	$T_{\text{reac}}^{\text{dec}}$	Reactor temperature in decomposition
$\overline{\eta_{\text{pri}}}$	Average primary energy efficiency	$T_{\text{evap}}$	Evaporation temperature
$\gamma$	Adiabatic index		

29

30 **1. Introduction**

31 With the incoming climate change, there is an emergency to reconsider our relationship to energy. Producing  
32 energy from renewable sources will help, but storage solutions must be found to compensate the intermittency of solar  
33 or wind energy. At the same time, it is essential to preserve our primary energy resource by improving the efficiency  
34 of energy transformation systems. Nevertheless, even with efficient systems, a part of the initial energy is transformed  
35 into heat. According to [1], 72% of the global primary energy consumption is lost and transformed into heat with 63%  
36 of this heat being rejected under 100 °C. Moreover, around 20% of all the electricity produced in the world is  
37 consumed for refrigeration and air-conditioning processes of various kinds, according to [2]. Most of this demand is  
38 being met by using Mechanical vapor compression systems powered by electricity from the grid.

39 Thermochemical system can help to solve the aforementioned issues because they have several interesting  
40 characteristics. First, a thermochemical system provides a natural storage function in the form of a chemical potential.  
41 Among thermal energy storage systems, thermochemical has the highest energy density and the longest period of  
42 storage compared to sensible and latent heat storage according to [3]. In addition, thermochemical systems can be  
43 driven by heat at temperatures lower than 100 °C which is interesting to upgrade low-graded wasted heat.  
44 Nevertheless, fully thermally driven systems, i.e. systems that only use thermal energy, are not widely spread in the

45 industry because of their still high cost and their low performances compared to conventional mechanical vapor  
46 compression systems. In recent years, the research focuses on hybrid thermochemical systems to design more flexible  
47 and efficient systems.

48 Indeed, despite the initial advantage of only using heat to drive the system, much research over the past twenty  
49 years have studied hybrid sorption systems by adding an electrically driven compressor. Liquid/gas absorption–  
50 compression cycles have already been widely studied in the scientific literature and has shown some advantages. The  
51 cooling or heating capacity is increased, the operating range can be extended and an improved COP and primary  
52 energy ratio can be achieved. A recent review made in 2019 [4] about hybrid sorption systems mentioned 22 scientific  
53 articles about absorption-compression systems. Many compressor configurations have been studied for these systems  
54 among which the compressor is placed either between the evaporator and the absorber, or between the generator and  
55 the condenser, or between the low- and high-pressure stages or between the absorber and the generator.

56 Regarding solid/gas sorption systems, the literature is less extensive than for absorption systems. A first study  
57 carried out in 1997 [5] presents a screening of hydride salts of interest to be implemented, and estimates the  
58 mechanical COP of the overall system that can be obtained. The mechanical COP is defined as the ratio between the  
59 cold produced by the thermochemical process and the mechanical work required to drive the compression. This hybrid  
60 system consists of two reactors containing the same metal hydride salt and connected throughout a compressor.  
61 Hydrogen is sucked out from the fully charged reactor by the compressor, allowing an endothermic reaction with a  
62 cooling effect that can reduce the temperature of the room where the reactor is located. For the 26 salts studied in that  
63 work, the maximum mechanical COP that can be reached is 4.4 with a compression ratio of 6.6. One of these salts is  
64 further explored in [6] and corroborate the theoretical evaluation of the specific cooling capacity, but the COP has not  
65 been experimentally determined. A similar compressor implementation has been experimentally studied in [7], [8].  
66 The metal hydride  $Zr_{0.9}Ti_{0.1}Cr_{0.55}Fe_{1.45}$  is used in both reactors. With a room maintained at 27 °C and a half-cycle time  
67 of 3 minutes, the reactor in desorption phase allowed the air taken from the room to be cooled to 6 °C at the outlet.  
68 The maximal COP reached by this system is 1.8. Exergetic considerations are brought by [9] where each potential  
69 source of irreversibility is studied : thermal pinches in heat exchanger, pressure drops in pipes, isentropic efficiency of  
70 the compressor or the ratio between the implemented salt mass and the reactor mass. Two salts are considered and for  
71 realistic operating conditions, the obtained COP are respectively 2.77 and 2.96 for a cold temperature of 7 °C. The  
72 exergetic efficiency is evaluated to 0.21 and 0.22. The authors conclude that the major sources of irreversibility are  
73 linked to the thermal pinches in heat exchangers and the isentropic efficiency of the compressor.

74           Regarding ammonia-based hybrid systems, Ferrucci et al. [10] carried out a theoretical study of a compressor  
75 implementation to assist the desorption phase of a thermochemical process. Such an implementation reduces the  
76 minimal temperature required for the desorption of ammonia from the charged salt, in this case the octaammoniate of  
77 barium chloride ( $\text{BaCl}_2 \cdot 8\text{NH}_3$ ) that decomposes into barium chloride salt ( $\text{BaCl}_2$ ). This compressor assistance may  
78 even allow the desorption to take place at room temperature. This study is focused on the impact of the compressor  
79 efficiency and the thermal pinches in heat exchanger. The mechanical COP and the exergetic efficiency of the system  
80 are respectively about 2.2 and 0.11, for a desorption reaction occurring at ambient temperature ( $25^\circ\text{C}$ ) with thermal  
81 pinches of 10K and a compressor isentropic efficiency of 0.7. Fito et al. [11] led an experimental study of a similar  
82 hybrid thermochemical process implementing the same salt with the same compressor configuration, demonstrating  
83 the feasibility of such a hybridization and its interest for lowering the desorption temperature. Other hybrid  
84 thermochemical systems based on ammoniated salts that can be found in the literature [12]–[17], mainly target heating  
85 applications and are not really in the scope of the study presented here that focuses on cooling and deep freezing  
86 applications, using low temperature heat.

87           In this paper, a screening of more than one hundred different ammoniated reactive salts is carried out. Three  
88 different compressor-assistance configurations are described, evaluated and compared to a fully thermally driven  
89 system to be a thermodynamic tool for selecting the most suitable ammoniated salt and compressor operating  
90 configuration for a targeted cooling application. In addition, it highlights the benefits of such a hybrid system using a  
91 compressor, in particular the increased operability of the system over a wider range of temperature and the  
92 improvement of cooling performances.

93           All in all, 4 types of thermochemical systems are studied in this article : a fully thermally driven system, a  
94 system with a compressor-assisted decomposition, another with a compressor-assisted synthesis and a last system  
95 where both phases are assisted by a compressor. These 4 systems are compared between each other to discuss the  
96 evolution of the temperature operating range and the system performances in function of the compressor usage.

97           At our knowledge, the compressor assisted synthesis has not yet been deeply studied for thermochemical  
98 system used to ensure a cold production. The compressor could then be used to adjust the synthesis pressure and  
99 produce cold at a given level of temperature below its initial limitation. Besides promising performances, which will  
100 be described later in this article, such a system could be interesting for several reasons. First, as synthesis and  
101 decomposition never occurred at the same time, there is the possibility to use only one compressor for both phases. In  
102 addition, the flexibility brought by the compressor in synthesis could lead to an even more flexible system that can

103 produce several levels of cold temperature. Finally, because most of cold loads require the cold production during the  
104 sunny period, there could be a way to produce the electricity consumed by the compressor with photovoltaic panels.

105 Three indicators are used to evaluate system performances, the coefficient of performance (COP), the  
106 exergetic efficiency ( $\eta_{ex}$ ) and the primary energy efficiency ( $\eta_{pri}$ ). The computation of this 3 performances indicator  
107 is described later in this paper.

108 This paper is structured as follows: hybrid thermochemical systems are presented in the following part. Part 3  
109 is dedicated to the presentation of the different models used to conduct these studies and their associated hypothesis.  
110 Part 4 is a discussion about studies results, which concerns on the one hand the modification of the operating range  
111 and on the other hand the alteration or enhancement of performances. Finally, a conclusion is reached in Part 5.

## 112 2. Systems presentation

### 113 2.1. General presentation of thermochemical processes

114 A thermochemical system is based on the reversible solid-gas reaction shown by equation (1). This reaction  
115 between a salt and a reactive gas takes place in a single fixed-bed reactor.



116 The left to right direction in equation (1) corresponds to the synthesis phase where one mole of the desorbed  
117 salt ( $S_0$ ) reacts with  $\nu$  moles of gas (G) to form the synthesized salt ( $S_1$ ).  $\Delta_r H^\circ$  is the standard enthalpy of reaction and  
118 corresponds to the rejected heat when a mole of gas is absorbed by the salt during the synthesis reaction. The right to  
119 left direction corresponds to the decomposition phase, which is an endothermic reaction.

120 This reaction is monovariant so if one intensive parameter is fixed, temperature or pressure for example, the  
121 other one will adjust to get back to the equilibrium state. The equilibrium can be described in a first approximation  
122 with the Clausius-Clapeyron equation as shown in (2).

$$P_{eq} = P_{ref} \cdot \exp\left(\frac{\Delta_r H^\circ}{R} - \frac{\Delta_r S^\circ}{R \cdot T_{eq}}\right) \quad 2)$$

123 In this equation,  $P_{eq}$  is the equilibrium pressure of the reaction taking place at the temperature  $T_{eq}$ .  $\Delta_r H^\circ$  and  
124  $\Delta_r S^\circ$  represent respectively the enthalpy and entropy of reaction in the standard conditions ( $P_{ref} = 1$  bar and  $T_{ref} =$   
125  $25^\circ\text{C}$ ). Thermodynamic constraints in pressure and temperature different from those corresponding to equilibrium  
126 must be imposed on the salt for the reaction to take place.

127 An example of reaction between the barium chloride ( $\text{BaCl}_2$ ) and the ammonia ( $\text{NH}_3$ ) is presented in equation  
128 (3). This salt has been chosen as a common thread in this paper because it has already been used in experimental  
129 systems including hybrid system with compressor [11] or deep-freezing process [18]. In addition, as it will be exposed  
130 later in this article, this salt appears has the “best salt” in many compressor configurations and for different operating  
131 ranges.

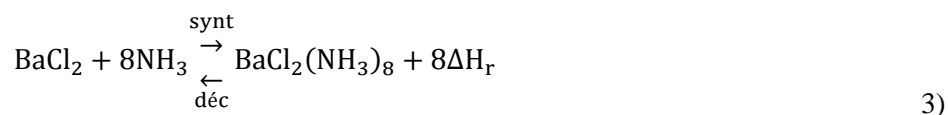

132 By coupling such a solid/gas reaction with a liquid/gas phase change of the same gas, a cooling process can be  
133 designed. In addition to the reactor, a condenser and an evaporator complete the system.

134 Let’s first describe the two phases (decomposition and synthesis) with and without compressor. For the sake  
135 of clarity, operating points are represented at equilibrium and no temperature pinches have been considered.

136 The decomposition of the fully thermally driven system is depicted in Figure 1. The temperature inside the  
137 condenser is fixed by the thermal exchange with the environment. With the knowledge of the ambient temperature and  
138 the temperature pinch it is possible to estimate the condenser temperature. Because the kinetic of condensation is  
139 much higher than the kinetic of the chemical reaction the condenser can be supposed at equilibrium because once gas  
140 entered the condenser it is almost immediately liquefied so pressure does not increase. When heat is brought to the  
141 reactor its temperature increases ( $0 \rightarrow 1$ ). Because only one intensive parameter is fixed during this phase, the reactor  
142 remains at equilibrium and pressure is increasing as well. When the reactor reaches the condensation pressure, it is  
143 submitted to a double constraint : the temperature is imposed by the heat exchange with the heat source and the  
144 pressure is imposed by the condenser. The decomposition reaction occurs because the system is outside of its  
145 equilibrium and the released gas flows towards the condenser ( $1 \rightarrow 2$ ) where it is liquefied. The liquid is then stored in  
146 a tank at ambient temperature.

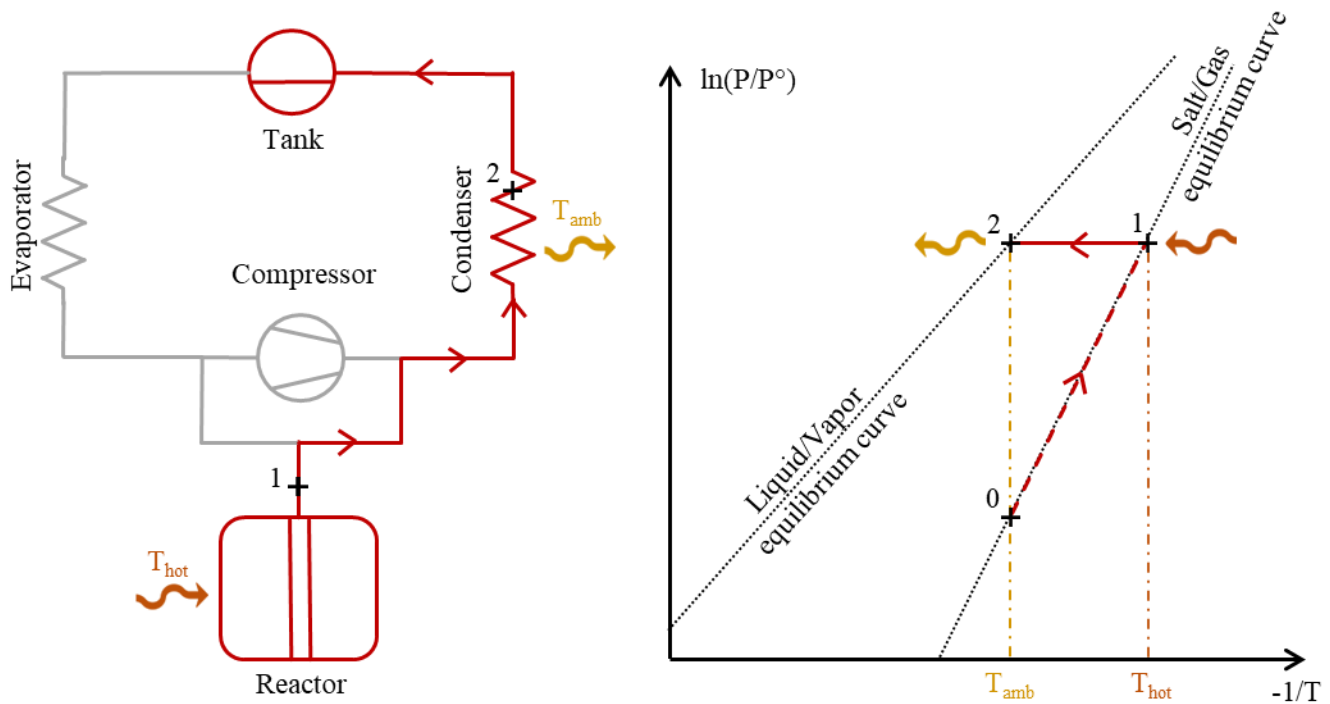

147

148 *Figure 1 : Scheme of the thermal decomposition (left) and representation in the Clausius-Clapeyron diagram (right).*

149 The assisted decomposition is represented in Figure 2. When the heat source temperature is not sufficient to  
 150 reach the condensation pressure ( $0 \rightarrow 1$ ), a compressor can be added between the reactor and the condenser. The  
 151 compressor inlet is at reactor pressure and the outlet at condenser pressure. The compression ( $1 \rightarrow 2$ ) leads potentially  
 152 to a high outlet temperature so it can be necessary to cool down the gas in a heat exchanger before entering the  
 153 compressor (not represented here).



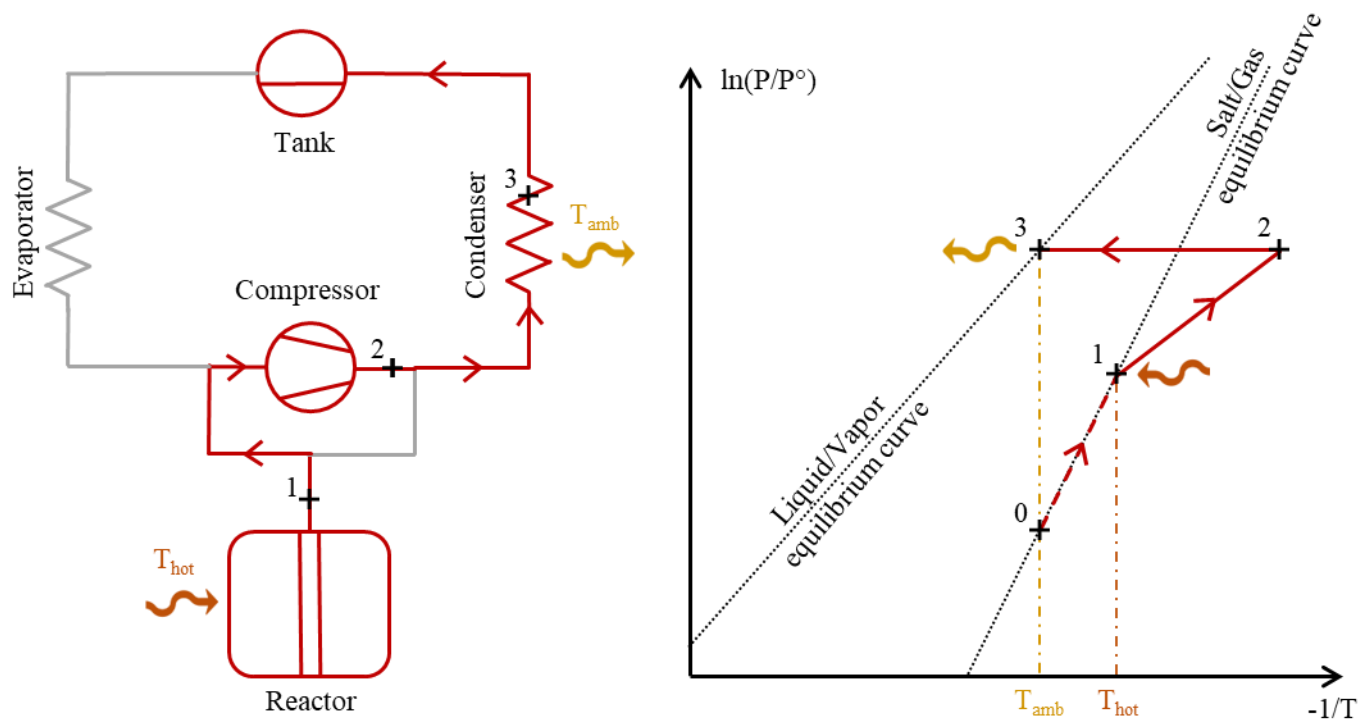

154

155

Figure 2 : Scheme of a compressor-assisted decomposition (left) and representation in the Clausius-Clapeyron diagram (right).

156

157

158

159

160

In the classical synthesis (without compressor), represented on Figure 3, the liquid stored in the tank goes through a throttling valve to decrease its pressure up to the evaporation pressure (1 → 2). This pressure is fixed by the heat exchange between the evaporator and the cold room. The evaporated gas entered the reactor (2 → 3) where the double constraints in temperature and pressure enable the synthesis to take place.

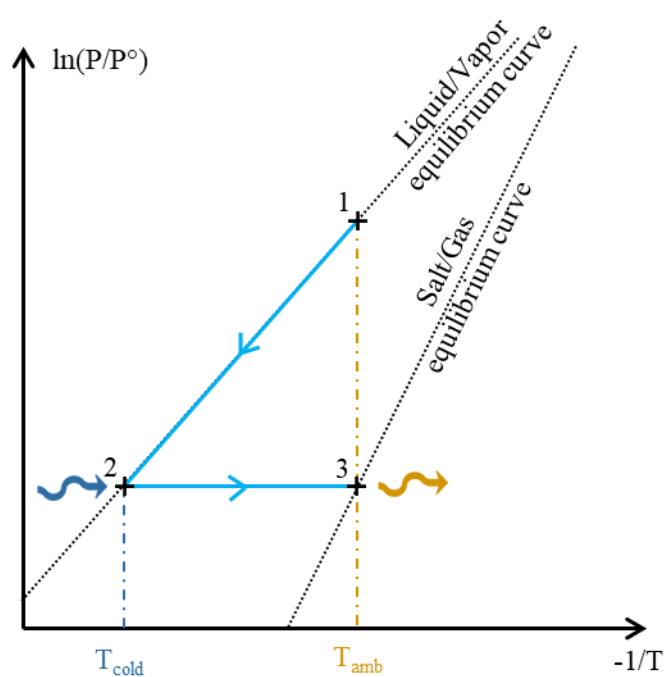
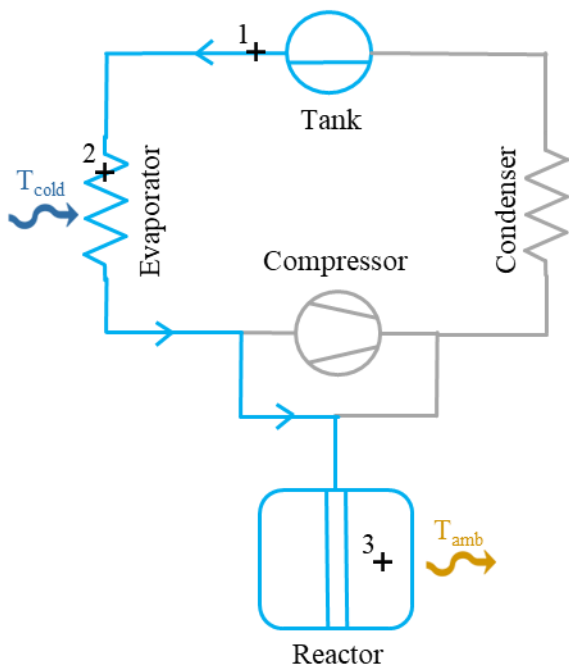

161

162

Figure 3 : Scheme of a classical synthesis (left) and representation in the Clausius-Clapeyron diagram (right).

163

164

165

166

167

168

The assisted synthesis is represented on Figure 4. As in the fully thermally driven synthesis phase, the liquid pressure is decreased to the evaporation pressure ( $1 \rightarrow 2$ ). Nevertheless, the addition of a compressor in the synthesis phase enable to produce cold at lower temperature because the difference between the evaporation and synthesis pressures can be filled with the compressor. Because the compressor can be damaged if it remains liquid at the inlet, it is necessary to ensure an overheating of the gas between the evaporator and the compressor ( $2 \rightarrow 3$ ). The gas is then compressed ( $3 \rightarrow 4$ ) and the double constraint in pressure and temperature enable the synthesis at point 5.

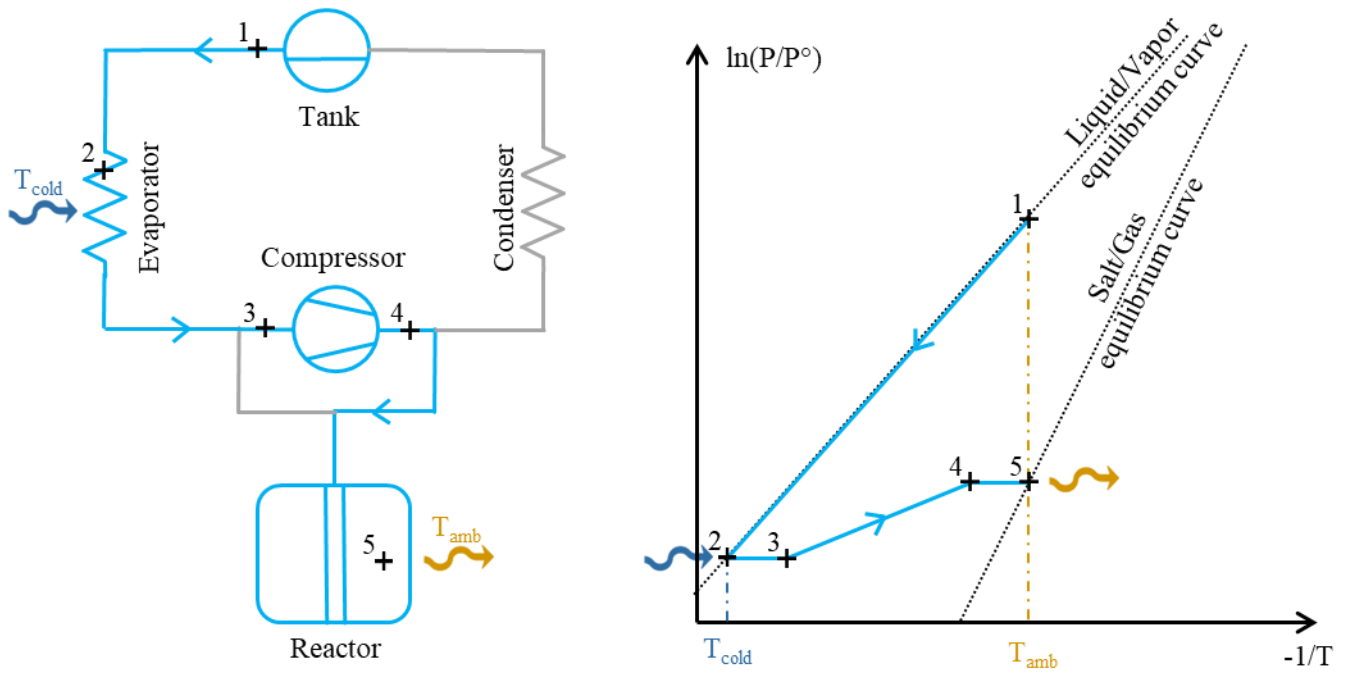

Figure 4 : Scheme of a compressor-assisted synthesis (left) and representation in the Clausius-Clapeyron diagram (right).

## 2.2. Thermodynamic paths of a two compressions system

To enhance the comprehension of a 2 compressions thermochemical system, the thermodynamic cycle is depicted on 3 different thermodynamic diagrams :

- The Clausius-Clapeyron diagram (Figure 5) represents the pressure in function of the temperature. Both equilibrium curves for the chemical reaction and the phase state change are represented by straight lines on this diagram but saturation curves are superposed. Thus, some operating points of the cycle are merged.
- The Mollier diagram (Figure 6) represents the pressure in function of the specific enthalpy. Saturation curves of the phase state change are no more superposed in this diagram. With the methodology proposed in [19], it is possible to compute and display both curves representing respectively the desorbed ammonia in equilibrium with the salt and the sorbed ammonia in equilibrium with the salt. The latter is a virtual curve representing the thermodynamic properties of sorbed ammonia in equilibrium with the salt as it was pure ammonia. Even if this curve is in the liquid domain, ammonia is actually in the gaseous form, sorbed in the salt. Because this curve is a virtual one, it has been plotted with a dotted line while 3 other curves are plotted with a solid line. Isothermal curves of pure ammonia are represented with the slightly dashed grey lines.

- 188
- The temperature-entropy diagram (Figure 7) shows the temperature as a function of the specific entropy.
- 189 As with the Mollier diagram, the saturation curves are distinct and equilibrium curves between ammonia  
190 and the salt have been plotted. The curve representing sorbed ammonia in equilibrium with the salt is  
191 plotted with a dashed line for the same reason as for the Mollier diagram. Isobaric curves for pure  
192 ammonia are represented by slightly dashed grey lines.

193 The salt considered in this example is  $\text{BaCl}_2(8/0)$  which reacts with  $\text{NH}_3$  to form  $\text{BaCl}_2(\text{NH}_3)_8$  as mentioned in  
194 equation (3). The cold temperature is the evaporation temperature ( $-35\text{ }^\circ\text{C}$ ). The ambient temperature is the  
195 environment temperature ( $25\text{ }^\circ\text{C}$ ), and the hot temperature is the temperature of the reactor during the decomposition  
196 ( $60\text{ }^\circ\text{C}$ ). It is worth noticing that no temperature pinches have been considered for the different heat exchange. As  
197 described earlier in this article, it is necessary to be outside of the equilibrium state for the reaction to take place.  
198 Nevertheless, operating points are represented at equilibrium here for the sake of simplicity. In addition, it has been  
199 considered no pressure losses in pipes and heat exchangers and an isenthalpic pressure drop between the tank and  
200 evaporator. An isentropic efficiency of 0.7 has been considered for both compressions.

201 Because points are considered at equilibrium, it is possible to compute the condensation pressure with the  
202 Clausius-Clapeyron equation described earlier (equation (2)). The obtained condensation pressure is about 10 bar.  
203 Nevertheless, with a reactor at  $60\text{ }^\circ\text{C}$ , the pressure inside the reactor is about 9.0 bar which is not enough. For this  
204 reason, a compressor is used.

205 During the synthesis, the reactor is at ambient temperature because the heat released by the reaction is  
206 evacuated towards the environment and no temperature pinch has been considered. The synthesis pressure is then at  
207 1.8 bar. The evaporation temperature at this pressure will be about  $-21\text{ }^\circ\text{C}$ . To have a lower evaporation temperature, a  
208 compressor is used to decrease the evaporation pressure to 0.9 bar to have an evaporation temperature about  $-35\text{ }^\circ\text{C}$ .

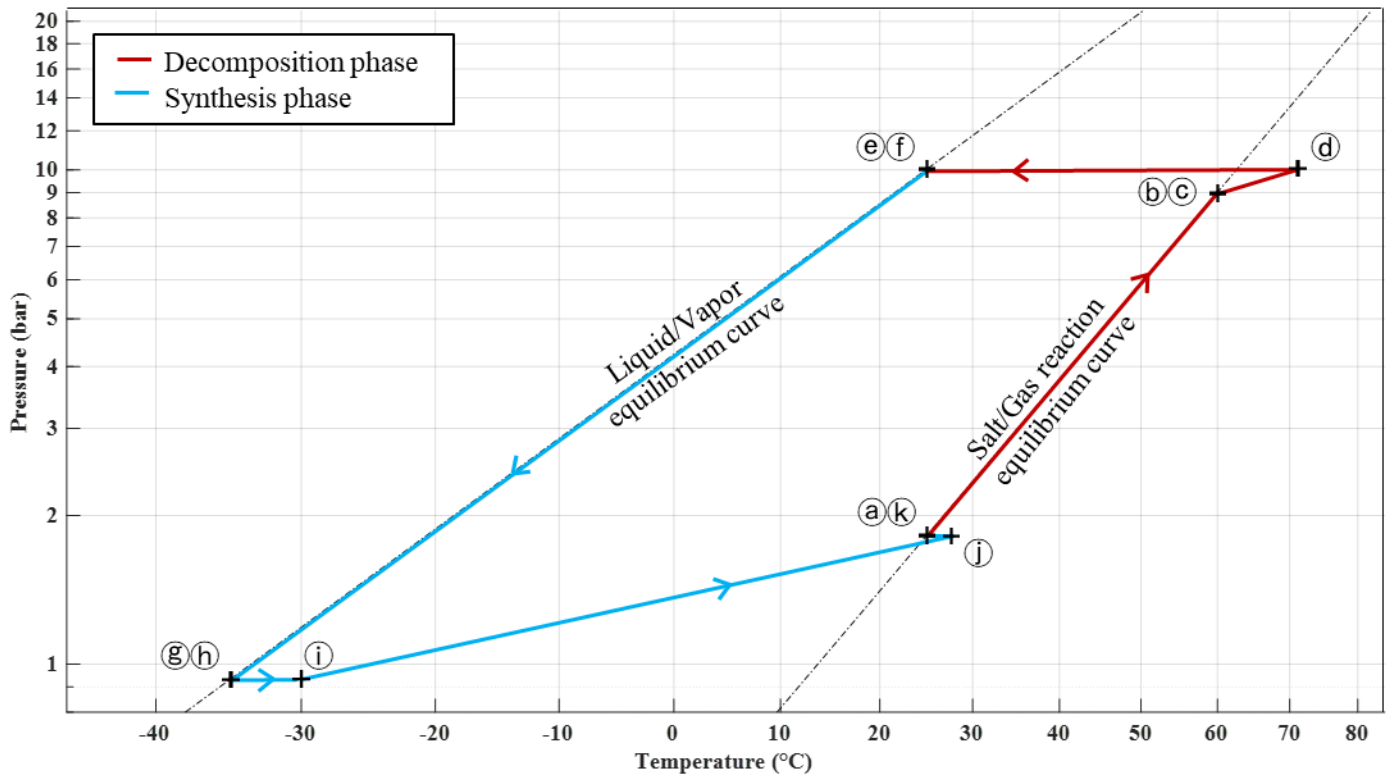

209

210

Figure 5 : Clausius-Clapeyron diagram of a hybrid system including a compressor assisted decomposition and

211

synthesis. Decomposition phase ( $(a) \rightarrow (f)$ ) is represented in red and synthesis phase ( $(f) \rightarrow (a)$ ) in blue.

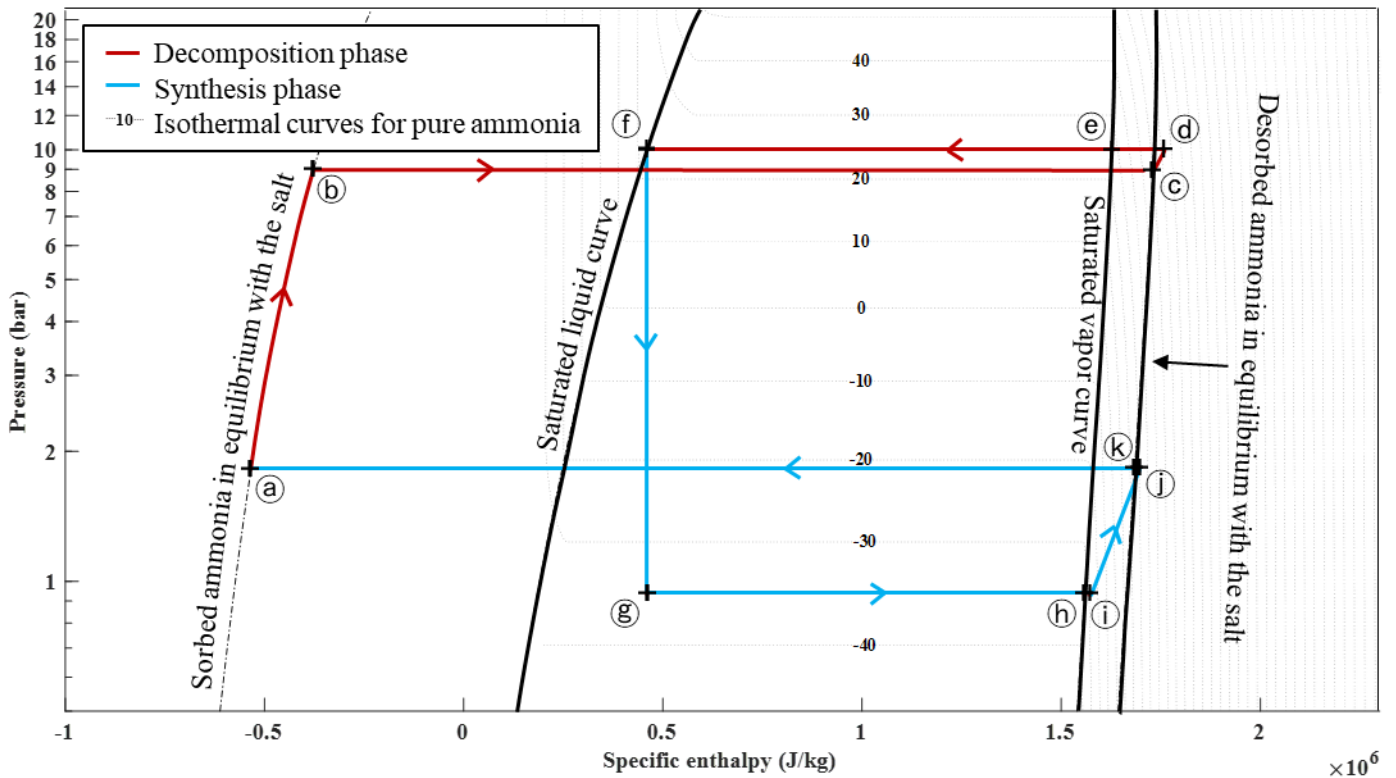

212

213

Figure 6 : Mollier diagram of a hybrid system including a compressor assisted decomposition and synthesis.



- $\text{c} \rightarrow \text{d}$  : The compressor raised the desorbed gas to the condensation pressure. A process with an isentropic efficiency of 0.7 has been considered.
- $\text{d} \rightarrow \text{e}$  : The gas at the outlet of the compressor is cooled until it reaches condensation temperature. This is considered as an isobaric process.
- $\text{e} \rightarrow \text{f}$  : The gas is condensed. This process is isothermal and isobaric. The liquid is then stored at ambient temperature.

The second step ( $\text{f} \rightarrow \text{a}$ ) correspond to the cold production phase which occurs during the synthesis phase (in blue). This step is sometimes referred as discharging phase because the stock of ammonia is used for the cold production :

- $\text{f} \rightarrow \text{g}$  : Liquid ammonia is drawn from the tank. The liquid pressure decreased down to the evaporation pressure thanks to a throttling valve. This process is supposed to be isenthalpic.
- $\text{g} \rightarrow \text{h}$  : The liquid is vaporized inside the evaporator. This reaction is endothermic and absorbs heat.
- $\text{h} \rightarrow \text{i}$  : The gas at the outlet of the evaporator is superheated about  $5^\circ\text{C}$  to ensure a saturated vapor in the compressor.
- $\text{i} \rightarrow \text{j}$  : The gas is compressed up to the synthesis pressure.
- $\text{j} \rightarrow \text{k}$  : The gas returns towards equilibrium conditions thanks to a heat transfer.
- $\text{k} \rightarrow \text{a}$  : The gas is absorbed by the salt because the reactor is outside of its equilibrium. The pressure is fixed by the compressor and the temperature by the heat exchange between the reactor and the environment. This transformation is isobaric and isothermal.

### 3. Hypothesis and models

For the computation of performance criteria all operating points have been taken at equilibrium, no temperature pinches in heat exchangers and no pressure losses have been considered. These hypotheses seem necessary in such a theoretical study because these parameters are strongly dependent of the manufacture of the system : the nature of the fluid in the heat exchanger, the heat transfer in the reactor or the bending of pipes for example. The results which are presented in this article are then purely theoretical and the real performances of such hybrid systems will necessary be lower.

### 3.1. Performance indicators

Three energy quantity are necessary to characterize the system :

- $q_{\text{cold}}$  represents the heat absorbed in the evaporator by mole of evaporated gas. This corresponds to the cold production.
- $q_{\text{hot}}$  is the heat consumed by the system from the hot source to decomposed one mole of gas.
- $w$  represents the work needed to compress one mole of gas.

Three different indicators are used for assessing the systems performances in this study :

- The **coefficient of performance** (COP) which is defined by the ratio between the useful effect ( $q_{\text{cold}}$ ) and the energies consumed to drive the system ( $w$  and  $q_{\text{hot}}$ ) as shown by equation (4) :

$$\text{COP} = \frac{q_{\text{cold}}}{w + q_{\text{hot}}} \quad (4)$$

Because the heat consumed to drive the desorption is often low-graded wasted heat, the term  $q_{\text{hot}}$  is sometimes removed from the computation of the COP to obtain what is often called the mechanical COP. Nevertheless, by considering this, the COP of a fully thermally driven system is infinite and the comparison with other systems is then impossible.

- The **exergetic efficiency** ( $\eta_{\text{ex}}$ ). The main defect of the previous indicator is that it does not take into account the energy quality. Indeed, electricity, such as the one used to drive the compressor is more valuable than a heat source from which it is impossible to extract all the energy. It is more interesting to handle the cold production with a poor-quality energy such as low-grade waste heat than mechanical work provided by electricity. To take this into account, the exergetic efficiency has been used to compare systems. This indicator defined by the ratio between the exergy of the useful effect ( $\text{Ex}_{\text{cold}}$ ) and the exergies consumed to drive the system ( $w$  and  $\text{Ex}_{\text{hot}}$ ) can be computed with (5) :

$$\eta_{\text{ex}} = \frac{\text{Ex}_{\text{cold}}}{w + \text{Ex}_{\text{hot}}} = \frac{q_{\text{cold}} \cdot \theta_{\text{cold}}}{w + q_{\text{hot}} \cdot \theta_{\text{hot}}} \quad (5)$$

Where  $\theta_{\text{cold}}$  and  $\theta_{\text{hot}}$  are Carnot factors defined by (6):



$$\begin{cases} \theta_{\text{cold}} = \frac{T_{\text{amb}}}{T_{\text{cold}}} - 1 \\ \theta_{\text{hot}} = 1 - \frac{T_{\text{amb}}}{T_{\text{hot}}} \end{cases} \quad 6)$$

- The **primary energy efficiency** ( $\eta_{\text{pri}}$ ). Another way to consider the energy quality difference between electricity and thermal energy is to consider the primary energy efficiency. A coefficient of transformation is applied to consider the transformation between primary energy and final energy. European authorities consider a coefficient about  $\beta = 2.5$  meaning that the production of 1kWh of electricity in Europe requires 2.5kWh of primary energy. Then a primary energy efficiency can be used as shown by equation (7) :

$$\eta_{\text{pri}} = \frac{q_{\text{cold}}}{\beta \cdot w + q_{\text{hot}}} \quad 7)$$

## 3.2. Energy computation

To estimate performances of thermochemical systems it is necessary to compute the different energies at stake in the process. There are 3 main energy flux in hybrid thermochemical systems. Thermal energy at high temperature  $q_{\text{hot}}$  and electrical energy  $w$  are used to drive the system. The system provides in return a useful effect in the form of cold thermal energy  $q_{\text{cold}}$ . Equations to compute these 3 amounts of energy are presented below.

### 3.2.1. Mechanical work of the compressor

To compute the mechanical work needed to compress the gas from  $P_{\text{in}}$  to  $P_{\text{out}}$ , the isentropic compression work is first computed. The first law of thermodynamic is applied considering a steady state and adiabatic compression as shown by equation (8) :

$$w_{\text{comp}}^{\text{is}} = h_{\text{out, is}}(P_{\text{out}}, s_{\text{in}}) - h_{\text{in}}(P_{\text{in}}, T_{\text{in}}) \quad 8)$$

In this model  $P_{\text{in}}, P_{\text{out}}, T_{\text{in}}$  only depend on the temperatures  $T_{\text{cold}}, T_{\text{hot}}$  and  $T_{\text{amb}}$  because everything is considered at equilibrium. Thermodynamic tables such as *CoolProp* have been used to compute the enthalpies and entropies that are unknown.

To compute the real compression work a constant isentropic efficiency ( $\eta_{\text{is}} = 0.7$ ) is considered. By definition, this efficiency can be expressed as shown by equation (9) :

$$\eta_{is} = \frac{w_{comp}^{is}}{w_{comp}} \quad 9)$$

Finally, the computation of the compression work can be computed as described by equation (10) :

$$w_{comp} = \frac{h_{out,is}(P_{out}, s_{in}) - h_{in}(P_{in}, T_{in})}{\eta_{is}} \quad 10)$$

Because this paper is a preliminary thermodynamic study, compressors technologies have not been taken into account. This is why the isentropic efficiency has been taken as a constant average value of 0.7, no further efficiencies have been considered for the compressor, meaning that perfect mechanical and electrical transformations are considered. In addition, a volumetric efficiency is usually defined to consider the diminution of gas drawn in when the compression ratio increases. The computation of the volumetric efficiency requires the knowledge of the clearance ratio of the compressor, i.e. the ratio of the dead volume to the swept volume and  $\gamma$  is the adiabatic index. Nevertheless, the volumetric efficiency has a small impact with small ratio of compression. For an ideal gas ( $\gamma = 1.4$ ) and a typical clearance of 2% the volumetric efficiency is above 95% for a compression ratio of 5 [20]. That is why the volumetric efficiency is not considered in this study where the maximum compression ratio has been limited to 5, which is a common value for a single stage compressor.

### 3.2.2. Cold production at the evaporator

The thermal energy absorbed by mole of evaporated gas can be computed thanks to the equation (11) :

$$q_{cold} = h_{in,evap}(P_{vap}, T_{vap,in}) - h_{out,evap}(P_{vap}, T_{vap,out}) \quad 11)$$

Considering an isenthalpic expansion between the ammonia tank and the evaporator, the enthalpy at the evaporator inlet is equal to the enthalpy of the saturated liquid at ambient temperature.  $h_{in,evap}(P_{vap}, T_{vap,in}) = h_{sat}(T_{amb})$ . This value can be computed using thermodynamic tables. There is a need to have superheated vapor at the outlet of the evaporator to safely use the compressor without liquid fraction in the gas. An overheating of  $\Delta T_{superheat} = 5^{\circ}C$  has been considered. Then the outlet temperature can be computed with (12) :

$$T_{vap,out} = T_{cold} + \Delta T_{superheat} \quad 12)$$

### 3.2.3. Thermal energy to drive the decomposition of the reactor

The reactor is initially considered at ambient temperature in the decomposition step. Sensible heat is first used to raise the reactor temperature. Heat is then used to drive the decomposition. The total amount of heat provided to the reactor to desorb one mole of gas is the sum of these two quantities and is computed with equation (13):

$$q_{\text{hot}} = c \cdot (T_{\text{hot}} - T_{\text{amb}}) + \Delta_r H^\circ \quad (13)$$

Where  $c$  is the molar thermal capacity of the reactor. In this study, only the thermal capacity of the synthesized salt has been considered because the thermal capacity of the whole reactor depends on the nature of the reactive mixture, the material used to build the reactor and the geometry of the reactor. Nevertheless, this approximation has a very small impact on results because major part of the heat brought to the reactor is used for the desorption.

### 3.3. Operating conditions and bounds of the study

The temperature range of the study has been limited to the interval  $T \in [-50^\circ\text{C}; 150^\circ\text{C}]$ . The lower limit has been decided to keep a gap with the fusion temperature of ammonia ( $T_{\text{fus}} = -77^\circ\text{C}$ ) and because there are not many industrial applications requiring cold below  $-50^\circ\text{C}$ . The upper limit has been chosen because these types of hybrid system are intended to use low-graded wasted heat. The ambient temperature is taken at  $T_{\text{amb}} = 25^\circ\text{C}$ .

In addition, to avoid operating in pressure ranges where mass transfer phenomena are limiting inside the reactor, it is necessary to maintain a pressure above 0.5 bar. This hypothesis is quite easy to make if expanded natural graphite is used and if gas diffusers are correctly dispatched in the reactive mixture [21].

For these different reasons, any salt which does not appear in the scope defined by these constraints is excluded from the study as shown by Figure 8. The initial list of 103 ammoniated salts has been reduced to 84 different salts. Thermodynamic properties of these ammoniated salts have been partially extracted from [22] and from the past experiences of the PROMES laboratory.

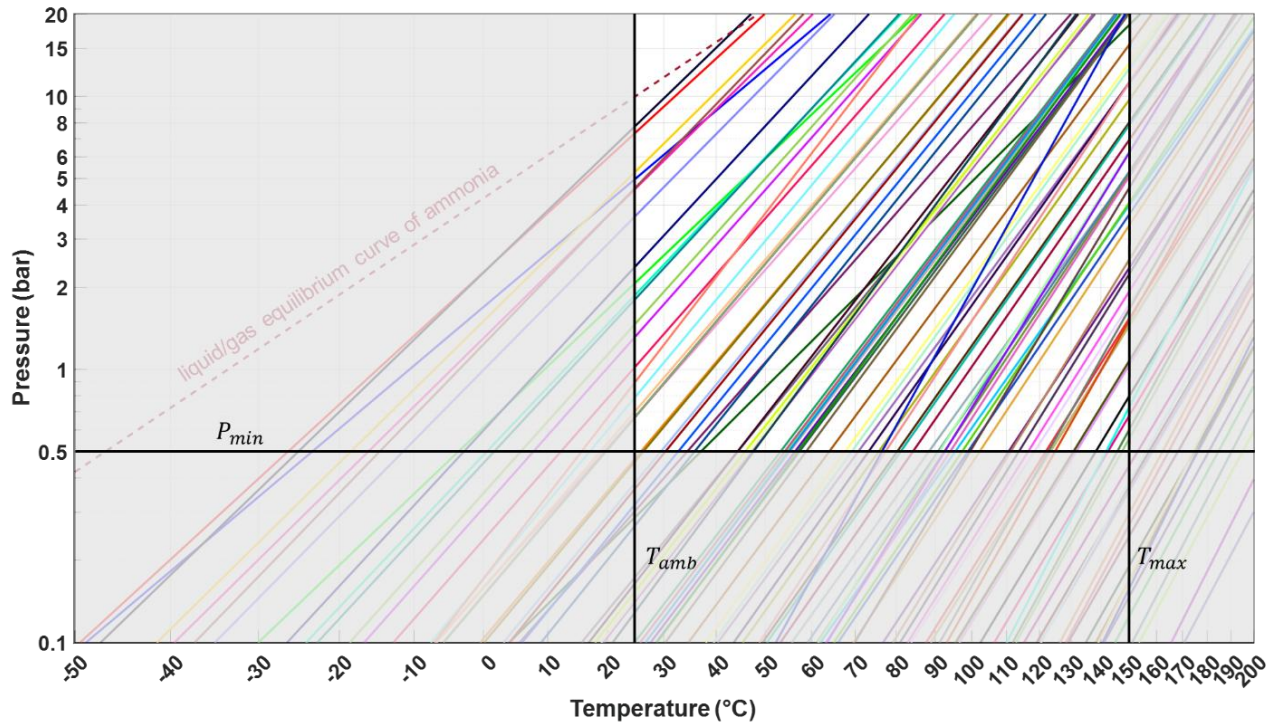

Figure 8 : Salts selection method with the temperature and pressure defined for the study.

It is also essential to keep in mind that no other constraints have been considered as melting point of the salt, environmental impacts, dangerousness or even the ease of use of the salt. Some salts presented here could potentially be unusable on some temperature or pressure range, but this study wanted to remain the more general as possible.

#### 4. Discussion and results

##### 4.1. Extension of the operating range thanks to the compressor

For a thermochemical system used for cold production, the operating range is defined by the whole couple of temperature ( $T_{hot}$ ,  $T_{cold}$ ) for which the system can operate. Because no temperature pinches have been considered in this study, the hot source temperature  $T_{hot}$  is equal to the reactor temperature in decomposition  $T_{react}^{dec}$  and the cold temperature  $T_{cold}$  is equal to the evaporation temperature  $T_{evap}$ . As said in the previous part, this study is limited to a maximum compression ratio of 5. Figure 9 shows an example of operating range evolution as a function of the compressor usage for the salt  $BaCl_2(8/0)$ .

It can be seen on Figure 9 that it is necessary to have the reactor operating above  $63^{\circ}C$  to drive the decomposition and it is impossible to evaporate ammonia below  $-21^{\circ}C$  without the assistance of a compressor (point A). If a compressor is used in decomposition, it is possible to desorb gas with a reactor maintained at  $27^{\circ}C$  (point B). The compressor assisted synthesis enables an evaporation temperature up to  $-52^{\circ}C$  (Point C). Finally, with a compressor in both phases, the system can evaporate ammonia at  $-52^{\circ}C$  with a reactor maintained at  $27^{\circ}C$  during the

353 decomposition (point D). Of course, this enhancement of the operating range is done by consuming mechanical energy  
 354 for the compression work. This leads to a lower COP, about -20% between the maximum COP and the COP at point  
 355 D.

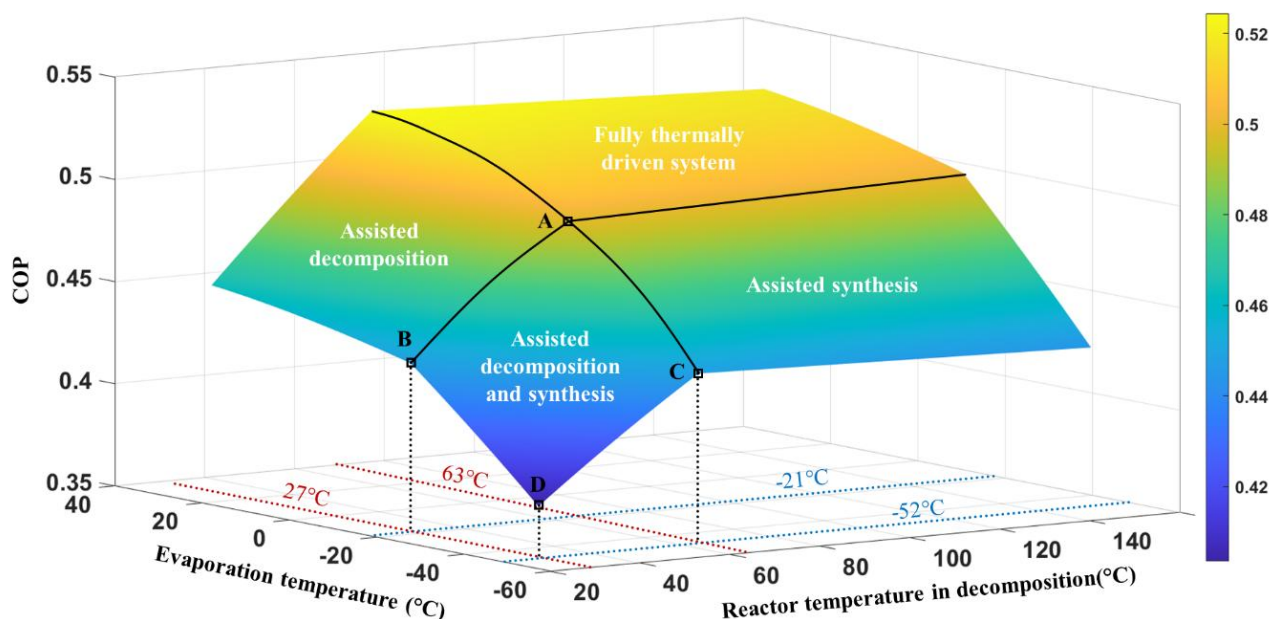

356

357 *Figure 9 : Evolution of BaCl<sub>2</sub>(8/0) COP for different compressor configuration in function of the reactor temperature*  
 358 *in decomposition and the evaporation temperature.*

359

360 It is worth noticing now that the presented limit temperatures will be quite different considering temperature  
 361 pinches and deviation from equilibrium. To have an overview, Table 1 shows the hot source temperature to have to  
 362 produce a certain cold temperature level for different pinches. temperature to apply to the reactor in decomposition  
 363 and the cold temperature for different pinches. In this table, the case without temperature pinches discussed previously  
 364 is retrieved where it is possible to produce cold at -21°C with a hot source at 63°C. Nevertheless, with temperature  
 365 pinches taken at 15°C, it is necessary to have a hot source above 101°C and the cold temperature production will be  
 only 12°C. Temperature pinches have then a high impact on operating temperatures.

Pinch (°C)	Decomposition				Synthesis			
	$T_{cond}$ (°C)	$P_{cond}$ (bar)	$T_{reac,dec}$ (°C)	$T_{hot}$ (°C)	$T_{reac,synt}$ (°C)	$P_{synt}$ (bar)	$T_{evap}$ (°C)	$T_{cold}$ (°C)
<b>0</b>	25	10.0	63	<b>63</b>	25	1.8	-21	<b>-21</b>
<b>5</b>	30	13.6	71	<b>76</b>	30	2.3	-16	<b>-11</b>
<b>10</b>	35	18.2	79	<b>89</b>	35	3.0	-9	<b>1</b>

15	40	23.8	86	101	40	3.8	-3	12
----	----	------	----	-----	----	-----	----	----

Table 1 : Operating temperatures of fully thermally driven system for different temperature pinches

#### 4.2. Influence of compressors on the COP

As for the  $\text{BaCl}_2(8/0)$  example shown on Figure 9, it is possible to compute the COP of each salt on its operating range depending on the compressor usage. For all of the 84 available salts, the COP is computed and plotted on the 3-dimensionnal graph of Figure 10, as a function of the evaporation temperature ( $T_{\text{evap}}$ ) and the reactor temperature in decomposition ( $T_{\text{reac}}^{\text{dec}}$ ).

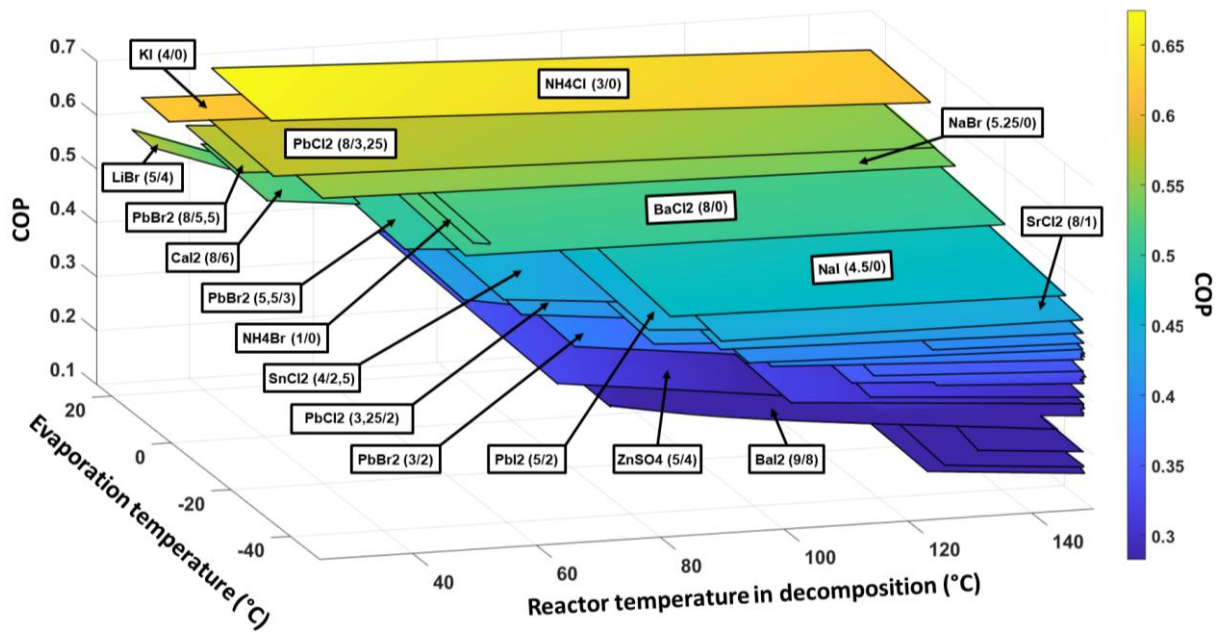
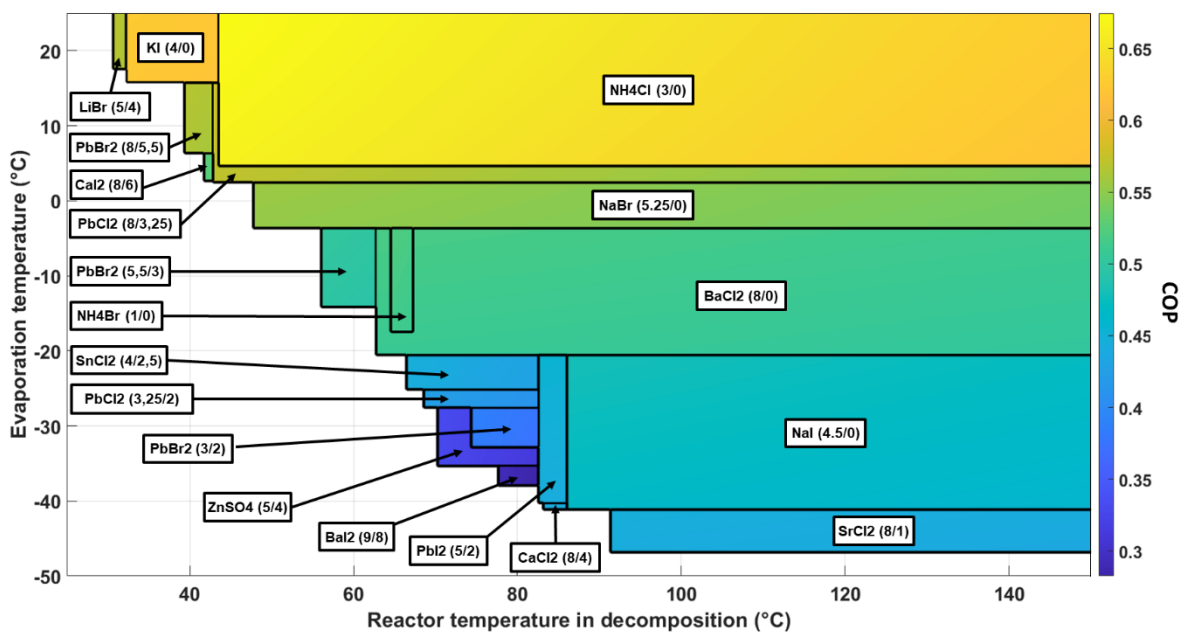

Figure 10 : 3D view of the COP of each one of the 84 salts in a fully thermally driven system in function of the evaporation temperature and reactor temperature in decomposition.

Nevertheless, even if this type of figure help to understand the study principle, it is quite difficult to extract information from it. That is why, in the rest of this paper, only the salt with the best performance indicator is kept at each operating point. The 3-dimensionnal figure is viewed from the top to obtain the 2-dimensionnal graph of Figure 11. The values of the performance indicator can be read on the colored bar on the right of the figure. With this methodology, it is possible to have a rough idea of the best COP that can be reached by an ammonia-based solid/gas thermochemical system at each operating point ( $T_{\text{reac}}^{\text{dec}}, T_{\text{evap}}$ ). Figure 11 displays this maximum COP for a fully thermally driven system in function of the reactor temperature in decomposition and the evaporation temperature. This figure is then directly correlated with Figure 10. On this figure, black lines represent the transition between two different salts, either because the salt is no more accessible and cannot be implemented beyond this operating point or because a new salt provides better performances. Many temperatures cannot be reached with a fully thermally driven

385 system as it can be seen with the white area on this figure. A COP between 0.15 and 0.67 can be expected with such a  
 386 system. The average COP over the whole operating range is 0.55.



387

388 *Figure 11: COP of the best salt in a fully thermally driven system in function of the evaporation temperature and*  
 389 *reactor temperature in decomposition.*

390 Figure 12 shows the best salt COP for a system where the compressor can be used to assist the decomposition.  
 391 The maximum COP is then given for the best salt with the best compressor configuration. To see if it is interesting to  
 392 use the compressor, some operating points are emphasized with symbols. The yellow circles represent operating points  
 393 where it is better to thermally decompose the reactor and there are brown triangles where it is better to assist the  
 394 decomposition with a compressor. The first thing to notice is the possibility to reach new operating points, the red  
 395 dotted line on this figure represents the operating range of the fully thermally driven system (without compressor). For  
 396 most operating points that were accessible without compressor, it is better to stay this way. Nevertheless, close to the  
 397 operating border of the fully thermally driven system, it become sometimes better to use a compressor to enhance the  
 398 COP even if it is possible to do without it. An interesting example is the point ( $T_{\text{reac}}^{\text{dec}} = 80^{\circ}\text{C}$ ;  $T_{\text{evap}} = 30^{\circ}\text{C}$ ) because  
 399 this point was accessible without compressor and  $\text{PbBr}_2(3/2)$  was the best salt which gave a COP about 0.38.  
 400 Nevertheless, with a compressor assisted decomposition, the operating range of  $\text{NaI}(4.5/0)$  has been extended towards  
 401 lower reactor temperature and this salt is now usable at this level of reactor temperature. The performance of this salt  
 402 at this operating point gives now a COP about 0.46. Despite the energy used to drive the compression, the COP has  
 403 raised about 20% for this precise operating point. To conclude with the assisted decomposition system it can be said  
 404 that this configuration is useful to enhance the operating range of the system but not to enhance system performances

405 except for a narrow region of operating points. Indeed, the average COP over the operating range of a fully thermally  
 406 driven system is increased by only 0.6%. The average COP over the entire operating range which is now reachable is  
 407 about 0.48 which means that the new operating points have an average COP lower than the average COP of a fully  
 408 thermally driven system.

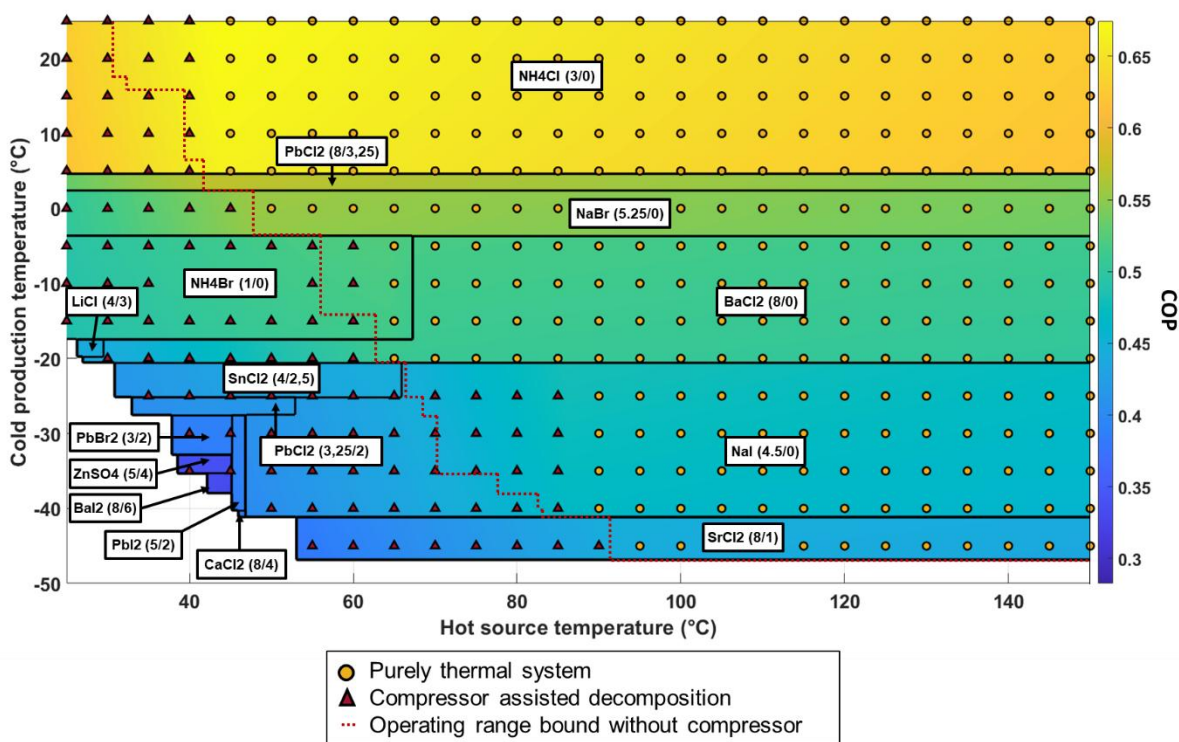

409

410 *Figure 12: COP of the best salt with the possibility to assist the decomposition in function of the evaporation*  
 411 *temperature and reactor temperature in decomposition.*

412 The configuration with the compressor assisted synthesis can be discussed with Figure 13. The improvement  
 413 of the operating range is quite similar to the system with a compressor assisted decomposition, but colder evaporation  
 414 temperature can be reached here. Nevertheless, for many operating points that were already accessible without  
 415 compressor, it is now much better to use a compressor to assist the synthesis. This leads to an improvement of the  
 416 average COP over the operating range of the fully thermally driven system which is now about 0.59 (+7.8%). The  
 417 COP over the whole reachable area with this system is 0.57 which is higher than the average COP of a fully thermally  
 418 driven system. Another interesting point to notice is the totally different salts repartition between both compressor  
 419 systems. With the use of a compressor in synthesis, there is less “best” salts. This could be interesting to design  
 420 flexible systems which have to adapt between different levels of temperature. In conclusion, the compressor in  
 421 synthesis enhances the operating range in a similar way of the compressor in decomposition but bring better  
 422 performances.



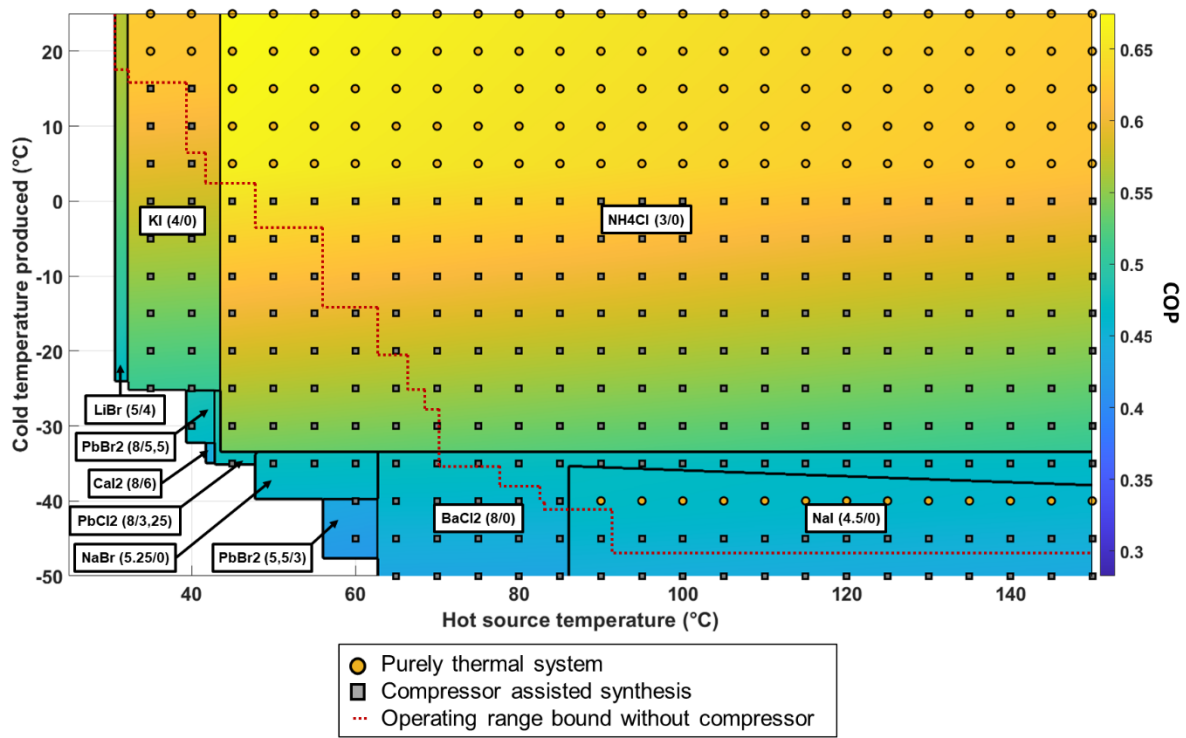

423

424

*Figure 13 : COP of the best salt with the possibility to assist the synthesis in function of the evaporation temperature and reactor temperature in decomposition.*

425

426

427

428

429

430

431

Finally, a system with a compressor assisted decomposition and synthesis is studied on Figure 14. With this system, the operating range is even more extended, and all operating points considered in this study are now reachable. The average COP of the 2 compressions system over the operating range of a fully thermally driven system is about 0.59 which is similar to the system with the compressor only in the synthesis phase. The main interest of using a compressor in both phases compare to the compressor only in synthesis is principally the new operating points that are now reachable.

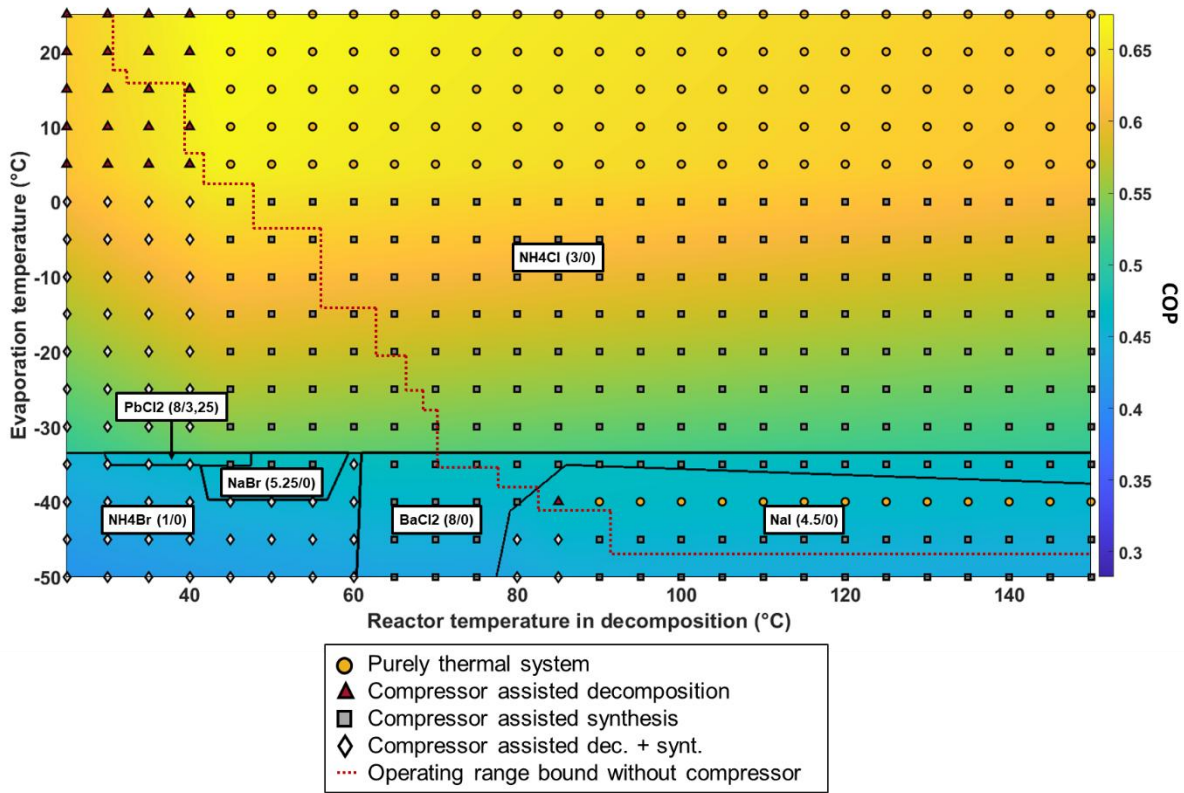

Figure 14: COP of the best salt where all compressors' configurations are possible in function of the evaporation temperature and reactor temperature in decomposition

An interesting point to discuss is ( $T_{\text{reac}}^{\text{dec}} = 60^{\circ}\text{C}$ ;  $T_{\text{evap}} = -35^{\circ}\text{C}$ ) for example. Available salts and corresponding COP for each operating mode at this precise operating point are shown in Table 2. This operating point is unreachable without compressor, this means that no salts are able to be decomposed with this reactor temperature and produce this temperature level of cold. With a compressor in decomposition, 10 salts are available, among which NaI(4.5/0) gives the highest COP. In the assisted synthesis, only 3 salts are available, and NaI(4.5/0) is no more in the list because this salt cannot be decomposed with a thermal source at  $60^{\circ}\text{C}$ . Nevertheless, among the 3 available salts, NaBr(5.25/0) gives a COP about 0.47, which is better than NaI(4.5/0) in the assisted decomposition. Finally, when the compressor can be used in both phases, all previous salts are of course available, and new ones are available too.  $\text{NH}_4\text{Br}(1/0)$  which is now also available enables a small enhancement of the COP compared to the one obtained with compressor-assisted synthesis.

Finally, the only reason which can lead to obtain better performances at a given operating point is the possibility to use new salts that were not accessible without this compressor configuration. Indeed, it is impossible to obtain better performances with the same salt when using a compressor has discussed on Figure 9. Nevertheless, even if the list of available salt is extended, the best salt remains sometimes the one obtained for the fully thermally driven

449 system. This is the case of the operating point ( $T_{\text{react}}^{\text{dec}} = 100^{\circ}\text{C}; T_{\text{evap}} = 15^{\circ}\text{C}$ ) where  $\text{NH}_4\text{Cl}(3/0)$  is always the best  
 450 salt.

Fully thermally driven system		Assisted decomposition		Assisted synthesis		Assisted decomposition and synthesis	
Salt name	COP	Salt name	COP	Salt name	COP	Salt name	COP
-	-	NaI (4.5/0)	0.43	PbCl <sub>2</sub> (8/3.25)	0.47	NH <sub>4</sub> Br (1/0)	0.47
		PbI <sub>2</sub> (5/2)	0.41	NaBr (5.25/0)	0.47	PbCl <sub>2</sub> (8/3.25)	0.47
		CaCl <sub>2</sub> (8/4)	0.41	PbBr <sub>2</sub> (5.5/3)	0.45	NaBr (5.25/0)	0.47
		SnBr <sub>2</sub> (5/3)	0.40			LiCl (4/3)	0.40
		SrCl <sub>2</sub> (8/1)	0.40			BaCl <sub>2</sub> (8/0)	0.47
		BaBr <sub>2</sub> (8/4)	0.39			PbBr <sub>2</sub> (5.5/3)	0.45
		BaI <sub>2</sub> (9/8)	0.32			SnCl <sub>2</sub> (4/2.5)	0.42
		CaCl <sub>2</sub> (4/2)	0.37			NaI (4.5/0)	0.43
		BaBr <sub>2</sub> (4/2)	0.37			PbCl <sub>2</sub> (3.25/2)	0.41
		ZnSO <sub>4</sub> (5/4)	0.33			PbBr <sub>2</sub> (3/2)	0.39
						PbI <sub>2</sub> (5/2)	0.41
						CaCl <sub>2</sub> (8/4)	0.41
						SnBr <sub>2</sub> (5/3)	0.40
						SrCl <sub>2</sub> (8/1)	0.40
						BaBr <sub>2</sub> (8/4)	0.39
						BaI <sub>2</sub> (9/8)	0.32
						CaCl <sub>2</sub> (4/2)	0.37
						BaBr <sub>2</sub> (4/2)	0.37
						ZnSO <sub>4</sub> (5/4)	0.33

451

452 *Table 2 : COP of all salts available at the operating conditions  $T_{\text{hot}} = 60^{\circ}\text{C}$  and  $T_{\text{cold}} = -35^{\circ}\text{C}$  in each compressor*  
 453 *configuration (best one in green).*

454 This study concerning the COP of the system with different compressor configurations has shown the interest  
 455 of the compressor to enhance the operating range. It has also shown that the compressor in synthesis bring better

456 performances, but it is essential to keep in mind that even if better COP can be reached with electrical systems it is  
457 sometimes better to use only low-grade wasted heat to save electricity which is a more valuable source of energy. To  
458 take this into account, the following section presents a similar study, but with different performance indicators.

### 459 4.3. Exergetic efficiency

460 The reference temperature for the computation of exergetic efficiency is the ambient temperature taken at  
461  $T_{amb} = 25^{\circ}\text{C}$ . The first thing to explore is the way the exergetic efficiency is modified in function of operating  
462 temperatures and compressor configurations. Figure 15 is similar to Figure 9 but shows the evolution of the exergetic  
463 efficiency of  $\text{BaCl}_2(8/0)$  instead of the COP. Points A, B, C and D are the same as in the previous figure and represent  
464 the limit operating points of each compressor configuration. Looking at the expression of exergetic efficiency  
465 (equation (5)) it is normal to be equal to 0 for an evaporation temperature at ambient temperature because  $\theta_f = 0$ . In  
466 the fully thermally driven system, the exergetic efficiency is increasing when the evaporation temperature and reactor  
467 temperature in decomposition are decreasing because of  $\theta$  values. The maximal exergetic efficiency is reached at point  
468 A because it is impossible to go further in temperature without using a compressor. After point A, if the evaporation  
469 temperature or the reactor temperature in decomposition are further lower, the values of  $\theta$  make the exergetic  
470 efficiency increase but the consumption of energy for the compression make the global exergetic efficiency decrease.

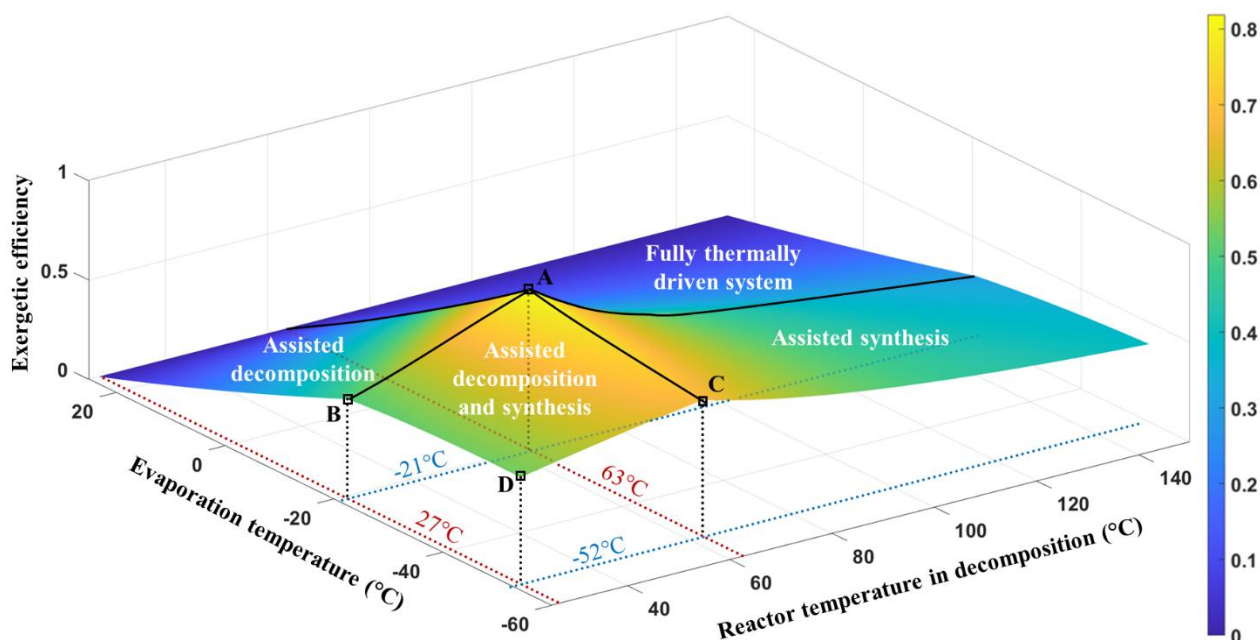

471  
472 *Figure 15 : Exergetic efficiency of the  $\text{BaCl}_2(8/0)$  for different compressor configuration in function of the*  
473 *evaporation temperature and reactor temperature in decomposition.*

474 To keep conciseness, only the fully thermally driven system and the system with assisted decomposition and  
475 synthesis are discussed here.

476 Figure 16 shows the best salt according to exergetic efficiency for each operating point in a fully thermally  
477 driven system. The maximum exergetic efficiency is about 0.83 and the average value about 0.33. For a given salt, it is  
478 better to work with the reactor close to the limit desorption temperature because working at higher temperature brings  
479 a loss in term of sensible temperature. In addition, to reach better exergetic efficiency, it is always better to evaporate  
480 at the lower temperature reachable. That is why, for each salt, the best performances are reached close to both limit  
481 temperatures which correspond of the bottom left corner for each salt on Figure 16. For  $\text{BaCl}_2(8/0)$  for example, the  
482 point of maximum exergetic efficiency correspond to the point A ( $63^\circ\text{C}$ ;  $-21^\circ\text{C}$ ) described in Figure 9.

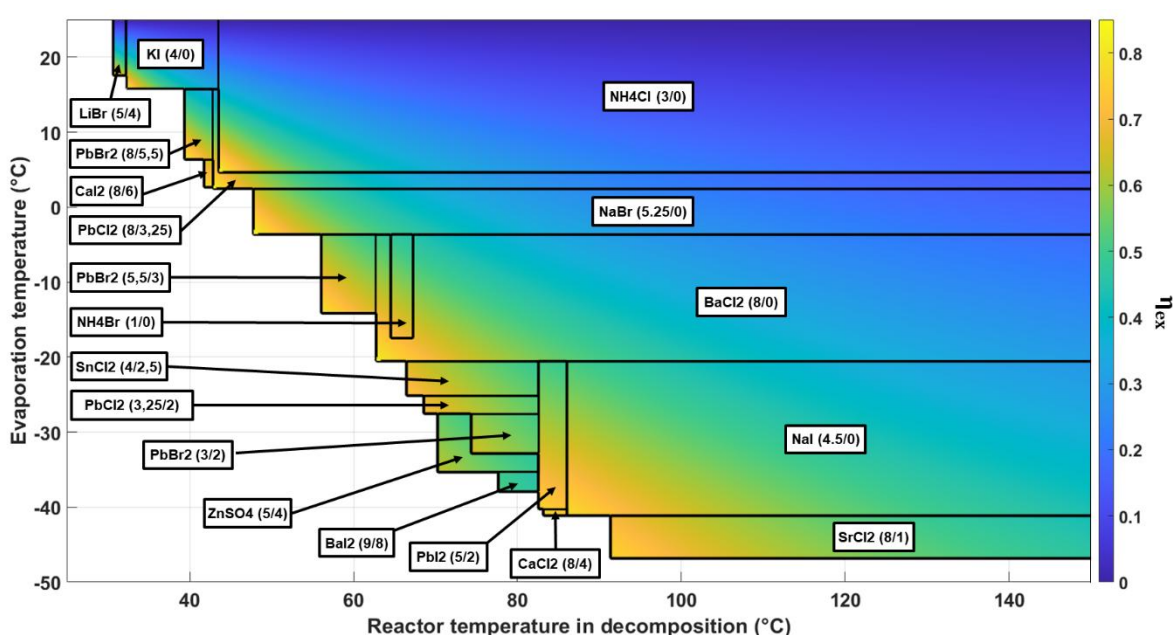

483

484 *Figure 16: Exergetic efficiency of the best salt in a fully thermally driven system in function of the evaporation*  
485 *temperature and reactor temperature in decomposition*

486 Figure 17 represents the maximum exergetic efficiency evolution on the operating range for a system where  
487 all compressor configurations are possible. It can be noticed that, for a given operating point, the best salt regarding  
488 the exergetic efficiency is ZnSO4 necessarily the same as the best salt regarding the COP. In addition, as one could  
489 expected, there is more operating points where the best configuration is without compressor compared to the COP.  
490 Nevertheless, the most interesting thing to notice is the fact that the new points that are reachable with a compressor  
491 gives still a good exergetic efficiency while best operating points for the COP were already accessible without  
492 compressor. This translates into an increased average exergetic efficiency over the whole operating area 0.43  
493 compared to 0.33 with the fully thermally driven system. This conclusion is quite interesting because the addition of a

494 compressor has now a double positive effect, it is possible to reach new operating points, i.e. to produce cold at lower  
 495 temperature with thermal sources of lower value and these new operating points presents high values of exergetic  
 496 efficiency.

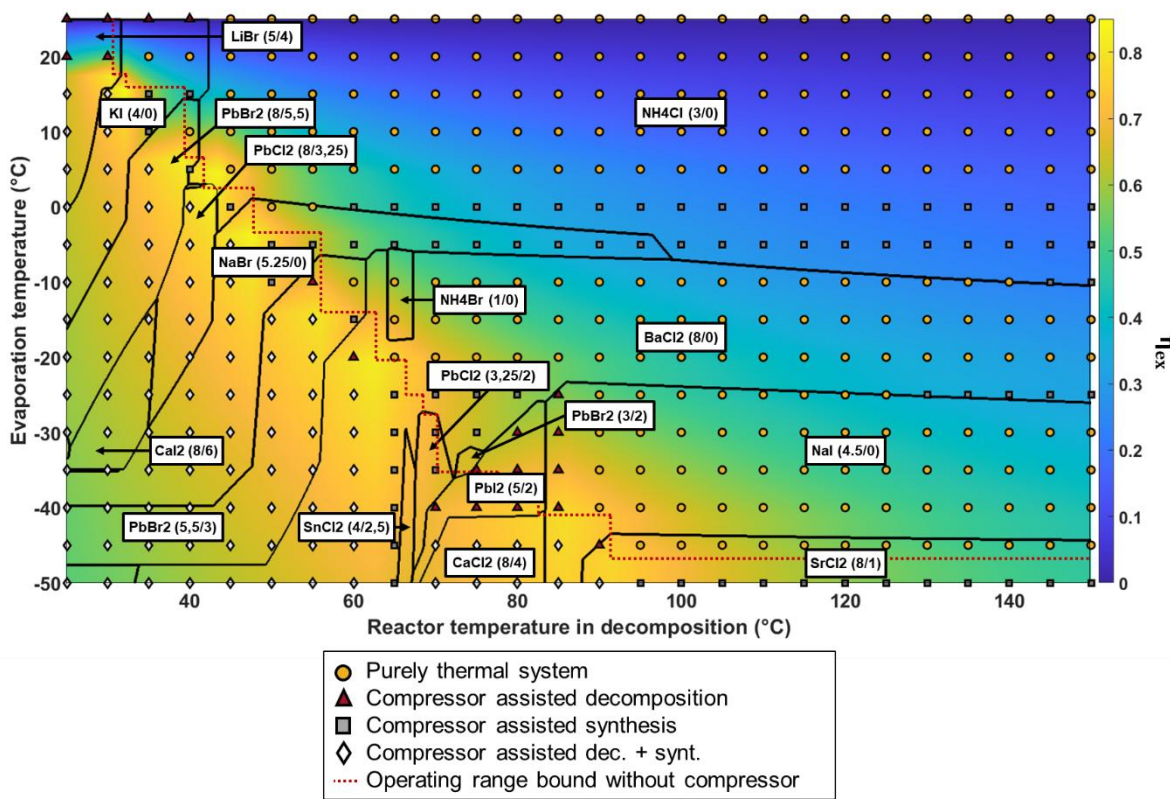

497

498 *Figure 17: Exergetic efficiency of the best salt where all compressors' configurations are possible in function of the*  
 499 *evaporation temperature and reactor temperature in decomposition*

#### 500 4.4. Primary energy efficiency

501 The primary energy efficiency of one salt can be easily related to its COP. Indeed, on the fully thermally  
 502 driven area, primary energy efficiency and COP are strictly equal. Then, when compressors are used, the  
 503 performances are decreasing faster because of the transformation coefficient which is applied on electrical energy used  
 504 to drive the compression. For this reason, there is no need to display the primary energy efficiency for a fully  
 505 thermally driven system because it is strictly identical to the COP case.

506 Figure 18 shows the primary energy efficiency of a thermochemical system where both phases can be  
 507 mechanically assisted with a compressor. The interesting things to notice here is that it remains more operating points  
 508 where it is better to only drive the system with heat when it's possible. To evaporate at  $-20^{\circ}\text{C}$  with a reactor between  
 509 65 and  $150^{\circ}\text{C}$  for example it is now better to use  $\text{BaCl}_2(8/0)$  because this salt does not require the compressor while  
 510 regarding the COP it was better to use  $\text{NH}_4\text{Cl}(3/0)$  and a compressor to assist the synthesis. Nevertheless, even by

511 considering the energetic cost of electricity production, the use of a compressor, especially in synthesis, can bring  
512 flexibility and sometimes better performances.

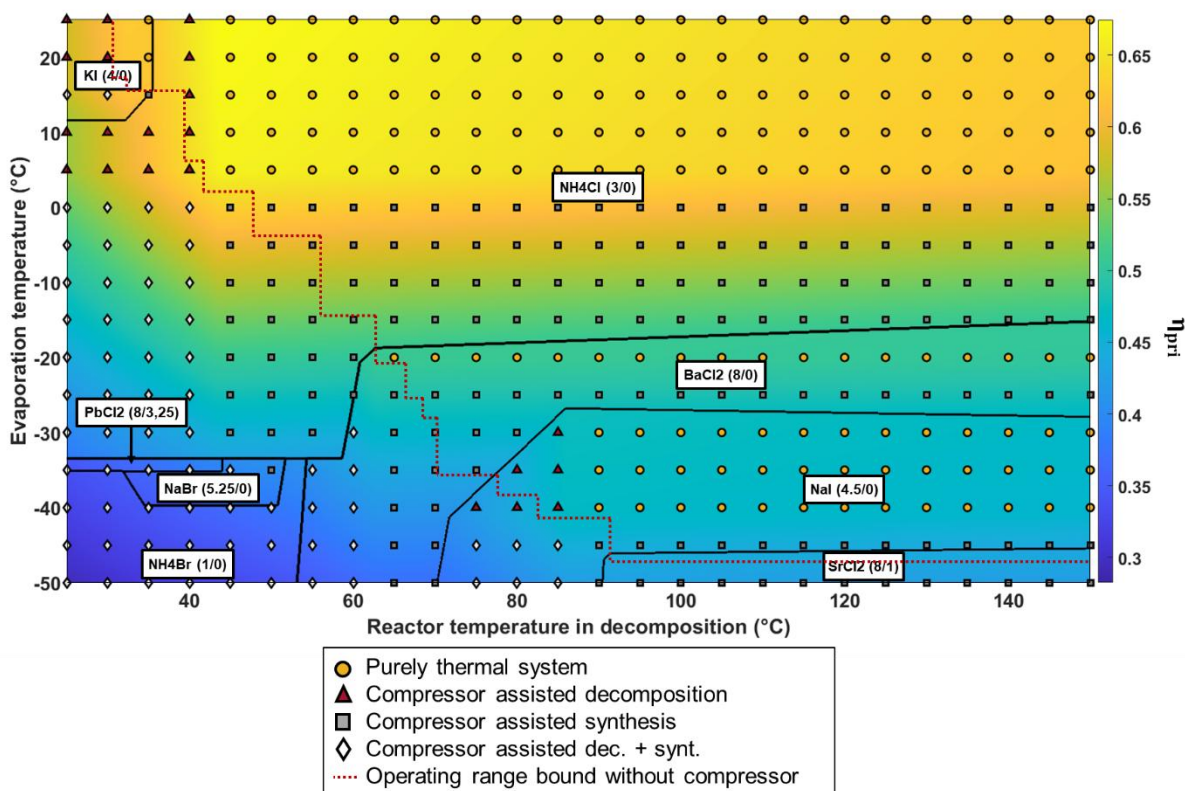

513

514 *Figure 18 : Primary energy efficiency of the best salt where all compressors' configurations are possible in function*  
515 *of the evaporation temperature and reactor temperature in decomposition.*

#### 516 4.5. Performance's analysis

517 First, it seems useful to clarify the mechanism by which salts performs differently. Two parameters are mainly  
518 decisive : the enthalpy and entropy of reaction. Indeed, these two parameters qualify the thermodynamic position of  
519 the reaction equilibrium and are therefore the source of the pressure difference between two salts operating at the same  
520 temperature. These different operating pressures leads to different compression ratios and, consequently, the  
521 consumed work by the compressor is also different for each salt. In addition, the enthalpy of reaction represents also a  
522 major part of the that is needed to desorb one mole of gas.

523 Figure 19 summarizes the different average values of COP, exergetic efficiency and primary energy efficiency  
524 over either the operating range of a fully thermally driven system or over the range of the whole permissible area of  
525 use.

526 The compressor in decomposition brings nearly no gain in performances over the operating range of the fully  
527 thermally driven system (+0.6%). New operating points that are reachable present low performances regarding the

528 COP and the primary energy efficiency but a good exergetic efficiency. This is translated into a decreased average  
529 value of the COP and the primary energy efficiency (-12.5%) but an increased average value of exergetic efficiency  
530 over the whole operating range (+17.8%).

531 Concerning the system with an assisted synthesis, the average performances over the operating range of the  
532 fully thermally driven system are quite enhanced regarding the COP (+7.8%) and the primary energy efficiency  
533 (+3.8%) but not much regarding the exergetic efficiency (+2.1%). As for the compressor in decomposition, new  
534 operating points tends to decrease the primary energy efficiency (-9.6%). Nevertheless, contrary to the compressor in  
535 decomposition, the average COP over the new reachable operating area is now better than the average COP of a fully  
536 thermally driven system over its own operation area (+5.1%). The average exergetic efficiency is increased thanks to  
537 new operating points that present a good exergetic efficiency (+22.9%). The compressor in synthesis brings then better  
538 average performances than the compressor in decomposition for a quite similarly extended operating range.

539 With the system where all compressor configurations are allowed, in addition to the further extended  
540 operating range, enhanced performances can be reached. Compared to the fully thermally driven system over its  
541 operating range, the average COP is now about 0.59 (+8.0%), the exergetic efficiency 0.34 (+2.1%) and the primary  
542 energy efficiency 0.57 (+3.8%). The computation over the new extended operating area leads to a COP of 0.57  
543 (+4.7%) and a primary energy efficiency of 0.54 (-1.7%). This means that the new operating points have lower  
544 performance values in average than the average value over the operating range of a fully thermally driven system.  
545 Concerning the exergetic efficiency, new operating points presents high values, and the system can reach an exergetic  
546 efficiency of 0.43 in average (+31.9%).



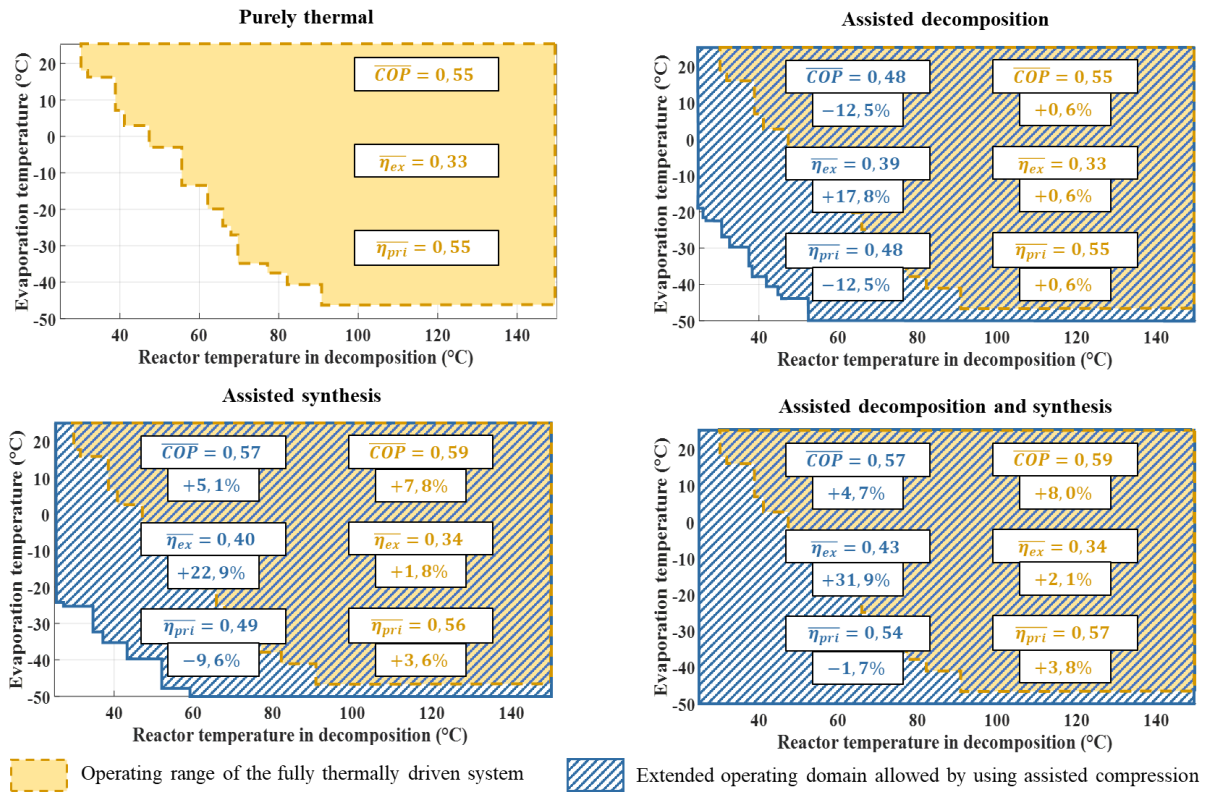

Figure 19 : Possible operating domain ( $T_{reac}^{dec}; T_{evap}$ ) of the 4 systems. Average performances for each system over the operating domains either of the fully thermally driven system (yellow area) or the extended operating domain allowed by using assisted compression (blue area). Performance comparison with the fully-thermally driven system.

It is essential to keep in mind that even if average values do not show the interest of compressor for some configuration, it remains some points where better performances can be reached locally. It was for example the case of the point (80°C; -30°C) discussed earlier where the compressor in decomposition brings a COP 20% higher.

Apart from these performances considerations, this study has also brought some possibility to design flexible systems that seems interesting. For example, with a system based on  $BaCl_2(8/0)$ , it is possible to produce cold for air-conditioning applications without using a compressor if the heat source is above 63°C. If the user has a heat source at a lower temperature,  $BaCl_2$  can still be implemented with good performances by using a compressor to assist the decomposition. Using a compressor to assist the synthesis allow to evaporate ammonia below -30°C and this salt is still the better one regarding the three performance indicators. This configuration seems particularly interesting to explore and compare with the previous cascaded thermochemical processes implementing  $BaCl_2$  salt that have been experimented by Le Pierres et al [18] for solar deep-freezing applications. Obviously, this salt is not the only one that seems interesting, but the methodology developed in this article seems particularly interesting and can help for the choice of a salt and the preliminary design.

## 5. Conclusion

565 A thermodynamic study has been done to investigate the performance of 4 thermochemical cycles : a  
566 thermally driven cycle, a system with a compressor assisted decomposition or synthesis and a cycle where both phases  
567 are assisted by a compressor. The main novelty brought by this paper is the screening of many ammoniated salts over  
568 different compressor configurations. In addition, the compressor assisted synthesis has never been studied in the  
569 scientific literature for the cold production with thermochemical systems at our knowledge. This new configuration  
570 seems to bring interesting performances and required probably further consideration in the future. Furthermore, this  
571 configuration is not incompatible with the assisted decomposition and a system with an assisted decomposition and  
572 synthesis seems feasible with only one compressor. Experimental investigations must be done in order to establish an  
573 experimental proof of concept and to determine experimental performances of these two new compressor  
574 configurations.

575 This study has been done with many hypotheses to remain a theoretical study. That is why every parameter  
576 which depends on the manufacturing of the system has been excluded. There is then no pressure drops, no temperature  
577 pinches in heat exchanger and the operating points have been taken at thermodynamic equilibrium. This article is  
578 intended as an aid in selecting the most suitable ammoniated salt and compressor configuration for an intended  
579 application.

580 It has been shown that a single compressor, either in decomposition or synthesis, enables an extended  
581 operating range even if the compression ratio is limited to 5. This extension of the operating range enables the design  
582 of flexible systems that can adapt to a wide range of hot source temperature and produce cold at different level of  
583 temperatures. The operating range is even further extended if the compressor is used in both phases and every  
584 operating point considered in this study are reachable ( $T_{reac}^{dec} \in [25^{\circ}C; 150^{\circ}C]$ ;  $T_{evap} \in [-50^{\circ}C; 25^{\circ}C]$ ).

585 An advancement brought by this paper is the interesting performances reached by a system where the  
586 synthesis is assisted by a compressor. Indeed, in addition to the operating area extension, it is possible to enhance  
587 performances. On the operating range of a fully thermally driven system, compressor in synthesis bring an average  
588 improvement about 8% regarding the COP, 2% regarding the exergetic efficiency and 4% for the primary energy  
589 efficiency.

590 Another advancement concerns the exergetic efficiency because the new operating points that are reachable  
591 with compressors system thanks to the extension of the operating range of each salt present a good exergetic  
592 efficiency value. This leads to an average value of exergetic efficiency about 32% higher than with a fully thermally  
593 driven system.

## 594 Acknowledgments

595 This work was supported by the French National Research Agency (ANR) in the framework of the RECIF  
596 project under contract ANR-18-CE05-0043 (<https://anr.fr/Projet-ANR-18-CE05-0043>). These studies have been  
597 conducted within the PROMES laboratory which the authors would like to thank too.

## 598 References

- 599 [1] C. Forman, I. K. Muritala, R. Pardemann, et B. Meyer, « Estimating the global waste heat potential », *Renew.*  
600 *Sustain. Energy Rev.*, vol. 57, p. 1568- 1579, 2016.
- 601 [2] S. Firth, K. Lomas, A. Wright, et R. Wall, « Identifying trends in the use of domestic appliances from  
602 household electricity consumption measurements », *Energy Build.*, vol. 40, n° 5, p. 926- 936, 2008.
- 603 [3] A. H. Abedin, « A Critical Review of Thermochemical Energy Storage Systems », *Open Renew. Energy J.*,  
604 vol. 4, n° 1, p. 42- 46, 2011.
- 605 [4] P. Gao, M. M. Chang, C. L. Zhang, et L. L. Shao, « System principles and applications of hybrid sorption-  
606 compression heat pump – A review », *Int. J. Refrig.*, vol. 108, p. 14- 25, 2019.
- 607 [5] K. J. Kim, K. T. Feldman, G. Lloyd, et A. Razani, « Compressor-driven metal-hydride heat pumps », *Appl.*  
608 *Therm. Eng.*, vol. 17, n° 6, p. 551- 560, 1997.
- 609 [6] K. J. Kim, G. M. Lloyd, et A. Razani, « Thermal analysis of the Ca<sub>0.4</sub>Mm<sub>0.6</sub>Ni<sub>5</sub> metal-hydride reactor »,  
610 *Appl. Therm. Eng.*, vol. 18, p. 1325- 1336, 1998.
- 611 [7] J. G. Park, S. C. Han, H. Y. Jang, S. M. Lee, P. S. Lee, et J. Y. Lee, « The development of compressor-driven  
612 metal hydride heat pump (CDMHHP) system as an air conditioner », *Int. J. Hydrogen Energy*, vol. 27, n° 9, p.  
613 941- 944, 2002.
- 614 [8] J. G. Park, K. J. Jang, P. S. Lee, et J. Y. Lee, « The operating characteristics of the compressor-driven metal  
615 hydride heat pump system », *Int. J. Hydrogen Energy*, vol. 26, n° 7, p. 701- 706, 2001.
- 616 [9] S. S. Bedbak et M. R. Gopal, « Performance analysis of a compressor driven metal hydride cooling system »,  
617 *Int. J. Hydrogen Energy*, vol. 30, n° 10, p. 1127- 1137, 2005.
- 618 [10] F. Ferrucci, D. Stitou, P. Ortega, et F. Lucas, « Mechanical compressor-driven thermochemical storage for  
619 cooling applications in tropical insular regions. Concept and efficiency analysis », *Appl. Energy*, vol. 219, n°  
620 December 2017, p. 240- 255, 2018.
- 621 [11] J. Fitó, A. Coronas, S. Mauran, N. Mazet, M. Perier-Muzet, et D. Stitou, « Hybrid system combining  
622 mechanical compression and thermochemical storage of ammonia vapor for cold production », *Energy*  
623 *Convers. Manag.*, vol. 180, n° July 2018, p. 709- 723, 2019.
- 624 [12] L. Jiang, R. Q. Wang, X. Tao, et A. P. Roskilly, « A hybrid resorption-compression heat transformer for energy  
625 storage and upgrade with a large temperature lift », *Appl. Energy*, vol. 280, n° March, p. 115910, 2020.
- 626 [13] M. van der Pal, A. Wemmers, S. Smeding, et K. van den Heuvel, « Study on the performance of hybrid  
627 adsorption-compression type II heat pumps based on ammonia salt adsorption », *Int. J. Low-Carbon Technol.*,  
628 vol. 6, n° 3, p. 207- 211, 2011.
- 629 [14] M. Van Der Pal, A. Wemmers, S. Smeding, et R. De Boer, « Technical and economical feasibility of the  
630 hybrid adsorption compression heat pump concept for industrial applications », *Appl. Therm. Eng.*, vol. 61, n°  
631 2, p. 837- 840, 2013.
- 632 [15] H. Bao, Z. Ma, et A. P. Roskilly, « Integrated chemisorption cycles for ultra-low grade heat recovery and  
633 thermo-electric energy storage and exploitation », *Appl. Energy*, vol. 164, p. 228- 236, 2016.
- 634 [16] H. Bao, Z. Ma, et A. P. Roskilly, « Chemisorption power generation driven by low grade heat – Theoretical  
635 analysis and comparison with pumpless ORC », *Appl. Energy*, vol. 186, 2017.
- 636 [17] Z. Ma, H. Bao, et A. P. Roskilly, « Electricity-assisted thermochemical sorption system for seasonal solar

- 637 energy storage », *Energy Convers. Manag.*, vol. 209, n° January, p. 112659, 2020.
- 638 [18] N. Le Pierrès, N. Mazet, et D. Stitou, « Experimental results of a solar powered cooling system at low  
639 temperature », *Int. J. Refrig.*, vol. 30, n° 6, p. 1050- 1058, 2007.
- 640 [19] P. Neveu, « Diagrammes thermodynamiques relatif aux équilibres solide/gaz ». 1996.
- 641 [20] K. Liang, R. Stone, W. Hancock, M. Dadd, et P. Bailey, « Comparison between a crank-drive reciprocating  
642 compressor and a novel oil-free linear compressor », *Energy Econ.*, vol. 45, p. 25- 34, 2014.
- 643 [21] P. Jolly et N. Mazet, « Optimisation de la diffusion du gaz dans des matériaux réactifs, siège de transferts de  
644 chaleur, de masse et d'une réaction chimique », *Int. J. Heat Mass Transf.*, vol. 42, n° 2, p. 303- 321, 1999.
- 645 [22] P. Touzain, « Thermodynamic values of ammonia-salts reactions for chemical sorption heat pumps. », in  
646 *Proceedings of the international sorption heat pump conference, Munich, Germany. 1999, 1999.*

647