

DFO Symposium

# Escaping unknown discontinuous regions in blackbox optimization

Solène Kojtych

July, 19th 2022

Supervisors: Charles AUDET, Alain BATAILLY





# Motivation : design of aircraft engines

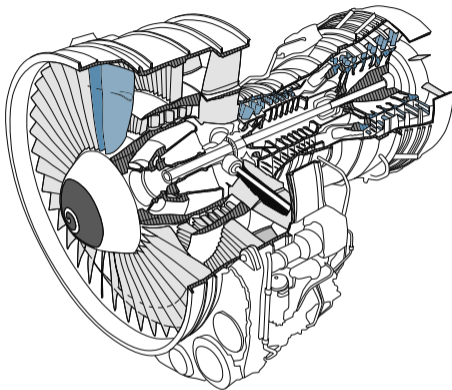

► aircraft engine , adapted from 1.

<sup>1</sup>Y. Colaitis. <https://tel.archives-ouvertes.fr/tel-03318777>. PhD thesis. École Polytechnique de Montréal, 2021.

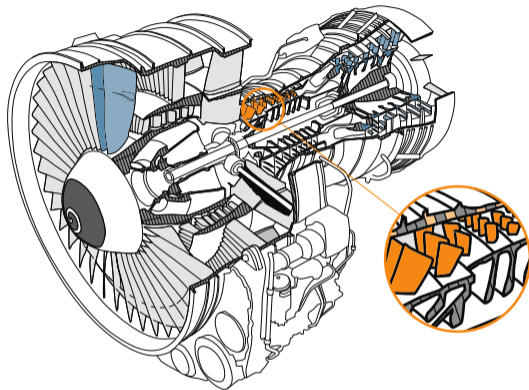

- contact and friction interfaces

- ▶ nonlinear vibrations
- ▶ detrimental phenomena

▶ aircraft engine , adapted from 1.



# Motivation : design of aircraft engines

Context

Motivation

Framework

Problem

Modeling

Basics on Mads

DiscoMads

Convergence

Results

Conclusion

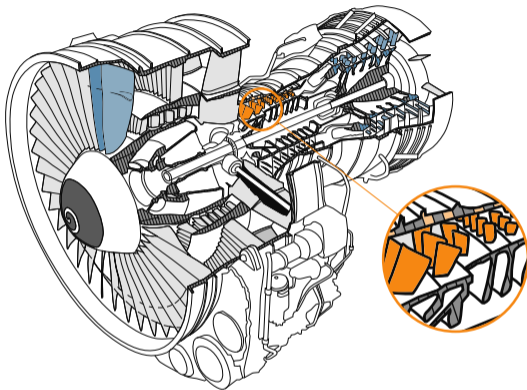

▶ aircraft engine , adapted from 1.

- contact and friction interfaces

- ▶ nonlinear vibrations
- ▶ detrimental phenomena

- nonlinear phenomena in design cycle ?



<sup>1</sup>Y. Colaitis. <https://tel.archives-ouvertes.fr/tel-03318777>. PhD thesis. École Polytechnique de Montréal, 2021.



# Motivation : design of aircraft engines

Context

Motivation

Framework

Problem

Modeling

Basics on Mads

DiscoMads

Convergence

Results

Conclusion

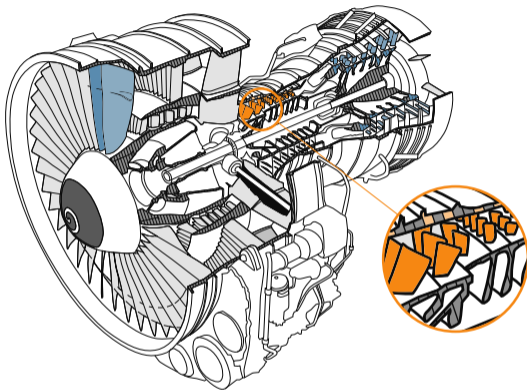

▶ aircraft engine , adapted from 1.

- contact and friction interfaces

- ▶ nonlinear vibrations
- ▶ detrimental phenomena

- nonlinear phenomena in design cycle ?

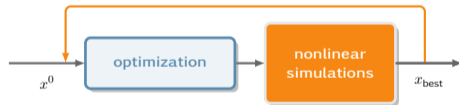

<sup>1</sup>Y. Colaitis. <https://tel.archives-ouvertes.fr/tel-03318777>. PhD thesis. École Polytechnique de Montréal, 2021.



# Motivation : design of aircraft engines

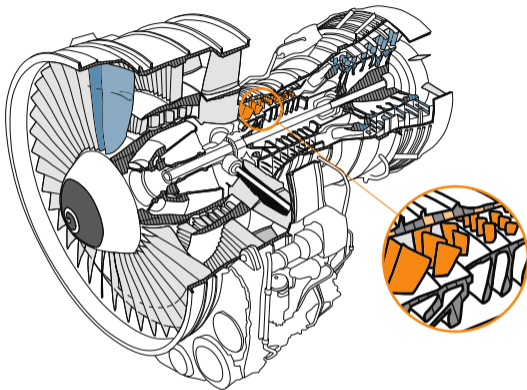

▶ aircraft engine , adapted from 1.

- contact and friction interfaces

- ▶ nonlinear vibrations
- ▶ detrimental phenomena

- nonlinear phenomena in design cycle ?

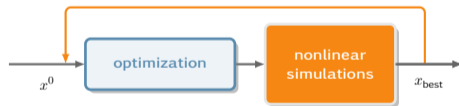

⇒ **Need to account for nonlinear simulations in the early stages of the design cycle**

<sup>1</sup>Y. Colaitis. <https://tel.archives-ouvertes.fr/tel-03318777>. PhD thesis. École Polytechnique de Montréal, 2021.



Context

Motivation

Framework

Problem

Modeling

Basics on Mads

DiscoMads

Convergence

Results

Conclusion

# Mathematical framework

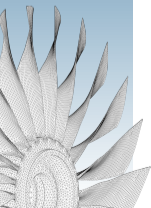



# Mathematical framework

Context

Motivation

Framework

Problem

Modeling

Basics on Mads

DiscoMads

Convergence

Results

Conclusion

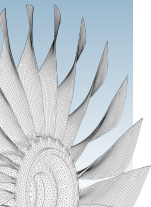
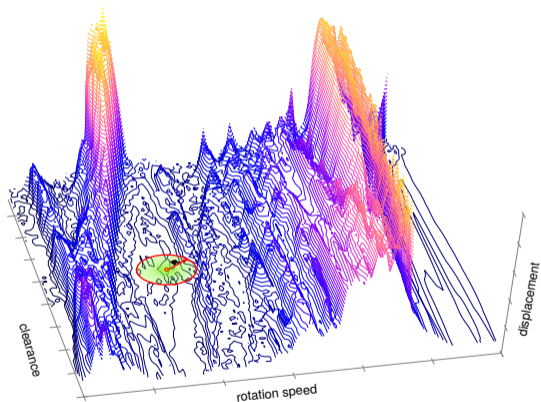



# Mathematical framework

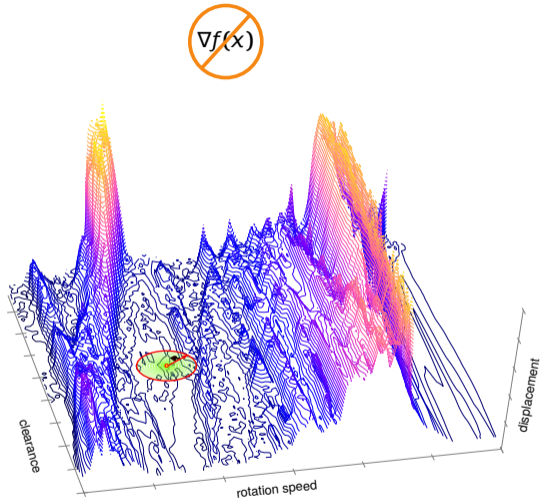
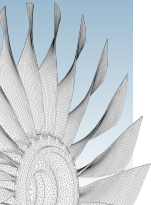

# Mathematical framework



- blackbox optimization problem

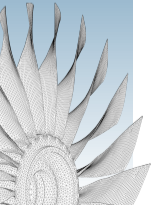
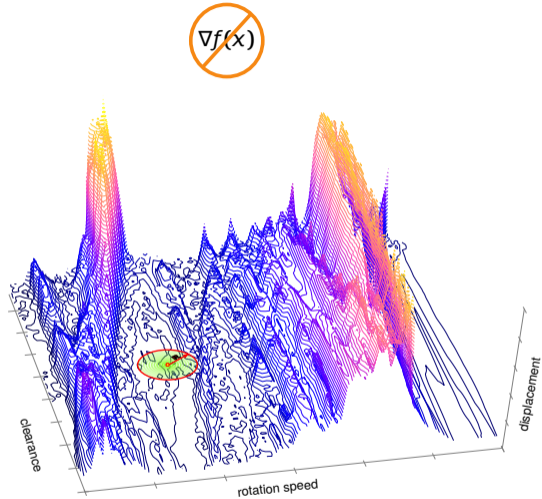



- blackbox optimization problem

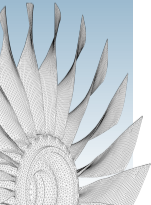
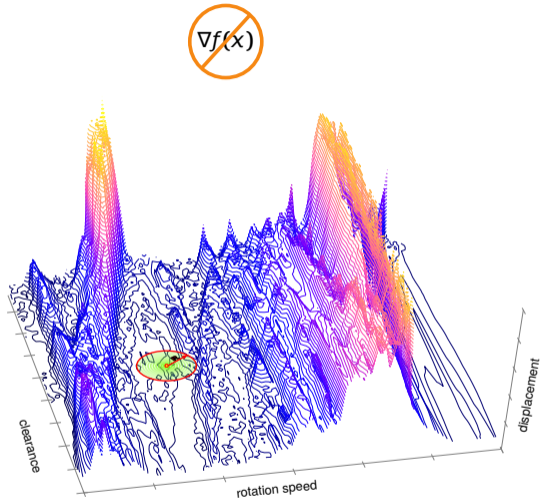

# Mathematical framework

- DFO Symposium
- Context
- Motivation

- Framework
- Problem
- Modeling
- Basics on Mads
- DiscoMads
- Convergence
- Results
- Conclusion



- blackbox optimization problem

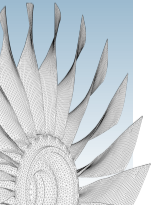
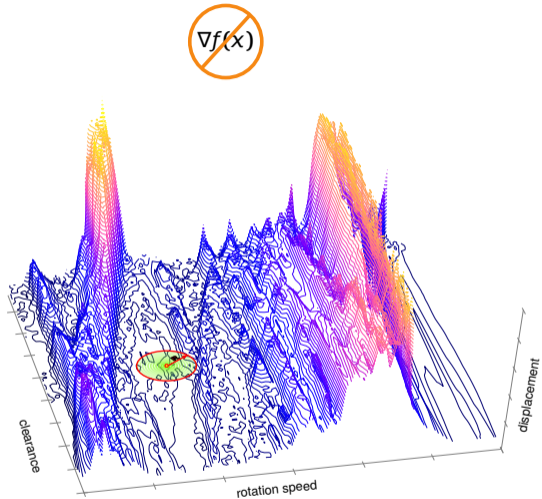
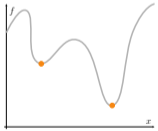



- blackbox optimization problem

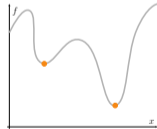

ERROR

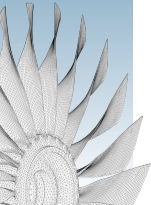
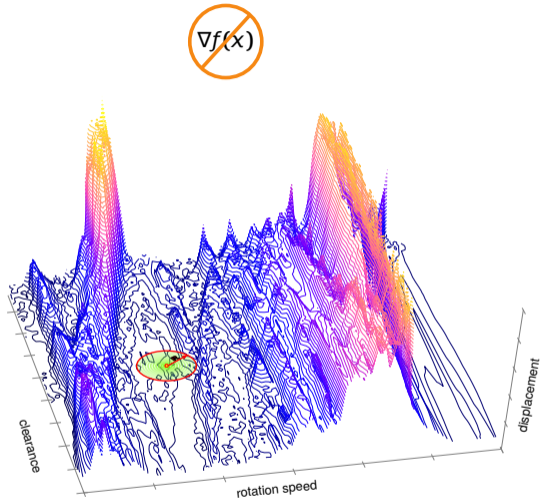



# Blackbox optimization problem

$$\min_{x \in X} f(x) \tag{1}$$

- notations

- ▶  $x \in X \subseteq \mathbb{R}^n$ : vector of variables
- ▶  $f : X \rightarrow \mathbb{R} \cup \{\infty\}$ : objective function

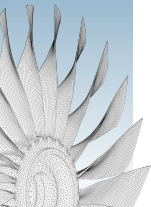



# Blackbox optimization problem

$$\min_{x \in X} f(x) \quad (1)$$

- notations

- ▶  $x \in X \subseteq \mathbb{R}^n$ : vector of variables
- ▶  $f : X \rightarrow \mathbb{R} \cup \{\infty\}$ : objective function

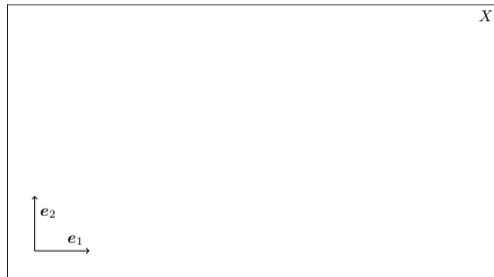

$$\min_{x \in X} f(x)$$

$$\text{subject to } c(x) \leq 0$$

(1)

## • notations

- ▶  $x \in X \subseteq \mathbb{R}^n$ : vector of variables
- ▶  $f : X \rightarrow \mathbb{R} \cup \{\infty\}$ : objective function
- ▶  $c : X \rightarrow \mathbb{R}^m \cup \{\infty\}^m$ : models  $m$  constraints  $c_j(x), j \in \{1, \dots, m\}$

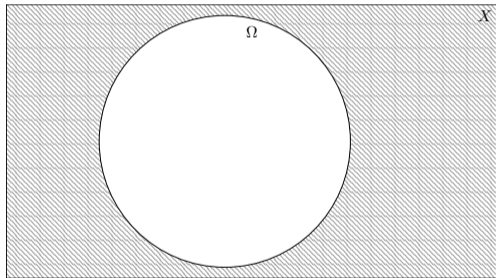

$$\Omega = \{x \in X : c(x) \leq 0\}$$

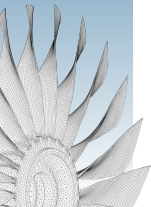



$$\min_{x \in X} f(x)$$

$$\text{subject to } c(x) \leq 0$$

(1)

## • notations

- ▶  $x \in X \subseteq \mathbb{R}^n$ : vector of variables
- ▶  $f : X \rightarrow \mathbb{R} \cup \{\infty\}$ : objective function
- ▶  $c : X \rightarrow \mathbb{R}^m \cup \{\infty\}^m$ : models  $m$  constraints  $c_j(x), j \in \{1, \dots, m\}$

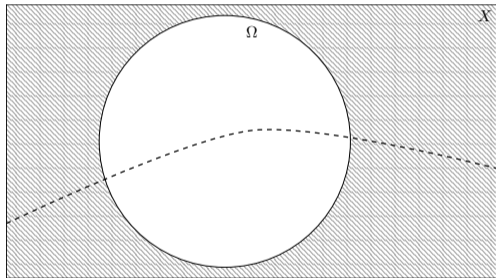

$$\Omega = \{x \in X : c(x) \leq 0\}$$

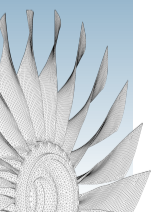

# Blackbox optimization problem

$$\begin{aligned} \min_{x \in X} \quad & f(x) \\ \text{subject to} \quad & c(x) \leq 0 \end{aligned} \tag{1}$$

## • notations

- ▶  $x \in X \subseteq \mathbb{R}^n$ : vector of variables
- ▶  $f : X \rightarrow \mathbb{R} \cup \{\infty\}$ : objective function
- ▶  $c : X \rightarrow \mathbb{R}^m \cup \{\infty\}^m$ : models  $m$  constraints  $c_j(x), j \in \{1, \dots, m\}$

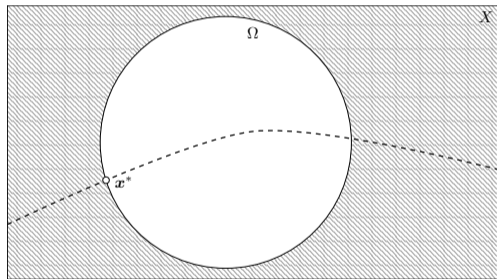

$$\Omega = \{x \in X : c(x) \leq 0\}$$

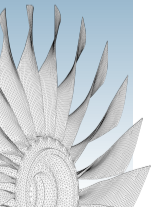

$$\begin{aligned}
 & \min_{x \in X} f(x) \\
 & \text{subject to } c(x) \leq 0 \\
 & \text{and } d(x) \leq 0 \iff x \text{ "far" from discontinuities of outputs } j \in J
 \end{aligned} \tag{1}$$

• notations

- ▶  $x \in X \subseteq \mathbb{R}^n$ : vector of variables
- ▶  $f : X \rightarrow \mathbb{R} \cup \{\infty\}$ : objective function
- ▶  $c : X \rightarrow \mathbb{R}^m \cup \{\infty\}^m$ : models  $m$  constraints  
 $c_j(x), j \in \{1, \dots, m\}$
- ▶  $J \subseteq \{0, 1, \dots, m\}$  user-defined indexes of outputs
- ▶  $d : X \rightarrow \mathbb{R}$ : remoteness constraint

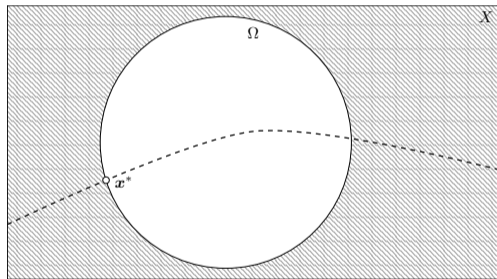

$$\Omega = \{x \in X : c(x) \leq 0\}$$

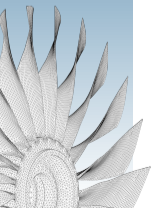



## Blackbox optimization problem

$$\begin{aligned}
 & \min_{x \in X} f(x) \\
 & \text{subject to } c(x) \leq 0 \\
 & \text{and } d(x) \leq 0 \iff x \text{ "far" from discontinuities of outputs } j \in J
 \end{aligned} \tag{1}$$

## • notations

- ▶  $x \in X \subseteq \mathbb{R}^n$ : vector of variables
- ▶  $f : X \rightarrow \mathbb{R} \cup \{\infty\}$ : objective function
- ▶  $c : X \rightarrow \mathbb{R}^m \cup \{\infty\}^m$ : models  $m$  constraints  
 $c_j(x), j \in \{1, \dots, m\}$
- ▶  $J \subseteq \{0, 1, \dots, m\}$  user-defined indexes of outputs
- ▶  $d : X \rightarrow \mathbb{R}$ : remoteness constraint

## • characteristics

- ▶  $f$  and  $c$ : deterministic **blackbox** functions, possibly **discontinuous**

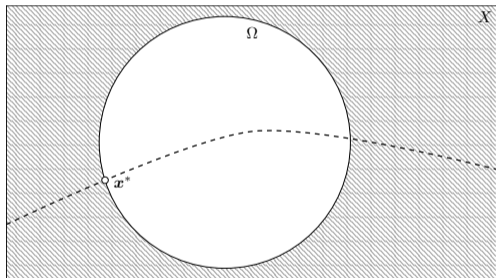

$$\Omega = \{x \in X : c(x) \leq 0\}$$

## Blackbox optimization problem

$$\begin{aligned}
 & \min_{x \in X} f(x) \\
 & \text{subject to } c(x) \leq 0 \\
 & \text{and } d(x) \leq 0 \iff x \text{ "far" from discontinuities of outputs } j \in J
 \end{aligned} \tag{1}$$

- notations

- ▶  $x \in X \subseteq \mathbb{R}^n$ : vector of variables
- ▶  $f : X \rightarrow \mathbb{R} \cup \{\infty\}$ : objective function
- ▶  $c : X \rightarrow \mathbb{R}^m \cup \{\infty\}^m$ : models  $m$  constraints  $c_j(x), j \in \{1, \dots, m\}$
- ▶  $J \subseteq \{0, 1, \dots, m\}$  user-defined indexes of outputs
- ▶  $d : X \rightarrow \mathbb{R}$ : remoteness constraint

- characteristics

- ▶  $f$  and  $c$ : deterministic **blackbox** functions, possibly **discontinuous**
- ▶  $d$ : **infinite constraint**

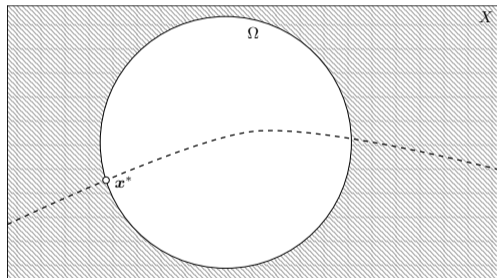

$$\Omega = \{x \in X : c(x) \leq 0\}$$

$$\begin{aligned}
 & \min_{x \in X} f(x) \\
 & \text{subject to } c(x) \leq 0 \\
 & \text{and } d(x) \leq 0 \iff x \text{ "far" from discontinuities of outputs } j \in J
 \end{aligned} \tag{1}$$

- notations

- ▶  $x \in X \subseteq \mathbb{R}^n$ : vector of variables
- ▶  $f : X \rightarrow \mathbb{R} \cup \{\infty\}$ : objective function
- ▶  $c : X \rightarrow \mathbb{R}^m \cup \{\infty\}^m$ : models  $m$  constraints  $c_j(x), j \in \{1, \dots, m\}$
- ▶  $J \subseteq \{0, 1, \dots, m\}$  user-defined indexes of outputs
- ▶  $d : X \rightarrow \mathbb{R}$ : remoteness constraint

- characteristics

- ▶  $f$  and  $c$ : deterministic **blackbox** functions, possibly **discontinuous**
- ▶  $d$ : **infinite** constraint

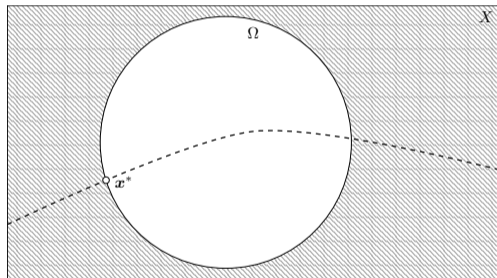

$$\Omega = \{x \in X : c(x) \leq 0\}$$

Objective: a Mesh Adaptive Direct Search algorithm to solve problem (1)



Context

Modeling

Basics on Mads

DiscoMads

Convergence

Results

Conclusion

① Context

② Modeling

③ Basics on Mads

④ DiscoMads

⑤ Convergence analysis

⑥ Numerical results

⑦ Conclusion





Context

Modeling

Basics on Mads

DiscoMads

Convergence

Results

Conclusion

① Context

② Modeling

③ Basics on Mads

④ DiscoMads

⑤ Convergence analysis

⑥ Numerical results

⑦ Conclusion





# Modeling of discontinuities

$$\min_{x \in X} f(x)$$

$$\text{s.t. } c(x) \leq 0$$

and  $d(x) \leq 0 \iff x$  "far" from discontinuities of outputs  $j \in J$

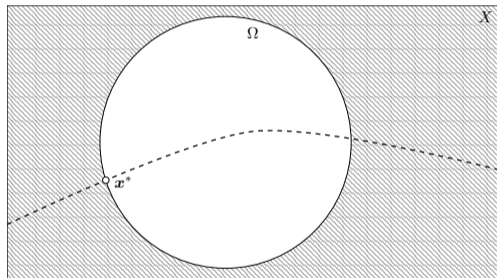

## Modeling of discontinuities

$$\min_{x \in X} f(x)$$

$$\text{s.t. } c(x) \leq 0$$

$$\text{and } d(x) \leq 0 \iff x \text{ "far" from discontinuities of outputs } j \in J$$

- **region of weak discontinuities  $D$  (■):**  
rate of change of  $c_j, j \in J$  between  
two points at distance at most  $r_d$   
exceeds a limit rate  $\tau$

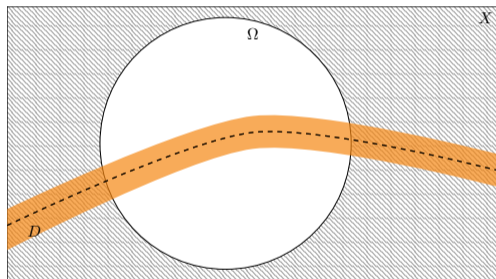

$$D = \{y \in X : \exists j \in J, \exists z \in X \cap B_{r_d}(y), |c_j(y) - c_j(z)| > \tau \|y - z\|\}$$

$$\min_{x \in X} f(x)$$

$$\text{s.t. } c(x) \leq 0$$

$$\text{and } d(x) \leq 0 \iff x \text{ "far" from discontinuities of outputs } j \in J$$

- region of weak discontinuities  $D$  (■):**  
 rate of change of  $c_j, j \in J$  between two points at distance at most  $r_d$  exceeds a limit rate  $\tau$
- safety margin  $M$  (■  $\cup$  ■):** region of radius  $r_e$  around  $D$

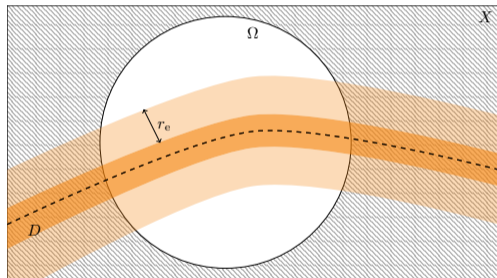

$$D = \{y \in X : \exists j \in J, \exists z \in X \cap B_{r_d}(y), |c_j(y) - c_j(z)| > \tau \|y - z\|\}$$

$$M = X \cap (\cup_{x \in D} B_{r_e}(x))$$

$$\begin{aligned} & \min_{x \in X} f(x) \\ & \text{s.t. } c(x) \leq 0 \\ & \text{and } d(x) \leq 0 \iff x \text{ "far" from discontinuities of outputs } j \in J \end{aligned}$$

- region of weak discontinuities  $D$  (■):**  
 rate of change of  $c_j, j \in J$  between two points at distance at most  $r_d$  exceeds a limit rate  $\tau$
- safety margin  $M$  (■  $\cup$  ■):** region of radius  $r_e$  around  $D$

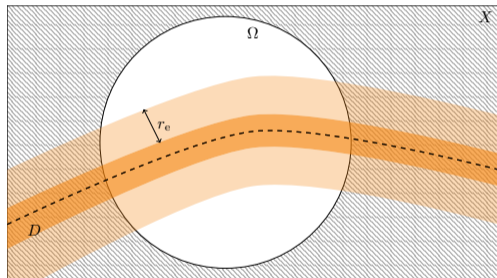

$$\begin{aligned} D &= \{y \in X : \exists j \in J, \exists z \in X \cap B_{r_d}(y), |c_j(y) - c_j(z)| > \tau \|y - z\|\} \\ M &= X \cap (\cup_{x \in D} B_{r_e}(x)) \\ x \notin M &\iff d(x) \leq 0 \end{aligned}$$

$$\min_{x \in X} f(x)$$

$$\text{s.t. } c(x) \leq 0$$

$$\text{and } d(x) \leq 0 \iff x \text{ "far" from discontinuities of outputs } j \in J$$

- **region of weak discontinuities**  $D$  (■): rate of change of  $c_j, j \in J$  between two points at distance at most  $r_d$  exceeds a limit rate  $\tau$
- **safety margin**  $M$  (■  $\cup$  ■): region of radius  $r_e$  around  $D$

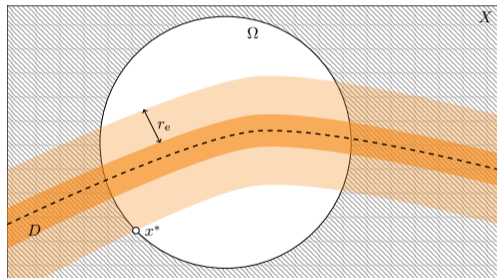

$$D = \{y \in X : \exists j \in J, \exists z \in X \cap B_{r_d}(y), |c_j(y) - c_j(z)| > \tau \|y - z\|\}$$

$$M = X \cap (\cup_{x \in D} B_{r_e}(x))$$

$$x \notin M \iff d(x) \leq 0$$



Context

Modeling

Basics on Mads

Mads

Mads-PB

DiscoMads

Convergence

Results

Conclusion

① Context

② Modeling

③ Basics on Mads

④ DiscoMads

⑤ Convergence analysis

⑥ Numerical results

⑦ Conclusion

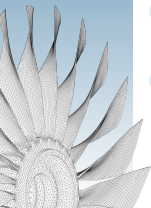

# Mesh Adaptive Direct Search<sup>2</sup> (Mads) for unconstrained problems

$$\min_{x \in X} f(x)$$

DFO  
Symposium



Context

Modeling

Basics on Mads

Mads

Mads-PB

DiscoMads

Convergence

Results

Conclusion

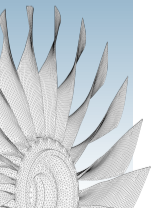

---

<sup>2</sup>C. Audet et al. *SIAM Journal on Optimization* (2006). doi: 10.1137/040603371.

$$\min_{x \in X} f(x)$$

## A Mads iteration

iteration  $k = 0$

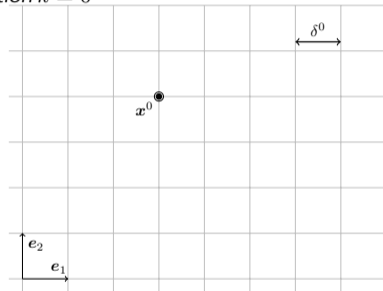



$$\min_{x \in X} f(x)$$

## A Mads iteration

- Aim : find a better solution than the current incumbent  $x^k$  on the mesh of size  $\delta^k$

iteration  $k = 0$

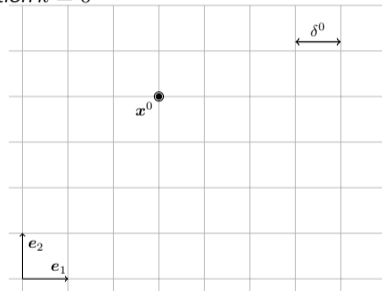

$$\min_{x \in X} f(x)$$

## A Mads iteration

- Aim : find a better solution than the current incumbent  $x^k$  on the mesh of size  $\delta^k$

iteration  $k = 0$

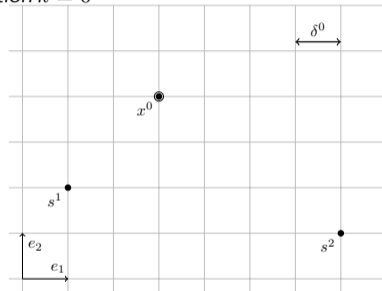

### 1 search

- ▶ user-defined, optional

- search

Mesh Adaptive Direct Search<sup>2</sup> (Mads) for unconstrained problems

$$\min_{x \in X} f(x)$$

## A Mads iteration

- Aim : find a better solution than the current incumbent  $x^k$  on the mesh of size  $\delta^k$

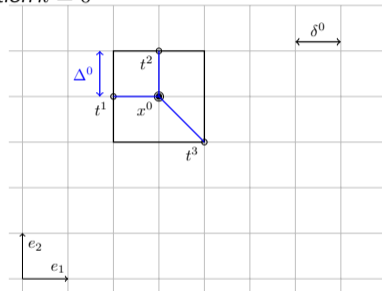
iteration  $k = 0$ 

## ① search

- ▶ user-defined, optional

## ② poll

- ▶ poll directions in frame of size  $\Delta^k$

- search

- poll

- ▶  $f(x^0) \leq f(t^1)$

Mesh Adaptive Direct Search<sup>2</sup> (Mads) for unconstrained problems

$$\min_{x \in X} f(x)$$

## A Mads iteration

- Aim : find a better solution than the current incumbent  $x^k$  on the mesh of size  $\delta^k$

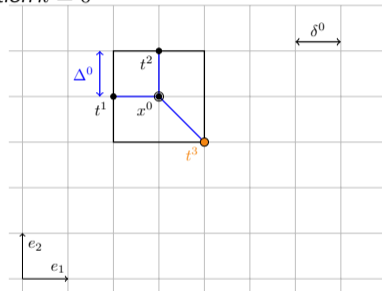
iteration  $k = 0$ 

## 1 search

- ▶ user-defined, optional

## 2 poll

- ▶ poll directions in frame of size  $\Delta^k$

## • search

## • poll

- ▶  $f(x^0) \leq f(t^1)$
- ▶  $f(x^0) \leq f(t^2)$
- ▶  $f(x^0) > f(t^3) \Rightarrow$  success

Mesh Adaptive Direct Search<sup>2</sup> (Mads) for unconstrained problems

$$\min_{x \in X} f(x)$$

## A Mads iteration

- Aim : find a better solution than the current incumbent  $x^k$  on the mesh of size  $\delta^k$

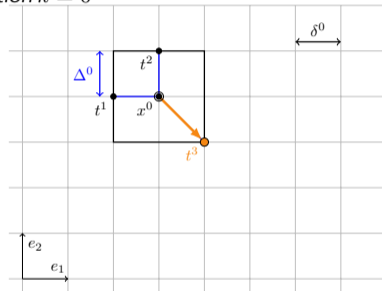
iteration  $k = 0$ 

## ① search

- ▶ user-defined, optional

## ② poll

- ▶ poll directions in frame of size  $\Delta^k$

## ③ update depending on success/failure

- ▶ computation of  $\Delta^{k+1}$ ,  $\delta^{k+1}$ ,  $x^{k+1}$

## • search

## • poll

- ▶  $f(x^0) \leq f(t^1)$
- ▶  $f(x^0) \leq f(t^2)$
- ▶  $f(x^0) > f(t^3) \Rightarrow$  success

$$\min_{x \in X} f(x)$$

## A Mads iteration

- Aim : find a better solution than the current incumbent  $x^k$  on the mesh of size  $\delta^k$

### 1 search

- ▶ user-defined, optional

### 2 poll

- ▶ poll directions in frame of size  $\Delta^k$

### 3 update depending on success/failure

- ▶ computation of  $\Delta^{k+1}$ ,  $\delta^{k+1}$ ,  $x^{k+1}$

iteration  $k = 1$

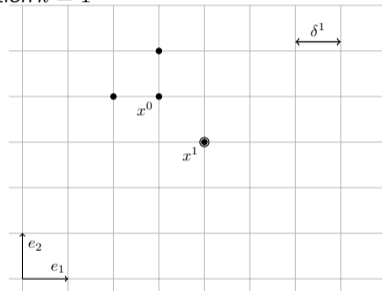

- search
- poll

$$\min_{x \in X} f(x)$$

## A Mads iteration

- Aim : find a better solution than the current incumbent  $x^k$  on the mesh of size  $\delta^k$

iteration  $k = 1$

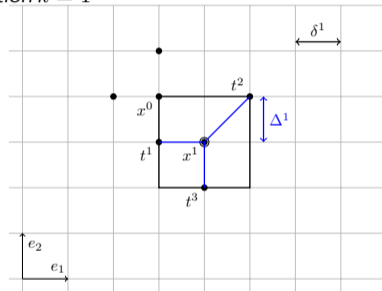

### 1 search

- ▶ user-defined, optional

### 2 poll

- ▶ poll directions in frame of size  $\Delta^k$

### 3 update depending on success/failure

- ▶ computation of  $\Delta^{k+1}$ ,  $\delta^{k+1}$ ,  $x^{k+1}$

### • search

### • poll

- ▶  $f(x^1) \leq f(t^4)$
- ▶  $f(x^1) \leq f(t^5)$
- ▶  $f(x^1) \leq f(t^6) \Rightarrow$  failure

Mesh Adaptive Direct Search<sup>2</sup> (Mads) for unconstrained problems

$$\min_{x \in X} f(x)$$

## A Mads iteration

- Aim : find a better solution than the current incumbent  $x^k$  on the mesh of size  $\delta^k$

iteration  $k = 2$ **1 search**

- ▶ user-defined, optional

**2 poll**

- ▶ poll directions in frame of size  $\Delta^k$

**3 update** depending on success/failure

- ▶ computation of  $\Delta^{k+1}$ ,  $\delta^{k+1}$ ,  $x^{k+1}$

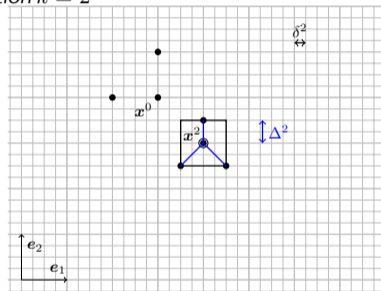





# Mads<sup>3</sup> for constrained problems

$$\begin{array}{ll} \min_{x \in X} & f(x) \\ \text{s.t.} & c(x) \leq 0 \end{array}$$

## A Mads iteration

- Aim : find a better solution than the current incumbent  $x^k$  on the mesh of size  $\delta^k$
- ① **search**
  - ▶ user-defined, optional
- ② **poll**
  - ▶ poll directions in frame of size  $\Delta^k$
- ③ **update** depending on success/failure
  - ▶ computation of  $\Delta^{k+1}, \delta^{k+1}, x^{k+1}$



# Mads<sup>3</sup> for constrained problems

$$\begin{array}{ll} \min_{x \in X} & f(x) \\ \text{s.t.} & c(x) \leq 0 \end{array}$$

## A Mads iteration

- Aim : find a better solution than the current incumbent  $x^k$  on the mesh of size  $\delta^k$

### 1 search

- ▶ user-defined, optional

### 2 poll

- ▶ poll directions in frame of size  $\Delta^k$

### 3 update depending on success/failure

- ▶ computation of  $\Delta^{k+1}, \delta^{k+1}, x^{k+1}$

### Progressive barrier approach

- constraint violation function

$$h(x) = \begin{cases} \sum_{j=1}^m (\max(c_j(x), 0))^2 & \text{if } x \in X, \\ \infty & \text{otherwise} \end{cases}$$

Mads<sup>3</sup> for constrained problems

$$\begin{aligned} \min_{x \in X} \quad & f(x) \\ \text{s.t.} \quad & c(x) \leq 0 \end{aligned}$$

## A Mads iteration

- Aim : find a better solution than the current incumbent  $x^k$  on the mesh of size  $\delta^k$

## ① search

- ▶ user-defined, optional

## ② poll

- ▶ poll directions in frame of size  $\Delta^k$

## ③ update depending on success/failure

- ▶ computation of  $\Delta^{k+1}$ ,  $\delta^{k+1}$ ,  $x^{k+1}$

## Progressive barrier approach

- constraint violation function

$$h(x) = \begin{cases} \sum_{j=1}^m (\max(c_j(x), 0))^2 & \text{if } x \in X, \\ \infty & \text{otherwise} \end{cases}$$

- ▶ threshold  $h_{\max}^k$  to reject points

Mads<sup>3</sup> for constrained problems

$$\begin{array}{ll} \min_{x \in X} & f(x) \\ \text{s.t.} & c(x) \leq 0 \end{array}$$

## A Mads iteration

- Aim : find a better solution than the current incumbent  $x^k$  on the mesh of size  $\delta^k$

## ① search

- ▶ user-defined, optional

## ② poll

- ▶ poll directions in frame of size  $\Delta^k$

## ③ update depending on success/failure

- ▶ computation of  $\Delta^{k+1}$ ,  $\delta^{k+1}$ ,  $x^{k+1}$

## Progressive barrier approach

- constraint violation function

$$h(x) = \begin{cases} \sum_{j=1}^m (\max(c_j(x), 0))^2 & \text{if } x \in X, \\ \infty & \text{otherwise} \end{cases}$$

- ▶ threshold  $h_{\max}^k$  to reject points
- dominance relation based on  $f$  and  $h$  values

Mads<sup>3</sup> for constrained problems

$$\begin{array}{ll} \min_{x \in X} & f(x) \\ \text{s.t.} & c(x) \leq 0 \end{array}$$

A Mads iteration **with the progressive barrier approach**

- Aim : find a better solution than the current incumbent  $x^k$  on the mesh of size  $\delta^k$

## ① search

- ▶ user-defined, optional

## ② poll

- ▶ poll directions in frame of size  $\Delta^k$

## ③ update depending on success/failure

- ▶ computation of  $\Delta^{k+1}, \delta^{k+1}, x^{k+1}$

## Progressive barrier approach

- constraint violation function

$$h(x) = \begin{cases} \sum_{j=1}^m (\max(c_j(x), 0))^2 & \text{if } x \in X, \\ \infty & \text{otherwise} \end{cases}$$

- ▶ threshold  $h_{\max}^k$  to reject points
- dominance relation based on  $f$  and  $h$  values

$$\begin{aligned} \min_{x \in X} \quad & f(x) \\ \text{s.t.} \quad & c(x) \leq 0 \end{aligned}$$

## A Mads iteration **with the progressive barrier approach**

- Aim : find a better solution than the current incumbent  $x^k$  on the mesh of size  $\delta^k$

### 1 search

- ▶ user-defined, optional

### 2 poll

- ▶ poll directions in frame of size  $\Delta^k$

### 3 update depending on **success/failure**

- ▶ computation of  $\Delta^{k+1}, \delta^{k+1}, x^{k+1}$

### Progressive barrier approach

- constraint violation function

$$h(x) = \begin{cases} \sum_{j=1}^m (\max(c_j(x), 0))^2 & \text{if } x \in X, \\ \infty & \text{otherwise} \end{cases}$$

- ▶ threshold  $h_{\max}^k$  to reject points
- dominance relation based on  $f$  and  $h$  values

$$\begin{aligned} \min_{x \in X} \quad & f(x) \\ \text{s.t.} \quad & c(x) \leq 0 \end{aligned}$$

## A Mads iteration with the progressive barrier approach

- Aim : find a better solution than the current incumbent  $x^k$  on the mesh of size  $\delta^k$

### 1 search

- ▶ user-defined, optional

### 2 poll

- ▶ poll directions in frame of size  $\Delta^k$

### 3 update depending on success/failure

- ▶ computation of  $\Delta^{k+1}$ ,  $\delta^{k+1}$ ,  $x^{k+1}$ ,  $h_{\max}^{k+1}$

### Progressive barrier approach

- constraint violation function

$$h(x) = \begin{cases} \sum_{j=1}^m (\max(c_j(x), 0))^2 & \text{if } x \in X, \\ \infty & \text{otherwise} \end{cases}$$

- ▶ threshold  $h_{\max}^k$  to reject points
- dominance relation based on  $f$  and  $h$  values



Context

Modeling

Basics on Mads

DiscoMads

Principle

Ingredients

Convergence

Results

Conclusion

① Context

② Modeling

③ Basics on Mads

④ DiscoMads

⑤ Convergence analysis

⑥ Numerical results

⑦ Conclusion

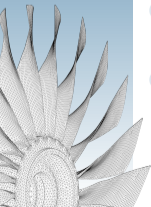





## Proposed algorithm: DiscoMads

$$\begin{array}{ll} \min_{x \in X} & f(x) \\ \text{s.t.} & c(x) \leq 0 \\ \text{and} & d(x) \leq 0 \end{array}$$

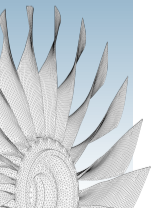



# Proposed algorithm: DiscoMads

## A DiscoMads iteration

- Aim : find a better solution than the current incumbent  $x^k$  on the mesh of size  $\delta^k$

### 1 search

- ▶ user-defined, optional

### 2 poll

- ▶ poll directions in frame of size  $\Delta^k$

### 3 update depending on success/failure

- ▶ computation of  $\Delta^{k+1}$ ,  $\delta^{k+1}$ ,  $x^{k+1}$ ,  $h_{\max}^{k+1}$

$$\begin{aligned} \min_{x \in X} \quad & f(x) \\ \text{s.t.} \quad & c(x) \leq 0 \\ \text{and} \quad & d(x) \leq 0 \end{aligned}$$

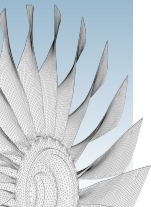



# Proposed algorithm: DiscoMads

## A DiscoMads iteration

- Aim : find a better solution than the current incumbent  $x^k$  on the mesh of size  $\delta^k$

### 1 search

- ▶ user-defined, optional
- ▶ revelation after each evaluation

### 2 poll

- ▶ poll directions in frame of size  $\Delta^k$
- ▶ revelation after each evaluation

### 3 update depending on success/failure

- ▶ computation of  $\Delta^{k+1}$ ,  $\delta^{k+1}$ ,  $x^{k+1}$ ,  $h_{\max}^{k+1}$

$$\begin{aligned} \min_{x \in X} \quad & f(x) \\ \text{s.t.} \quad & c(x) \leq 0 \\ \text{and} \quad & d(x) \leq 0 \end{aligned}$$

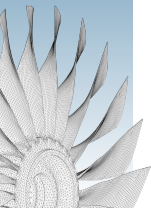



## Proposed algorithm: DiscoMads

$$\begin{aligned} \min_{x \in X} \quad & f(x) \\ \text{s.t.} \quad & c(x) \leq 0 \\ \text{and} \quad & d(x) \leq 0 \end{aligned}$$

## A DiscoMads iteration

- Aim : find a better solution than the current incumbent  $x^k$  on the mesh of size  $\delta^k$

iteration  $k = 1$ 

## ① search

- ▶ user-defined, optional
- ▶ revelation after each evaluation

## ② poll

- ▶ poll directions in frame of size  $\Delta^k$
- ▶ revelation after each evaluation

## ③ update depending on success/failure

- ▶ computation of  $\Delta^{k+1}$ ,  $\delta^{k+1}$ ,  $x^{k+1}$ ,  $h_{\max}^{k+1}$

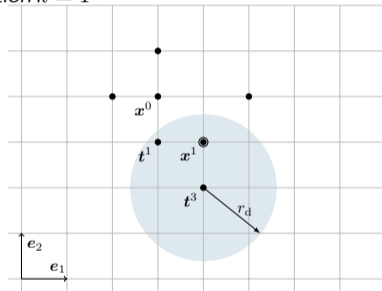

- revelation



## Proposed algorithm: DiscoMads

$$\begin{aligned} \min_{x \in X} \quad & f(x) \\ \text{s.t.} \quad & c(x) \leq 0 \\ \text{and} \quad & d(x) \leq 0 \end{aligned}$$

## A DiscoMads iteration

- Aim : find a better solution than the current incumbent  $x^k$  on the mesh of size  $\delta^k$

iteration  $k = 1$ 

## ① search

- ▶ user-defined, optional
- ▶ revelation after each evaluation

## ② poll

- ▶ poll directions in frame of size  $\Delta^k$
- ▶ revelation after each evaluation

## ③ update depending on success/failure

- ▶ computation of  $\Delta^{k+1}, \delta^{k+1}, x^{k+1}, h_{\max}^{k+1}$

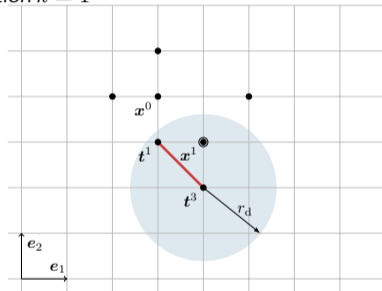

## • revelation

- ▶  $|f(t^1) - f(t^3)| \leq \tau \|t^1 - t^3\|$



# Proposed algorithm: DiscoMads

$$\begin{aligned} \min_{x \in X} \quad & f(x) \\ \text{s.t.} \quad & c(x) \leq 0 \\ \text{and} \quad & d(x) \leq 0 \end{aligned}$$

## A DiscoMads iteration

- Aim : find a better solution than the current incumbent  $x^k$  on the mesh of size  $\delta^k$

iteration  $k = 1$

### 1 search

- ▶ user-defined, optional
- ▶ revelation after each evaluation

### 2 poll

- ▶ poll directions in frame of size  $\Delta^k$
- ▶ revelation after each evaluation

### 3 update depending on success/failure

- ▶ computation of  $\Delta^{k+1}, \delta^{k+1}, x^{k+1}, h_{\max}^{k+1}$

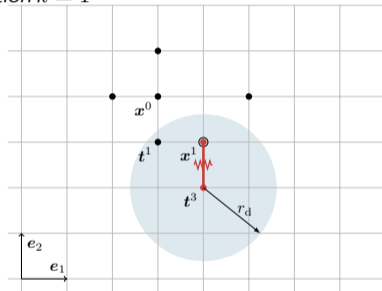

### • revelation

- ▶  $|f(t^1) - f(t^3)| \leq \tau \|t^1 - t^3\|$
- ▶  $|f(t^3) - f(x^1)| > \tau \|t^3 - x^1\|$   
 $\implies x^1$  and  $t^3$  revealing points  $\in D$



## Proposed algorithm: DiscoMads

$$\begin{aligned} \min_{x \in X} \quad & f(x) \\ \text{s.t.} \quad & c(x) \leq 0 \\ \text{and} \quad & d(x) \leq 0 \end{aligned}$$

## A DiscoMads iteration

- Aim : find a better solution than the current incumbent  $x^k$  on the mesh of size  $\delta^k$

iteration  $k = 1$ 

## ① search

- ▶ user-defined, optional
- ▶ revelation after each evaluation

## ② poll

- ▶ poll directions in frame of size  $\Delta^k$
- ▶ revelation after each evaluation

## ③ update depending on success/failure

- ▶ computation of  $\Delta^{k+1}$ ,  $\delta^{k+1}$ ,  $x^{k+1}$ ,  $h_{\max}^{k+1}$

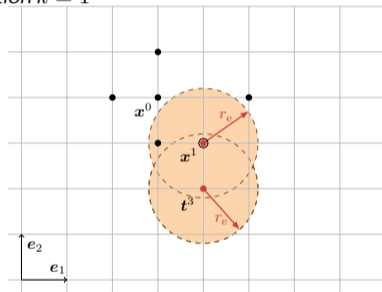

- revelation

- exclusion

- ▶ exclusion constraint around  $x^1$  and  $t^3$



## Proposed algorithm: DiscoMads

$$\begin{aligned} \min_{x \in X} \quad & f(x) \\ \text{s.t.} \quad & c(x) \leq 0 \\ \text{and} \quad & d(x) \leq 0 \end{aligned}$$

## A DiscoMads iteration

- Aim : find a better solution than the current incumbent  $x^k$  on the mesh of size  $\delta^k$

iteration  $k = 1$ 

## ① search

- ▶ user-defined, optional
- ▶ revelation after each evaluation

## ② poll

- ▶ poll directions in frame of size  $\Delta^k$
- ▶ revelation after each evaluation

## ③ update depending on success/failure or revelation

- ▶ computation of  $\Delta^{k+1}$ ,  $\delta^{k+1}$ ,  $x^{k+1}$ ,  $h_{\max}^{k+1}$

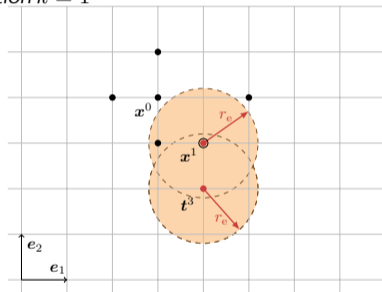

- revelation

- exclusion

- ▶ exclusion constraint around  $x^1$  and  $t^3$





## Proposed algorithm: DiscoMads

$$\begin{aligned} \min_{x \in X} \quad & f(x) \\ \text{s.t.} \quad & c(x) \leq 0 \\ \text{and} \quad & d(x) \leq 0 \end{aligned}$$

## A DiscoMads iteration

- Aim : find a better solution than the current incumbent  $x^k$  on the mesh of size  $\delta^k$

iteration  $k = 1$ 

## 1 search

- ▶ user-defined, optional
- ▶ revelation after each evaluation

## 2 poll

- ▶ revealing poll: random point(s) around  $x^k$
- ▶ poll directions in frame of size  $\Delta^k$
- ▶ revelation after each evaluation

## 3 update depending on success/failure or revelation

- ▶ computation of  $\Delta^{k+1}$ ,  $\delta^{k+1}$ ,  $x^{k+1}$ ,  $h_{\max}^{k+1}$

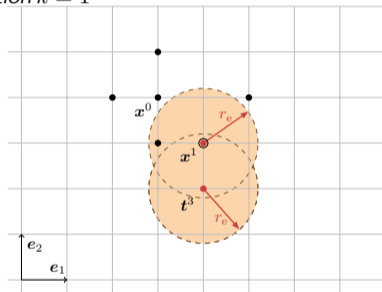

- revelation

- exclusion

- ▶ exclusion constraint around  $x^1$  and  $t^3$

# Revelation and exclusion

DFO  
Symposium



Context

Modeling

Basics on Mads

DiscoMads

Principle

Ingredients

Convergence

Results

Conclusion

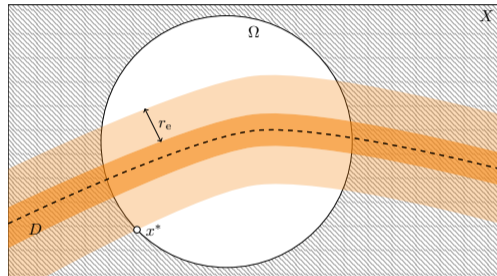





## Revelation and exclusion

- ① set of **revealing points**  $D^k$  at iteration  $k$

$$D^k = \{y \in V^k \cap X : \exists z \in V^k \cap X \cap B_{r_d}(y), \exists j \in J, |c_j(y) - c_j(z)| > \tau \|y - z\|\} \in D$$

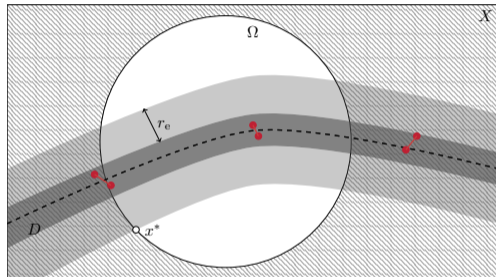



## Revelation and exclusion

- ① set of **revealing points**  $D^k$  at iteration  $k$

$$D^k = \{y \in V^k \cap X : \exists z \in V^k \cap X \cap B_{r_d}(y), \exists j \in J, |c_j(y) - c_j(z)| > \tau \|y - z\|\} \in D$$

- ② **exclusion constraint**  $d^k$  at iteration  $k$

$$d^k(x) = \begin{cases} 1 - \frac{\text{dist}(x, D^k)}{r_e} & \text{if } D^k \cap B_{r_e}(x) \neq \emptyset, \\ 0 & \text{otherwise} \end{cases}$$

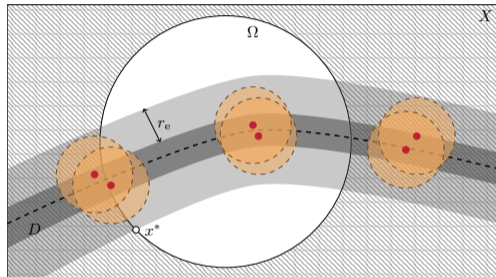



## Revelation and exclusion

- ① set of **revealing points**  $D^k$  at iteration  $k$

$$D^k = \{y \in V^k \cap X : \exists z \in V^k \cap X \cap B_{r_d}(y), \exists j \in J, |c_j(y) - c_j(z)| > \tau \|y - z\|\} \in D$$

- ② **exclusion constraint**  $d^k$  at iteration  $k$

$$d^k(x) = \begin{cases} 1 - \frac{\text{dist}(x, D^k)}{r_e} & \text{if } D^k \cap B_{r_e}(x) \neq \emptyset, \\ 0 & \text{otherwise} \end{cases}$$

problem solved at iteration  $k$

$$\begin{aligned} \min_{x \in X} \quad & f(x) \\ \text{s.t.} \quad & c(x) \leq 0 \\ \text{and} \quad & \mathbf{d}^k(\mathbf{x}) \leq 0 \end{aligned}$$

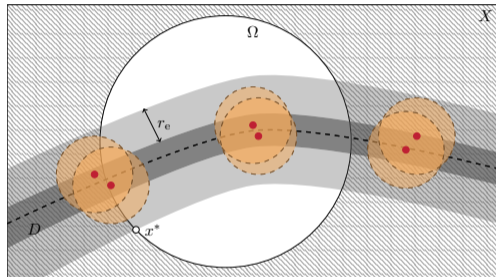



## Revelation and exclusion

- ① set of **revealing points**  $D^k$  at iteration  $k$

$$D^k = \{y \in V^k \cap X : \exists z \in V^k \cap X \cap B_{r_d}(y), \exists j \in J, |c_j(y) - c_j(z)| > \tau \|y - z\|\} \in D$$

- ② **exclusion constraint**  $d^k$  at iteration  $k$

$$d^k(x) = \begin{cases} 1 - \frac{\text{dist}(x, D^k)}{r_e} & \text{if } D^k \cap B_{r_e}(x) \neq \emptyset, \\ 0 & \text{otherwise} \end{cases}$$

problem solved at iteration  $k$

$$\begin{aligned} \min_{x \in X} \quad & f(x) \\ \text{s.t.} \quad & c(x) \leq 0 \\ \text{and} \quad & \mathbf{d}^k(\mathbf{x}) \leq \mathbf{0} \end{aligned}$$

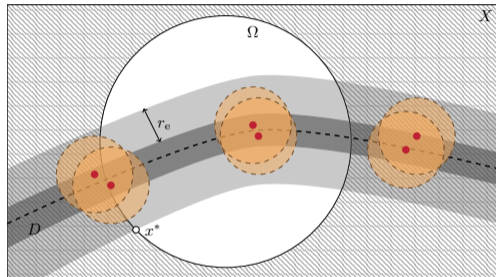

- progressive barrier approach

- ▶ constraint violation function  $h^k$

$$h^k(x) = \begin{cases} \sum_{j=1}^m \max(c_j(x), 0)^2 + \max(d^k(x), 0)^2 & \text{if } x \in X \\ \infty & \text{otherwise} \end{cases}$$

# Revealing iteration

- 1 revealing point is found during iteration  $k \implies$  stop evaluations
  - ▶ set  $R$  of new revealing points

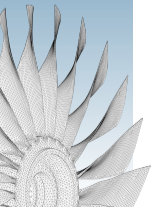





## Revealing iteration

- 1 revealing point is found during iteration  $k \implies$  stop evaluations
  - ▶ set  $R$  of new revealing points
- 2 update set of revealing points

$$D^{k+1} \leftarrow D^k \cup R$$

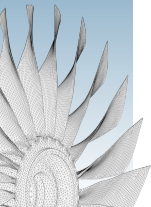



## Revealing iteration

- 1 revealing point is found during iteration  $k \implies$  stop evaluations
  - ▶ set  $R$  of new revealing points

- 2 update set of revealing points

$$D^{k+1} \leftarrow D^k \cup R$$

- 3 update exclusion constraint and constraints violation function

$$d^{k+1}(x) \geq d^k(x)$$

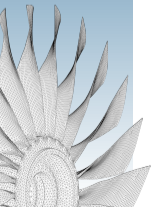



## Revealing iteration

- 1 revealing point is found during iteration  $k \implies$  stop evaluations
  - ▶ set  $R$  of new revealing points

- 2 update set of revealing points

$$D^{k+1} \leftarrow D^k \cup R$$

- 3 update exclusion constraint and constraints violation function

$$d^{k+1}(x) \geq d^k(x) \implies h^{k+1}(x) \geq h^k(x) \quad \text{may change the feasibility of points !}$$

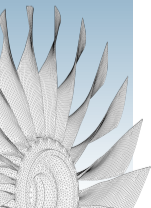



## Revealing iteration

- 1 revealing point is found during iteration  $k \implies$  stop evaluations
  - ▶ set  $R$  of new revealing points

- 2 update set of revealing points

$$D^{k+1} \leftarrow D^k \cup R$$

- 3 update exclusion constraint and constraints violation function

$$d^{k+1}(x) \geq d^k(x) \implies h^{k+1}(x) \geq h^k(x) \quad \text{may change the feasibility of points !}$$

- 4 update barrier threshold adequately and Mads parameters

$$\delta^{k+1} = \delta^k \quad \text{and} \quad \Delta^{k+1} = \Delta^k$$

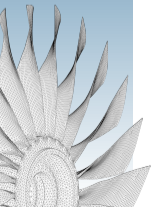



## Revealing iteration

- 1 revealing point is found during iteration  $k \implies$  stop evaluations
  - ▶ set  $R$  of new revealing points

- 2 update set of revealing points

$$D^{k+1} \leftarrow D^k \cup R$$

- 3 update exclusion constraint and constraints violation function

$$d^{k+1}(x) \geq d^k(x) \implies h^{k+1}(x) \geq h^k(x) \quad \text{may change the feasibility of points !}$$

- 4 update barrier threshold adequately and Mads parameters

$$\delta^{k+1} = \delta^k \quad \text{and} \quad \Delta^{k+1} = \Delta^k$$

## Revealing poll

- unsuccessful iterations  $\implies$  poll size parameter  $\Delta^k \searrow \implies$  discontinuities may not be revealed

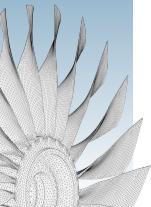



## Revealing iteration

- 1 revealing point is found during iteration  $k \implies$  stop evaluations
  - ▶ set  $R$  of new revealing points

- 2 update set of revealing points

$$D^{k+1} \leftarrow D^k \cup R$$

- 3 update exclusion constraint and constraints violation function

$$d^{k+1}(x) \geq d^k(x) \implies h^{k+1}(x) \geq h^k(x) \quad \text{may change the feasibility of points !}$$

- 4 update barrier threshold adequately and Mads parameters

$$\delta^{k+1} = \delta^k \quad \text{and} \quad \Delta^{k+1} = \Delta^k$$

## Revealing poll

- unsuccessful iterations  $\implies$  poll size parameter  $\Delta^k \searrow \implies$  discontinuities may not be revealed
- at least 1 random point in  $B_{r_m}(x^k)$  with  $r_m > r_d + r_e$



Context

Modeling

Basics on Mads

DiscoMads

Convergence

Objective

Steps

Results

Conclusion

① Context

② Modeling

③ Basics on Mads

④ DiscoMads

⑤ Convergence analysis

⑥ Numerical results

⑦ Conclusion

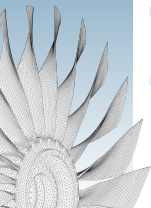

# Convergence analysis in brief

Draw optimality conditions related to the original problem (1)

$$\begin{aligned} & \min_{x \in X} f(x) \\ (1) \quad & \text{s.t. } c(x) \leq 0 \\ & \text{and } d(x) \leq 0 \end{aligned}$$

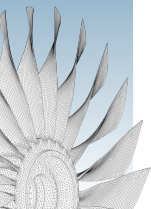



Draw optimality conditions related to the original problem (1)

$$\begin{aligned} & \min_{x \in X} f(x) \\ (1) \quad & \text{s.t. } c(x) \leq 0 \\ & \text{and } d(x) \leq 0 \end{aligned} \quad \text{with remoteness constraint } d(x) = \begin{cases} 1 - \frac{\text{dist}(x, D)}{r_e} & \text{if } D \cap B_{r_e}(x) \neq \emptyset, \\ 0 & \text{otherwise} \end{cases}$$



## Convergence analysis in brief

Draw optimality conditions related to the original problem (1)

$$\begin{aligned} & \min_{x \in X} f(x) \\ (1) \quad & \text{s.t. } c(x) \leq 0 \quad \text{with remoteness constraint } d(x) = \begin{cases} 1 - \frac{\text{dist}(x, D)}{r_e} & \text{if } D \cap B_{r_e}(x) \neq \emptyset, \\ 0 & \text{otherwise} \end{cases} \\ & \text{and } d(x) \leq 0 \end{aligned}$$

- "ideal" constraint violation function

$$\hat{h}(x) = \begin{cases} \sum_{j=1}^m \max(c_j(x), 0)^2 + \max(d(x), 0)^2 & \text{if } x \in X \\ \infty & \text{otherwise} \end{cases}$$

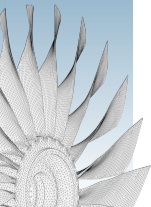

Draw optimality conditions related to the original problem (1)

$$(1) \quad \begin{array}{ll} \min_{x \in X} & f(x) \\ \text{s.t.} & c(x) \leq 0 \\ \text{and} & d(x) \leq 0 \end{array} \quad \begin{array}{l} \text{with remoteness constraint} \\ d(x) = \begin{cases} 1 - \frac{\text{dist}(x, D)}{r_e} & \text{if } D \cap B_{r_e}(x) \neq \emptyset, \\ 0 & \text{otherwise} \end{cases} \end{array}$$

- "ideal" constraint violation function

$$\hat{h}(x) = \begin{cases} \sum_{j=1}^m \max(c_j(x), 0)^2 + \max(d(x), 0)^2 & \text{if } x \in X \\ \infty & \text{otherwise} \end{cases}$$

- ▶ only  $d^k$  and  $h^k$  are accessible !

# Convergence analysis in brief

DFO  
Symposium



Context

Modeling

Basics on Mads

DiscoMads

Convergence

Objective

Steps

Results

Conclusion

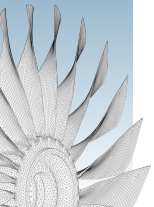



## Convergence analysis in brief

- 1 mesh gets infinitely fine :  $\liminf_{k \rightarrow \infty} \delta^k = 0$

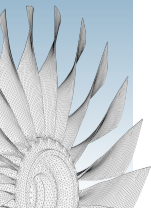



# Convergence analysis in brief

- 1 mesh gets infinitely fine :  $\liminf_{k \rightarrow \infty} \delta^k = 0$
- 2 there exists at least one refining subsequence  $\{x^k\}_{k \in K} \rightarrow \hat{x}$

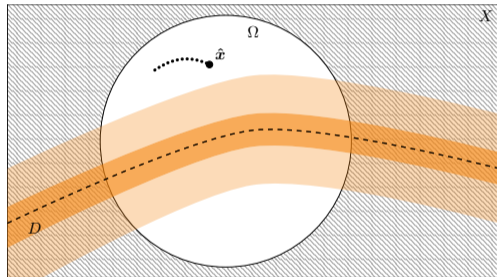



# Convergence analysis in brief

- 1 mesh gets infinitely fine :  $\liminf_{k \rightarrow \infty} \delta^k = 0$
- 2 there exists at least one refining subsequence  $\{x^k\}_{k \in K} \rightarrow \hat{x}$
- 3  $\hat{x}$  satisfies some conditions

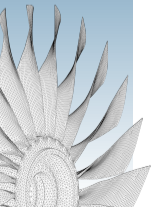
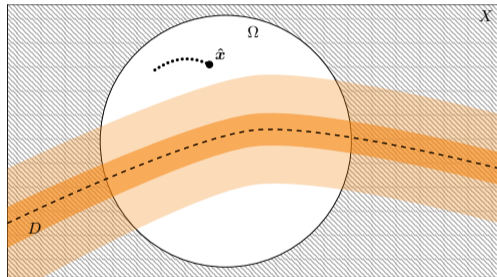



# Convergence analysis in brief

- 1 mesh gets infinitely fine :  $\liminf_{k \rightarrow \infty} \delta^k = 0$
- 2 there exists at least one refining subsequence  $\{x^k\}_{k \in K} \rightarrow \hat{x}$
- 3  $\hat{x}$  satisfies some conditions
  - ▶ case A

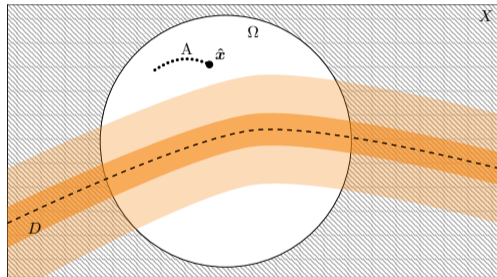





# Convergence analysis in brief

- 1 mesh gets infinitely fine :  $\liminf_{k \rightarrow \infty} \delta^k = 0$
- 2 there exists at least one refining subsequence  $\{x^k\}_{k \in K} \rightarrow \hat{x}$
- 3  $\hat{x}$  satisfies some conditions
  - ▶ case A  $\implies f^\circ(\hat{x}, p) \geq 0$  (from Mads)

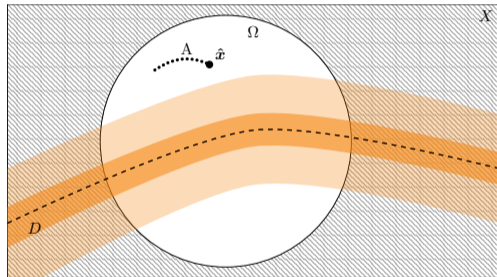



# Convergence analysis in brief

- 1 mesh gets infinitely fine :  $\liminf_{k \rightarrow \infty} \delta^k = 0$
- 2 there exists at least one refining subsequence  $\{x^k\}_{k \in K} \rightarrow \hat{x}$
- 3  $\hat{x}$  satisfies some conditions
  - ▶ case A  $\implies f^\circ(\hat{x}, p) \geq 0$  (from Mads)
  - ▶ case B

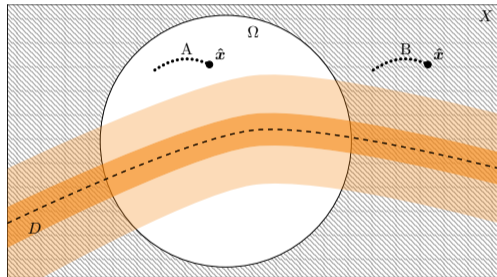



# Convergence analysis in brief

- 1 mesh gets infinitely fine :  $\liminf_{k \rightarrow \infty} \delta^k = 0$
- 2 there exists at least one refining subsequence  $\{x^k\}_{k \in K} \rightarrow \hat{x}$
- 3  $\hat{x}$  satisfies some conditions
  - ▶ case A  $\implies f^\circ(\hat{x}, p) \geq 0$  (from Mads)
  - ▶ case B  $\implies \hat{h}^\circ(\hat{x}, p) \geq 0$  (from Mads)

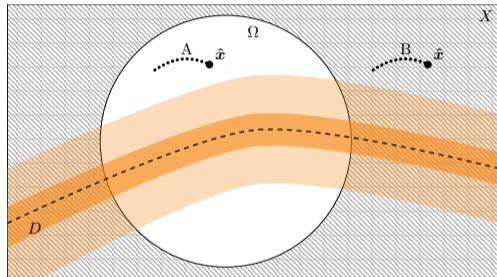



# Convergence analysis in brief

- 1 mesh gets infinitely fine :  $\liminf_{k \rightarrow \infty} \delta^k = 0$
- 2 there exists at least one refining subsequence  $\{x^k\}_{k \in K} \rightarrow \hat{x}$
- 3  $\hat{x}$  satisfies some conditions
  - ▶ case A  $\implies f^\circ(\hat{x}, p) \geq 0$  (from Mads)
  - ▶ case B  $\implies \hat{h}^\circ(\hat{x}, p) \geq 0$  (from Mads)
  - ▶ case C  $\implies \hat{x}$  is a local minimizer of  $\hat{h}$  on  $X$   
 $\implies$  new result

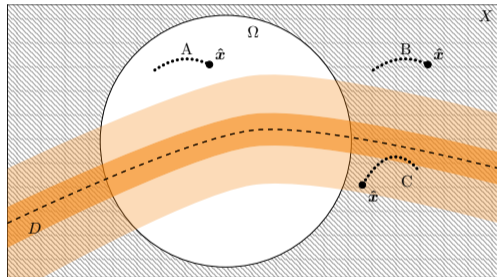



# Convergence analysis in brief

- 1 mesh gets infinitely fine :  $\liminf_{k \rightarrow \infty} \delta^k = 0$
- 2 there exists at least one refining subsequence  $\{x^k\}_{k \in K} \rightarrow \hat{x}$

- 3  $\hat{x}$  satisfies some conditions

- ▶ case A  $\implies f^\circ(\hat{x}, p) \geq 0$  (from Mads)
- ▶ case B  $\implies \hat{h}^\circ(\hat{x}, p) \geq 0$  (from Mads)
- ▶ case C  $\implies \hat{x}$  is a local minimizer of  $\hat{h}$  on  $X$   
 $\implies$  new result

- idea behind the proof

- ▶  $\lim_{k \rightarrow \infty} h^k(y) = \hat{h}(y)$  for  $y$  close to  $\hat{x}$
- ▶ piecewise continuity assumption and revealing poll required

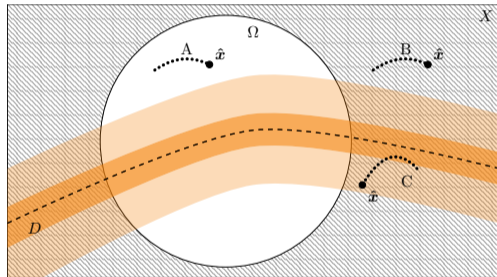



Context

Modeling

Basics on Mads

DiscoMads

Convergence

Results

Weak discontinuities

Hidden constraints

Conclusion

① Context

② Modeling

③ Basics on Mads

④ DiscoMads

⑤ Convergence analysis

⑥ Numerical results

⑦ Conclusion

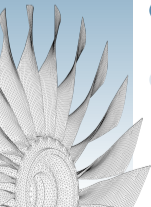

# Escaping weak discontinuities

- vibrations of aircraft engine blades

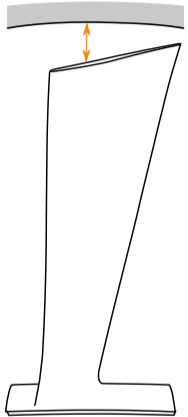

▶ blade-tip/casing clearance ( ← → )

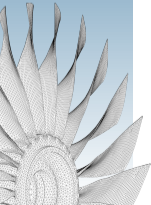

<sup>4</sup>A. Batailly et al. *Journal of Engineering for Gas Turbines and Power* (2015), doi: 10.1115/1.4028263.

# Escaping weak discontinuities

DFO

Symposium



Context

Modeling

Basics on Mads

DiscoMads

Convergence

Results

Weak discontinuities

Hidden constraints

Conclusion

- vibrations of aircraft engine blades
- quantity of interest<sup>4</sup>: vibration magnitude at blade-tip

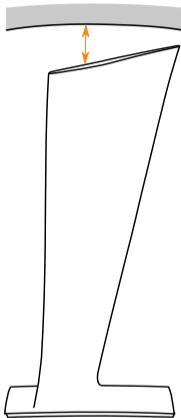



▶ blade-tip/casing clearance ( ← → )

<sup>4</sup>A. Batailly et al. *Journal of Engineering for Gas Turbines and Power* (2015), doi: 10.1115/1.4028263.

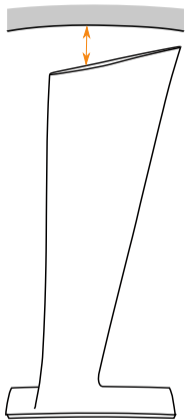

# Escaping weak discontinuities



▶ blade-tip/casing clearance (  )

- vibrations of aircraft engine blades
- quantity of interest<sup>4</sup>: vibration magnitude at blade-tip
  - ▶ response surface  $v(s, \omega) \Rightarrow 45\,000$  simulations

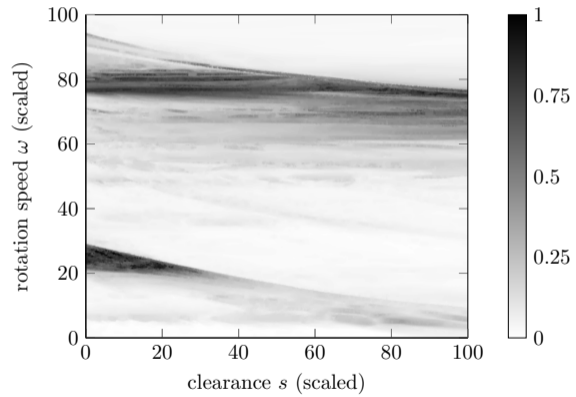

<sup>4</sup>A. Batailly et al. *Journal of Engineering for Gas Turbines and Power* (2015), doi: 10.1115/1.4028263.

# Escaping weak discontinuities

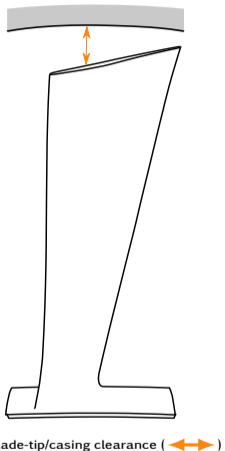

- vibrations of aircraft engine blades
- quantity of interest<sup>4</sup>: vibration magnitude at blade-tip
  - ▶ response surface  $v(s, \omega) \Rightarrow 45\,000$  simulations

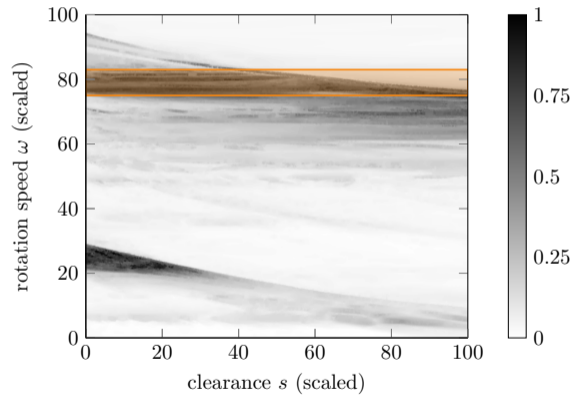

<sup>4</sup>A. Batailly et al. *Journal of Engineering for Gas Turbines and Power* (2015), doi: 10.1115/1.4028263.

# Escaping weak discontinuities

- DFO Symposium
- Context
- Modeling
- Basics on Mads
- DiscoMads
- Convergence
- Results
- Weak discontinuities
- Hidden constraints
- Conclusion

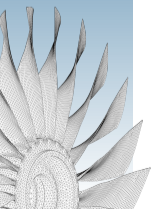
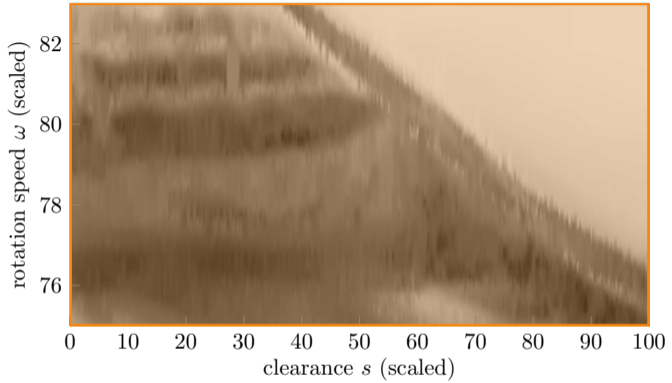

# Escaping weak discontinuities

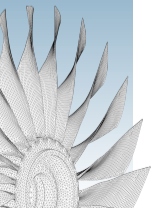
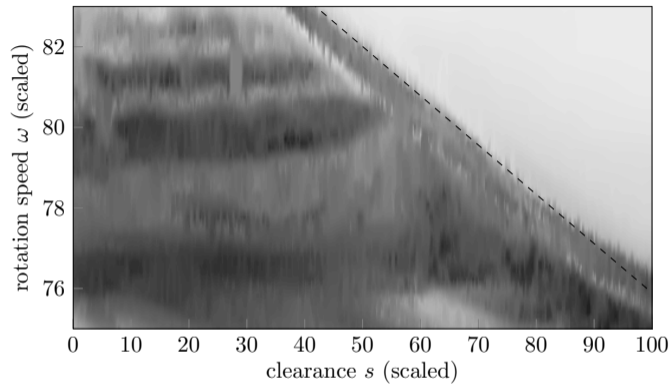

# Escaping weak discontinuities

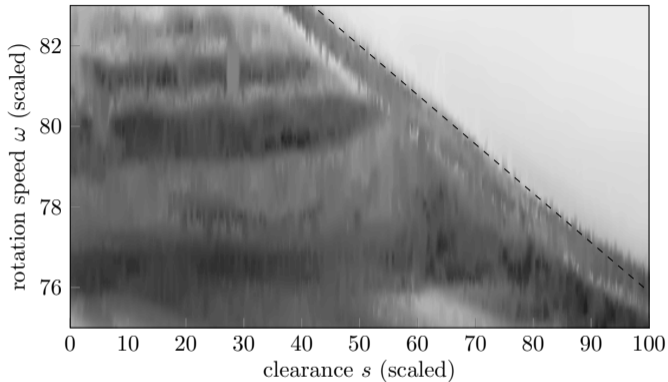

- simplified optimization problem

$$\begin{aligned} \min_{x \in X} \quad & f(x) \\ \text{s.t.} \quad & c(x) \leq 0 \\ \text{and} \quad & d(x) \leq 0 \end{aligned}$$

# Escaping weak discontinuities

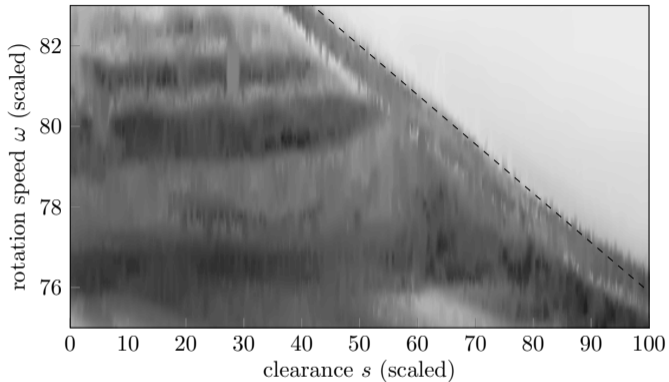

- simplified optimization problem

$$\begin{aligned} \min_{(s, \omega)} \quad & f(s, \omega) \\ \text{s.t.} \quad & c(s, \omega) \leq 0 \\ \text{and} \quad & d(s, \omega) \leq 0 \end{aligned}$$

# Escaping weak discontinuities

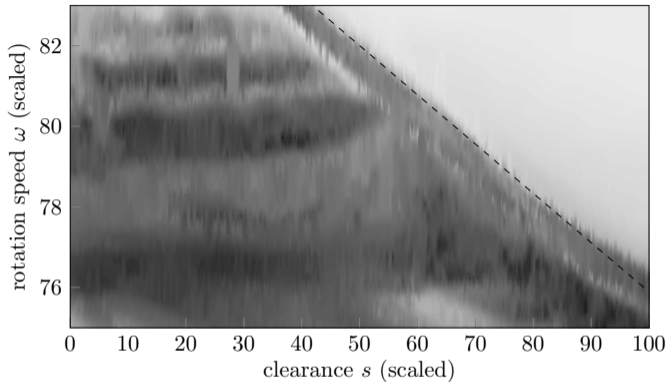

- simplified optimization problem

$$\begin{aligned} \min_{(s, \omega)} \quad & s \\ \text{s.t.} \quad & c(s, \omega) \leq 0 \\ \text{and} \quad & d(s, \omega) \leq 0 \end{aligned}$$

# Escaping weak discontinuities

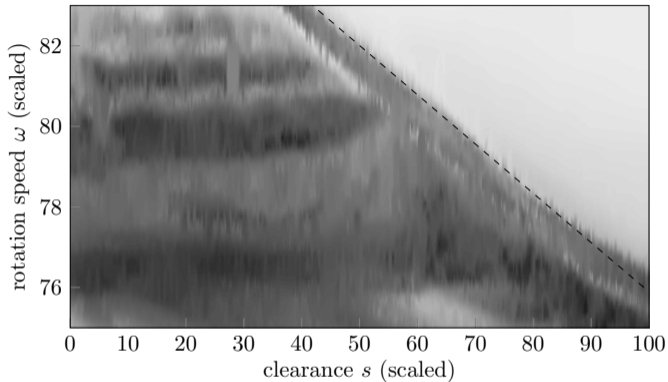

- simplified optimization problem

$$\begin{aligned} \min_{(s, \omega)} \quad & s \\ \text{s.t.} \quad & v(s, \omega) \leq v_{max} \\ \text{and} \quad & d(s, \omega) \leq 0 \end{aligned}$$



# Escaping weak discontinuities

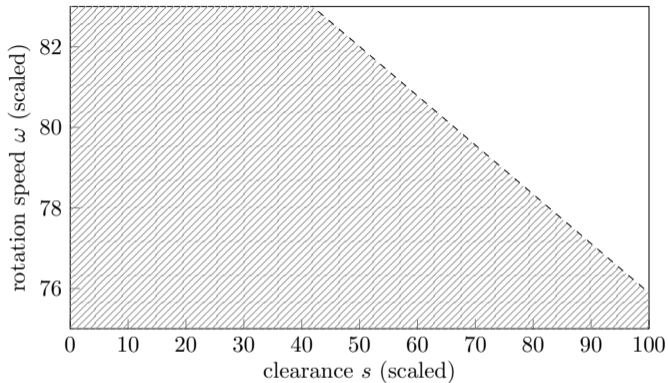

- simplified optimization problem

$$\begin{aligned} \min_{(s,\omega)} \quad & s \\ \text{s.t.} \quad & v(s,\omega) \leq v_{max} \\ \text{and} \quad & d(s,\omega) \leq 0 \end{aligned}$$

# Escaping weak discontinuities

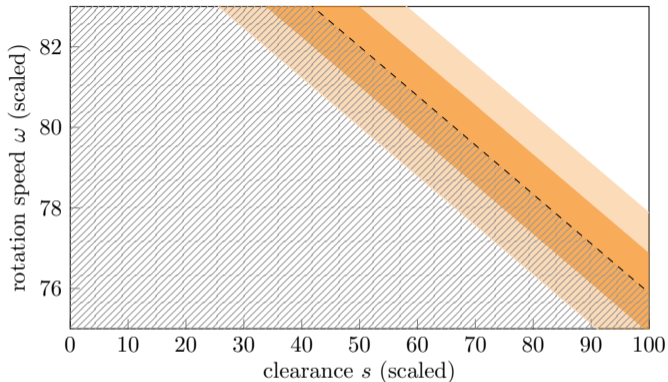

- simplified optimization problem

$$\begin{aligned} \min_{(s, \omega)} \quad & s \\ \text{s.t.} \quad & v(s, \omega) \leq v_{max} \\ & \text{and } d(s, \omega) \leq 0 \end{aligned}$$

$$\blacktriangleright r_d = 1 \quad \tau = 0.4 \quad r_e = 1$$

# Escaping weak discontinuities

DFO

Symposium



Context

Modeling

Basics on Mads

DiscoMads

Convergence

Results

Weak discontinuities

Hidden constraints

Conclusion

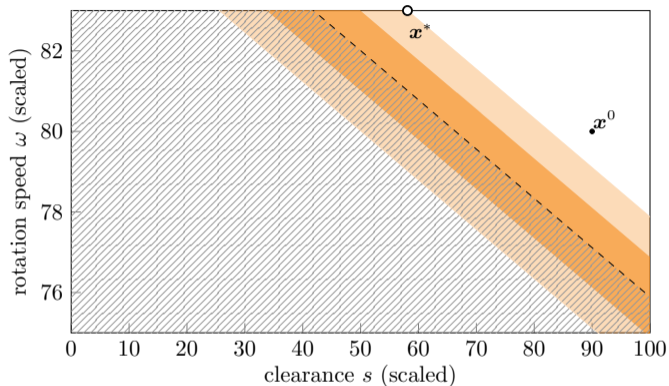

- simplified optimization problem

$$\begin{aligned} \min_{(s,\omega)} \quad & s \\ \text{s.t.} \quad & v(s,\omega) \leq v_{max} \\ & \text{and } d(s,\omega) \leq 0 \end{aligned}$$

$$\blacktriangleright r_d = 1 \quad \tau = 0.4 \quad r_e = 1$$

# Escaping weak discontinuities

- DFO Symposium
- Context
- Modeling
- Basics on Mads
- DiscoMads
- Convergence
- Results
- Weak discontinuities
- Hidden constraints
- Conclusion

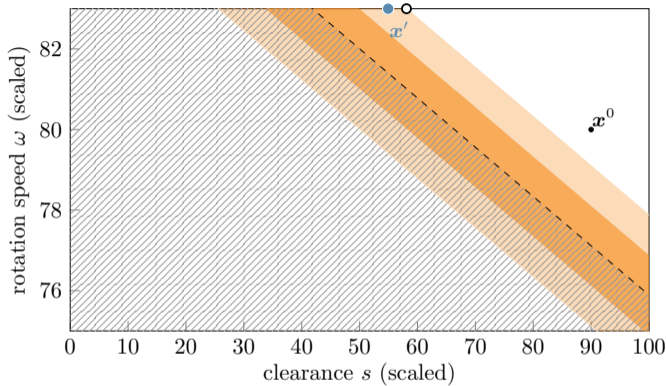

- simplified optimization problem

$$\begin{aligned} \min_{(s,\omega)} \quad & s \\ \text{s.t.} \quad & v(s,\omega) \leq v_{max} \\ & \text{and } d(s,\omega) \leq 0 \\ \blacktriangleright \quad & r_d = 1 \quad \tau = 0.4 \quad r_e = 1 \end{aligned}$$

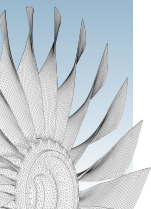

# Escaping weak discontinuities

- DFO Symposium
- Context
- Modeling
- Basics on Mads
- DiscoMads
- Convergence
- Results
  - Weak discontinuities
  - Hidden constraints
- Conclusion

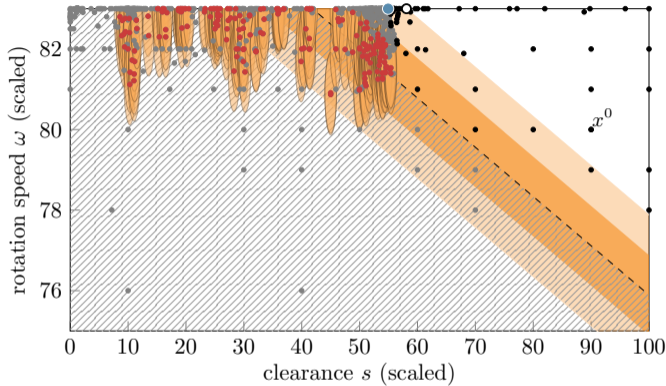

- simplified optimization problem

$$\begin{aligned} \min_{(s, \omega)} \quad & s \\ \text{s.t.} \quad & v(s, \omega) \leq v_{max} \\ & \text{and } d(s, \omega) \leq 0 \\ \blacktriangleright \quad & r_d = 1 \quad \tau = 0.4 \quad r_e = 1 \end{aligned}$$

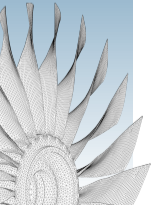

# Escaping regions of hidden constraints

DFO

Symposium



Context

Modeling

Basics on Mads

DiscoMads

Convergence

Results

Weak discontinuities

Hidden constraints

Conclusion

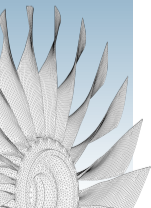

---

<sup>5</sup>C. Audet et al. *J. Global Optim.* (2008). doi: 10.1007/s10898-007-9234-1.

<sup>6</sup><https://github.com/bbopt/styrene>

# Escaping regions of hidden constraints

- styrene production problem<sup>5</sup>  $\implies$  STYRENE blackbox<sup>6</sup>
  - ▶ 8 variables, 11 constraints
  - ▶ simulation fails for some  $x$   $\implies$  hidden constraints

DFO

Symposium



Context

Modeling

Basics on Mads

DiscoMads

Convergence

Results

Weak discontinuities

Hidden constraints

Conclusion

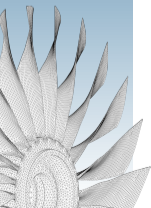

<sup>5</sup>C. Audet et al. *J. Global Optim.* (2008). doi: 10.1007/s10898-007-9234-1.

<sup>6</sup><https://github.com/bbopt/styrene>

## Escaping regions of hidden constraints

- styrene production problem<sup>5</sup>  $\implies$  STYRENE blackbox<sup>6</sup>
  - ▶ 8 variables, 11 constraints
  - ▶ simulation fails for some  $x$   $\implies$  hidden constraints

Use DiscoMads to escape regions of hidden constraints

<sup>5</sup>C. Audet et al. *J. Global Optim.* (2008). doi: 10.1007/s10898-007-9234-1.

<sup>6</sup><https://github.com/bbopt/styrene>





## Escaping regions of hidden constraints

- styrene production problem<sup>5</sup>  $\implies$  STYRENE blackbox<sup>6</sup>
  - ▶ 8 variables, 11 constraints
  - ▶ simulation fails for some  $x \implies$  hidden constraints

Use DiscoMads to escape regions of hidden constraints

- modeling of hidden constraints
  - ▶ failed evaluation  $\implies f = 10^{20} \implies$  weak discontinuity of  $f$

<sup>5</sup>C. Audet et al. *J. Global Optim.* (2008). doi: 10.1007/s10898-007-9234-1.

<sup>6</sup><https://github.com/bbopt/styrene>



## Escaping regions of hidden constraints

- styrene production problem<sup>5</sup>  $\implies$  STYRENE blackbox<sup>6</sup>
  - ▶ 8 variables, 11 constraints
  - ▶ simulation fails for some  $x \implies$  hidden constraints

Use DiscoMads to escape regions of hidden constraints

- modeling of hidden constraints
  - ▶ failed evaluation  $\implies f = 10^{20} \implies$  weak discontinuity of  $f$
- how do we know if  $d$  is satisfied at  $x$ ?

<sup>5</sup>C. Audet et al. *J. Global Optim.* (2008). doi: 10.1007/s10898-007-9234-1.

<sup>6</sup><https://github.com/bbopt/styrene>



## Escaping regions of hidden constraints

- styrene production problem<sup>5</sup>  $\implies$  STYRENE blackbox<sup>6</sup>
  - ▶ 8 variables, 11 constraints
  - ▶ simulation fails for some  $x \implies$  hidden constraints

Use DiscoMads to escape regions of hidden constraints

- modeling of hidden constraints
  - ▶ failed evaluation  $\implies f = 10^{20} \implies$  weak discontinuity of  $f$
- how do we know if  $d$  is satisfied at  $x$ ?
  - ▶ evaluation of severity of hidden constraints around  $x$

$$H(x, \sigma) := \#\{y^i \in B_\sigma(x), i \in \{1, \dots, 1000\}, \text{ evaluation at } y \text{ fails}\}$$

<sup>5</sup>C. Audet et al. *J. Global Optim.* (2008). doi: 10.1007/s10898-007-9234-1.

<sup>6</sup><https://github.com/bbopt/styrene>

## Escaping regions of hidden constraints

DFO

Symposium



Context

Modeling

Basics on Mads

DiscoMads

Convergence

Results

Weak discontinuities

Hidden constraints

Conclusion

- problem parameters

- ▶  $r_d = 5, \tau = 10^{15}, r_e = 10$

- initial point  $x^0$

- ▶ one of the best known solutions:  $f(x^0) = -33\,709\,000$

- ▶  $H(x^0, 15) = 435 \implies x^0$  in hidden constraints regions

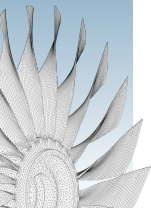

## Escaping regions of hidden constraints

- problem parameters

- ▶  $r_d = 5, \tau = 10^{15}, r_e = 10$

- initial point  $x^0$

- ▶ one of the best known solutions:  $f(x^0) = -33\,709\,000$

- ▶  $H(x^0, 15) = 435 \implies x^0$  in hidden constraints regions

DFO

Symposium



Context

Modeling

Basics on Mads

DiscoMads

Convergence

Results

Weak discontinuities

Hidden constraints

Conclusion

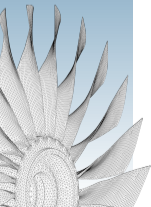

# Escaping regions of hidden constraints

- problem parameters
  - ▶  $r_d = 5, \tau = 10^{15}, r_e = 10$
- initial point  $x^0$ 
  - ▶ one of the best known solutions:  $f(x^0) = -33\,709\,000$
  - ▶  $H(x^0, 15) = 435 \implies x^0$  in hidden constraints regions
- 100 runs with 100 random seeds

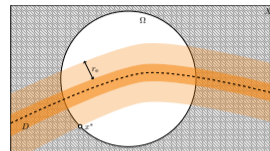



## Escaping regions of hidden constraints

- problem parameters
  - ▶  $r_d = 5, \tau = 10^{15}, r_e = 10$
- initial point  $x^0$ 
  - ▶ one of the best known solutions:  $f(x^0) = -33\,709\,000$
  - ▶  $H(x^0, 15) = 435 \implies x^0$  in hidden constraints regions
- 100 runs with 100 random seeds
  - ▶ f values

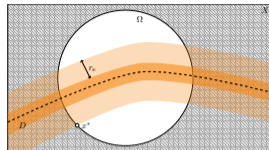



# Escaping regions of hidden constraints

- problem parameters
  - ▶  $r_d = 5, \tau = 10^{15}, r_e = 10$
- initial point  $x^0$ 
  - ▶ one of the best known solutions:  $f(x^0) = -33\,709\,000$
  - ▶  $H(x^0, 15) = 435 \implies x^0$  in hidden constraints regions
- 100 runs with 100 random seeds
  - ▶ f values

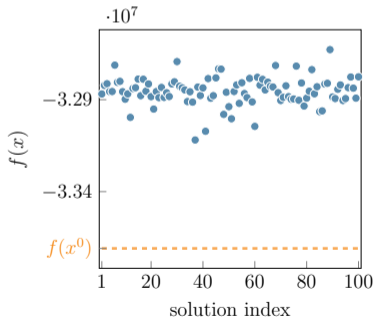
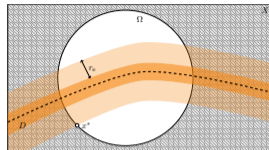



# Escaping regions of hidden constraints

- problem parameters
  - ▶  $r_d = 5, \tau = 10^{15}, r_e = 10$
- initial point  $x^0$ 
  - ▶ one of the best known solutions:  $f(x^0) = -33\,709\,000$
  - ▶  $H(x^0, 15) = 435 \implies x^0$  in hidden constraints regions
- 100 runs with 100 random seeds
  - ▶ hidden constraints violation

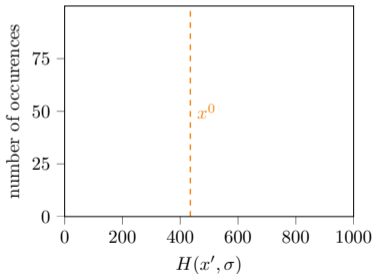
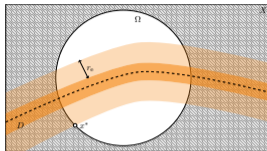

▶  $\sigma = r_d + r_e = 15$

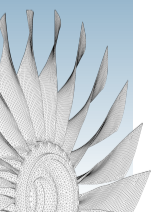

# Escaping regions of hidden constraints

- problem parameters
  - ▶  $r_d = 5, \tau = 10^{15}, r_e = 10$
- initial point  $x^0$ 
  - ▶ one of the best known solutions:  $f(x^0) = -33\,709\,000$
  - ▶  $H(x^0, 15) = 435 \implies x^0$  in hidden constraints regions
- 100 runs with 100 random seeds
  - ▶ hidden constraints violation

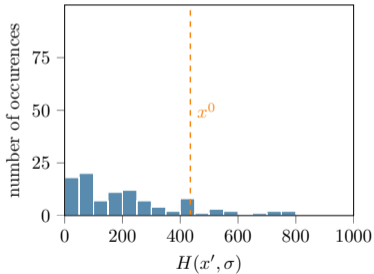
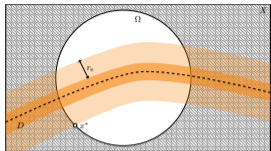

▶  $\sigma = r_d + r_e = 15$

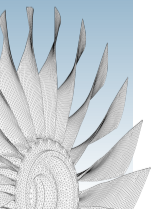

# Escaping regions of hidden constraints

- problem parameters
  - ▶  $r_d = 5, \tau = 10^{15}, r_e = 10$
- initial point  $x^0$ 
  - ▶ one of the best known solutions:  $f(x^0) = -33\,709\,000$
  - ▶  $H(x^0, 15) = 435 \implies x^0$  in hidden constraints regions
- 100 runs with 100 random seeds
  - ▶ hidden constraints violation

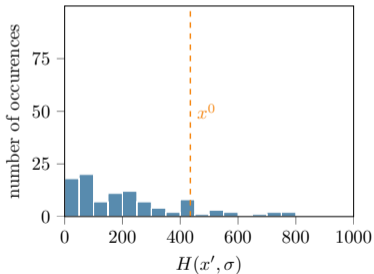
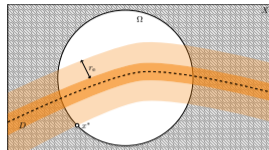

▶  $\sigma = r_d + r_e = 15$

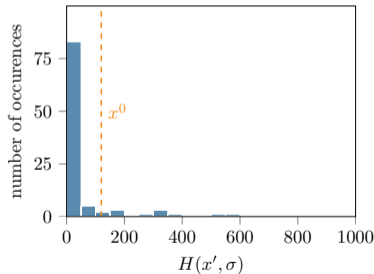

▶  $\sigma = r_d = 5$

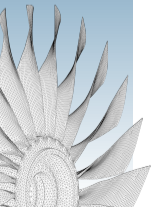



Context

Modeling

Basics on Mads

DiscoMads

Convergence

Results

Conclusion

① Context

② Modeling

③ Basics on Mads

④ DiscoMads

⑤ Convergence analysis

⑥ Numerical results

⑦ Conclusion



A DiscoMads algorithm to escape unknown discontinuous regions



## A DiscoMads algorithm to escape unknown discontinuous regions

- major points
  - ▶ inner approximations of the safety margin to treat infinite constraint  $d$

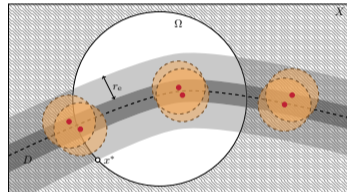

## A DiscoMads algorithm to escape unknown discontinuous regions

- major points

- ▶ inner approximations of the safety margin to treat infinite constraint  $d$
- ▶ based on Mads  $\Rightarrow$  convergence properties preserved

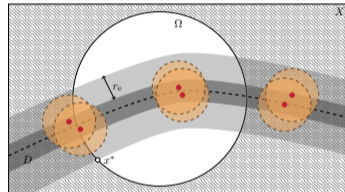

## A DiscoMads algorithm to escape unknown discontinuous regions

- major points

- ▶ **inner approximations** of the safety margin to treat infinite constraint  $d$
- ▶ based on Mads  $\Rightarrow$  convergence properties preserved
- ▶ validated on analytical and engineering problems

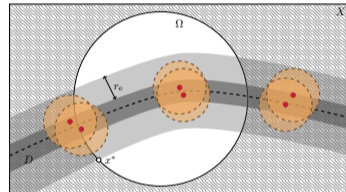





## A DiscoMads algorithm to escape unknown discontinuous regions

- major points
  - ▶ inner approximations of the safety margin to treat infinite constraint  $d$
  - ▶ based on Mads  $\Rightarrow$  convergence properties preserved
  - ▶ validated on analytical and engineering problems
- publication
  - ▶ "Escaping unknown discontinuous regions in blackbox optimization", C. Audet, A. Batailly and S. Kojtych, *SIAM Journal On Optimization* (recently accepted, preprint available<sup>7</sup>)

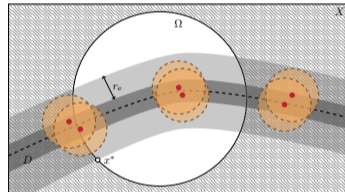

<sup>7</sup>C. Audet et al. Aug. 2020. eprint: <https://www.gerad.ca/en/papers/G-2020-46/view.published>.



## Conclusion

### A DiscoMads algorithm to escape unknown discontinuous regions

- major points
  - ▶ **inner approximations** of the safety margin to treat infinite constraint  $d$
  - ▶ based on Mads  $\Rightarrow$  convergence properties preserved
  - ▶ validated on analytical and engineering problems
- publication
  - ▶ "Escaping unknown discontinuous regions in blackbox optimization", C. Audet, A. Batailly and S. Kojtych, *SIAM Journal On Optimization* (recently accepted, preprint available<sup>7</sup>)

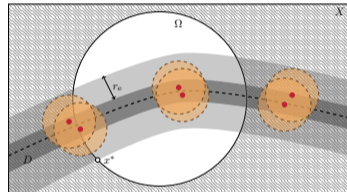

## Perspectives

- usages: discontinuities and **hidden constraints**

<sup>7</sup>C. Audet et al. Aug. 2020. eprint: <https://www.gerad.ca/en/papers/G-2020-46/view.published>.



## Conclusion

### A DiscoMads algorithm to escape unknown discontinuous regions

- major points
  - ▶ inner approximations of the safety margin to treat infinite constraint  $d$
  - ▶ based on Mads  $\Rightarrow$  convergence properties preserved
  - ▶ validated on analytical and engineering problems
- publication
  - ▶ "Escaping unknown discontinuous regions in blackbox optimization", C. Audet, A. Batailly and S. Kojtych, *SIAM Journal On Optimization* (recently accepted, preprint available<sup>7</sup>)

## Perspectives

- usages: discontinuities and **hidden constraints**
- short-term
  - ▶ implementation in Nomad 4  $\Rightarrow$  hidden constraint problems

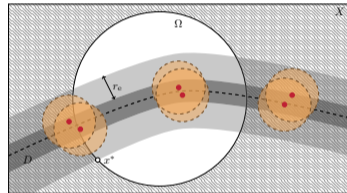

<sup>7</sup>C. Audet et al. Aug. 2020. eprint: <https://www.gerad.ca/en/papers/G-2020-46/view.published>.



# Conclusion

## A DiscoMads algorithm to escape unknown discontinuous regions

- major points
  - ▶ inner approximations of the safety margin to treat infinite constraint  $d$
  - ▶ based on Mads  $\Rightarrow$  convergence properties preserved
  - ▶ validated on analytical and engineering problems
- publication
  - ▶ "Escaping unknown discontinuous regions in blackbox optimization", C. Audet, A. Batailly and S. Kojtych, *SIAM Journal On Optimization* (recently accepted, preprint available<sup>7</sup>)

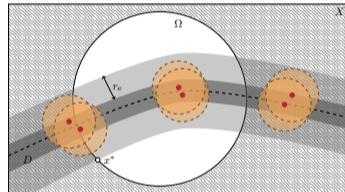

## Perspectives

- usages: discontinuities and **hidden constraints**
- short-term
  - ▶ implementation in Nomad 4  $\Rightarrow$  hidden constraint problems
- others
  - ▶ performance improvements  $\Rightarrow$  scaling of  $c$  and  $d^k$ , revealing poll, surrogates...
  - ▶ comparison with other methods adapted to treat  $d$ ?
  - ▶ other infinite constraints?

<sup>7</sup>C. Audet et al. Aug. 2020. eprint: <https://www.gerad.ca/en/papers/G-2020-46/view.published>.

Thank you for attention !