



HAL
open science

Energy Harvesting using Integrated Piezoelectric Transducer in a Composite Smart Structure for Self-powered Sensor Applications

Linjuan Yan, Jonathan Rodriguez, Kevin Billon, Mickaël Null Lallart, Manuel Collet, Claire Jean-Mistral, Simon Chesné

► **To cite this version:**

Linjuan Yan, Jonathan Rodriguez, Kevin Billon, Mickaël Null Lallart, Manuel Collet, et al.. Energy Harvesting using Integrated Piezoelectric Transducer in a Composite Smart Structure for Self-powered Sensor Applications. *Journal of Intelligent Material Systems and Structures*, inPress, 10.1177/1045389X221121902. hal-03737133

HAL Id: hal-03737133

<https://hal.science/hal-03737133>

Submitted on 23 Jul 2022

HAL is a multi-disciplinary open access archive for the deposit and dissemination of scientific research documents, whether they are published or not. The documents may come from teaching and research institutions in France or abroad, or from public or private research centers.

L'archive ouverte pluridisciplinaire **HAL**, est destinée au dépôt et à la diffusion de documents scientifiques de niveau recherche, publiés ou non, émanant des établissements d'enseignement et de recherche français ou étrangers, des laboratoires publics ou privés.

Energy Harvesting using Integrated Piezoelectric Transducer in a Composite Smart Structure for Self-powered Sensor Applications

Journal of Intelligent Material Systems and Structures
XX(X):1–9
©The Author(s) 2022
Reprints and permission:
sagepub.co.uk/journalsPermissions.nav
DOI: 10.1177/ToBeAssigned
www.sagepub.com/

SAGE

Linjuan Yan¹, Jonathan Rodriguez², Kevin Billon³, Mickaël Lallart¹, Manuel Collet³, Claire Jean-Mistral², Simon Chesné²

Abstract

Self-sensing structures are tremendously needed in transport or energy applications. Nevertheless, structures are rarely designed in advance to harvest energy in realistic operational conditions, leading to sensing functions using most of the time batteries. Thus, this paper proposes a complete application of self-powered sensing using an integrated piezoelectric transducer on a representative composite structure, namely a smart composite reduced-model car. Based on an optimized self-powered Synchronized Switch Harvesting on Inductor circuit (SSHI) coupled with a complete electromechanical behavior study, up to $40\mu W$ can be harvested on a resistive load of $3M\Omega$ for a linear velocity of $12,5km.h^{-1}$. This power allows supplying a temperature sensor and its wireless transmitter, whose data can be sent each $60s$. Our functionalized car is a first step toward real industrial application cases and demonstrates the ability of the proposed method to enhance the energy harvesting process on an existing weakly coupled structure and use the vibrations as an energy source for relevant embedded microgenerators and associated self-powered sensors.

Keywords

Energy harvesting, Smart composite structures, Piezoelectric transducers, Self-powered sensors

Introduction

Composite smart structures have shown over recent years a great potential in many applications. By integrating piezoelectric transducers directly into the composite layers or by simply bonding them to the external layer, voltages can be sensed as images of the local strain experienced by the structure or applied to generate local stress, yielding the use of the transducers as actuators. Besides, considering mechanical to electrical energy conversion (direct piezoelectric effect), this electrical energy coming from dynamic mechanical loads during operational conditions can be retrieved using specific energy harvesting circuits for self-powered applications for instance. This new type of self-sensing structure is very promising in the transportation field, especially for structural health monitoring applications (SHM) since no external power supply is needed, avoiding the additional weight and cost of wiring, or maintenance of batteries (see Ferrari et al. (2009) and Le et al. (2015)).

Hence, piezoelectric transducers integrated directly into vibrating structures seem an interesting method to harvest the available vibrational energy from an excited mechanical system. These transducers are light and more and more cost-effective. However, their efficiency in the process of mechanical-electrical energy conversion remains a challenge.

First, the vibrating structure's geometry and material in addition to the mounting of the transducers is not always optimal leading to poor electro-mechanical coupling. To tackle such a difficulty, energy harvesting systems are often

designed to benefit from dynamical modes of the structures, where for particular frequencies of mechanical excitation, the strain experienced by the piezoelectric transducers is maximum and so is the electrical output power.

Yet, in realistic operational conditions, the external mechanical disturbance does not necessarily excite the main modes of the structure, drastically reducing the efficiency of the harvesting systems.

Different techniques have been developed to increase the efficiency of mechanical to electrical energy conversion. Two main directions of exploration are then possible: 1) the optimization of the mechanical structure to increase its resonant response or widen the maximum strain bandwidth and 2) the electrical optimization of the energy harvesting circuit itself.

Regarding the optimization of the mechanical structure for energy harvesting, dynamic magnifiers are often used to increase the strain at a certain frequency as Gibus et al. (2020) for instance. Qi et al. (2010) or Zhou et al. (2011) have also developed multi-beam dynamic magnifiers to take advantage of several structure modes, at the cost of an overall

¹Univ. Lyon, INSA-Lyon, LGEF, EA682, F-69621, France

²Univ. Lyon, INSA-Lyon, LaMCoS UMR5229, F-69621, France

³Univ. Lyon, Ecole Centrale de Lyon, ENISE, ENTPE, CNRS, Laboratoire de Tribologie et Dynamique des Systèmes LTDS UMR5513, F-69134 Ecully, France

Corresponding author:

Mickaël Lallart

Email: mickael.lallart@insa-lyon.fr

lower power density. Non-linear techniques like magneto-piezoelectric systems creating bi-stable behaviors and high energy orbits as Duffing oscillators have also been explored to widen the frequency bandwidth of maximum strain by Erturk et al. (2009), Erturk and Inman (2011), Aladwani et al. (2012), Wang et al. (2018) or Yan et al. (2019). However, for industrial applications, it is not always possible to implement in to the structure additional mechanical parts and masses, especially in transportation. Besides, as Meyer et al. (2019) mention it, few studies addressed the integration of piezoelectric energy harvesters into complex shapes and composite structures. Yet Shi et al. (2017) devised a comparison between different integration techniques for Macro Fiber Composite transducers (MFC) in composite plane wings, supporting the hypothesis that integrating the transducer during the manufacturing process of the vibrating structure (wing) can increase its electromechanical coupling compared to a simply bonded MFC using additional adhesive.

The second aspect of improvement is the optimization of the energy harvesting circuit and various electrical loads have been studied to increase the level of harvested power. For instance Shi and Lien (2006) or Liang and Liao (2010) used classical AC-DC full-wave rectifiers and smoothing capacitors known as standard energy harvesting circuit (SEH).

On the other hand, Guyomar et al. (2005), Lefeuvre et al. (2006) and Shu et al. (2007) investigated Synchronized Switching Harvesting on Inductor (SSHI) circuits, with or without AC-DC rectifiers to take advantage of a switching inversion process triggered when the strain experienced by the transducer reaches an extremum value. Thanks to this switching action and considering weakly coupled structures, power gains up to a decade can be obtained compared to SEH, with the gain being however dependent on the quality of the inversion process where energy losses can reduce the final output power. Nevertheless, even in the worst case (voltage cancellation), the SSHI approach still allows a gain of 2 compared to SEH, confirming its interest in such energy harvesting systems.

Considering all these mechanical and electrical limitations that can quickly reduce the recoverable energy from the vibrating structure, the practical implementation of energy harvesting systems from piezoelectric transducers as well as associated self-powered sensors on real industrial applications with composite parts in operational conditions remains a challenge. This difficulty is precisely the main motivation behind the work reported in this study.

In reality, not only the previously mentioned aspects (environmental factors, electromechanical characteristics of vibrational systems and features of the dedicated charge extraction circuits) but also the actual application conditions may drastically affect the actual feasibility and applicability of vibrational energy harvesting systems serving as power supply for wireless node devices. Therefore, it is essential to investigate the complete autonomous self-powered device with a global view encompassing the structural, electrical harvesting scheme along with the sensor supply and power management. In that view, a few works describing such a global approach can be found in the literature considering vibrational energy source converted through piezoelectric

effect. For instance, Sodano et al. (2005) applied a vibrational excitation signal from a car engine compartment (air compressor) to a bimorph piezoelectric cantilever. Despite the use of a resonant structure, the charge time for different battery sizes was much higher using such broadband excitation than sinusoidal at the frequency of the 1st beam mode. Wang et al. (2013) placed a piezoelectric material on a small remote control aircraft to harvest electrical power from the wind-disturbed wing and supply actuators for vibration control thus reducing the necessary energy. Their study clearly shows the disproportion between the necessary control energy and possible harvested energy.

A piezoactive-based health monitoring system for damage detection was also introduced by Guyomar et al. (2007) and Lallart et al. (2008). In this device, an autonomous wireless transmitter is active once it obtains sufficient energy approximately 20 mJ from a storage capacitor with 470 μ F to send identifier code by RF emitter to wake up the sleeping network and to send an acoustic Lamb wave on a dedicated piezoelectric insert. The corresponding damage detection experiments using this Lamb wave signature showed the possibility of self-powering the health monitoring integration and demonstrated a potential application in industrial domain. With similar purposes, Ma et al. (2017) used a low frequency (2.42 Hz) piezoelectric beam as energy generator with LTC3588 chip for signal rectification. The converted energy, which is stored in a supercapacitor, was enough to power an ultralow-power wireless sensor LTC5800. A dedicated interface circuit was developed to power the wireless sensor after sufficient charging of the capacitor. Besides, Muller et al. (2010) introduced a wireless network exclusively supplied by a piezoelectric cantilever energy harvesting unit, which is mounted at the rear of forage wagon for converting the energy from agitation and steady state motor vibrations through full bridge rectifier with a 1 μ F storage capacitor. The operations consisted in transmitting with a period of 40ms a 9-byte data payload from a single sensor node to a central base station. Clementi et al. (2020) also introduced an application example with lead free lithium niobate (LiNbO₃) piezoelectric transducer. Under continuous excitation, the transducer and associated electrical unit allowed powering a sensor node once harvested energy is sufficient to send data information (420 μ energy consumption per cycle in the demonstration experiment), with a transmission period of 2s.

The contribution of this paper relies upon the complete development of a self-powered device that includes an energy harvesting system and a viable sensing apparatus, using a representative smart composite structure with a realistic excitation. Thus, a piezoelectric transducer is integrated directly within the glass fiber layers of a reduced model car composite body which is riding on a roller test bench. It is worth noticing that the smart structure has not been optimized in advance for energy harvesting applications leading to poor electromechanical coupling in addition to broadband structure response. Despite many sources of uncertainties and their impact on the SSHI functioning: composite manufacturing, piezoelectric integration impact on electromechanical coupling, broadband excitation signal on the transducer due to operational conditions, and variable RPM, the global system still performs its energy harvesting

task. Hence, the proposed self-powered switching circuit based on SSHI principle allows increasing the power output from the transducer, storing the energy, and supplying a temperature sensor together with a wireless transmitter that sends data every 60 seconds to a dedicated receiver or a computer.

This paper is organized as follows. The first section presents the smart composite structure and the roller test bench with a first insight on the integrated transducer electromechanical coupling. The next section develops the energy harvesting capabilities of the structure by proposing a SSHI-based circuit increasing the output power. The final section presents the practical application of self-powered temperature monitoring using the composite smart structure and the harvesting circuit.

Characterization of the reduced-model smart composite car body

In this section, the reduced-model smart composite car body is introduced as the medium for the energy harvesting and self-powered device application with its associated roller test bench. A preliminary investigation of the voltage signal available on the integrated transducer is also presented to estimate the electrical energy available from the piezoelectric patch.

Mechanical structure and test-bench

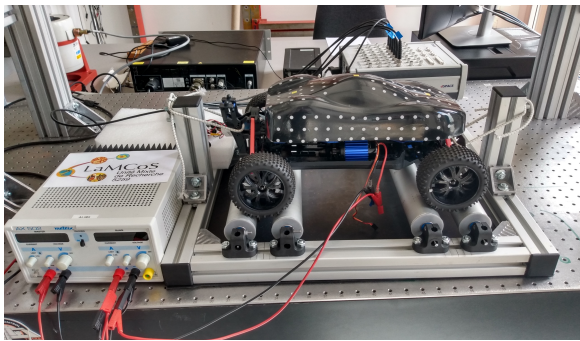

Figure 1. Smart car and roller test bench: side view.

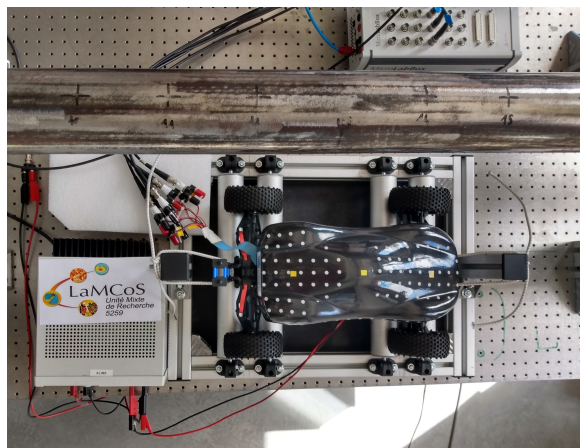

Figure 2. Smart car and roller test bench: top view.

The experimental structure is a RC car model (1/12 scale) powered by an electric motor. The plastic car body

is replaced by the smart composite body prototype with a piezoelectric transducer integrated between the fiber glass layers which has been manufactured by the M3M Laboratory (UTBM - France). Figures 1 and 2 display pictures of the roller test bench with the considered reduced scale vehicle and its smart composite body.

The integrated piezo ceramic patch (buzzer from the manufacturer Murata) is a 25 mm diameter disc with a thickness of 150 μm and a 33.8 nF capacitance. It is positioned at the top rear of the vehicle body as depicted in the schematic representations of the test bench shown in Figures 3 and 4.

The car chassis is then placed on the roller test bench and maintained using low stiffness components not to interfere with the dynamics of the vehicle. A constant voltage is applied to the vehicle electric motor (EM on Figure 3) so that the whole system is dynamically excited in a representative way of operational conditions, *i.e.* the vehicle driving on a road.

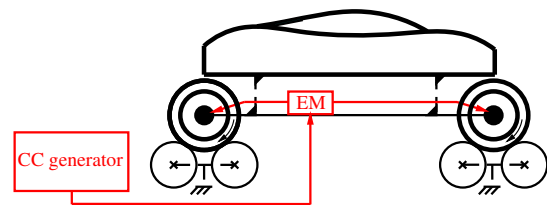

Figure 3. Schematic representation of the experiment, side view

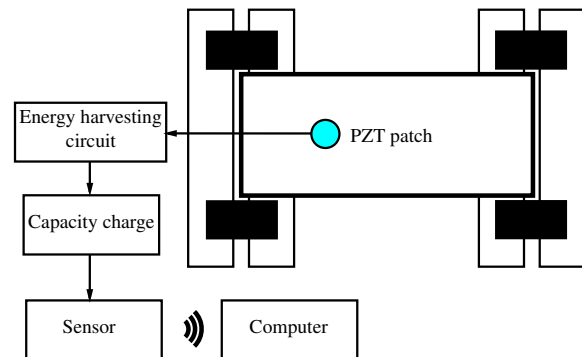

Figure 4. Schematic representation of the experiment, top view

Transducers voltage response

The piezoelectric patch output voltage U_{PZT} is measured using Dspace Microlabbox (11 M Ω input impedance). Considering that the main excitation frequency contents are high enough so that the output impedance of the piezoelectric insert is lower than the equivalent connected load, the voltage response of the PZT patch for different vehicle speeds has been recorded and highlight some optimal vehicle velocity for energy harvesting application.

The measurements are performed with a sampling frequency of 10 kHz and a signal length of 90s. The constant voltage U_{EM} applied to the electric motor goes from 1 V to 3.6 V leading to a vehicle velocity between 5 km.h⁻¹ and 18 km.h⁻¹. Figure 5 displays the Power Spectral Density (PSD) of the measured PZT voltage in function of the

vehicle electric motor voltage or velocity. Most of the electrical energy coming from the vibrations is focused under 100 Hz. Especially, results show the presence of 3 particularly predominant harmonics, that varies with the velocity from [10 , 30] Hz to [30, 80] Hz.

Even if the electro-mechanical structure of the RC car naturally possesses higher frequency modes due to the composite body stiffness containing the PZT patch, their contribution is negligible to the PSD since the excitation induced by the test bench and the wheels on the rollers is too low in frequency. This observation is interesting since it is very representative of a real applicative case where the smart structure has not been optimized in advance by placing the electro-mechanical system modes at suitable frequencies excited during operational conditions. Besides, high frequencies would be anyway filtered by the suspension system in a road vehicle.

Thus, the signal power $\int_0^T U_{PZT}^2(t)dt$ presented in Figure 6 also in function of the electric motor voltage or velocity, highlights the optimal speed of $14.7km.h^{-1}$ corresponding to a motor voltage of $3V$. For this velocity, the PSD of the piezovoltage U_{PZT} and a time signal extraction are shown in Figures 7 and 8 respectively. The most energetic harmonic frequencies are 22, 44 and 66 Hz and are direct consequences of the contact between the wheel spikes and the roller.

Remark: Since the piezoelectric voltage is maximum at the identified velocity of $14.7km.h^{-1}$, the optimal energy harvesting function is to be further realized at this particular speed configuration. Besides, an efficient electronic interface is necessary due to the low voltage level and the non-sinusoidal characteristics of the signal. Here, the excitation comes essentially from the tribological properties of the contact wheel/road and as mentioned earlier in the introduction with the research work from Sodano et al. (2005) and Wang et al. (2013) for instance, broadband excitation signals lead in general to poor energy harvesting performances. Thus, the proposed optimized self-powered SSHI circuit can overcome this difficulty.

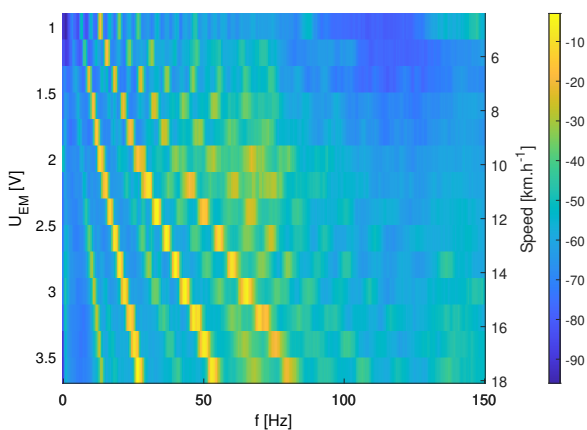

Figure 5. PZT voltage PSD function of the electric motor voltage or vehicle velocity on the bench [dB].

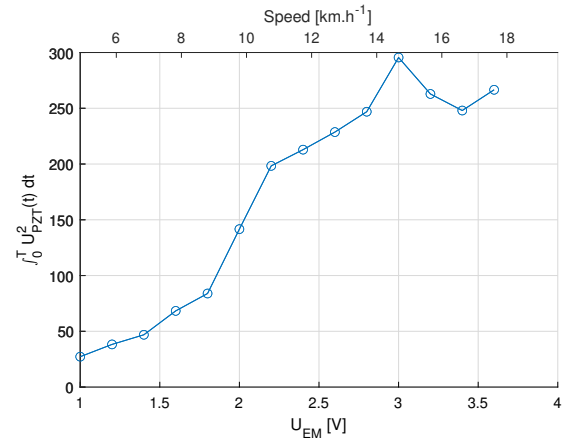

Figure 6. Signal power function of the electric motor voltage or vehicle velocity on the bench.

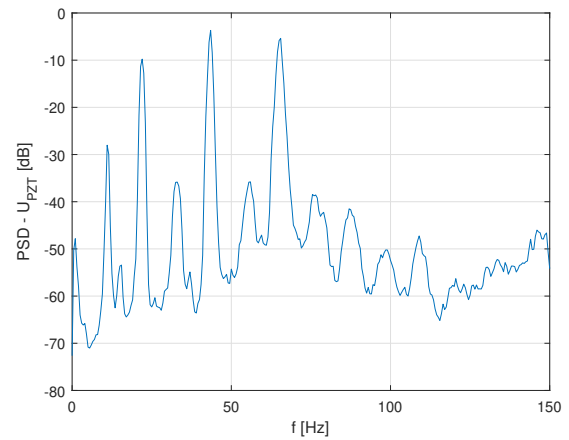

Figure 7. PZT voltage PSD for $U_{EM} = 3V$.

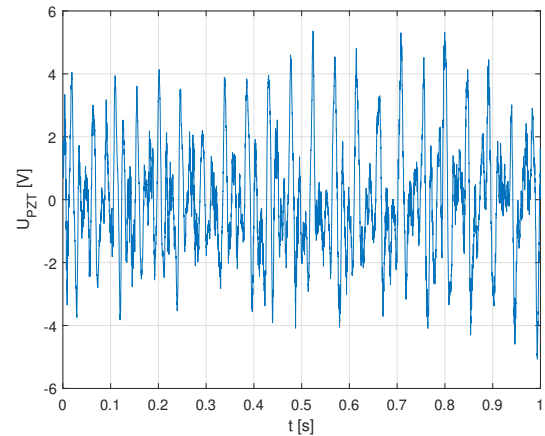

Figure 8. PZT voltage time signal sample for $U_{EM} = 3V$.

Energy harvesting evaluation

Based on the characterization of the composite car electromechanical response, this section aims at assessing the harvesting capabilities of the structure. To dispose of a usable electrical energy supply with optimized power output, the electrical interface consisted of a full wave voltage doubler, as depicted in Figure 9. Furthermore, in order to improve the energy extraction abilities of the piezoelectric transducer, a Synchronized Switch Harvesting on Inductor

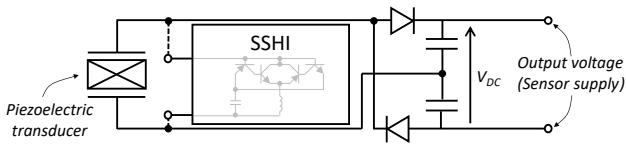

Figure 9. Energy harvesting electrical interface.

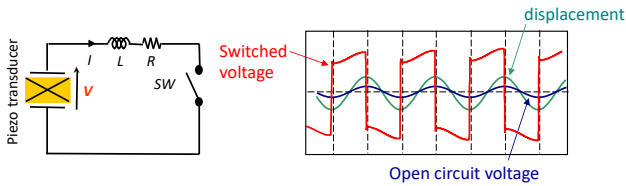

Figure 10. SSHI principles.

(SSHI - [Guyomar et al. \(2005\)](#), [Lefeuvre et al. \(2006\)](#)) interface may be added to the circuit.

SSHI principles and self-powered implementation

The principles of the SSHI consist in quickly inverting the piezovoltage when this voltage, or equivalently the strain experienced by the piezoelectric element, reaches an extremum value (Figure 10). The inversion process is obtained thanks to the use of an inductor, which shapes with the capacitive behavior of the piezoelement a $L - C_0$ oscillating circuit (with L the inductor and C_0 the piezoelectric clamped capacitance). Hence, when the switch SW is closed, the voltage starts oscillating around 0 V. After half an oscillating pseudo-period, the switch is opened, finishing the electric charge transfer from one electrode of the piezoelectric transducer to the other one, and thus realizing the voltage inversion operation. However, because of internal losses in the inversion circuit (resistive or iron losses of the inductor, switch losses, etc.), the inversion is not perfect and characterized by an inversion coefficient given as the ratio of the absolute voltage after and before the inversion event. Thanks to this process, the time shift between voltage and velocity is significantly reduced and a cumulative voltage magnification effect arises. Both of these effects yield a significant improvement of the converted energy, as it is given by the integral of the product of the voltage by the velocity. It is noteworthy that such a magnification is obtained without the use of any external energy supply (e.g., voltage source). Under monochromatic excitation, this can lead to an output power that is a decade higher ([Guyomar et al. \(2005\)](#)) than in the standard case (i.e., with a simple diode rectifier), especially for structures featuring low electromechanical coupling or high mechanical losses, or structures driven out of their resonance frequency band.

One significant advantage of the SSHI in terms of realistic implementation lies in the fact that the switching branch as well as the extremum detector can be made totally self-powered, consuming very little part of the electrostatic energy available on the piezoelectric element (hence not compromising the power gain). In the present study considering realistic operating conditions of the global system, the SSHI block represented in Figure 9 is therefore

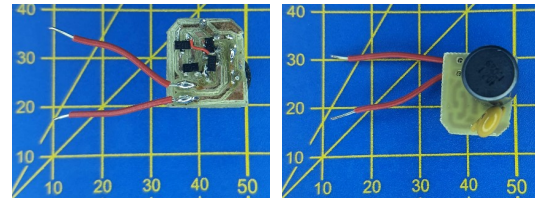
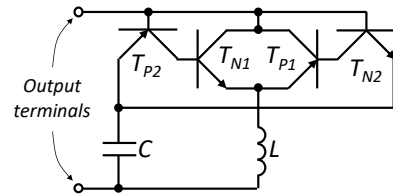

Figure 11. Self-powered switching circuit implementation and circuit photographs.

implemented in this way. The most common discrete architecture of this self-powered detector lies in a filter that allows shifting the input voltage (piezoelectric voltage). Then, once the filtered voltage is greater in absolute value to the absolute piezoelectric voltage, this triggers the main switch initiating the inversion process. Finally, after half a pseudo-period of the electrical oscillation corresponding to a current cancellation, a diode in the switching branch allows the opening of a switching transistor, hence terminating the inversion ([Lallart et al. \(2008\)](#)). An even more compact version of the discrete self-powered extremum detector and switch has been proposed by [Eltamaly and Addoweesh \(2017\)](#) and its implementation in the present study with further simplifications (e.g., only one filtering capacitor is used) is shown in Figure 11, where bipolar transistor T_{P2} (resp. T_{N2}) is used as comparator for positive (resp. negative) voltages and filter diode together with capacitance C for negative (resp. positive) voltages, thanks to the P-N junction between the base and emitter. Also, the switching transistors being based on bipolar technology, the end of the inversion is naturally achieved on current cancellation thus not requiring supplementary diodes. Finally, L is the inductor used for shaping the electrical resonant network allowing the inversion process previously exposed.

Figure 12 depicts the obtained waveforms both in open circuit and when connecting the switching device (without rectifier and harvesting stages) with the component values or references are given in Table 1 and with the vehicle motor voltage being set to 2.56 V, corresponding to a linear velocity of 12.52 km.h^{-1} . These results clearly indicate the performance of the SSHI for significantly boosting the piezoelectric voltage, reaching a RMS value of 3.83 V over

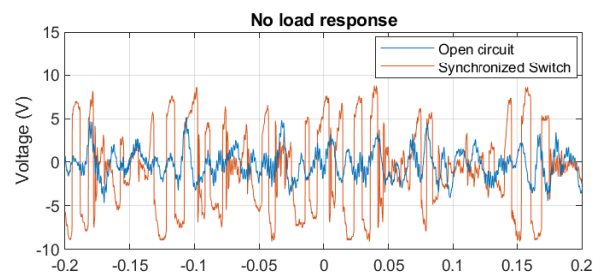

Figure 12. voltage response without harvesting stage (no load).

Component	Reference	Value
Inductance	RL181S-104J-RC	100 mH
Capacitor	AY2102M29Y5US63L7	1 nF
NPN transistor	2SC2412KT146R	N/A
PNP transistor	2SA1037AKT146Q/R	N/A

Table 1. Self-powered switching device components

the considered time window, which is 2.4 times higher than in pure open-circuit case (1.62 V). While this gain is noteworthy, it can be noted that because of the non-monochromatic characteristics of the signal, as well as the nonlinear, non-time invariant nature of the switching operations, the gain is lower than in pure sine case.

Experimental results

Following the successful implementation of the SSHI approach, this section aims at evaluating the harvesting performance using either standard (sole use of rectifier and associated smoothing capacitors) or SSHI approach. The measurement operation protocol consisted in wiring the circuit depicted in Figure 9, with 1N4148 as rectifying diodes and using two $4.7 \mu\text{F}$ smoothing capacitors, and measuring the output rectified voltage by means of a multimeter. However, because of the low frequency contents of the vibration and voltage spectra, the optimal loads, especially in the SSHI case, are expected to be high. Hence, for loads higher than $1 \text{ M}\Omega$, and not to have any effect from the multimeter input impedance, the load was split into a variable resistor and a $1 \text{ M}\Omega$ across which the voltage was measured. Then the rectified voltage was deduced using classical resistor bridge transfer function. The harvested power P was then derived as $P = V_{DC}^2/R_L$, with V_{DC} the rectified voltage and R_L the connected load.

Obtained results are depicted in Figure 13. Although the SSHI does not provide gain in low speeds because of low piezovoltage that does not permit the start-up of the self-powered switching circuit (whose start-up voltage has been measured around 1.5 V in magnitude), its maximal power significantly outperforms the standard case as the speed increases, eventually reaching more than $40 \mu\text{W}$ at 12.52 km.h^{-1} , while the standard case remains limited to less than $20 \mu\text{W}$. As expected, the optimal loads are quite high in the standard case ($1 \text{ M}\Omega$), and even higher with the SSHI (around $3 \text{ M}\Omega$), slightly varying in the latter case as the circuit becomes more and more efficient as the piezovoltage increases.

When depicting the maximal power as a function of the speed (Figure 14), it can be seen a power law behavior of the power. More precisely, while the power in standard case is close to a quadratic behavior, the SSHI power increases with a higher exponent (around 2.5), as the switching circuit performance increases with the piezovoltage magnitude. So do the gain with respect to the standard case, that eventually shows that the SSHI permits harvesting more than 2 times the power in the standard case. This gain is lower than the typical gain reported in the literature due to the complex, non-monochromatic nature of the piezoelectric output voltage. However, even in such a case, the SSHI still allows a

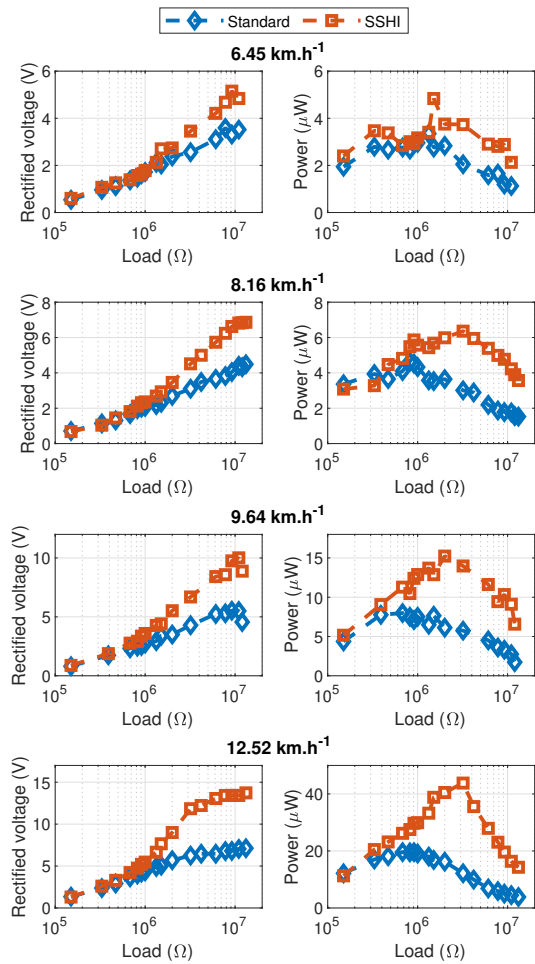

Figure 13. Experimental power as a function of connected load.

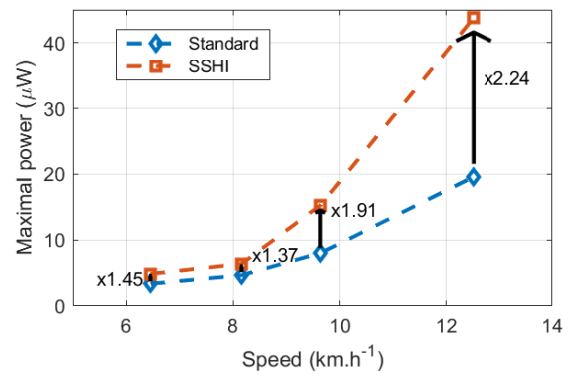

Figure 14. Experimental power as a function of car velocity.

significant improvement of the output power compared to the standard approach.

Self-powered sensor demonstration

From the successful validation of the harvesting capabilities of the smart composite car, this Section proposes an application example to self-powered temperature monitoring.

System design

Among the potential sensors able to address ultralow power constraints, the selected sensor consisted in a STM 330 module from Enocean GmbH, which includes an onboard temperature sensor. For a fair assessment of the abilities of the previously described harvesting device for powering the sensor, the photovoltaic cell as well as the battery included in the original device were removed (Figure 15).

According to the manufacturer’s user manual (STM330 (2021)), the device consumption in terms of electrical charge is 30 μC for each measurement cycle and 100 μC for each transmission, while also featuring a 500 nA current leakage. Hence, considering an average supply voltage of 3 V and a temperature measurement and transmission every 60 s, this yields an average power consumption of 8 μW (the leakage accounting for approximately 18% of this total power consumption). Although the power consumption can be slightly further decreased by disconnecting the internal transmit LED indicator, this is nevertheless compatible with the previous assessments in terms of harvested power. More precisely, it can be noted that according to the previous results this would allow the system to be energetically viable above 8.5 $\text{km}\cdot\text{h}^{-1}$ of linear speed when using the SSHI, while the critical speed reaches almost 10 $\text{km}\cdot\text{h}^{-1}$ with the sole use of rectifying and harvesting stage.

Then, the STM 330 board has been integrated into a circuit incorporating both the SSHI interface and the harvesting stage (Figure 16). In order to provide a rather constant output voltage with no significant drop during active state as well as the necessary energy for start-up, two 470 μF capacitors were used. This yields an equivalent storage capacitance of 235 μF at the harvesting stage output, which adds up with the 470 μF internal storage capacitor of the STM 330 module.

Implementation and evaluation

When connecting the whole electrical interface to the piezoelectric element, and starting from null initial conditions, both at the electrical (discharged capacitors) and operative (zero speed) levels, the recorded voltage output is depicted in Figure 17 when driving the car so that the linear speed is 12.52 $\text{km}\cdot\text{h}^{-1}$. After an initial state where the internal capacitance of the STM 330 is not connected due to the use of an internal diode that prevents reverse conduction, the voltage is almost linearly evolving (beginning of an exponential charge) up to 2.8 V before the first measurement

and data transmission at time instant of 345 s. Then the device is able to work with a measurement and sending period of 60 s with a mean voltage slightly higher than 3 V. Taking as example the last transmission cycle recorded in Figure 17, where the voltage drops from approximately 3.1 to 2.9 V, the associated energy consumption is 0.42 mJ, close to the theoretical value of 0.39 mJ from the manufacturer’s user manual (STM330 (2021)).

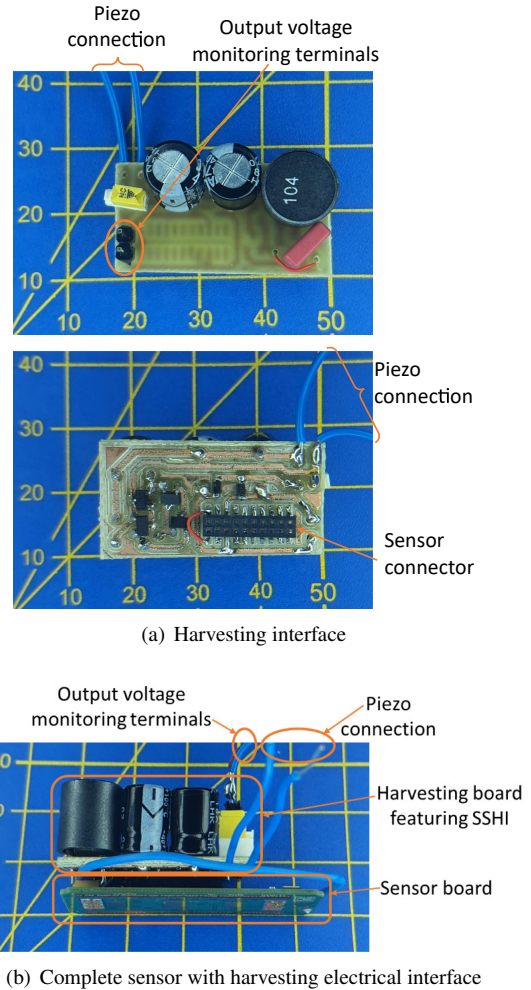

Figure 16. Electrical circuit: (a) Harvesting circuit; (b) complete circuit with sensor.

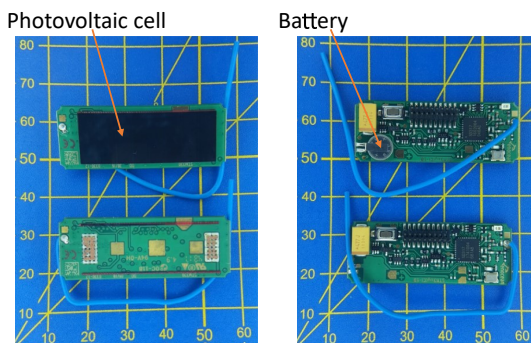

Figure 15. STM 330 module. Top: original circuit; bottom: modified circuit.

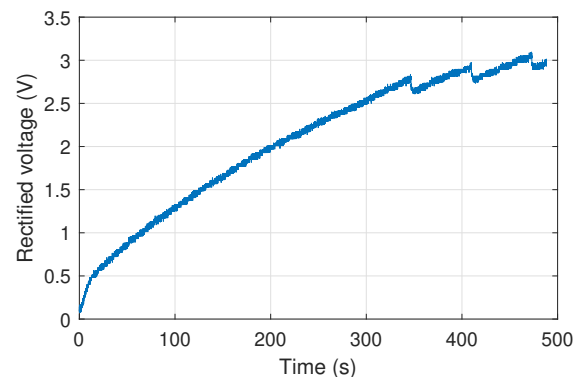
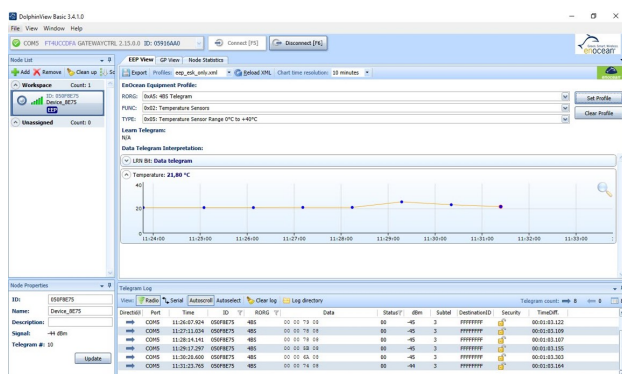

Figure 17. Rectified voltage supplying the sensor from zero initial conditions.

Finally, the data transmission was received by two means. The first one being through a computer using a USB 300 gateway from EnOcean GmbH connected to a computer equipped with DolphinView software. However, in the framework of embedded systems, a second device, based on a EnOcean Pi radio module connected to a M5Stack Core2 module (featuring ESP32 System on Chip) was also successfully tested (Figure 18).

Conclusions

With the advances in low power electronics, wireless technologies, and the increasing demand for self-sensing structures, the idea of power harvesting and self-sufficient sensors has never been more relevant. However, capturing sufficient energy from the ambient vibrations surrounding the electronics is a difficult challenge. Depending on the excitation signal nature, the structural response and the electromechanical coupling, the energy generated by piezoelectric materials is in general far too small for directly powering an electronic system.



(a) Data reception on computer (screenshot)

INSA
INSTITUT NATIONAL
DES SCIENCES
APPLIQUÉES
LYON
LGEF



Computer with
USB300 gateway

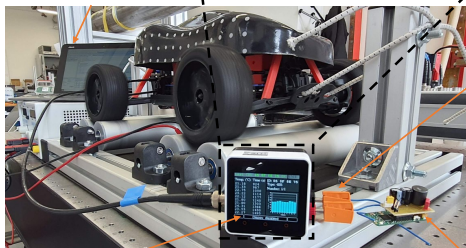

Receiving radio module with
EnOcean Pi and ESP32 interface

Self-powered
sensor with SSHI

(b) Data reception with homemade transceiver interface

Figure 18. Data transmission reading: (a) screenshot of DolphinView software using a USB300 gateway module; (b) global view featuring the homemade receiver using M5Stack Core2 module interfaced with EnOcean Pi transceiver.

Yet, this paper proposed a complete application of an energy harvesting system applied to an existing composite smart structure. A transducer has been integrated during the manufacturing process into the layers of a reduced model composite car body. Then the composite smart structure has been mounted on the vehicle chassis which was riding on a dedicated roller test bench giving a representative broadband mechanical excitation. It is worth noticing that the smart structure had not been optimized in advance in its design for energy harvesting applications, being so a representative example of an existing weakly coupled electromechanical system. However, the proposed energy harvesting circuit, based on the SSHI principle and completely self-powered from the vibrational source, allowed supplying a temperature sensor in addition to its wireless transmitter and sending the temperature data every 60s to the receiver. These experiments demonstrated the viability of the whole concept, especially the ability of the energy harvesting circuit to overcome the common difficulty of poor electromechanical coupling or broadband response in piezoelectric energy harvesting systems with up to $40\mu W$ recovered on a resistive load of $3M\Omega$. Thanks to the switching method, and even with a low voltage response from the transducer, this available power was two times higher compared to the classical piezoelectric energy harvesting circuit confirming the vibrations as a relevant energy source for embedded microgenerators and associated self-powered sensors in real industrial applications.

Now that nonlinear energy harvesting circuits can be designed and optimized to maximize the available electrical power from ambient vibrations, future perspectives are to optimize in-situ existing mechanical structures for this application. Thus, nonlinear wave traps for local strain concentration or nonlinear dynamic magnifiers are mechanical solutions to combine with SSHI methods to reach the next level of fully integrated piezoelectric energy harvesting systems.

Acknowledgements

The authors acknowledge the support of Institut Carnot Ingénierie@Lyon for funding this research through the IMPACT project and the M3M Laboratory (UTBM - France) for providing the smart composite structure.

References

- Aladwani, A., Arafa, M., Aldraihem, O. and Baz, A., 2012. Cantilevered piezoelectric energy harvester with a dynamic magnifier. *Journal of vibration and acoustics*, 134(3). <https://doi.org/10.1115/1.4005824>
- Clementi, G., Lombardi, G., Margueron, S., Suarez, M.A., Lebrasseur, E., Ballandras, S., Imbaud, J., Lardet-Vieudrin, F., Gauthier-Manuel, L., Dulmet, B. and Lallart, M., 2021. LiNbO3 films—A low-cost alternative lead-free piezoelectric material for vibrational energy harvesters. *Mechanical Systems and Signal Processing*, 149, p.107171. DOI : 10.1016/j.ymssp.2020.107171
- Eltamaly, A.M. and Addoweesh, K.E., 2016. A novel self-power SSHI circuit for piezoelectric energy harvester. *IEEE Transactions on Power Electronics*, 32(10), pp.7663-7673.

- Erturk, A., Hoffmann, J. and Inman, D.J., 2009. A piezomagnetoelastic structure for broadband vibration energy harvesting. *Applied Physics Letters*, 94(25), p.254102. <https://doi.org/10.1063/1.3159815>
- Erturk, A. and Inman, D.J., 2011. Broadband piezoelectric power generation on high-energy orbits of the bistable Duffing oscillator with electromechanical coupling. *Journal of Sound and Vibration*, 330(10), pp.2339-2353.
- Ferrari, M., Ferrari, V., Guizzetti, M. and Marioli, D., 2009. An autonomous battery-less sensor module powered by piezoelectric energy harvesting with RF transmission of multiple measurement signals. *Smart materials and Structures*, 18(8), p.085023. <https://doi.org/10.1088/0964-1726/18/8/085023>
- Gibus, D., Gasnier, P., Morel, A., Formosa, F., Charleux, L., Boisseau, S., Pillonnet, G., Berlitz, C.A., Quelen, A. and Badel, A., 2020. Strongly coupled piezoelectric cantilevers for broadband vibration energy harvesting. *Applied Energy*, 277, p.115518. <https://doi.org/10.1016/j.apenergy.2020.115518>
- Guyomar, D., Badel, A., Lefeuvre, E. and Richard, C., 2005. Toward energy harvesting using active materials and conversion improvement by nonlinear processing. *IEEE transactions on ultrasonics, ferroelectrics, and frequency control*, 52(4), pp.584-595.
- Guyomar, D., Jayet, Y., Petit, L., Lefeuvre, E., Monnier, T., Richard, C. and Lallart, M., 2007. Synchronized switch harvesting applied to selfpowered smart systems: Piezoactive microgenerators for autonomous wireless transmitters. *Sensors and Actuators A: Physical*, 138(1), pp.151-160.
- Lallart, M., Guyomar, D., Jayet, Y., Petit, L., Lefeuvre, E., Monnier, T., Guy, P. and Richard, C., 2008. Synchronized switch harvesting applied to self-powered smart systems: Piezoactive microgenerators for autonomous wireless receivers. *Sensors and Actuators A: Physical*, 147(1), pp.263-272.
- Lallart, M. and Guyomar, D., 2008. An optimized self-powered switching circuit for non-linear energy harvesting with low voltage output. *Smart Materials and Structures*, 17(3), p.035030.
- Liang, J. and Liao, W.H., 2010. Energy flow in piezoelectric energy harvesting systems. *Smart Materials and Structures*, 20(1), p.015005. <https://doi.org/10.1088/0964-1726/20/1/015005>
- Le, M.Q., Capsal, J.F., Lallart, M., Hebrard, Y., Van Der Ham, A., Reffe, N., Geynet, L. and Cottinet, P.J., 2015. Review on energy harvesting for structural health monitoring in aeronautical applications. *Progress in Aerospace Sciences*, 79, pp.147-157.
- Lefeuvre, E., Badel, A., Richard, C., Petit, L. and Guyomar, D., 2006. A comparison between several vibration-powered piezoelectric generators for standalone systems. *Sensors and Actuators A: Physical*, 126(2), pp.405-416.
- Ma, Y., Ji, Q., Chen, S. and Song, G., 2017. An experimental study of ultra-low power wireless sensor-based autonomous energy harvesting system. *Journal of renewable and sustainable energy*, 9(5), p.054702. <https://doi.org/10.1063/1.4997274>
- Meyer, Y., Lachat, R. and Akhras, G., 2019. A review of manufacturing techniques of smart composite structures with embedded bulk piezoelectric transducers. *Smart Materials and Structures*, 28(5), p.053001. <https://doi.org/10.1088/1361-665X/ab0fab>
- Müller, G., Rittenschober, T. and Springer, A., 2010. A wireless sensor network using energy harvesting for agricultural machinery. *e & i Elektrotechnik und Informationstechnik*, 127(3), pp.39-46. DOI 10.1007/s00502-010-0719-0
- Qi, S., Shuttleworth, R., Oyadiji, S.O. and Wright, J., 2010. Design of a multiresonant beam for broadband piezoelectric energy harvesting. *Smart Materials and Structures*, 19(9), p.094009. <https://doi.org/10.1088/0964-1726/19/9/094009>
- Shi, Y., Hallett, S.R. and Zhu, M., 2017. Energy harvesting behaviour for aircraft composites structures using macro-fibre composite: Part I—Integration and experiment. *Composite Structures*, 160, pp.1279-1286. <https://doi.org/10.1016/j.compstruct.2016.11.037>
- Shu, Y.C. and Lien, I.C., 2006. Analysis of power output for piezoelectric energy harvesting systems. *Smart materials and structures*, 15(6), p.1499. <https://doi.org/10.1088/0964-1726/15/6/001>
- Shu, Y.C., Lien, I.C. and Wu, W.J., 2007. An improved analysis of the SSHI interface in piezoelectric energy harvesting. *Smart Materials and Structures*, 16(6), p.2253. <https://doi.org/10.1088/0964-1726/16/6/028>
- Sodano, H.A., Inman, D.J. and Park, G., 2005. Comparison of piezoelectric energy harvesting devices for recharging batteries. *Journal of intelligent material systems and structures*, 16(10), pp.799-807. <https://doi.org/10.1177/1045389X05056681>
- STM330 user manual: https://www.enocean.com/en/products/enocean_modules/stm-330stm-331/user-manual-pdf/ (last viewed: 30/05/2021).
- Wang, Y. and Inman, D.J., 2013. Simultaneous energy harvesting and gust alleviation for a multifunctional composite wing spar using reduced energy control via piezoceramics. *Journal of Composite Materials*, 47(1), pp.125-146. doi:10.1177/0021998312448677
- Wang, G., Liao, W.H., Yang, B., Wang, X., Xu, W. and Li, X., 2018. Dynamic and energetic characteristics of a bistable piezoelectric vibration energy harvester with an elastic magnifier. *Mechanical Systems and Signal Processing*, 105, pp.427-446.
- Yan, L., Lallart, M. and Karami, A., 2019. Low-cost orbit jump in nonlinear energy harvesters through energy-efficient stiffness modulation. *Sensors and Actuators A: Physical*, 285, pp.676-684. <https://doi.org/10.1016/j.sna.2018.12.009>
- Zhou, W., Penamalli, G.R. and Zuo, L., 2011. An efficient vibration energy harvester with a multi-mode dynamic magnifier. *Smart Materials and Structures*, 21(1), p.015014. <https://doi.org/10.1088/0964-1726/21/1/015014>