



HAL
open science

Improvement of a soft electrostatic generator: polarization with a triboelectric function

Simon-Emmanuel Haim, Christophe Pollet, Axel Sanchez, Claire Jean-Mistral,
Alain Sylvestre

► To cite this version:

Simon-Emmanuel Haim, Christophe Pollet, Axel Sanchez, Claire Jean-Mistral, Alain Sylvestre. Improvement of a soft electrostatic generator: polarization with a triboelectric function. EuroEAP 2022, Jun 2022, Chianciano Terme, Italy. hal-03735724

HAL Id: hal-03735724

<https://hal.science/hal-03735724>

Submitted on 21 Jul 2022

HAL is a multi-disciplinary open access archive for the deposit and dissemination of scientific research documents, whether they are published or not. The documents may come from teaching and research institutions in France or abroad, or from public or private research centers.

L'archive ouverte pluridisciplinaire **HAL**, est destinée au dépôt et à la diffusion de documents scientifiques de niveau recherche, publiés ou non, émanant des établissements d'enseignement et de recherche français ou étrangers, des laboratoires publics ou privés.

Improvement of a soft electrostatic generator: polarization with a triboelectric function

Simon-emmanuel Haim (1) (2), Christophe Pollet (1), Axel Sanchez (1), Claire Jean-mistral (2), Alain Sylvestre (1)

Poster ID:
2.2.5

Contact e-mail:
simon-emmanuel.haim@g2elab.grenoble-inp.fr

(1) Univ. Grenoble Alpes, CNRS, Grenoble INP, G2Elab, Grenoble, France ; (2) Univ Lyon, INSA-Lyon, CNRS, LaMCoS, Villeurbanne, France

Abstract: Improvement of a soft electrostatic generator

Soft electrostatic generators (SEG), typically made of electroactive polymers like silicone, represent an efficient way to power up devices widely used in the IoT, including smart clothes, biomechanical energy harvesters or sensors. The principle of these generators is to exploit in an external circuit the electricity produced by a mechanical deformation of the SEG. The electrical charges available for this circuit have been in most cases previously brought through a high voltage supply (HVS). To get rid of the HVS and make the SEG autonomous in energy, we present an original solution based on a TENG (Triboelectric nano generator) approach used in a sliding mode. In order to develop and optimize the electrical response performance of the TENG to be coupled with our silicone-SEG, a test bench equipped with Trek electrostatic probes, a Keithley electrometer and a decade box has been designed. Thanks to this over-equipped bench, we have monitored the transfer of electrical charges between the two materials that form the TENG (copper, PET, PTFE.) over thousands of cycles in sliding mode. Modeling with a finite element model is underway to account for the observed mechanisms.

Design of a energy harvester

Triboelectric generator operating in sliding mode

- Ease to fabricate
- Ease to integrate
- High power density potential

Triboelectric serie for material selection

Teflon PVC Wool Leather Glass

Theoretical analysis to predict the performance

$$V_t = \frac{Q_t + \sigma wx}{C_{var}}, \text{ avec } C_{var} = \epsilon_0 \frac{w(l-x)}{\epsilon_t + \frac{d_b}{\epsilon_b}}$$

Integration in our hybrid structures: the triboelectric generator polarizes a dielectric elastomer generator (DEG)

Energy gain of the system:

$$W_{rec} = \frac{1}{2} (C_{min} V_{max}^2 - C_{max} V_{min}^2)$$

Scavenged energy proportional to the square of the input (polarized) voltage

Test bench setup

Translation length: 60 mm
Maximum speed: 500 mm/s
Width of samples: <55 mm
Length of samples: <60 mm

Acquisition frequency: 1 kHz
Acquisition time: 5400 s
Resistor range: 1 MΩ - 1.6 GΩ

Trek 347 electrostatic voltmeter: ±3 kV ; 3 V accuracy

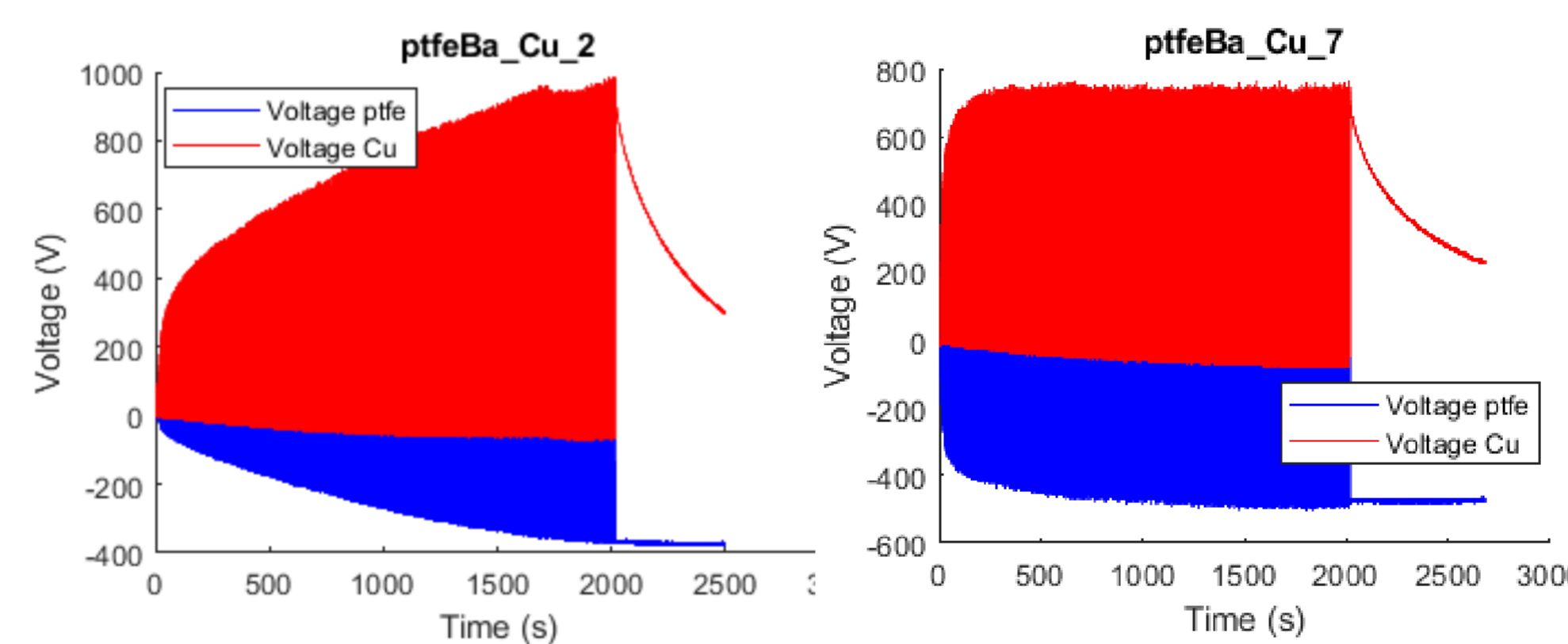
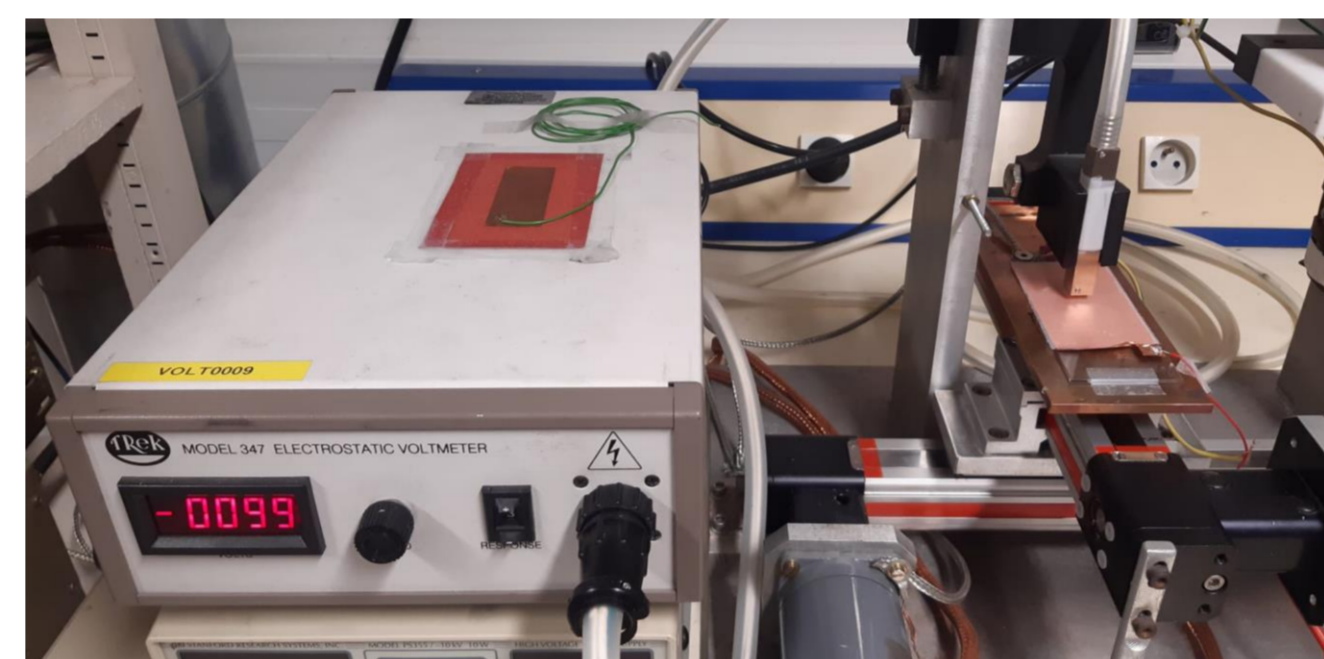

Influence of past experiments of the sample on its electrical response

Measurement of the parasitic capacitance between copper and frame

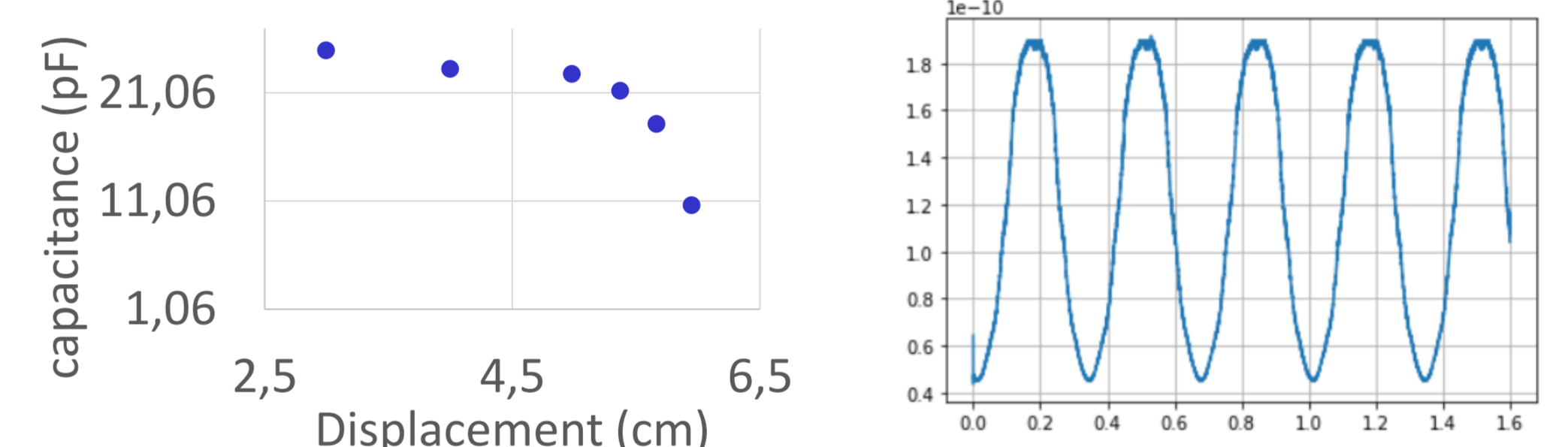
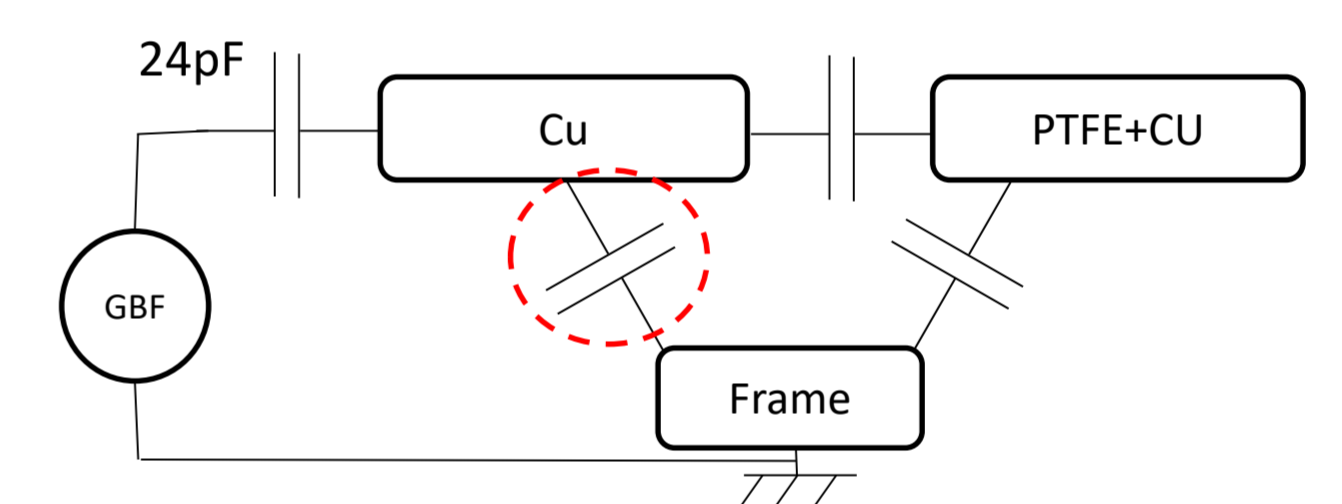

One parasitic capacitance up to 25pF
Dynamic measurement of capacitance of a TENG (in fF)
Min value: 44 pF
Max value: 192 pF

TENG in open circuit and with resistor load

Three copper electrodes in open circuit

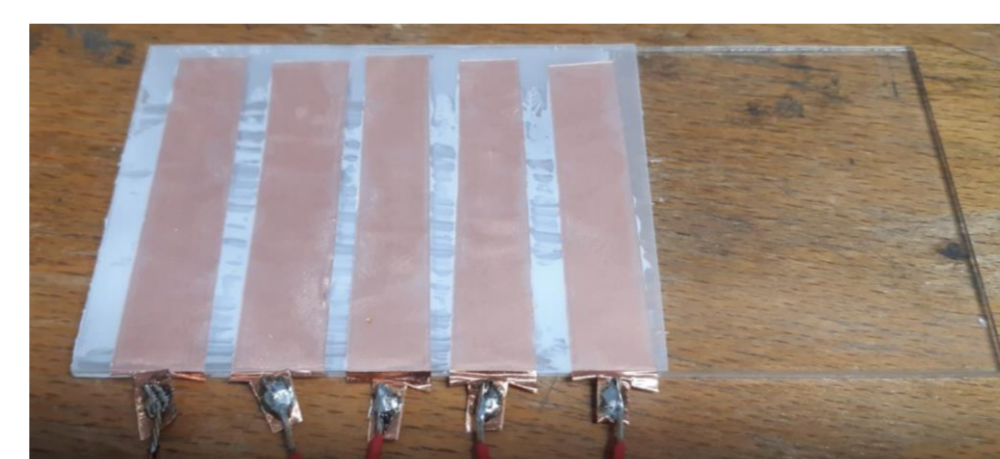
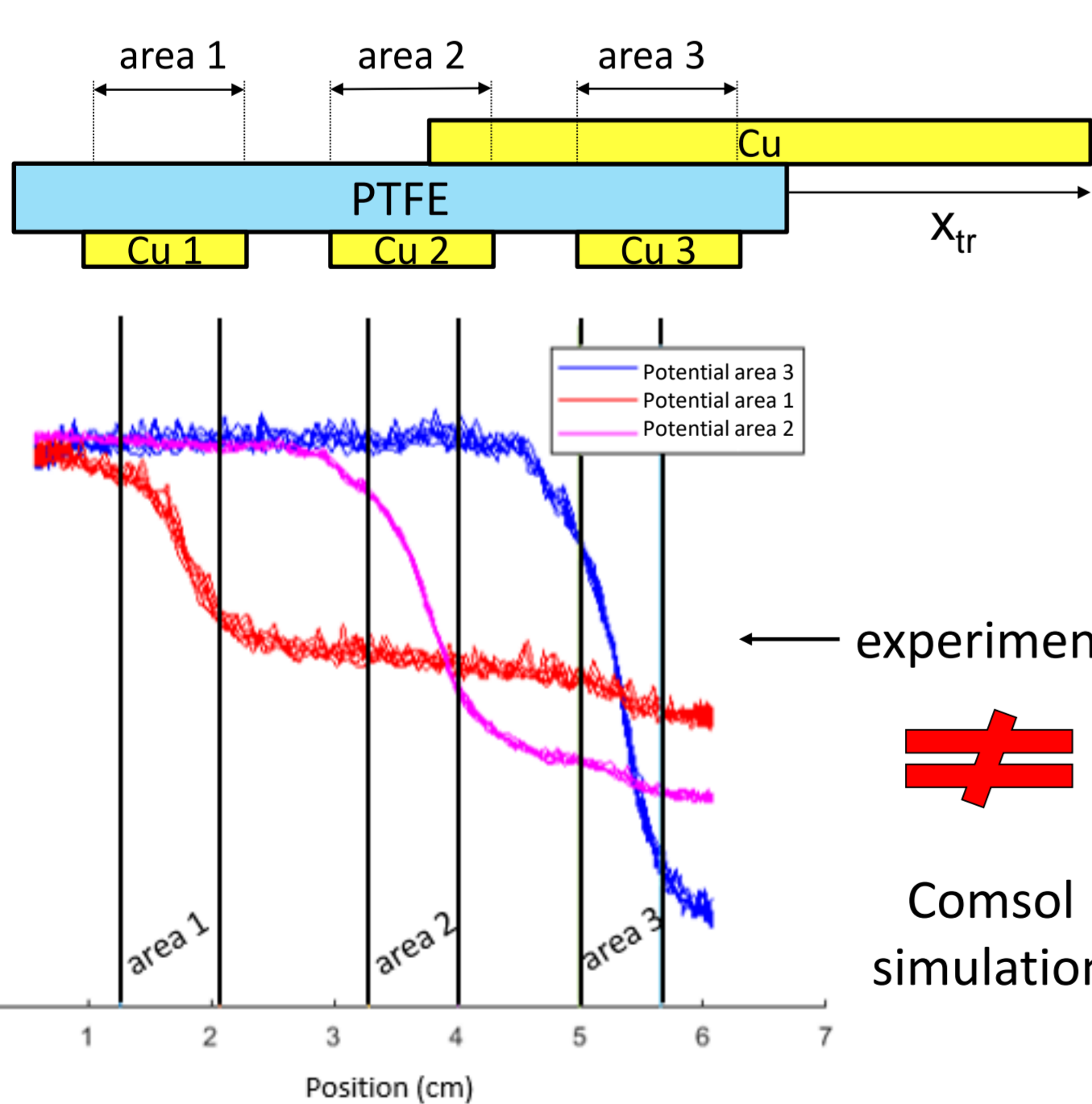

Example of device

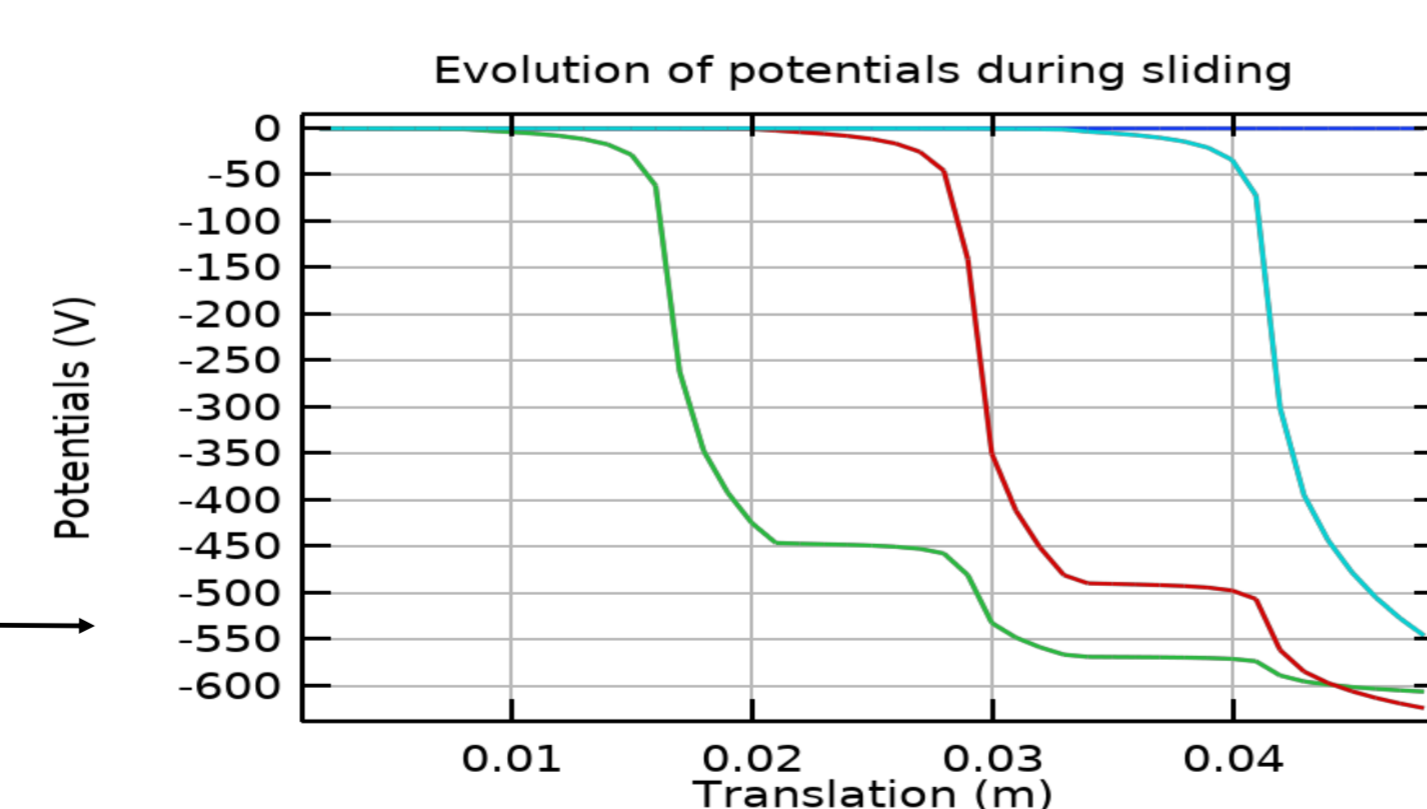

Unfiltered current measured with Keithley 6517b

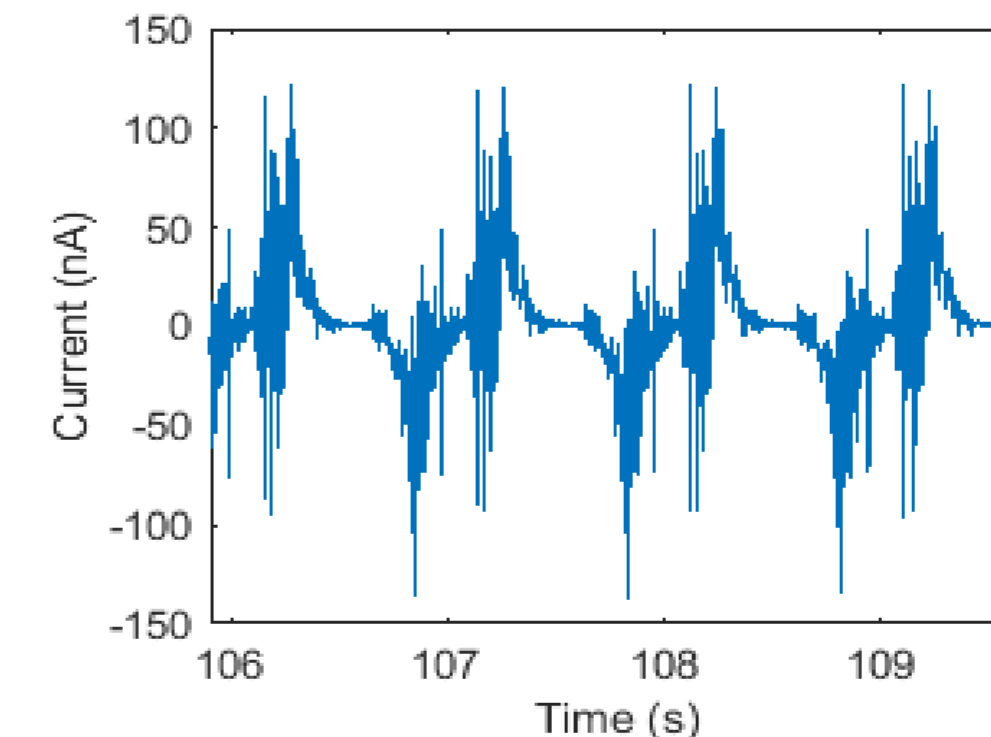

Computations with Matlab

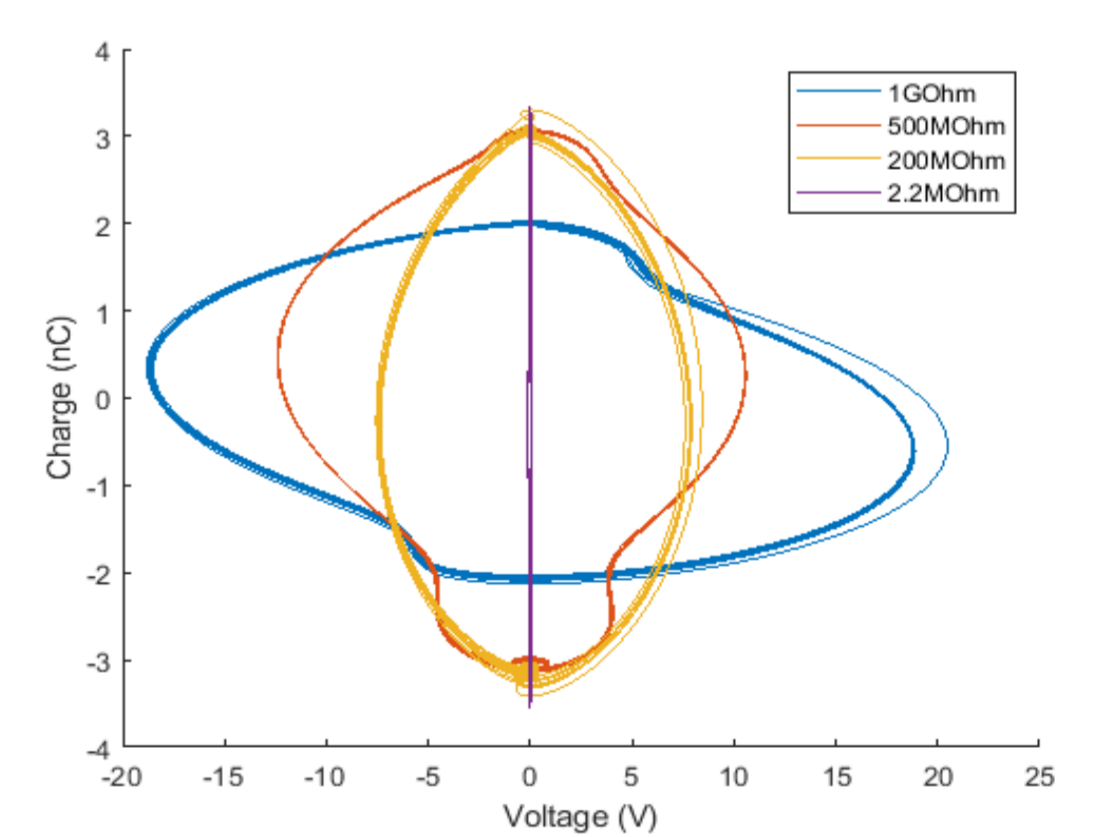

Use of QV cycles to compare power transfer with different loads

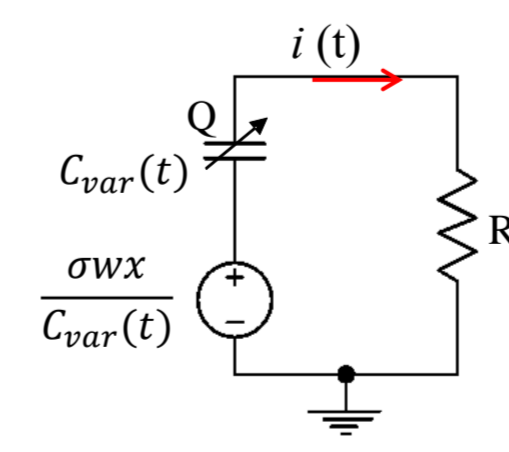

$$i = \frac{\partial Q}{\partial t} = \frac{V_s}{R} - \frac{Q}{RC_{var}}$$

$$P_{avg} = \frac{1}{t_2 - t_1} \int_{t_1}^{t_2} R \left(\frac{\partial Q}{\partial t} \right)^2 dt$$

To optimize the power transfer, a load of few hundreds of ohms is required as the area described by the QV cycle is the widest

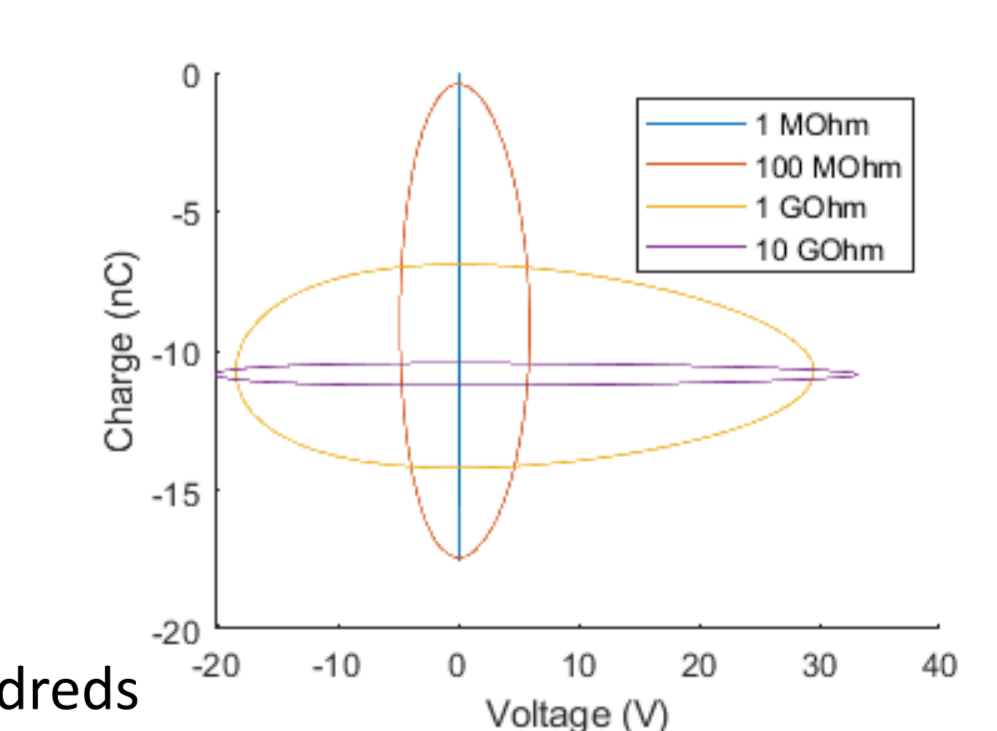

Synthesis - Conclusions

- Measurement of non-negligible parasitic capacitance between the copper film and the frame compared to the capacitance of the TENG: importance of the environment in these measurements.
- Non uniform charge density identified by experimental results that suggest promoting larger friction strokes rather than larger width for developing devices.
- Good accordance between experimental and simulated QV cycles. Be careful that the uniform load consideration of the simulations does not affect the power estimation
- Power management units remain to be tested to charge fixed capacitors at first, then SEGs. Half-wave diode rectifiers are the best candidates .
- The triboelectric phenomenon is better and better understood, even if behind apparent easy experiments remain real challenges to obtain repeatable and interpretable measurements.

References

1. Ali Ghaffarinejad, Javad Yavand Hasani, Dimitri Galayko, Philippe Basset, « Superior performance of half-wave to full-wave rectifier as a power conditioning circuit for triboelectric nanogenerators: Application to contact-separation and sliding mode TENG », Nano Energy, 2019. <https://doi.org/10.1016/j.nanoen.2019.104137>.
2. Wang, Sihong, Long Lin, Yannan Xie, Qingshen Jing, Simiao Niu, et Zhong Lin Wang. « Sliding-Triboelectric Nanogenerators Based on In-Plane Charge-Separation Mechanism ». Nano Letters 13, n° 5 (8 mai 2013): 2226-33. <https://doi.org/10.1021/nl400738p>.
3. Haque, Rubaiyet I., Gregoire Ferracci, Pierre-Andre Farine, et Danick Briand. « Fully Casted Stretchable Triboelectric Device for Energy Harvesting and Sensing Made of Elastomeric Materials ». In 2017 19th International Conference on Solid-State Sensors, Actuators and Microsystems (TRANSDUCERS), 1816-19. Kaohsiung, Taiwan: IEEE, 2017. <https://doi.org/10.1109/TRANSDUCERS.2017.7994422>