



**HAL**  
open science

# The MICADO first-light imager for the ELT: towards the preliminary design review of the MICADO-MAORY SCAO

Yann Clénet, Jean-Tristan Buey, Éric Gendron, Zoltan Hubert, Fabrice Vidal, Mathieu Cohen, Frédéric Chapron, Arnaud Sevin, Pierre Fédou, Gaële Barbary, et al.

## ► To cite this version:

Yann Clénet, Jean-Tristan Buey, Éric Gendron, Zoltan Hubert, Fabrice Vidal, et al.. The MICADO first-light imager for the ELT: towards the preliminary design review of the MICADO-MAORY SCAO. Adaptive Optics Systems VI, Jun 2018, Austin, Texas, United States. id. 1070313 11 pp., 10.1117/12.2311481 . hal-03734649

**HAL Id: hal-03734649**

**<https://hal.science/hal-03734649>**

Submitted on 5 Dec 2023

**HAL** is a multi-disciplinary open access archive for the deposit and dissemination of scientific research documents, whether they are published or not. The documents may come from teaching and research institutions in France or abroad, or from public or private research centers.

L'archive ouverte pluridisciplinaire **HAL**, est destinée au dépôt et à la diffusion de documents scientifiques de niveau recherche, publiés ou non, émanant des établissements d'enseignement et de recherche français ou étrangers, des laboratoires publics ou privés.

# PROCEEDINGS OF SPIE

[SPIDigitalLibrary.org/conference-proceedings-of-spie](https://spiedigitallibrary.org/conference-proceedings-of-spie)

## The MICADO first-light imager for the ELT: towards the preliminary design review of the MICADO-MAORY SCAO

Yann Clénet, Tristan Buey, Eric Gendron, Zoltan Hubert, Fabrice Vidal, et al.

Yann Clénet, Tristan Buey, Eric Gendron, Zoltan Hubert, Fabrice Vidal, Mathieu Cohen, Frédéric Chapron, Arnaud Sevin, Pierre Fédou, Gaële Barbary, Pierre Baudoz, Bruno Borgo, Saber Ben Nejma, Vincent Chambouleyron, Vincent Déo, Olivier Dupuis, Sébastien Durand, Florian Ferreira, Julien Gaudemard, Damien Gratadour, Elsa Huby, Jean-Michel Huet, Bertrand Le Ruyet, Napoléon Nguyen-Tuong, Clément Perrot, Simone Thijs, Youssef Younès, Gérard Rousset, Philippe Feautrier, Gérard Zins, Emiliano Diolaiti, Paolo Ciliegi, Simone Esposito, Lorenzo Busoni, Josef Schubert, Michael Hartl, Veronika Hörmann, Richard Davies, "The MICADO first-light imager for the ELT: towards the preliminary design review of the MICADO-MAORY SCAO," Proc. SPIE 10703, Adaptive Optics Systems VI, 1070313 (10 July 2018); doi: 10.1117/12.2311481

**SPIE.**

Event: SPIE Astronomical Telescopes + Instrumentation, 2018, Austin, Texas, United States

# The MICADO first-light imager for the ELT: towards the preliminary design review of the MICADO-MAORY SCAO

Yann Clénet<sup>a</sup>, Tristan Buey<sup>a</sup>, Eric Gendron<sup>a</sup>, Zoltan Hubert<sup>a</sup>, Fabrice Vidal<sup>a</sup>, Mathieu Cohen<sup>b</sup>, Frédéric Chapron<sup>a</sup>, Arnaud Sevin<sup>a</sup>, Pierre Fédou<sup>a</sup>, Gaële Barbary<sup>a</sup>, Pierre Baudoz<sup>a</sup>, Bruno Borgo<sup>a</sup>, Saber Ben Nejma<sup>a</sup>, Vincent Chambouleyron<sup>a</sup>, Vincent Déo<sup>a</sup>, Olivier Dupuis<sup>a</sup>, Sébastien Durand<sup>a</sup>, Florian Ferreira<sup>a</sup>, Julien Gaudemard<sup>b</sup>, Damien Gratadour<sup>a</sup>, Elsa Huby<sup>a</sup>, Jean-Michel Huet<sup>b</sup>, Bertrand Le Ruyet<sup>a</sup>, Napoléon Nguyen-Tuong<sup>a</sup>, Clément Perrot<sup>a</sup>, Simone Thijs<sup>a</sup>, Youssef Younès<sup>b</sup>, Gérard Rousset<sup>a</sup>, Philippe Feautrier<sup>c</sup>, Gérard Zins<sup>d</sup>, Emiliano Diolaiti<sup>e</sup>, Paolo Ciliegi<sup>e</sup>, Simone Esposito<sup>f</sup>, Lorenzo Busoni<sup>f</sup>, Josef Schubert<sup>g</sup>, Michael Hartl<sup>g</sup>, Veronika Hörmann<sup>g</sup>, and Richard Davies<sup>g</sup>

<sup>a</sup>LESIA, Observatoire de Paris, Université PSL, CNRS, Sorbonne Université, Univ. Paris Diderot, Sorbonne Paris Cité, 5 place Jules Janssen, 92195 Meudon, France

<sup>b</sup>GEPI, Observatoire de Paris, Université PSL, CNRS, 5 place Jules Janssen, 92195 Meudon, France

<sup>c</sup>IPAG, Univ. Grenoble Alpes, 38000 Grenoble, France

<sup>d</sup>ESO, ESO Vitacura, Alonso de Córdova 3107, Vitacura, Casilla 19001, Santiago de Chile, Chile

<sup>e</sup>Osservatorio Astrofisico di Bologna, Via Ranzani 1, 40127-Bologna, Italy

<sup>f</sup>Osservatorio Astrofisico di Arcetri, Largo E. Fermi 5, 50125-Firenze, Italy

<sup>g</sup>Max Planck Institute for extraterrestrial Physics, 85748 Garching, Germany

## ABSTRACT

MICADO is the European ELT first-light imager, working in the near-infrared at the telescope diffraction limit. Provided by MAORY, the ELT first-light adaptive optics module (AO), MCAO will be the primary AO mode of MICADO, driving the design of the instrument. MICADO will also come with a SCAO capability. Developed under MICADO's responsibility and jointly by MICADO and MAORY, SCAO will be the first AO mode to be tested at the telescope, in a phased approach of the AO integration at the ELT. The MICADO-MAORY SCAO preliminary design review (PDR) will occur in November 2018.

We present here different activities and results we have had in the past two years preparing this PDR, covering several fields (opto-mechanics, electronics, real-time and control software, integration and tests, AO simulations and performance, prototyping) and the different SCAO subsystems (pyramid wavefront sensor, calibration unit, real-time computer, dichroic and the so-called Green Doughnut which hosts the SCAO assembly as well as the MAORY MCAO natural guide star wavefront sensors).

**Keywords:** ELT, MICADO, MAORY, SCAO, preliminary design, simulations, prototyping

## 1. INTRODUCTION

### 1.1 The MICADO instrument

MICADO is the European Extremely Large Telescope first-light imager.<sup>1</sup> The instrument will work in the near-infrared, from 0.8 to 2.4 microns, with a field of view of about 1 arcmin<sup>2</sup>, delivering images at the telescope diffraction limit thanks to adaptive optics correction (see sect. 1.2).

---

Further author information: send correspondence to Y. Clénet, e-mail: yann.clenet "at" obspm.fr

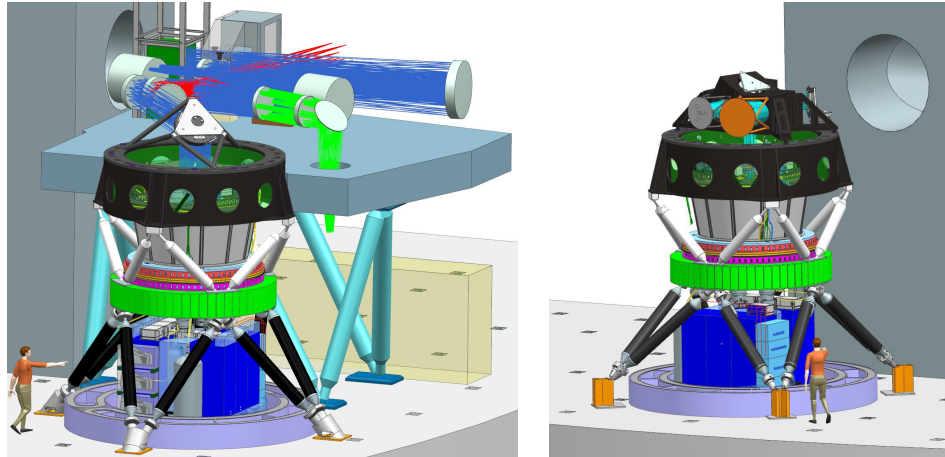

Figure 1. Left: MICADO and MAORY mounted together at the telescope. Right: MICADO at the telescope in its standalone configuration, i.e. with the SCAO module alone and a dedicated optical relay.

MICADO will offer to the astronomers four observing modes:

- classical imaging: this mode will make use of the  $3 \times 3$  Hawaii 4RG detectors. Two different plate scales will be offered, 4 mas ( $50'' \times 50''$  field of view) in the low resolution imaging mode (LRI) and 1.5 mas ( $19'' \times 19''$  field of view) in the high resolution imaging mode (HRI). More than 30 filters will be available, including those dedicated to spectroscopy.
- astrometric imaging: in this mode, the instrument configuration is similar to the classical imaging mode. But, this mode will take advantage of the instrument design, with fixed mirrors in HRI and flat mirrors moved for LRI, and will make use of dedicated calibration to reach an astrometric precision of  $50 \mu\text{as}$  relative to a set of reference sources in the field.
- spectroscopy: this long-slit spectroscopy mode is optimized for compact sources with 16 mas width slits. 50 mas width slits will also be available. A  $3''$  long slit will cover simultaneously the IzJ bands or the HK bands and a  $15''$  long slit might cover simultaneously different wavelength bandpasses. The expected spectral resolution is 10000 integrated across the slit or 20000 for point sources.
- high contrast imaging:<sup>2</sup> this mode can make use either of focal plane coronagraphic masks (classical Lyot or vortex) or pupil plane coronagraphic masks (vAPP). It is planned to be used tracking the pupil in order to be able to use classical post-processing technics for exoplanet study, such as ADI.

The project kick-off took place in October 2015. The preliminary design review is planned in November this year and first light in 2025.

## 1.2 Adaptive optics for MICADO

MICADO will work at the diffraction limit of the telescope thanks to OA. It will benefit from two possible AO corrections: either MCAO or SCAO (Fig. 1).

The MCAO correction will be provided by the MAORY instrument,<sup>3</sup> with a moderate AO correction and a large sky coverage. The design of MICADO is optimized for MAORY in order to benefit from its AO correction on the entire MICADO field of view.

The SCAO correction will be provided by a dedicated module developed under MICADO's responsibility with contributions from the MAORY consortium. Both MICADO and MAORY consortium agreed with ESO that this SCAO will be the first AO mode tested at the telescope, in a phased approach of the AO development. The SCAO module will be integrated in the MAORY instrument in the end. But in order to cope with a potential delay of the MAORY project, SCAO is required to be able to be used with MICADO without MAORY and then to be designed accordingly.

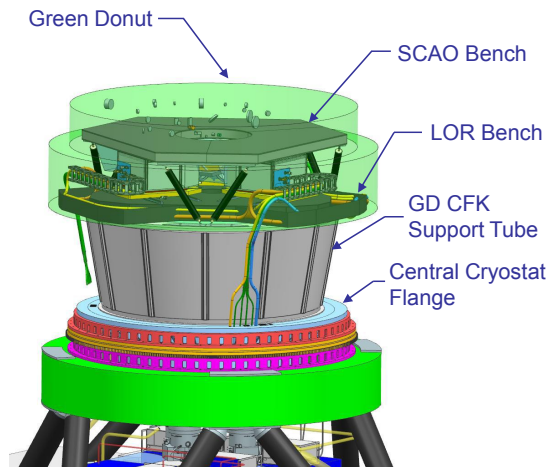

Figure 2. Closer view of the Green Doughnut, with the two AO benches (SCAO bench atop and MCAO LOR bench at the bottom), the support tube interfacing the Green Doughnut with the MICADO cryostat.

## 2. SUBSYSTEM DESIGN

### 2.1 The SCAO Green Doughnut structure

The SCAO opto-mechanical parts are located in the so-called "Green Doughnut" volume, which is the green volume that one can see on Fig. 1, surrounded by a black structure with portholes.

The light coming from the telescope is going out horizontally from the telescope pre-focal station, going through an optical relay (either the MAORY one, which contains deformable mirror(s), or the standalone one, made of static mirrors). The last mirror of either relay is directing the light downwards allowing the MICADO cryostat to be in a gravity invariant position. Just after this last optical relay mirror, the light is entering the Green Doughnut volume.

This volume is shared between the three MAORY natural guide star low order and reference (LOR) WFS and the MICADO-MAORY SCAO WFS. After discussions between MICADO and MAORY the volume has been shared by having SCAO occupying the upper part of the volume and MCAO LOR the lower part, in order to minimize the distance between the LOR and the MICADO entrance focal plane, which maximizes the LOR patrol field of view and then MAORY sky coverage.

To limit the interfaces, MCAO WFSs and SCAO WFS are supported each one by their own benches, the SCAO bench being hence above the MCAO LOR one. These two benches are interfaced with the MICADO cryostat+derotator thanks to a support tube, today carbon fiber made (Fig. 2).

The SCAO Green Doughnut structure is made of the SCAO bench, the feet interfacing this bench with the support tube, the baffling and the SCAO dichroic assembly. This SCAO GD structure have stringent specifications to comply with:

- an envelop of 2.8 m × 0.4 m
- a first eigenfrequency of 50 Hz, with a goal of 80 Hz
- a mass budget of 1.5 tons for the whole GD, 550 kg for the SCAO parts
- thermal stability

Given these specifications, using finite element simulations, our study came out with a design with carbon fiber made bench+feet, together with a baffling contributing to the global structural stability.

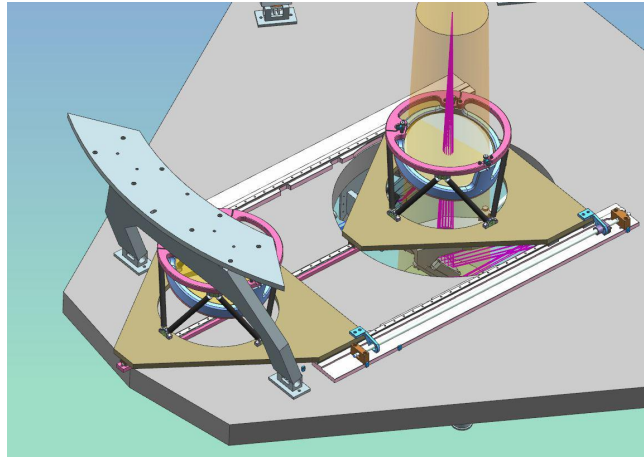

Figure 3. View below the SCAO bench showing the dichroic assembly in its two allowed positions, in the beam or in its parking position at the edge of the GD volume.

Regarding the SCAO dichroic plate, it has been specified to be removable for MCAO operations to allow a better transmission in the MCAO mode. Hence, the dichroic plate is mounted on an assembly allowing for two fixed positions, either in the beam for SCAO operations (LOR WFS are then in their parking positions) or in parking position for MCAO operations. The dichroic assembly is located below the SCAO bench, taking care of the LOR WFS operating volumes (Fig. 3).

A critical parameter for this dichroic is its inclination angle:

- the larger the angle, the larger the resulting optical aberrations (astigmatism), hence pushing for lowering this angle
- the larger the angle, the lower the vignetting of the MCAO patrol field of view by SCAO parts (first mirror assembly), hence pushing for increasing this angle (cf. Fig 4)
- the larger the angle, the lower the available volume for SCAO parts on the bench, hence pushing for lowering this angle

The trade-off analysis came out with an angle value of 18°.

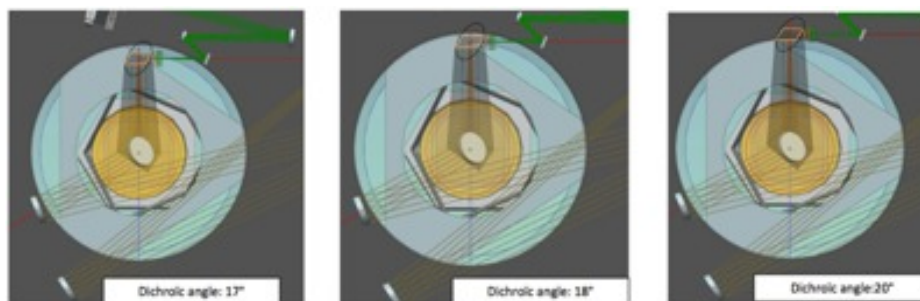

Figure 4. Footprint of the SCAO first mirror assembly on the MCAO LOR field of view for SCAO dichroic inclination angle values of 17°, 18° and 20°.



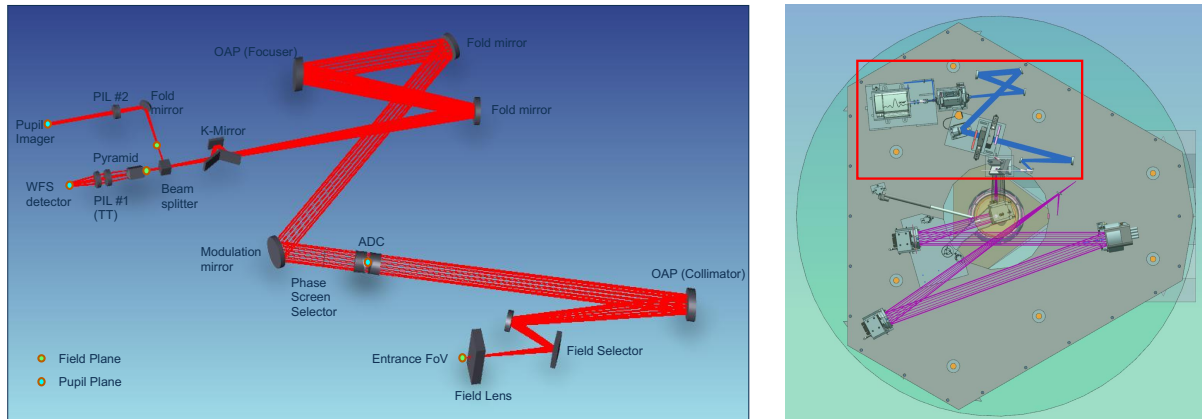

Figure 5. Left: optical design of the MICADO-MAORY SCAO WFS. Right: mechanical implementation of the MICADO-MAORY SCAO WFS on the SCAO bench. The WFS parts are those inside the red rectangle.

## 2.2 WFS

The WFS baseline is to use a pyramid wavefront sensor. The optical design incorporates several required functionalities and their corresponding parts:

- pupil alignment: a adjustable mirror is placed close to the entrance focal plane of the WFS
- pupil tracking in rotation and x/y: the former is ensured thanks to a K-mirror while the second is provided by shifting in x/y the pupil imaging lenses located between the WFS detector and the pyramid
- field selection and tracking: two moving mirrors are acting as a field selector allowing to patrol a  $20'' \times 6''$  field of view and to do differential tracking between the science and the WFS sources. The size of the WFS patrol field of view has been chosen to allow the observations of the Galactic Centre for which the separation between the visible WFS reference source and the Galactic Centre is about  $20''$ .
- atmospheric dispersion correction: this is provided by a classical two rotating double prisms
- pre-compensation of non common path aberrations (NCPA): we have chosen to pre-compensate for these NCPA by having phase plate(s) in the WFS, located after the ADC. In the current design a single phase plate is sufficient to adapt the different MICADO observing modes (see Sect. 3.3). Though a mechanism is necessary there to allow for two positions: the phase plate position and a free position for calibration.
- modulation for the pyramid wavefront sensor: this is provided by a PI mount.
- focus adjustment: this is provided by mounting the WFS camera, the pupil imaging lenses and the pyramid optics on a stage
- wavefront sensing: this is provided by a double pyramid (allowing compensation of the chromaticism)
- detection: this is provided by a  $240 \times 240$  E2V detector based camera
- pupil viewing for maintenance: this is provided by a simple camera fed thanks to a beam splitter located between the K-mirror and the pyramid optics. It is only used for maintenance to image at high resolution the pupil.

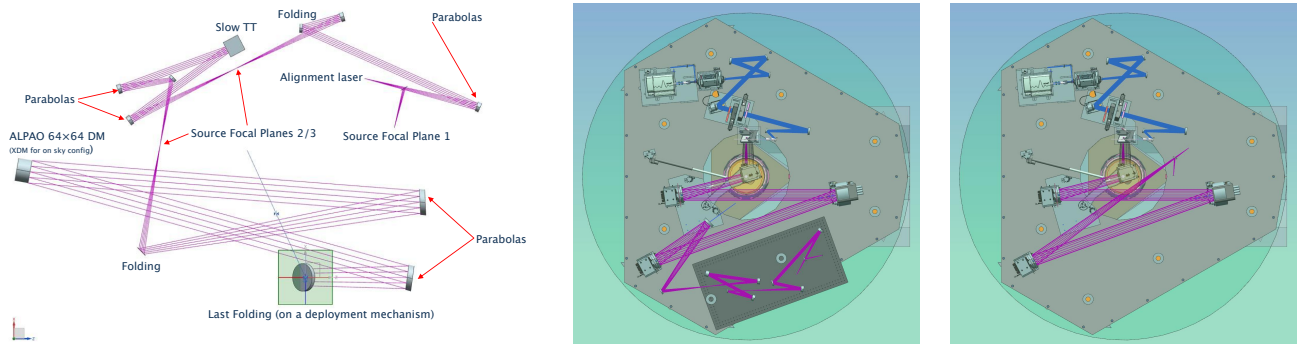

Figure 6. Left: Optical design of the SCU in the AIT configuration, with its three optical relays and their associated devices. Middle and right: design of the MICADO-MAORY SCAO calibration unit in the AIT (middle) and on-sky (right) configurations. SCU parts are on the lower part of the image, intercepting the purple beam.

### 2.3 SCAO calibration unit

An other subsystem of the SCAO system is its calibration unit (SCU). Our strategy is to develop an AIT tool and from this tool to build the SCU. Hence two configurations have to be considered for the SCU: AIT (conf. 1) and operations at the telescope (conf. 2). The SCU is made of three independent subparts (Fig. 6):

- a first optical relay providing
  - a pupil plane for an ALPAO 64×64 actuator deformable mirror (DM), used in conf. 1, or for a low order and large aperture deformable mirror in conf. 2. The high order DM will be used during the AIT phases in Europe to check the SCAO performance while the low order DM will be used during operations in Chile for the NCPA calibrations.
  - an entrance focal plane for a source module and an alignment laser (in conf. 2, during operations)
- a second optical relay providing
  - a pupil plane for a slow tip-tilt mirror in conf. 1 during AIT, in order to reproduce, together with the aforementioned high order DM, the ELT configuration with M4/M5
  - an entrance focal plane for a source module (in conf. 1 during AIT)
- a third optical relay providing
  - a pupil plane for pupil masks and turbulent phase screens, in conf. 1 during AIT
  - an entrance focal plane for a source module and alignment laser, in conf. 1 during AIT

The second and third optical relay and corresponding optics/devices will be mounted on a separated board fixed on the SCAO bench during AIT and retrieved after commissioning (Fig. 6).

### 2.4 Real-time computer

A third subsystem of the SCAO system is the real-time computer (RTC). The global architecture of the ELT instrument RTC is defined by ESO (Fig. 7). Hence the RTC is divided into three subsystems:

- the hard real-time core (HRTC), in charge of the real-time computations and in interface with the deformable mirror(s) and wavefront sensor camera(s),
- the soft real-time cluster (SRTC), in charge of the optimisation of the HRTC computations, by processing the HRTC telemetry data, and of the HRTC supervision. Part of the software of the SRTC will be delivered by ESO, as a RTC toolkit. The latter provides tools and libraries to aid in the construction of the SRTC application software. Functionality and interfaces which are provided by the ESO toolkit are highlighted in blue in Fig. 7.



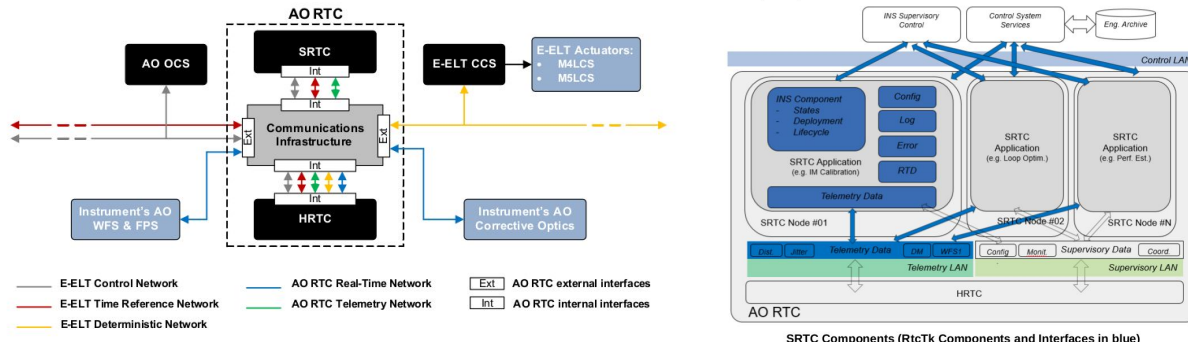

Figure 7. Left: RTC architecture as defined by ESO. Right: SRTC components, emphasizing in blue the ESO RTC toolkit.

- a communication infrastructure, to ensure the interface and data transfer internal to the RTC (between the HRTC, the SRTC), as well as between the RTC and the deformable mirror(s), the wavefront sensor camera(s) and the telescope communication infrastructure.

The MICADO-MAORY SCAO RTC will of course follow the architecture required by ESO and our baseline design is addressing the three RTC subsystems. The HRTC and SRTC will be based on developments undertaken at LESIA in the framework of the H2020 Green Flash project.<sup>4</sup> Hence, using GPU accelerators, the HRTC design will be based of a smart interconnect between the HRTC and the WFS camera, with a direct FPGA-GPU data transfer to optimize this transfer from the camera to the GPU. In addition we will make use of persistent kernels running on the GPU,<sup>5</sup> allowing a significant gain in terms of latency and jitter (Fig. 8). The SRTC will make use of optimized algorithms and methods developed on GPU also in the Green Flash project.

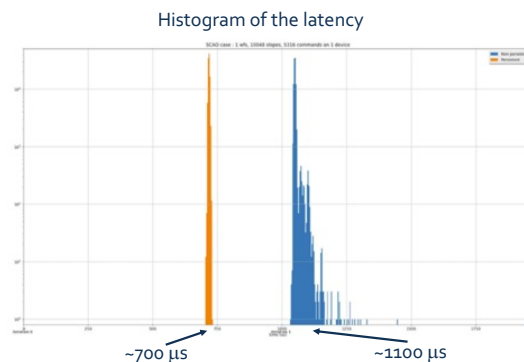

Figure 8. Histogram of latency from data transfer tests performed in SCAO configuration. In blue: non persistent kernel case, in orange: persistent kernel case.

## 2.5 Control software

The instrument control software of the SCAO system must follow the ESO instrument control system (ICS) framework. The latter is in course of definition but consequent preliminary information have been provided by ESO so that we have been able to define a preliminary design.

This design has been developed together with the MAORY consortium: since in the end SCAO will be part of MAORY, we decided between MICADO and MAORY that the SCAO ICS is part of the MAORY ICS. We worked together with MAORY on an architecture allowing the simplest interfaces inside the MAORY ICS so that we can still comply with our requirement to be able to operate SCAO in standalone if needed. Hence the interface between the MICADO ICS and the MAORY ICS is done by a observing coordination manager (OCM) dispatching the received commands either to the SCAO ICS or the MCAO ICS (Fig. 9). In a potential standalone configuration, this OCM will simply ignore the MCAO branch.

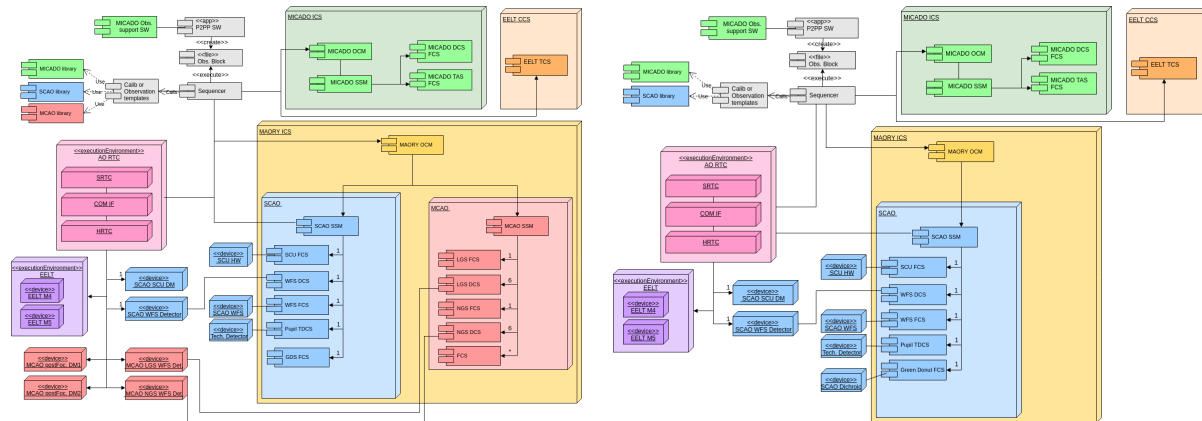

Figure 9. Left: global MICADO + MAORY ICS architecture, with both SCAO and MCAO in the MAORY ICS. Right: MICADO + SCAO ICS architecture in the standalone configuration.

### 3. ADAPTIVE OPTICS SIMULATIONS

#### 3.1 Simulation tool

We have made our AO simulations with the GPU-based platform COMPASS.<sup>6</sup> This platform has been run on a server equipped with two CPU Intel(R) Xeon(R) CPU E5-2630 v4 running at 2.20 GHz (10 cores each) with 64GB RAM and eight NVIDIA Titan X (Pascal) GPU cards.

This platform allows to perform simulations at a fast execution time even with the high resolution model of the pyramid wavefront sensor implemented in COMPASS. At the ELT scale, the final pyramid image is on 512×512 pixel support. The simulation of an ELT SCAO with a pyramid modulated at  $5\lambda/d$  runs at  $\sim 10$  Hz, leading to 40 min for the total simulation time (accounting for the initialization and 8096 iterations at 500 Hz).

#### 3.2 SCAO performance

Currently the AO simulations have been done assuming perfect pyramid optical gain compensation, no spider in the WFS pupil, no telescope segmentation and no transient/vibration telescope effect. We have performed simulations to derive the SCAO performance versus:<sup>7</sup>

- the type of WFS: pyramid WFS is outperforming the Shack-Hartmann WFS, particularly considering the difference in readout noise for the detectors contemplated for the two WFS
- the guide star magnitude
- the turbulence conditions (following the different cases identified by ESO)
- the guide star off-axis distance
- the pyramid modulation radius
- the WFS pupil sampling
- the number of controlled modes

Comparing the results of these simulations with those performed by MAORY to derive the performance in the field of the MCAO mode (extrapolated to a  $0.79''$  seeing and assuming two post-focal deformable mirrors), one can draw the following conclusions (Fig. 10):

- for a NGS off-axis distance lower than  $\sim 20$  arcseconds, SCAO is performing better than MCAO (though with a poorer sky coverage)
- for a NGS off-axis distance larger than  $\sim 20$  arcseconds, MCAO is performing better than SCAO

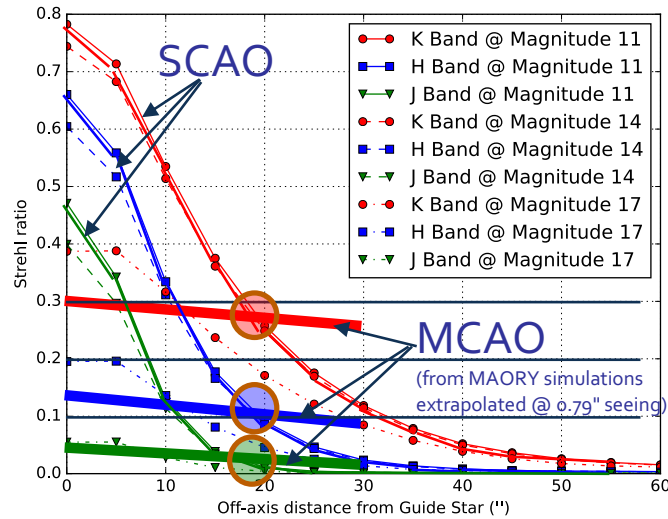

Figure 10. Comparison between the SCAO and the MCAO performance in the field, the latter being derived from MAORY simulations (done with 2 post-focal deformable mirrors) and extrapolated at  $0.79''$  seeing.

### 3.3 Non common path aberrations

The non common path aberrations (NCPA) are those aberrations that are not common to the WFS and the scientific path, i.e. those coming from optics located after the dichroic plate, either in the WFS path or in the scientific path.

We have made the choice to compensate for the NCPA thanks to a phase plate located inside the WFS path (see Sect. 2.2). This is motivated by simplicity with regards to using a more complex sub-system inside the WFS made of a deformable mirror together with a Shack-Hartmann.

Our current estimations of the NCPA are:

- from the dichroic plate: 110 nm rms (astigmatism)
- from optics inside the MICADO cryostat:
  - in the MICADO low resolution imaging mode: 111 nm rms wavefront error for the low spatial frequencies and 49 nm rms wavefront error for the medium spatial frequencies
  - in the MICADO high resolution imaging mode: 111 nm rms wavefront error for the low spatial frequencies and 63 nm rms wavefront error for the medium spatial frequencies

We have performed AO simulations to derive a strategy for the NCPA compensation and to derive the number of phase plates necessary to cover the different MICADO observing modes.

These simulations have shown that the strategy classically used with a Shack-Hartmann wavefront sensor, by simply applying reference slopes, is dramatic in terms of correction: the loop easily crashes and the result is far more worse than simply do nothing and work without reference slopes (Fig. 11). Hence compensating for pyramid optical gains is mandatory to ensure a good correction.<sup>8</sup>

We have simulated the performance achieved by using a single phase plate, assuming a certain level of compensation of the dichroic astigmatism (for 0% to 95%) by this phase plate. Considering the MICADO case, where the NCPA apart from the dichroic astigmatism is estimated to to  $\sim 110$  nm rms, using this phase plate together with reference slopes and optical gain compensation, the loss of performance is limited a few per cent Strehl (2-3% in K-band, Fig. 11). We hence have decided to use a single phase plate for NCPA compensation in the SCAO design.

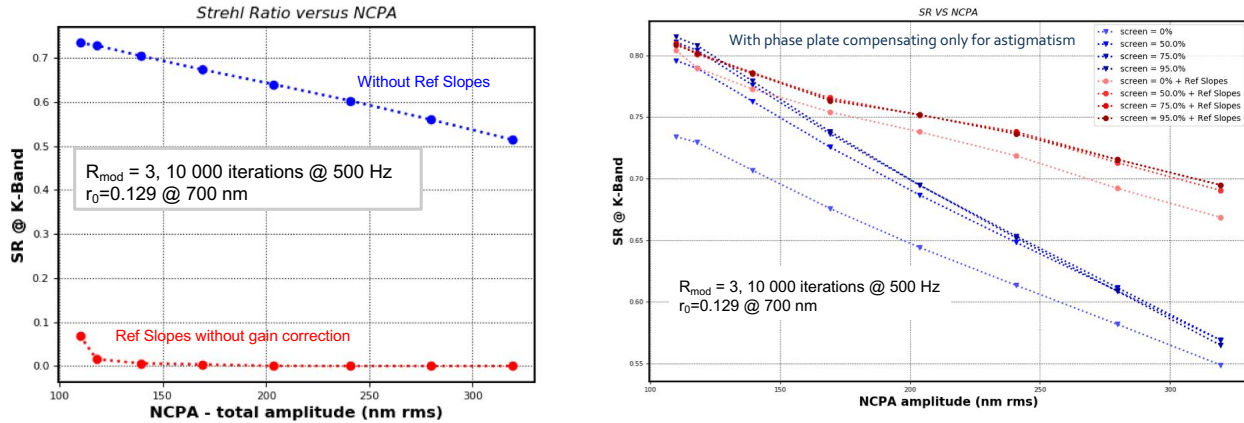

Figure 11. Left: SCAO performance when compensating NCPA by applying reference slopes without any pyramid optical gain compensation (red curve) or when not compensating for NCPA (blue curve). Right: SCAO correction when assuming a certain level of compensation of the dichroic astigmatism (for 0% to 95%) without any reference slope (blue curves) and with reference slopes together with optical gain compensation (red curves). For both figures, we have modeled the NCPA as 110 nm rms of astigmatism together a given amount of aberrations uniformly distributed over Zernike modes Z6 to Z30.

## 4. PROTOTYPING

### 4.1 K-mirror prototyping

A K-mirror is used in the SCAO WFS path for the pupil stabilization in rotation and ensure the proper conjugation between the WFS and M4.

If not well aligned or if badly made, the K-mirror could induces a field rotation within the field stop of the WFS leading to a shift in the scientific images. To avoid any noticeable impact on the performance the specifications for this K-mirror is to keep the image shift within  $\sim 0.1 \lambda/D$  over a period of time of 120 s. Considering that the peak speed in rotation is reached at  $2^\circ$  from zenith with a speed of  $0.05^\circ/s$ , it translates into a specification of  $\sim 0.1 \lambda/D$  over  $6^\circ$  rotation.

The objectives of the K-mirror prototyping we are undertaking is to demonstrate the K-mirror alignment with these stringent required tolerances and to validate a new alignment procedure we have developed for K-mirrors.

We have produced a first prototype using 3-D printing with some metals and real roller bearings. This prototype already comply with the targeted specifications. We are planning to produced a second prototype, fully metal made, to work with a model closer to the definitive one.

### 4.2 CANARDO

CANARDO (CANARY for MICADO) is an on-sky demonstration of our SCAO system we have integrated in our SCAO development plan.

The objectives are to validate in variable observing conditions the performances of the MICADO-MAORY SCAO pyramid WFS and RTC, checking the procedures/algorithms developed for calibrations, pyramid optical gain compensation and NCPA compensation.

The plan is to use the Canary bench developed at the William Herschel telescope to demonstrate MOAO and various AO modes/algorithms.<sup>9</sup> We plan to install there in 2021 the first version of the MICADO-MAORY SCAO pyramid WFS and RTC, together with the coming ALPAO  $64 \times 64$  actuator DM, and to spend few nights to test the RTC, the WFS and the global SCAO loop.

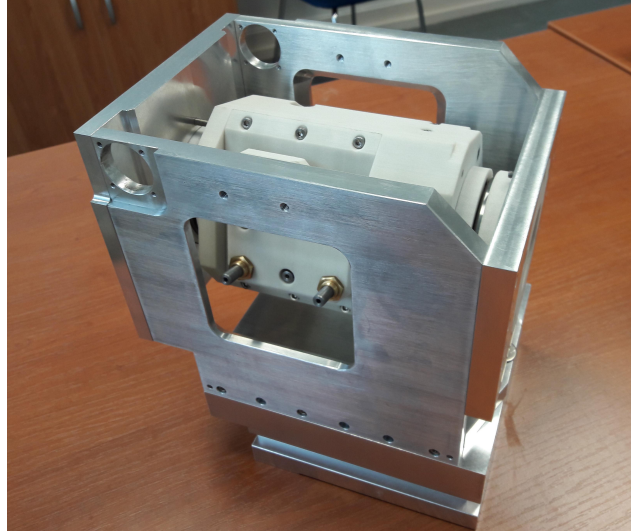

Figure 12. Photo of our 3-D printing K-mirror.

## 5. CONCLUSIONS

Our SCAO design has been driven by

- performance at low flux, leading to the choice of the pyramid wavefront sensor
- robustness and, as much as possible, simplicity, leading to a simplified SCU on-sky configuration (compared to our very first design), the use of (a single) phase plate to handle the NCPA, a limited number of operating modes.

Our designs and plans will be presented during the MICADO preliminary design review, planned in late November 2018.

## REFERENCES

- [1] R. Davies, J. Alves, Y. Clénet, *et al.*, “The MICADO first light imager for ELT: overview and operation,” in *Ground-based and Airborne Instrumentation for Astronomy VII, Proc. SPIE* **10702**, 2018.
- [2] P. Baudoz, E. Huby, Y. Clénet, *et al.*, “The MICADO first light imager for ELT: updated performance of the high contrast imaging mode,” in *Ground-based and Airborne Instrumentation for Astronomy VII, Proc. SPIE* **10702**, 2018.
- [3] P. Ciliegi, E. Diolaiti, R. Abicca, *et al.*, “MAORY for ELT: preliminary design overview,” in *Adaptive Optics System VI, Proc. SPIE* **10703**, 2018.
- [4] D. Gratadour, T. Morris, H. Deneux, *et al.*, “Prototyping AO RTC using emerging high performance computing technologies with the Green Flash project,” in *Adaptive Optics System VI, Proc. SPIE* **10703**, 2018.
- [5] J. Bernard, A. Sevin, D. Perret, *et al.*, “Performance of a scalable GPU based SCAO RTC prototype,” in *Adaptive Optics System VI, Proc. SPIE* **10703**, 2018.
- [6] F. Ferreira, D. Gratadour, A. Sevin, *et al.*, “Real-time end-to-end AO simulations at ELT scale on multiple GPUs with the COMPASS platform,” in *Adaptive Optics System VI, Proc. SPIE* **10703**, 2018.
- [7] F. Vidal, V. Déo, A. Sevin, *et al.*, “End-to-end simulations for the MICADO-MAORY SCAO mode,” in *Proceedings of the AO<sub>4</sub>ELT5 conference*, 2017.
- [8] V. Déo, E. Gendron, G. Rousset, *et al.*, “A modal approach to optical gain compensation for the pyramid wavefront sensor,” in *Adaptive Optics System VI, Proc. SPIE* **10703**, 2018.
- [9] E. Gendron, T. Morris, A. Basden, *et al.*, “Final two-stage MOAO on-sky demonstration with CANARY,” in *Adaptive Optics System V, Proc. SPIE* **9909**, pp. id. 99090C1–17, 2016.