

# Quality of Supply and Uncertainty: Risk and Reliability Implications from DERs

Dr Ignacio Hernando-Gil

Associate Professor in Electrical Power Engineering  
ESTIA Institute of Technology (University of Bordeaux)

*[i.hernandogil@estia.fr](mailto:i.hernandogil@estia.fr)*

CIRED Tutorial 3  
20<sup>th</sup> September 2021

1. Network Operation and Planning under Uncertainty
2. Enhanced Fault Level Assessment in Smart Grids
3. Reliability Enhancement under Uncertainty from DERs
4. Optimal Energy Management: Hybrid Micro-Grids
5. Conclusions: Quality of Supply & DERs

## Key Drivers:

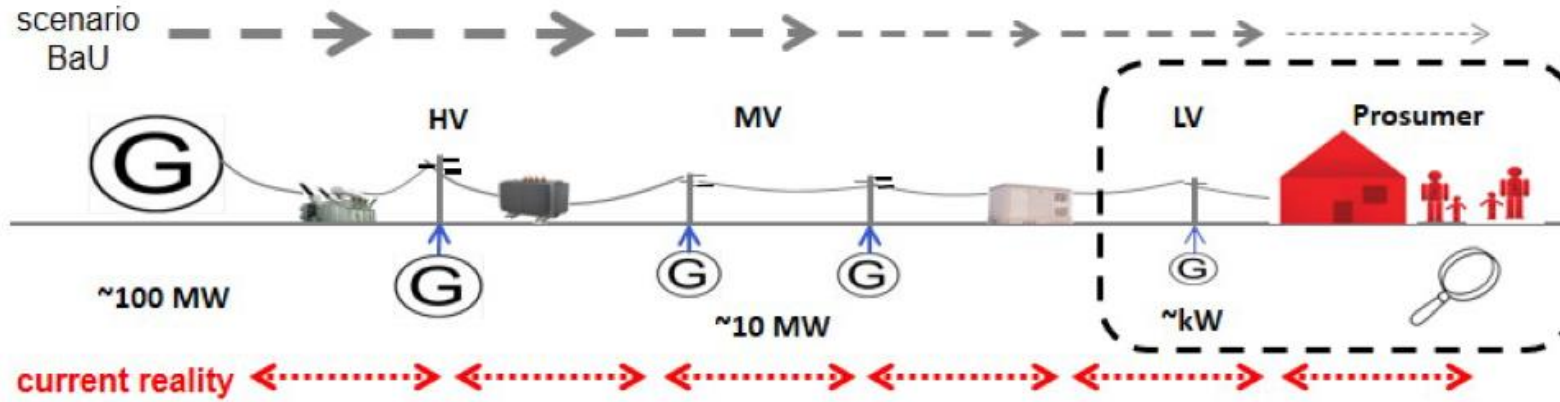

- environmental and regulatory pressure
- market liberalization and overall efficiency
- security of supply + increase quality of service
- "copper" investments postponement
- increasing dispersed renewable generation (DG)
- flexibility (storage, electric vehicle, active demand)

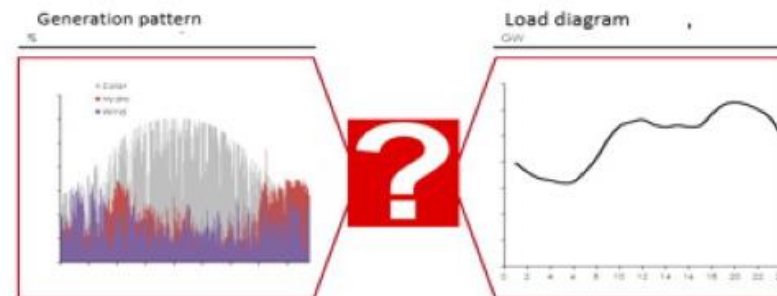
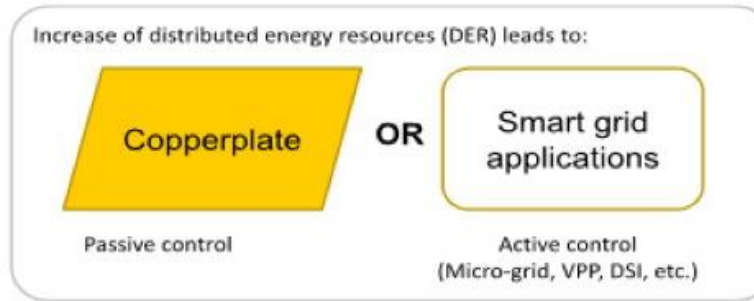

Operations	Planning	Trend
real-time or near real-time decisions	“long-time” decision	shorten planning cycles
alternative scenario (contingency) is always “prepared”	alternative scenario is highly scrutinized	future is “foggy” and it is difficult to realize impacts
operational procedures are fundamental	analyses procedures are also fundamental	new variables to be incorporated
decisions evolve risk	risk highly mitigated	risk incorporation
decisions affect the present	decisions affect mostly the future	systems integration to improve decisions



Planning	is still based on:	... but has to:
Demand forecast	macroeconomic and historical models	forecast for load and DG production(*)
Load data forecast	customer usage and territorial planning	incorporate information on DER development
Planning alternatives (scenarios)	compliance with standards based on traditional supply side options	considerate active network solutions and integrate risk variable
Approach	deterministic models	switch to probabilistic

(\*) extreme scenarios considered



...motivated by different factors (**Objective Functions**)

Minimum cost (*building, maintenance, losses*)



Load density (*urban, semi-urban, rural areas*)



Environmental constraints (*lakes, forest, historical buildings*)



Continuity of supply (*penalties/rewards from regulators, network automation*)

**CIGRE WG C6.19**  
*Survey on methods and tools for planning of ADN*

“Today, while of interest to many utilities, ADN concept fails to be taken seriously by utilities as viable alternatives in the planning process.”

Main reasons:



- 1) lack of planning tools,
- 2) lack of ad hoc business cases.

## MV Overhead Distribution Network (sub-urban and rural areas)

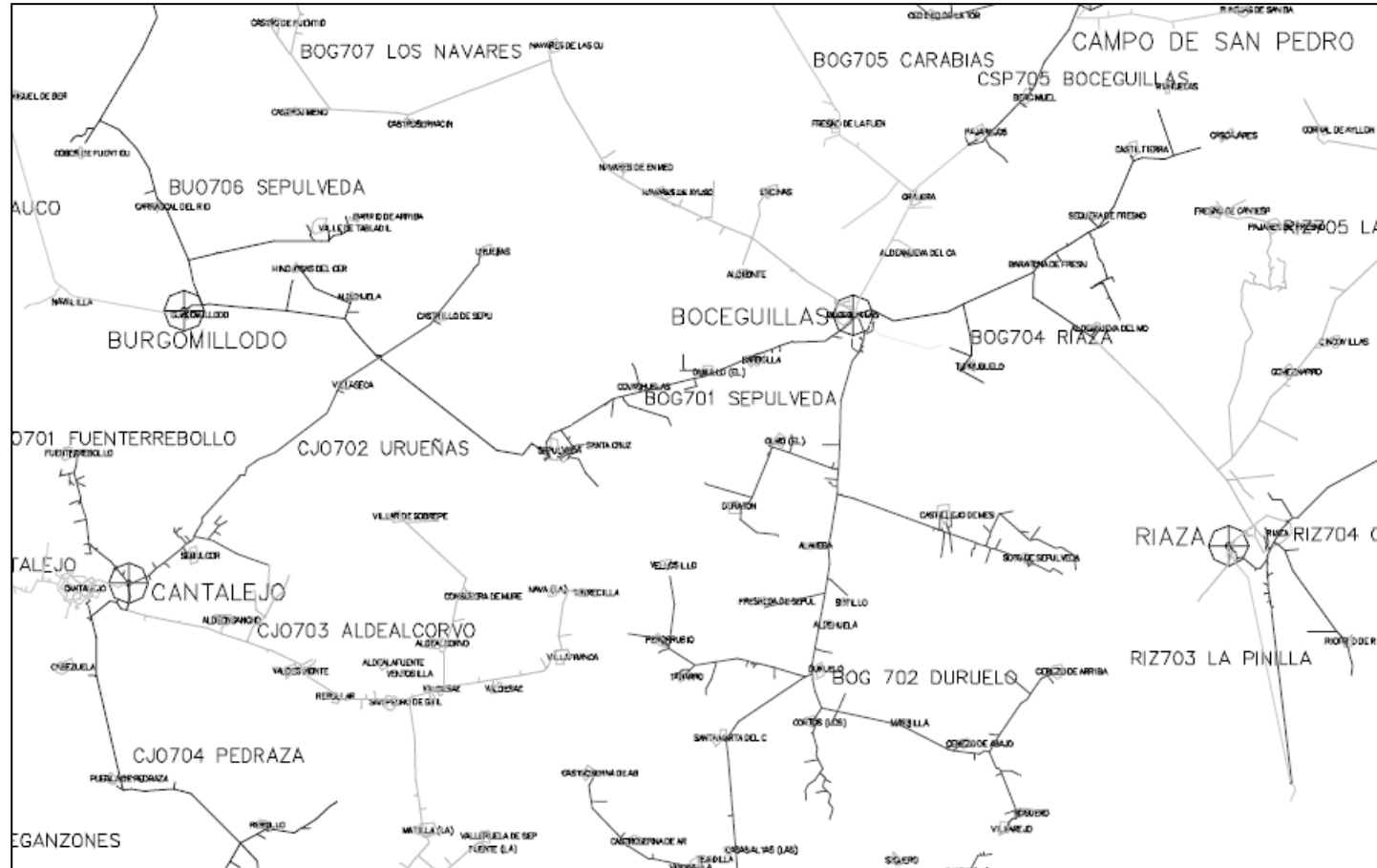

## MV Underground Distribution Network (metropolitan and urban areas)

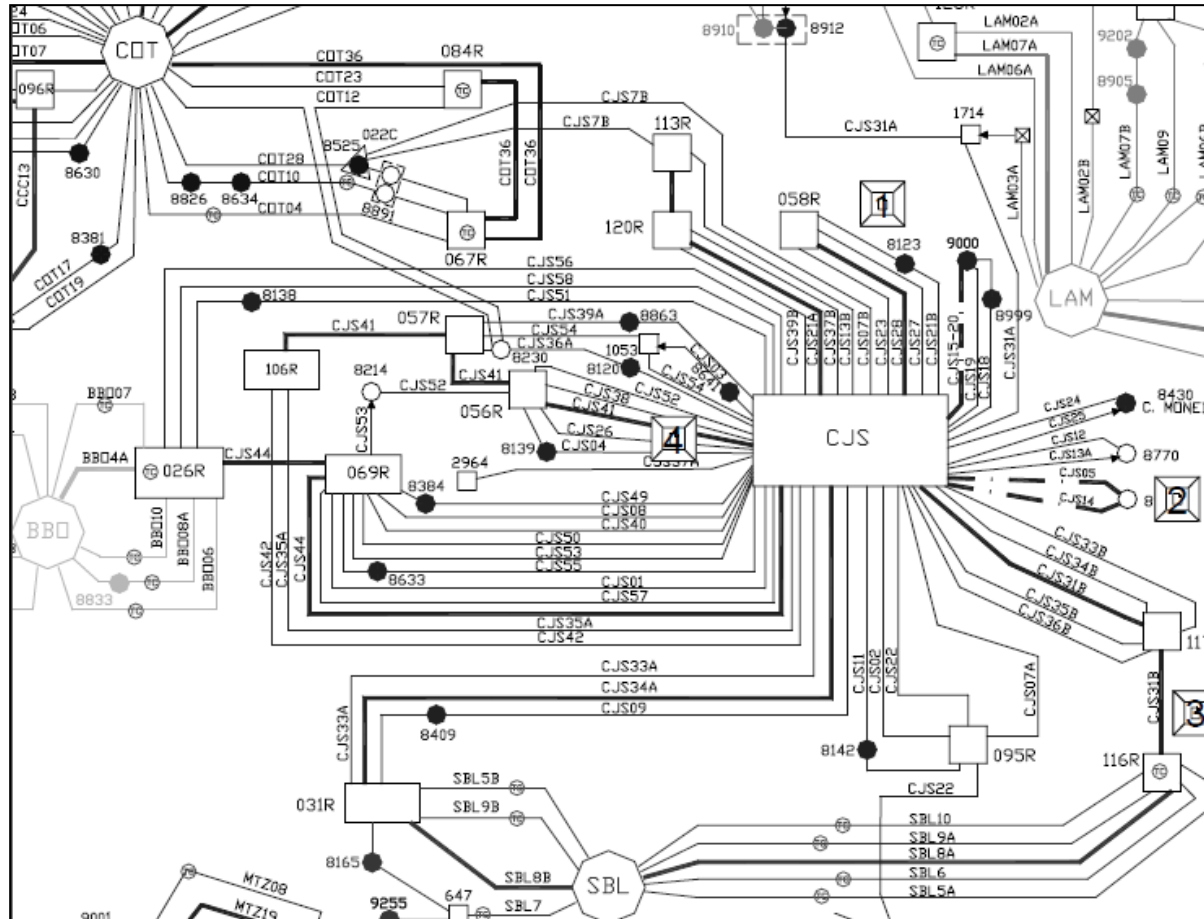

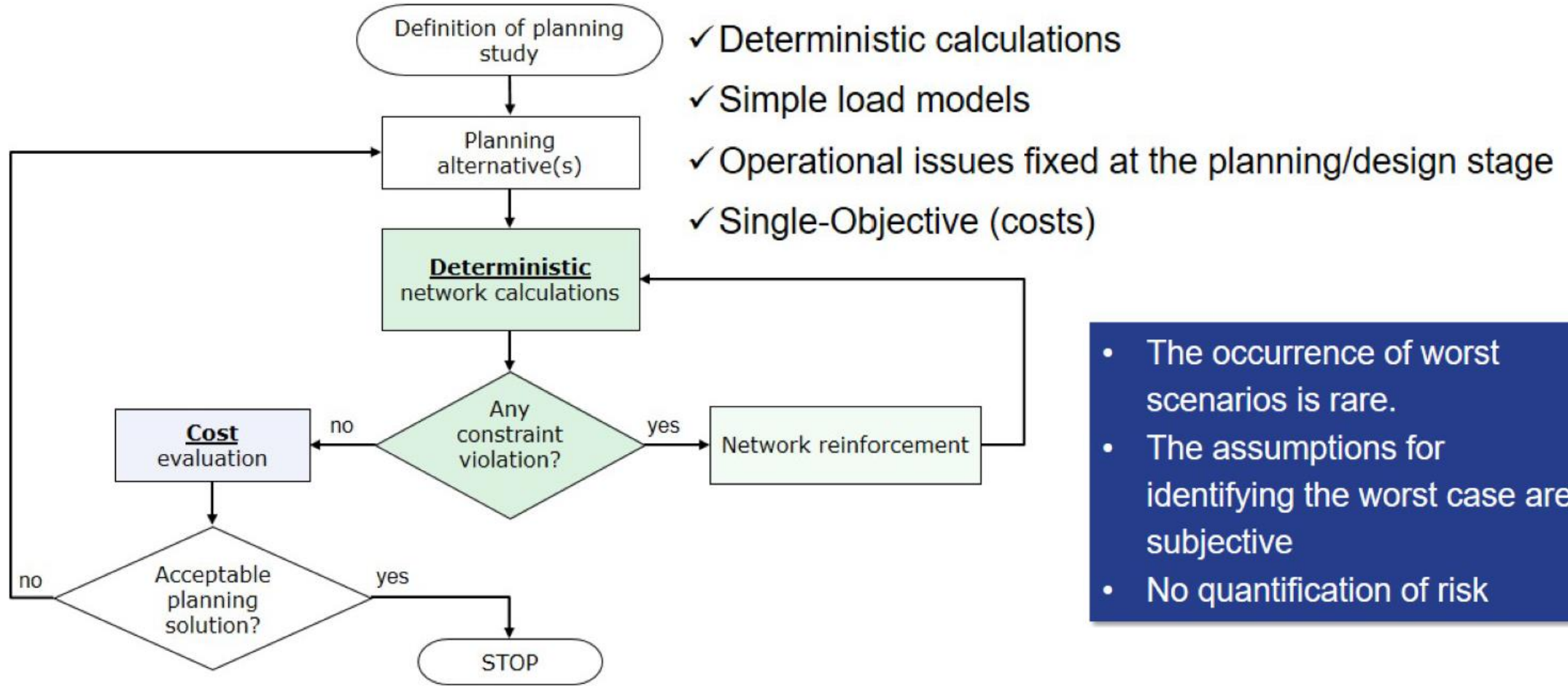

- The occurrence of worst scenarios is rare.
- The assumptions for identifying the worst case are subjective
- No quantification of risk



- Electricity produced by Renewable Energy Sources
- Electricity increasingly produced by or closer to consumers/load centers
- Electrification of transport (plug-in EV);
- New markets
- Information and communication technologies
- Advanced metering infrastructure
- Energy Storage (electrical, mechanical, chemical, thermal, etc.)

Increase of distributed energy resources (DER) leads to:



Passive control

OR

Smart grid applications

Active control  
(Micro-grid, VPP, DSI, etc.)

**LESS** traditional network investments

**MORE** cost-effective **Active Distribution Network (ADN)** solutions

Technical Issue	BAU Distribution Network	Active Distribution Network
Voltage rise/drop	Limits/bands for demand and generation connection/operation Generation tripping Capacitor banks	Coordinated volt-var control Static var compensators Coordinated dispatch of DER On-line reconfiguration
Hosting Capacity	Network reinforcement (e.g. lines, transformers)	Coordinated dispatch of DER On-line reconfiguration
Reactive Power Support	Dependency on transmission network Capacitor banks Limits/bands for demand and generation connection/operation	Coordinated volt-var control Static var compensators Coordinated reactive power dispatch of DER
Protection	Adjustment of protection settings New protection elements Limits for generation connection Fault ride through specifications for generation	On-line reconfiguration Dynamic protection settings

- ✧ Enhanced load and generation representation
  - ✧ Load/generation profiles
  - ✧ Time series
- ✧ Detailed description of Smart Grid
  - ✧ Distribution State Estimation Measurement System
  - ✧ Information and Communication Technology
- ✧ Multi-objective, probabilistic, risk-oriented planning
- ✧ Operation actions are planning options



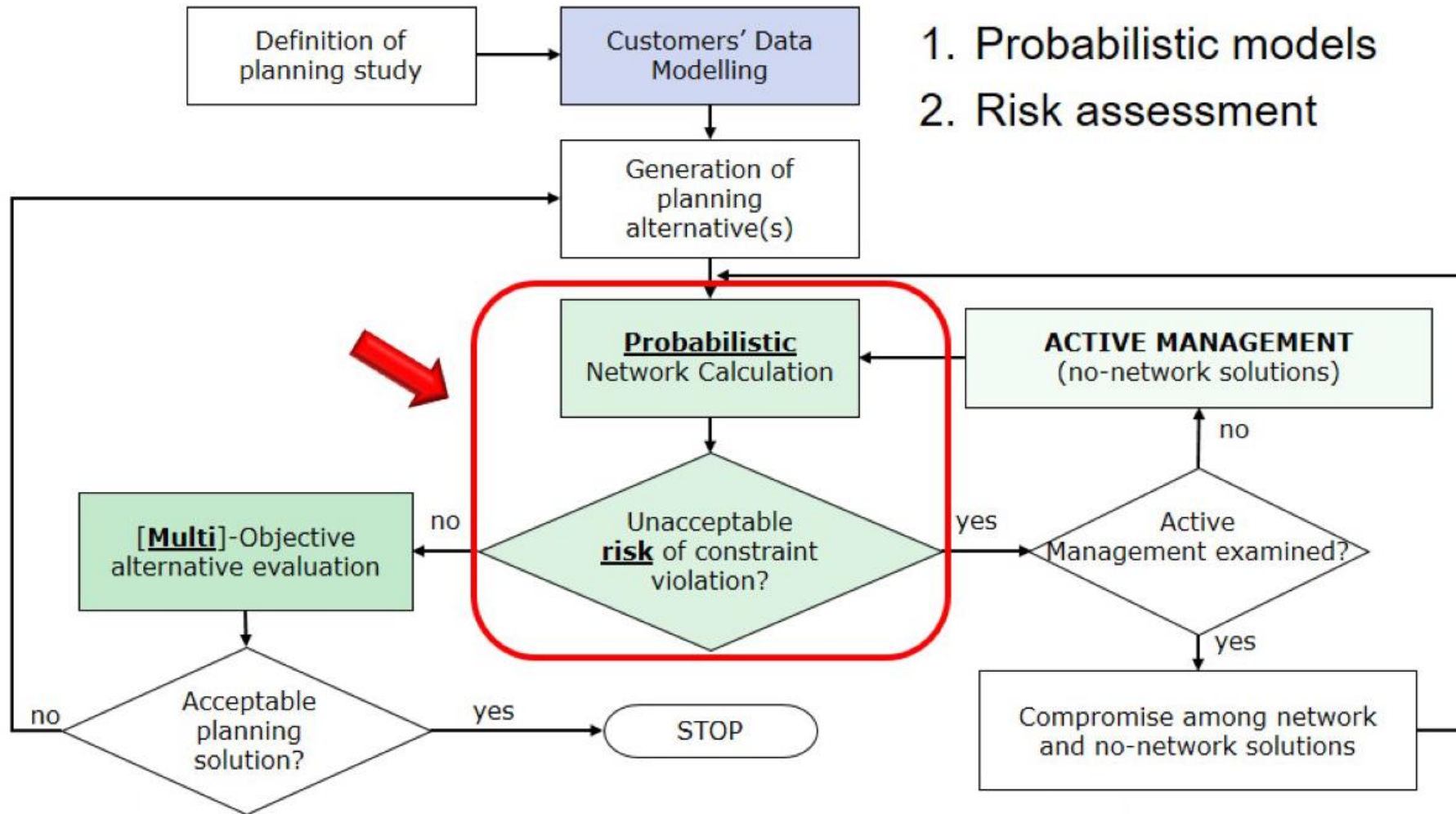

1. Probabilistic models
2. Risk assessment

Main Issue: data availability for probabilistic models definition.

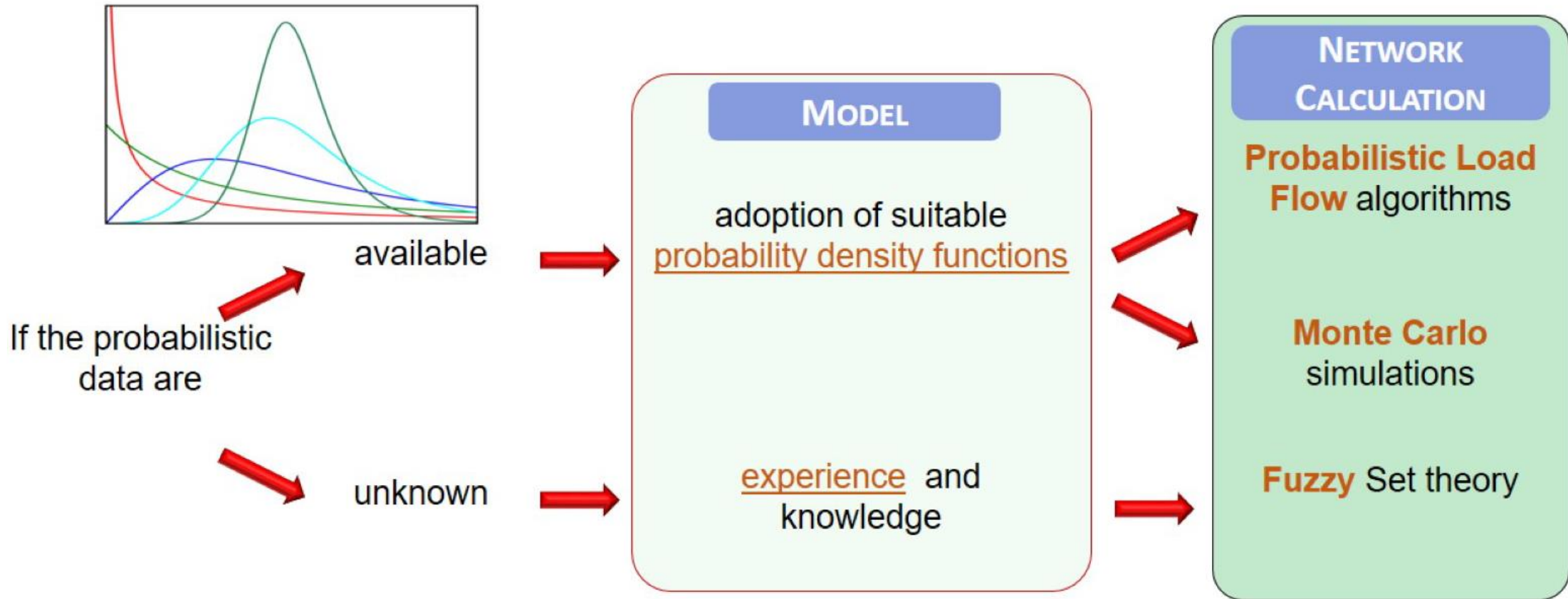



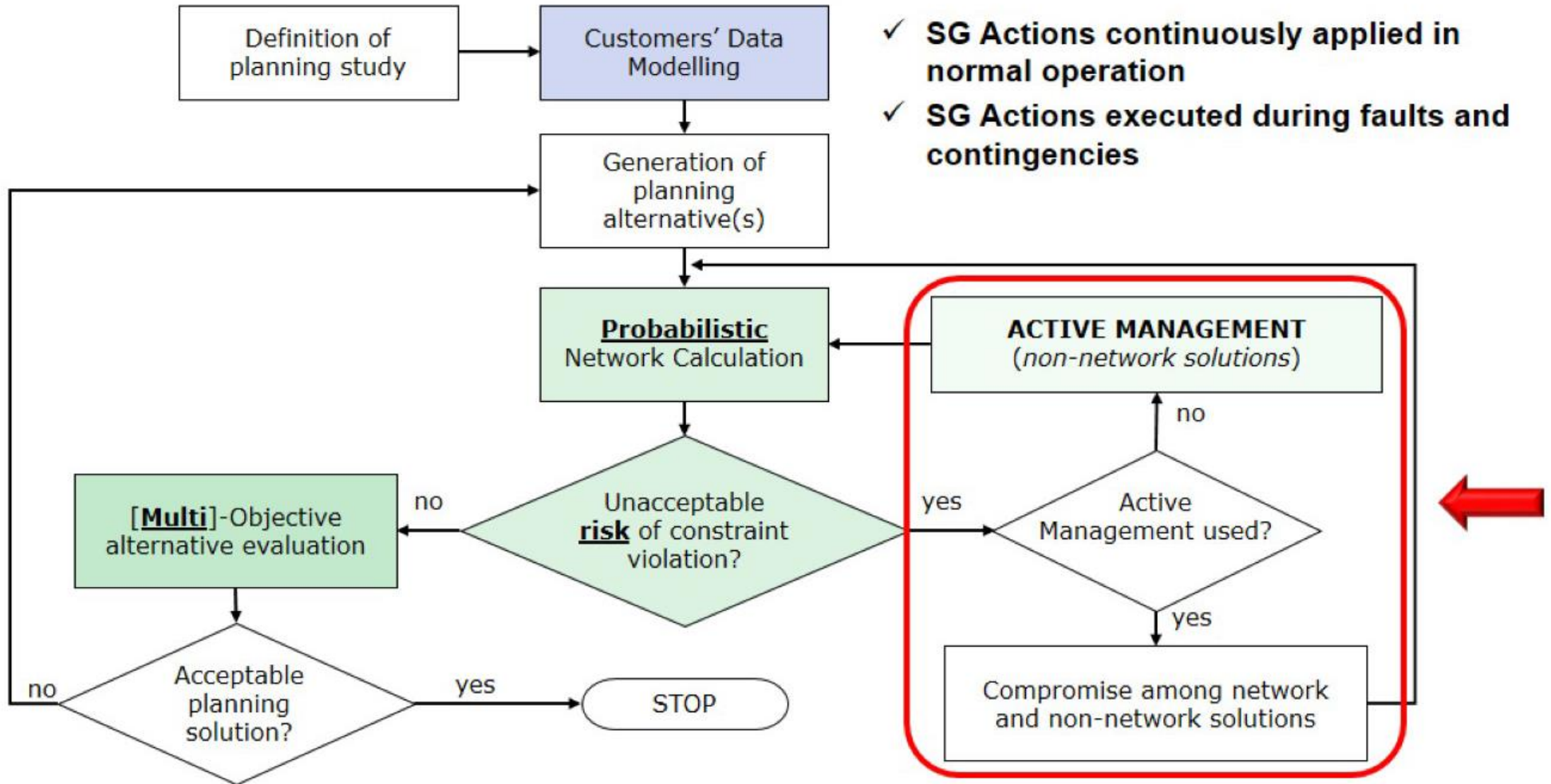

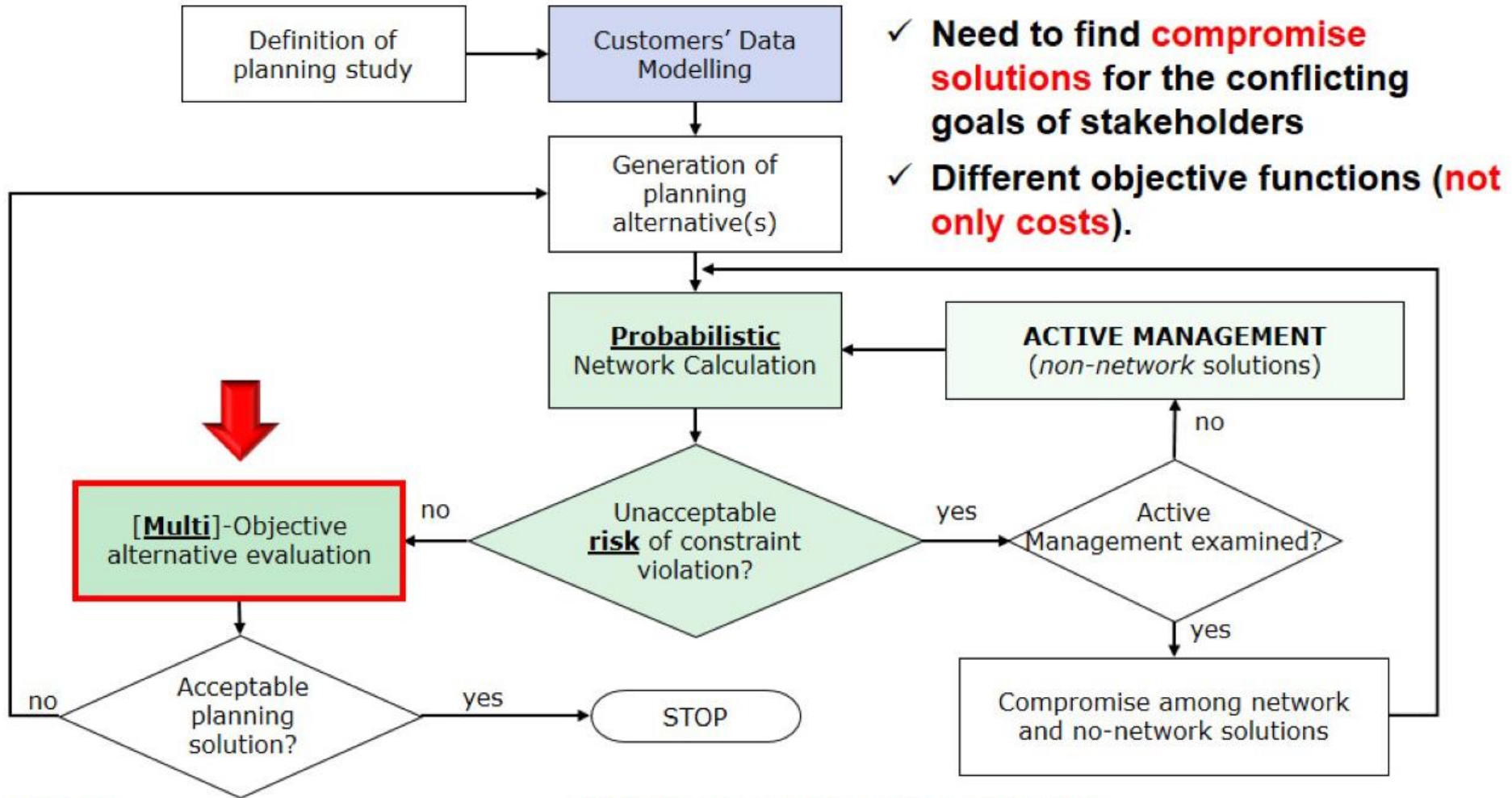

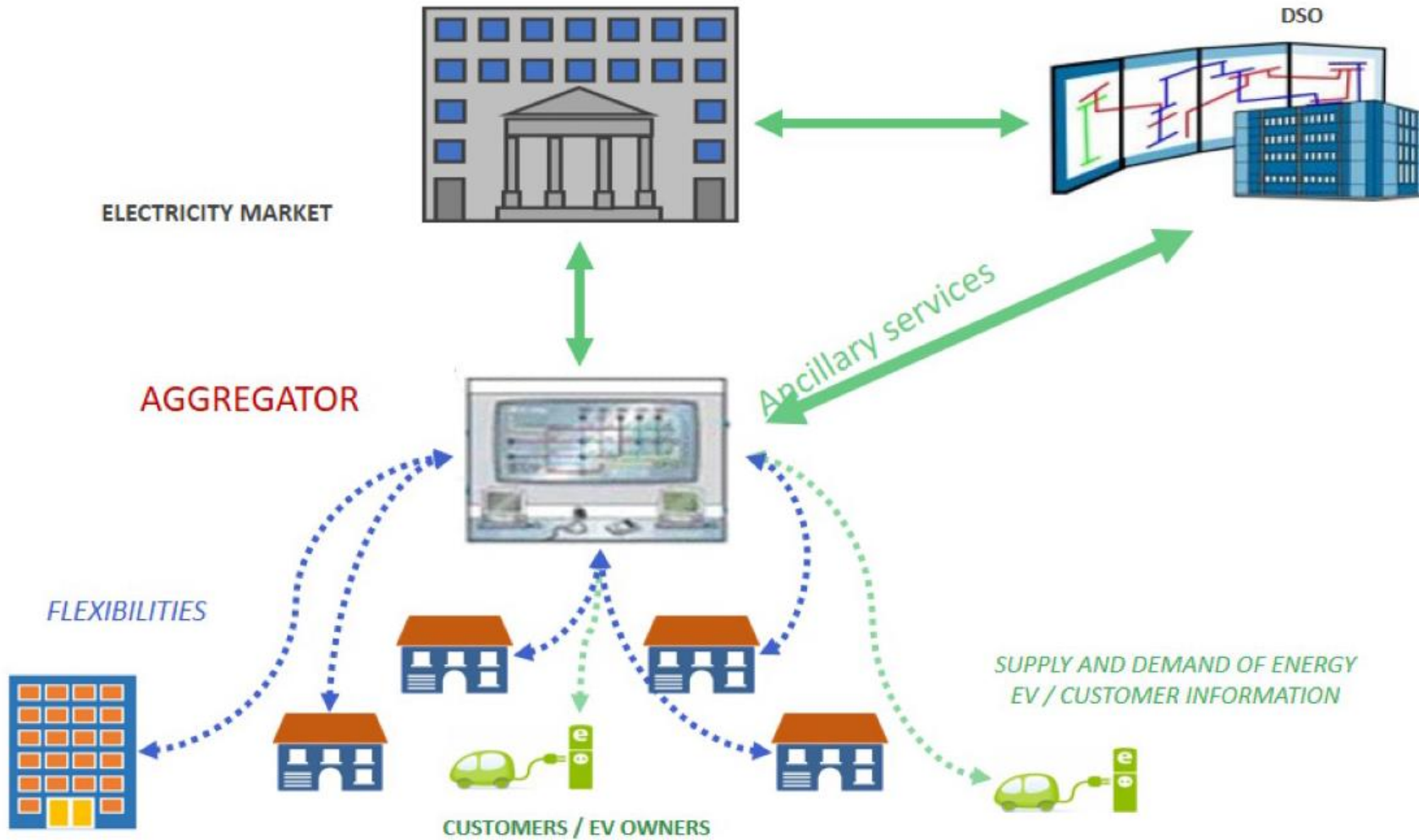

- Generic MV/LV distribution network models
- Residential customer groups

Rural (RU)

Urban (U)

Suburban (SU)

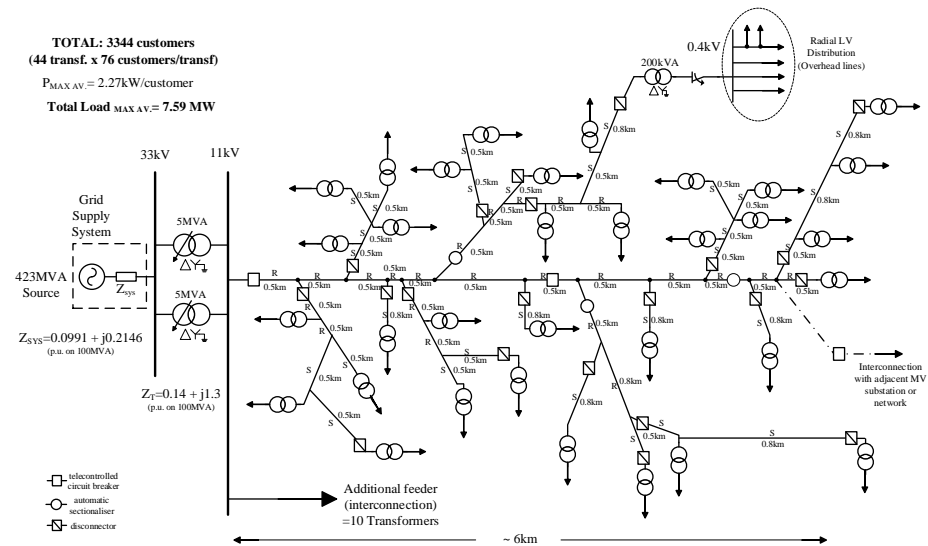
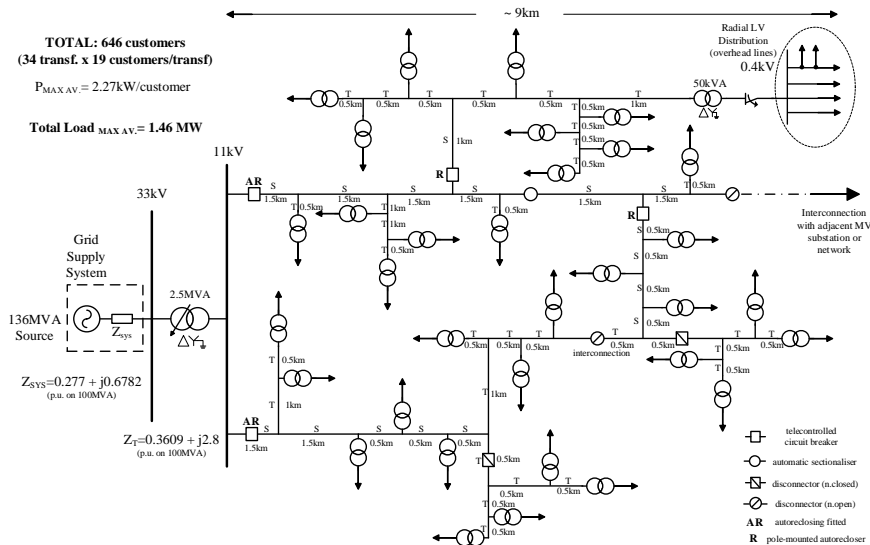
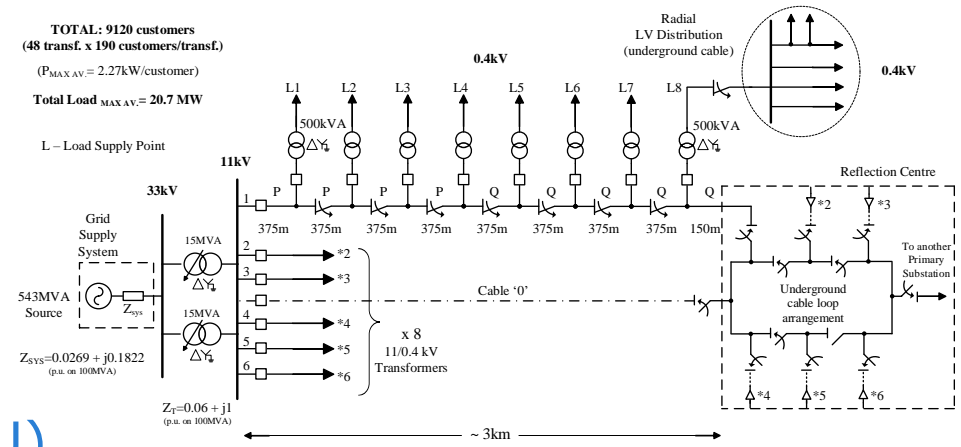



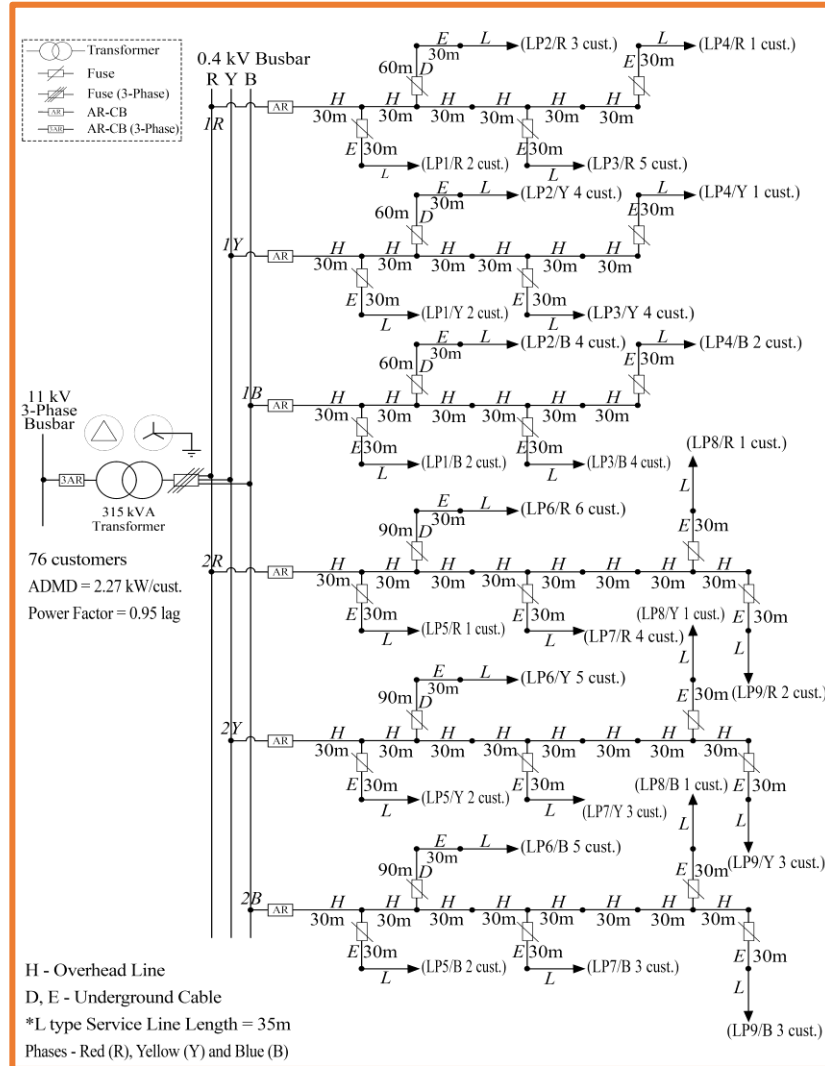
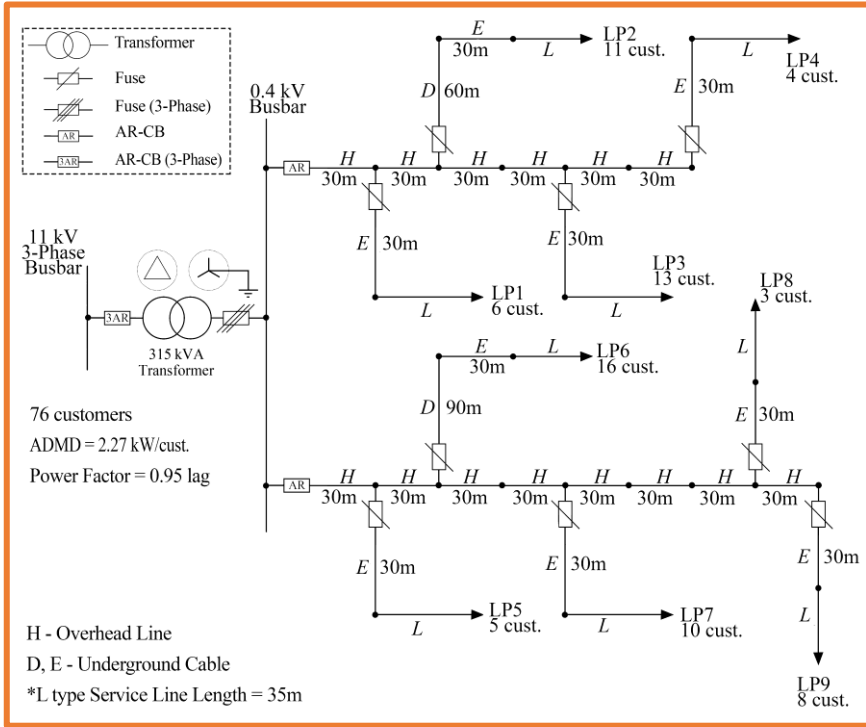

Three-phase model (TPM) of an **'unbalanced'** (& realistic) generic suburban LV network

Single-line model (SLM) of a **'balanced'** generic suburban LV network

## Formulation of Reliability Equivalents of LV Networks by State Enumeration and Monte Carlo Simulation Techniques

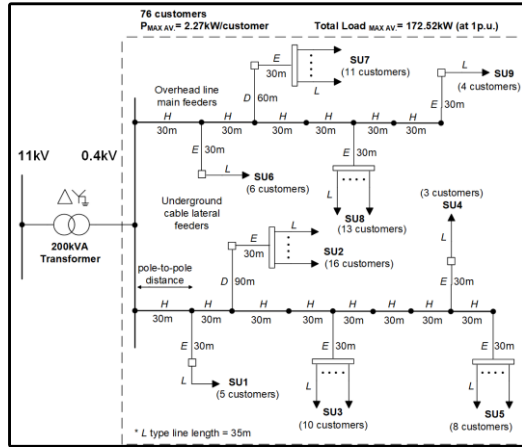

SE+MCS

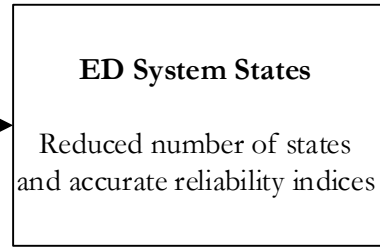

Equivalenting

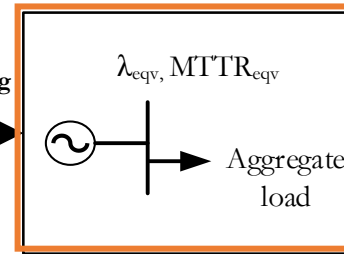

TPM Single Equivalent Component Parameters

Eqv-PC	$\lambda_{eqv}$ (failures/year)	$MTTR_{eqv}$ (hours)	Computational Time Saving (%)
TPM	1.555	0.588	99.98%

- Detailed LV model
- Time-consuming MCS

- Minimum error
- Faster MCS

- Equivalent PC
- Same unavailability

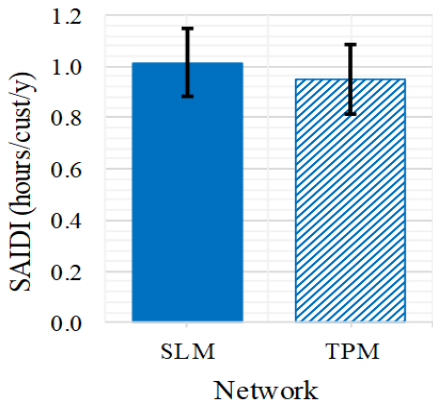

(a) SAIDI

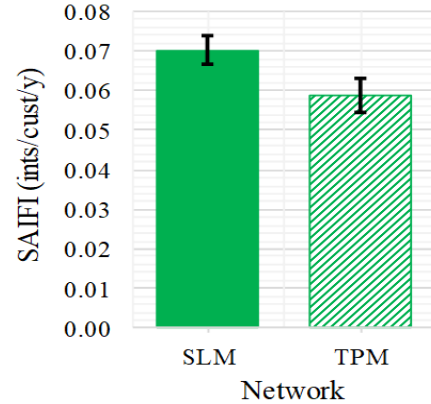

(b) SAIFI

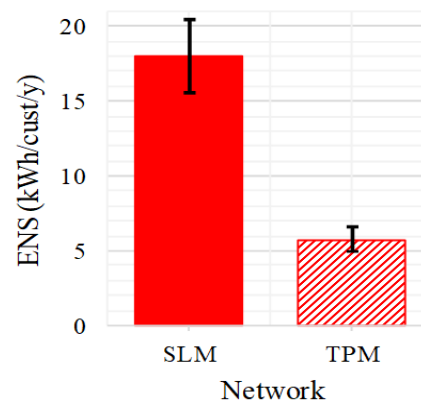

(c) ENS

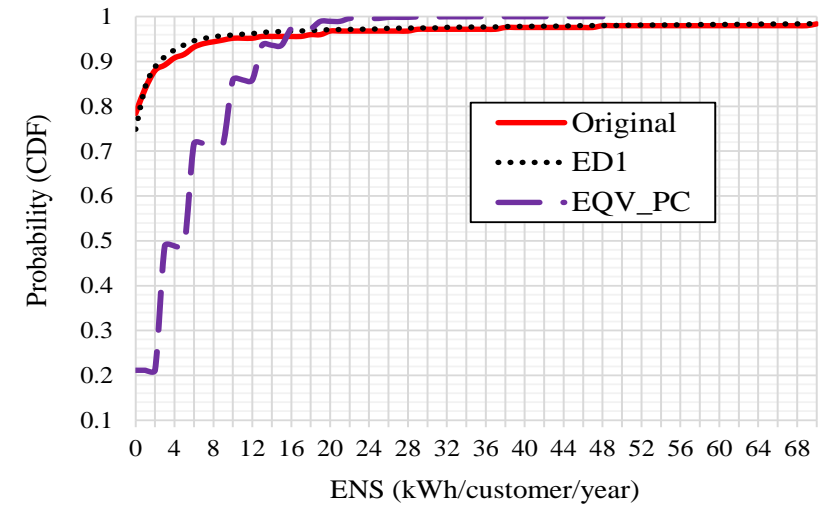

- How is it going to (likely to) change?

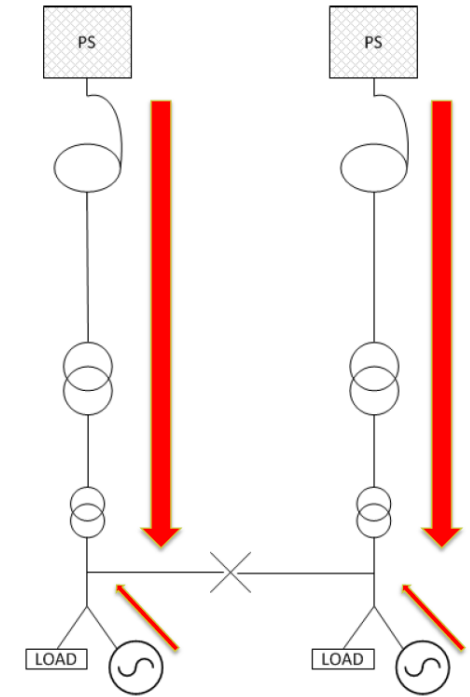
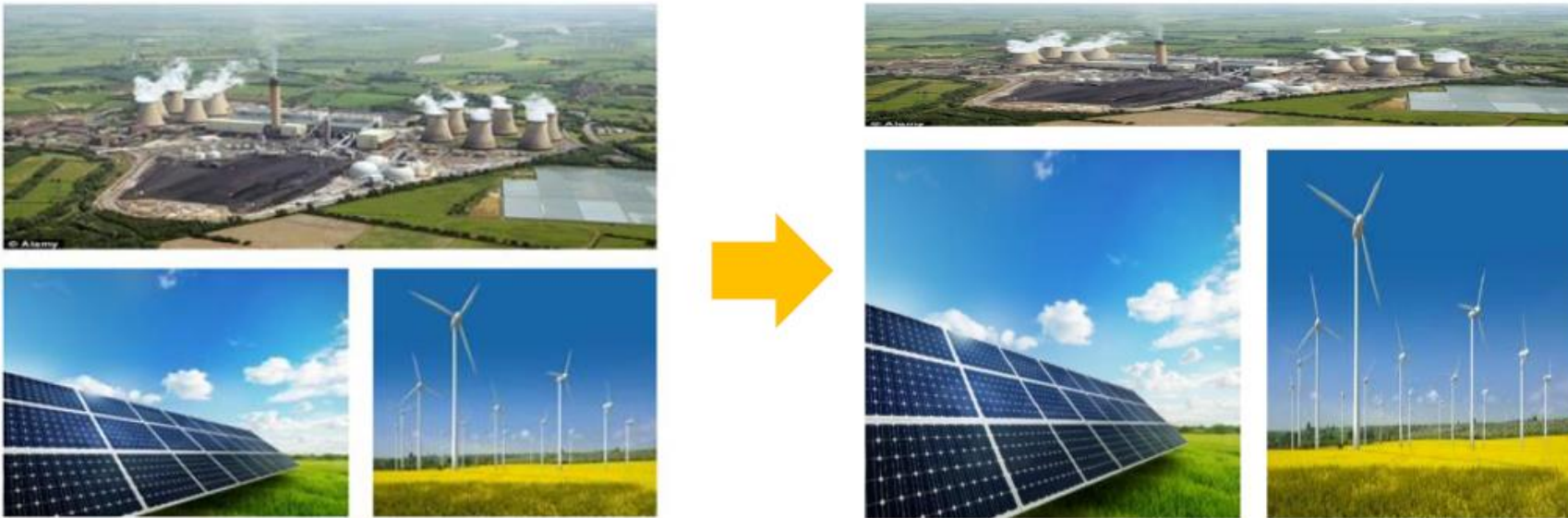

G59 & P28 EMC Compliance (QoS, PQ, V, flicker...)



DER Hosting capacity!

$$2I = \frac{V}{Z}$$

- How is it going to (likely to) change?

## National Grid's projection of fault level reduction from 2015 to 2025

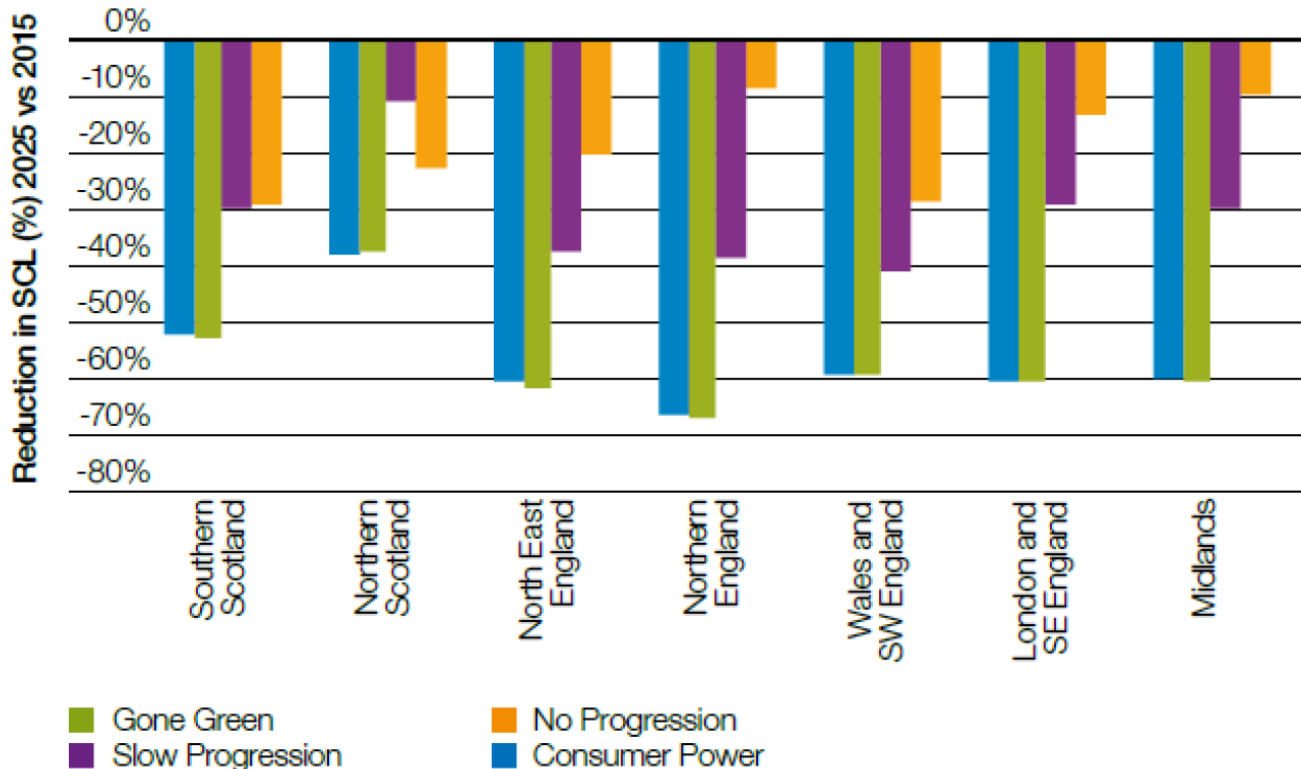

Average Combined Heat and Power Fault Level Infeed – **4.5MVA/MVA**

Average Inverter Fed Generator Infeed – **1.2MVA/MVA**

Even if the Power Station was equivalent to a CHP unit a 2000MW station would have an infeed value of **9000MVA**

If all that power was generated by inverter fed distributed generation the fault level infeed would be reduced by **6600MVA** to **2400MVA**



## SYSTEM FAULT LEVELS:

- Indicators of Network Strength (regardless Voltage level)
- MVA values for network planning

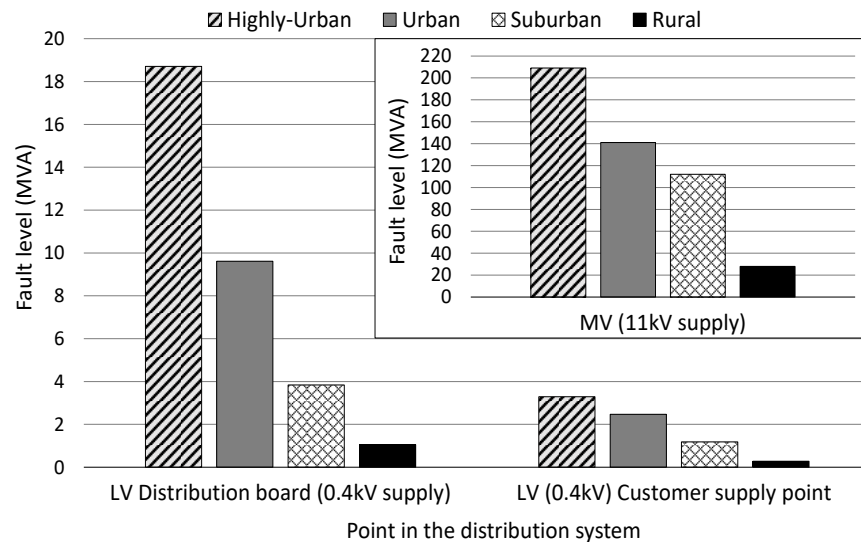

MV (11kV) and LV (0.4kV) system fault levels at different points/locations

UK RESIDENTIAL CONSUMERS' COMPLEX SUPPLY IMPEDANCE FOR 1-PH CONNECTIONS AT 50 HZ [15]

Country	Percentage of consumers with supply impedances equal to or less than the listed complex values	
	98%	90%
United Kingdom	$0.46 + j0.45 \Omega$	$0.25 + j0.23 \Omega$

## IEC TR 60725:2012

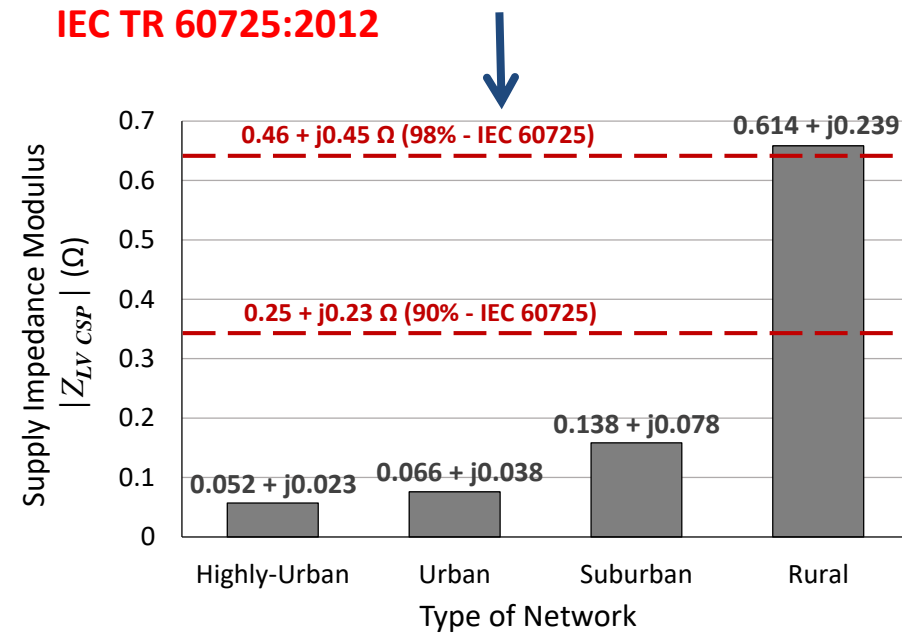

Disaggregation of supply impedance maximum values for UK-generic distribution networks

## → Objectives:

- 'General framework' flexibly adapted to different network characteristics
- Assess gradient of **fault level variations** according to diverse feeder structures
- Dependency of short-circuit levels to **electricity demand & DG Connection: Demand & DG (time)-varying fault level monitoring.**
- Wider range of  $Z_{SYS}$  benchmark values than those in **IEC 60725**

## → Potential Applications for Industry:

- Information on hosting capacity: Connect / Disconnect Generation
- Inform requirements for Network Reconfiguration
- Understand requirements/purpose of Dynamic Protection Settings
- Combined with application of novel 'Superconducting' Fault Current Limiters
- Facilitate the use of Synthetic Inertia



$$\nabla_x f(z) = \frac{\partial f(z)}{\partial z} \cdot \frac{\partial z}{\partial x_1} e_1 + \dots + \frac{\partial f(z)}{\partial z} \cdot \frac{\partial z}{\partial x_n} e_n$$

Sensitivity Analysis

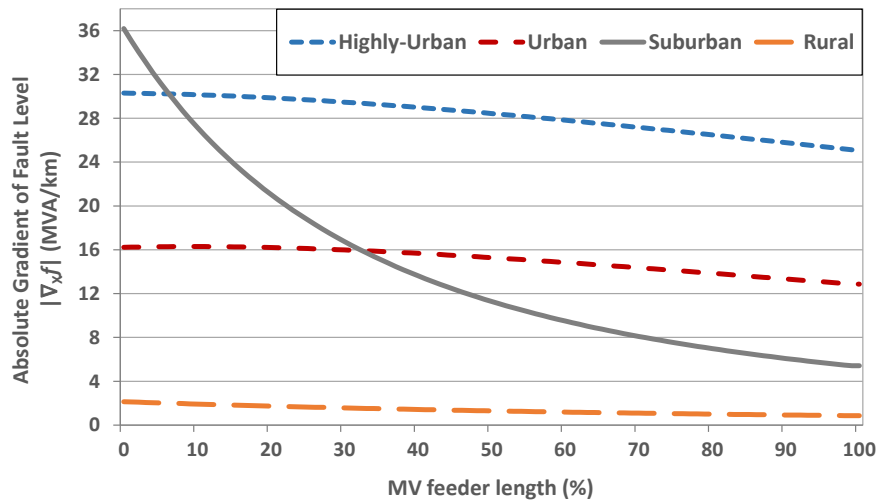
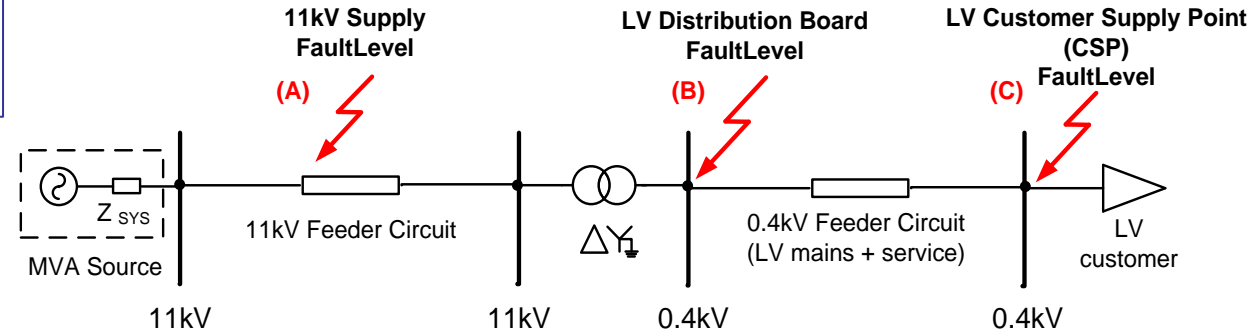

Impact of MV feeder length on fault levels at MV supply: network point (A)

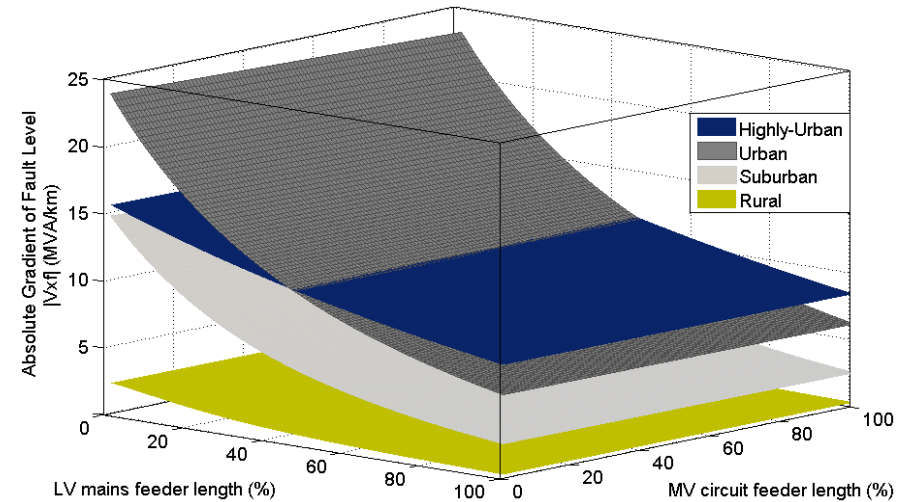

Fault level gradients at LV CSP: network point (C), in relation to two variant feeder lengths (LV mains and MV circuit)

**Demand influence on Fault Level** depends on network supply locations and effect of OLTC regulation:

- Point A: before OLTC regulating transformer (33KV)
- Point B: after OLTC regulating transformer (11KV)
- Point C: primary of 11/0.4 kV distribution transformer (before LV distribution board)
- Point D: at LV customer supply point (0.4KV)

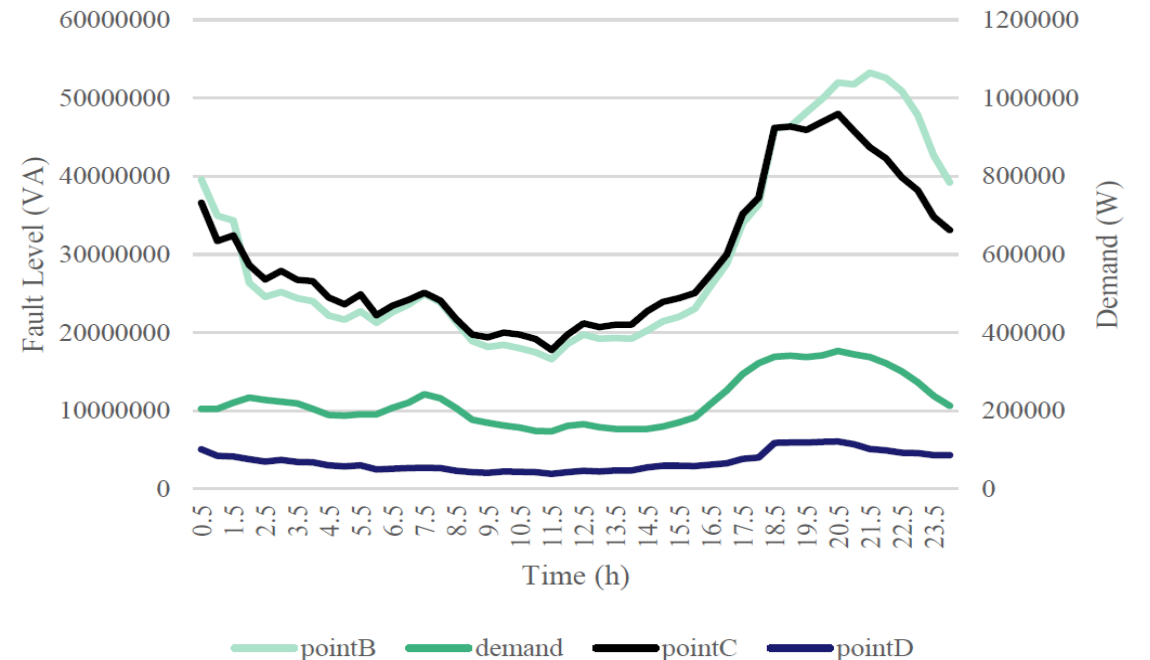
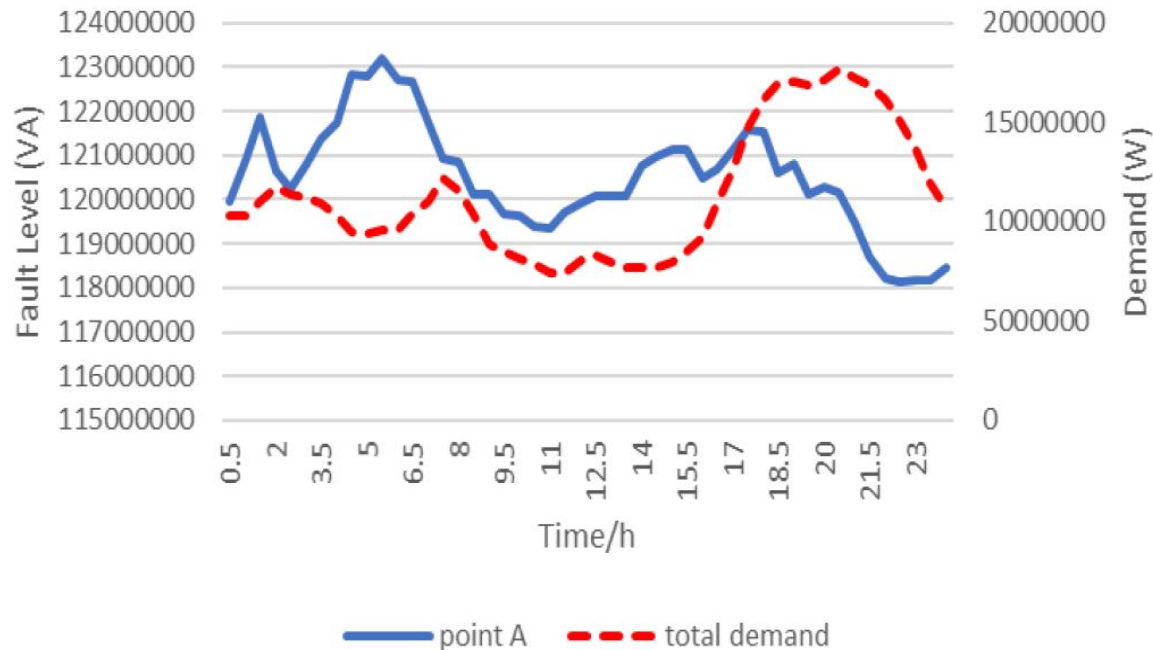



## Fault Case

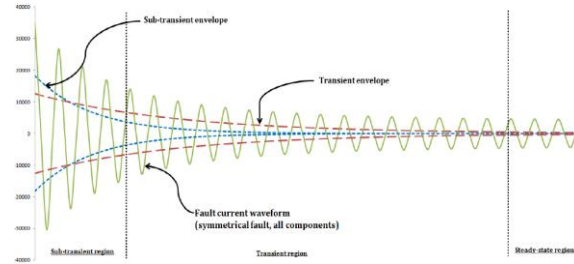

### Balanced three-phase fault

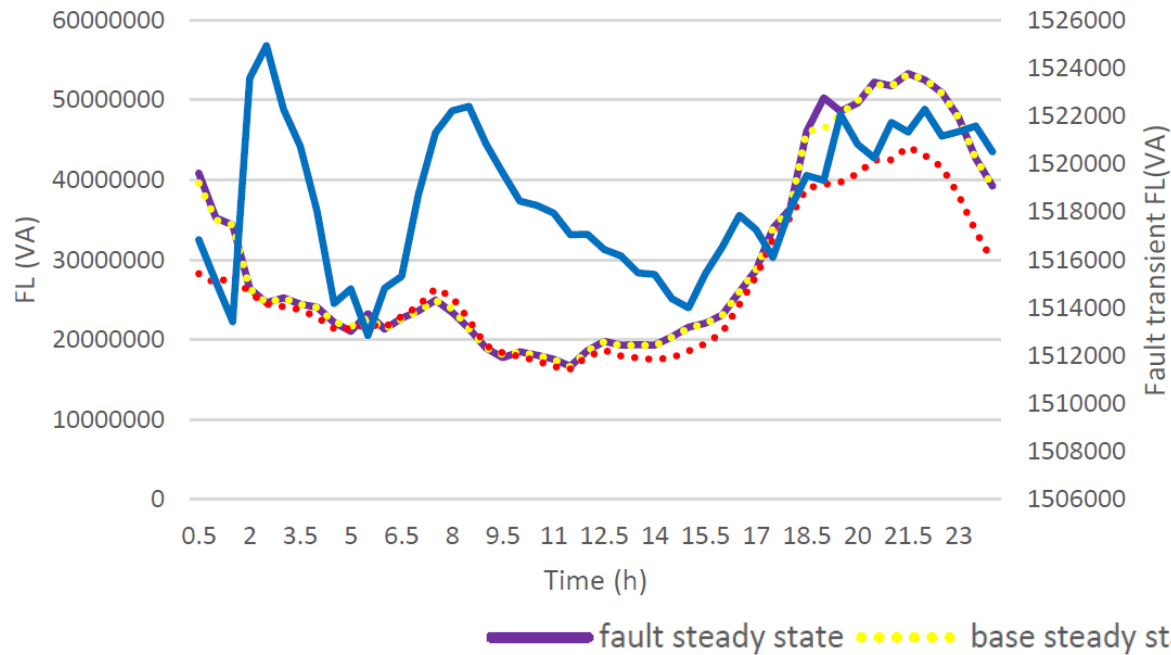

### Unbalanced phase-to-ground fault

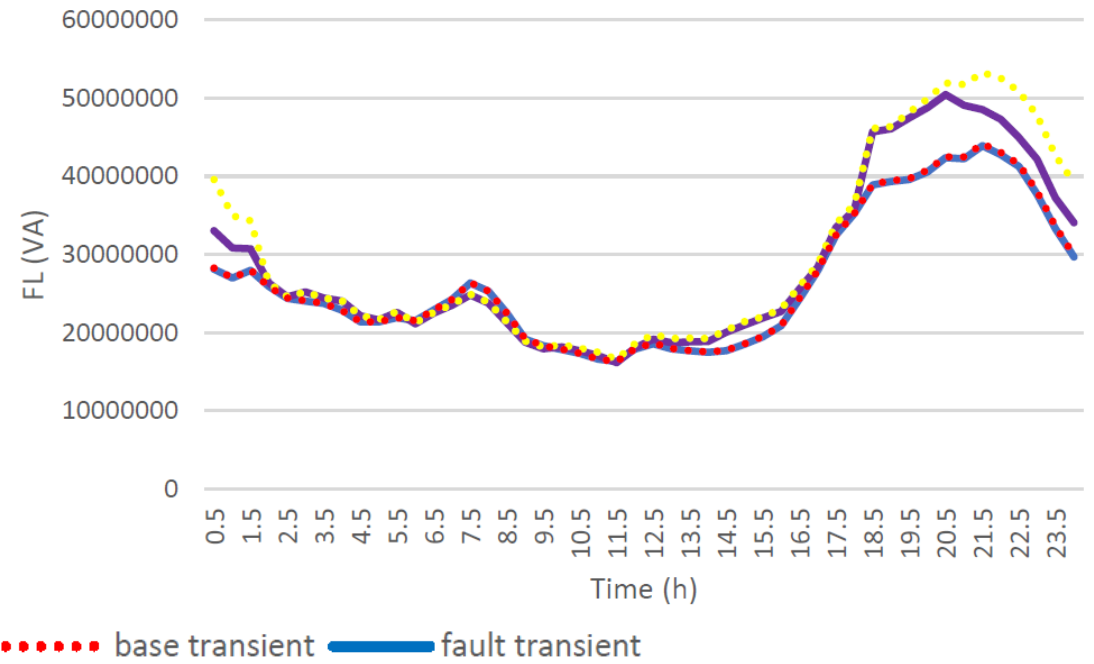

The more phases related to fault, the more influence the fault has on the Short-circuit Level.

**DG Case**



+



**Micro-DG Connection**

Steady-state Fault Level after OLTC (11kV)

Steady-state Fault Level at LV Transformer (0,4kV)

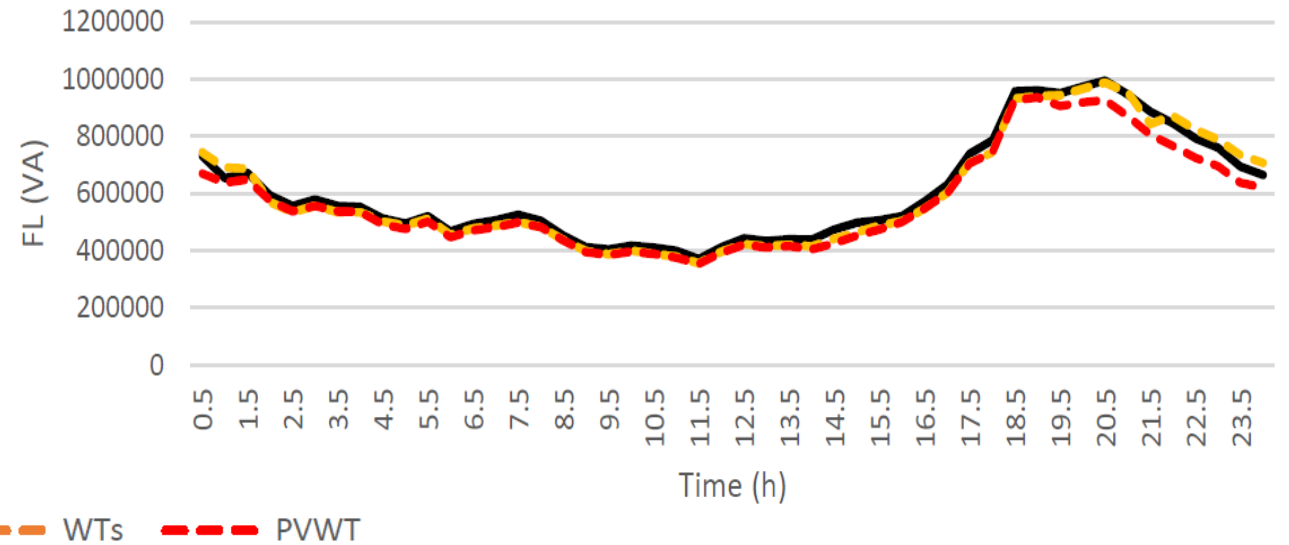
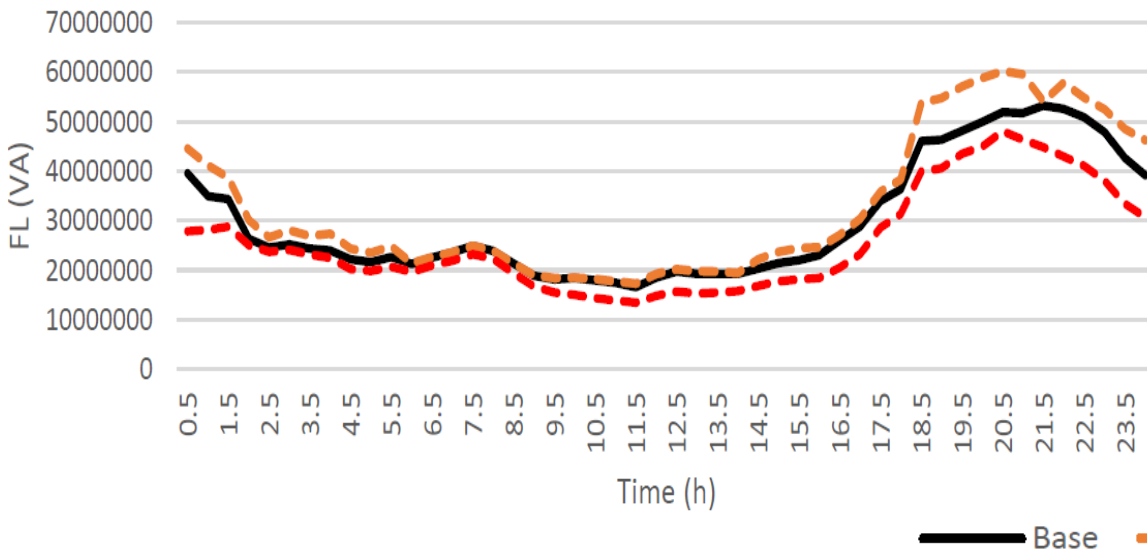

Fault Level reduces after connecting Micro-DG, especially during peak demand period (6.5pm-0.5am). Combined PV and WTs offers a better solution to Fault Level than WTs only.

*Def.:* Ability of a component/system to operate without interruptions



- **The Availability Challenge:**

- The majority of system assets were installed around 1980, with a design life of 40 years!

- Increased capability: enhanced ratings above nameplate!

- **Environmental Challenge:**

- **Question of analysis:**



How does the energy industry manage its impact on the environment?



How does the energy industry manage the effects of environment on it?



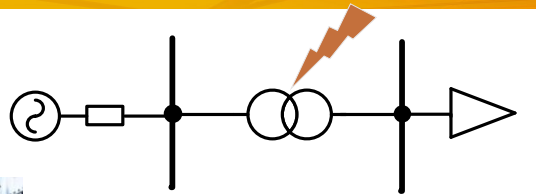

**Permanent fault in Distribution network**



- Faulted component will be disconnected by protection system
- DNO will try to reconfigure the network to maintain supply to all customers

**Design limitations?  
(n-1 criterion)**

Consequences



Load shedding

Residential customers



Long Interruptions

- Residential demand is responsible for around **~30% of consumption**. Residential customers are highly dispersed within LV networks
- DNOs can neither trace nor control individual demands
- **Hybrid Micro-Grid** systems, in coordination with **E. Storage** and **DSM**, will maximise the number of customers with a continuous supply.



- **Energy not supplied is due to: (most frequently)**
  - Faults on distribution system  $\longrightarrow$  Lose small amounts of load
  - MV/LV networks have a dominant impact on the quality of service seen by the end customers:

$\sim 90\%$  CI and  $\sim 97\%$  CML between  $0.4\text{kV} - 20\text{kV}$

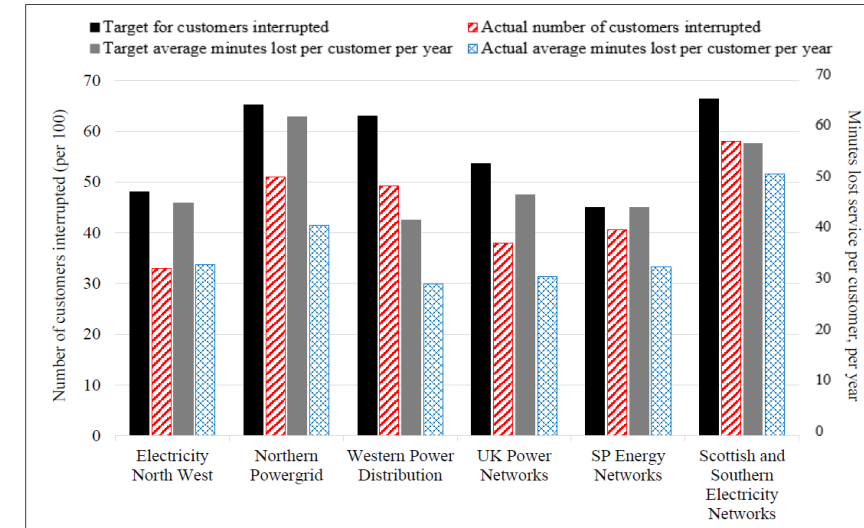

CI & CML (UK, 2016-17)

- **Customer Priorities in a Climate of Rising Energy Prices:**
  - **System-oriented** evaluation masks poor reliability performance.
  - **Accurate** reliability evaluation raises customer **“Willingness To Pay”**.
  - Different **customer perceptions of DNO services’ value**. The most rated are:
    - Rapid supply restoration.
    - Quicker detection of supply loss.
    - Carbon reduction initiatives.

## Probabilistic Impact/Risk Analysis

- Modification of conventional Monte Carlo Simulation → Uncertainty
- Network Planning and Management → Optimal:
  - Network Reconfiguration
  - Fault Restoration
- Accurate Network-Reliability Equivalents
- Tailored Demand Response and Renewable Energy Storage Strategies
- Statistical Modelling of System/Load Indices → Quality of Supply Legislation

## Prediction of Network Stochastic Behaviour

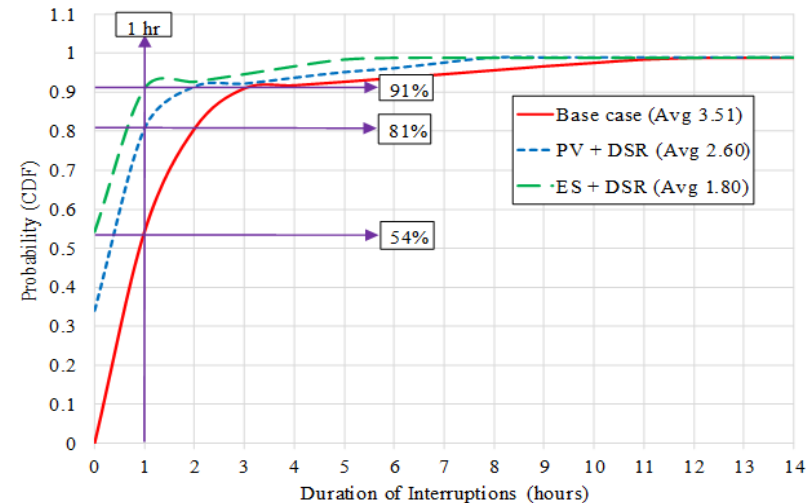
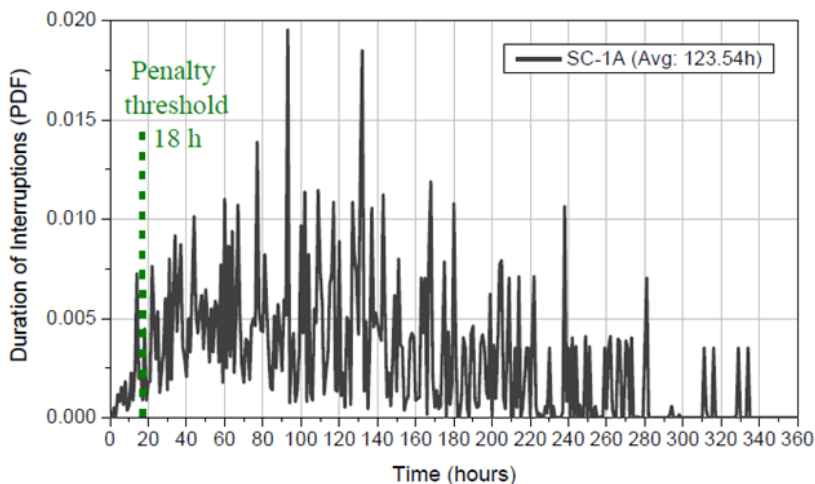

## Data Analytics for renewable generation and weather data:

- **Seasonal Prediction Model of PV output (vs irradiation) (vs wind) (vs temperature)**

### Summer



### Winter



Risk of Customer Supply Interrupt.

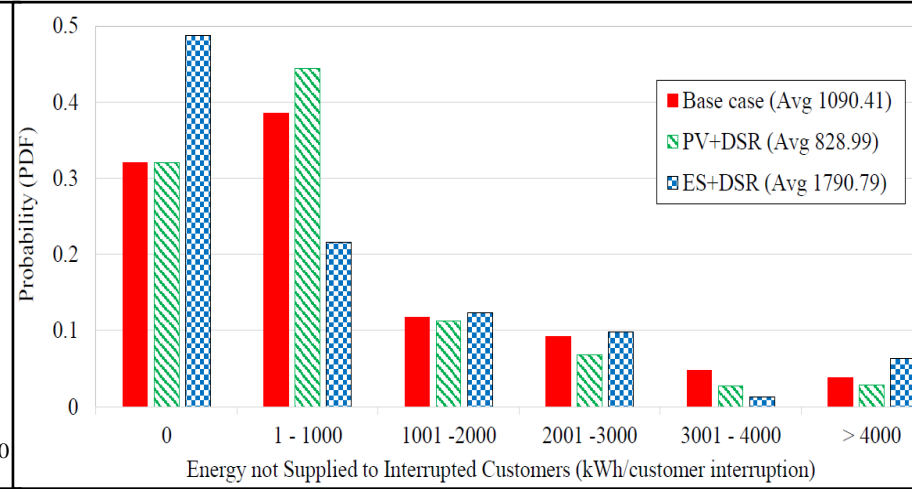
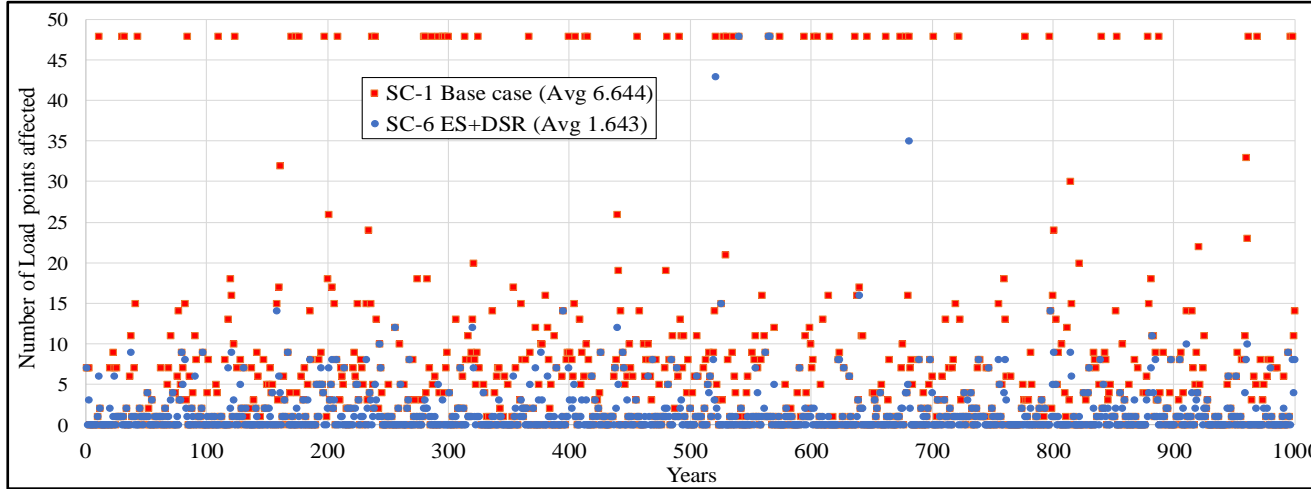

Quantification of Smart Interventions on Energy Not Supplied

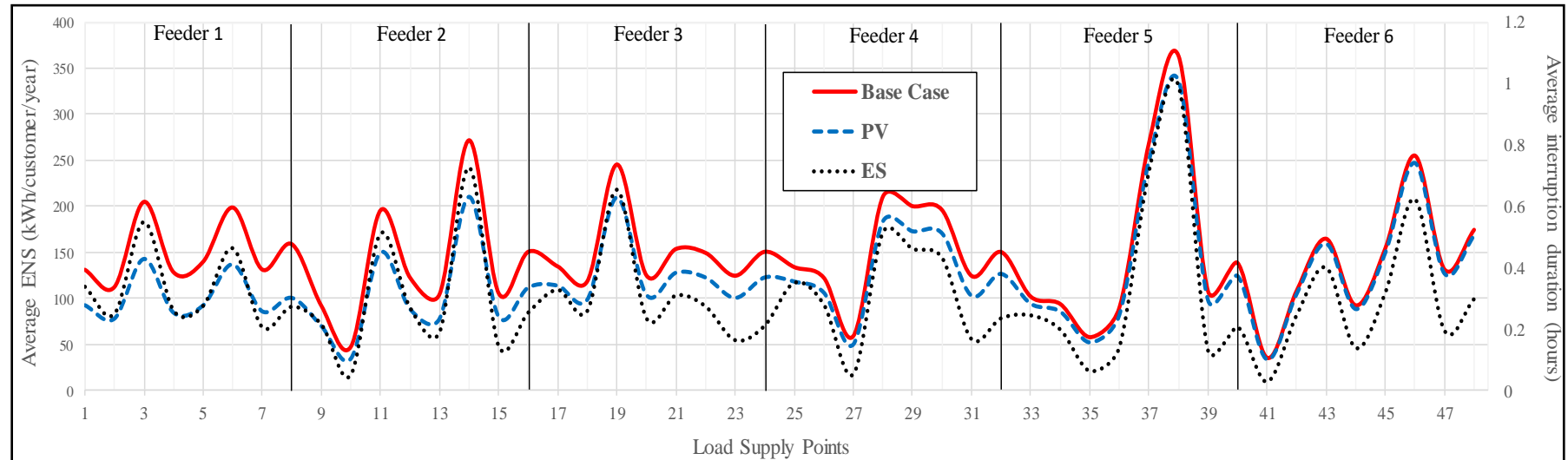



## Urban networks

- Metropolitan areas
- Underground arrangement
- Meshed operation radially,
- High loading conditions and load density

## Average ENS: Urban MV/LV distribution network

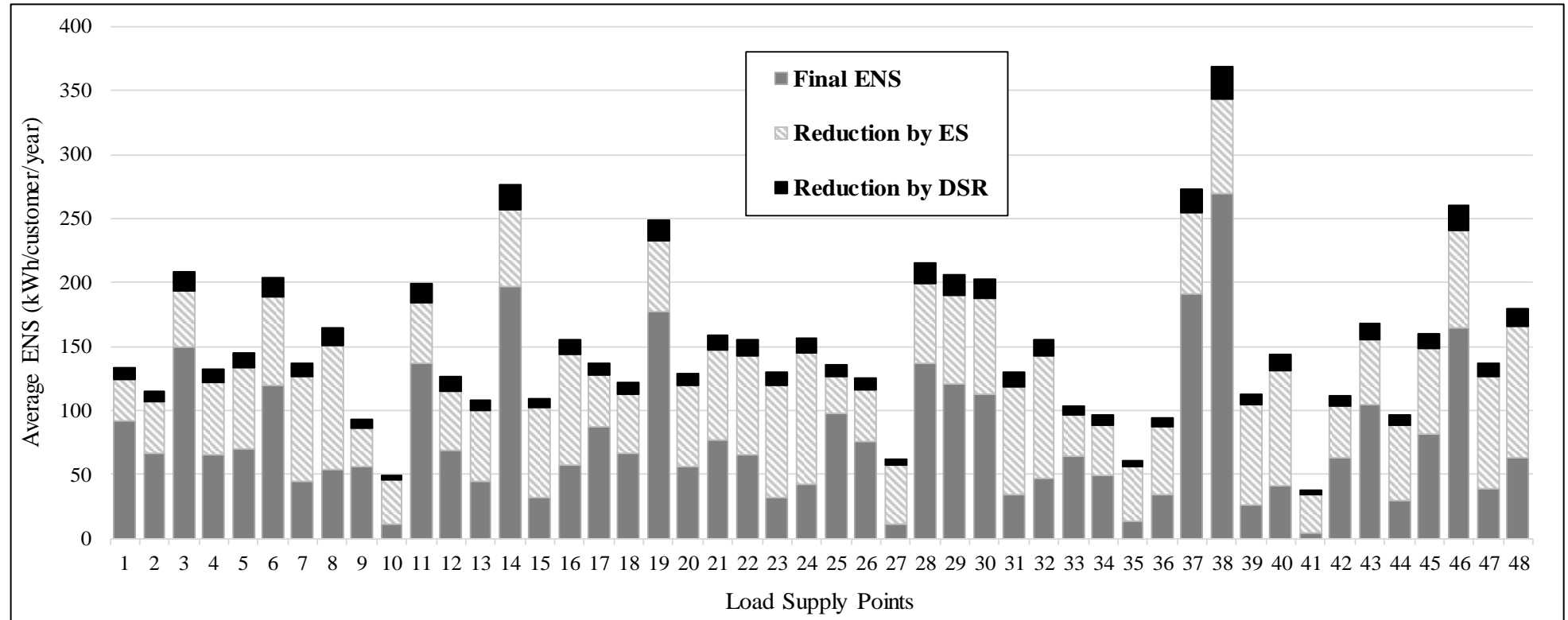

- **E. Storage** offers a more significant contribution to ENS reduction because it represents a **post-fault corrective** action, while **DSR** is deployed as a **preventive** action

## SG Performance in Rural LV Networks?

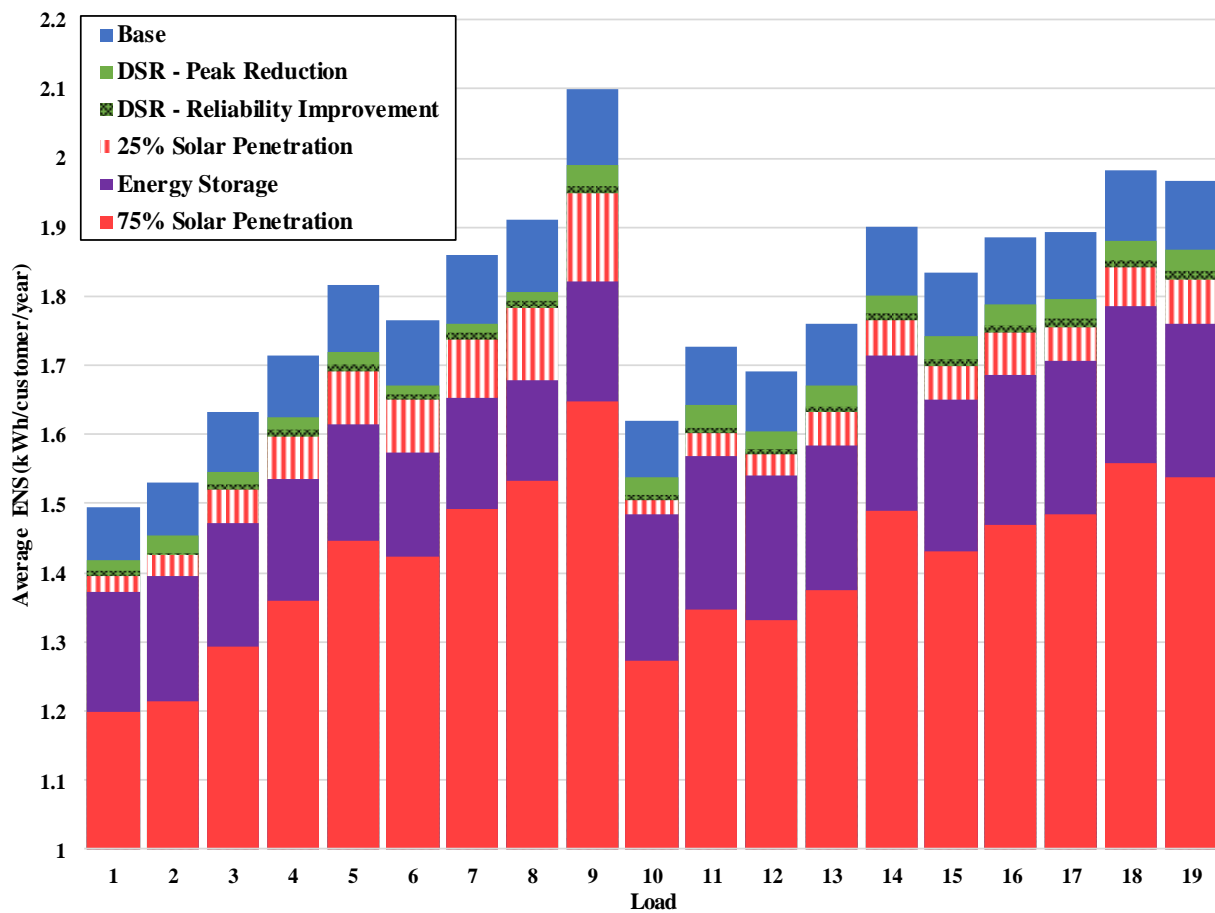

Average ENS for all modelled SG scenarios

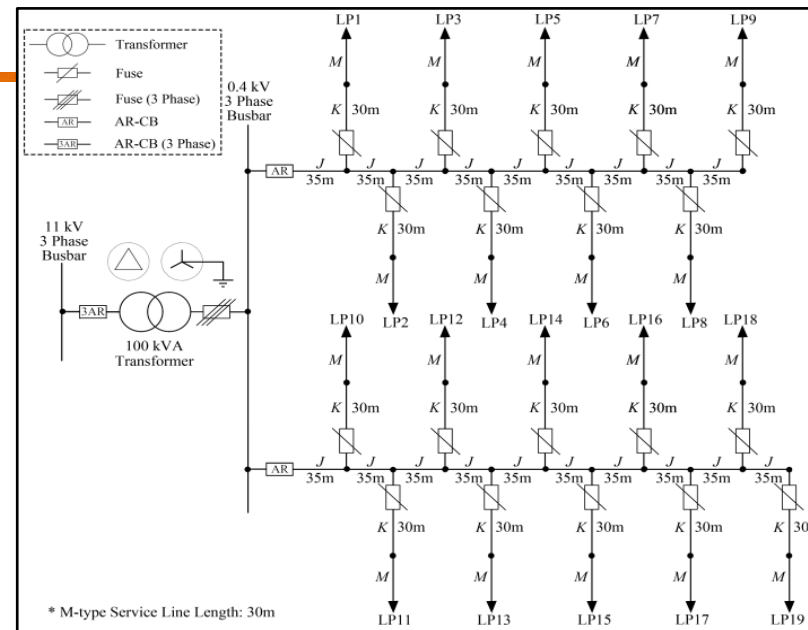

- **DSR** schemes have small effect on reliability indices:
  - Likely due to low-peak load profile
  - DSR suits higher density networks
- Cumulative energy supply from **E. Storage**:
  - Loads down radials benefit more
- **PV** case (75% penetration): largest improvement (21% ENS/cust./year)

**Wide network Diversity!**

**Energy Not Supplied  
AGGREGATE Network:**

**Energy Not Supplied  
DISAGGREGATION of  
Reliability Performance:**

(variability of performance due to network configuration, demand and mix of components)

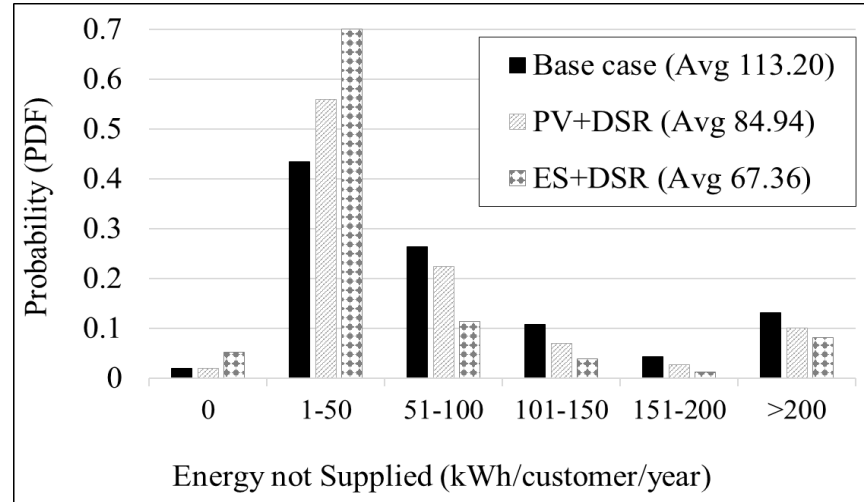

- Limiting ENS **raises** customer willingness to pay
- Aggregation significantly **lowers** the **collective probability** of having 'zero' ENS in the network
- ES+DSR **increases** the probability of low ENS values given the combined average reduction in all constituent networks

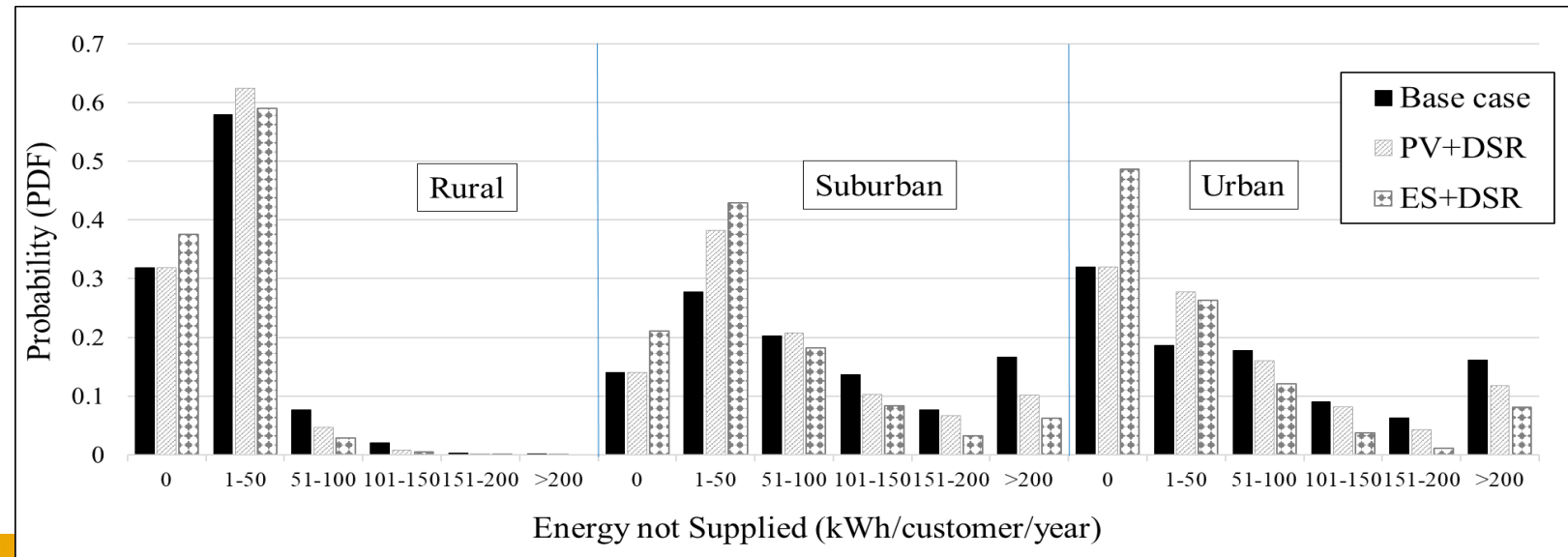

## Deterministic vs Probabilistic Assessment:

Variations of demands + DG power outputs + dynamic thermal ratings (DTR) of network components

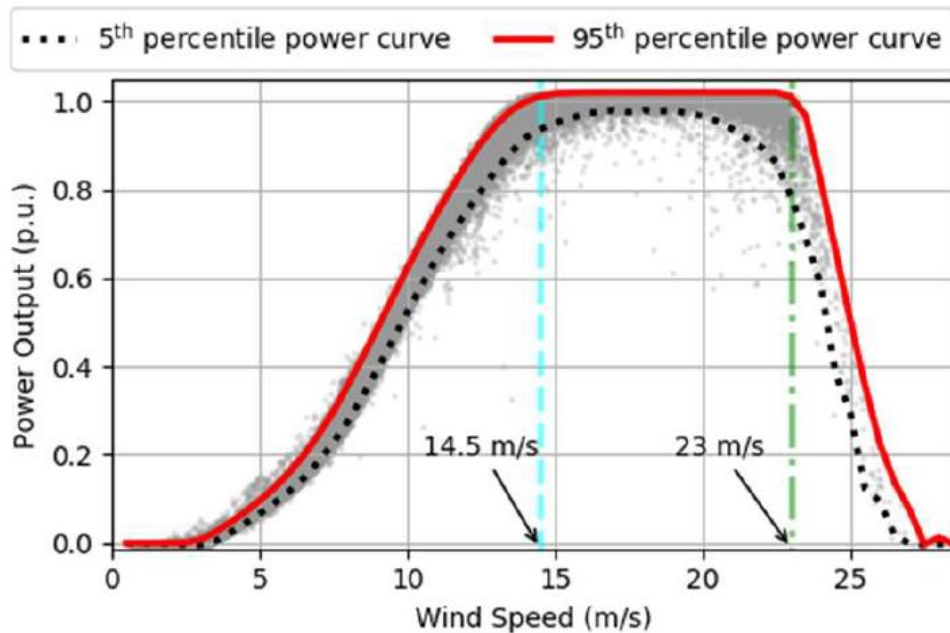

Wind speeds for which an actual WT produces 1 p.u. power output

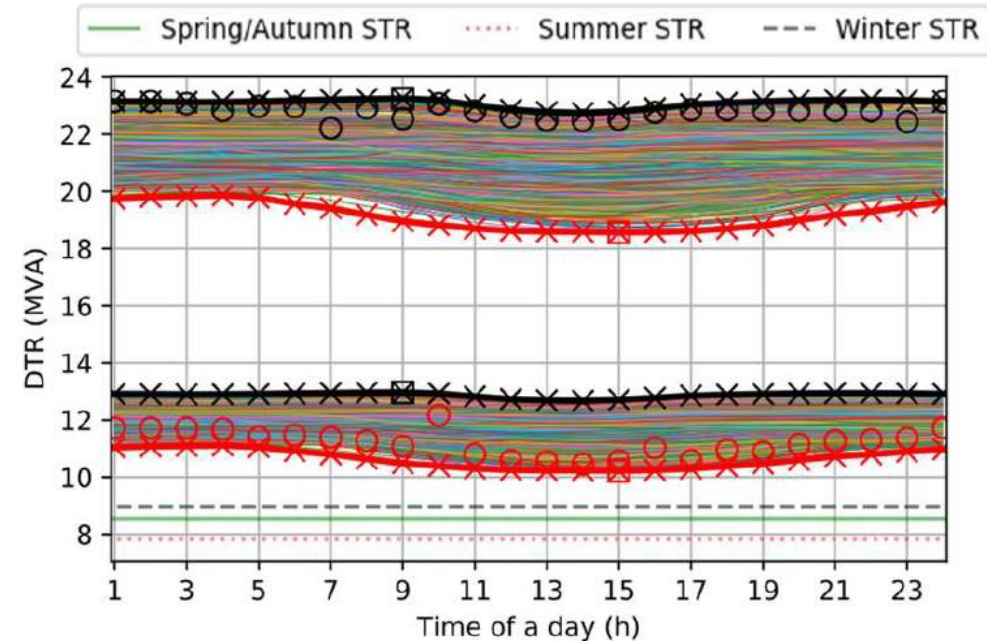

variations in minimum and maximum DTR values for OHL Type S for wind speeds of 14.5 m/s (up) and 23 m/s, and wind directions of 0° and 90°

(example of coincidental DTR values with max/min demands)



Comparison of ranges of **LHC values** assessed by **deterministic and probabilistic approaches** at individual network buses (for a single DG unit connected at a considered bus in generic MV network)

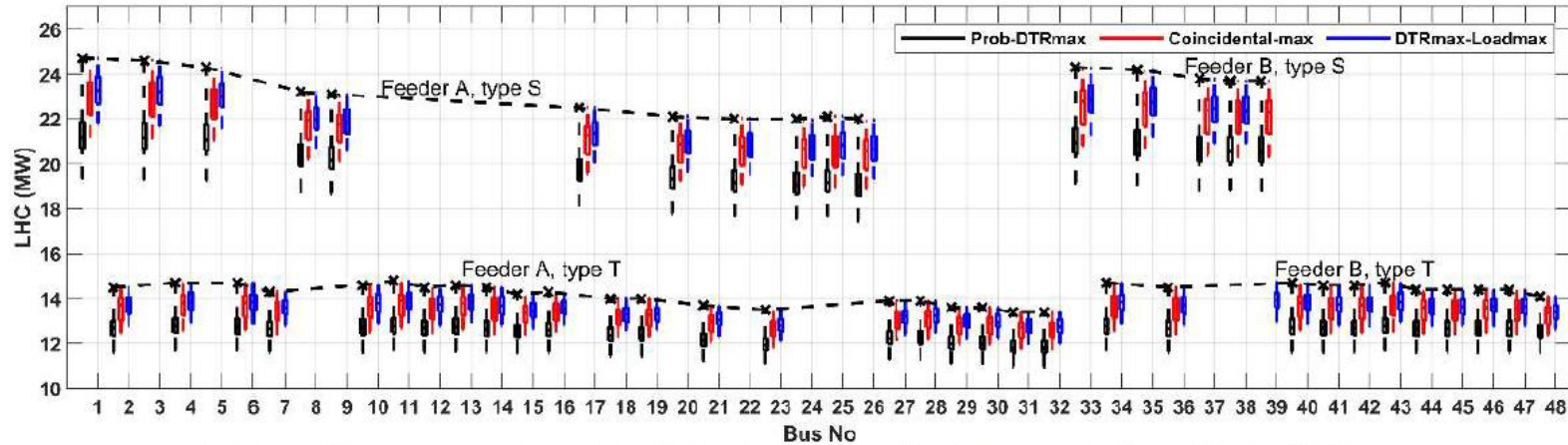

a) LHC values corresponding to non-firm capacity allocation (100% constraint violation limit)

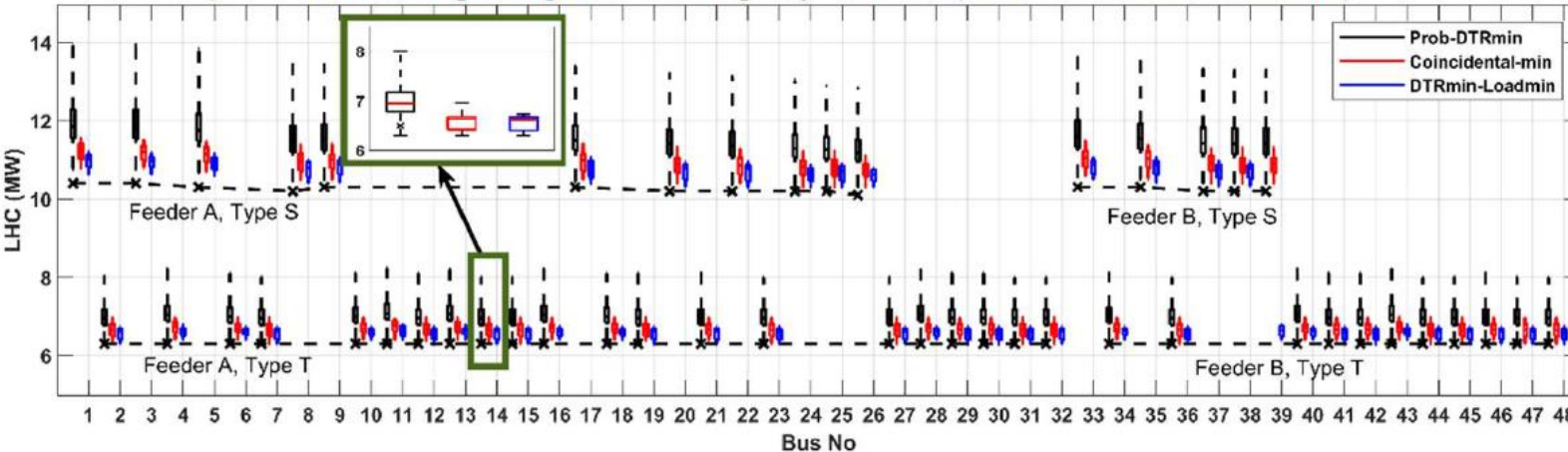

b) LHC values corresponding to firm capacity allocation (0% constraint violation limit)

Comparison of two optimisation methods (IEEE 33-bus network)

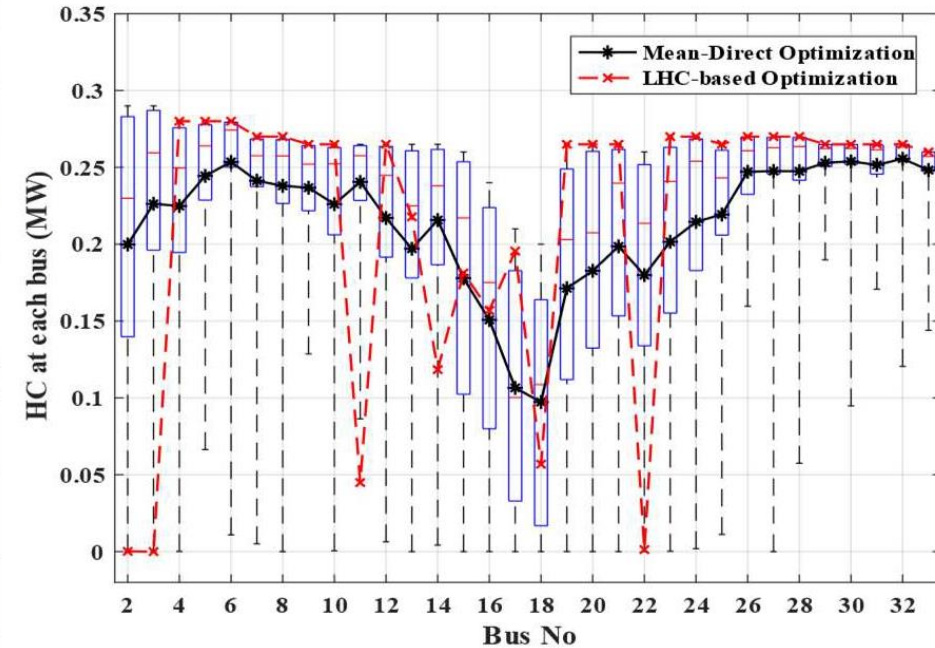

- Integration of electric power, gas and heating

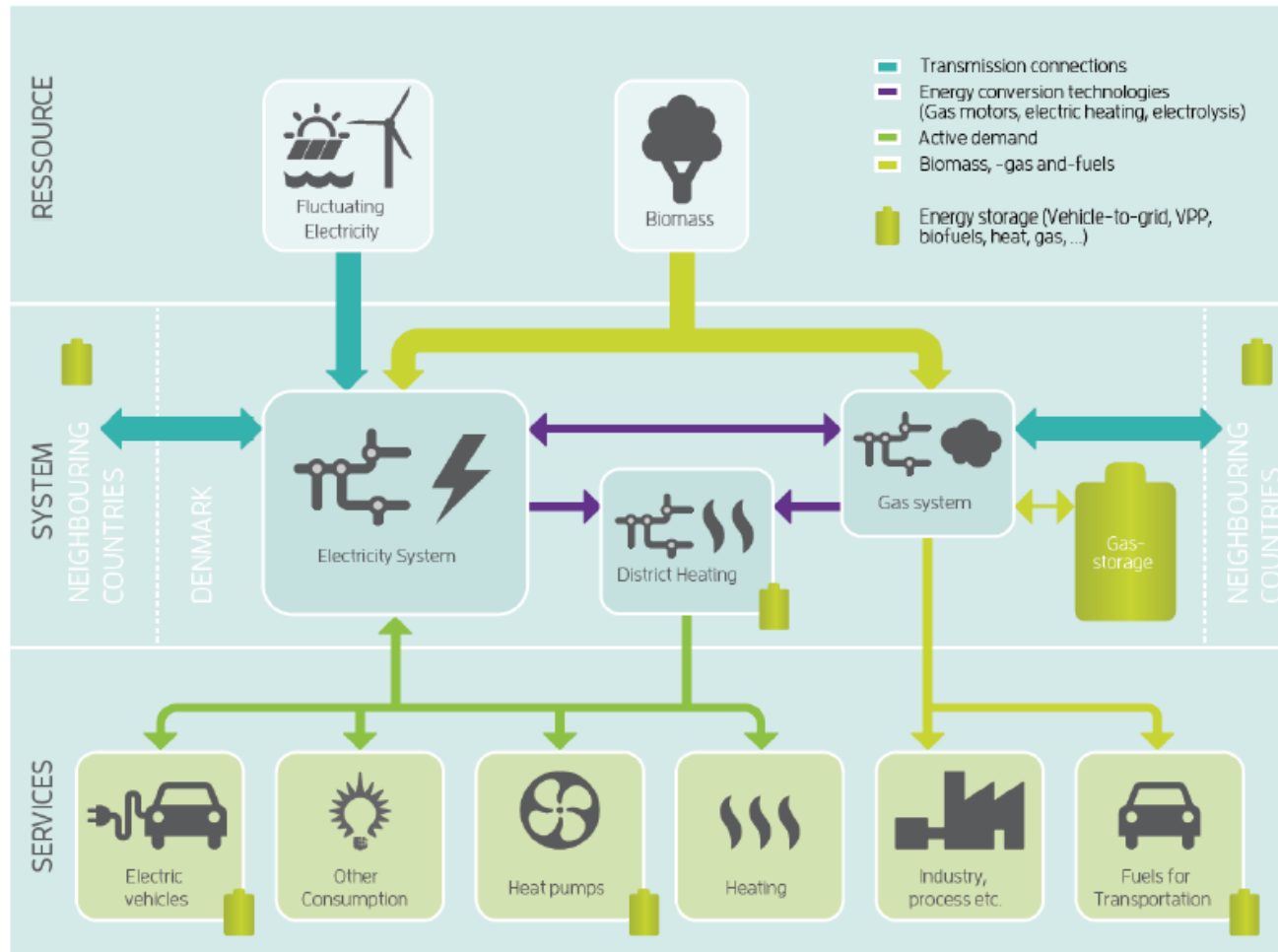

- High flexibility
- High reliability
- Cost efficiency
- Fuel shift
- Consumption time shift/thermal inertia
- Storage

## Smart Energy Management Systems

### → Aims:

- Maximise self-consumption of local generation (multi-energy)
- Minimise use of peak-price electricity (dispatchable microgrids in the pool market)
- Gain revenue through resolving network congestions

### → Insights into:

- Real-time modelling and forecasting of:  
(hardware)
  - Local (renewable) generation
  - Local consumption / storage
  - Supplier's time-of-day pricing
- DSR Aggregation: Battery Storage for network balancing
- Improve security of supply through storage of excess energy
- Control algorithms for an optimal PV-Battery management (fail-safe control)
- Peer-to-Peer Energy Trading (technically tested for the first time) – new business models

## Comparison of building energy management systems algorithms

### → Criteria:

- I. Ability to consider predictions.
- II. Calculation complexity.
- III. Model dependency.
- IV. Flexibility concerning Building Micro-Grid expansion.
- V. Robustness against uncertainties.

Category	Algorithm	I	II	III	IV	V
Metaheuristic	Genetic Algorithm	•	••	••	•••	••
Deterministic	Fuzzy Logic	•	•	••••	••	••
Predictive control	MPC	•••••	••	••	•••	••••
Artificial intelligence	Q-learning	•••	•••	•	••••	•••••
Stochastic & Robust	CVar	••	••••	•••	•••	••••

Legend: • very low      •••••: very high



## Proactive Operation Management of Building MicroGrids

Smart operation of buildings:  
**from reactivity to proactivity**

### → Objectives:

- self-consumption
- self-management
- self-monitoring
- self-healing
- self-optimization
- comfort, safety, well-being,
- new associated business models

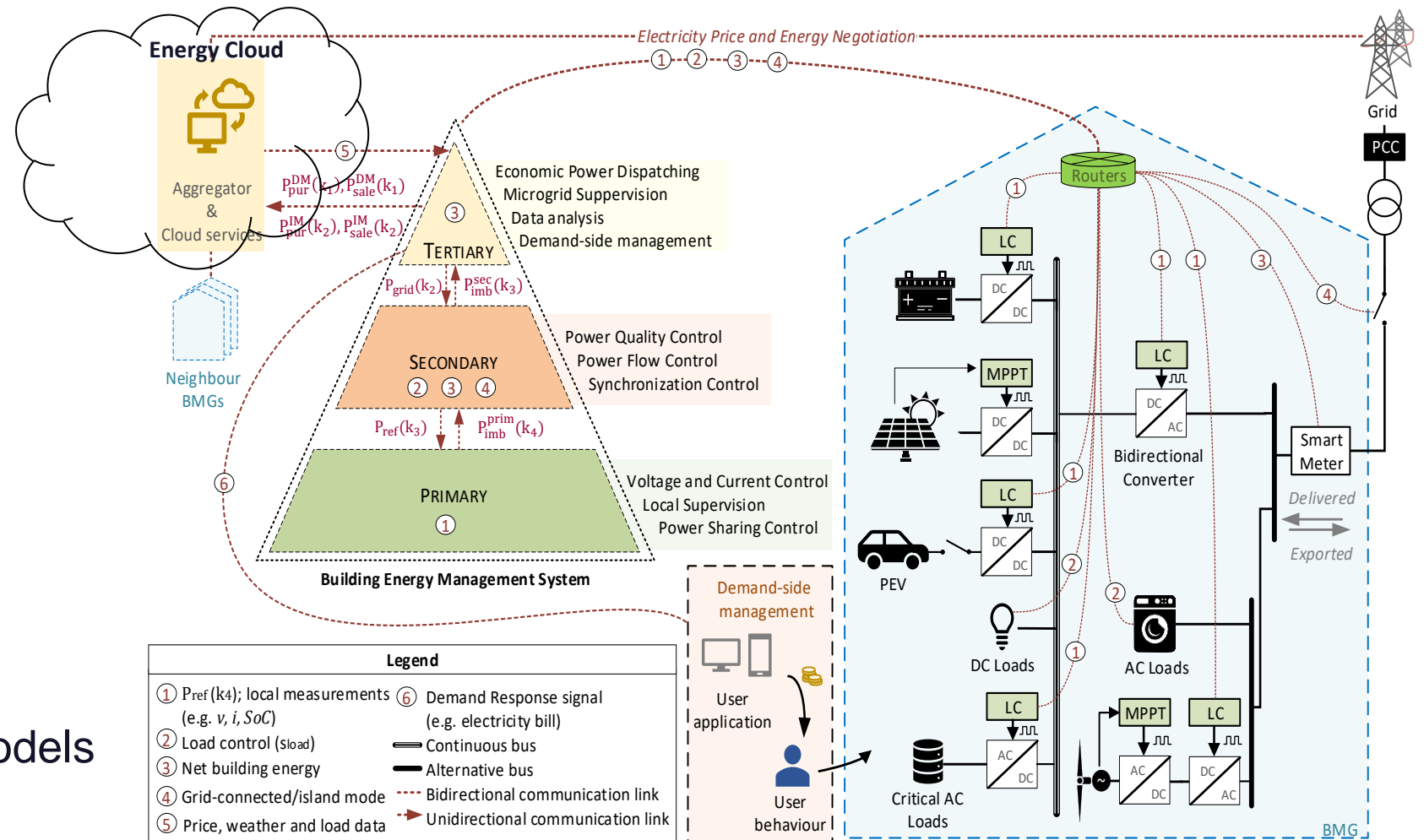

ZELEC Project:



PROGRAMME ALLIANCE 2021

Towards Self-Sufficient Zero Emission Local Energy Communities

Control and Optimization  
Building-integrated Microgrid based  
on Hybrid PV/Hydrogen/Energy  
Storage Systems

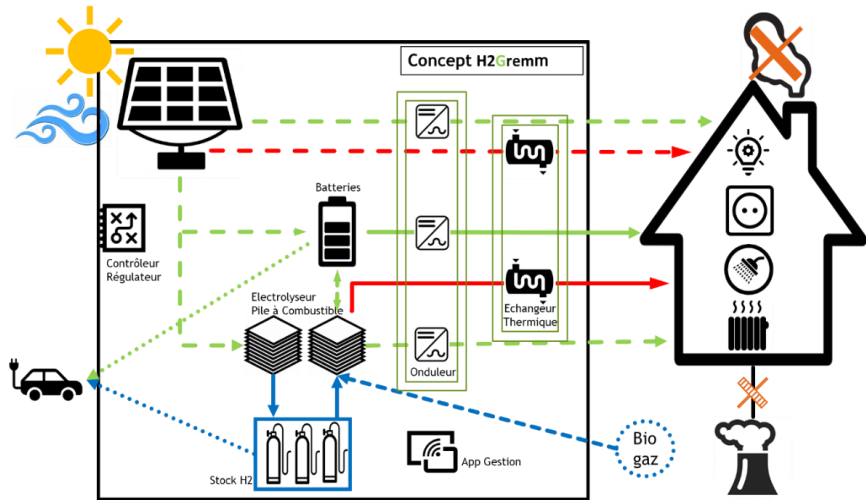

**H2Gremm**  
Energy for homes

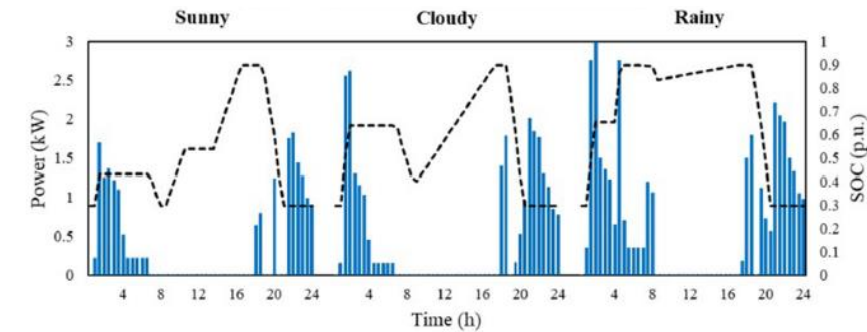
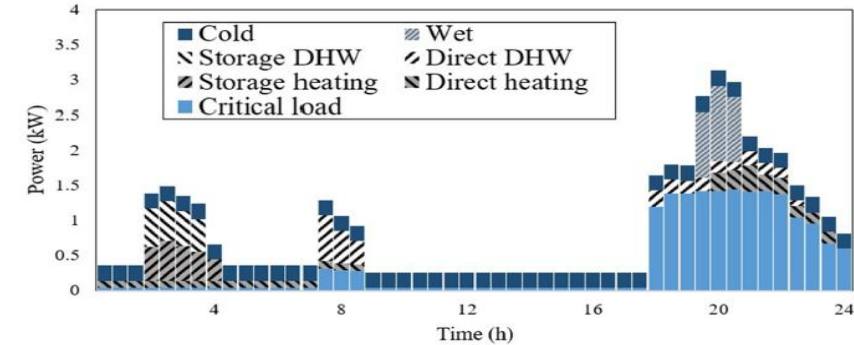
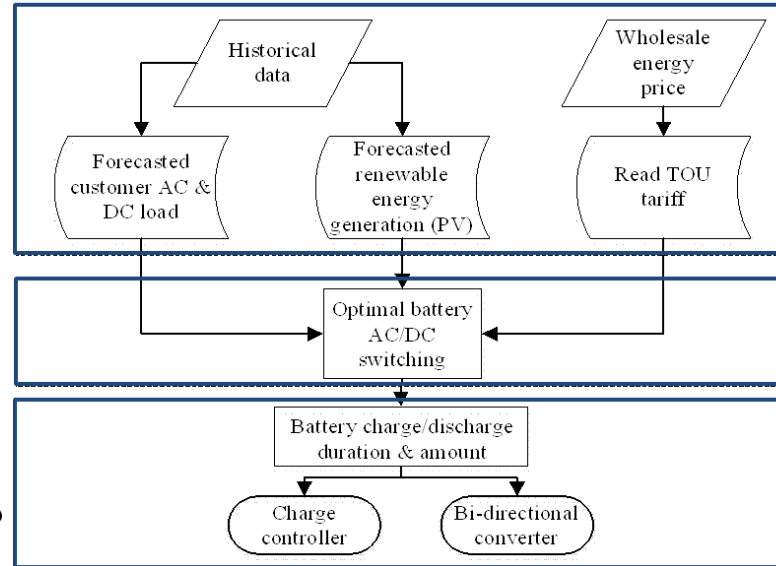

Appliance and SOC consumption  
scheduling for HEMS optimisation

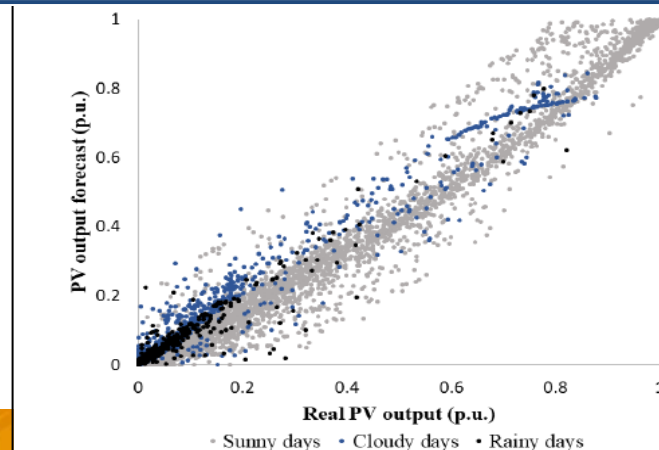
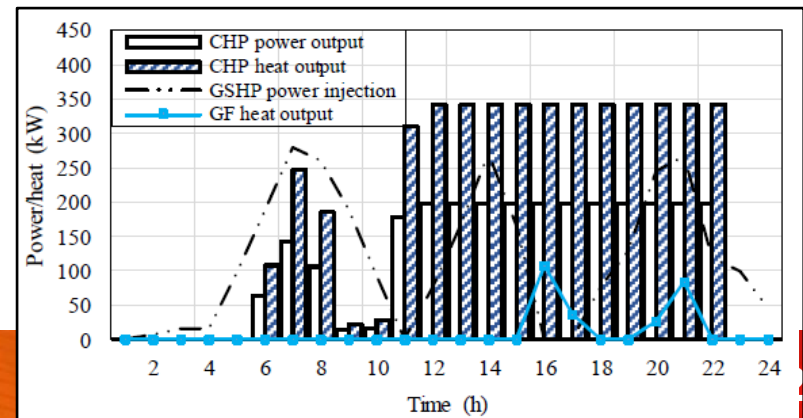
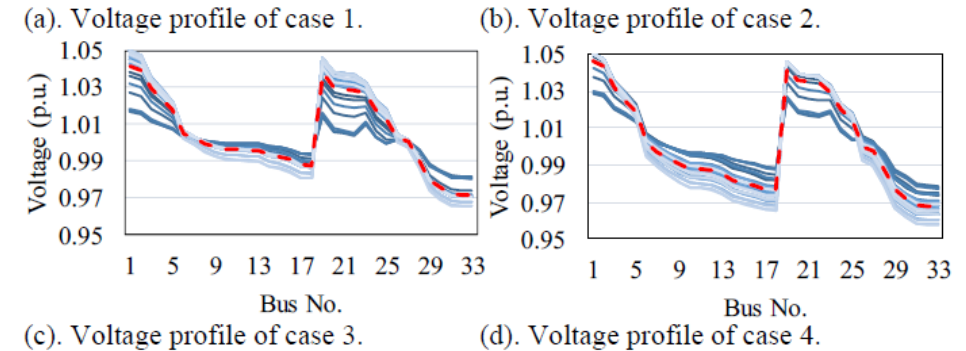
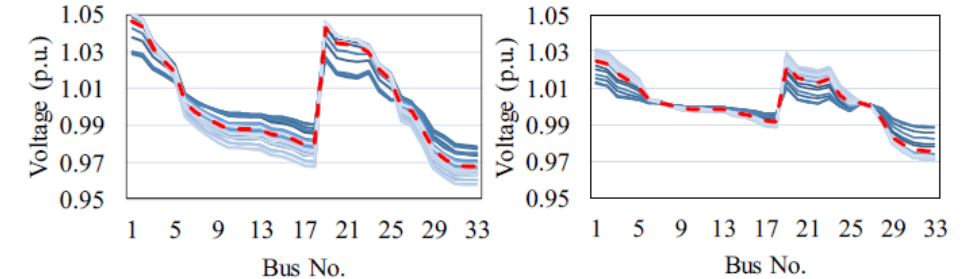
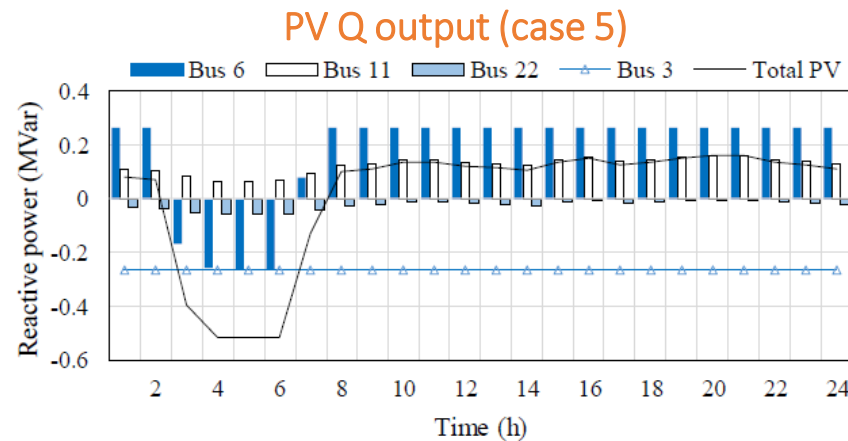
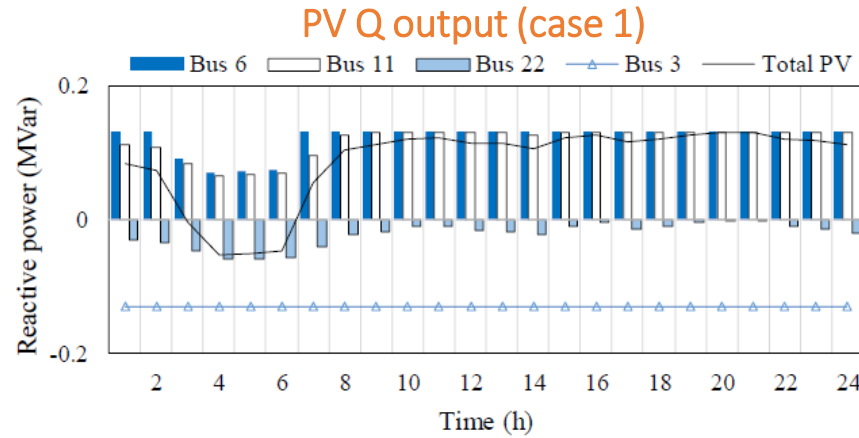

Fig. 2. PV output forecast for application with HEMS

## Two-stage coordinated Volt-Pressure Optimization (VPO) for Integrated Energy Systems (IES) networked with Energy Hubs considering Renewable Energy and Power-to-Gas (P2G) sources

CASE ILLUSTRATION

Case No.	PV system capacity (kVA)	Gas system connection	Gas quality management
1	400	Yes	Yes
2	400	P2G	Yes
3	400	G2P	Yes
4	400	No	Yes
5	800	Yes	Yes
6	400	Yes	No



Economic-effective day-ahead preparation and real-time adaptive operation scheme

Energy Hub scheduling

- ✧ **Low voltage systems in planning**
- ✧ **Impact of active demand in planning**
- ✧ **Data analytics for load modeling**
- ✧ **Choice of proper time granularity**
- ✧ **Interface TSO/DSO**
- ✧ **Reduction of complexity**
- ✧ **Integration of multiple services/infrastructures/energy**
- ✧ **Simulation of the role of energy and service markets in distribution planning**



- ✧ DSOs still adopt traditional planning tools
- ✧ Traditional planning is not suited for smart distribution
- ✧ New planning methodologies are required
  - ✧ Data Modelling and Smart meters
  - ✧ Operation & planning
  - ✧ Role of flexible demand/generation/storage in planning
  - ✧ Risk and reliability analysis
  - ✧ Co-simulation of ICT and Power Systems

# Thanks for listening

## Questions?

Dr Ignacio Hernando-Gil

ESTIA Institute of Technology (University of Bordeaux)

[i.hernandogil@estia.fr](mailto:i.hernandogil@estia.fr)

Acknowledgement:

