



HAL
open science

Key challenges for a large-scale development of battery electric vehicles: A comprehensive review

Badreddine Lebrouhi, Y Khattari, B Lamrani, M Maaroufi, Youssef Zeraouli, Tarik Kousksou

► To cite this version:

Badreddine Lebrouhi, Y Khattari, B Lamrani, M Maaroufi, Youssef Zeraouli, et al.. Key challenges for a large-scale development of battery electric vehicles: A comprehensive review. *Journal of Energy Storage*, 2021, 44, <10.1016/j.est.2021.103273>. <hal-03716827>

HAL Id: hal-03716827

<https://hal.science/hal-03716827v1>

Submitted on 5 Jan 2024

HAL is a multi-disciplinary open access archive for the deposit and dissemination of scientific research documents, whether they are published or not. The documents may come from teaching and research institutions in France or abroad, or from public or private research centers.

L'archive ouverte pluridisciplinaire **HAL**, est destinée au dépôt et à la diffusion de documents scientifiques de niveau recherche, publiés ou non, émanant des établissements d'enseignement et de recherche français ou étrangers, des laboratoires publics ou privés.



Distributed under a Creative Commons CC BY-NC 4.0 - Attribution - Non-commercial use - International License

Key challenges for a large-scale development of battery electric vehicles: A comprehensive Review

B. Lebrouhi^(a,b*), Y. Khattari^(b), B. Lamrani^(c), M. Maaroufi^(a), Y. Zeraouli^(b), T. Kousksou^(b*)

^(a) *Engineering for Smart and Sustainable Systems Research Center, Mohammadia School of Engineers, Mohammed V University in Rabat, Rabat, 11000, Morocco*

^(b) *Université de Pau et des Pays de l'Adour, E2S UPPA, SIAME, Pau, France*

^(c)

Université Mohammed V de Rabat, Faculté des Sciences, Laboratoire MANAPSE, B.P. 1014 RP Rabat, Morocco

Abstract

Nowadays, several countries have adopted an energy transition policy to achieve carbon targets and decarbonize transport while improving their electricity mixes. Electric vehicles are ubiquitous, considering its role in the energy transition as a promising technology for large-scale storage of intermittent power generated from renewable energy sources. However, the widespread adoption and commercialization of EV remain linked to policy measures and government incentives. Here in this work, we review the current bottlenecks and key barriers for large-scale development of electric vehicles. First, the impact of massive integration of electric vehicles is analysed, and the energy management tools of electric energy storage in EVs are provided. Then, the variety of services that EVs may provide is investigated. We also, highlight how the optimal placement and sizing of EV charging infrastructure can plays a crucial role in electric vehicle development. The different methods for Li-ion battery states estimation and cells characterization are outlined. Furthermore, we present the different incentives to accelerate EVs adoption. And finally, we provide insightful suggestions and policy recommendations for future studies. The work presented in this paper will be very beneficial for policymakers seeking to promote electric mobility, and advance sustainable EV technologies.

Keywords: *Electric vehicles, EV charging infrastructures, li-ion battery, energy storage, vehicle*

Contents

1. Introduction	4
2. Large-scale adoption of EVs	5
3. Safety and reliability of lithium-ion batteries for EVs	10
3.1. Battery management system	12
3.2. Battery thermal management system.....	14
3.2.1. External heating strategies	15
3.2.2. Internal heating strategies	16
3.3. Battery states estimation methods	17
3.3.1. Direct methods (Conventional method).....	19
3.3.1.1. Open circuit voltage-based estimation (OCV)	19
3.3.1.2. Coulomb counting estimation (CC).....	20
3.3.1.3. Electrochemical impedance spectroscopy (EIS)	20
3.3.2. Model-based estimation methods.....	21
3.3.2.1. Electrical circuit model-based estimation (ECM)	21
3.3.2.2. Electrochemical model-based estimation (EChM).....	23
3.3.3. Adaptative filter algorithms	25
3.3.3.1. KALMAN filters-based estimation (KF).....	25
3.3.3.2. Recursive least square based estimation (RLS).....	27
3.3.3.3. Particle filter (PF).....	27
3.3.3.4. H infinity-based estimation (H^∞)	28
3.3.4. Machine learning based methods (ML).....	28
3.3.5. Others approaches	30
3.4. Methodologies for battery cells characterisation	32
3.5. Life cycle analysis of a battery electric vehicle	35
3.6. Mining resources.....	36
4. EV charging infrastructures.....	37
4.1. Conductive charging systems	37
4.2. Wireless charging system	40
4.3. Battery swapping stations.....	42
4.4. Optimal placement and sizing of EVCS.....	47

5. Services that an EV can provide	50
6. Incentives to accelerate EVs adoption.....	53
7. Recommendations.....	56
8. Conclusion.....	58

Acronyms:

AC	Alternating Current
ACO	Ant Colony Optimization
BEV	Battery Electric Vehicles
BMS	Battery Management Systems
BSS	Battery Swapping Station
BTMS	Battery Thermal Management System
DC	Direct Current
DWPT	Dynamic Wireless Power Transfer
E3G	Third Generation Environmentalism
EchM	Electrochemical Model
ECM	Equivalent Circuit Model
EVCS	Electric Vehicle Charging Stations
EVs	Electric Vehicles
EVSE	Electric Vehicle Supply Equipment
GA	Genetic Algorithm
HEV	Hybrid Electric Vehicle
HOV	High Occupancy Vehicle
ICEV	Internal Combustion Engine Vehicles
IEC	International Electrotechnical Commission
IP	Integer Programming
ISO	International Organization for Standardization
PCM	Phase Change Material
PEV	Plug-in Electric Vehicles
PSO	Particle Swarm Optimization
PTC	Positive Temperature Coefficient
RUL	Remaining Useful Life
RTR	Rate of Temperature Rise
SAE	Society of Automotive Engineers
SOC	State of Charge
SOH	State of Health
V2B	Vehicle-to-Building
V2G	Vehicle- to-Grid
V2H	Vehicle-to-Home
V2L	Vehicle-to-Load
V2V	Vehicle-to-Vehicle
V2X	Vehicle-to-Everything
VCC	Vapour Compression Cycle
WPT	Wireless Power Transfer

1. Introduction

Various strategies are under development to accelerate the penetration of EVs into the worldwide market [1]. Tesla's approach that aims to reduce the cost of batteries via advanced manufacturing, packaging and expedition techniques [2]. The second approach consists mainly in developing and optimizing the energy performance of cells by reducing their costs [3]. The third approach aims at introducing new, smarter and smaller battery management systems (BMS) to improve the energy performance of EVs and reduce their weight [4]. The fourth approach aims to create new sources of revenues for EV owners through the participation of these vehicles in the energy markets and the supply of several services such as Vehicle-to-Vehicle (V2V), Vehicle-to-Home (V2H), Vehicle-to-Building (V2B), Vehicle-to-Load (V2L) and Vehicle-to-Grid (V2G) [5,6]. Such services are referred to Vehicle-to-Everything (V2X) services, which are designed to obtain additional benefits from battery during non-use periods of EVs [5,7]. Despite the positive aspects of V2X services, they may impact and degrade the energy performance of the batteries [1]. Batteries will frequently be subject to irreversible capacity loss with cycling and calendar aging [8,9]. A driver's mobility needs cannot be met any more if the battery loses a lot of its energy storage capacity [4].

Several researchers have also highlighted that insufficient charging infrastructure, the appropriate location of charging stations, and the scheduling of charging at charging stations are the main challenges for the large-scale implementation of EVs [10,11]. An additional crucial issue will be to decide which of the numerous technologies and load specifications should prevail and dominate the load of future EVs [12]. An appropriate load management of EVs is crucial to ensure reliable interconnection with the power grid [13]. An intelligent management of EV charging strategy can also lead to a reduction in the costs of electricity to users under dynamic pricing schemes [14]. In the absence of proper coordination, the power distribution system becomes overloaded due to the simultaneous loading of EVs. Unfortunately, the growth of EV markets and the promotion of EV adoption remain linked to policy measures and government incentives [15,16].

The aims of this paper are to:

- *Analyse the impact of massive integration of electric vehicles.*
- *Present the energy management tools of electric energy storage in EVs.*
- *Outline the different methods for Li-ion battery states estimation and cells characterization.*
- *Highlight how charging infrastructure plays a key role in electric vehicle development.*
- *Investigate the diversity of services that can be offered by EVs.*
- *Present the different incentives to accelerate EVs adoption.*
- *Provide insightful suggestions and policy recommendations for future studies*

However, the work presented in this paper will be very beneficial for policymakers seeking to promote electric mobility, and advance sustainable EV technologies. This review is arranged as follows: **Section 2** analyses the impact of massive integration of electric vehicles. **Section 3** discusses the reliability and safety of lithium-ion batteries for vehicular applications. In addition, the energy management tools for storing electricity in EVs and the different methods for Li-ion battery states estimation and cells characterization are outlined. **Section 4** highlights the different EV charging infrastructure, latest technologies, evolving standards, and optimal placement and sizing. **Section 5** investigates the diversity of services that can be offered by EVs. **Section 6** presents the different incentives to accelerate EVs adoption. And finally, insightful suggestions and policy recommendations for future studies are given in **section 7**.

2. Large-scale adoption of EVs

*Globally, electric vehicles have been widely adopted during the last ten years. In 2020, Plug-in EVs sales surpassed 3.24 million vehicles compared to 2.26 million for the previous year with a year on year (Y-O-Y) growth of 43%, and 4.2% share of all new car sales [17]. Overall, Plug-in EV sales and market share can be observed by region in **Fig.1**. According to [18], these sales are expected to hold 27% of the global EV market by 2030. Today, China, Germany, and the United States leading the globe in the number of registered electric vehicles.*

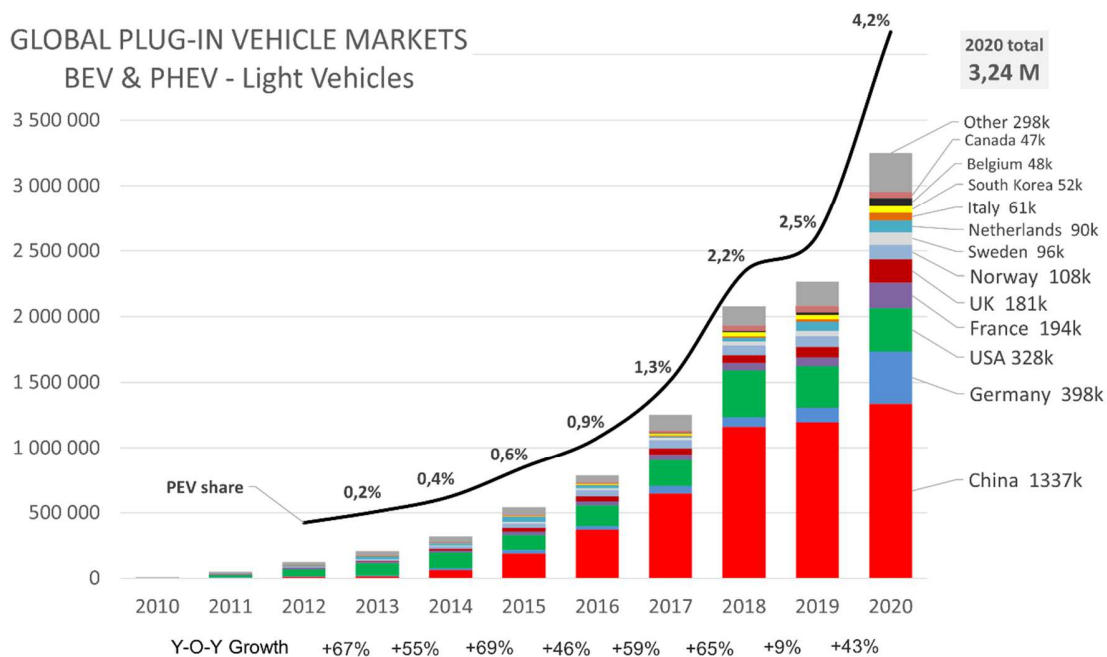

Fig. 1. Global Plug-in EV Sales [17]

According to a study conducted by the think tank E3G entitled "*Rules of the Road: The Geopolitics of Electric Vehicles in Eurasia*", many countries are not prepared for the consequences associated to the transition towards decarbonized energies [19]. A rapid and large-scale transition from the Internal Combustion Engine Vehicles (ICEV) to the EVs can be extremely troublesome in many countries [20]. From this study, EVs are projected to reach price parity with the ICEV by 2022. The E3G study identifies four major types of risks [19].

- *Industrial, commercial, social and political risk:* Large-scale introduction of EVs may devastate existing industries, particularly in Europe, the United States and Japan, where the automobile sector represents a significant share of economic activity.
- *Risk of destabilization of oil-producing countries:* Decarbonization of the automotive sector via the massive introduction of EVs can make oil-producing countries vulnerable and unstable.

- *Risk to access on resources:* A crucial challenge for EVs is to develop a suitable energy storage system with high autonomy and fast charging. Lithium-ion batteries are recently recognized as the most promising energy storage device for EVs due to their higher energy density, long cycle lifetime and higher specific power. Therefore, the large-scale development of electric vehicles will result in a significant increase in demand for cobalt, nickel, lithium and other strategic metals and rare earths. It is possible that access to these materials will be, as oil has been, an instrument for political lobbying and pressure [19].
- *Financial Risk:* Replacing internal combustion vehicles with EVs will gradually eliminate the revenues and profits of such a powerful industry, the first in the world, as the oil industry.

EVs are expected to play a significant role in the large-scale integration of renewable energy sources into the electricity grid [21,22], e.g. by saving electricity during peak generation and supplying energy to the grid during peak demand [23]. Conversely, inappropriate and poor management of EVs could negatively affect the power supply like voltage instability, peak demand, power quality, power losses, transformer heating and overloading.

- *Voltage instability:* It concerns voltage fluctuations around nominal values. This problem may be occurred under heavy loading conditions when the power system is unable to meet the demand [24]. Several authors [25,26] have demonstrated that EVs are highly responsible for voltage instability in the power system due to the non-linearity of EVs load, especially in case of massive penetration with high-charging level. Coordinated smart charging system with an aggregator can make the power grid more reliable and stable [27].
- *Peak demand fluctuation:* Electrical power absorbed under load of a significant number of EVs can exceed the power available in the power grid. The uncoordinated charging of large number of EVs can provoke a very serious problem for electricity system operators [28,29]. Bidirectional charging concept with a dynamic load control technique can be used to control peak loads on the power system [30]. It is very important to mention that the electrical power system can withstand a level of EV penetration without being

impacted. For instance, 500,000 EV in Ontario, Canada [31,32], and 73% EVs penetration in the US [33].

- *Power quality*: The effects of harmonic currents on the power quality caused by EVs are mainly related to several factors like rapid charging, AC single phase charging, the diversity of charger architecture, the EVs range, the number of chargers connected at same time, and the level of EV penetration [34,35]. Smart charging infrastructure, reliable communication systems, coordinated charging system, are the concepts required to reduce harmonics injected by uncontrolled EVs penetration in [36].
- *Power losses*: EVs are the main responsible of the power losses in the power grid [37,38]. Uniformly distributed charging, smart metering method, selecting optimal location and capacity of charging stations can substantially reduce power supply losses [39,40].
- *Transformer Overheating*: High integration of EVs into the power grid can overheat transformers [11,41]. The application of the K-factor derating method and the introduction of an intelligent load management strategy are among measures employed to prevent transformer overheating [42,43].

As mentioned above, to manage overloading due to EV load demand and to secure the grid from potential risks, the charging and discharging of EVs must be programmed with an appropriate planning and optimal management strategy. It is interesting to outline that the management approaches to support the charging of a large number of electric vehicles can differ considerably, according to the types of renewable energy and conventional power generation in each country, even for countries with a comparable share of renewable energy. In countries where the provision of renewable energy is highly variable, the coordination of energy demand for electric vehicles can be a serious problem. In certain regions where network infrastructure is weak, additional grid reinforcement or specific "smart charging" strategies may be required to guarantee an efficient and flexible electricity production and supply infrastructure. As illustrated in **Fig.2**, a number of tools are currently available to investigate the impact of EVs on the reliability of the power system [44,45]. By using these tools, EVs' efficiency and economic benefits can be improved.

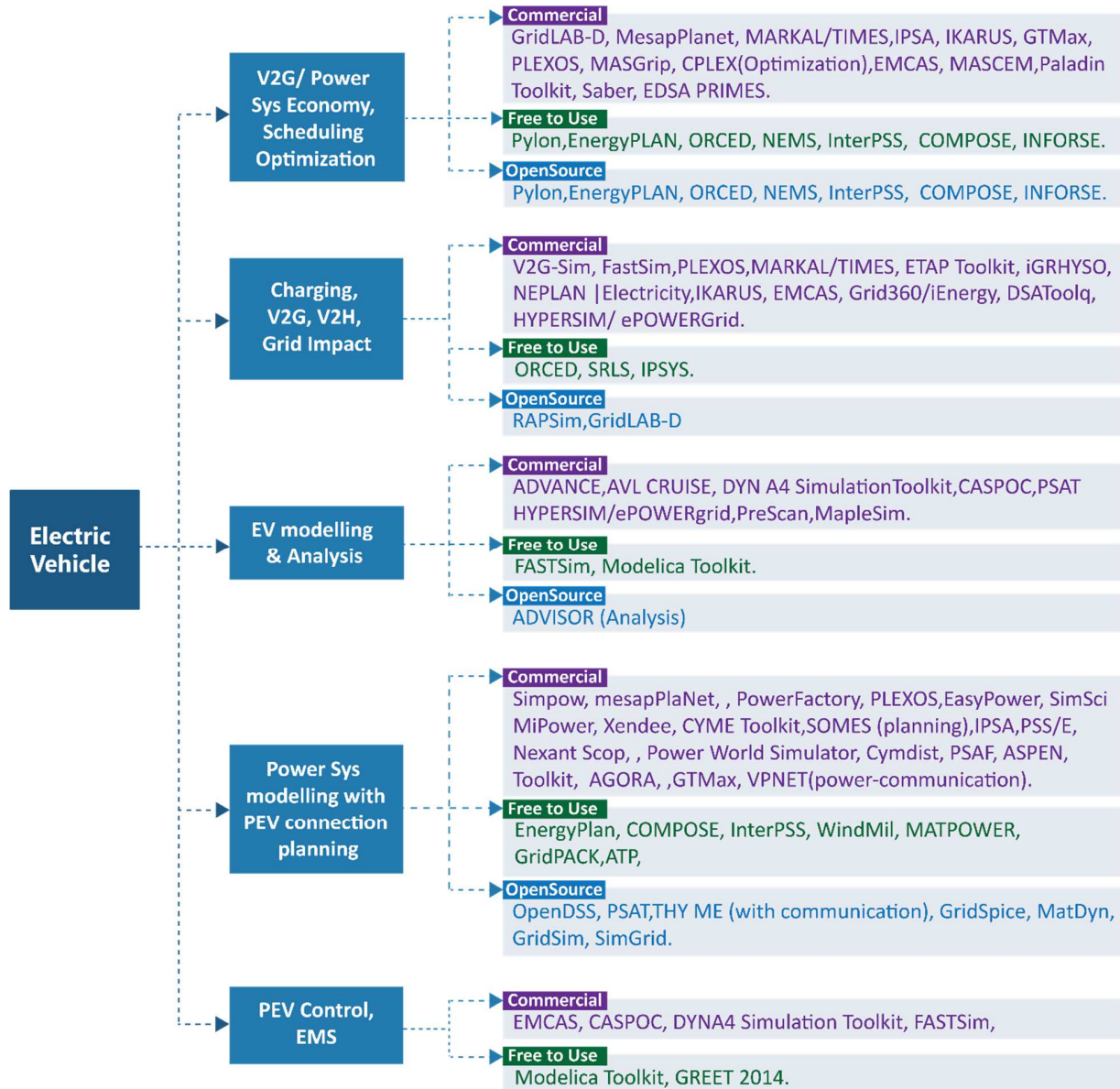

Fig. 2. Summary of commercial and non-commercial tools that can simulate different aspects of an electric vehicle and its integration to the grid

3. Safety and reliability of lithium-ion batteries for EVs

In EVs, the battery is the unique energy source to power the vehicle. Therefore, the safety, reliability and lifetime of the battery are crucial factors for the acceptance of the EV at a large scale [46,47]. It is worth pointing out that the safety and reliability of the entire system can be

seriously impacted if degradation of battery performance is not detected in time. **Fig.3** summarizes the contributions of aging stress factors to cell efficiency, providing a proxy to explain conditions that increase the ageing rate. Therefore, lithium-ion batteries necessitate a permanent surveillance and controls to assure continued reliability and prevent catastrophic failures (See **Fig.4**) [48,49].

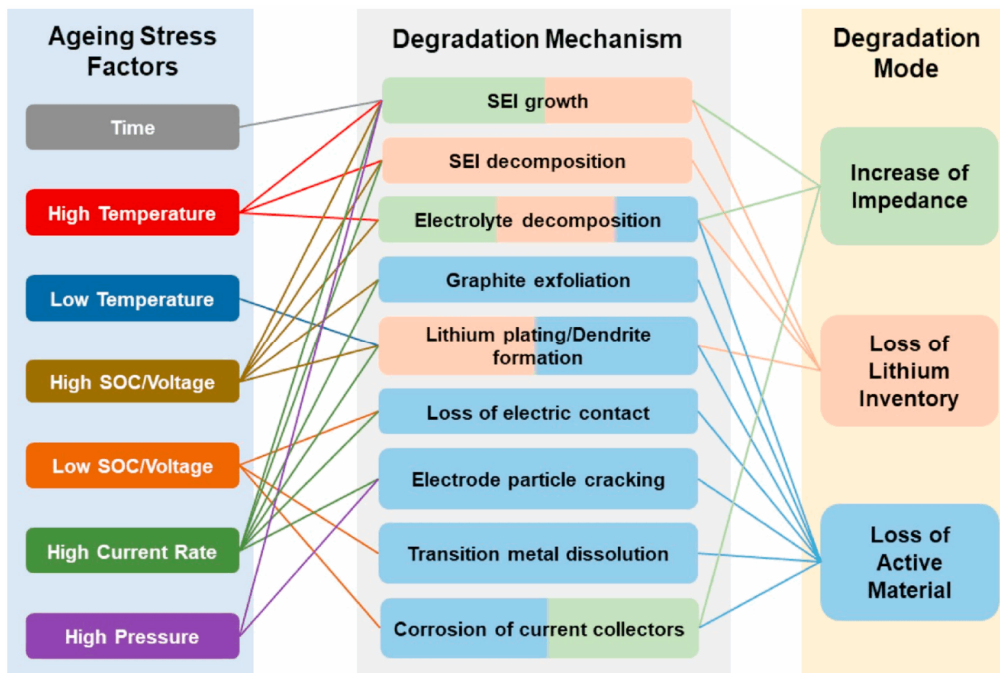

Fig. 3. Battery ageing impact factors during cycling and their associated degradation modes [50]



Fig. 4. EV and battery cells damaged by fire [49]

Harlow et al. [51] have invented a new method to assess battery failure during charge and discharge while looking at the amount of energy lost. Then, plotting the data obtained gives a curve that allows to determine the degradation of the battery as a function of the number of cycles (see Fig.5). For instance, for a Coulombic coefficient of 90%, there is 90% of the energy that can be used to run the battery and the 10% lost to a chemical process that degrades the battery. Until now, to determine the degradation of a battery, it took up to 8 years, taking a pack which is charged and discharged in real time. Elsewhere, Jeff Dahn and his laboratory, who are doing battery test for Tesla, have published research results for an impressive new battery cell [51]. And demonstrated that the tested new battery – a Li-Ion battery cell with a new generation NMC ‘single crystal’ cathode and a new highly advanced electric electrolyte – will be able to drive a vehicle for more than 1.6 million kilometres, and last more than two decades in grid energy storage even at an intense temperature of 40 C.

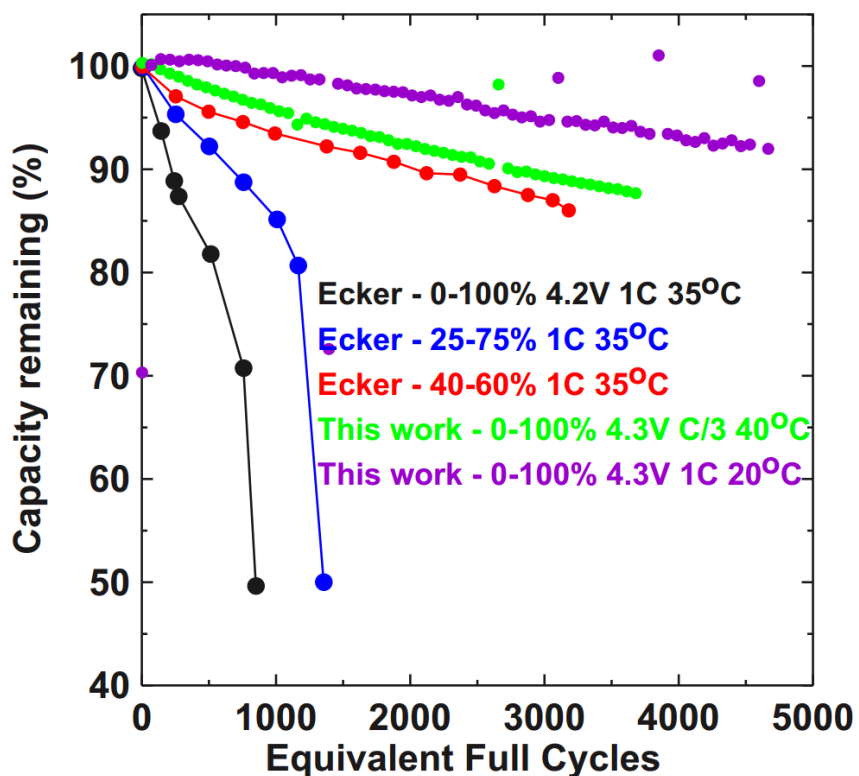

Fig. 5. Degradation of the battery as a function of equivalent full cycles for NMC/graphite cells [51]

3.1. Battery management system

The battery management system (BMS) is the most widely used method to track and manage key functionality and performance aspects like voltage, current, state of charge (SOC), state of health (SOH) and temperature [52,53]. As the lithium-ion battery is powerful and able to achieve greater efficiency over its long lifetime, careful precautions should be taken to minimize physical damage, ageing and runways [54]. Therefore, an effective BMS is desperately required to precisely calculate, estimate and control the SOC battery [55]. In electric vehicles, battery management systems (BMS) includes several components which are categorized into *hardware* and *software* structure [56], as illustrated in Fig.6. Numerous sensor systems are placed inside the BMS to track battery parameters, e.g. battery voltage, current and temperature [57]. Safety circuits are being used to precisely monitor the alarms to avoid, overcharge, over-discharge and overheating. Charge control is mandatory to manage the process of charge discharge. Although temperature variations between cells influence battery efficiency, durability, cell imbalance, a thermal management element are used in the BMS as presented in [58]. However, data within the BMS is communicated by using controlled transceiver. In order to monitor the operation of the hardware, a software structure remains essential. Upon request the users receives information and details about the state of charge (SOC) and state of health (SOH) the battery through the user interface. These battery states are generally estimated based on various models and algorithms [59,60]. Furthermore, abnormalities in battery and fault analysis are identified by intelligent control system.

Knowledge of all factors and causes that can lead to the system's degradation can help make BMS sophisticated and safe [61,62]. Battery temperature is one of the most important factors to ensure the cell health and reliability when the EV is underway [63]. To maximize the potential of lithium-ion cells, they need to be maintained at about 23–25 °C [64]. Li-ion batteries usually produce three forms of heat during charging and discharging cycles: irreversible activation heat due to the polarization of the electrochemical reaction, Joule heating resulting in ohmic losses, and reversible reaction heat due to the change in entropy during charging and discharging [65]. Consequently, if the heat released during battery operation is not correctly removed, the temperature of the system can increase due to the heat accumulation, which may influence the performance, lifetime and safety of the battery [54,66].

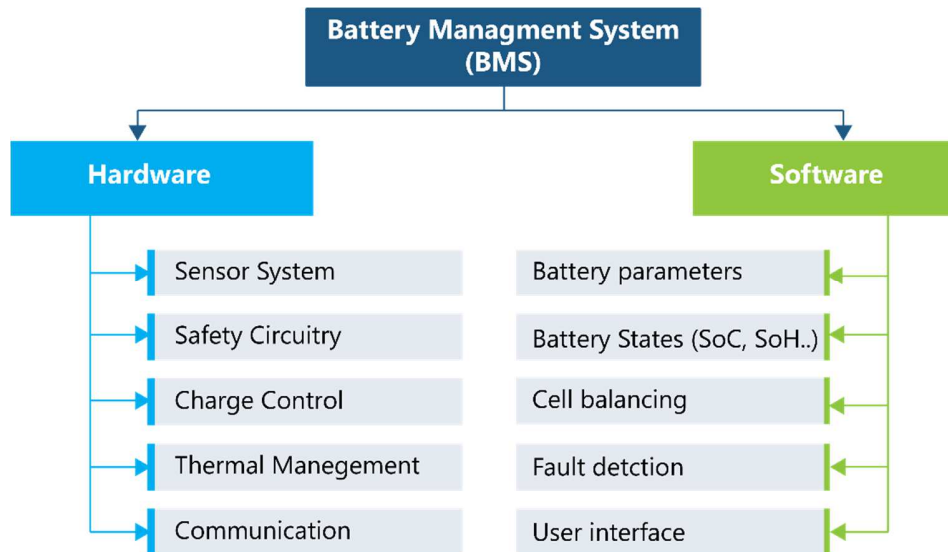

Fig. 6. Framework of battery management system for EV

Battery overheating can be caused by a short circuit and/or at excessively high ambient temperature which can result in energy loss, power degradation and thermal runaway [67]. Otherwise, low temperatures can increase the internal resistance and reduce the service life, and state of charge (SOC), an increase in lithium plating, and a reduction in disposable capacity [68]. A non-uniform temperature inside the battery can also affect its performance [69]. Various techniques have recently been developed to preheat or cool the battery before charging and discharging cycles [70,71]. According to Pesaran et al. [69], the battery thermal management system (BTMS) is a combination of four systems:

- cooling system to remove heat from the battery;
- heating system to ameliorate the battery temperature when the temperature is too low;
- isolation to control sudden fluctuations of the battery temperature;
- ventilation system to eliminate dangerous gases from the battery.

3.2. Battery thermal management system

Kim et al. [63] classifies the available cooling systems according to thermal cycle mode as summarized in Fig.7. The BTMS with a vapour compression cycle (VCC) involves cabin air-

cooling, second-loop liquid cooling and direct refrigerant two phases cooling. The BTMS without VCC contains phase change material (PCM) cooling, heat pipe cooling and thermoelectric element cooling. Several EVs include a VCC due to its ability to use available AC systems to cool or heat the battery. However, this system consumes a considerable quantity of energy to drive VCC system and has a negative impact on the performance of the EV's air-conditioning system. PCM cooling systems can be designed to remove heat from the battery during the phase transition without energy consumption. However, several problems (low conductivity, volume change, leaks, etc.) have to be addressed in order to integrate PCM system into EVs [72]. The heat pipe cooling system can efficiently control the battery temperature, but it is necessary to connect it to a cooling plate due to the reduced contact area with the battery. Currently, thermoelectric element cooling system cannot be installed in EVs due to its low efficiency. Preheating methods can be split into two groups—external and internal heating – depending on the sources of heat [61].

3.2.1. External heating strategies

External heating methods can be categorized into two groups, namely the methods combined with cooling system and electrothermal elements methods. The first group include air-based, liquid based, and PCM-based systems. Air preheating method is widely used in EVs owing to simple configuration and low costs. For instance, Honda Insight and Toyota Prius [73]. However, air ventilation requires additional materials such as a fan and a fluid circuit, which may increase the size and cost of the BTMS [74]. Liquid-based method is commonly used in EVs, for instance Volt [75] and Tesla Motor [76] adopt this method to heat battery. Thus, this method has the benefit of high thermal conductivity and heat capacity which can generate uniform temperature distribution [77], but involve a more complicated device [78].

PCM is known to be an efficient and innovative solution for heating the battery during phase change while optimizing energy, maintaining temperature uniformity, and enhancing the battery life [71]. Currently, PCM methods have not been used in EVs, and only studied in laboratories due to several factors such as thermal properties degradation, low thermal conductivity, risk of leakage, and change in volume. In the meantime, many experiments have been carried out to

show the efficiency of this technology [79,80]. However, additional studies are required to thoroughly investigate the advantages and disadvantages of PCMs.

Elsewhere, electrothermal methods include Peltier effect methods, electrothermal plates, electrothermal jackets, and electrothermal films [61,68]. The approach based on Peltier effect mechanism can be used as an active BTMS to heat the battery pack while effectively regulating the temperature. [68]. Meanwhile, this method has been widely investigated and adopted in EVs for battery preheating [81]. The electrothermal plate implements positive temperature coefficient (PTC) materials by using a temperature-sensitive semiconductor system to self-regulate temperature, which can maintain a steady temperature during heating, prevent overheating and ensure the safety of battery operations [61]. Electrothermal plates are generally placed on or under the battery pack. However, earlier EVs like Mitsubishi MiEV [82], and Nissan LEAF [83] have adopted this approach. The electrothermal jacket is usually built around each battery cell using resistive heater. This heating system is effective to recover the battery to the normal working temperature range with uniform temperature distribution and acoustic stability in about ten minutes [84]. Nevertheless, at high temperatures, the jacket makes the battery very extremely difficult to dissipate heat [61]. Electrothermal film system requires small metal foil shielded and positioned on each cell's largest surface. This method is simple, easy to install, and can be faster to heat the battery in comparison with electrothermal plates [85]. One of the strict drawbacks of this method is that it is only suitable for square battery cells and cannot be self-controlled. Furthermore, the safety and reliability of this method should be further investigated.

3.2.2. Internal heating strategies

In contrast to external heating strategies, internal heating will produce high a rate of temperature rise (RTR) and don't be affected by the battery design [61]. Thus, the internal preheating process is therefore complex, and can trigger battery pack protection issues. However, internal heating strategies include self-heating [86] and current excitation preheating. For self-heating methods, it can be assumed that high temperature rates can be expected but with low safety and temperature accuracy. Meanwhile, this method was only studied in a lab environment and not explored in EVs due to safety and consistency problems at the battery pack level. Current excitation strategies may be categorized as direct current preheating (DC), alternate current preheating

(AC) and pulse preheating strategy. DC preheating means that the battery is heated by a permanent DC from the battery power. Since no additional equipment is required, this method is easy to implement, and its cost is relatively low. However, to reduce the preheating period, this process requires a high discharge rate and thus raises the risk of battery degradation [87], the battery capacity losses and lithium plating [88]. As such, this method is rarely used and still under development [89]. AC preheating can also heat the battery faster and more efficiently compared to DC heating with a limited duration [90], while applying an AC to the positive and negative electrodes of the battery with a particular frequency and amplitude [91]. Nevertheless, it remains uncertain how alternative power impacts on battery safety, which could be a restricting element for use in EVs. In pulse preheating strategy, the battery is generally heated by applying a discontinuous constant current for creating heat across the battery's internal impedance. Pulse preheating can provide uniform preheating and less battery capacity loss compared to air preheating [92], and electrothermal plate preheating [93]. Since a circuit control system is required and can result in high costs. The pulse preheating technique is not applied for EVs and only in the lab environment.

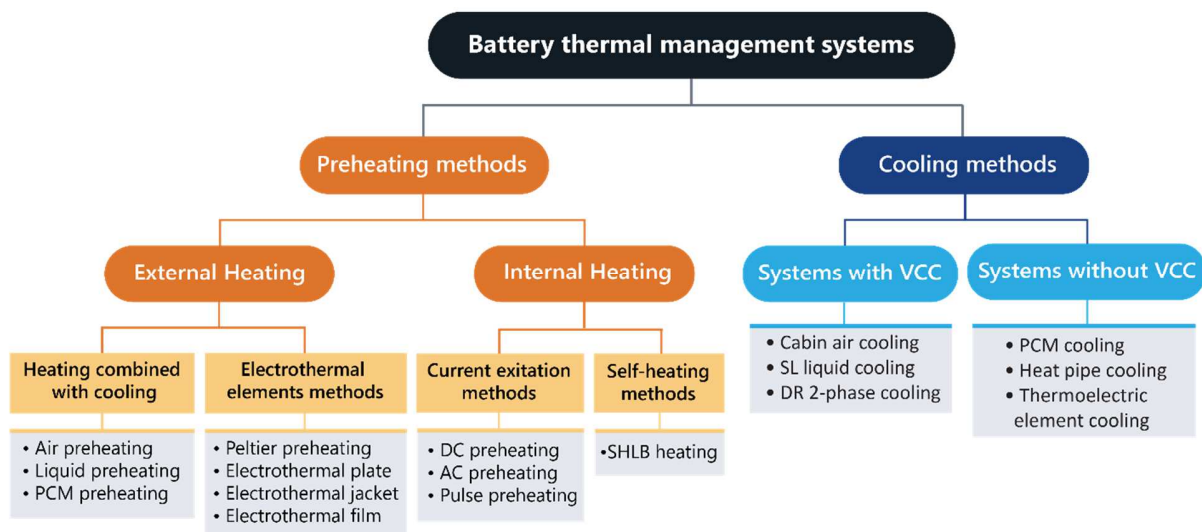

Fig. 7. Classification of battery thermal management systems

Today, range anxiety is one of the major barriers to widespread EV adoption. The ability of a BMS to accurately predict the current and future battery status, and therefore the estimated driving range, will alleviate this problem and open up vast opportunities in battery

manufacturing, usage and optimization [94,95]. State of Charge (SOC), State of Health (SOH) and remaining useful life (RUL) are the most critical battery cell states [96,97]. Otherwise, modelling the dynamic and internal behaviour of battery cell is crucial to track these states. Whether research on the internal battery cell structure is thorough, the battery cell model can be divided into three main approaches: White box model which developed from battery mechanism and law [98,99]; Gray box model that has an unclear perception of the relevant system laws, most typical gray box model are equivalent circuit model (ECM) [100,101] and electrochemical model (EchM) [102]; Black box model is data-driven method as they rely on data sets and artificial neural networks [103]. The following section presents an exhaustive review of recent battery states estimation methods.

3.3. Battery states estimation methods

SOC, SOH and RUL are particularly the key battery management parameters and are generally defined as:

$$SOC = SOC_0 + \frac{\int_0^t I(t)dt}{C_{nom}} \quad (1)$$

$$SOH = \frac{C_{full}}{C_{nom}} \times 100 \% \quad (2)$$

Where SOC_0 is the initial battery state of charge, C_{full} Is the battery's fully charged capacity, C_{nom} is the brand-new battery nominal capacity [50]. In essence, SOH reports battery aging and degradation and alerts when the battery should be replaced. When capacity is degraded to 80% of the current capacity, the battery is considered unusable for vehicle applications and should be replaced [104]. While SoC reflects the available battery capacity that can be removed from the battery and is used to avoid over-discharge or overcharge and to run the battery in a way that eliminates aging effects. Meanwhile, RUL predicts the remaining time or number of battery cycles until the battery's SOH reaches 0%. Reliable estimation of remaining useful life (RUL) would enable the use of batteries to their full capacity and optimum life expectancy until replacement or disposal. The accurate and real-time prediction of these three states have attracted the attention of several scientists, and several different approaches were proposed to forecast

them [104,105]. In summary, battery states estimation methods can be categorized into five main categories as displayed in Fig.8, including direct method [106,107], model-based methods [108,109], adaptive-filter algorithm [110,111], machine learning (ML)-based methods [59,112], and other methods [113,114].

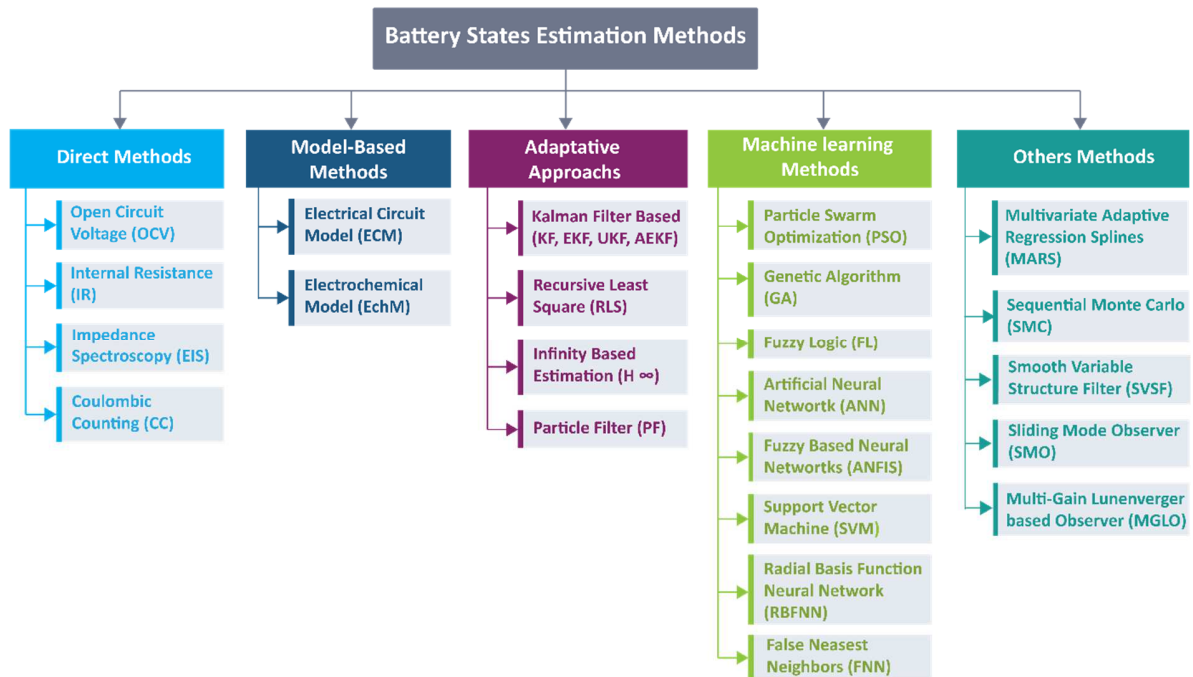

Fig. 8. Classification of SOC, SOH and RUL predictions methods

3.3.1. Direct methods (Conventional method)

Direct methods calculate physical battery properties such as current and temperature, and then forecast the battery states using an equation or relationship. Direct methods include open-circuit voltage estimation (OCV), electrochemical impedance spectroscopy (ELS) and coulomb counting estimation (CC) (also known as the ampere-hour balancing strategy) [115].

3.3.1.1. Open circuit voltage-based estimation (OCV)

The voltage of the cell is continuously determined, and the corresponding states are derived from a table or curve. For instance, a linear relationship existed between OCV and SOC. This relationship generally depends on capacity and material of the battery [116], and differs from

each type of batteries [117]. Similar relationship exists between SOH and OCV [118]. **Fig.9** presents OCV-SoC relationship for LiNiCoMnO₂ battery at different C-rates charging values. Example of OCV method applications in predicting SOC and SOH states is presented in [119,120]. Meanwhile, this method is not practical for online testing during charging/discharging since the battery requires to have a long time resting to reach equilibrium condition [120]. Also, OCV method is not accurate due to the hysteresis characteristics of the battery [121].

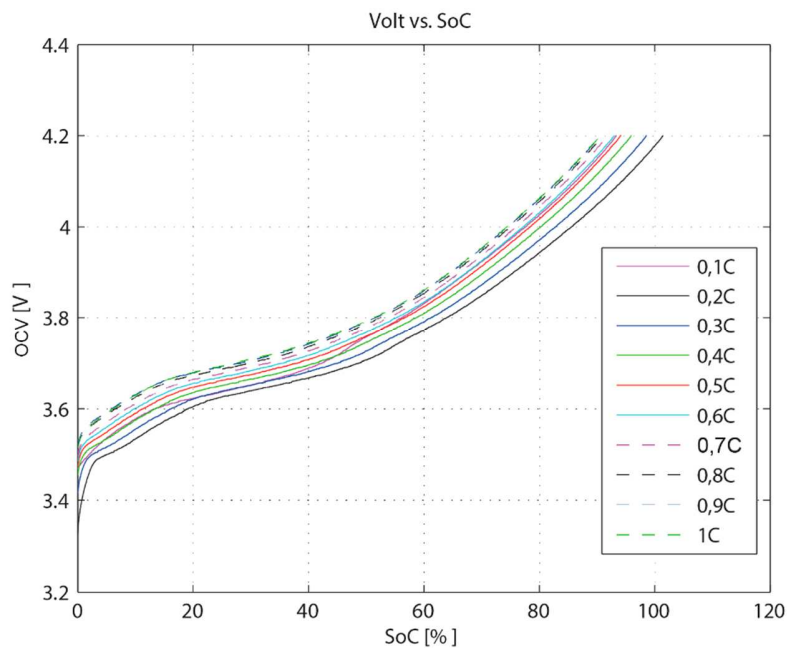

Fig. 9. OCV-SoC relationship for LiNiCoMnO₂ battery during the charge process at different current values [122]

3.3.1.2. Coulomb counting estimation (CC)

Coulombic counting approach is widely used to estimate dynamic states of battery. It is based on time-dependent integration of battery current during the charge and discharge of the battery. This method is simple, easy and widely used for estimating the battery states particularly the SOC and SOH [106] since it is the most accurate technique for short-term calculations. Nevertheless, the main drawback of coulomb counting method is that it cannot estimate the initial value, and has an accumulative error [123]. Also, its precision is highly impacted by uncertain variables and disturbances such as noise, temperature, current, etc [124]. Moreover, this method is usually combined with other techniques.

3.3.1.3. Electrochemical impedance spectroscopy (EIS)

Electrochemical Impedance spectroscopy is a commonly used measurement method in laboratories for characterizing battery cells. It estimates cell impedance using a sinusoidal AC excitation signal over a wide range of frequencies [125]. And then, the SoC and SOH of battery can be predicted owing the strong dependency between dynamic states of battery and the variation of the low frequency impedance of EIS [126]. Implementations of onboard impedance measurements in vehicular applications were proposed by several authors [107,127,128]. In [107], authors propose an onboard EIS measurement system while using a power amplifier to generate a separate excitation signal. Similar work found in [127], where author show how the state of charge can be estimated with impedance spectra and a simplified equivalent circuit. However, this technique requires additional hardware, and the implementation costs are extra. Meanwhile, a new framework for onboard impedance spectroscopy on cell level which incorporates a passive method without the need of an additional active signal generation is developed in [128]. Thus, this framework can be simply integrated in a single-cell BMS architecture for electric and hybrid vehicles.

3.3.2. Model-based estimation methods

The development of battery model is highly required in order to have online states prediction. Model-based approaches incorporate a model of battery with various advanced algorithms for predicting the state of the battery from calculated variables including current, voltage and temperature. The most common use of battery models involves electrochemical model and equivalent circuit model.

3.3.2.1. Electrical circuit model-based estimation (ECM)

Electrical circuit model (ECM) has the advantages of low computational complexity and high precision [129]. It can also slightly describe the battery cell's internal reaction process. There are three different ECMs such as first-order RC model, first-order ECM, and second-order ECM. These models are widely adopted due to their excellent dynamic performance [130]. **Fig.10** presents the schematic diagram of second-order ECM, where U_{OCV} represents the open-circuit voltage, which has some correspondence with the battery cell SOC. I_C the current of the battery cell. U_{P1} , U_{P2} are the polarization voltage corresponding to the RC link. R_0 is internal resistance.

R_{p1} and R_{p2} are the polarization resistances while C_{p1} , C_{p2} are the polarization capacitances. However, the two RC links can characterize the battery polarization and diffusion effect. And finally, U_t represents the terminal voltage of the battery cell.

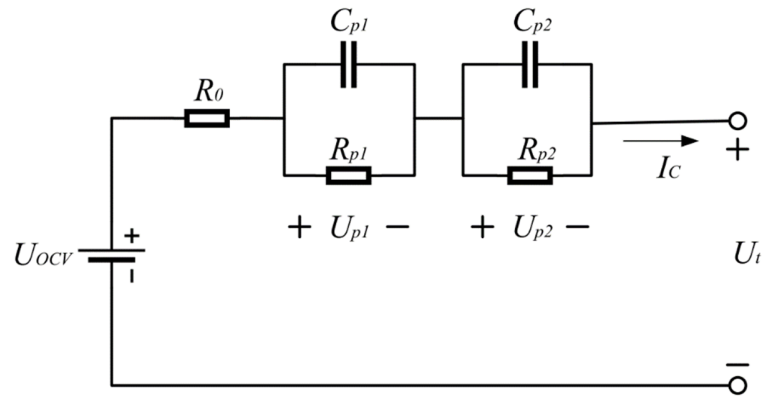

Fig. 10. Schematic diagram of second-order ECM [129]

According to the second-order ECM described above, a variety of adaptive filter algorithms [131] can be used to online obtain the battery cell SOC accurately. However, the parameters of the second order ECM can be calculated with different datasets depending on the scenario where the model will be used, as in [132]. Meanwhile, improvement of the accuracy of dynamic response prediction of this model can be obtained by increasing the number of parallel R-C pairs. ECMs were extensively investigated in literature. A comparative study of the three mentioned ECM models is presented in [130] using a combination of ECM with extended Kalman filter (EKF) and CC estimation strategy. This paper reveals that the second order ECM is the most reliable and dynamically efficient, but it is also the most complex of these three models. In [133], another ECM model is proposed for the SOC and SOH estimates which reflect both aging and temperature effects. This strategy does not require the battery model or any awareness or estimate of the battery parameters. In [134], twelve widely used lithium-ion battery ECMs are tested, using a multi-swarm particle swarm optimization algorithm to determine optimal configuration parameters for all Li-ion battery cell types. From this study it can be inferred that the first-order RC configuration with one-state hysteresis is suitable for LiFePO₄ battery due to its high accuracy.

All of the above works have only focused on estimating the battery states at cell levels. Despite this interest, investigating all the battery pack states still poorly discussed. However, given cell inconsistency, an online SOC estimate strategy is presented for aged lithium-ion battery pack in [129]. Results show that the SOC estimation error of each cell in the battery pack is 5% for the entire test cycle and 3% for the later capacity estimation process. However, the structure of the ECM model is mainly empiric dependent and does not accurately describe battery electrochemical processes. Thus, under battery discharging/charging experiments, all above-mentioned parameters are defined and restricted for new batteries in the laboratory, which is costly, time-consuming, and often not practical to obtain all parameters [122]. Otherwise, according to literature, the ECM seemed to be able to provide relatively satisfactory voltage and SOC results in the high and middle SOC area, but in the low SOC area the model accuracy was seldom indicated. The lowest SOC value in experimental validation was generally determined not less than 10% [135], which evidently affects the accuracy of the ECM under 10% SOC [102].

3.3.2.2. Electrochemical model-based estimation (EChM)

Electrochemical models (EChMs) generally use the equations describing physicochemical processes such as battery diffusion, intercalation, and electrochemical kinetics inside the battery as illustrated in Fig.11. The EchM can be represented as (eq3):

$$U = U_{OC} - U_R - U_P \quad (3)$$

where: U is the battery terminal voltage, U_{OC} is the OCV of the battery, U_R is the potential resistance difference, and U_P is the electric potential of polarization process. By determining the battery model parameters, the battery status can be easily monitored through the lookup table [136]. Since the model is a set of multi-parameter partial differential equations, the resolution process is computer-prohibitional and cumbersome. So, they are hard to implement in BMS. Despite of that, EchMs are practically used to evaluate battery efficiency, and are ideally suited to optimize the physical and material properties of internal electrodes and electrolytes [137], and its application is limited for online estimation.

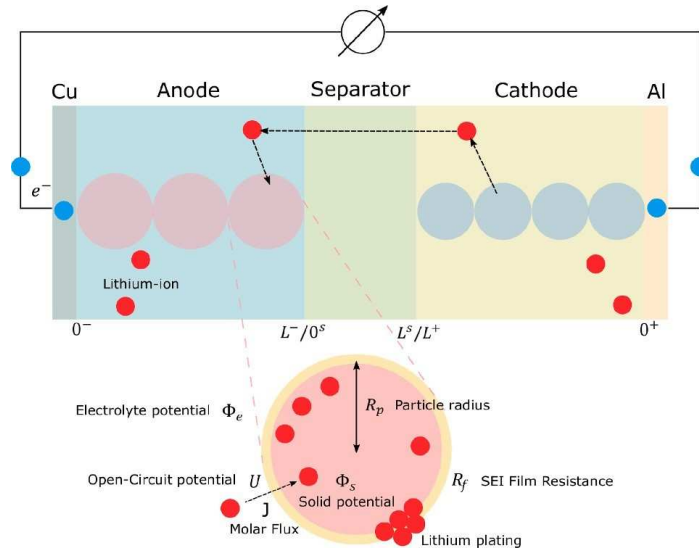

Fig. 11. Schematic of the electrochemical model for LIBs [138]

Several EChMs that can be used for battery states forecasting namely SOC has been recently proposed in literature [139,140], all these papers do not present the SoC estimation process. However, different approaches presented in [141,142] precisely establish EChMs for SoC estimation. For instance, [141] developed a model that consists of four submodels representing electrical, electrochemical, thermal, and aging dynamics in partial differential equations. A work in [142] introduces a reduced-order electrochemical model adopted in dual-nonlinear observers to predict SoC and cyclable lithium loss over time. Another technique for SoC estimation presented in [143], where a non-invasive optimization strategy is introduced to estimate the EChM parameters for any battery lifespan. Extensive investigation is required to accurately identify model parameters, since these parameters vary considerably in electrode chemistry, electrolytes, packaging and time, and the cells are usually heterogeneous in battery package parameters and temperature. Which results in low accuracy and computational complexity [122]. In contrast, a recent paper has been published [138] where the sensitivity of 26 lithium-ion EChM physical parameters was analysed for lithium-NMC-graphite battery cells in real-world EV driving cycles. From this paper it can be inferred that the inaccurate identification of these parameters has no effect on the functionality of BMS, especially SoC identification, and the parameter identification method should focus only on 14 sensitive parameters. The benefit of EChMs is that they implicitly provide battery behaviour dependency on battery states and

temperature, resulting in high precision, although electrical models must store their parameters for various SoC and temperature combinations [122]. Meanwhile, both model-based approaches are usually computationally expensive, and additional parameters or multiple models are normally needed for specific operating conditions. Thus, adaptive methods listed below will attempt to reach this condition.

3.3.3. Adaptive filter algorithms

For improved safety and more effective estimation, model parameter values should be continuously updated. Adaptive filters typically use feedback to alter their current output from various inputs and attempt to adjust accordingly [110]. Adaptive algorithm such as Kalman filter have been proven to accomplish this [144], combining direct and model-based approaches.

3.3.3.1. KALMAN filters-based estimation (KF)

Recently, Kalman filters (KFs) have been the most commonly used adaptive approaches, and their self-correction and online computing capabilities have proven effective in all battery states estimation including SOC, SOH, and RUL. Kalman Filter is series of mathematical equations, which repeatedly forecasts and corrects a new condition as the system operates [145]. The method contrasts input and output data to determine the correct mean square variance of the real state. So, the KF model mainly comprises a process equation (4) which estimates the current state x_k from the earlier state x_{k+1} and a measurement equation (5) which updates the current state to converge it to the real value [145].

$$x_{k+1} = A_k x_k + B_k u_k + w_k \quad (4)$$

$$y_k = C_k x_k + D_k u_k + v_k \quad (5)$$

Where x is the system state, u is the control input, w is process noise, y is the reference for measurement, v is measurement noise, A , B , C and D represent time variable covariance matrices and define system dynamics [145]. Some publications in literature propose KF Based methods for battery states estimation [146,147]. For instance, [146] applied KF on a simple ECM of the lithium-ion battery on Matlab-Simulink software, and the SOC is determined with an error being less than 5%. The work developed in [147] fully describe a combination of KF with open-circuit voltage and coulomb counting methods. The results indicate that KF implementation

improves the accuracy of coulomb counting strategy in forecasting the SOC of lithium-ion batteries with an error of $\pm 1.76\%$. Elsewhere, several extensions have been suggested, including extended Kalman filter (EKF) [148], unscented Kalman filter (UKF), cubature Kalman filter (CKF), and the adaptive extended Kalman filter (AEKF) [149]. Zheng et al. [150] implement the EKF to determine the SOC based on a second-order resistance-capacitance model. In an electrochemical model, Lee et al. [151] applied dual EKF to predict the SOC and capacity. The outcome reveals that the model is better accurate than the real value, with a smaller initial error of $\pm 5\%$. In [152], a fractional-order UKF has been developed to estimate the SOC. Similar approach with support vector regression (SVR) is applied in [153] to estimate SOC and SOH. Results indicate an estimation error under 1%. Peng et al. [154] apply a CKF to forecast the lithium-ion battery SOC based on a first-order RC model and corresponding fractional-order model. The findings revealed that the CKF is more effective and stable than the UKF and EKF. EKF algorithm with multi-time scales has been used in [155] to predict the SOC and battery capacity in different time dimensions. Similar work is presented in [156], where the multi-time scale extended Kalman filter approach is applied based on "S&D" model to estimate each cell's SOC, model parameter, and capacity in the battery pack. Findings indicate that each cell's SOC prediction error in the battery pack is below 5% over the entire test cycle and below 3% while the latter capacity estimation process stays constant. From this study it can be concluded that the multi-time scale adaptive filter algorithm can achieve high accuracy while reducing the computational complexity. Another KF algorithm improvement is presented in [157], where an adaptive unscented Kalman filter (AUKF) introduced to determine the battery internal parameters and estimate SOC. Zeng et al. [158] developed an adaptive cubature Kalman filter (ACKF) to predict the SOC. Results indicate the high estimation accuracy and fast convergence of ACKF compared with CKF. Xu et al. [159] apply a dual Kalman filter (DKF) and dual extended Kalman filter (DEKF) to predict the SOC. Then, combining the strengths of DKF and DEKF methods, an SOC estimation algorithm based on adaptive Kalman double filter is suggested. Comparative analysis tests show that the proposed algorithm error is inside the range of ± 0.01 under most test conditions and will instantly restore SOC to true value if system errors occur. This, verify the validity, accuracy, robustness and adaptability of the proposed algorithm under different operation conditions.

3.3.3.2. Recursive least square based estimation (RLS)

Recursive Least Square (RLS) is an effective technique that is used to determine the filter coefficients for a minimal square of the error signal in dynamic adaptive models [122]. In particular, RLS algorithm is used to obtain model parameters [160,161]. For instance, in [162] a forgetting Factor Recursive Least Squares (FFRLS) is applied to realize online identification of ECM model parameters. The results show that the maximum estimation error of SOC and SOH is 1.08% and 1.52% respectively, which prove the accuracy of the proposed method. Zhang et al. [111] proposed different decoupled weighted recursive least squares (DWRLS) method to separately predict the battery parameters and SOC. Results indicate that DWRLS method achieves good accuracy with about 1%. All the aforementioned works show that the RLS can help reducing the estimated SOC error and noise, while reducing the computational cost.

3.3.3.3. Particle filter (PF)

Particle filter (PF) method is a set of Monte Carlo algorithms widely used to approximate the probability density function (PDF) of a non-linear system. In [163] PF is used to estimate high-power lithium-ion battery SOC while considering the impact of drift noise temperature, charging/discharge rate and running mileage. The numerical calculations demonstrate that the proposed method is efficient to reduce the maximum absolute error (MaxAE) and Root Mean Squared Error (RMSE) by 30.2% and 12.6% respectively. Ye et al.[164] proposed a novel double adaptive particle filter method to adapt to environmental variety. In this model a double-scale dual adaptive particle filter is used to improve the efficiency and convergence ability according to the initial environmental offset. The results demonstrate the effectiveness and applicability of the proposed approach are verified by aged batteries. Chen et al. [165] proposes a particle filter based OCV online estimation method to achieve the voltage-based state of charge. A framework for state-of-charge prediction is proposed in [166]. Where the unscented particle filter (UPF) is employed to improve the observation accuracy. The results indicate high precision and fast convergence of the proposed method under dynamic driving cycles. Another study presented in [167] where a hybrid cubature particle filter is applied by aggregating the cubature filter and particle filter to achieve a more stable SOC prediction under harsh charging & discharging schedules. The findings indicate that the proposed hybrid method is more robust than the existing models.

3.3.3.4. H infinity-based estimation (H_∞)

H infinity (H_∞) based method is a powerful theory to restrict the effect of exogenous disturbances on output. It is a simply designed model, which has the strong robustness to ensure SoC estimation accuracy under certain conditions [168], especially in the worst cases [169]. Zhang et al. [170] introduced the H_∞ based method to predict the SOC of lithium-ion batteries, considering the temperature, current, state of health as a time-varying parameters. The proposed system provides better accuracy with an acceptable 2,49% error. Similarly, a universal linear model based on adaptative H_∞ filter (AHF) is implemented in [171] to determine the SOC, considering the model parameters as a function SOC. Results confirm that the AHF performs accurately better than other adaptative methods. In addition, other recent researches demonstrate that H-infinity algorithm can be efficiently used to develop online SoC estimators, at both cell and pack levels [172,173]. Elsewhere, effects such as aging, hysteresis and temperature could deviate the model accuracy. Wang et al. [174] set up dual-estimator-based joint estimation framework to investigate the SOC estimation under the influence of temperature deviation. On this basis, recursive least square (RLS) and the adaptive H infinity filter (AHIF) are joined and used. The result indicates that RLS-AHIF algorithm has better accuracy for SOC estimation even at low temperatures, such as -10°C , and the SOC error is within 3.5%, while the maximum error of SOC is less than 2% at 0°C and 25°C . Likewise, Shu et al. [175] proposed an adaptative fusion algorithm to calculate the SOC of lithium-ion batteries applying both RLS and H-infinity filter to identify parameters of the built equivalent circuit model and to predict the battery state of charge and to cope with uncertainty of model errors respectively. Experimental results reveal that the fusion estimation algorithm has maximum absolute error of less than 1.2%. Demonstrating its efficiency and reliability when exposed to internal battery loss and operating temperature variability.

3.3.4. Machine learning based methods (ML)

In the past few years, machine learning methods have drastically attracted extensive attention because of the increasing availability of large quantities of battery data [176,177]. Machine learning is a promising approach for forecasting the battery states such as SOC, SOH and RUL with no underlying physical knowledge. Thus, machine learning based methods consider the battery as a black box and learn its internal dynamics through charge-discharge data to determine

the nonlinear relationship between the battery states and measured variables. Machine learning approaches include neural network, support-vector machine, random forest and regression techniques. A summary of the most useful machine learning algorithms to predict SOH, SOC, and RUL is provided in [59]. The following Fig.12 displays the machine learning approach for SOC, SOH and other battery states prediction.

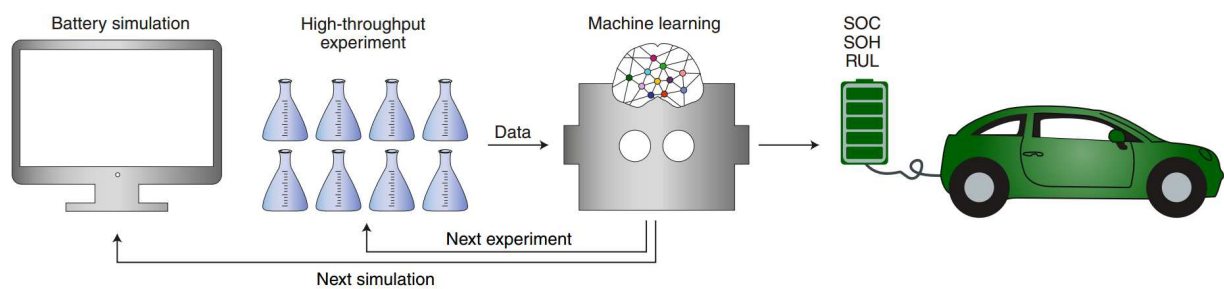

Fig. 12. A machine learning approach for SOC, SOH and RUL predictions of li-ion batteries [59]

Guo et al. [103] has implemented a stronger neural back propagation network (BP), in which the measured voltage, current and temperature are used as the input to approximate the battery SOC. The robustness of this BP neural network was improved by [176] while injecting the Gaussian noise into the training data. In [178], recurrent neural networks (RNNs) are introduced to predict the battery SOC from past charge-discharge data. An extension of this RNNs model known as stacked long short-term memory (LSTM) network was implemented by Yang et al. [177] and Chemali et al. [179] for SOC estimation. Similar approach was developed in [180]. Unlike BP network, both the RNN and LSTM networks connect the current SOC to the previous state, thus achieving better prediction accuracy. In [181], a new method for accurate SOC estimation using Recurrent nonlinear autoregressive with exogenous inputs (RNARX) neural network algorithm is presented, and the computational accuracy of RNARX is enhanced by employing lightning search algorithm (LSA). The experimental results prove that the proposed approach is accurate and robust as it can accurately predict SOC under different operating conditions. In [182], Gaussian process regression is applied to forecast the SOC of Li-ion batteries. Results show that Gaussian processes method outperform support-vector machine with a SOC prediction error of 0.8%. Another ML-based method widely used in industry is the neural network. This method

provides the highest quality adaptation function, particularly where a large amount of data is available. In [183], a generalized neural network model to predict SOC is presented. High accuracy level is attained by this model with SOC estimation error of 0.1%. Machine learning approaches provide high deep-learning capabilities compared to other conventional methods, and learning accuracy progressively increases as historically learned information accumulates. Thus, the accumulated operational data on EVs and the development of new connectivity techniques such as vehicle-to-cloud (V2C), vehicle-to-vehicle (V2V), and vehicle-to-infrastructure (V2I) [184] will undoubtedly offer wider a wider range of future implementations of these methods. The principal limitations to ML-based models are time-consuming in collecting training data which is more than six months' worth [185], poor model accuracy as setting and testing conditions vary from training data. Elsewhere, estimated results probably suffer evident fluctuations due to overfitting or underfitting [186]. Fusing model-based filtering methods and ML-based methods are therefore required to obtain more accurate and robust battery states estimation [187].

3.3.5. Others approaches

Whilst some strategies do not fall into the previously proposed categories, it is highly important to mention them in this review. So, other battery states prediction methods may include, Multivariate Adaptive Regression Splines (MARS) [113], Sequential Monte Carlo (SMC) [188], Smooth Variable Structure Filter (SVSF) [114], Sliding Mode Observer (SMO) [189], and Multi-Gain Lunenverger Based Observer (MGLO) [190]. **The table.1** below gives a summary of all methods for forecasting the li-ion battery states, their advantages, disadvantages, and the average error for each method.

Table 1. Summary of li-ion battery states estimation methods, their advantages, disadvantages, and average error

Battery States Estimation Methods		Strengths	Weakness	Output estimated error ^a for each state (%)			Ref.
				SOC	SOH	RUL	
Direct Methods	OCV	Easy to implement	Long rest time needed to reach equilibrium		1		[191]
	EMF	Simple, low cost	Take a long time to interrupt the OCV relaxation model	2			[192]
	CC	Easy to implement, low computational complexity	Difficulty assessing SOC's initial value	4	1-9		[123,124]
	EIS	Online, low cost, high accuracy achieved if impedance value is normalized.	Results influence aging and temperature		2.1		[193]
Model-based methods	ECM	Online, High precision	Highly depends on model accuracy	5			[129]
	EChM	Online, High accuracy	Complicated, Heavy calculations	5			[194]
Adaptive Filter algorithm	KF,	Accurate, high degree of noise can be filtered	High computational complexity	1.76	5		[147,195]
	EKF	Good precision in predicting non-linear dynamic state	Limited robustness.	1			[196]
	UKF	Simple to implement	Poor robustness	4			[197]
	SPKF	Good accuracy and robustness.	Complicated, Heavy calculations	2			[198]
	(RLS)	High accuracy	Heavy computation, instability	1.08	1.52		[162]
	(H inf)	High accuracy, low computational cost	Accuracy deviates due to aging, hysteresis and temperature effects	2.49			[170]
	PF	High precision, less processing time	High calculation	1-2	2	4.08	[167,199,200]
Machine learning Methods	PSO	Good accuracy	Low convergence rate	3		3-9	[201,202]
	GA	High precision, Robustness against noisy function,	Heavy computation	2			[203]
	FL	Adaptability to non-linear battery behaviour	Heavy computations	5	1.4-9.4		[204]
	SVM	High accuracy, lest prediction time	High complex calculation	0.2	1.6	3.3	[153,205,206]
	NN	High accurate estimation	Require processing unit	0.1	0.5	0.6	[183,207]
Others	MARS	High accuracy	Accuracy disperses at the beginning and end of SOC period.	1			[113,208]
	SMO	Stability and robustness	Difficult to adjust switching gain to control sliding regime	3			[209]
	PDF	Easy to implement, quick response	Require high accuracy measurement.		2		[210]
	Bayesian	High accuracy		0.8		3.2	[182,185]

^a Error is estimated from the approach described in the 'Battery States estimation methods' section

3.4. Methodologies for battery cells characterisation

Over the past decade, lithium-ion batteries have gained considerable interest within the battery community due to their high energy density, high efficiency, long life cycle, and low maintenance. Currently, Li-ion batteries dominate the energy storage industry with 55% market share [211], with dramatic downturn in Li-ion battery pack costs, falling about 87% from 2010 to 2019, reaching a volume-weighted average of 156 \$/kWh [212]. However, its development still faces several issues depending on an in-depth understanding and insight into the complex mechanism and elusive chemical/physical processes of a cell during discharge and charge via advanced characterization techniques. Therefore, improving battery performance and lifetime, studying structure and chemistry impacts on LIB performance is critical [213]. With the recent development of a third-generation synchrotron source, various advanced characterization techniques have been explored, such as: Synchrotron X-ray techniques, neutron scattering techniques, solid-state NMR techniques [214,215]. These tools represent an important step forward as researchers can now obtain a more detailed understanding of how electrochemical processes affect individual battery components under real working conditions. Meanwhile, such approaches are very expensive and require a high level of expertise. Elsewhere, non-invasive characterization tests have been widely used by both industrial engineers and academic researchers to compare the cell capability and track its performance evolution during different operations. The purpose of these tests is to make full use of the measurable electrical and thermal signals from a lithium-ion cell to provide a comprehensive overview of its internal aging without disassembly. Typically, these methods include capacity tests, open-circuit voltage tests, electrochemical voltage spectroscopy tests, internal impedance/resistance tests (see Fig.13). The measurement of cell capacity generally used to determine maximum capacity in applications with a defined load, while OCV measurements provide crucial information on a thermodynamic cell's property. Resistance tests, therefore, describe cell dynamics. Numerous international standards for characterization and electrical test of lithium-ion cells are well examined and explored in [216]. Therefore, the various testing methods are compared through four criteria: test equipment needs, generated data, knowledge usage and description of the key advantages and disadvantages of each method (see Table.2). However, there is no 'one-size-fits-all' testing

process. Practitioners should describe their aims and required data, and then recognize which characterization test can best achieve them. Moreover, as Li-ion cells rise in demand and usage, it is expected that application-specific characterization tests will increasingly become more relevant for future development.

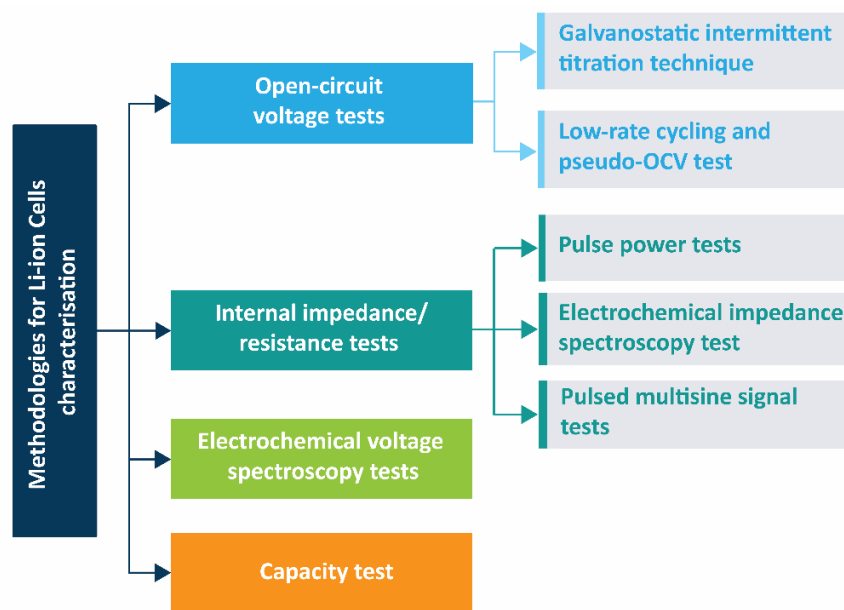

Fig. 13. Methodologies for battery cells characterization

Table 2. Summary of test methods for lithium-ions battery characterization [216]

Test methods		Equipment required	Data generated	Data extracted	Duration of test (h)	Factors impacting results	Application of test data	Advantages	Drawbacks/cautions
Capacity tests	(≥ C/3)	Battery cyclers	<ul style="list-style-type: none"> ➤ Voltage variation under various charge/discharge current 	<ul style="list-style-type: none"> ➤ Capacity ➤ Energy ➤ Temperature increase 	3-8	<ul style="list-style-type: none"> ➤ Charge and discharge rate ➤ Temperature 	<ul style="list-style-type: none"> ➤ Validation of cell accuracy. ➤ Development et validation of ECM and thermal model. 	<ul style="list-style-type: none"> ➤ Simplicity. ➤ Short test duration ➤ Use of standard battery cyclers 	<ul style="list-style-type: none"> ➤ Important temperature rise during test influences capacity measurement ➤ Cells exposed to high over potential, leading to degradation
	(< C/3)	High-precision battery cyclers		<ul style="list-style-type: none"> ➤ Thermo-dynamic capacity 	10-100	<ul style="list-style-type: none"> ➤ Charge and discharge rate ➤ Temperature 	<ul style="list-style-type: none"> ➤ EchM and ECM modelling ➤ SoC prediction ➤ Define degradation processes 	<ul style="list-style-type: none"> ➤ Widespread use of data ➤ C/10 enables EVS analysis and pseudo-OCV according to cell type 	<ul style="list-style-type: none"> ➤ High-precision battery cyclers required. ➤ Long test duration
Open-circuit voltage tests	GITT	Battery cycler	<ul style="list-style-type: none"> ➤ Voltage relaxation after short charge/discharge pulses 	<ul style="list-style-type: none"> ➤ Actual OCV vs. capacity ➤ OCV hysteresis 	> 100	<ul style="list-style-type: none"> ➤ Temperature ➤ Relaxation period after charge/discharge ➤ Charge discharge rate 	<ul style="list-style-type: none"> ➤ EchM and ECM modelling ➤ Performance degradation ➤ Identification of degradation processes 	<ul style="list-style-type: none"> ➤ Actual cell OCV measuring ➤ Actual OCV hysteresis ➤ Use of standard battery cyclers 	<ul style="list-style-type: none"> ➤ Long test duration
	Pseudo-OCV tests	High-precision battery cycler	<ul style="list-style-type: none"> ➤ Voltage variation with very low (C/25) charge and discharge current 	<ul style="list-style-type: none"> ➤ Voltage vs. capacity ➤ Thermo-dynamic capacity ➤ IC and DV curves 	25–100	<ul style="list-style-type: none"> ➤ Temperature ➤ Charge/discharge rate 	<ul style="list-style-type: none"> ➤ SOC estimation ➤ ECM modelling ➤ EVS analysis 	<ul style="list-style-type: none"> ➤ Quicker than GITT 	<ul style="list-style-type: none"> ➤ High-precision battery cyclers required. ➤ Long test duration
Electrochemical voltage spectroscopy tests					25–100		<ul style="list-style-type: none"> ➤ EchM modelling ➤ Performance degradation ➤ Identification of degradation mechanisms 	<ul style="list-style-type: none"> ➤ Provides in-situ information of cell degradation ➤ Same data can be used for pseudo-OCV analysis 	<ul style="list-style-type: none"> ➤ High-precision battery cyclers required. ➤ Long test duration ➤ Requires specialist knowledge and analysis tools.
Internal impedance/resistance tests	Pulse power test	Battery cycler	<ul style="list-style-type: none"> ➤ DC voltage response 	<ul style="list-style-type: none"> ➤ Cell internal resistance 	2–12		<ul style="list-style-type: none"> ➤ Validation of cell accuracy ➤ ECM modelling ➤ Power fade definition 	<ul style="list-style-type: none"> ➤ Simplicity ➤ Short test duration ➤ Use of standard battery cyclers 	<ul style="list-style-type: none"> ➤ Only DC resistance can be measured ➤ No separation of contributions to total resistance
	EIS test	Specialised EIS equipment	<ul style="list-style-type: none"> ➤ Impedance as a function of frequency 	<ul style="list-style-type: none"> ➤ Cell impedance ➤ ECM model parameters 	2–4	<ul style="list-style-type: none"> ➤ SoC ➤ Temperature 	<ul style="list-style-type: none"> ➤ Produces impedance over a wide range of frequencies ➤ Dynamic modelling ➤ Performance degradation ➤ Identification of degradation mechanisms 	<ul style="list-style-type: none"> ➤ Strong evidence for degradation analysis ➤ Enables development of ECMs 	<ul style="list-style-type: none"> ➤ Specialised equipment required ➤ Sophisticated test setup and interconnections required
	Pulsed Multi-sine test	Battery cycler					<ul style="list-style-type: none"> ➤ EchM and ECM modelling ➤ Performance degradation 		<ul style="list-style-type: none"> ➤ Limited to lower frequency measurements ➤ Accuracy is lower than EIS ➤ Additional data processing involved

3.5. Life cycle analysis of a battery electric vehicle

A vehicle's environmental footprint needs to be assessed over its entire life span, to include the environmental costs of manufacturing and lifetime, as well as the environmental impacts of driving. It is therefore necessary to assess the carbon footprint of this type of vehicle by comparing it to others, over its entire useful life [217,218]. Numerous researchers have used the life cycle assessment (LCA) approach to compare carbon emissions between battery-powered electric vehicles with conventional vehicles [219,220]. The term "life cycle assessment" refers to all of the environmentally significant processes that occur during the life cycle of a vehicle, including raw material extraction, component manufacture, assembly, transportation, vehicle usage, and end-of-life treatment. According to the European Federation for Transport and Environment's study on battery electric vehicle life cycle analysis [219], a medium-sized vehicle with a battery produced in Europe and driven in France generates four times less greenhouse gases than an equivalent gasoline vehicle over its lifetime (i.e. after 225,000 km). Due to the numerous hypotheses taken in the realization of a life cycle analysis, a comparison of different sources is required. Similar conclusions are drawn in [218,220–222]. For instance, Teixeira et al. [218] assessed the impact of combining conventional vehicles with electric vehicles on carbon emissions in Brazil under various scenarios. They indicate that, even in the most unfavourable power generation scenario, electric vehicles release 10 times less carbon dioxide than conventional vehicles. Glitman et al. [221] conducted a carbon emission study on electric vehicles in Saudi Arabia. And reveal that for every 1% of electric vehicles implemented, carbon emissions are decreased by 5%. In the best-case scenario, introducing 1% electric vehicles reduces carbon emissions by 0.9%. Using the Hybrid LCA methodology, Xiong et al. [223] examined the CO₂ emission reduction potential of China's large-scale vehicle electrification. The findings of review indicate that individual PEVs had lower life cycle CO₂ emissions (g/km) than equivalent conventional vehicles in all scenarios. In summary, the LCA of electric vehicles could also be improved by the second life of batteries: use for other forms of mobility, for local stabilization of the electrical grid, or for other uses.

Current research directions for Li-ion batteries are to: (i) selecting elements that are naturally abundant, (ii) favouring less energy-consuming methods of synthesis by soft chemistry, (iii) or

developing electrodes based on organic materials. Furthermore, the progressive decarbonization of the electricity used in the battery manufacturing process should contribute to an improvement in their carbon balance. Other researchers have proposed the Well-to-Wheels life cycle analysis model to calculate the energy consumption and GHG emissions of several EVs [224,225]. Based on these studies it can be interfered that battery recycling and the transition to renewable power contributes to the environmental benefits of EVs.

3.6. Mining resources

Li-ion technologies appear to be one of the best alternatives for electric vehicle batteries for many manufacturers in terms of on-board power, lightweight, reliability, life span, and manufacturing cost [226]. The large-scale manufacture of batteries for electric vehicles requires the construction of very large factories (called Gigafactories), capable of producing daily thousands of batteries, equivalent to GWh of electrical energy consumption per year [227]. All Li-ion batteries are composed of a lithium-based liquid electrolyte, which interfaces between an anode, mainly composed of graphite, and a cathode [54,228]. However, there are several variants of chemical compositions for the anode and cathode materials. The main impact on performance, cost and the quantity of materials used has so far been on the choice of metals for the cathode. These are mainly lithium, cobalt, nickel and manganese [229].

In 2007, 82% of Li-ion battery cathodes were made of lithium Cobaltate (LiCoO_2) or its abbreviation LCO [230]. The evolution of cathode chemistry has subsequently favoured the development of so-called NMC (Nickel-Manganese-Cobalt) formulations, offering greater energy capacities while progressively limiting the use of cobalt in the cathode. The "333" NMC formulation, in which the atomic contents of nickel, cobalt and manganese are identical (1/3 Ni, 1/3 Mn, 1/3 Co), has really been dethroned in favour of the "622" formulation (60% Ni, 20% Mn and 20% Co), which is currently on the market [231]. Work is currently underway to improve the behaviour of the next generation – called NMC "811" (80%Ni, 10%Mn and 10%Co) – which to date has the disadvantage of a lower cycling life, but the advantage of containing even less cobalt and more nickel, again due to the tensions on cobalt and its high prices [232].

The availability of these materials in sufficient quantities and qualities therefore directly conditions the development of the battery electric vehicle market. To reduce the predicted demand on battery resources, it is also essential to recycle batteries [233–235]. Although the technologies already exist, they still need to be industrialized. One of the difficulties for battery recycling industries is to be competitive with mineral extraction [236]. However, if the price of these resources increases, recycling could become profitable.

4. EV charging infrastructures

Electric vehicle supply equipment (EVSE) or electric vehicle charging station (EVCS), is an electrical component assembly designed specifically to deliver electrical energy from the electricity source to an EV and PHEV. It involves cords, connectors, and interfaces. As shown in Fig.14, EVCS can be divided into three major categories, based on the mode of energy transfer which involves conductive charging, inductive charging, and the battery swapping [237,238].

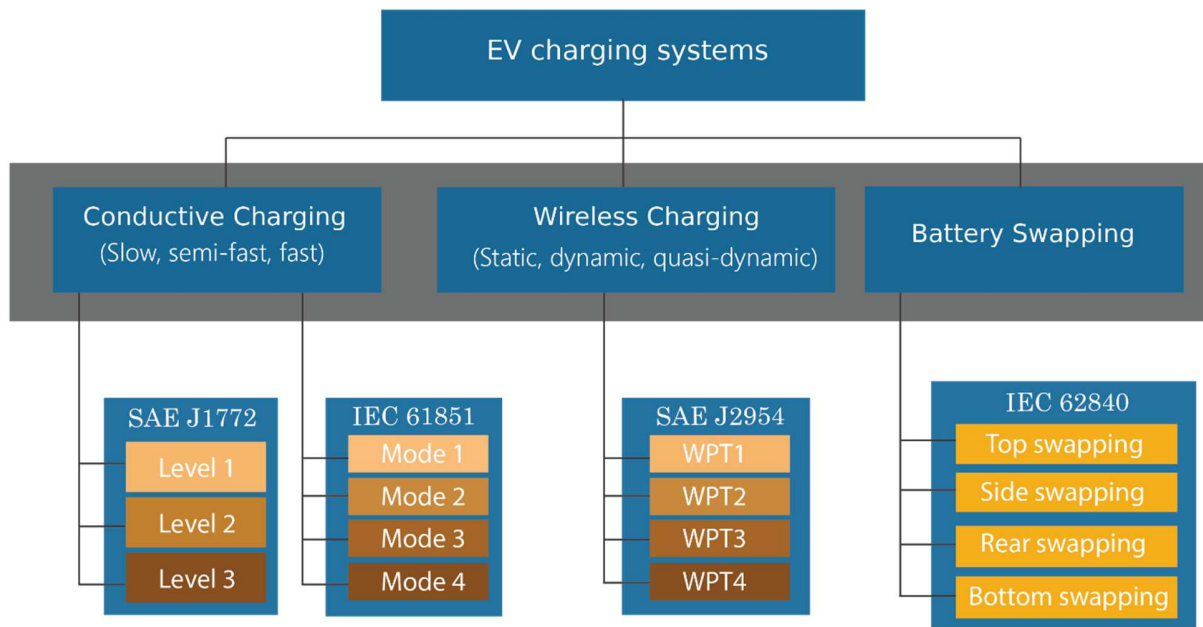

Fig. 14. EVCS classification

4.1. Conductive charging systems

Conductive charging method transfers power from the utility grid to EV through direct metal-to-metal contact. This method involves conductor to connect the electronic devices to the extent of energy transfer. This method is simple, robust, and highly efficient [239]. Specific power configurations differ from each country depending on voltage, electrical grid connection, frequency, and transmission standard. According to the *Society of Automotive Engineers* (SAE), the charging level can be categorized as alternating current (AC) level 1, AC Level 2, direct current (DC) Level 1 and DC Level 2. While the *International Electrotechnical Commission* (IEC) defines four modes of EV charging, namely, AC Mode 1 (Slow), AC mode 2 (slow), AC mode 3 (slow/fast), DC mode 4 (fast) based on IEC 61851. Similarly, in the Chinese standard GB/T 20234.1-2015. However, a recent detailed review of all EVSE standards have been presented by Das et al. [12]. Thus, a summary of standards characteristics for each type of charging systems in North America, Europe, and China [240–246] is given in **Table.3**. For levels 1 and 2, the conversion of the utility AC power to the DC power required for battery charging occurs in the vehicle's on-board charger. In DC Fast Charging, the conversion from AC to DC power typically occurs off board, so that DC power is delivered directly to the vehicle as presented in **Fig.15**.

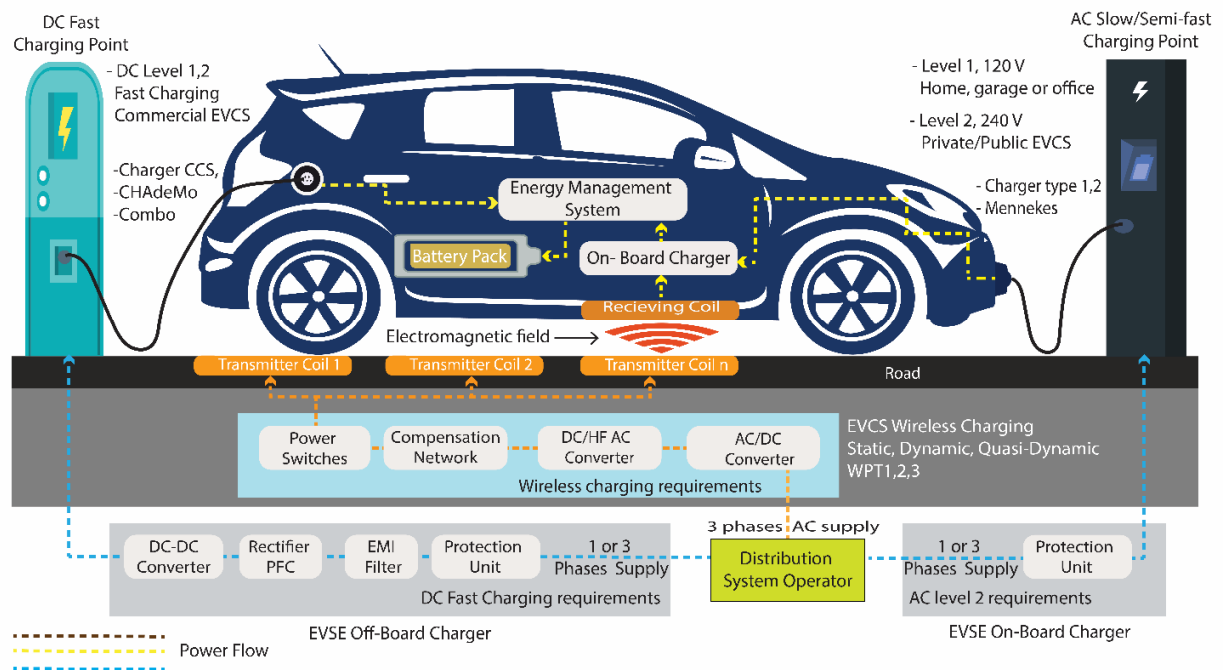

Fig. 15. EV charging infrastructures

Another difference between these charging standards remains in the connector design, for AC charging the SAE J1772 and the IEC 62196-2 type 1 and type 2 connectors are used for both level 1 and level 2, while for DC charging the popular standard SAE J1772 Combo and CHAdeMO Japanese standard are the only standards that can be used (see [Fig.16](#)), while Tesla has designed its own connector for both AC and DC charging.

		United States	Europe	Japan	China	
Charging type	AC-Slow/Semi-Fast	Connectors	 SAE J1772 L1&L2	 IEC 62196-2 L1&L2	 SAE J1772 L1&L2	 IEC 62196-2 L1&L2
		Ports	 SAE J1772 L1&L2	 IEC 62196-2 L1&L2	 SAE J1772 L1&L2	 IEC 62196-2 L1&L2
	DC-Fast	Connectors	 SAE J1772 DC & L2 Combo	 IEC 62196-3 combo	 CHAdeMO DC	 GB/T 20234.3
		Ports	 SAE J1772 Combo	 IEC 62196-3 combo	 CHAdeMO DC	 GB/T 20234.3

Fig. 16. Chargers and connector types

The cost of conductive charging infrastructure is depending on each level. For example, the cost of the AC level-1 takes less than \$880 [247]. Level-1 charging equipment is portable, suitable for residential applications and does not require the installation of specialized infrastructure [248]. It uses a 120 V AC connection and takes approximately 8–12 hours to fully charge a depleted battery, depending on battery size and type and the input power. For level-2, the charging infrastructure for home or public applications costs approximately around \$1000 to \$3000 [247], and the charging time take around 2–6 hours to fully charge an EV battery depending upon the input power. This charging level requires an AC power range of 208–240 V, and it is suitable for all EVs and PHEVs. The infrastructure installation costs for Level-3, also known as DC fast charging, vary from \$30,000 and \$160,000 [247], and it's widely used in public or commercial. This charging level requires an off-board charger and uses 208–600 V AC or DC commercial three phase out, taking around 15–20 min to provide 80% of charge for EV battery, depending on battery size and type, the input power, and temperature.

4.2. Wireless charging system

Wireless or inductive charging system is based on the principle of mutual induction for transferring power between the grid system and electric vehicle without any physical contact. This wireless link can efficiently prevent sparking over plugging and unplugging [249,250]. Thus, wireless charging system gives the possibility for dynamic charging while driving the vehicle. Numerous companies worldwide, particularly in the UK, Germany and Korea, are working to develop this flexible and convenient method for charging EVs that does not require bulky cables [250]. Wireless charging infrastructure for EV can be classified into three main categories: Static wireless charging (SWC), dynamic wireless charging (DWC) and quasi dynamic wireless charging (QWC) [251–254]. SWC is similar to current plug-in chargers, it has two coils; one is installed in the charger outside the EV while other coil is the integral part of the EV (see Fig.15), both coils must be properly aligned to achieve the high efficiency of power transfer [255]. Dynamic inductive charging system has the possibility to charge the vehicle while it is moving. Thus, in this charging technology special charging tracks are placed on the roads and provides energy to the battery, which increase the driving range of EV and reduce the batteries size [256,257]. Quasi-Dynamic inductive charging systems are generally installed in traffic light signals, taxi stops, or bus stops and provide energy to battery even for small interval [11].

Since the appearance of wireless power system for vehicular charging purposes, there was a need for standardization. Promotional activities towards creating a standard for WPT systems for charging electric vehicles have been ongoing for several years. For instance, in October 2020, the Society of Automotive Engineers (SAE) established the SAE J2954-2020 "Wireless Power Transfer & Alignment for Light Duty Vehicles" [258,259], as an attempt to supply electric vehicles (EVs) with a safe and efficient way of transferring electricity from a charging station to the vehicle. Furthermore, in the near future, vehicles that can be charged wirelessly by SAE J2954 can also be conductively charged by SAE J1772 plug-in charging. The SAE J2954-2020 standard specifies different charging levels for wireless charging, based on the previous SAE J1772 standard for conductive charging (AC levels 1, 2, and 3), with certain differences. It describes WPT system requirements such as input power classes of 3.7 kW (WPT1), 7.7 kW (WPT2), and 11 kW (WPT3), while including some criteria that concern ground clearance

ranges, frequency of operation, efficiency targets, EMC limits, and safety requirements as well as testing of charging systems for light duty EVs. Thus, there are three types of ground clearances Z1 (100–150 mm), Z2 (140–210 mm), and Z3 (170–250 mm) established for each power class. This ground clearance signifies the air gap between the bottom of the receiver coil and the ground floor. It is important to mention that this version SAE J2954 focuses only on unidirectional charging and stationary applications, bidirectional and dynamic charging may be evaluated and considered for a future standard. Elsewhere, the guidelines for wireless power transfer communication between an electric vehicle and an inductive battery charging system are released by the SAE J2847/6 [259]. **Table.4** presents the WPT classes for passenger cars. The WPT1 power class is generally used for vehicles with small battery packs, such as plug-in hybrid vehicles, while the WPT2 and WPT3 power classes will be the dominant charging level for most light-duty battery electric vehicles. The charging time depends on the battery pack size but receiving a full charge in around 4–6 hours is considered sufficient as most charging will occur at home or work where vehicles are typically parked for hours.

The economic feasibility of wireless charging technology has received little attention due to its novelty. Generally, this economic viability depends on several factors including the road coverage, the power supply, the EV penetration level, and battery capacity [260]. Elsewhere, the magnetically coupled transmitter and receiver differentiate a stationary wireless charging system from a conventional wired charging system [261]. This implies that the cost of purchasing and installing an 8-kW stationary wireless charging system to be about \$400 [262]. When considering the long-term cost benefits and convenience that the stationary wireless charging system can provide, this cost can be acceptable to consumers [263]. Jae Jang et al. [27] assess and compare the initial investment of implementing three forms of wireless charging (SWC, QWC, and DWC) in a proposed public transportation system. It is mentioned that the cost of batteries and charging infrastructure will differ significantly depending on the type of wireless charging solution selected. DWC drastically reduces the high investment costs of typical plug-in EVs by allowing the batteries to be downsized [249]. Likewise, battery costs can be reduced by installing chargers at various bus stops. Furthermore, DWC would be cost competitive because it would make efficient use of the existing charging facilities, since many cars would use the same road segments equipped with a charging system.

The OLEV is one of KAIST's newly commercialized wireless-charging for EVs. This system is designated as a DWC type and extensive technical details can be found in [264,265]. Related pilot programs have recently started in several countries [24]. Based on the WPT systems built and tested in recent few years, the WPT technology cost can be estimated. Thus, the third generation OLEV cost was 1,069 M\$/km [266], while the cost for the fourth generation was reduced to 0.85 M\$/km. The cost of power supply system is estimated to be 0.235 M\$/km [267]. Depending on these costs, several authors have investigated the economic impact of DWPT system. Shekhar et al. [268] presented a mathematical model that estimates the cost and road coverage for various DWPT power levels (between 0.7-1.2 M\$/km) for a driving range of 400 km. Jeong et al. [269] have used this model to investigate the economic impact of DWPT system compared to stationary charging from a battery capacity reduction point of view. They projected the average expense of the DWPT system over a ten-year term and found that the total cost of the DWPT system is approximately 20% lower than the system cost of a stationary charging system. Bi et al. [270] confirmed that the wireless charging system has the lowest cumulative cost over its lifetime, in comparison with ICE, plug-in hybrid system. Fuller et al. [271] estimated the cost of installing 626 miles of roadways in California with 40 kW DWPT system to be \$2.5 billion. With a target of a payback time of 20 years, and a total number of EVs of 300,000, the costs per vehicle and year would be \$512. This cost can be reduced to \$168 a year per vehicle if the EVs penetration is increased to 1 million. In summary, although the high initial investment cost of WPT technology that depends on to the high construction, installation and maintenance costs, this technology would still costly effective and competitive for long-term consideration, especially with a fast development and a higher penetration of EVs.

4.3. Battery swapping stations

Battery swapping station (BSS) also known as battery switching station is a place where electric vehicle owners can rapidly exchange their empty battery with a fully charged one (see Fig.17). This concept has been proposed as a new method to handle the obstacles regarding to the aforementioned traditional charging methods [272,273]. There are currently three battery swap types on the industry: chassis power swap, sub-box power swap, and side power swap [274]. The

general outline of battery swap systems is given by the IEC 62840-1,-2 [275,276], and NB/T 33006-2013, NB/T 33020-2015 with a maximal voltage up to 1 000 V AC and up to 1 500 V DC. It is claimed that the use of battery swapping station is advantageous, given the ability of this technology to refuel the EVs in a rapid way [277]; for example, Tesla swaps an EV battery in 90s [278], preventing waiting anxiety [279], and giving EVs the possibility to travel nonstop on long road trips. As the EV's owner does not own the battery in the car, a reduction EV's total cost is advantageous [238]. Thus, the cost over the battery, battery maintenance, quality, and warranty are transferred to the battery swapping station company. Furthermore, discharged batteries that are exchanged can be charged when electricity price is cheap and in an off-peak period [280]. Moreover, the overloading, the network stress and the uncertainty in time of charging caused by mass EV charging, can be disappeared by controlled charging in BSS [238,281]. Other advantages include that the battery life expectancy can be prolonged because the battery swap station has the possibility to charge batteries with lower voltage compared to rapid charging stations.

With the rise of e-mobility services, this new technology as a new refuelling option has been considered in several countries worldwide including China, Denmark, Germany, and India. For instance, China has developed the world's most BSS and charging spots [282] and aims to achieve 12,000 battery swapping stations by the end of 2020 in order to meet the charging demand of the growing EVs penetration [283,284]. While India has launched its first battery swapping station for EVs, in order to facilitate the EV adoption [285]. The BSS adoption has been seen elsewhere; in Germany the idea of battery swapping station *is associated with* the use of photovoltaic plants in urban areas [286]. Other companies that have recently started to provide battery swapping facilities include NIO, Gogoro, and BattSwap.

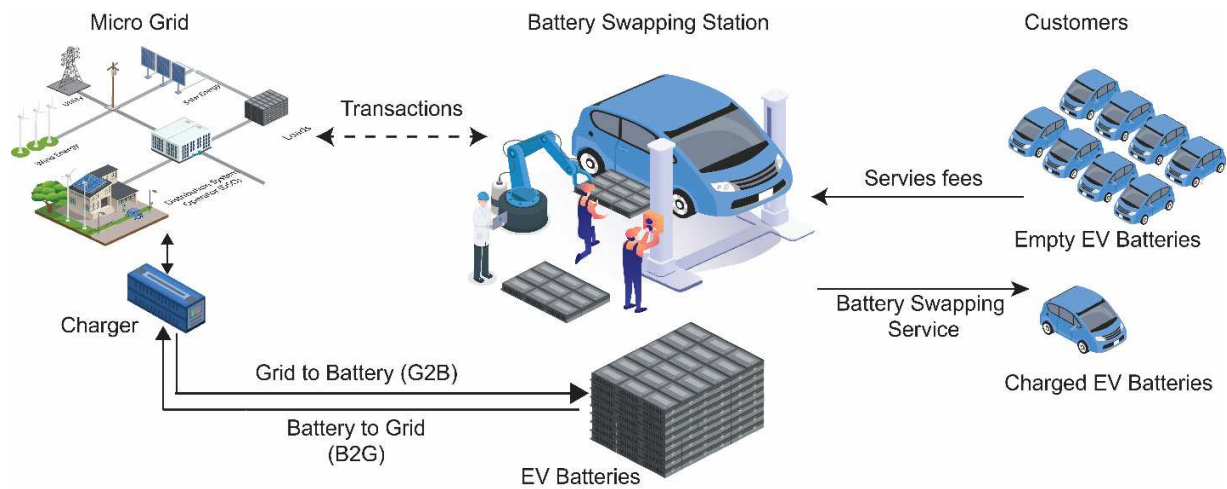

Fig. 17. Battery Swapping Station

In recent few years, several papers in literature discuss the BSS adoption. In [287], it's shown that an optimal BSS placement can handle the issue of travel distance, and can avoid the battery range anxiety. However, the BSS technology can be implemented in a Micro-grid or a network of Micro-grids instead of distribution networks. Thus, this concept is considered in [288], in terms of energy management and battery charging optimization. In addition, a study in [289] presents the benefits of BSS integration in networked nano-grids regarding the renewable energy resource, the reduction of fuel cost, and resilience enhancement. The influence of the BSSs on the distribution network reliability is discussed in [290,291]. In these papers authors indicate that the optimal BSSs scheduling and the behaviour of EVs users can enhance the reliability of the system. Indeed, authors in [292] and [293], propose the application of BSS in order to schedule the electric buses charging. While in [294], various battery swap pricing schemes and charging policies for the BSSs are proposed. However, authors in [295,296] expect that the use of battery-swap services can reduce the fleet size and the number of chargers. Elsewhere, the participation of BSSs in the global electricity market has been discussed in [297], and it has been demonstrated that BSSs can acquire a higher revenue while responding actively to the electricity price fluctuation. Moreover, a comparative study between BSS and the fast-charging station in terms of performance is presented in this paper [238]. Findings indicate that BSS is more suitable for public transportation system and more competitive for BSS owner.

Table 3. Standards characteristics for conductive charging systems in North America, Europe and China

Standards Characteristics				Nominal Supply voltage (V)	Grid phases	EVSE Output	Max. Current (A)	Operating Frequency (Hz)	Max. Power (kW)	Charging time (h)	Charger type	Charger location	Typical use	EVSE cost (\$)		
Conductive charging	North America SAE J1772	Levels	AC	1	120	1	AC	12-16	50/60	1.44 - 1.92	8-9	Type 1 Type 2	On-board	Home or office	< 880	
			AC	2	208-240	1	AC	40-80	50/60	Up to 19.2	1-3	Type 2	On-board	Private or public	\$1000 to \$3000	
		DC	1	50-1000	-	DC	80	50/60	80	0.5 -1.5	CHAdEMO CCS	Off-board	Public, commercial	30,000 160,000		
			2	50-1000	-	DC	400	50/60	100	0.2- 0.58	CHAdEMO CCS	Off-board	Public, commercial	30,000 160,000		
	Europe IEC 61851-1, 61851-23 62196-2,	Modes	1	250-480	1-3	AC	16	50/60	3.7	5.5	Type 1	On-board	Home or office	< 880		
			2	250-480	1-3	AC	32	50/60	22	1.0	Type 2 Mennekes	On-board	Private of public	\$1000 to \$3000		
			3	250-480	3	AC	63	50/60	44	0.5	Type 2 Mennekes	On-board	Public, commercial	30,000 160,000		
			4	1000-1500	-	DC	300	50/60	200	0.1	CHAdEMO CCS	Off-board	Public, commercial	30,000 160,000		
	China GB/T 20234.1, 20234.2, 20234.3, 18487.1	Modes	1	Prohibited												
			2	250	1	AC	10/16/3 2	50/60	3.7-22	3-5	GB/T	On-board	Private of public	\$300 to \$500		
			3	440	1-3	AC	16/32/6 3	50/60	22-44	1-3	GB/T	On-board	Public, commercial	\$7000-10000		
			4	750/1000	-	DC	80/125/ 200/250	50/60	250	0.2- 0.58	GB/T CHAdEMO	Off-board	Public, commercial	\$7000-10000		

Table 4. Standards characteristics for wireless charging systems in North America, Europe and China

Standards Characteristics				Rated Power (kW)	Air Gap (mm)		Target efficiency	Nominal Supply voltage (V)	Resonant Frequency (kHz)	Typical use	EVSE cost (\$)
Wireless charging	North America SAE J2954 J1773	WPT Classes	1	3.7	Supply device Z-classes	Z1: 100–150	85%	Up to 1000 AC 1500 DC	81.38-90	Home or office	<p>SWC: Charger at the base station \$40,000-\$60,000</p> <p>QWC: Charging unit and inverter \$50,000-\$60,000/unit</p> <p>DWC: Power transmitter \$400-\$600/m Inverter unit \$50,000-\$60,000/unit</p>
			2	7.7		Z2: 140–210				Private/Public Parking	
			3	11.1		Z3: 170-250				Private/Public Parking	
			4	22						Private/Public Parking	
	Europe IEC 61980-1 61980-2 61980-3	MF-WPT Classes	1	3.7	Supply device Z-classes	Z1: 100-150	80- 85%	Up to 1000 AC 1500 DC	81.38-90	Home or office	
			2	3.7-7.7		Z2: 100-210				Private/Public Parking	
			3	7.7-11.1		Z3: 100-250				Private/Public Parking	
			4	11.1-22						Private/Public Parking	
			5	>22						Private/Public Parking	
	China GB/T 38775-1 38775-2 38775-3 38775-4	MF-WPT	1	3.7	TBD	TBD	TBD	Up to 1000 AC 1500 DC	81.38-90	Home or office	
			2	3.7-7.7						Home or office	
			3	7.7-11.1						Private/Public Parking	
			4	11.1-22						Private/Public Parking	
			5	22-33						Private/Public Parking	
6			33-66	Private/Public Parking							
7			> 66	Private/Public Parking							

4.4. Optimal placement and sizing of EVCS

The EVCSs placement and sizing is recognized as being one of the most complex problems related to EVCS, due to the increased use of vehicles powered by alternative fuels, and the limited range and limited access to charging stations [298,299]. However, an appropriate implementation of EVCSs is mainly important to reduce the energy loss in electric grid and EVs [300], and to meet the increased charging demand, while improving the sustainable planning of urban infrastructures. A literature reviews showing the state-of-the-art of technologies and latest trends concerning the EVCS placement and their impacts can be found in [239,299]. In literature, several studies deal with these issues while providing different approaches to size and define the optimal placement for charging infrastructures. The studies specifically consider two aspects: one is economic, while the other focus on topics related to the power grid. The ultimate goal is to determine EVCS's strategic location and size through optimization techniques that minimize total costs while maintaining the safety of the power system. Different heuristic optimization algorithms have been used to solve with this problem. For instance, researcher in [301,302] have used modified genetic algorithm (GA) to solve the optimal EVCS placement and sizing problems. Particle swarm optimization (PSO) has been used in [303,304] with the target to find optimal solution with higher possibility and efficiency. In [305,306] Integer programming (IP) is used to identify the optimal location for EVCS placement. Furthermore, Ant colony optimization (ACO) method has been also used in this paper [307] to evaluate optimal EVCS placement. In relative studies, greedy algorithm has been proposed in [308] to prove the heuristic optimization at each stage. It is claimed that the use of heuristic algorithms is advantageous, given the ability of these methods to find the global or near-global optimal solution even though the problem is very complex. Thus, particle swarm optimization provides the advantages to obtain a global optimal solution with higher possibility and accuracy compared to other methods. However, the main shortcomings of PSO are low precision and easy divergence. Otherwise, genetic algorithms are easy to implement, suitable for placement problems, but also requires long computational time to find the optimal solution. Similarly, Ant colony optimization presents a rapid way for discovering good solution. **Nonetheless, ACO's time to convergence is uncertain.** Furthermore, integer programming methods are simple to apply but they only work with linear variables and cannot potentially solve stochastic problems. Elsewhere, other practical and effective methods in terms of computational costs, have been presented in literature to investigate and improve

the EVCS placement strategies such as clustering methods [309], Network Equilibrium models [310], Flow Capturing models [311], dynamic spatial and temporal models [312,313], simulation-based models [314,315], set covering models [316,317], Continuous facility location models [318], Route Node Coverage problem [314,319], Mathematical programming models [320,321], Graph theory [322], data-based methods [323–325], artificial intelligence [326], and stochastic modelling [327].

All these approaches have provided important contributions from different viewpoints on the optimal EVCS placement and sizing problem. Thus, most researchers apply single optimization methods, whereas other researchers apply hybrid techniques by using a combination of these methods while considering different criteria and constraints. For instance, Sadeghi-Barzani et al. [328] used the Mixed-Integer Non-Linear optimization approach to select the optimum location and size of the fast-charging stations considering EV energy loss and electric grid loss and urban roads. The outcomes showed the robustness and effectiveness of the proposed approach for picking the optimal location and capacity of charging stations. Injeti et al. [329] used a combination between PSO and Butterfly Optimization (BO) algorithms to optimize the integration of distributed generators (DGs) into radial distribution systems in the presence of plug-in EVs in order to reduce daily active power losses and improve the system voltage profile. The simulation results show that the suggested solution enhanced system performance in every aspect. Fathy et al. [81] proposed a metaheuristic-based strategy for locating and sizing parking areas in the distribution network. The study's primary goal was to increase network robustness at the lowest possible expense. The problem was optimized using various algorithms, and the final results revealed that the Gray Wolf optimizer (GWO) provides the best performance. Cilio et al. [325] suggested a novel data-driven framework using real-time GPS information for installing suitable rapid EVCS in large urban areas, to assess the smallest possible facilities for a level of charging availability that guarantees continuous electric taxi service in Istanbul, Turkey. This research has also shown the realistic trade-off between initial economic expenditures in infrastructure implementation and the level of charging accessibility in the domain. According to their findings, an appropriate charging infrastructure to support a fully electric taxi fleet of 17,395 vehicles in a major city like Istanbul should include approximately 1,363–1,834 charging stations, depending on the roll-out strategy. They also demonstrate that small changes in the number of charging stations (less than 1,300 charging stations in this case study) will result in significant changes in taxi charging availability, and reliability of taxi services. Chen et al.

[330] proposed a Balanced Mayfly Algorithm (BMA) to find the optimal placement of EVCS to 30-bus distribution system in Allahabad, India. The simulation results reveal that the proposed approach, with an active power loss of 18.358 MW and a reactive power loss of 73.826 MVar, and 415 charging ports, provides better performance with lower power losses. A recent approach to the issue of charging station placement is found in [331], where two effective evolutionary algorithms, Chicken Swarm Optimization (CSO) and Teaching Learning Based Optimization (TLBO), are combined to extract the best features of both algorithms. The proposed hybrid algorithm clearly outperformed others in addressing the charging station location issue. Jordehi et al. [332], formulated a mixed-integer non-linear optimization problem to find the optimal placement of battery swapping stations in microgrid including geothermal, pumped hydro storage, photovoltaic, and wind power plants. The results indicate that choosing the optimal location for BSSs is crucial, as the difference in daily microgrid operating costs between the best and worst locations is as high as 4.9%. For dynamic ridesharing, Ma et al. [333] established an online vehicle-charging station assignment model, and improved the location of fast-charging stations by incorporating charging management to reduce the fleet's regular charging service time. In this study, a surrogate-assisted optimization approach is adopted, and the proposed methodology has been evaluated in Luxembourg on a realistic scalable bus service. The findings reveal that the proposed online charging strategy could significantly minimize fleet charging times while compared to other approaches. Thus, with the installation of 10 extra DC fast chargers, charging time can be decreased by up to 27.8%. Today, there are several web sites available that summarize charging stations and map them to reduce the fleet's congestion and charging time. For instance, ChargePoint and PlugShare operate the world's largest network of EVCS in North America and Europe [334,335].

Nevertheless, inappropriate placement and sizing of electric vehicle charging stations had a negative effect on the traffic network infrastructure in the region, as well as the suitability of EV drivers [336]. An adequate choice these methods can be based on different criteria such as the computational time, the cost, and the convergence.

5. Services that an EV can provide

Electric vehicles appear to be the future solution to ensure mobility independent of fossil energy resources and non-emitting CO₂ during use [337,338]. The use of electric vehicles is

not restricted to transportation, but it also covers the electricity sector. They could enable many ancillary services to the grid, such as voltage regulation [339], load levelling [23], spinning reserve [340], and storage [22] and so on. At residential level, according to Marinescu et al. [341,342], enhancing the currently existing millions of household RES Microgrids with an EV charging capability would improve the utility grid by providing to leverage distributing RES to prevent overcharging [341]. However, increasing the penetration of EVs brings new challenges to the distribution system operator (DSO) and require new approaches and strategies to integrate these active distributed resources in sizeable quantities as well as the aggregator [343–345]. The aggregator is a necessary entity to implement the V2G concept [346]. It is an upstream link to various network entities. Through this concept, using EV battery as a storage medium for the network when it is connected can be a possible solution for load balancing and for reducing the ownership cost of an EV [344,347]. Also, with the development of intelligent and bidirectional charging stations, electric vehicles have the ability to transfer energy to the power grid (**V2G**), to EVs (**V2V**), and to the residential (**V2H**) or tertiary (**V2B**) buildings to which they are connected [5,348] (see **Fig.18**). These concepts allow buildings to be deleted from the power grid during critical peak periods and thus contributes to its reliability.

The worldwide V2G projects and corresponding key insights are mapped out in [349]. Since 2009, there have been 86 projects involving V2G systems in 22 countries, with approximately 59% proof of concept trial, 20.5% small-scale commercial trial, and 2.6% are services produced commercially. Great Britain with 43, the United States with 27, and Netherland with 19 offered services are top three countries in terms of offered V2G services. Among top 14 vehicle manufacturers that have participated in the V2G projects, Nissan, Mitsubishi, Honda, Fiat-Chrysler, and Renault have the biggest share of these projects, about more than 68% of the total projects. In recent few years, several V2G feasibility analyses have been undertaken to better understand the potential applications of EVs [23,350–352], the economic and environmental impact of V2G system [352–357], and to present strategies for its positive emergence in power systems [358–360]. For instance, authors in [350,353] have proposed the adoption of V2G technology and demonstrated that V2G can improve the quality and reliability of the power system. Bibak et al. [360] show that integrating EVs and V2G systems in power supply with high RESs improves power grid reliability in terms of reducing total cost and emission levels. Muhammad Aziz et al. [23], performed a peak load shifting by using 5 EV, used EV batteries, and 20 kW PV panels as RES. They demonstrated that the

application of this system in supporting certain small-scale energy management systems is feasible. Sarabi et al. [351] assessed the real potential use of EV to provide a fast response. They modelled the available V2G power of the EV fleets in Niort, a city in west of France. According to their findings, EVs may participate in the grid ancillary services sector to reduce their daily operating costs in the deregulated energy market.

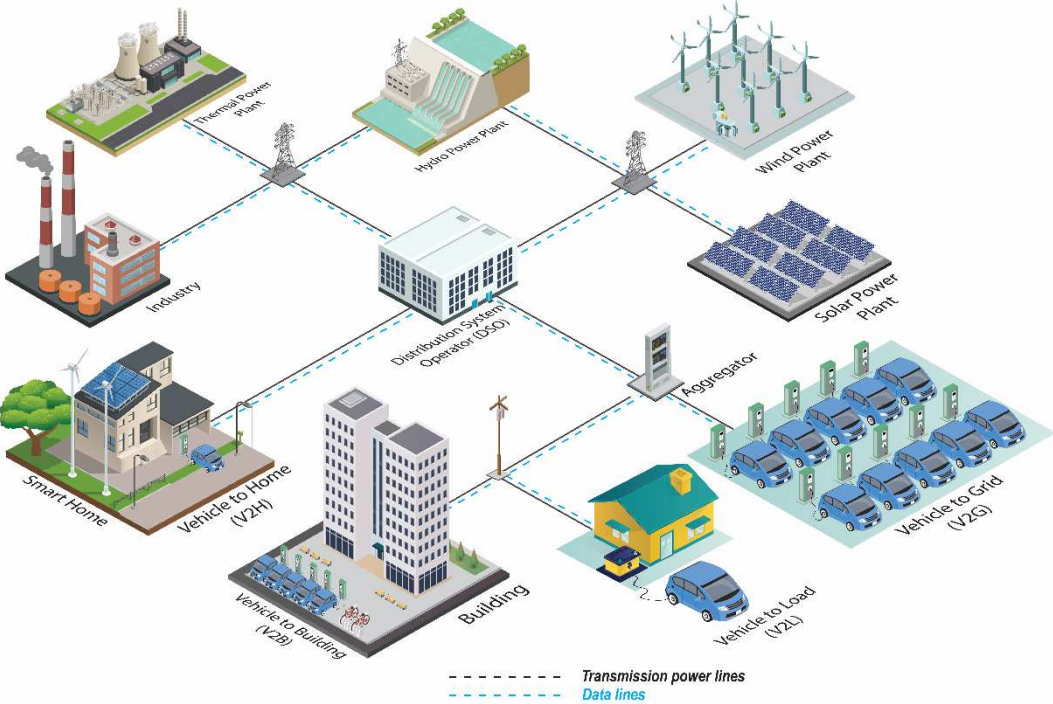

Fig. 18. V2X topology

From an economic standpoint, the use of EVs in V2G is possible since the estimated profit is higher than the actual selling price of EV batteries, even though battery wear is considered [357]. In another study, Huda et al. [352] focused on the potential use of EVs in the Indonesian power grid, especially for load levelling and frequency regulation. Results reveal that both the power company and EV owner can benefit from the V2G implementation; For the EV owners, the charging cost of EVs can be reduced by up to 60.15%. From power company point of view, the V2G can improve annual revenue by approximately 3.65%, whilst the peak supply from fossil fuels is effectively reduced by up to 2.8%, and 8.8% for coal and gas, respectively. Xinzhou Li et al. [356] conducted a cost-benefit analysis of V2G EVs supporting peak shaving in Shanghai, taking into consideration four brands of electric vehicles. The results exhibit that power plants have the most benefits of the three participants,

significantly surpassing those earned by EV owners, and recommend the establishment of a fair market distribution mechanism of V2G profits among three participants to guarantee a rational distribution of benefits. In similar analysis, Gough et al. [355], investigate the economic potential of 50 EVs with V2G in the United Kingdom. They demonstrated the economic attractiveness of EVs with smart charging could provide a significant source of income, resulting in an individual vehicle net present value of around £8400 over 10-year period. In this another study, Brinkel et al. [353] investigated whether grid reinforcements are appealing from a cost or emissions standpoint in the light of massive EV penetration. The study's findings reveal that using V2G will result in significant reductions in EV charging costs and emissions even with the current transformer capacity. They indicate a cost savings of up to 32.4% compared to uncontrolled EV charging. Also, emissions can be reduced by 23.6% while EV charging costs can be reduced by 13.2%.

From the previously mentioned works, several barriers are identified, and here are some requirements that must be fully fulfilled, to benefit from EVs through the V2G concept in a positive way:

- Optimal management methods for mitigating grid challenges with electric vehicles [359].
- Smart metering system that ensures accurate measurement and improve the fairness and transparency during charging and discharging process is essential and can be implemented in the aggregator level.
- A reliable market forecast that takes into account the weather conditions and human behaviour is critical for determining the peak-cut threshold [23].
- One of the most common concerns that EVs owners have about participating in the V2G scheme is exchanging data and information about their location, driving activities, charging places, and so on with aggregators and central power units. So, an efficient and secure communication system is required [361], and new protocol can be developed especially with the successful implementation of 5G which is expected to be the future technology for V2X communications due to its speeds and other technical advances [362].
- Further market models of encouraging policies, competitive tariffs, tax reduction, and subsidies are needed to encourage the EV owner to participate in V2G system.

6. Incentives to accelerate EVs adoption

Numerous policy incentives have been adopted in recent years to support and promote the adoption of electric vehicles [363,364]. This meant to increase the attractiveness of EVs is an important way to boost EV sales [365]. As shown in **Fig.19**, these incentives can be classified into two main categories: financial incentives, non-financial incentives, or taking other forms as well as supporting charging infrastructures, raising consumers awareness and so one. *Financial incentives* refer to different forms of financial costs associated with EV purchase and use, and they may take many forms [16]: Point-of-sale Grant incentives; This incentive takes the form of government purchase reductions or grants and helps to reduce the cost of EVs at the time of purchase, for instance Consumers in Germany will save US\$5500 from the cost of BEVs. Post purchase rebates; usually given as a cheque to consumers after purchasing the vehicle, for example in the United States BEV buyers can benefit from a rebate of US\$2,500 after purchase. VAT and Purchase Tax Exemptions; Generally applied at the time of purchase, BEV customers can pay reduced to zero VAT to pay no sales tax on certain cars. For e.g. in China this opportunity is worth US\$9,800. Income Tax Credits; This incentive entitles BEV users to a reduced income tax bill at the end of the fiscal year, for instance in the United States customers can pay US\$7,500 less tax. **Otherwise, financial incentives can take other forms such as free or preferred parking, free charging.**

Non-financial incentives refer to various types of non-monetary benefits that consumers can benefit with while owning an EV, such as the access to high occupancy vehicle (HOV) lanes, and toll road access [15,366]. Otherwise, incentives can take other forms like supporting charging infrastructure, raising information and awareness while providing consumers with the right information or educating them on the differences between EVs and ICEVs, and correcting misperceptions around energy savings, EV's maintenance and reparation [365].

Understanding which incentive stimulate and promote EVs adoption is important to optimize the use of public funds and resources. **In this way, several research in the literature analysed the effectiveness of financial and non-financial incentives for EV adoption, either through a questionnaire survey or an analysis of EV markets, or through other methodologies, such as qualitative surveys, literature or policy assessments [15,16,367].** Hardman et al. [16]

investigate the effectiveness of financial incentives in the top market for EVs which are: Canada, China, France, Germany, Japan, Netherlands, Norway, United Kingdom, United States, with the aim to find whether financial purchase is effective in promoting EV sales. They indicate that buying benefits should be applied as a reward or VAT buy-tax exemption, and they recommend that the size of incentives should differentiate between EVs ranges that have different environmental and energy benefits. In line with these findings, Santos et al. [368] questioned whether electric vehicles need government subsidies in the United Kingdom. Results indicate that BEV needs large subsidies to be competitive. With a £4,500 rebate or exemption from 20% VAT, BEV mass market could be increased significantly in the UK. Similar conclusions are drawn from several studies in [369,370]. In another study, Langbroek et al. [365] demonstrate that free parking and access to bus lanes are efficient to potential EV users and increase the probability of EV adoption. According to Jenn et al. [371], every \$1000 provided as a rebate or tax credit boost annual sales of EVs by 2.6% in the United States, while HOV access generates 4.7% rise per 100 vehicles using lane per hour.

Kester et al. [372] presented a qualitative study that addresses the reasoning underlying EV incentives and policy processes in the five Nordic countries. They demonstrate how the advantages and disadvantages of these policy structures differ by region, transport segment, market share, and even region. They provide expert advice in terms of costs, charging infrastructures, consumers' knowledge and awareness, and more general policy directions. From this study it can be concluded that taxation policies are preferred over subsidies, even where no taxation exemptions are available. Also, strong, and stable national targets preceded by purchase price incentives and flexible local variable secondary benefits; as free parking, HOV/bus access, free charging, and toll exemptions are necessary to promote EVs, as well as more attention to consumer information and awareness campaigns. The effect of various government subsidies on the market share of BEVs in Australia was investigated by Cong et al. [373]. Since EVs are supposed to be costly expensive, the findings suggest that a refund on the initial expense of an EV is the most preferred monetary incentive. Thus, rebates on energy costs and parking fees are well received by Australians as a way of promoting EVs, while non-financial incentives are ineffective to promote EVs adoption.

Lack of availability of recharging points also limits the deployment of EVs. According to [374], most light-duty electric vehicle chargers in 2019 are private chargers in homes, workplaces, and multi-dwelling buildings, while publicly accessible chargers accounted only for 12% of total chargers, most of which are slow chargers. Sierzchula et al. [375]

investigated the effect of financial incentives and other socioeconomic variables on EV adoption in different countries. They found that supporting charging infrastructure has the most dominant policy effect on a country's rate of new EV sales. Similarly, Mersky et al. [367] also revealed that charging infrastructures accessibility is highly related to EV adoption in Norway.

Research on incentive policies has shown contradictory outcomes, including both effectiveness and ineffectiveness [376,377]. The consumers' purchase intentions could depend on several factors such as the mechanism of government policies, consumer psychological factors, consumers' perceptions of incentive policies and consumer social attributes, environmental concerns and so on [376,378]. In a recent study, Wu et al. [363] reviewed the China's EV subsidy policy in a macro scope. They demonstrated that achieving the EV emission target solely through government subsidies would be difficult and concluded that the development of a future EV industry must shift from a policy-driven to a market-driven model.

Elsewhere, future studies may emphasize on the relationship between a country's charging infrastructure accessibility and its EV penetration level as in [379]. Also, investment into R&D is required to improve the technological advancement of EV and production quality, this can increase the competitiveness and widespread adoption of EV [380]. Controlling production costs, providing convenient transport infrastructure, and distinguishing customers' experiences of driving EVs from conventional vehicles are viewed as necessary strategies for current EV manufacturers to tap consumers' deep desire and stand out in the highly competitive environment.

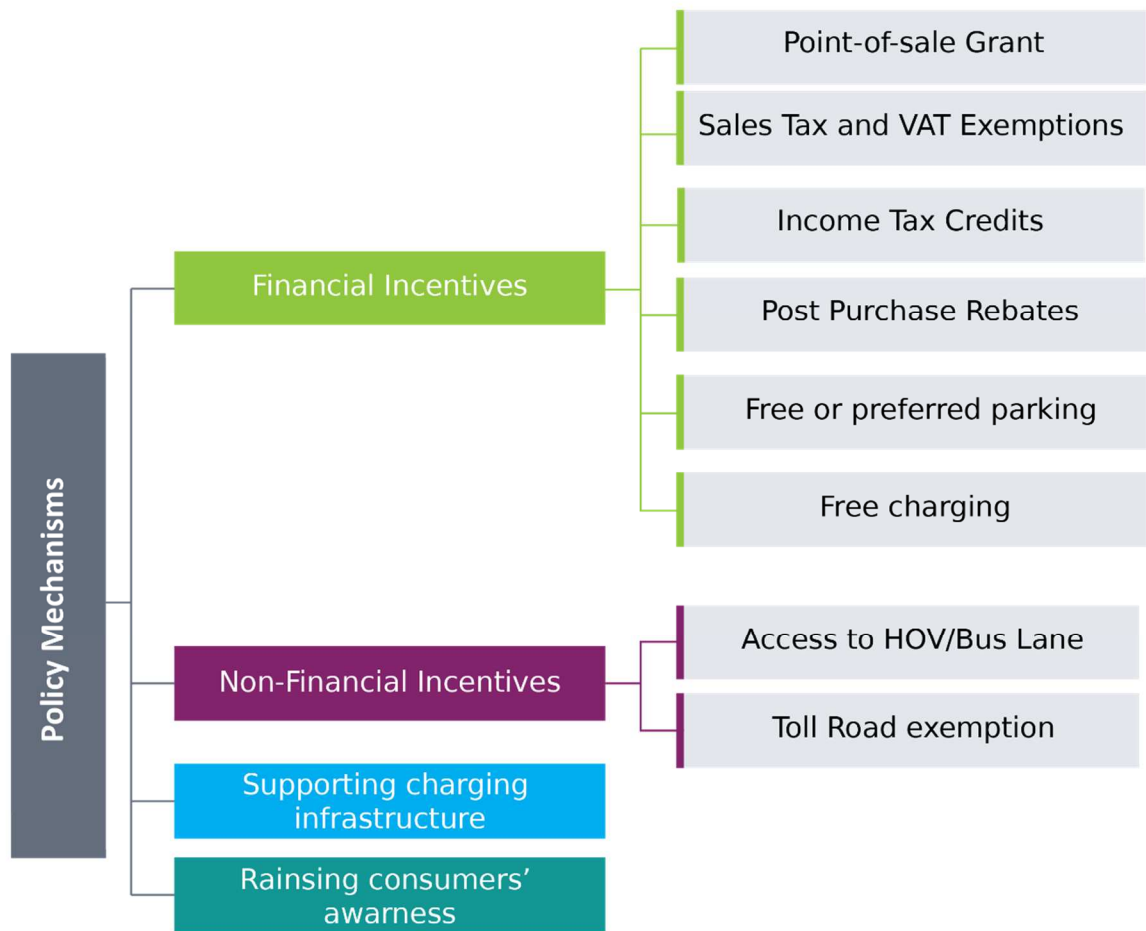

Fig. 19. Types of policy mechanisms affecting PEVs adoption

To reduce the emissions of transport, it is necessary to activate multiple levers. These levers must be implemented over the long term and require strong, coherent and constant involvement of the public authorities to give visibility and confidence to the players in their investment choices.

7. Recommendations

As mentioned earlier, there are several factors that influence the adoption of battery electric vehicles. Some of these have already been studied, but there is still work to be done to encourage the adoption of these vehicles.

- To successfully decarbonize road transport while taking into account economic, ecological and social constraints, we believe that the electric motor will have to become widespread, and be powered by on-board batteries, coupled with the gradual deployment of recharging infrastructures to increase the autonomy of cars.
- To improve the performance of the battery electric car, it is necessary to improve the energy density of the batteries, optimize the design, management system and integration of the battery system in the electric car.
- Other actions are necessary to optimize electrical consumption such as reducing the mass of the car, improving its aerodynamics and installing a regenerative braking system.
- Greater coordination and cooperation of policies are needed across different sectors specially the transport, energy sector, to foster the world transition toward clean energy, and to achieve the environmental objectives.

8. Conclusion

Electric vehicles are expected to become a sustainable part of the mobility scene and will continue to expand in the coming years, taking an increasingly large share of the market. Their economic viability without subsidies, still penalized by the current cost of batteries, should improve in the coming years and become competitive with internal combustion vehicles. Future batteries must also demonstrate that they represent a sustainable development breakthrough in order to be worthwhile. In addition to the issue of access to raw materials, the question of recycling is posed to ensure that, for example, the plastics scandal that nobody would have anticipated a century ago will not occur in this sector today.

References

- [1] A.W. Thompson, Economic implications of lithium ion battery degradation for Vehicle-to-Grid (V2X) services, *J. Power Sources*. 396 (2018) 691–709. <https://doi.org/10.1016/j.jpowsour.2018.06.053>.
- [2] Tesla - Statistics & Facts | Statista, (n.d.). <https://www.statista.com/topics/2086/tesla/> (accessed April 3, 2020).
- [3] G. Zubi, R. Dufo-López, M. Carvalho, G. Pasaoglu, The lithium-ion battery: State of the art and future perspectives, *Renew. Sustain. Energy Rev.* 89 (2018) 292–308. <https://doi.org/10.1016/j.rser.2018.03.002>.
- [4] L. Zhou, L. He, Y. Zheng, X. Lai, M. Ouyang, L. Lu, Massive battery pack data compression and reconstruction using a frequency division model in battery management systems, *J. Energy Storage*. 28 (2020) 101252. <https://doi.org/10.1016/j.est.2020.101252>.
- [5] N.S. Pearre, H. Ribberink, Review of research on V2X technologies, strategies, and operations, *Renew. Sustain. Energy Rev.* 105 (2019) 61–70. <https://doi.org/10.1016/j.rser.2019.01.047>.
- [6] L. Noel, G. Zarazua de Rubens, J. Kester, B.K. Sovacool, Beyond emissions and economics: Rethinking the co-benefits of electric vehicles (EVs) and vehicle-to-grid (V2G), *Transp. Policy*. 71 (2018) 130–137. <https://doi.org/10.1016/j.tranpol.2018.08.004>.
- [7] M. Li, X. Wu, X. He, G. Yu, Y. Wang, An eco-driving system for electric vehicles with signal control under V2X environment, *Transp. Res. Part C Emerg. Technol.* 93 (2018) 335–350. <https://doi.org/10.1016/j.trc.2018.06.002>.
- [8] E. Apostolaki-Iosifidou, P. Codani, W. Kempton, Measurement of power loss during electric vehicle charging and discharging, *Energy*. 127 (2017) 730–742. <https://doi.org/10.1016/j.energy.2017.03.015>.
- [9] K. Uddin, T. Jackson, W.D. Widanage, G. Chouchelamane, P.A. Jennings, J. Marco, On the possibility of extending the lifetime of lithium-ion batteries through optimal V2G facilitated by an integrated vehicle and smart-grid system, *Energy*. 133 (2017) 710–722. <https://doi.org/10.1016/j.energy.2017.04.116>.
- [10] Ö. Gönül, A.C. Duman, Ö. Güler, Electric vehicles and charging infrastructure in Turkey: An overview, *Renew. Sustain. Energy Rev.* 143 (2021). <https://doi.org/10.1016/j.rser.2021.110913>.
- [11] M.R. Khalid, M.S. Alam, A. Sarwar, M.S. Jamil Asghar, A Comprehensive review on electric vehicles charging infrastructures and their impacts on power-quality of the utility grid, *ETransportation*. 1 (2019) 100006. <https://doi.org/10.1016/j.etrans.2019.100006>.
- [12] H.S. Das, M.M. Rahman, S. Li, C.W. Tan, Electric vehicles standards, charging infrastructure, and impact on grid integration: A technological review, *Renew. Sustain. Energy Rev.* 120 (2020). <https://doi.org/10.1016/j.rser.2019.109618>.
- [13] T.U. Solanke, V.K. Ramachandramurthy, J.Y. Yong, J. Pasupuleti, P. Kasinathan, A. Rajagopalan, A review of strategic charging–discharging control of grid-connected electric vehicles, *J. Energy Storage*. 28 (2020) 101193. <https://doi.org/10.1016/j.est.2020.101193>.
- [14] H. Khayyam, J. Abawajy, B. Javadi, A. Goscinski, A. Stojcevski, A. Bab-Hadiashar, Intelligent battery energy management and control for vehicle-to-grid via cloud computing network, *Appl. Energy*. 111 (2013) 971–981. <https://doi.org/10.1016/j.apenergy.2013.06.021>.

- [15] J. Kester, L. Noel, G. Zarazua de Rubens, B.K. Sovacool, Policy mechanisms to accelerate electric vehicle adoption: A qualitative review from the Nordic region, *Renew. Sustain. Energy Rev.* 94 (2018) 719–731. <https://doi.org/10.1016/j.rser.2018.05.067>.
- [16] S. Hardman, A. Chandan, G. Tal, T. Turrentine, The effectiveness of financial purchase incentives for battery electric vehicles – A review of the evidence, *Renew. Sustain. Energy Rev.* 80 (2017) 1100–1111. <https://doi.org/10.1016/j.rser.2017.05.255>.
- [17] EV-Volumes - The Electric Vehicle World Sales Database, (n.d.). <https://www.ev-volumes.com/> (accessed May 27, 2021).
- [18] Deloitte Insights, Electric vehicles setting a course for 2030., (2020). https://www2.deloitte.com/content/dam/insights/us/articles/22869-electric-vehicles/DI_Electric-Vehicles.pdf.
- [19] T. Dimsdale, Rules of the Road: The Geopolitics of Electric Vehicles in Eurasia, 2019. https://www.e3g.org/docs/12_6_19_E3G_Geopolitics_of_EVs_PDF.pdf.
- [20] R.R. Kumar, K. Alok, Adoption of electric vehicle: A literature review and prospects for sustainability, *J. Clean. Prod.* 253 (2020) 119911. <https://doi.org/10.1016/j.jclepro.2019.119911>.
- [21] M. Boulakhbar, B. Lebrouhi, T. Kousksou, S. Smouh, A. Jamil, M. Maaroufi, M. Zazi, Towards a large-scale integration of renewable energies in Morocco, *J. Energy Storage.* 32 (2020) 101806. <https://doi.org/10.1016/j.est.2020.101806>.
- [22] A. Colmenar-Santos, A.M. Muñoz-Gómez, E. Rosales-Asensio, Á. López-Rey, Electric vehicle charging strategy to support renewable energy sources in Europe 2050 low-carbon scenario, *Energy.* 183 (2019) 61–74. <https://doi.org/10.1016/j.energy.2019.06.118>.
- [23] M. Aziz, T. Oda, T. Mitani, Y. Watanabe, T. Kashiwagi, Utilization of electric vehicles and their used batteries for peak-load shifting, *Energies.* 8 (2015) 3720–3738. <https://doi.org/10.3390/en8053720>.
- [24] C. Concordia, Voltage instability, *Int. J. Electr. Power Energy Syst.* 13 (1991) 14–20. [https://doi.org/10.1016/0142-0615\(91\)90012-k](https://doi.org/10.1016/0142-0615(91)90012-k).
- [25] C.H. Dharmakeerthi, N. Mithulananthan, T.K. Saha, Impact of electric vehicle fast charging on power system voltage stability, *Int. J. Electr. Power Energy Syst.* 57 (2014) 241–249. <https://doi.org/10.1016/j.ijepes.2013.12.005>.
- [26] J. Xiong, K. Zhang, X. Liu, W. Su, Investigating the impact of plug-in electric vehicle charging on power distribution systems with the integrated modeling and simulation of transportation network, *IEEE Transp. Electr. Conf. Expo, ITEC Asia-Pacific 2014 - Conf. Proc.* (2014) 1–5. <https://doi.org/10.1109/ITEC-AP.2014.6940855>.
- [27] T.U. Solanke, V.K. Ramachandramurthy, J.Y. Yong, J. Pasupuleti, P. Kasinathan, A. Rajagopalan, A review of strategic charging–discharging control of grid-connected electric vehicles, *J. Energy Storage.* 28 (2020) 101193. <https://doi.org/10.1016/j.est.2020.101193>.
- [28] E. Akhavan-Rezai, M.F. Shaaban, E.F. El-Saadany, A. Zidan, Uncoordinated charging impacts of electric vehicles on electric distribution grids: Normal and fast charging comparison, *IEEE Power Energy Soc. Gen. Meet.* (2012) 1–7. <https://doi.org/10.1109/PESGM.2012.6345583>.
- [29] M. Muratori, Impact of uncoordinated plug-in electric vehicle charging on residential power demand, *Nat. Energy.* 3 (2018) 193–201. <https://doi.org/10.1038/s41560-017-0074-z>.

- [30] M. Ahmadi, N. Mithulananthan, R. Sharma, Dynamic load control at a bidirectional DC fast charging station for PEVs in weak AC grids, *Asia-Pacific Power Energy Eng. Conf. APPEEC*. 2016-Janua (2016) 4–8. <https://doi.org/10.1109/APPEEC.2015.7380948>.
- [31] A. Hajimiragha, C.A. Canizares, M.W. Fowler, A. Elkamel, Optimal transition to plug-in hybrid electric vehicles in Ontario, Canada, considering the electricity-grid limitations, in: *IEEE Trans. Ind. Electron.*, 2010: pp. 690–701. <https://doi.org/10.1109/TIE.2009.2025711>.
- [32] A.H. Hajimiragha, C.A. Cañizares, M.W. Fowler, S. Moazeni, A. Elkamel, A robust optimization approach for planning the transition to plug-in hybrid electric vehicles, *IEEE Trans. Power Syst.* 26 (2011) 2264–2274. <https://doi.org/10.1109/TPWRS.2011.2108322>.
- [33] M. Kintner-Meyer, K. Schneider, R. Pratt, Impacts assessment of plug-in hybrid vehicles on electric utilities and regional US power grids., *Pacific Northwest Natl. Lab.* (2007). <http://citeseerx.ist.psu.edu/viewdoc/download?doi=10.1.1.105.663&rep=rep1&type=pdf>.
- [34] C. Jiang, R. Torquato, D. Salles, W. Xu, Method to assess the power-quality impact of plug-in electric vehicles, *IEEE Trans. Power Deliv.* 29 (2014) 958–965. <https://doi.org/10.1109/TPWRD.2013.2283598>.
- [35] M. Wanik, Harmonic Measurement and Analysis during Electric Vehicle Charging, *Engineering*. 05 (2013) 215–220. <https://doi.org/10.4236/eng.2013.51b039>.
- [36] S. Iqbal, A. Xin, M.U. Jan, H. Ur Rehman, A. Masood, S.A.A. Rizvi, S. Salman, Aggregated Electric Vehicle-to-Grid for Primary Frequency Control in a Microgrid- A Review, in: *Proc. 2018 IEEE 2nd Int. Electr. Energy Conf. CIEEC 2018*, Institute of Electrical and Electronics Engineers Inc., 2018: pp. 563–568. <https://doi.org/10.1109/CIEEC.2018.8745952>.
- [37] L. Pieltain Fernández, T. Gómez San Román, R. Cossent, C. Mateo Domingo, P. Frías, Assessment of the impact of plug-in electric vehicles on distribution networks, *IEEE Trans. Power Syst.* 26 (2011) 206–213. <https://doi.org/10.1109/TPWRS.2010.2049133>.
- [38] H.L. Li, X.M. Bai, W. Tan, Impacts of plug-in hybrid electric vehicles charging on distribution grid and smart charging, *2012 IEEE Int. Conf. Power Syst. Technol. POWERCON 2012.* (2012) 1–5. <https://doi.org/10.1109/PowerCon.2012.6401265>.
- [39] S. Deilami, A.S. Masoum, P.S. Moses, M.A.S. Masoum, Real-time coordination of plug-in electric vehicle charging in smart grids to minimize power losses and improve voltage profile, *IEEE Trans. Smart Grid.* 2 (2011) 456–467. <https://doi.org/10.1109/TSG.2011.2159816>.
- [40] E. Sortomme, M.M. Hindi, S.D.J. MacPherson, S.S. Venkata, Coordinated charging of plug-in hybrid electric vehicles to minimize distribution system losses, *IEEE Trans. Smart Grid.* 2 (2011) 186–193. <https://doi.org/10.1109/TSG.2010.2090913>.
- [41] M.J. Rutherford, V. Yousefzadeh, The impact of electric vehicle battery charging on distribution transformers, in: *Conf. Proc. - IEEE Appl. Power Electron. Conf. Expo. - APEC*, 2011: pp. 396–400. <https://doi.org/10.1109/APEC.2011.5744627>.
- [42] G. Razeghi, L. Zhang, T. Brown, S. Samuelsen, Impacts of plug-in hybrid electric vehicles on a residential transformer using stochastic and empirical analysis, *J. Power Sources.* 252 (2014) 277–285. <https://doi.org/10.1016/j.jpowsour.2013.11.089>.
- [43] M.A.S. Masoum, P.S. Moses, S. Deilami, Load management in smart grids considering harmonic distortion and transformer derating, *Innov. Smart Grid Technol. Conf. ISGT 2010.* (2010) 1–7.

- <https://doi.org/10.1109/ISGT.2010.5434738>.
- [44] K. Mahmud, G.E. Town, A review of computer tools for modeling electric vehicle energy requirements and their impact on power distribution networks, *Appl. Energy*. 172 (2016) 337–359. <https://doi.org/10.1016/j.apenergy.2016.03.100>.
- [45] K. Mahmud, G.E. Town, S. Morsalin, M.J. Hossain, Integration of electric vehicles and management in the internet of energy, *Renew. Sustain. Energy Rev.* 82 (2018) 4179–4203. <https://doi.org/10.1016/j.rser.2017.11.004>.
- [46] H. Budde-Meiwes, J. Drillkens, B. Lunz, J. Muennix, S. Rothgang, J. Kowal, D.U. Sauer, A review of current automotive battery technology and future prospects, *Proc. Inst. Mech. Eng. Part D J. Automob. Eng.* 227 (2013) 761–776. <https://doi.org/10.1177/0954407013485567>.
- [47] Y. Liu, Y. Zhu, Y. Cui, Challenges and opportunities towards fast-charging battery materials, *Nat. Energy*. 4 (2019) 540–550. <https://doi.org/10.1038/s41560-019-0405-3>.
- [48] X. Shu, W. Yang, Y. Guo, K. Wei, B. Qin, G. Zhu, A reliability study of electric vehicle battery from the perspective of power supply system, *J. Power Sources*. 451 (2020) 227805. <https://doi.org/10.1016/j.jpowsour.2020.227805>.
- [49] G.P. Beauregard, A.Z. Phoenix, Report of investigation: Hybrids plus plug in hybrid electric vehicle, Natl. Rural Electr. Coop. Assoc. Inc. US Dep. Energy, Idaho Natl. Lab. by Etec, Online Im Internet URL Http://Www.Evworld.Com/Library/Prius_fire_forensics.Pdf [Stand 11.04. 2012]. (2008).
- [50] Y. Li, K. Liu, A.M. Foley, A. Zülke, M. Berecibar, E. Nanini-Maury, J. Van Mierlo, H.E. Hoster, Data-driven health estimation and lifetime prediction of lithium-ion batteries: A review, *Renew. Sustain. Energy Rev.* 113 (2019) 109254. <https://doi.org/10.1016/j.rser.2019.109254>.
- [51] J.E. Harlow, X. Ma, J. Li, E. Logan, Y. Liu, N. Zhang, L. Ma, S.L. Glazier, M.M.E. Cormier, M. Genovese, S. Buteau, A. Cameron, J.E. Stark, J.R. Dahn, A Wide Range of Testing Results on an Excellent Lithium-Ion Cell Chemistry to be used as Benchmarks for New Battery Technologies, *J. Electrochem. Soc.* 166 (2019) A3031–A3044. <https://doi.org/10.1149/2.0981913jes>.
- [52] F.H. Gandoman, A. Ahmadi, P. Van den Bossche, J. Van Mierlo, N. Omar, A.E. Nezhad, H. Mavalizadeh, C. Mayet, Status and future perspectives of reliability assessment for electric vehicles, *Reliab. Eng. Syst. Saf.* 183 (2019) 1–16. <https://doi.org/10.1016/j.ress.2018.11.013>.
- [53] M.S. Hossain Lipu, M.A. Hannan, T.F. Karim, A. Hussain, M.H.M. Saad, A. Ayob, M.S. Miah, T.M. Indra Mahlia, Intelligent algorithms and control strategies for battery management system in electric vehicles: Progress, challenges and future outlook, *J. Clean. Prod.* 292 (2021). <https://doi.org/10.1016/j.jclepro.2021.126044>.
- [54] Q. Wang, B. Mao, S.I. Stolarov, J. Sun, A review of lithium ion battery failure mechanisms and fire prevention strategies, *Prog. Energy Combust. Sci.* 73 (2019) 95–131. <https://doi.org/10.1016/j.pecs.2019.03.002>.
- [55] L. Lu, X. Han, J. Li, J. Hua, M. Ouyang, A review on the key issues for lithium-ion battery management in electric vehicles, *J. Power Sources*. 226 (2013) 272–288. <https://doi.org/10.1016/j.jpowsour.2012.10.060>.
- [56] Y. Xing, E.W.M. Ma, K.L. Tsui, M. Pecht, Battery management systems in electric and hybrid vehicles, *Energies*. 4 (2011) 1840–1857. <https://doi.org/10.3390/en4111840>.

- [57] J.D. Kozlowski, Electrochemical cell prognostics using online impedance measurements and model-based data fusion techniques, *IEEE Aerosp. Conf. Proc.* 7 (2003) 3257–3270. <https://doi.org/10.1109/AERO.2003.1234169>.
- [58] A.A. Pesaran, Battery thermal models for hybrid vehicle simulations, in: *J. Power Sources*, Elsevier, 2002: pp. 377–382. [https://doi.org/10.1016/S0378-7753\(02\)00200-8](https://doi.org/10.1016/S0378-7753(02)00200-8).
- [59] M. Ng, J. Zhao, Q. Yan, G.J. Conduit, Z.W. Seh, Predicting the state of charge and health of batteries using data-driven machine learning, *Nat. Mach. Intell.* 2 (2020) 161–170. <https://doi.org/10.1038/s42256-020-0156-7>.
- [60] H. Tian, P. Qin, K. Li, Z. Zhao, A review of the state of health for lithium-ion batteries: Research status and suggestions, *J. Clean. Prod.* (2020). <https://doi.org/10.1016/j.jclepro.2020.120813>.
- [61] S. Wu, R. Xiong, H. Li, V. Nian, S. Ma, The state of the art on preheating lithium-ion batteries in cold weather, *J. Energy Storage.* 27 (2020) 101059. <https://doi.org/10.1016/j.est.2019.101059>.
- [62] Z. Liu, C. Tan, F. Leng, A reliability-based design concept for lithium-ion battery pack in electric vehicles, *Reliab. Eng. Syst. Saf.* 134 (2015) 169–177. <https://doi.org/10.1016/j.res.2014.10.010>.
- [63] J. Kim, J. Oh, H. Lee, Review on battery thermal management system for electric vehicles, *Appl. Therm. Eng.* 149 (2019) 192–212. <https://doi.org/10.1016/j.applthermaleng.2018.12.020>.
- [64] W. Wu, S. Wang, W. Wu, K. Chen, S. Hong, Y. Lai, A critical review of battery thermal performance and liquid based battery thermal management, *Energy Convers. Manag.* 182 (2019) 262–281. <https://doi.org/10.1016/j.enconman.2018.12.051>.
- [65] J. Chen, S. Kang, J. E, Z. Huang, K. Wei, B. Zhang, H. Zhu, Y. Deng, F. Zhang, G. Liao, Effects of different phase change material thermal management strategies on the cooling performance of the power lithium ion batteries: A review, *J. Power Sources.* 442 (2019) 227228. <https://doi.org/10.1016/j.jpowsour.2019.227228>.
- [66] S. Lei, Y. Shi, G. Chen, A lithium-ion battery-thermal-management design based on phase-change-material thermal storage and spray cooling, *Appl. Therm. Eng.* 168 (2020) 114792. <https://doi.org/10.1016/j.applthermaleng.2019.114792>.
- [67] C.H. Wang, T. Lin, J.T. Huang, Z.H. Rao, Temperature response of a high power lithium-ion battery subjected to high current discharge, *Mater. Res. Innov.* 19 (2015) S2156–S2160. <https://doi.org/10.1179/1432891715Z.0000000001318>.
- [68] X. Hu, Y. Zheng, D.A. Howey, H. Perez, A. Foley, M. Pecht, Battery warm-up methodologies at subzero temperatures for automotive applications: Recent advances and perspectives, *Prog. Energy Combust. Sci.* 77 (2020) 100806. <https://doi.org/10.1016/j.peccs.2019.100806>.
- [69] A.A. Pesaran, N. Renewable, A.A. Pesaran, Battery Thermal Management in EVs and HEVs : Issues and Solutions Battery Thermal Management in EVs and HEVs : Issues and Solutions, (2001).
- [70] K. Benabdelaziz, B. Lebrouhi, A. Maftah, M. Maaroufi, Novel external cooling solution for electric vehicle battery pack, *Energy Reports.* 6 (2019) 262–272. <https://doi.org/10.1016/j.egyr.2019.10.043>.
- [71] W. Zichen, D. Changqing, A comprehensive review on thermal management systems for power lithium-ion batteries, *Renew. Sustain. Energy Rev.* 139 (2021) 110685. <https://doi.org/10.1016/j.rser.2020.110685>.
- [72] B. Lamrani, B.E. Lebrouhi, Y. Khattari, T. Kousksou, A simplified thermal model for a lithium-ion

- battery pack with phase change material thermal management system, *J. Energy Storage*. 44 (2021) 103377. <https://doi.org/10.1016/J.EST.2021.103377>.
- [73] K.J. Kelly, M. Mihalie, M. Zolot, Battery Usage and Thermal Performance of the Toyota Prius and Honda Insight during Chassis Dynamometer Testing XVII . The Seventeenth Annual Battery Conference on Applications and Advances, *Batter. Conf. Appl. Adv.* 2002. Seventeenth Annu. (2002) 247–252.
- [74] T. Wang, K.J. Tseng, J. Zhao, Development of efficient air-cooling strategies for lithium-ion battery module based on empirical heat source model, *Appl. Therm. Eng.* 90 (2015) 521–529. <https://doi.org/10.1016/j.applthermaleng.2015.07.033>.
- [75] R. Matthé, U. Eberle, *The Voltec System-Energy Storage and Electric Propulsion*, Elsevier, 2014. <https://doi.org/10.1016/B978-0-444-59513-3.00008-X>.
- [76] P. Chen, Z. Lu, L. Ji, Y. Li, Design of the control scheme of power battery low temperature charging heating based on the real vehicle applications, 2013 9th IEEE Veh. Power Propuls. Conf. IEEE VPPC 2013. 4 (2013) 105–110. <https://doi.org/10.1109/VPPC.2013.6671673>.
- [77] A.A. Pesaran, S. Burch, M. Keyser, An approach for designing thermal management systems for electric and hybrid vehicle battery packs, *Proc. 4th Veh. Therm. Manag. Syst.* (1999) 24–27.
- [78] G. Karimi, X. Li, Thermal management of lithium-ion batteries for electric vehicles, *Int. J. Energy Res.* 37 (2013) 13–24. <https://doi.org/10.1002/er.1956>.
- [79] Z.H. Rao, S.F. Wang, Y.L. Zhang, Thermal management with phase change material for a power battery under cold temperatures, *Energy Sources, Part A Recover. Util. Environ. Eff.* 36 (2014) 2287–2295. <https://doi.org/10.1080/15567036.2011.576411>.
- [80] S. Al-Hallaj, J.R. Selman, Thermal modeling of secondary lithium batteries for electric vehicle/hybrid electric vehicle applications, in: *J. Power Sources*, Elsevier, 2002: pp. 341–348. [https://doi.org/10.1016/S0378-7753\(02\)00196-9](https://doi.org/10.1016/S0378-7753(02)00196-9).
- [81] C. Alaoui, Z.M. Salameh, A novel thermal management for electric and hybrid vehicles, *IEEE Trans. Veh. Technol.* 54 (2005) 468–476. <https://doi.org/10.1109/TVT.2004.842444>.
- [82] Kohei Umezu, H. Noyama, *Air-Conditioning system For Electric Vehicles*, 2010.
- [83] J. Laurikko, R. Granström, A. Haakana, Realistic estimates of EV range based on extensive laboratory and field tests in Nordic climate conditions, *World Electr. Veh. J.* 6 (2013) 192–203. <https://doi.org/10.3390/wevj6010192>.
- [84] J. WANG, CN101710630A - Vehicle lithium battery intelligent charging method and device thereof - Google Patents, n.d.
- [85] Q. Peng, H. Zhao, X. Liu, Y. Fang, X. Zeng, Battery thermal management system design and control strategy study for hybrid electric vehicles, *IEEE Transp. Electrif. Conf. Expo, ITEC Asia-Pacific 2014 - Conf. Proc.* (2014) 1–4. <https://doi.org/10.1109/ITEC-AP.2014.6941245>.
- [86] C.Y. Wang, G. Zhang, S. Ge, T. Xu, Y. Ji, X.G. Yang, Y. Leng, Lithium-ion battery structure that self-heats at low temperatures, *Nature*. 529 (2016) 515–518. <https://doi.org/10.1038/nature16502>.
- [87] Z.G. Qu, Z.Y. Jiang, Q. Wang, Experimental study on pulse self-heating of lithium-ion battery at low temperature, *Int. J. Heat Mass Transf.* 135 (2019) 696–705. <https://doi.org/10.1016/j.ijheatmasstransfer.2019.02.020>.
- [88] R. Xiong, Q. Yu, W. Shen, C. Lin, F. Sun, A Sensor Fault Diagnosis Method for a Lithium-Ion Battery

- Pack in Electric Vehicles, *IEEE Trans. Power Electron.* 34 (2019) 9709–9718. <https://doi.org/10.1109/TPEL.2019.2893622>.
- [89] Y. Ji, C.Y. Wang, Heating strategies for Li-ion batteries operated from subzero temperatures, *Electrochim. Acta.* 107 (2013) 664–674. <https://doi.org/10.1016/j.electacta.2013.03.147>.
- [90] J. qiu Li, L. Fang, W. Shi, X. Jin, Layered thermal model with sinusoidal alternate current for cylindrical lithium-ion battery at low temperature, *Energy.* 148 (2018) 247–257. <https://doi.org/10.1016/j.energy.2018.01.024>.
- [91] T.A. Stuart, A. Hande, HEV battery heating using AC currents, *J. Power Sources.* 129 (2004) 368–378. <https://doi.org/10.1016/j.jpowsour.2003.10.014>.
- [92] J. Jaguemont, L. Boulon, Y. Dubé, A comprehensive review of lithium-ion batteries used in hybrid and electric vehicles at cold temperatures, *Appl. Energy.* 164 (2016) 99–114. <https://doi.org/10.1016/j.apenergy.2015.11.034>.
- [93] M. Zuniga, J. Jaguemont, L. Boulon, Y. Dube, Heating Lithium-Ion Batteries with Bidirectional Current Pulses, 2015 IEEE Veh. Power Propuls. Conf. VPPC 2015 - Proc. (2015). <https://doi.org/10.1109/VPPC.2015.7352959>.
- [94] K.A. Severson, P.M. Attia, N. Jin, N. Perkins, B. Jiang, Z. Yang, M.H. Chen, M. Aykol, P.K. Herring, D. Fraggedakis, M.Z. Bazant, S.J. Harris, W.C. Chueh, R.D. Braatz, Data-driven prediction of battery cycle life before capacity degradation, *Nat. Energy.* 4 (2019) 383–391. <https://doi.org/10.1038/s41560-019-0356-8>.
- [95] A. Nuhic, T. Terzimehic, T. Soczka-Guth, M. Buchholz, K. Dietmayer, Health diagnosis and remaining useful life prognostics of lithium-ion batteries using data-driven methods, *J. Power Sources.* 239 (2013) 680–688. <https://doi.org/10.1016/j.jpowsour.2012.11.146>.
- [96] H. Meng, Y.F. Li, A review on prognostics and health management (PHM) methods of lithium-ion batteries, *Renew. Sustain. Energy Rev.* 116 (2019) 109405. <https://doi.org/10.1016/j.rser.2019.109405>.
- [97] Y. Li, D.I. Stroe, Y. Cheng, H. Sheng, X. Sui, R. Teodorescu, On the feature selection for battery state of health estimation based on charging–discharging profiles, *J. Energy Storage.* 33 (2021) 102122. <https://doi.org/10.1016/j.est.2020.102122>.
- [98] M. Doyle, Modeling of Galvanostatic Charge and Discharge of the Lithium/Polymer/Insertion Cell, *J. Electrochem. Soc.* 140 (1993) 1526. <https://doi.org/10.1149/1.2221597>.
- [99] M. Doyle, Comparison of Modeling Predictions with Experimental Data from Plastic Lithium Ion Cells, *J. Electrochem. Soc.* 143 (1996) 1890. <https://doi.org/10.1149/1.1836921>.
- [100] V.H. Johnson, Battery performance models in ADVISOR, in: *J. Power Sources*, Elsevier, 2002: pp. 321–329. [https://doi.org/10.1016/S0378-7753\(02\)00194-5](https://doi.org/10.1016/S0378-7753(02)00194-5).
- [101] M. Yazdanpour, P. Taheri, A. Mansouri, B. Schweitzer, A circuit-based approach for electro-Thermal modeling of lithium-ion batteries, in: *Annu. IEEE Semicond. Therm. Meas. Manag. Symp.*, Institute of Electrical and Electronics Engineers Inc., 2016: pp. 113–127. <https://doi.org/10.1109/SEMI-THERM.2016.7458455>.
- [102] M. Ouyang, G. Liu, L. Lu, J. Li, X. Han, Enhancing the estimation accuracy in low state-of-charge area: A novel onboard battery model through surface state of charge determination, *J. Power Sources.* 270 (2014) 221–237. <https://doi.org/10.1016/j.jpowsour.2014.07.090>.

- [103] Y. Guo, Z. Zhao, L. Huang, SoC Estimation of Lithium Battery Based on Improved BP Neural Network, in: *Energy Procedia*, Elsevier Ltd, 2017: pp. 4153–4158. <https://doi.org/10.1016/j.egypro.2017.03.881>.
- [104] M.S.H. Lipu, M.A. Hannan, A. Hussain, M.M. Hoque, P.J. Ker, M.H.M. Saad, A. Ayob, A review of state of health and remaining useful life estimation methods for lithium-ion battery in electric vehicles: Challenges and recommendations, *J. Clean. Prod.* 205 (2018) 115–133. <https://doi.org/10.1016/j.jclepro.2018.09.065>.
- [105] M.A. Hannan, M.S.H. Lipu, A. Hussain, A. Mohamed, A review of lithium-ion battery state of charge estimation and management system in electric vehicle applications: Challenges and recommendations, *Renew. Sustain. Energy Rev.* 78 (2017) 834–854. <https://doi.org/10.1016/j.rser.2017.05.001>.
- [106] L. Ungurean, G. Cârstoiu, M. V. Micea, V. Groza, Battery state of health estimation: a structured review of models, methods and commercial devices, *Int. J. Energy Res.* 41 (2017) 151–181. <https://doi.org/10.1002/er.3598>.
- [107] X. Wang, X. Wei, H. Dai, Q. Wu, State Estimation of Lithium Ion Battery Based on Electrochemical Impedance Spectroscopy with On-Board Impedance Measurement System, 2015 IEEE Veh. Power Propuls. Conf. VPPC 2015 - Proc. (2015). <https://doi.org/10.1109/VPPC.2015.7353021>.
- [108] M.A. Rahman, S. Anwar, A. Izadian, Electrochemical model parameter identification of a lithium-ion battery using particle swarm optimization method, *J. Power Sources.* 307 (2016) 86–97. <https://doi.org/10.1016/j.jpowsour.2015.12.083>.
- [109] T. Bruen, J. Marco, Modelling and experimental evaluation of parallel connected lithium ion cells for an electric vehicle battery system, *J. Power Sources.* 310 (2016) 91–101. <https://doi.org/10.1016/j.jpowsour.2016.01.001>.
- [110] N. Khayat, N. Karami, Adaptive techniques used for lifetime estimation of lithium-ion batteries, in: 2016 3rd Int. Conf. Electr. Electron. Comput. Eng. Their Appl. EECEA 2016, Institute of Electrical and Electronics Engineers Inc., 2016: pp. 98–103. <https://doi.org/10.1109/EECEA.2016.7470773>.
- [111] C. Zhang, W. Allafi, Q. Dinh, P. Ascencio, J. Marco, Online estimation of battery equivalent circuit model parameters and state of charge using decoupled least squares technique, *Energy.* 142 (2018) 678–688. <https://doi.org/10.1016/j.energy.2017.10.043>.
- [112] I. Babaeiyazdi, A. Rezaei-Zare, S. Shokrzadeh, State of charge prediction of EV Li-ion batteries using EIS: A machine learning approach, *Energy.* 223 (2021) 120116. <https://doi.org/10.1016/j.energy.2021.120116>.
- [113] J.C. Álvarez Antón, P.J. García Nieto, F.J. De Cos Juez, F.S. Lasheras, C.B. Viejo, N. Roqueñí Gutiérrez, Battery state-of-charge estimator using the MARS technique, *IEEE Trans. Power Electron.* 28 (2013) 3798–3805. <https://doi.org/10.1109/TPEL.2012.2230026>.
- [114] H.H. Afshari, M. Attari, R. Ahmed, M. Farag, S. Habibi, Modeling, parameterization, and state of charge estimation of Li-Ion cells using a circuit model, in: 2016 IEEE Transp. Electrification Conf. Expo, ITEC 2016, Institute of Electrical and Electronics Engineers Inc., 2016. <https://doi.org/10.1109/ITEC.2016.7520301>.
- [115] C. Fleischer, W. Waag, Z. Bai, D.U. Sauer, Adaptive On-line State-of-available-power Prediction of Lithium-ion Batteries, 13 (2013).
- [116] T. Dong, J. Li, F. Zhao, Y. Yi, Q. Jin, Analysis on the influence of measurement error on state of charge estimation of LiFePO₄ power Battery, ICMREE2011 - Proc. 2011 Int. Conf. Mater. Renew. Energy

- Environ. 1 (2011) 644–649. <https://doi.org/10.1109/ICMREE.2011.5930893>.
- [117] X. Tang, B. Liu, F. Gao, State of Charge Estimation of LiFePO₄ Battery Based on a Gain-classifier Observer, *Energy Procedia*. 105 (2017) 2071–2076. <https://doi.org/10.1016/j.egypro.2017.03.585>.
- [118] Z. Guo, X. Qiu, G. Hou, B.Y. Liaw, C. Zhang, State of health estimation for lithium ion batteries based on charging curves, *J. Power Sources*. 249 (2014) 457–462. <https://doi.org/10.1016/j.jpowsour.2013.10.114>.
- [119] C. Truchot, M. Dubarry, B.Y. Liaw, State-of-charge estimation and uncertainty for lithium-ion battery strings, *Appl. Energy*. 119 (2014) 218–227. <https://doi.org/10.1016/j.apenergy.2013.12.046>.
- [120] X. Dang, L. Yan, K. Xu, X. Wu, H. Jiang, H. Sun, Open-Circuit Voltage-Based State of Charge Estimation of Lithium-ion Battery Using Dual Neural Network Fusion Battery Model, *Electrochim. Acta*. 188 (2016) 356–366. <https://doi.org/10.1016/j.electacta.2015.12.001>.
- [121] M.A. Roscher, D.U. Sauer, Dynamic electric behavior and open-circuit-voltage modeling of LiFePO₄-based lithium ion secondary batteries, *J. Power Sources*. 196 (2011) 331–336. <https://doi.org/10.1016/j.jpowsour.2010.06.098>.
- [122] J.P. Rivera-Barrera, N. Muñoz-Galeano, H.O. Sarmiento-Maldonado, Soc estimation for lithium-ion batteries: Review and future challenges, 2017. <https://doi.org/10.3390/electronics6040102>.
- [123] Y. Zhang, W. Song, S. Lin, Z. Feng, A novel model of the initial state of charge estimation for LiFePO₄ batteries, *J. Power Sources*. 248 (2014) 1028–1033. <https://doi.org/10.1016/j.jpowsour.2013.09.135>.
- [124] K.S. Ng, C.S. Moo, Y.P. Chen, Y.C. Hsieh, Enhanced coulomb counting method for estimating state-of-charge and state-of-health of lithium-ion batteries, *Appl. Energy*. 86 (2009) 1506–1511. <https://doi.org/10.1016/j.apenergy.2008.11.021>.
- [125] M. Li, Li-ion dynamics and state of charge estimation, *Renew. Energy*. 100 (2017) 44–52. <https://doi.org/10.1016/j.renene.2016.06.009>.
- [126] R. Mingant, J. Bernard, V. Sauvant Moynet, A. Delaille, S. Mailley, J.-L. Hognon, F. Huet, EIS Measurements for Determining the SoC and SoH of Li-Ion Batteries, 33 (2011) 41–53. <https://doi.org/10.1149/1.3589920>.
- [127] U. Westerhoff, T. Kroker, K. Kurbach, M. Kurrat, Electrochemical impedance spectroscopy based estimation of the state of charge of lithium-ion batteries, *J. Energy Storage*. 8 (2016) 244–256. <https://doi.org/10.1016/j.est.2016.09.001>.
- [128] B. Liebhart, L. Komsijska, C. Endisch, Passive impedance spectroscopy for monitoring lithium-ion battery cells during vehicle operation, *J. Power Sources*. 449 (2020) 227297. <https://doi.org/10.1016/j.jpowsour.2019.227297>.
- [129] C. Yang, X. Wang, Q. Fang, H. Dai, Y. Cao, X. Wei, An online SOC and capacity estimation method for aged lithium-ion battery pack considering cell inconsistency, *J. Energy Storage*. 29 (2020) 101250. <https://doi.org/10.1016/j.est.2020.101250>.
- [130] Q. Wang, J. Wang, P. Zhao, J. Kang, F. Yan, C. Du, Correlation between the model accuracy and model-based SOC estimation, *Electrochim. Acta*. 228 (2017) 146–159. <https://doi.org/10.1016/j.electacta.2017.01.057>.
- [131] H. Dai, P. Guo, X. Wei, Z. Sun, J. Wang, ANFIS (adaptive neuro-fuzzy inference system) based online SOC (State of Charge) correction considering cell divergence for the EV (electric vehicle) traction

- batteries, *Energy*. 80 (2015) 350–360. <https://doi.org/10.1016/j.energy.2014.11.077>.
- [132] J. Yang, B. Xia, Y. Shang, W. Huang, C. Mi, Improved battery modeling approach considering operating scenarios for HEV/EV applications, *Conf. Proc. - IEEE Appl. Power Electron. Conf. Expo. - APEC*. (2017) 1216–1222. <https://doi.org/10.1109/APEC.2017.7930850>.
- [133] H. Chaoui, C.C. Ibe-Ekeocha, H. Gualous, Aging prediction and state of charge estimation of a LiFePO₄ battery using input time-delayed neural networks, *Electr. Power Syst. Res.* 146 (2017) 189–197. <https://doi.org/10.1016/j.epsr.2017.01.032>.
- [134] G. Liu, L. Lu, H. Fu, J. Hua, J. Li, M. Ouyang, Y. Wang, S. Xue, P. Chen, A comparative study of equivalent circuit models and enhanced equivalent circuit models of lithium-ion batteries with different model structures, *IEEE Transp. Electrification Conf. Expo, ITEC Asia-Pacific 2014 - Conf. Proc.* (2014) 1–6. <https://doi.org/10.1109/ITEC-AP.2014.6940946>.
- [135] R. Xiong, F. Sun, X. Gong, C. Gao, A data-driven based adaptive state of charge estimator of lithium-ion polymer battery used in electric vehicles, *Appl. Energy*. 113 (2014) 1421–1433. <https://doi.org/10.1016/j.apenergy.2013.09.006>.
- [136] Y. Xing, W. He, M. Pecht, K.L. Tsui, State of charge estimation of lithium-ion batteries using the open-circuit voltage at various ambient temperatures, *Appl. Energy*. 113 (2014) 106–115. <https://doi.org/10.1016/j.apenergy.2013.07.008>.
- [137] Y. Cao, R.C. Kroeze, P.T. Krein, Multi-timescale parametric electrical battery model for use in dynamic electric vehicle simulations, *IEEE Trans. Transp. Electrification*. 2 (2016) 432–442. <https://doi.org/10.1109/TTE.2016.2569069>.
- [138] W. Li, D. Cao, D. Jöst, F. Ringbeck, M. Kuipers, F. Frie, D.U. Sauer, Parameter sensitivity analysis of electrochemical model-based battery management systems for lithium-ion batteries, *Appl. Energy*. 269 (2020) 115104. <https://doi.org/10.1016/j.apenergy.2020.115104>.
- [139] S.S. Madani, M.J. Swierczynski, S.K. Kaer, The discharge behavior of lithium-ion batteries using the Dual-Potential Multi-Scale Multi-Dimensional (MSMD) Battery Model, 2017 12th Int. Conf. Ecol. Veh. Renew. Energies, EVER 2017. (2017). <https://doi.org/10.1109/EVER.2017.7935915>.
- [140] S.J. Moura, F.B. Argomedeo, R. Klein, A. Mirtabatabaei, M. Krstic, Battery State Estimation for a Single Particle Model With Electrolyte Dynamics, (2016) 1–16.
- [141] C. Zou, C. Manzie, D. Nestic, A Framework for Simplification of PDE-Based Lithium-Ion Battery Models, *IEEE Trans. Control Syst. Technol.* 24 (2016) 1594–1609. <https://doi.org/10.1109/TCST.2015.2502899>.
- [142] A. Bartlett, J. Marcicki, S. Onori, G. Rizzoni, X.G. Yang, T. Miller, Electrochemical Model-Based State of Charge and Capacity Estimation for a Composite Electrode Lithium-Ion Battery, *IEEE Trans. Control Syst. Technol.* 24 (2016) 384–399. <https://doi.org/10.1109/TCST.2015.2446947>.
- [143] R. Ahmed, M. El Sayed, I. Arasaratnam, J. Tjong, S. Habibi, Reduced-Order Electrochemical Model Parameters Identification and State of Charge Estimation for Healthy and Aged Li-Ion Batteries—Part II: Aged Battery Model and State of Charge Estimation, *IEEE J. Emerg. Sel. Top. Power Electron.* 2 (2014) 678–690. <https://doi.org/10.1109/jestpe.2014.2331062>.
- [144] Y. Zheng, M. Ouyang, X. Han, L. Lu, J. Li, Investigating the error sources of the online state of charge estimation methods for lithium-ion batteries in electric vehicles, *J. Power Sources*. 377 (2018) 161–188.

- <https://doi.org/10.1016/j.jpowsour.2017.11.094>.
- [145] L. Xu, J. Wang, Q. Chen, Kalman filtering state of charge estimation for battery management system based on a stochastic fuzzy neural network battery model, *Energy Convers. Manag.* 53 (2012) 33–39. <https://doi.org/10.1016/j.enconman.2011.06.003>.
- [146] M. Urbain, S. Raël, B. Davat, P. Desprez, State estimation of a lithium-ion battery through Kalman filter, in: *PESC Rec. - IEEE Annu. Power Electron. Spec. Conf.*, 2007: pp. 2804–2810. <https://doi.org/10.1109/PESC.2007.4342463>.
- [147] M.W. Yatsui, H. Bai, Kalman filter based state-of-charge estimation for lithium-ion batteries in hybrid electric vehicles using pulse charging, in: *2011 IEEE Veh. Power Propuls. Conf. VPPC 2011*, 2011. <https://doi.org/10.1109/VPPC.2011.6042988>.
- [148] L. Wang, L. Wang, C. Liao, Research on improved EKF algorithm applied on estimate EV battery SOC, in: *Asia-Pacific Power Energy Eng. Conf. APPEEC*, 2010. <https://doi.org/10.1109/APPEEC.2010.5448581>.
- [149] R. Xiong, H. He, F. Sun, K. Zhao, Evaluation on State of Charge estimation of batteries with adaptive extended kalman filter by experiment approach, *IEEE Trans. Veh. Technol.* 62 (2013) 108–117. <https://doi.org/10.1109/TVT.2012.2222684>.
- [150] Z. Chen, Y. Fu, C.C. Mi, State of charge estimation of lithium-ion batteries in electric drive vehicles using extended Kalman filtering, *IEEE Trans. Veh. Technol.* 62 (2013) 1020–1030. <https://doi.org/10.1109/TVT.2012.2235474>.
- [151] S.J. Lee, J.H. Kim, J.M. Lee, B.H. Cho, The state and parameter estimation of an Li-Ion battery using a new OCV-SOC concept, in: *PESC Rec. - IEEE Annu. Power Electron. Spec. Conf.*, 2007: pp. 2799–2803. <https://doi.org/10.1109/PESC.2007.4342462>.
- [152] R. Xiong, J. Tian, W. Shen, F. Sun, A Novel Fractional Order Model for State of Charge Estimation in Lithium Ion Batteries, *IEEE Trans. Veh. Technol.* 68 (2019) 4130–4139. <https://doi.org/10.1109/TVT.2018.2880085>.
- [153] D. Andre, C. Appel, T. Soczka-Guth, D.U. Sauer, Advanced mathematical methods of SOC and SOH estimation for lithium-ion batteries, *J. Power Sources.* 224 (2013) 20–27. <https://doi.org/10.1016/j.jpowsour.2012.10.001>.
- [154] J. Peng, J. Luo, H. He, B. Lu, An improved state of charge estimation method based on cubature Kalman filter for lithium-ion batteries, *Appl. Energy.* 253 (2019) 113520. <https://doi.org/10.1016/j.apenergy.2019.113520>.
- [155] Q. Zhu, L. Li, X. Hu, N. Xiong, G. Di Hu, H_∞ -based nonlinear observer design for state of charge estimation of Lithium-ion battery with polynomial parameters, *IEEE Trans. Veh. Technol.* 66 (2017) 10853–10865. <https://doi.org/10.1109/TVT.2017.2723522>.
- [156] C. Yang, X. Wang, Q. Fang, H. Dai, Y. Cao, X. Wei, An online SOC and capacity estimation method for aged lithium-ion battery pack considering cell inconsistency, *J. Energy Storage.* 29 (2020) 101250. <https://doi.org/10.1016/j.est.2020.101250>.
- [157] Y. Li, C. Wang, J. Gong, A wavelet transform-adaptive unscented Kalman filter approach for state of charge estimation of LiFePo_4 battery, *Int. J. Energy Res.* 42 (2018) 587–600. <https://doi.org/10.1002/er.3842>.

- [158] Z. Zeng, J. Tian, D. Li, Y. Tian, An Online State of Charge Estimation Algorithm for Lithium-Ion Batteries Using an Improved Adaptive Cubature Kalman Filter, *Energies*. 11 (2018) 59. <https://doi.org/10.3390/en11010059>.
- [159] Y. Xu, M. Hu, A. Zhou, Y. Li, S. Li, C. Fu, C. Gong, State of charge estimation for lithium-ion batteries based on adaptive dual Kalman filter, *Appl. Math. Model.* 77 (2020) 1255–1272. <https://doi.org/10.1016/j.apm.2019.09.011>.
- [160] D.J. Xuan, Z. Shi, J. Chen, C. Zhang, Y.X. Wang, Real-time estimation of state-of-charge in lithium-ion batteries using improved central difference transform method, *J. Clean. Prod.* 252 (2020) 119787. <https://doi.org/10.1016/j.jclepro.2019.119787>.
- [161] Y. Li, J. Chen, F. Lan, Enhanced online model identification and state of charge estimation for lithium-ion battery under noise corrupted measurements by bias compensation recursive least squares, *J. Power Sources*. 456 (2020) 227984. <https://doi.org/10.1016/j.jpowsour.2020.227984>.
- [162] L. Fang, J. Li, B. Peng, Online estimation and error analysis of both SOC and SOH of lithium-ion battery based on DEKF method, in: *Energy Procedia*, Elsevier Ltd, 2019: pp. 3008–3013. <https://doi.org/10.1016/j.egypro.2019.01.974>.
- [163] Y. He, X.T. Liu, C. Bin Zhang, Z.H. Chen, A new model for State-of-Charge (SOC) estimation for high-power Li-ion batteries, *Appl. Energy*. 101 (2013) 808–814. <https://doi.org/10.1016/j.apenergy.2012.08.031>.
- [164] M. Ye, H. Guo, R. Xiong, Q. Yu, A double-scale and adaptive particle filter-based online parameter and state of charge estimation method for lithium-ion batteries, *Energy*. 144 (2018) 789–799. <https://doi.org/10.1016/j.energy.2017.12.061>.
- [165] Z. Chen, H. Sun, G. Dong, J. Wei, J. Wu, Particle filter-based state-of-charge estimation and remaining-dischargeable-time prediction method for lithium-ion batteries, *J. Power Sources*. 414 (2019) 158–166. <https://doi.org/10.1016/j.jpowsour.2019.01.012>.
- [166] Y. Wang, Z. Chen, A framework for state-of-charge and remaining discharge time prediction using unscented particle filter, *Appl. Energy*. 260 (2020) 114324. <https://doi.org/10.1016/j.apenergy.2019.114324>.
- [167] M. Liu, M. He, S. Qiao, B. Liu, Z. Cao, R. Wang, A high-order state-of-charge estimation model by cubature particle filter, *Meas. J. Int. Meas. Confed.* 146 (2019) 35–42. <https://doi.org/10.1016/j.measurement.2019.05.040>.
- [168] R. Xiong, Q. Yu, L.Y. Wang, C. Lin, A novel method to obtain the open circuit voltage for the state of charge of lithium ion batteries in electric vehicles by using H infinity filter, *Appl. Energy*. 207 (2017) 346–353. <https://doi.org/10.1016/j.apenergy.2017.05.136>.
- [169] C.Z. Liu, Q. Zhu, L. Li, W.Q. Liu, L.Y. Wang, N. Xiong, X.Y. Wang, A State of Charge Estimation Method Based on H_{∞} Observer for Switched Systems of Lithium-Ion Nickel-Manganese-Cobalt Batteries, *IEEE Trans. Ind. Electron.* 64 (2017) 8128–8137. <https://doi.org/10.1109/TIE.2017.2701766>.
- [170] Y. Zhang, C. Zhang, X. Zhang, State-of-charge estimation of the lithium-ion battery system with time-varying parameter for hybrid electric vehicles, *IET Control Theory Appl.* 8 (2014) 160–167. <https://doi.org/10.1049/iet-cta.2013.0082>.
- [171] M. Charkhgard, M.H. Zarif, Design of adaptive H_{∞} filter for implementing on state-of-charge estimation

- based on battery state-of-charge-varying modelling, *IET Power Electron.* 8 (2015) 1825–1833. <https://doi.org/10.1049/iet-pel.2014.0523>.
- [172] F. He, W.X. Shen, A. Kapoor, D. Honnery, D. Dayawansa, H infinity observer based state of charge estimation for battery packs in electric vehicles, in: *Proc. 2016 IEEE 11th Conf. Ind. Electron. Appl. ICIEA 2016*, Institute of Electrical and Electronics Engineers Inc., 2016: pp. 694–699. <https://doi.org/10.1109/ICIEA.2016.7603672>.
- [173] C. Lin, H. Mu, R. Xiong, W. Shen, A novel multi-model probability battery state of charge estimation approach for electric vehicles using H-infinity algorithm, *Appl. Energy.* 166 (2016) 76–83. <https://doi.org/10.1016/j.apenergy.2016.01.010>.
- [174] J. Wang, R. Xiong, L. Li, Y. Fang, A comparative analysis and validation for double-filters-based state of charge estimators using battery-in-the-loop approach, *Appl. Energy.* 229 (2018) 648–659. <https://doi.org/10.1016/j.apenergy.2018.08.022>.
- [175] X. Shu, G. Li, J. Shen, W. Yan, Z. Chen, Y. Liu, An adaptive fusion estimation algorithm for state of charge of lithium-ion batteries considering wide operating temperature and degradation, *J. Power Sources.* 462 (2020) 228132. <https://doi.org/10.1016/j.jpowsour.2020.228132>.
- [176] E. Chemali, P.J. Kollmeyer, M. Preindl, A. Emadi, State-of-charge estimation of Li-ion batteries using deep neural networks: A machine learning approach, *J. Power Sources.* 400 (2018) 242–255. <https://doi.org/10.1016/j.jpowsour.2018.06.104>.
- [177] F. Yang, X. Song, F. Xu, K.L. Tsui, State-of-Charge Estimation of Lithium-Ion Batteries via Long Short-Term Memory Network, *IEEE Access.* 7 (2019) 53792–53799. <https://doi.org/10.1109/ACCESS.2019.2912803>.
- [178] H. Chaoui, C.C. Ibe-Ekeocha, State of Charge and State of Health Estimation for Lithium Batteries Using Recurrent Neural Networks, *IEEE Trans. Veh. Technol.* 66 (2017) 8773–8783. <https://doi.org/10.1109/TVT.2017.2715333>.
- [179] E. Chemali, P.J. Kollmeyer, M. Preindl, R. Ahmed, A. Emadi, Long Short-Term Memory Networks for Accurate State-of-Charge Estimation of Li-ion Batteries, *IEEE Trans. Ind. Electron.* 65 (2018) 6730–6739. <https://doi.org/10.1109/TIE.2017.2787586>.
- [180] J. Hong, Z. Wang, W. Chen, Y. Yao, Synchronous multi-parameter prediction of battery systems on electric vehicles using long short-term memory networks, *Appl. Energy.* 254 (2019) 113648. <https://doi.org/10.1016/j.apenergy.2019.113648>.
- [181] M.A. Hannan, M.S.H. Lipu, A. Hussain, P.J. Ker, T.M.I. Mahlia, M. Mansor, A. Ayob, M.H. Saad, Z.Y. Dong, Toward Enhanced State of Charge Estimation of Lithium-ion Batteries Using Optimized Machine Learning Techniques, *Sci. Rep.* 10 (2020) 1–15. <https://doi.org/10.1038/s41598-020-61464-7>.
- [182] G.O. Sahinoglu, M. Pajovic, Z. Sahinoglu, Y. Wang, P. V. Orlik, T. Wada, Battery State-of-Charge Estimation Based on Regular/Recurrent Gaussian Process Regression, *IEEE Trans. Ind. Electron.* 65 (2018) 4311–4321. <https://doi.org/10.1109/TIE.2017.2764869>.
- [183] T. Zahid, K. Xu, W. Li, C. Li, H. Li, State of charge estimation for electric vehicle power battery using advanced machine learning algorithm under diversified drive cycles, *Energy.* 162 (2018) 871–882. <https://doi.org/10.1016/j.energy.2018.08.071>.
- [184] J. Hou, Z. Song, A hierarchical energy management strategy for hybrid energy storage via vehicle-to-

- cloud connectivity, *Appl. Energy*. 257 (2020) 113900. <https://doi.org/10.1016/j.apenergy.2019.113900>.
- [185] R.R. Richardson, M.A. Osborne, D.A. Howey, Gaussian process regression for forecasting battery state of health, *J. Power Sources*. 357 (2017) 209–219. <https://doi.org/10.1016/j.jpowsour.2017.05.004>.
- [186] S. Albelwi, A. Mahmood, A Framework for Designing the Architectures of Deep Convolutional Neural Networks, *Entropy*. 19 (2017) 242. <https://doi.org/10.3390/e19060242>.
- [187] W. He, N. Williard, C. Chen, M. Pecht, State of charge estimation for Li-ion batteries using neural network modeling and unscented Kalman filter-based error cancellation, *Int. J. Electr. Power Energy Syst.* 62 (2014) 783–791. <https://doi.org/10.1016/j.ijepes.2014.04.059>.
- [188] T. Zahid, F. Qin, W. Li, K. Xu, Y. Zhou, Sequential Monte Carlo based technique for SOC estimation of LiFePO₄ battery pack for electric vehicles, in: 2016 IEEE Int. Conf. Inf. Autom. IEEE ICIA 2016, Institute of Electrical and Electronics Engineers Inc., 2017: pp. 1308–1312. <https://doi.org/10.1109/ICInfA.2016.7832021>.
- [189] H. Han, H. Xu, Z. Yuan, Y. Zhao, State of Charge estimation of Li-ion battery in EVs based on second-order sliding mode observer, in: IEEE Transp. Electrification Conf. Expo, ITEC Asia-Pacific 2014 - Conf. Proc., Institute of Electrical and Electronics Engineers Inc., 2014. <https://doi.org/10.1109/ITEC-AP.2014.6941100>.
- [190] X. Tang, B. Liu, Z. Lv, F. Gao, Observer based battery SOC estimation: Using multi-gain-switching approach, *Appl. Energy*. 204 (2017) 1275–1283. <https://doi.org/10.1016/j.apenergy.2017.03.079>.
- [191] C. Weng, J. Sun, H. Peng, A unified open-circuit-voltage model of lithium-ion batteries for state-of-charge estimation and state-of-health monitoring, *J. Power Sources*. 258 (2014) 228–237. <https://doi.org/10.1016/j.jpowsour.2014.02.026>.
- [192] W. Waag, D.U. Sauer, Adaptive estimation of the electromotive force of the lithium-ion battery after current interruption for an accurate state-of-charge and capacity determination, *Appl. Energy*. 111 (2013) 416–427. <https://doi.org/10.1016/j.apenergy.2013.05.001>.
- [193] A. Eddahech, O. Briat, N. Bertrand, J.Y. Delétage, J.M. Vinassa, Behavior and state-of-health monitoring of Li-ion batteries using impedance spectroscopy and recurrent neural networks, *Int. J. Electr. Power Energy Syst.* 42 (2012) 487–494. <https://doi.org/10.1016/j.ijepes.2012.04.050>.
- [194] H. He, X. Zhang, R. Xiong, Y. Xu, H. Guo, Online model-based estimation of state-of-charge and open-circuit voltage of lithium-ion batteries in electric vehicles, *Energy*. 39 (2012) 310–318. <https://doi.org/10.1016/j.energy.2012.01.009>.
- [195] J. Kim, S. Lee, B.H. Cho, Complementary cooperation algorithm based on DEKF combined with pattern recognition for SOC/capacity estimation and SOH prediction, *IEEE Trans. Power Electron.* 27 (2012) 436–451. <https://doi.org/10.1109/TPEL.2011.2158554>.
- [196] C. Jiang, A. Taylor, C. Duan, K. Bai, Extended Kalman Filter based battery state of charge(SOC) estimation for electric vehicles, in: 2013 IEEE Transp. Electrification Conf. Expo Components, Syst. Power Electron. - From Technol. to Bus. Public Policy, ITEC 2013, 2013. <https://doi.org/10.1109/ITEC.2013.6573477>.
- [197] Y. Tian, B. Xia, W. Sun, Z. Xu, W. Zheng, A modified model based state of charge estimation of power lithium-ion batteries using unscented Kalman filter, *J. Power Sources*. 270 (2014) 619–626. <https://doi.org/10.1016/j.jpowsour.2014.07.143>.

- [198] G.L. Plett, Sigma-point Kalman filtering for battery management systems of LiPB-based HEV battery packs. Part 1: Introduction and state estimation, *J. Power Sources*. 161 (2006) 1356–1368. <https://doi.org/10.1016/j.jpowsour.2006.06.003>.
- [199] S. Schwunk, N. Armbruster, S. Straub, J. Kehl, M. Vetter, Particle filter for state of charge and state of health estimation for lithium-iron phosphate batteries, *J. Power Sources*. 239 (2013) 705–710. <https://doi.org/10.1016/j.jpowsour.2012.10.058>.
- [200] Q. Miao, L. Xie, H. Cui, W. Liang, M. Pecht, Remaining useful life prediction of lithium-ion battery with unscented particle filter technique, *Microelectron. Reliab.* 53 (2013) 805–810. <https://doi.org/10.1016/j.microrel.2012.12.004>.
- [201] B. Long, W. Xian, L. Jiang, Z. Liu, An improved autoregressive model by particle swarm optimization for prognostics of lithium-ion batteries, *Microelectron. Reliab.* 53 (2013) 821–831. <https://doi.org/10.1016/j.microrel.2013.01.006>.
- [202] W. Wang, H.S.H. Chung, J. Zhang, Near-real-time parameter estimation of an electrical battery model with multiple time constants and SoC-dependent capacitance, in: 2014 IEEE Energy Convers. Congr. Expo. ECCE 2014, Institute of Electrical and Electronics Engineers Inc., 2014: pp. 3977–3984. <https://doi.org/10.1109/ECCE.2014.6953942>.
- [203] Y. Zheng, L. Lu, X. Han, J. Li, M. Ouyang, LiFePO₄ battery pack capacity estimation for electric vehicles based on charging cell voltage curve transformation, *J. Power Sources*. 226 (2013) 33–41. <https://doi.org/10.1016/j.jpowsour.2012.10.057>.
- [204] H.T. Lin, T.J. Liang, S.M. Chen, The state-of-health diagnosis of Li-Co batteries with fuzzy identification, in: Conf. Proc. - 2012 IEEE 7th Int. Power Electron. Motion Control Conf. - ECCE Asia, IPENC 2012, 2012: pp. 2678–2682. <https://doi.org/10.1109/IPENC.2012.6259285>.
- [205] J.N. Hu, J.J. Hu, H.B. Lin, X.P. Li, C.L. Jiang, X.H. Qiu, W.S. Li, State-of-charge estimation for battery management system using optimized support vector machine for regression, *J. Power Sources*. 269 (2014) 682–693. <https://doi.org/10.1016/j.jpowsour.2014.07.016>.
- [206] S.S. Mansouri, P. Karvelis, G. Georgoulas, G. Nikolakopoulos, Remaining Useful Battery Life Prediction for UAVs based on Machine Learning, *IFAC-PapersOnLine*. 50 (2017) 4727–4732. <https://doi.org/10.1016/j.ifacol.2017.08.863>.
- [207] P. Khumprom, N. Yodo, A Data-Driven Predictive Prognostic Model for Lithium-Ion Batteries based on a Deep Learning Algorithm, *Energies*. 12 (2019) 660. <https://doi.org/10.3390/en12040660>.
- [208] J.C. Álvarez Antón, P.J. García Nieto, E. García Gonzalo, J.C. Viera Pérez, M. González Vega, C. Blanco Viejo, A New Predictive Model for the State-of-Charge of a High-Power Lithium-Ion Cell Based on a PSO-Optimized Multivariate Adaptive Regression Spline Approach, *IEEE Trans. Veh. Technol.* 65 (2016) 4197–4208. <https://doi.org/10.1109/TVT.2015.2504933>.
- [209] I.S. Kim, Nonlinear state of charge estimator for hybrid electric vehicle battery, *IEEE Trans. Power Electron.* 23 (2008) 2027–2034. <https://doi.org/10.1109/TPEL.2008.924629>.
- [210] X. Feng, J. Li, M. Ouyang, L. Lu, J. Li, X. He, Using probability density function to evaluate the state of health of lithium-ion batteries, *J. Power Sources*. 232 (2013) 209–218. <https://doi.org/10.1016/j.jpowsour.2013.01.018>.
- [211] C. Zhang, Y.L. Wei, P.F. Cao, M.C. Lin, Energy storage system: Current studies on batteries and power

- condition system, *Renew. Sustain. Energy Rev.* 82 (2018) 3091–3106. <https://doi.org/10.1016/j.rser.2017.10.030>.
- [212] B. Pack, P. Fall, A. Market, R. Up, W. Market, Battery Pack Prices Fall As Market Ramps Up With Market Average At \$156/kWh In 2019, BloombergNEF. (2019) Veronika Henze. <https://about.bnef.com/blog/battery-pack-prices-fall-as-market-ramps-up-with-market-average-at-156-kwh-in-2019/> (accessed June 17, 2020).
- [213] M.F. Lagadec, R. Zahn, V. Wood, Characterization and performance evaluation of lithium-ion battery separators, *Nat. Energy*. 4 (2019) 16–25. <https://doi.org/10.1038/s41560-018-0295-9>.
- [214] Y. Xiang, X. Li, Y. Cheng, X. Sun, Y. Yang, Advanced characterization techniques for solid state lithium battery research, *Mater. Today*. xxx (2020). <https://doi.org/10.1016/j.mattod.2020.01.018>.
- [215] J. Lu, T. Wu, K. Amine, State-of-the-art characterization techniques for advanced lithium-ion batteries, *Nat. Energy*. 2 (2017). <https://doi.org/10.1038/nenergy.2017.11>.
- [216] A. Barai, K. Uddin, M. Dubarry, L. Somerville, A. McGordon, P. Jennings, I. Bloom, A comparison of methodologies for the non-invasive characterisation of commercial Li-ion cells, *Prog. Energy Combust. Sci.* 72 (2019) 1–31. <https://doi.org/10.1016/j.pecs.2019.01.001>.
- [217] S. Goel, R. Sharma, A.K. Rathore, A review on barrier and challenges of electric vehicle in India and vehicle to grid optimisation, *Transp. Eng.* 4 (2021) 100057. <https://doi.org/10.1016/j.treng.2021.100057>.
- [218] A.C.R. Teixeira, J.R. Sodr e, Simulation of the impacts on carbon dioxide emissions from replacement of a conventional Brazilian taxi fleet by electric vehicles, *Energy*. 115 (2016) 1617–1622. <https://doi.org/10.1016/j.energy.2016.07.095>.
- [219] Electric vehicle life cycle analysis and raw material availability | Transport & Environment, (n.d.).
- [220] A. Alimujiang, P. Jiang, Synergy and co-benefits of reducing CO₂ and air pollutant emissions by promoting electric vehicles—A case of Shanghai, *Energy Sustain. Dev.* 55 (2020) 181–189. <https://doi.org/10.1016/j.esd.2020.02.005>.
- [221] K. Glitman, D. Farnsworth, J. Hildermeier, The role of electric vehicles in a decarbonized economy: Supporting a reliable, affordable and efficient electric system, *Electr. J.* 32 (2019) 106623. <https://doi.org/10.1016/j.tej.2019.106623>.
- [222] W. Choi, E. Yoo, E. Seol, M. Kim, H.H. Song, Greenhouse gas emissions of conventional and alternative vehicles: Predictions based on energy policy analysis in South Korea, *Appl. Energy*. 265 (2020) 114754. <https://doi.org/10.1016/j.apenergy.2020.114754>.
- [223] S. Xiong, Y. Wang, B. Bai, X. Ma, A hybrid life cycle assessment of the large-scale application of electric vehicles, *Energy*. 216 (2021) 119314. <https://doi.org/10.1016/j.energy.2020.119314>.
- [224] Q. Qiao, F. Zhao, Z. Liu, X. He, H. Hao, Life cycle greenhouse gas emissions of Electric Vehicles in China: Combining the vehicle cycle and fuel cycle, *Energy*. 177 (2019) 222–233. <https://doi.org/10.1016/j.energy.2019.04.080>.
- [225] F. Li, R. Ou, X. Xiao, K. Zhou, W. Xie, D. Ma, K. Liu, Z. Song, Regional comparison of electric vehicle adoption and emission reduction effects in China, *Resour. Conserv. Recycl.* 149 (2019) 714–726. <https://doi.org/10.1016/j.resconrec.2019.01.038>.
- [226] P. Greim, A.A. Solomon, C. Breyer, Assessment of lithium criticality in the global energy transition and addressing policy gaps in transportation, *Nat. Commun.* 11 (2020) 1–11. <https://doi.org/10.1038/s41467->

020-18402-y.

- [227] F. Duffner, L. Mauler, M. Wentker, J. Leker, M. Winter, Large-scale automotive battery cell manufacturing: Analyzing strategic and operational effects on manufacturing costs, *Int. J. Prod. Econ.* 232 (2021) 107982. <https://doi.org/10.1016/j.ijpe.2020.107982>.
- [228] Y. Chen, Y. Kang, Y. Zhao, L. Wang, J. Liu, Y. Li, Z. Liang, X. He, X. Li, N. Tavajohi, B. Li, A review of lithium-ion battery safety concerns: The issues, strategies, and testing standards, *J. Energy Chem.* 59 (2021) 83–99. <https://doi.org/10.1016/j.jechem.2020.10.017>.
- [229] L. Bongartz, S. Shammugam, E. Gervais, T. Schlegl, Multidimensional criticality assessment of metal requirements for Lithium-ion batteries in electric vehicles and stationary storage applications in Germany by 2050, *J. Clean. Prod.* (2021) 126056. <https://doi.org/10.1016/j.jclepro.2021.126056>.
- [230] W. Ma, Q. Xu, Lithium cobaltate: a novel host material enables high-rate and stable lithium–sulfur batteries, *Rare Met.* 37 (2018) 929–935. <https://doi.org/10.1007/s12598-018-1129-4>.
- [231] S. Chen, X. Zhang, M. Xia, K. Wei, L. Zhang, X. Zhang, Y. Cui, J. Shu, Issues and challenges of layered lithium nickel cobalt manganese oxides for lithium-ion batteries, *J. Electroanal. Chem.* (2021) 115412. <https://doi.org/10.1016/j.jelechem.2021.115412>.
- [232] C. Busà, M. Belekoukia, M.J. Loveridge, The effects of ambient storage conditions on the structural and electrochemical properties of NMC-811 cathodes for Li-ion batteries, *Electrochim. Acta.* 366 (2021) 137358. <https://doi.org/10.1016/j.electacta.2020.137358>.
- [233] D. Qiao, G. Wang, T. Gao, B. Wen, T. Dai, Potential impact of the end-of-life batteries recycling of electric vehicles on lithium demand in China: 2010–2050, *Sci. Total Environ.* (2020) 142835. <https://doi.org/10.1016/j.scitotenv.2020.142835>.
- [234] Y. Wang, N. An, L. Wen, L. Wang, X. Jiang, F. Hou, Y. Yin, J. Liang, Recent progress on the recycling technology of Li-ion batteries, *J. Energy Chem.* 55 (2020) 391–419. <https://doi.org/10.1016/j.jechem.2020.05.008>.
- [235] Y. Hua, X. Liu, S. Zhou, Y. Huang, H. Ling, S. Yang, Toward Sustainable Reuse of Retired Lithium-ion Batteries from Electric Vehicles, *Resour. Conserv. Recycl.* 168 (2021) 105249. <https://doi.org/10.1016/j.resconrec.2020.105249>.
- [236] F. Meng, J. McNeice, S.S. Zadeh, A. Ghahreman, Review of Lithium Production and Recovery from Minerals, Brines, and Lithium-Ion Batteries, *Miner. Process. Extr. Metall. Rev.* 42 (2021) 123–141. <https://doi.org/10.1080/08827508.2019.1668387>.
- [237] T.D. Nguyen, S. Li, W. Li, C.C. Mi, Feasibility study on bipolar pads for efficient wireless power chargers, *Conf. Proc. - IEEE Appl. Power Electron. Conf. Expo. - APEC.* (2014) 1676–1682. <https://doi.org/10.1109/APEC.2014.6803531>.
- [238] Y. Zheng, Z.Y. Dong, Y. Xu, K. Meng, J.H. Zhao, J. Qiu, Electric vehicle battery charging/swap stations in distribution systems: Comparison study and optimal planning, *IEEE Trans. Power Syst.* 29 (2014) 221–229. <https://doi.org/10.1109/TPWRS.2013.2278852>.
- [239] H. Shareef, M.M. Islam, A. Mohamed, A review of the stage-of-the-art charging technologies, placement methodologies, and impacts of electric vehicles, *Renew. Sustain. Energy Rev.* 64 (2016) 403–420. <https://doi.org/10.1016/j.rser.2016.06.033>.
- [240] V.S. Devahdhanush, S. Lee, I. Mudawar, Experimental investigation of subcooled flow boiling in annuli

- with reference to thermal management of ultra-fast electric vehicle charging cables, *Int. J. Heat Mass Transf.* 172 (2021) 121176. <https://doi.org/10.1016/j.ijheatmasstransfer.2021.121176>.
- [241] J1772A: SAE Electric Vehicle and Plug in Hybrid Electric Vehicle Conductive Charge Coupler - SAE International, (n.d.). https://www.sae.org/standards/content/j1772_201710/ (accessed November 26, 2019).
- [242] SAE Electric Vehicle and Plug in Hybrid Electric Vehicle Conductive Charge Coupler J1772_201710, 2017. https://saemobilus.sae.org/content/j1772_201710 (accessed May 16, 2021).
- [243] Electric vehicle conductive charging system - Part 1 General requirements, Standard BS EN IEC 61851-1:2019, 2019.
- [244] Electric vehicle conductive charging system - Part 23 DC electric vehicle charging station, Standard BS EN IEC 61851-23:2014, 2014. <https://webstore.iec.ch/publication/6032> (accessed May 16, 2021).
- [245] Connection set for conductive charging of electric vehicles - Part 1 General requirements, GB/T 20234.1-2015, 2015.
- [246] Connection set for conductive charging of electric vehicles - Part 2 AC charging coupler, GB/T 20234.2-2015, 2015.
- [247] R. Krishnamoorthy, C. Bharatiraja, K. Krishnan, Review of communication network interfaces and battery management for PHEV-ECU materials and components, *Mater. Today Proc.* (2021). <https://doi.org/10.1016/j.matpr.2020.12.933>.
- [248] C. Marinescu, L. Barote, D. Munteanu, V. Komasilovs, A. Zacepins, A. Kviesis, Enhancing with EV charging station functions a residential RES based network, *VEHITS 2018 - Proc. 4th Int. Conf. Veh. Technol. Intell. Transp. Syst.* 2018-March (2018) 610–616. <https://doi.org/10.5220/0006812306100616>.
- [249] S. Lukic, Z. Pantic, Cutting the Cord: Static and Dynamic Inductive Wireless Charging of Electric Vehicles, *IEEE Electrif. Mag.* 1 (2013) 57–64. <https://doi.org/10.1109/mele.2013.2273228>.
- [250] P. Machura, Q. Li, A critical review on wireless charging for electric vehicles, *Renew. Sustain. Energy Rev.* 104 (2019) 209–234. <https://doi.org/10.1016/j.rser.2019.01.027>.
- [251] J.M. Miller, P.T. Jones, J.M. Li, O.C. Onar, ORNL experience and challenges facing dynamic wireless power charging of EV's, *IEEE Circuits Syst. Mag.* 15 (2015) 40–53. <https://doi.org/10.1109/MCAS.2015.2419012>.
- [252] S. Li, Z. Liu, H. Zhao, L. Zhu, C. Shuai, Z. Chen, Wireless Power Transfer by Electric Field Resonance and Its Application in Dynamic Charging, *IEEE Trans. Ind. Electron.* 63 (2016) 6602–6612. <https://doi.org/10.1109/TIE.2016.2577625>.
- [253] W. Chen, C. Liu, C. Lee, Z. Shan, Cost-Effectiveness Comparison of Coupler Designs of Wireless Power Transfer for Electric Vehicle Dynamic Charging, *Energies.* 9 (2016) 906. <https://doi.org/10.3390/en9110906>.
- [254] V.B. Vu, D.H. Tran, W. Choi, Implementation of the Constant Current and Constant Voltage Charge of Inductive Power Transfer Systems with the Double-Sided LCC Compensation Topology for Electric Vehicle Battery Charge Applications, *IEEE Trans. Power Electron.* 33 (2018) 7398–7410. <https://doi.org/10.1109/TPEL.2017.2766605>.
- [255] A. Khaligh, S. Dusmez, Comprehensive topological analysis of conductive and inductive charging solutions for plug-in electric vehicles, *IEEE Trans. Veh. Technol.* 61 (2012) 3475–3489.

- <https://doi.org/10.1109/TVT.2012.2213104>.
- [256] M. Budhia, G. Covic, J. Boys, A new IPT magnetic coupler for electric vehicle charging systems, *IECON Proc. (Industrial Electron. Conf.)* (2010) 2487–2492. <https://doi.org/10.1109/IECON.2010.5675350>.
- [257] S. Chopra, P. Bauer, Driving range extension of EV with on-road contactless power transfer-A case study, *IEEE Trans. Ind. Electron.* 60 (2013) 329–338. <https://doi.org/10.1109/TIE.2011.2182015>.
- [258] Wireless Power Transfer for Light-Duty Plug-in/Electric Vehicles and Alignment Methodology J2954_202010, 2020. https://www.sae.org/standards/content/j2954_202010/ (accessed May 18, 2021).
- [259] J2847/6A: Communication for Wireless Power Transfer Between Light-Duty Plug-in Electric Vehicles and Wireless EV Charging Stations , 2020.
- [260] Y.J. Jang, S. Jeong, M.S. Lee, Initial energy logistics cost analysis for stationary, quasi-dynamic, & dynamic wireless charging public transportation systems, *Energies.* 9 (2016) 483. <https://doi.org/10.3390/en9070483>.
- [261] L. Sun, D. Ma, H. Tang, A review of recent trends in wireless power transfer technology and its applications in electric vehicle wireless charging, *Renew. Sustain. Energy Rev.* 91 (2018) 490–503. <https://doi.org/10.1016/j.rser.2018.04.016>.
- [262] S. Li, C.C. Mi, Wireless power transfer for electric vehicle applications, *IEEE J. Emerg. Sel. Top. Power Electron.* 3 (2015) 4–17. <https://doi.org/10.1109/JESTPE.2014.2319453>.
- [263] Z. Bi, T. Kan, C.C. Mi, Y. Zhang, Z. Zhao, G.A. Keoleian, A review of wireless power transfer for electric vehicles: Prospects to enhance sustainable mobility, *Appl. Energy.* 179 (2016) 413–425. <https://doi.org/10.1016/j.apenergy.2016.07.003>.
- [264] J. Huh, S.W. Lee, W.Y. Lee, G.H. Cho, C.T. Rim, Narrow-width inductive power transfer system for online electrical vehicles, *IEEE Trans. Power Electron.* 26 (2011) 3666–3679. <https://doi.org/10.1109/TPEL.2011.2160972>.
- [265] S.Y. Choi, B.W. Gu, S.W. Lee, W.Y. Lee, J. Huh, C.T. Rim, Generalized active EMF cancel methods for wireless electric vehicles, *IEEE Trans. Power Electron.* 29 (2014) 5770–5783. <https://doi.org/10.1109/TPEL.2013.2295094>.
- [266] C.T. Rim, C. Mi, *Wireless Power Transfer for Electric Vehicles and Mobile Devices*, John Wiley & Sons, Ltd, Chichester, UK, 2017. <https://doi.org/10.1002/9781119329084>.
- [267] J. Shin, S. Shin, Y. Kim, S. Ahn, S. Lee, G. Jung, S.J. Jeon, D.H. Cho, Design and implementation of shaped magnetic-resonance-based wireless power transfer system for roadway-powered moving electric vehicles, *IEEE Trans. Ind. Electron.* 61 (2014) 1179–1192. <https://doi.org/10.1109/TIE.2013.2258294>.
- [268] A. Shekhar, V. Prasanth, P. Bauer, M. Bolech, Economic viability study of an on-road wireless charging system with a generic driving range estimation method, *Energies.* 9 (2016) 1–20. <https://doi.org/10.3390/en9020076>.
- [269] S. Jeong, Y.J. Jang, D. Kum, Economic Analysis of the Dynamic Charging Electric Vehicle, *IEEE Trans. Power Electron.* 30 (2015) 6368–6377. <https://doi.org/10.1109/TPEL.2015.2424712>.
- [270] Z. Bi, R. De Kleine, G.A. Keoleian, Integrated Life Cycle Assessment and Life Cycle Cost Model for Comparing Plug-in versus Wireless Charging for an Electric Bus System, *J. Ind. Ecol.* 21 (2017) 344–355. <https://doi.org/10.1111/jiec.12419>.

- [271] M. Fuller, Wireless charging in California: Range, recharge, and vehicle electrification, *Transp. Res. Part C Emerg. Technol.* 67 (2016) 343–356. <https://doi.org/10.1016/j.trc.2016.02.013>.
- [272] J.J. Jamian, M.W. Mustafa, H. Mokhlis, M.A. Baharudin, Simulation study on optimal placement and sizing of Battery Switching Station units using Artificial Bee Colony algorithm, *Int. J. Electr. Power Energy Syst.* 55 (2014) 592–601. <https://doi.org/10.1016/j.ijepes.2013.10.009>.
- [273] T.H. Wu, G.K.H. Pang, K.L. Choy, H.Y. Lam, An optimization model for a battery swapping station in Hong Kong, in: 2015 IEEE Transp. Electrification Conf. Expo, ITEC 2015, Institute of Electrical and Electronics Engineers Inc., 2015. <https://doi.org/10.1109/ITEC.2015.7165769>.
- [274] C. Zhang, P. Chen, Economic benefit analysis of battery charging and swapping station for pure electric bus based on differential power purchase policy: a new power trading model, *Sustain. Cities Soc.* 64 (2021) 102570. <https://doi.org/10.1016/j.scs.2020.102570>.
- [275] IEC TS 62840-1:2016 | Electric vehicle battery swap system - Part 1: General and guidance, 2016. <https://webstore.iec.ch/publication/25398> (accessed May 20, 2021).
- [276] IEC 62840-2:2016 | Electric vehicle battery swap system - Part 2: Safety requirements, 2016. <https://webstore.iec.ch/publication/25983> (accessed May 20, 2021).
- [277] Y. Wang, W. Ding, L. Huang, Z. Wei, H. Liu, J.A. Stankovic, Toward Urban Electric Taxi Systems in Smart Cities: The Battery Swapping Challenge, *IEEE Trans. Veh. Technol.* 67 (2018) 1946–1960. <https://doi.org/10.1109/TVT.2017.2774447>.
- [278] Nichola Groom, Electric car maker Tesla unveils 90-second battery pack swap - Reuters, (2013). <https://www.reuters.com/article/us-tesla-swap/electric-car-maker-tesla-unveils-90-second-battery-pack-swap-idUSBRE95K07H20130621> (accessed January 17, 2020).
- [279] B. Sun, X. Tan, D.H.K. Tsang, Optimal Charging Operation of Battery Swapping and Charging Stations with QoS Guarantee, *IEEE Trans. Smart Grid.* 9 (2018) 4689–4701. <https://doi.org/10.1109/TSG.2017.2666815>.
- [280] X. Tan, B. Sun, Y. Wu, D.H.K. Tsang, Asymptotic performance evaluation of battery swapping and charging station for electric vehicles, *Perform. Eval.* 119 (2018) 43–57. <https://doi.org/10.1016/j.peva.2017.12.004>.
- [281] Q. Kang, J. Wang, M. Zhou, A.C. Ammari, Centralized Charging Strategy and Scheduling Algorithm for Electric Vehicles under a Battery Swapping Scenario, *IEEE Trans. Intell. Transp. Syst.* 17 (2016) 659–669. <https://doi.org/10.1109/TITS.2015.2487323>.
- [282] L. Chen, M. Wu, X. Xu, The development and applications of charging/battery swap technologies for EVS, in: China Int. Conf. Electr. Distrib. CICED, 2012. <https://doi.org/10.1109/CICED.2012.6508419>.
- [283] B. Sun, X. Sun, D.H.K. Tsang, W. Whitt, Optimal battery purchasing and charging strategy at electric vehicle battery swap stations, *Eur. J. Oper. Res.* 279 (2019) 524–539. <https://doi.org/10.1016/j.ejor.2019.06.019>.
- [284] China EV Charging Station and Charging Pile Market Report, 2017-2020, (n.d.). <https://www.marketresearch.com/Research-in-China-v3266/China-EV-Charging-Station-Pile-10718132/> (accessed January 17, 2020).
- [285] Smart Cities Council India | India's 1st battery swapping & charging station for electric vehicles, (n.d.).
- [286] Battery Swapping System | ACM (EN) - Adaptive City Mobility, (n.d.).

- [287] J. Yang, H. Sun, Battery swap station location-routing problem with capacitated electric vehicles, *Comput. Oper. Res.* 55 (2015) 217–232. <https://doi.org/10.1016/j.cor.2014.07.003>.
- [288] M. Zhang, J. Chen, The energy management and optimized operation of electric vehicles based on microgrid, *IEEE Trans. Power Deliv.* 29 (2014) 1427–1435. <https://doi.org/10.1109/TPWRD.2014.2303492>.
- [289] M. Ban, M. Shahidehpour, J. Yu, Z. Li, A Cyber-Physical Energy Management System for Optimal Sizing and Operation of Networked Nanogrids With Battery Swapping Stations, *IEEE Trans. Sustain. Energy.* 10 (2019) 491–502. <https://doi.org/10.1109/TSTE.2017.2788056>.
- [290] H. Farzin, M. Moeini-Aghtaie, M. Fotuhi-Firuzabad, Reliability Studies of Distribution Systems Integrated with Electric Vehicles under Battery-Exchange Mode, *IEEE Trans. Power Deliv.* 31 (2016) 2473–2482. <https://doi.org/10.1109/TPWRD.2015.2497219>.
- [291] L. Cheng, Y. Chang, J. Lin, C. Singh, Power System Reliability Assessment With Electric Vehicle Integration Using Battery Exchange Mode, *IEEE Trans. Sustain. Energy.* 4 (2013) 1034–1042.
- [292] Q. Dai, T. Cai, S. Duan, F. Zhao, Stochastic modeling and forecasting of load demand for electric bus battery-swap station, *IEEE Trans. Power Deliv.* 29 (2014) 1909–1917. <https://doi.org/10.1109/TPWRD.2014.2308990>.
- [293] P. You, Z. Yang, Y. Zhang, S.H. Low, Y. Sun, Optimal Charging Schedule for a Battery Switching Station Serving Electric Buses, *IEEE Trans. Power Syst.* 31 (2016) 3473–3483. <https://doi.org/10.1109/TPWRS.2015.2487273>.
- [294] Y. Liang, X. Zhang, Battery swap pricing and charging strategy for electric taxis in China, *Energy.* 147 (2018) 561–577. <https://doi.org/10.1016/j.energy.2018.01.082>.
- [295] B. Loeb, K.M. Kockelman, J. Liu, Shared autonomous electric vehicle (SAEV) operations across the Austin, Texas network with charging infrastructure decisions, *Transp. Res. Part C Emerg. Technol.* 89 (2018) 222–233. <https://doi.org/10.1016/j.trc.2018.01.019>.
- [296] G.S. Bauer, J.B. Greenblatt, B.F. Gerke, Cost, Energy, and Environmental Impact of Automated Electric Taxi Fleets in Manhattan, *Environ. Sci. Technol.* 52 (2018) 4920–4928. <https://doi.org/10.1021/acs.est.7b04732>.
- [297] S. Yang, J. Yao, T. Kang, X. Zhu, Dynamic operation model of the battery swapping station for EV (electric vehicle) in electricity market, *Energy.* 65 (2014) 544–549. <https://doi.org/10.1016/j.energy.2013.11.010>.
- [298] J. Romm, The car and fuel of the future, *Energy Policy.* 34 (2006) 2609–2614. <https://doi.org/10.1016/j.enpol.2005.06.025>.
- [299] I. Rahman, P.M. Vasant, B.S.M. Singh, M. Abdullah-Al-Wadud, N. Adnan, Review of recent trends in optimization techniques for plug-in hybrid, and electric vehicle charging infrastructures, *Renew. Sustain. Energy Rev.* 58 (2016) 1039–1047. <https://doi.org/10.1016/j.rser.2015.12.353>.
- [300] T.G. San Román, I. Momber, M.R. Abbad, Á. Sánchez Miralles, Regulatory framework and business models for charging plug-in electric vehicles: Infrastructure, agents, and commercial relationships, *Energy Policy.* 39 (2011) 6360–6375. <https://doi.org/10.1016/j.enpol.2011.07.037>.
- [301] Y. Li, L. Li, J. Yong, Y. Yao, Z. Li, Layout planning of electrical vehicle charging stations based on genetic algorithm, in: *Lect. Notes Electr. Eng.*, 2011: pp. 661–668. <https://doi.org/10.1007/978-3-642->

- [302] X. Yan, C. Duan, X. Chen, Z. Duan, Planning of Electric Vehicle charging station based on hierarchic genetic algorithm, in: IEEE Transp. Electr. Conf. Expo, ITEC Asia-Pacific 2014 - Conf. Proc., Institute of Electrical and Electronics Engineers Inc., 2014. <https://doi.org/10.1109/ITEC-AP.2014.6941087>.
- [303] Z.F. Liu, W. Zhang, X. Ji, K. Li, Optimal planning of charging station for electric vehicle based on particle swarm optimization, in: 2012 IEEE Innov. Smart Grid Technol. - Asia, ISGT Asia 2012, 2012. <https://doi.org/10.1109/ISGT-Asia.2012.6303112>.
- [304] J. Prasomthong, W. Ongsakul, J. Meyer, Optimal placement of vehicle-to-grid charging station in distribution system using Particle Swarm Optimization with time varying acceleration coefficient, in: Proc. 2014 Int. Conf. Util. Exhib. Green Energy Sustain. Dev. ICUE 2014, 2014.
- [305] O. Worley, D. Klabjan, T.M. Sweda, Simultaneous vehicle routing and charging station siting for commercial electric vehicles, in: 2012 IEEE Int. Electr. Veh. Conf. IEVC 2012, 2012. <https://doi.org/10.1109/IEVC.2012.6183279>.
- [306] Z. Yi, P.H. Bauer, Optimization models for placement of an energy-aware electric vehicle charging infrastructure, *Transp. Res. Part E Logist. Transp. Rev.* 91 (2016) 227–244. <https://doi.org/10.1016/j.tre.2016.04.013>.
- [307] P. Phonrattanasak, N. Leeprechanon, Optimal placement of EV fast charging stations considering the impact on electrical distribution and traffic condition, in: Proc. 2014 Int. Conf. Util. Exhib. Green Energy Sustain. Dev. ICUE 2014, 2014.
- [308] J.G. Kim, M. Kuby, A network transformation heuristic approach for the deviation flow refueling location model, *Comput. Oper. Res.* 40 (2013) 1122–1131. <https://doi.org/10.1016/j.cor.2012.10.021>.
- [309] M. Momtazpour, P. Butler, M.S. Hossain, M.C. Bozchalui, N. Ramakrishnan, R. Sharma, Coordinated clustering algorithms to support charging infrastructure design for electric vehicles, in: Proc. ACM SIGKDD Int. Conf. Knowl. Discov. Data Min., 2012: pp. 126–133. <https://doi.org/10.1145/2346496.2346517>.
- [310] Y. Yin, S. Lawphongpanich, Network equilibrium models with battery electric vehicles, *Transp. Res. PART B.* 67 (2014) 306–319. <https://doi.org/10.1016/j.trb.2014.05.010>.
- [311] M. Cruz-Zambrano, C. Corchero, L. Igualada-Gonzalez, V. Bernardo, Optimal location of fast charging stations in Barcelona: A flow-capturing approach, in: Int. Conf. Eur. Energy Mark. EEM, 2013. <https://doi.org/10.1109/EEM.2013.6607414>.
- [312] J. Wirges, S. Linder, A. Kessler, Modelling the development of a regional charging infrastructure for electric vehicles in time and space, *Eur. J. Transp. Infrastruct. Res.* 12 (2012) 391–416. <https://doi.org/10.18757/ejtir.2012.12.4.2976>.
- [313] W. Tu, Q. Li, Z. Fang, S. lung Shaw, B. Zhou, X. Chang, Optimizing the locations of electric taxi charging stations: A spatial–temporal demand coverage approach, *Transp. Res. Part C Emerg. Technol.* 65 (2016) 172–189. <https://doi.org/10.1016/j.trc.2015.10.004>.
- [314] H. Fredriksson, M. Dahl, J. Holmgren, Optimal placement of Charging Stations for Electric Vehicles in large-scale Transportation Networks, *Procedia Comput. Sci.* 160 (2019) 77–84. <https://doi.org/10.1016/j.procs.2019.09.446>.
- [315] X. Xi, R. Sioshansi, V. Marano, Simulation-optimization model for location of a public electric vehicle

- charging infrastructure, *Transp. Res. Part D Transp. Environ.* 22 (2013) 60–69. <https://doi.org/10.1016/j.trd.2013.02.014>.
- [316] I. Frade, A. Ribeiro, G. Gonçalves, A. Antunes, Optimal location of charging stations for electric vehicles in a neighborhood in Lisbon, Portugal, *Transp. Res. Rec.* 2252 (2011) 91–98. <https://doi.org/10.3141/2252-12>.
- [317] J. Asamer, M. Reinthaler, M. Ruthmair, M. Straub, J. Puchinger, Optimizing charging station locations for urban taxi providers, *Transp. Res. Part A Policy Pract.* 85 (2016) 233–246. <https://doi.org/10.1016/j.tra.2016.01.014>.
- [318] N. Sathaye, S. Kelley, An approach for the optimal planning of electric vehicle infrastructure for highway corridors, *Transp. Res. Part E Logist. Transp. Rev.* 59 (2013) 15–33. <https://doi.org/10.1016/j.tre.2013.08.003>.
- [319] H. Fredriksson, M. Dahl, J. Holmgren, Optimal placement of Charging Stations for Electric Vehicles in large-scale Transportation Networks, *Procedia Comput. Sci.* 160 (2019) 1–10. <https://doi.org/10.1016/j.procs.2019.09.446>.
- [320] H. Xu, S. Miao, C. Zhang, D. Shi, Optimal placement of charging infrastructures for large-scale integration of pure electric vehicles into grid, *Int. J. Electr. Power Energy Syst.* 53 (2013) 159–165. <https://doi.org/10.1016/j.ijepes.2013.04.022>.
- [321] A.Y.S. Lam, Y.W. Leung, X. Chu, Electric vehicle charging station placement: Formulation, complexity, and solutions, *IEEE Trans. Smart Grid.* 5 (2014) 2846–2856. <https://doi.org/10.1109/TSG.2014.2344684>.
- [322] L. Jia, Z. Hu, Y. Song, Z. Luo, Optimal siting and sizing of electric vehicle charging stations, in: 2012 IEEE Int. Electr. Veh. Conf. IEVC 2012, 2012. <https://doi.org/10.1109/IEVC.2012.6183283>.
- [323] S. Wagner, M. Götzinger, D. Neumann, Optimal location of charging stations in smart cities: A points of interest based approach, *ICIS 2013 Proc.* (2013). <https://aisel.aisnet.org/icis2013/proceedings/BreakthroughIdeas/12> (accessed January 21, 2020).
- [324] Y. Tao, M. Huang, L. Yang, Data-driven optimized layout of battery electric vehicle charging infrastructure, *Energy.* 150 (2018) 735–744. <https://doi.org/10.1016/j.energy.2018.03.018>.
- [325] L. Cilio, O. Babacan, Allocation optimisation of rapid charging stations in large urban areas to support fully electric taxi fleets, *Appl. Energy.* 295 (2021) 117072. <https://doi.org/10.1016/j.apenergy.2021.117072>.
- [326] T. Yi, X. Cheng, H. Zheng, J. Liu, Research on Location and Capacity Optimization Method for Electric Vehicle Charging Stations Considering User's Comprehensive Satisfaction, (2019).
- [327] E. Pashajavid, M.A. Golkar, Optimal placement and sizing of plug in electric vehicles charging stations within distribution networks with high penetration of photovoltaic panels, *J. Renew. Sustain. Energy.* 5 (2013). <https://doi.org/10.1063/1.4822257>.
- [328] P. Sadeghi-Barzani, A. Rajabi-Ghahnavieh, H. Kazemi-Karegar, Optimal fast charging station placing and sizing, *Appl. Energy.* 125 (2014) 289–299. <https://doi.org/10.1016/j.apenergy.2014.03.077>.
- [329] S.K. Injeti, V.K. Thunuguntla, Optimal integration of DGs into radial distribution network in the presence of plug-in electric vehicles to minimize daily active power losses and to improve the voltage profile of the system using bio-inspired optimization algorithms, *Prot. Control Mod. Power Syst.* 5

- (2020) 1–15. <https://doi.org/10.1186/s41601-019-0149-x>.
- [330] L. Chen, C. Xu, H. Song, K. Jermittiparsert, Optimal sizing and siting of EVCS in the distribution system using metaheuristics: A case study, *Energy Reports*. 7 (2021) 208–217. <https://doi.org/10.1016/j.egy.2020.12.032>.
- [331] S. Deb, X.Z. Gao, K. Tammi, K. Kalita, P. Mahanta, A novel chicken swarm and teaching learning based algorithm for electric vehicle charging station placement problem, *Energy*. 220 (2021) 119645. <https://doi.org/10.1016/j.energy.2020.119645>.
- [332] A. Rezaee Jordehi, M.S. Javadi, J. P. S. Catalão, Optimal placement of battery swap stations in microgrids with micro pumped hydro storage systems, photovoltaic, wind and geothermal distributed generators, *Int. J. Electr. Power Energy Syst.* 125 (2021) 106483. <https://doi.org/10.1016/j.ijepes.2020.106483>.
- [333] T.Y. Ma, S. Xie, Optimal fast charging station locations for electric ridesharing with vehicle-charging station assignment, *Transp. Res. Part D Transp. Environ.* 90 (2021) 102682. <https://doi.org/10.1016/j.trd.2020.102682>.
- [334] EVSE | Bornes de recharge de véhicules électriques (VE) | ChargePoint, (n.d.).
- [335] PlugShare - EV Charging Station Map - Find a place to charge your car!, (n.d.).
- [336] Q. Meng, T. Liu, C. Su, H. Niu, Z. Hou, N. Ghadimi, A Single-Phase Transformer-Less Grid-Tied Inverter Based on Switched Capacitor for PV Application, *J. Control. Autom. Electr. Syst.* 31 (2020) 257–270. <https://doi.org/10.1007/s40313-019-00531-5>.
- [337] A. Ghosh, Possibilities and Challenges for the Inclusion of the Electric Vehicle (EV) to Reduce the Carbon Footprint in the Transport Sector: A Review, *Energies*. 13 (2020) 2602. <https://doi.org/10.3390/en13102602>.
- [338] M.K. Nematchoua, A. Marie-Reine Nishimwe, S. Reiter, Towards nearly zero-energy residential neighbourhoods in the European Union: A case study, *Renew. Sustain. Energy Rev.* 135 (2021) 110198. <https://doi.org/10.1016/j.rser.2020.110198>.
- [339] H. Fan, L. Jiang, C.K. Zhang, C. Mao, Frequency regulation of multi-area power systems with plug-in electric vehicles considering communication delays, *IET Gener. Transm. Distrib.* 10 (2016) 3481–3491. <https://doi.org/10.1049/iet-gtd.2016.0108>.
- [340] I. Pavić, T. Capuder, I. Kuzle, Value of flexible electric vehicles in providing spinning reserve services, *Appl. Energy*. 157 (2015) 60–74. <https://doi.org/10.1016/j.apenergy.2015.07.070>.
- [341] C. Marinescu, L. Barote, D. Munteanu, V. Komasilovs, A. Zacepins, A. Kviesis, Enhancing with EV charging station functions a residential RES based network, in: *VEHITS 2018 - Proc. 4th Int. Conf. Veh. Technol. Intell. Transp. Syst.*, SciTePress, 2018: pp. 610–616. <https://doi.org/10.5220/0006812306100616>.
- [342] C. Marinescu, L. Barote, Toward a practical solution for residential RES based EV charging system, *Proc. - 2017 Int. Conf. Optim. Electr. Electron. Equipment, OPTIM 2017 2017 Intl Aegean Conf. Electr. Mach. Power Electron. ACEMP 2017*. (2017) 771–776. <https://doi.org/10.1109/OPTIM.2017.7975062>.
- [343] S. Burger, J.P. Chaves-Ávila, C. Batlle, I.J. Pérez-Arriaga, A review of the value of aggregators in electricity systems, *Renew. Sustain. Energy Rev.* 77 (2017) 395–405. <https://doi.org/10.1016/j.rser.2017.04.014>.

- [344] H. Tang, S. Wang, H. Li, Flexibility categorization, sources, capabilities and technologies for energy-flexible and grid-responsive buildings: State-of-the-art and future perspective, *Energy*. 219 (2021) 119598. <https://doi.org/10.1016/j.energy.2020.119598>.
- [345] A.F. Cortés Borray, J. Merino, E. Torres, J. Mazón, A review of the population-based and individual-based approaches for electric vehicles in network energy studies, *Electr. Power Syst. Res.* 189 (2020) 106785. <https://doi.org/10.1016/j.epsr.2020.106785>.
- [346] C. Guille, G. Gross, A conceptual framework for the vehicle-to-grid (V2G) implementation, *Energy Policy*. 37 (2009) 4379–4390. <https://doi.org/10.1016/j.enpol.2009.05.053>.
- [347] C. Peng, J. Zou, L. Lian, L. Li, An optimal dispatching strategy for V2G aggregator participating in supplementary frequency regulation considering EV driving demand and aggregator's benefits, *Appl. Energy*. 190 (2017) 591–599. <https://doi.org/10.1016/j.apenergy.2016.12.065>.
- [348] B.K. Sovacool, J. Kester, L. Noel, G. Zarazua de Rubens, Actors, business models, and innovation activity systems for vehicle-to-grid (V2G) technology: A comprehensive review, *Renew. Sustain. Energy Rev.* 131 (2020) 109963. <https://doi.org/10.1016/j.rser.2020.109963>.
- [349] V2G Hub | V2G Around the world, (2021).
- [350] M. Ehsani, M. Falahi, S. Lotfifard, Vehicle to grid services: Potential and applications, *Energies*. 5 (2012) 4076–4090. <https://doi.org/10.3390/en5104076>.
- [351] S. Sarabi, A. Davigny, V. Courtecuisse, Y. Riffonneau, B. Robyns, Potential of vehicle-to-grid ancillary services considering the uncertainties in plug-in electric vehicle availability and service/localization limitations in distribution grids, *Appl. Energy*. 171 (2016) 523–540. <https://doi.org/10.1016/j.apenergy.2016.03.064>.
- [352] M. Huda, K. Tokimatsu, M. Aziz, Techno economic analysis of vehicle to grid (V2G) integration as distributed energy resources in Indonesia power system, *Energies*. 13 (2020). <https://doi.org/10.3390/en13051162>.
- [353] N.B.G. Brinkel, W.L. Schram, T.A. AlSkaif, I. Lampropoulos, W.G.J.H.M. van Sark, Should we reinforce the grid? Cost and emission optimization of electric vehicle charging under different transformer limits, *Appl. Energy*. 276 (2020) 115285. <https://doi.org/10.1016/j.apenergy.2020.115285>.
- [354] C. Heilmann, G. Friedl, Factors influencing the economic success of grid-to-vehicle and vehicle-to-grid applications—A review and meta-analysis, *Renew. Sustain. Energy Rev.* 145 (2021) 111115. <https://doi.org/10.1016/j.rser.2021.111115>.
- [355] R. Gough, C. Dickerson, P. Rowley, C. Walsh, Vehicle-to-grid feasibility: A techno-economic analysis of EV-based energy storage, *Appl. Energy*. 192 (2017) 12–23. <https://doi.org/10.1016/j.apenergy.2017.01.102>.
- [356] X. Li, Y. Tan, X. Liu, Q. Liao, B. Sun, G. Cao, C. Li, X. Yang, Z. Wang, A cost-benefit analysis of V2G electric vehicles supporting peak shaving in Shanghai, *Electr. Power Syst. Res.* 179 (2020) 106058. <https://doi.org/10.1016/j.epsr.2019.106058>.
- [357] S. Han, S. Han, Economic feasibility of V2G frequency regulation in consideration of battery wear, *Energies*. 6 (2013) 748–765. <https://doi.org/10.3390/en6020748>.
- [358] A. Kumar, N.K. Meena, A.R. Singh, Y. Deng, X. He, R.C. Bansal, P. Kumar, Strategic integration of battery energy storage systems with the provision of distributed ancillary services in active distribution

- systems, *Appl. Energy*. 253 (2019) 113503. <https://doi.org/10.1016/j.apenergy.2019.113503>.
- [359] M.T. Hussain, D.N. Bin Sulaiman, M.S. Hussain, M. Jabir, Optimal Management strategies to solve issues of grid having Electric Vehicles (EV): A review, *J. Energy Storage*. 33 (2021) 102114. <https://doi.org/10.1016/j.est.2020.102114>.
- [360] B. Bibak, H. Tekiner-Mogulkoc, Influences of vehicle to grid (V2G) on power grid: An analysis by considering associated stochastic parameters explicitly, *Sustain. Energy, Grids Networks*. 26 (2021) 100429. <https://doi.org/10.1016/j.segan.2020.100429>.
- [361] B. Bibak, H. Tekiner-Moğulkoç, A comprehensive analysis of Vehicle to Grid (V2G) systems and scholarly literature on the application of such systems, *Renew. Energy Focus*. 36 (2021) 1–20. <https://doi.org/10.1016/j.ref.2020.10.001>.
- [362] Annu, D. Kaushik, A. Gupta, Ultra-secure transmissions for 5G-V2X communications, *Mater. Today Proc.* (2021). <https://doi.org/10.1016/j.matpr.2020.12.130>.
- [363] Y.A. Wu, A.W. Ng, Z. Yu, J. Huang, K. Meng, Z.Y. Dong, A review of evolutionary policy incentives for sustainable development of electric vehicles in China: Strategic implications, *Energy Policy*. 148 (2021) 111983. <https://doi.org/10.1016/j.enpol.2020.111983>.
- [364] X.W. Wang, Y.M. Cao, N. Zhang, The influences of incentive policy perceptions and consumer social attributes on battery electric vehicle purchase intentions, *Energy Policy*. 151 (2021) 112163. <https://doi.org/10.1016/j.enpol.2021.112163>.
- [365] J.H.M. Langbroek, J.P. Franklin, Y.O. Susilo, The effect of policy incentives on electric vehicle adoption, *Energy Policy*. 94 (2016) 94–103. <https://doi.org/10.1016/j.enpol.2016.03.050>.
- [366] S. Hardman, G. Tal, Exploring the decision to adopt a high-end battery electric vehicle: Role of financial and nonfinancial motivations, *Transp. Res. Rec.* 2572 (2016) 20–27. <https://doi.org/10.3141/2572-03>.
- [367] A.C. Mersky, F. Sprei, C. Samaras, Z.S. Qian, Effectiveness of incentives on electric vehicle adoption in Norway, *Transp. Res. Part D Transp. Environ.* 46 (2016) 56–68. <https://doi.org/10.1016/j.trd.2016.03.011>.
- [368] G. Santos, S. Rembalski, Do electric vehicles need subsidies in the UK?, *Energy Policy*. 149 (2021) 111890. <https://doi.org/10.1016/j.enpol.2020.111890>.
- [369] M. Scorrano, R. Danielis, M. Giansoldati, Dissecting the total cost of ownership of fully electric cars in Italy: The impact of annual distance travelled, home charging and urban driving, *Res. Transp. Econ.* 80 (2020) 100799. <https://doi.org/10.1016/j.retrec.2019.100799>.
- [370] R. Azarafshar, W.N. Vermeulen, Electric vehicle incentive policies in Canadian provinces, *Energy Econ.* 91 (2020) 104902. <https://doi.org/10.1016/j.eneco.2020.104902>.
- [371] A. Jenn, K. Springel, A.R. Gopal, Effectiveness of electric vehicle incentives in the United States, *Energy Policy*. 119 (2018) 349–356. <https://doi.org/10.1016/j.enpol.2018.04.065>.
- [372] J. Kester, L. Noel, G. Zarazua de Rubens, B.K. Sovacool, Policy mechanisms to accelerate electric vehicle adoption: A qualitative review from the Nordic region, *Renew. Sustain. Energy Rev.* 94 (2018) 719–731. <https://doi.org/10.1016/j.rser.2018.05.067>.
- [373] S. Gong, A. Ardeshiri, T. Hossein Rashidi, Impact of government incentives on the market penetration of electric vehicles in Australia, *Transp. Res. Part D Transp. Environ.* 83 (2020) 102353. <https://doi.org/10.1016/j.trd.2020.102353>.

- [374] International Energy Agency (IEA), *Global EV Outlook 2020*, 2020. <https://doi.org/10.1787/d394399e-en>.
- [375] W. Sierzchula, S. Bakker, K. Maat, B. Van Wee, The influence of financial incentives and other socio-economic factors on electric vehicle adoption, *Energy Policy*. 68 (2014) 183–194. <https://doi.org/10.1016/j.enpol.2014.01.043>.
- [376] K. Chen, C. Ren, R. Gu, P. Zhang, Exploring purchase intentions of new energy vehicles: From the perspective of frugality and the concept of “mianzi,” *J. Clean. Prod.* 230 (2019) 700–708. <https://doi.org/10.1016/j.jclepro.2019.05.135>.
- [377] S. Habich-Sobiegalla, G. Kostka, N. Anzinger, Citizens’ electric vehicle purchase intentions in China: An analysis of micro-level and macro-level factors, *Transp. Policy*. 79 (2019) 223–233. <https://doi.org/10.1016/j.tranpol.2019.05.008>.
- [378] X.W. Wang, Y.M. Cao, N. Zhang, The influences of incentive policy perceptions and consumer social attributes on battery electric vehicle purchase intentions, *Energy Policy*. 151 (2021) 112163. <https://doi.org/10.1016/j.enpol.2021.112163>.
- [379] C.W. Hsu, K. Fingerman, Public electric vehicle charger access disparities across race and income in California, *Transp. Policy*. 100 (2021) 59–67. <https://doi.org/10.1016/j.tranpol.2020.10.003>.
- [380] P.K. Tarei, P. Chand, H. Gupta, Barriers to the adoption of electric vehicles: Evidence from India, *J. Clean. Prod.* 291 (2021) 125847. <https://doi.org/10.1016/j.jclepro.2021.125847>.