



**HAL**  
open science

## Ageing and air leakage assessment of a nuclear reactor containment mock-up: VERCORS 2nd benchmark

Julien Niepceron, Laurent Charpin, Manuel Corbin, Benoit Masson,  
Jean-Philippe Mathieu, Jessica Haelewyn, François Hamon, Magnus Ahs,  
Sofia Aparicio, Mehdi Asali, et al.

### ► To cite this version:

Julien Niepceron, Laurent Charpin, Manuel Corbin, Benoit Masson, Jean-Philippe Mathieu, et al.. Ageing and air leakage assessment of a nuclear reactor containment mock-up: VERCORS 2nd benchmark. Nuclear Engineering and Design, 2021, 377, pp.111136. 10.1016/j.nucengdes.2021.111136 . hal-03711943

**HAL Id: hal-03711943**

**<https://hal.science/hal-03711943>**

Submitted on 1 Jul 2022

**HAL** is a multi-disciplinary open access archive for the deposit and dissemination of scientific research documents, whether they are published or not. The documents may come from teaching and research institutions in France or abroad, or from public or private research centers.

L'archive ouverte pluridisciplinaire **HAL**, est destinée au dépôt et à la diffusion de documents scientifiques de niveau recherche, publiés ou non, émanant des établissements d'enseignement et de recherche français ou étrangers, des laboratoires publics ou privés.

# Ageing and air leakage assessment of a nuclear reactor containment mock-up: VERCORS 2<sup>nd</sup> benchmark

## Authors:

- Julien Niepceron (EDF DT, Lyon, France)
- Laurent Charpin (EDF R&D, EDF Lab Les Renardières, France)
- Manuel Corbin (EDF DT, Lyon, France)
- Benoît Masson (EDF DT, Lyon, France)
- Jean-Philippe Mathieu (EDF R&D, EDF Lab Les Renardières, France)
- Jessica Haelewyn (EDF R&D, EDF Lab Saclay, France)
- François Hamon (EDF R&D, EDF Lab Saclay, France)
- Magnus Åhs (Lund University, Lund, Sweden)
- Sofía Aparicio (ITEFI, CSIC, Spain)
- Mehdi Asali, Bruno Capra (OXAND, France)
- Miguel Azenha (ISISE, University of Minho, Portugal)
- David E.-M. Bouhjiti (Univ. Grenoble Alpes, CNRS, Grenoble INP, 3SR, F-38000 Grenoble, France & Currently in Egis Industries, Montreuil, TSA 50012-93188, France)
- Kim Calonius (VTT, Finland)
- Meng Chu (Snerdi, China)
- Nico Herrman (Institute of Concrete Structures and Building Materials (IMB), Materials Testing and Research Institute (MPA Karlsruhe), Karlsruhe Institute of Technology (KIT), Germany)
- Sergio Jiménez (International Centre for Numerical Methods in Engineering (CIMNE), Barcelona, Spain)
- Jacky Mazars (Grenoble INP - Engineering Institute, France)
- Georges Nahas (Institute for Radiological and Nuclear Safety (IRSN), B.P. 17 - 92262 Fontenay-aux-Roses, France)
- Jan Stepan (UJV-EGP, Czech Republic)
- Thibaud Thenint (SIXENSE NECS, France)
- Jean-Michel Torrenti (Université Gustave Eiffel, France)

## ABSTRACT

---

Electricité de France (EDF) operates a large fleet of nuclear reactors and is responsible for demonstrating the safety of facilities, including concrete containment buildings (CCB), which are non-replaceable components. The leak-tightness of CCBs is assessed every 10 years during integrated leak-rate tests (IRLT). For double-wall containments, which have no metallic liners, the leak-tightness is strongly influenced by the degree of cracking of concrete and opening of the cracks, which mostly depends on (a) the prestress decrease due to the delayed strains of concrete, and (b) the saturation degree of the concrete wall. Therefore, to optimize the maintenance programs on CCBs, it is important to predict the evolution of drying, creep shrinkage strains of concrete to be able to

correctly assess the pre-stress losses, and finally the air leak-tightness at a structural level during pressure tests or under accidental loadings.

To improve our understanding and identify the best modelling practices on this issue, a large experimental program called VERCORS was launched in 2014. VERCORS is a 1/3 mock-up of a 1300 MWe nuclear reactor CCB. It is widely instrumented, and its concrete thoroughly studied. A specific attention has been paid to ensure it is consistent with real CCBs features in EDF's nuclear fleet.

To complement its internal R&D efforts, EDF decided to associate external partners to this program. One of the means for this is the organization of benchmarks, where all teams are given data and information about the mock-up and are asked to forecast its behaviour. The present paper reports the organization and findings of the 2<sup>nd</sup> benchmark which was organized in 2018 and gathered several international teams around the same objective: improve the confidence in the modelling of structural behaviour as well as the leak-tightness of concrete in containment walls under pressure test loading.

## 1 INTRODUCTION

---

Choices made by EDF in early 70' during the switch from 900 MWe nuclear power plant (NPP) to 1300 MWe NPP (see Figure 1) lead to a drastic change in the design of the containment buildings. Instead of ensuring the leak-tightness of the single pre-stressed concrete wall with a steel liner, the leak-tightness is obtained thanks to the duplication of the containments (no steel liner, see Figure 2 and [4]), and with an active system that keeps the space between those containments under a constant vacuum. This system improved the nuclear safety of the NPP in a way that the potential radiological elements due to accidental situations can be pumped up and filtered instead of being released in the atmosphere. In addition, the design provides better protection against aircraft impacts.



Figure 1 - French nuclear fleet

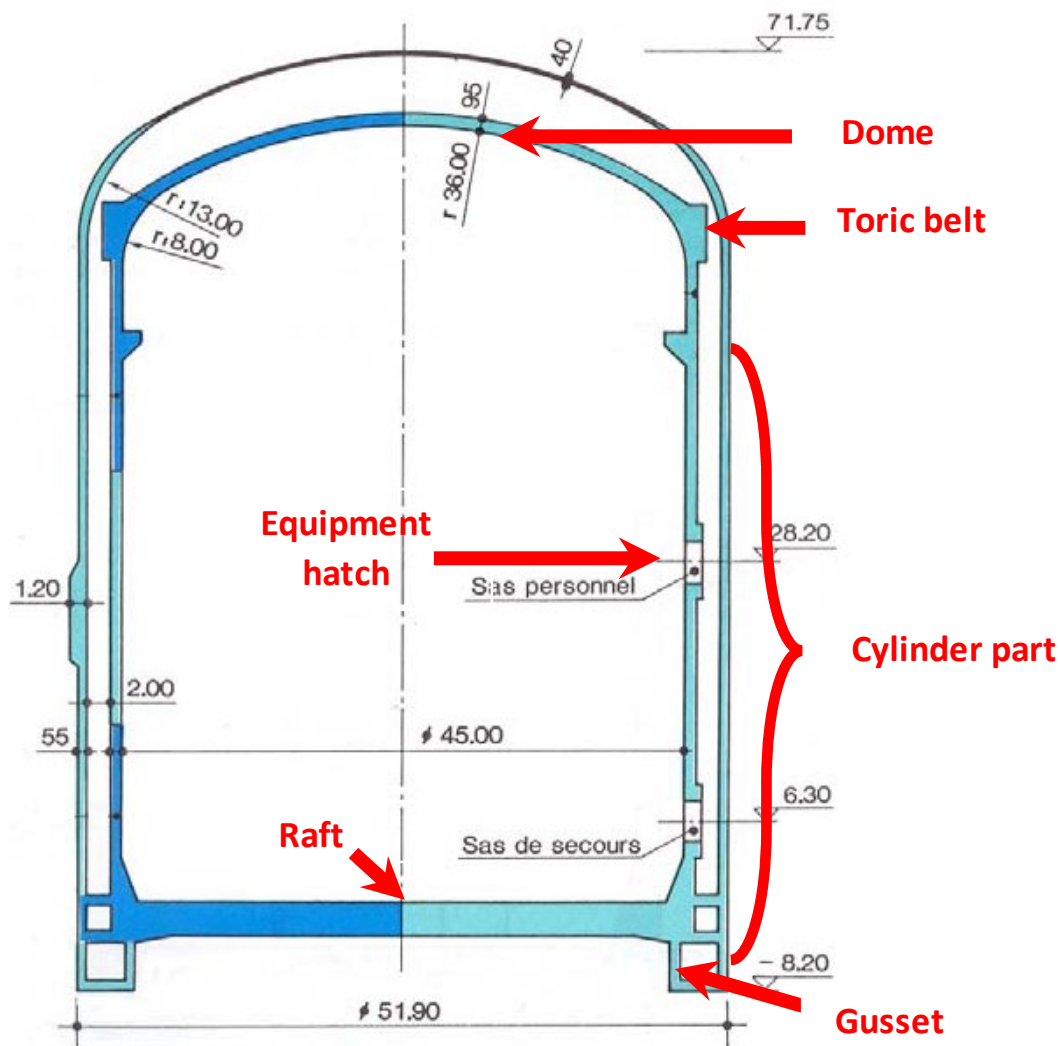

Figure 2 - Double containment reactor building

However, even if the leak-tightness function relies on both containments, there is still an allowed maximum leak criterion on the first pre-stressed containment which is 1.5 % of the air mass per day. According to the French nuclear standards, EDF performs a pressure test every 10 years in order to make sure that this leak criterion is not exceeded. These tests are called ILRT (integrated leak rate tests) and are designated by the name of the decennial periodic safety review during which they occur: VD1 after 10 years of operation, VD2 after 20 years, etc.

To strengthen its approach, EDF performs numerical simulations with Code-Aster® [5] in order to assess the safety margins of the containments on the long term (60 years) regarding the mechanical and the leak-tightness behaviours [1].

The numerical assessment of the leak-tightness of a pre-stressed concrete containment wall remains a complex task for the following reasons:

**Physical complexity:** There are several phenomena affecting the global air tightness of a concrete structure (thermo-hydration, drying, creep, damage, pre stressing, transfer properties, etc.). Understanding and identifying all the physical parameters contributing in the total air leakage (local leaks through cracks or diffuse leaks through the wall porosity) is a key step to achieve an accurate predictive analysis.

**Numerical difficulty:** In the literature, one can find several modelling strategies more or less complex ranging from the microscopic scale to the macroscopic one. However, all these models show strong non-linearity and important numerical costs. From that point of view, a reasonable trade-off between the physical complexity and the numerical achievability is required in order to define a global model including thermal, hydric, mechanical and hydraulic aspects (crack's initiation, propagation, evolution over time, leakage estimation through the porous network).

The VERCORS benchmarks intend to answer these questions and help with the identification of the most accurate (a) modelling strategies (b) physical models (c) up-to-date numerical solving schemes.

To improve its understanding and capabilities to solve both kinds of issues, EDF decided to launch a very large experimental program called VERCORS [1] [2] [3].

This program is based on a 1/3 scale mock-up of the CCB of Nogent sur Seine, which has an average behaviour in terms of delayed strains and leak-rate amongst the 1300 MWe NPP of the French fleet.

This ratio of 1/3 has been decided as it is considered to represent an optimum between representativity of the mock-up (at this scale, it is possible to represent the main features of a real CCB) and acceleration of drying, and hence, ageing of the mock-up (see Figure 3). It is worth mentioning that to allow for thermal cracking to occur in the gusset (see Figure 2) in a similar manner to what happens on real CCBs, this area has been heated after casting. Despite these precautions, and due to complex size effects on cracking of concrete [6], cracking development might be different on VERCORS compared to real CCB. However, cracking in the gusset, which represents the majority of leakage of VERCORS and also on a lot of CCBs (in absence of coating of this area), has been observed to be similar on VERCORS and CCBs. Also, to allow for a development of drying similar to what happens on real CCBs (except for the kinetics effect related to thickness), a heating system has been installed to impose 35°C and 50% RH inside the containment and 20°C and 60% HR outside (i.e. between the two containment walls).

It is important to mention that everything that could be made to this 1/3 scale has been made accordingly (steel rebars, prestressing cables, wall thickness, height, etc.). However, the maximum size of the gravel is limited to 16 mm against 25 mm of the Nogent sur Seine CCB.

The concrete formula to build VERCORS mock-up was strongly inspired from the concrete formulae of the Nogent sur Seine units CCB (aggregates are from the same region).

Based on Eurocode equations, EDF estimated that thanks to its 1/3 scale the acceleration of drying would approximately be speeded up by a factor of 9 in comparison with the real CCB: in EC2 Appendix B, drying shrinkage is proportional to time divided by the square of the thickness (EC2B.116), and drying creep is proportional to drying shrinkage (EC2B.121). Only basic creep is not speeded-up by the reduction of thickness, which is why the speed-up factor is considered approximate.

### 1/3 scale mockup of a containment building

→ aging acceleration:

7 yrs mockup ⇔ 60 yrs NPP

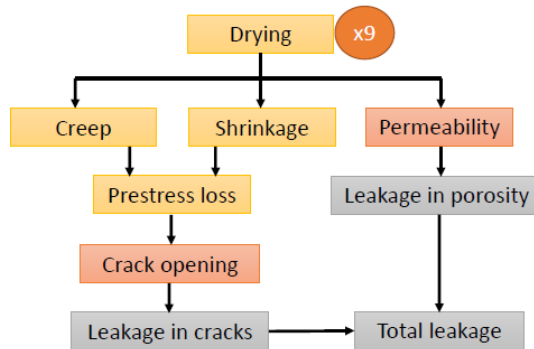

- Geometry: same features as real containment building
- Mechanical load: same prestress, same pressure test

Figure 3 - Aging process of VERCORS mock-up. Grey boxes are relevant during a pressure test or an accident only. During normal operation, the pressure difference between both sides of the wall is very low.

The main events occurring in the operation of VERCORS and a 1300 MWe NPP taken as an example (Nogent 1) are shown in Table 1.

Table 1 - Comparison of events in the life of VERCORS and Nogent 1 CCB

Event	Description	VERCORS		Nogent 1	
		Date	Operation time (y.)	Date	Operation time (y.)
Start of construction	Concreting of the raft	24/07/2014		26/05/1981	
End of construction	End of concreting of the dome	28/04/2015		13/07/1984	
Start of prestressing (excluding raft prestressing for Belleville 1)	Prestressing was performed in numerous phases, ensuring of VERCORS that concrete age was minimum 1 month before prestressing.	06/05/2015		24/05/1984	
End of prestressing		12/08/2015		07/02/1985	
Containment kept wet until this date	To avoid early-age drying, VERCORS was kept wet until the end of prestressing	12/08/2015			
Pre-operational test	This is the first pressure test of the CCB which technically marks the start of the commercial use of the NPP	05/11/2015		07/06/1985	
VC1 test	Control visit (performed twice on Belleville 1)	27/01/2016		29/06/1989	
Start of the reactor	Date of the beginning of operation (it took approximately 1 year to reach full operation power)			02/1988	0
Start of the heating system	For VERCORS, the heating system could not be turned on before VC1, as it should have. <b>The drying and by extension the "aging" process start at this point.</b>	01/03/2016	0		
VD1 test	First decennial test	14/03/2017	1	27/10/1998	10
VD1bis test	This first test was repeated on VERCORS	21/03/2017	1		

	to check whether results changed or not.				
VD2 test	Second decennial test	29/03/2018	2	26/08/2009	21
VD3 test	Third decennial test	19/03/2019	3	04/08/2019	31
VD4 test	Fourth decennial test (Unfortunately, the fourth "Decennial Visit" didn't happen because of the COVID-19 and the confinement obligation in France)	Cancelled			

The pressure typical pressure profile applied on VERCORS during pressure tests is shown on Figure 4.

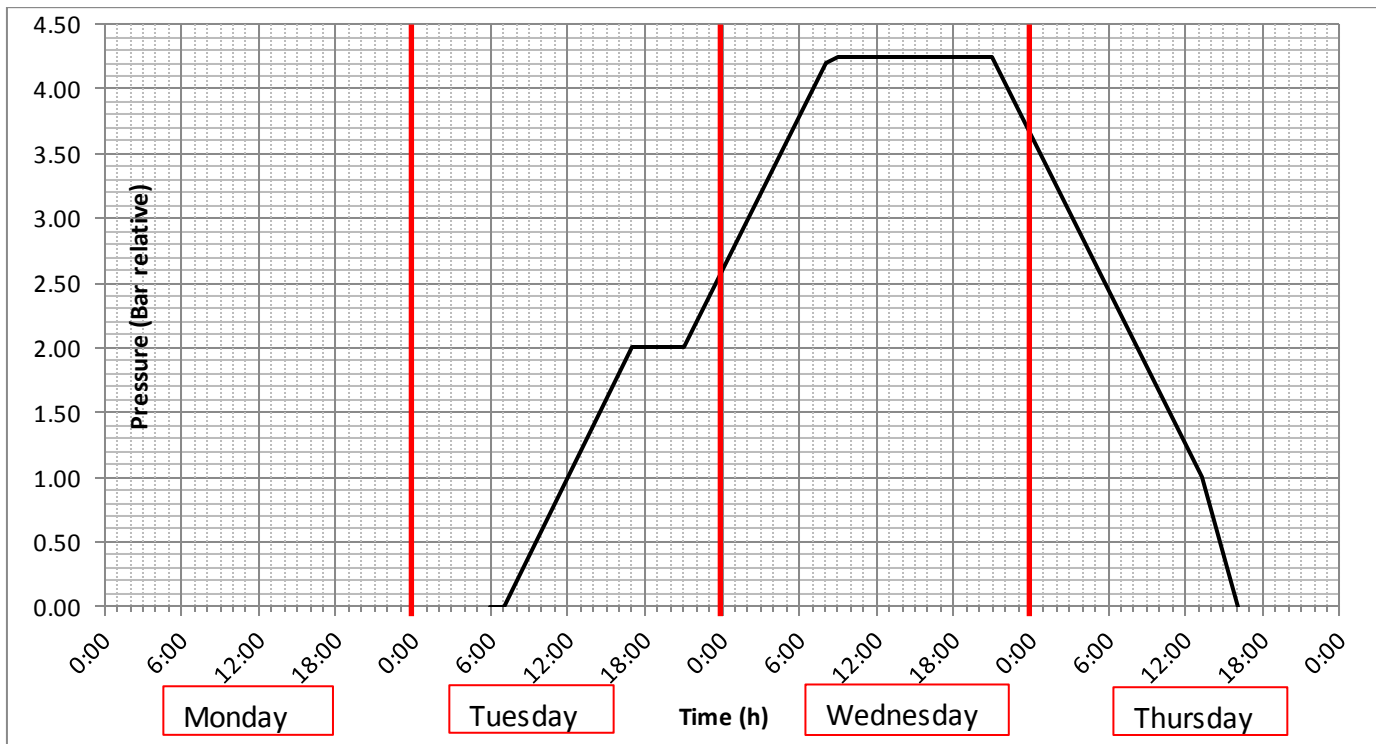

Figure 4 - Typical pressure profile applied during VERCORS pressure tests.

The Figure 5 shows the evolution of the vertical strains of VERCORS from the construction, with some key moments of VERCORS lifetime.

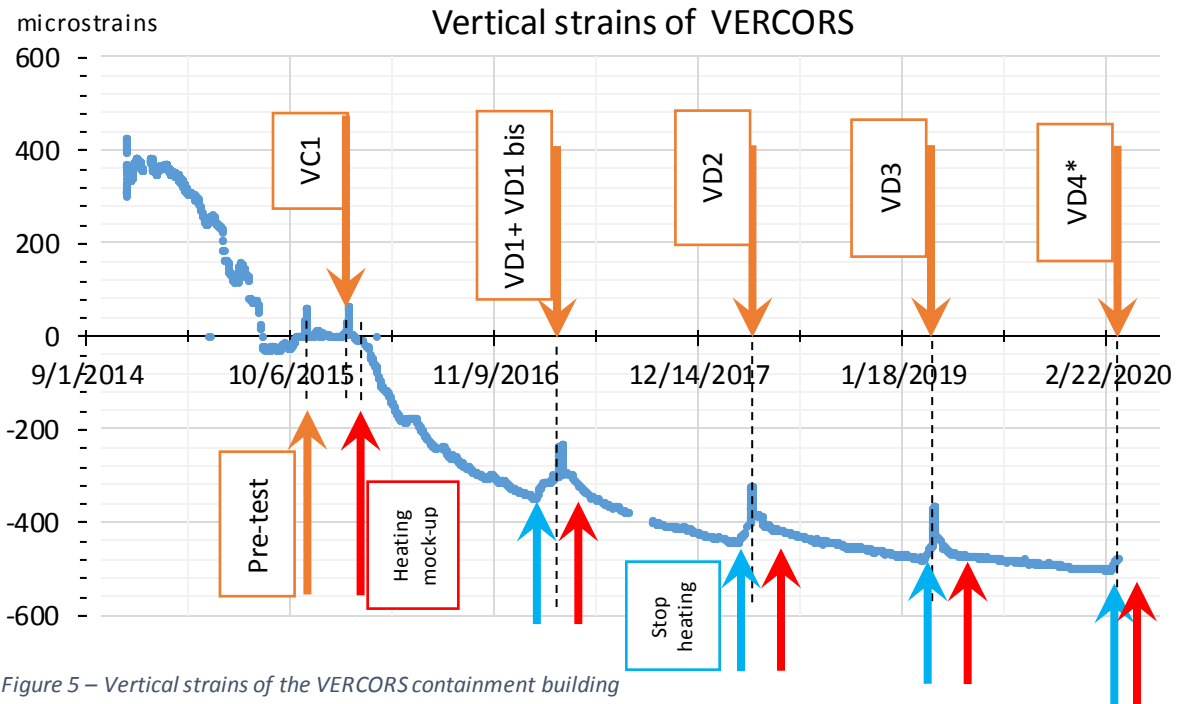

Figure 5 – Vertical strains of the VERCORS containment building

Knowing that the first data from Nogent 1 sur Seine CCB was collected in 1984, the age of this CCB is today about **36 years**, which corresponds to the same “accelerated age” of VERCORS (VD 4 = 4 years x 9 = 36 years).

It is interesting to notice on Figure 6 and Figure 7 that the value of the strains in vertical and tangential directions is very close to each other in the VERCORS Mock-up and the Nogent 1 CCB, which is quite reassuring and would suggest to confirm the time factor of 9 hypothesis. Moreover, when time is expanded by a factor 9 (as estimated with Eurocodes 2 rules), the strain curve fits quite well with the real strain curve of the Nogent CCB.

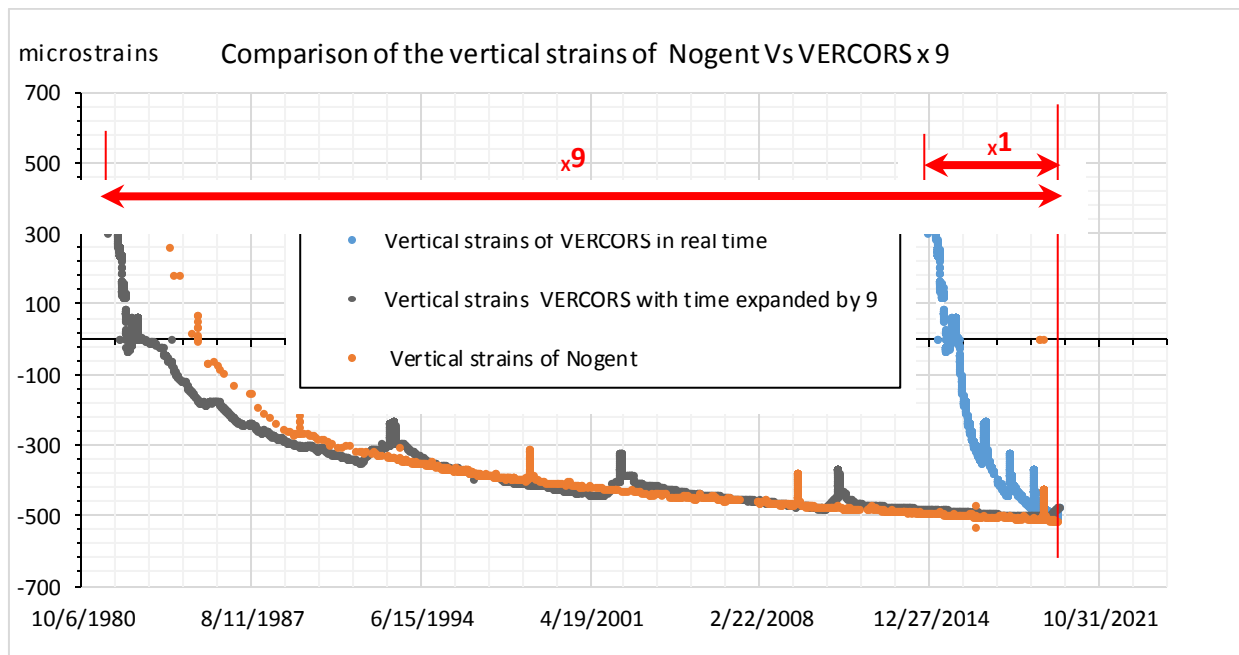

Figure 6 – Vertical strains of Nogent sur Seine containment building



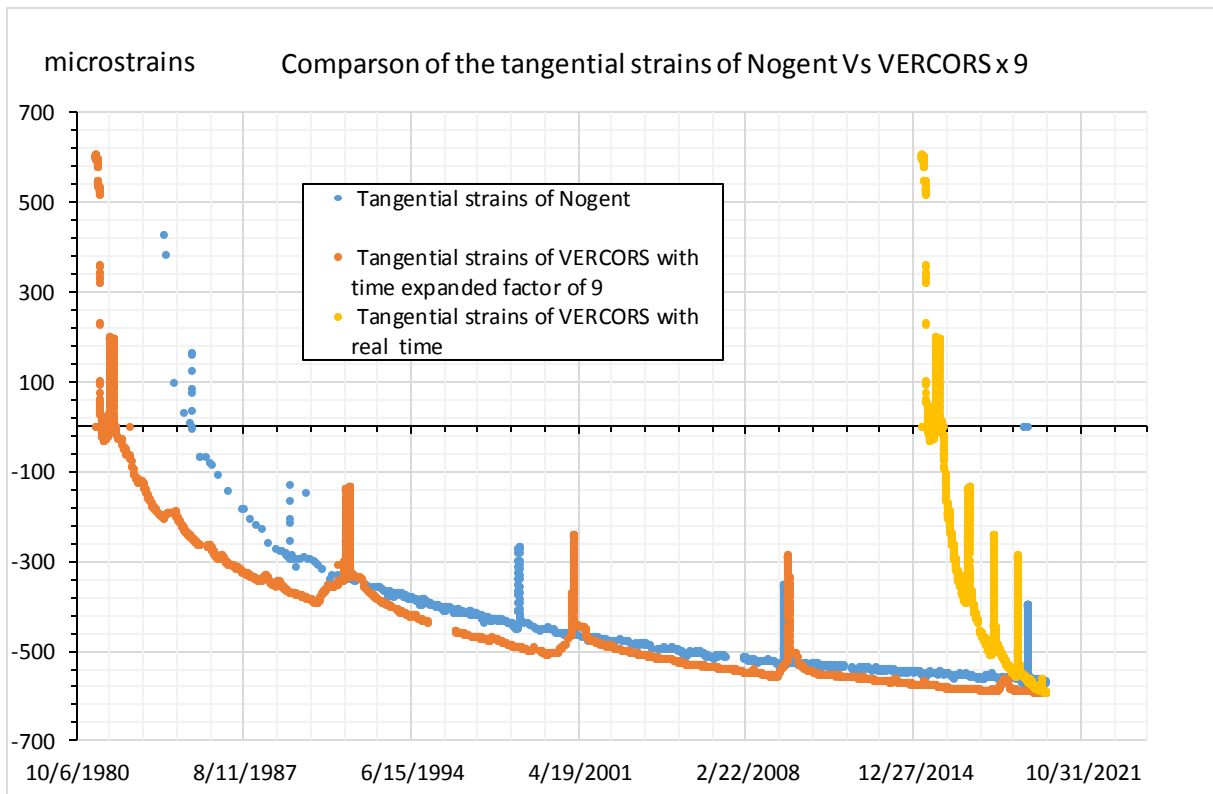

Figure 7 – Tangential strains of Nogent sur Seine containment building

The expected time factor of 9 regarding the ageing process as explained in Figure 3 seems therefore to be confirmed.

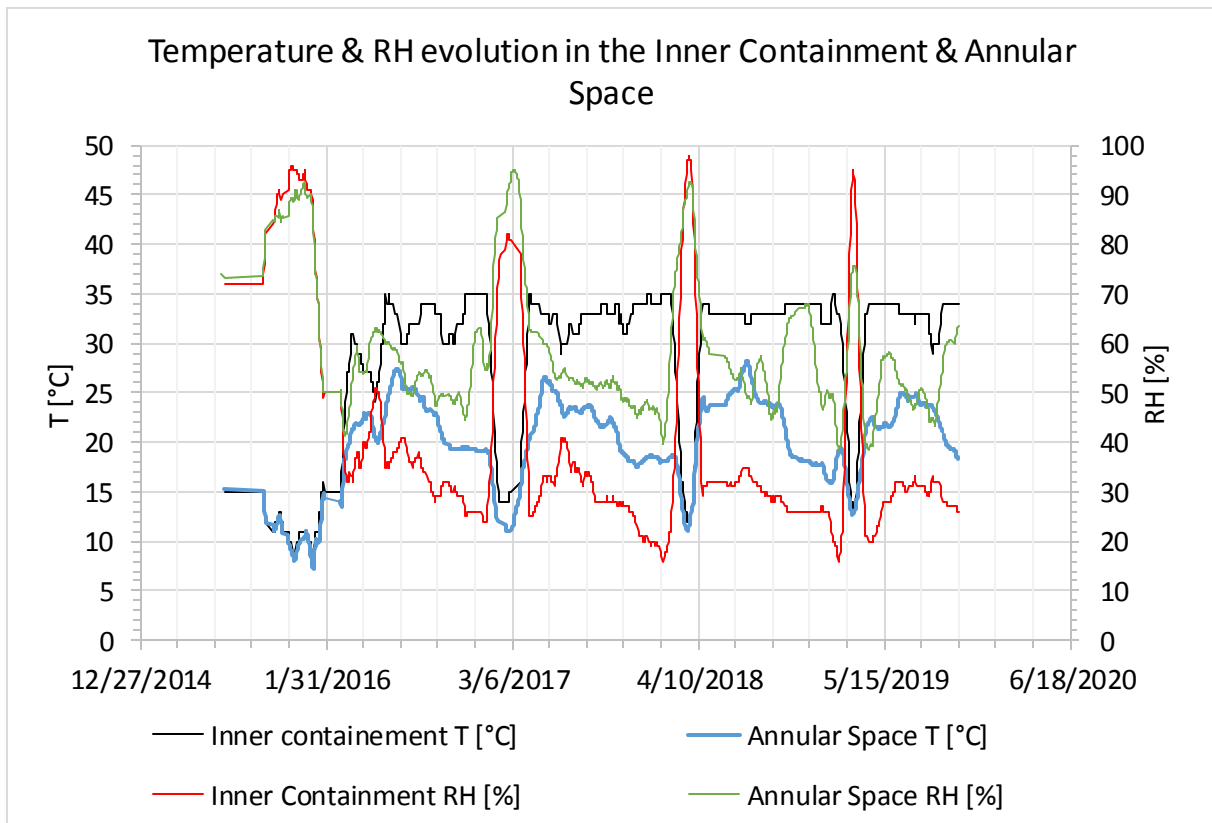

Figure 8 – Temperature & RH evolution in the Inner Containment & Annular Space (mid-height of the containment)

However, it is important to notice that the periodic pressure test itself has a strong influence on concrete drying. Indeed as can be seen on Figure 8 the temperature and RH varies significantly in the VERCORS mock-up, these evolutions are due to certain measures taken before and during the pressure test which certainly slow down the concrete drying process and henceforth the strains:

- during the periodic pressure test performed each year on VERCORS, the heating system is stopped for about 1 month for practical reasons
- VERCORS' foundation raft is completely sunk with a layer of water in order to stop the leakage through this part, however this procedure leads to a high humidity rate in the containment and starts the water saturation in the concrete, on the real CCB the foundation raft is rarely sunk and for a shorter time
- finally the VERCORS mock-up is completely (100% of its surface) inspected each year for local leakage detection by spraying soapy water on the outer surface of the inner containment, this water will certainly saturate in water at least the outer surface of the concrete where in the real containment only a fraction of the surface can be inspected with soapy water.

As it can be seen in details in [1], the VERCORS mock-up is widely instrumented, and its concrete thoroughly studied, so that the research and engineering program accompanying the mock-up has access to a lot of reference data. The aim of this research program is to progress on all scientific, understanding and simulation challenges in order to be able to predict the evolution of leakage of real CCBs, which is the industrial matter faced by EDF.

EDF has also shared as much as possible with the scientific community in this research program, and to do so, on top of many PhD thesis on the topic and the use of VERCORS as a reference case of study in national programs such as MACENA [7] and ENDE [8] and European projects such as the COST action TU1404 [9], EDF thought the best way to treat this challenge was to perform a series of benchmarks where each participant had the same data and the same given objectives to answer. So far there have been 2 benchmarks organized by EDF in 2015 (early-age behaviour and leak-tightness [10] [11]) and 2018 (Creep modelling - Micromechanics and/or Multiphysics approaches; Mechanical behaviour of the containment during pressure test; Air leakage [12] [13]), and **EDF plans a third benchmark in 2021, in the framework of the Euratom project called ACES, starting in summer 2020.**

## 2 2<sup>ND</sup> VERCORS BENCHMARK ORGANIZATION

---

### 2.1 THEMES

For this second benchmark, three main topics were proposed.

#### **Theme 1: Creep modelling - Micromechanics and/or Multiphysics approaches**

The prediction of creep effects is a major challenge regarding the behaviour over time of concrete structures. The proposal was to analyse the phenomenon at several scales and for several environmental conditions, in order to calibrate the models.

Two sub-themes were proposed.

##### 1.1) Micromechanics of cementitious materials

Prediction of basic creep considering the mix design. The results should present the basic creep at multiple scales and be compared to experimental data:

- cement paste: ageing basic creep, characteristics at early age, as measured from the technique described in [14]
- concrete: basic creep at 90 days.

More predictions could be proposed by benchmark participants, at cement paste, mortar or concrete scales, and for different loading times.

##### 1.2) Multiphysics approach for total creep

Predictions of creep behaviour of VERCORS concrete to show the ability of models to describe creep situations under varying environmental conditions. Especially, the request was related to the prediction of the influence of drying-imbibition cycles on the creep of a specific concrete sample. The prediction had to cover:

- basic creep at 20°C;
- drying creep at 20°C and various Relative Humidity (RH 50%, RH 30% and RH 70%);
- drying creep with drying - imbibition cycles at 20°C.

The theme 1 results will not be presented in the present paper, since very few teams responded (only 1 team performed the early-age behaviour simulation). However, for some of the participants, their work in this theme can be considered as the calibration of the constitutive laws used for theme 2.

## Theme 2: Mechanical behaviour of the containment during pressure test

Using as an input the material testing data, the monitoring and ambient conditions data until VD1 (2018), it was asked to make predictions of:

- strains, stresses and cracking history of the whole containment wall during VD1 bis and VD2 pressure test;
- the delayed strains at VD2 pressure test.
- strains, stresses and cracking history of the whole containment wall during VD2 pressure test.

## Theme 3: Air leakage

Using results from theme 2 and IRLT results until VC1 (2017) included, it was asked in this theme 3 to make predictions of air leakage during the pressure tests (VD1, VD1 bis and VD2), at the end of the 4.2 relative bars pressure plateau, globally for the whole containment and for several subzones: dome area, equipment hatch area, gusset area and cylindrical part.

## 2.2 SCHEDULE

The benchmark was started in early 2017, and results due by March 2018, as can be seen on Figure 9.

	2017												2018							
	1	2	3	4	5	6	7	8	9	10	11	12	1	2	3	4	5	6	7	8
Start		◇																		
Mockup air tests (VD1=>VD1bis=>>VD2)			◇◇													◇				
Final report (March, 30th)																◇				
Experimental results sent to participants	March 2017 air test																			
	April 2018 air test																			
Complementary works (if desired) before workshop																				
Workshop Paris EDF Lab Saclay 08/27-31 (week 35)																				◇

Figure 9 - Schedule of the VERCORS 2nd benchmark

More specifically, the key dates of the benchmark were:

- February 6, 2017: start of the benchmark
- March 2017: additional data regarding VD1 pressure test given to participants
- March 30, 2018: results have to be sent to EDF
- April 2018: additional results regarding VD2 tests given to participants to improve their models for the workshop.
- August 27-31, 2018: restitution workshop in EDF Lab Saclay, France

## 2.3 DATA GIVEN TO PARTICIPANTS

For this second benchmark, EDF provided a large selected database to the participants with the aim to allow them building their simulations (CAD geometry and finite element mesh), to give them information about the materials (different laboratory tests on concrete and steel samples), and to

give them information about the ambient conditions of the mock-up and the monitoring data obtained. The concrete properties given to participants are detailed in Table 2.

All data was available on [www.fr.xing-events.com/EDF-vercors-project.html](http://www.fr.xing-events.com/EDF-vercors-project.html) which is still online at the present time. The data provided for the benchmark is available as supplementary material to this paper.

Table 2 – Concrete properties (sample sizes in cm)

Data	Unit	Origin	Comment
Concrete Composition	-	-	EDF specification
Mortar Composition	-	-	EDF specification
Cement paste Composition	-	-	EDF specification
Density	[kg/m <sup>3</sup> ]	Each VERCORS lift	Cylinder 11x22
Air content	[%]	Each VERCORS lift	Specific test
Consistence	[mm]	Each VERCORS lift	Slump test
Young modulus	[GPa]	Several VERCORS lifts	Cylinder 11x22
Compressive strength (28 days)	[MPa]	Each VERCORS lift	Cylinder 11x22
Tensile strength (28 days)	[MPa]	Each VERCORS lift	Split test (cylinder 11x22)
Compressive strength (7days)	[MPa]	Each VERCORS lift	
Fracture energy	[J.m <sup>-2</sup> ]	Lab sample	
Specific heat	[J.m <sup>-3</sup> .K <sup>-1</sup> ]	Lab sample	
Thermal conductivity	[W.m <sup>-1</sup> .°C <sup>-1</sup> ]	Lab sample	
Convective exchange coefficient	[W.m <sup>-2</sup> .°C <sup>-1</sup> ]	No	During erection
Hydration heat release		Lab sample	Semi-adiabatic test (QAB)
Autogenous shrinkage evolution	[µm/m]	Lab sample	Cylinder 16x100
Drying shrinkage evolution	[µm/m]	Lab sample	Cylinder 16x100, drying at 90 days
Basic creep evolution	[µm/m]	Lab sample	Cylinder 16x100, force applied at 90 days
Drying creep evolution	[µm/m]	Lab sample	Cylinder 16x100, force applied at 90 days, drying at 90 days
Porosity	[%]	Each VERCORS lift	
Loss of mass/hygrometry curve		Lab sample	Cylinder 16x100

The material characterization of rebars and tendons are given in Table 3 and Table 4.

Table 3 – Rebars properties. Data from vendors.

Data
Young modulus

Stress/strain  
relation curve

Table 4 - Tendons properties. Data from vendors

Data
Stress/strain relation curve
Ultimate yield strength warranty
Elastic Yield strength warranty
Relaxation at 1000h at 20°C
Friction coefficient for vertical tendon
Friction coefficient for horizontal tendon

The finite element mesh was provided but not imposed to participants. A view of the coarsest provided mesh is shown on Figure 10.

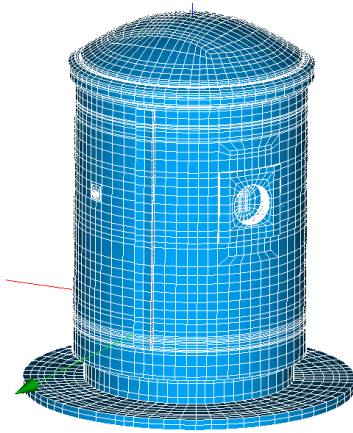

Figure 10 - Coarse mesh

Two quantities were monitored and given to the participants regarding the ambient air conditions experienced by the mock-up. These quantities are presented in Table 5.

Table 5 - Ambient air conditions

Data	Unit	Period	Comment
Temperature	°C	From the inner containment closure	Temperature in the inner containment and the annular space
Hygrometry	%	From the inner containment closure	Hygrometry in the inner containment and the annular space

The monitoring and ILRT results given to participants are described in Table 6.

Table 6 - Monitoring & ILRT results

Result	Unit	Period or test	Comment
Measured strains	μm/m	From the start of prestressing to the 'VD1' test	In some points: raft, gusset, mid-height, dome. Strains are not corrected from thermal effects. Associated measured temperatures are given
Measured strains	μm/m	During pressure	In some points: raft, gusset, mid-height,

		tests: 'Pre-Op' 'VC1' 'VD1'	dome. Strains are not corrected from thermal effects. Associated measured temperatures are given
Global air leakage flow	Nm <sup>3</sup> /h	'Pre-Op' 'VC1'	The so-called "Normo" volume of a gas (expressed in Nm <sup>3</sup> ) is the volume it occupies in standard conditions for temperature and pressure: T <sub>N</sub> = 273.15 K and P <sub>N</sub> = 1013.25 hPa.
Air leakage repartition		'Pre-Op' 'VC1'	Zones: gusset, cylinder, hatch area, dome
Leakage faults location		'Pre-Op' 'VC1'	Tables: given location, type of the faults, geometric characteristics
Leakage faults measured flows	Nm <sup>3</sup> /h	'Pre-Op' 'VC1'	Tables: given measured flow for each leakage fault

## 2.4 MONITORING

The position of the main sensors concerned by the benchmark is given in Figure 11 (gusset), Figure 12 (cylinder and dome, elevation view) and Figure 13 (cylinder and dome, section view).

VERCORS

Strain gauges and thermometers  
Base slab – Gusset  
Section AA

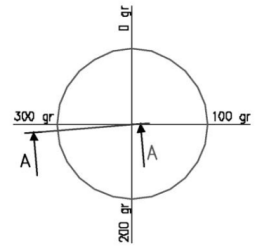
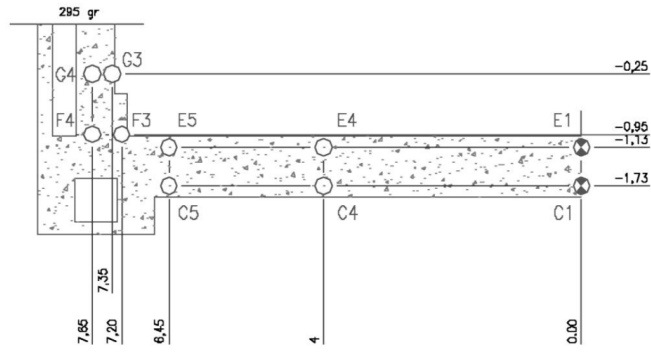

- 1 radial + 1 tangential + 1 PT100
- ⊗ 2 perpendicular radials + 1 PT100



VERCORS

Strain gauges and thermometers  
Base slab – Gusset  
Section BB

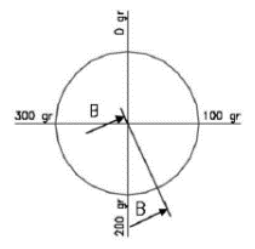
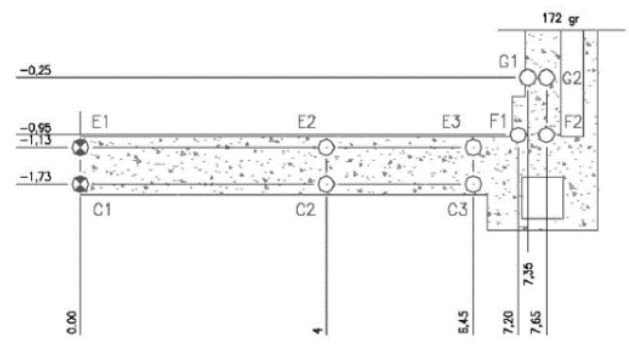

- 1 radial + 1 vertical + 1 PT100
- ⊗ 2 perpendicular radials + 1 PT100



Figure 11 - Position of the strain gauges and thermometers in the base slab and the gusset



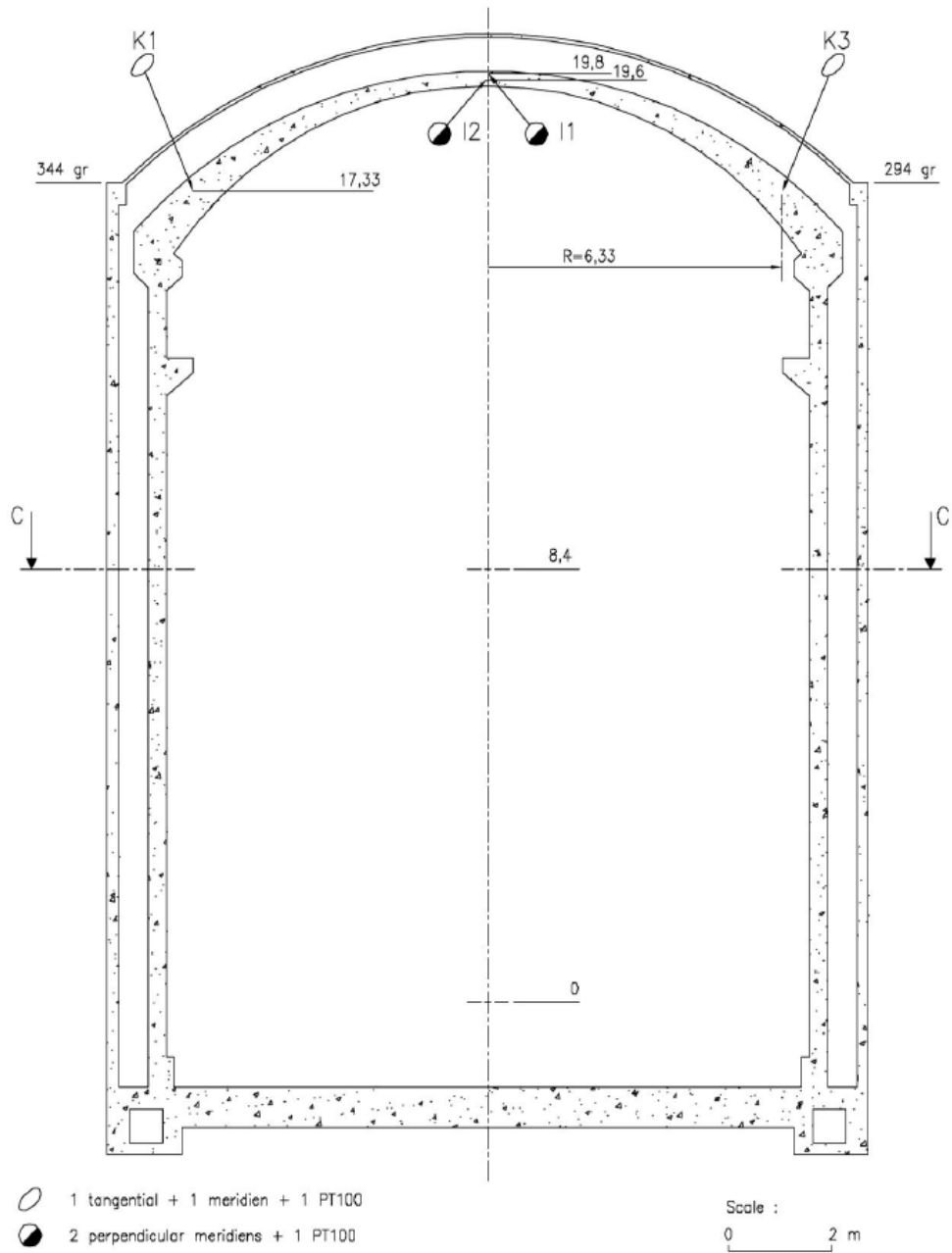

**The shape of the base slab is given as an indication. There is no gallery in the base slab of the mock-up.**

Figure 12 - Position of the strain gauges and thermometers in the cylindrical part and the dome – elevation view

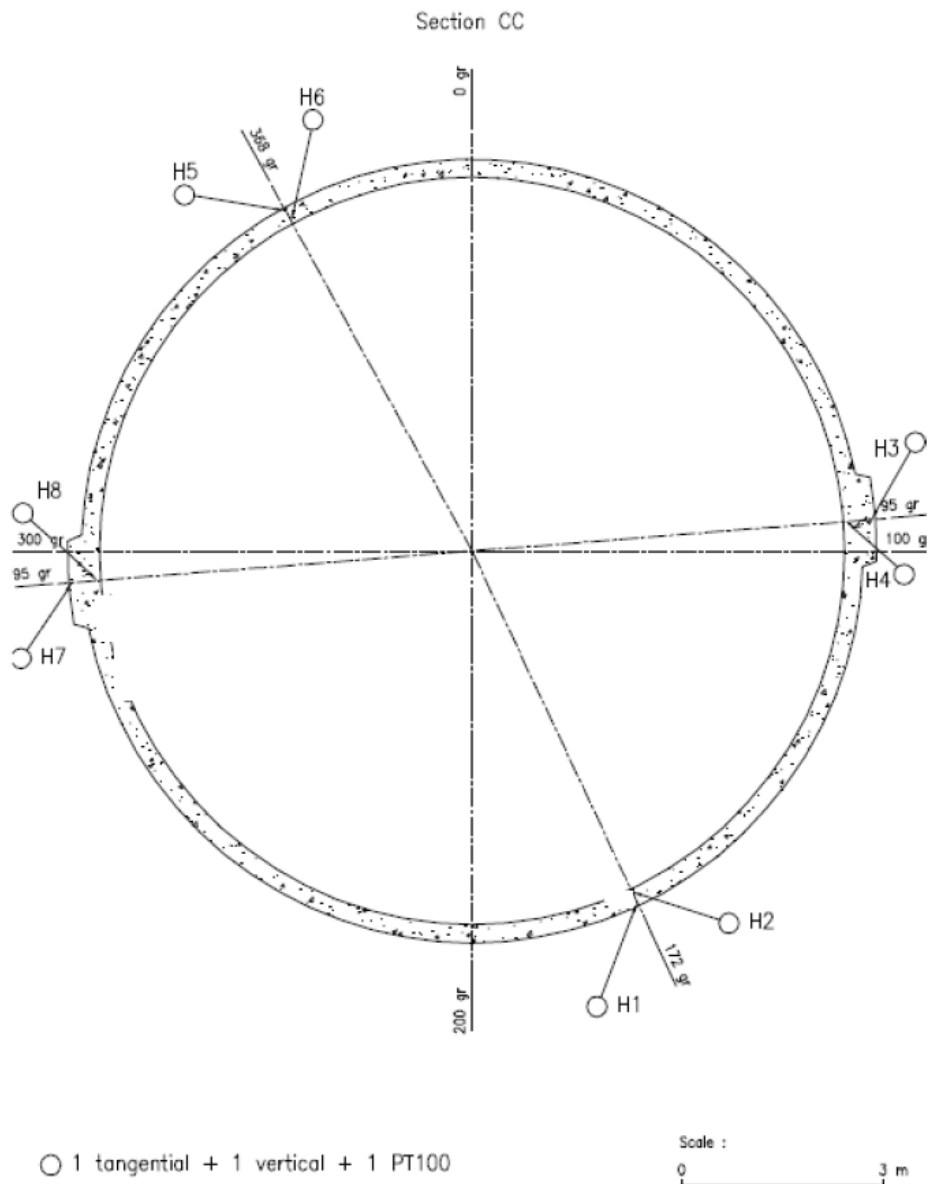

Figure 13 - Position of the strain gauges and thermometers in the cylindrical part – section view

### 3 2<sup>ND</sup> VERCORS BENCHMARK COMMUNITY

#### 3.1 PARTICIPANTS

The geographical origin of the participants is given in Figure 14.

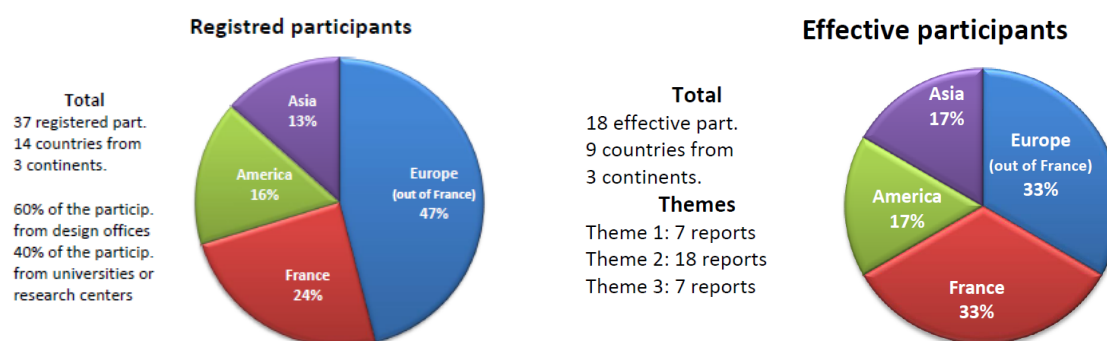

Figure 14 - Origin of the registered participants & repartition of the effective participants

The detail of effective participants by theme is given in Table 7.

Table 7 – List of participants (see section “themes and key dates”). Team number are not given for the participants who did not explicitly agree.

Authors	Organization	Country	Themes	Number
YANGSU Kwon, KEUN-KYEONG Kim, MYUNG-SUG Cho, KYUNG Hun Kang, HONG-PYO Lee	KHNP CRI (Korea Hydro and Nuclear Power Co., LTD, Central Research Institute)	KR	1, 2, 3	
Jan STEPAN	UVJ Rez, a.s. div. Energoprojekt Praha	CZ	2	24
Sofía APARICIO, M.G. HERNÁNDEZ and J.J. ANAYA	ITEFI (CSIC), Madrid	SP	2	86
Sandrine KERVORKIAN, Julien CLEMENT, Georges NAHAS	IRSN	FR	2	66
Pentti VARPASUO, Joonas KOSKINNEN	Fortum Power & Heat Ltd / PVA Eng Services	FI	2	
Mehdi ASALI, Bruno CAPRA	OXAND	FR	1, 2, 3	14
David BOUHJITI; Julien BAROTH; Frédéric DUFOUR; Matthieu BRIFFAUT; Benoît MASSON, Sylvie MICHEL-PONNELLE	Industrial chair PERENITI (EDF-SETEN/DTG/CIH & 3SR Laboratory), EDF R&D	FR	1, 2, 3	50
Kim CALONIUS	VTT Technical Research Centre of Finland Ltd	FI	1, 2, 3	23
Sergio JIMÉNEZ, Alejandro CORNEJO, Lucia BARBU, Sergio OLLER and Alex BARBAT	International Centre for Numerical Methods in Engineering (CIMNE) / Technical University of Catalonia (UPC), Barcelona	SP	2	84
Xu HUANG; Oh-Sung KWON; Evan BENTZ	University of Toronto	CA	2	
Mahsa MOZAYAN; Nicolas GOJJARD	INGEROP / Mines Paris - Tech	FR	2, 3	
Rong PAN, Meng CHU, Chaochao ZHAO, Jin ZHANG, Zhengyi TANG, Guopeng REN	Shanghai Nuclear Engineering Research and Design institute	CN	2	15
Magnus ÅHS, Richard MALM and Christian BERNSTONE.	Lund Univ. / KTH Royal Inst. Of tech./Vattenfall AB	SE	1, 2	82
Joshua HOGANCAMP, Gregg FLORES, Madhumita SIRCAR	Sandia National Laboratories / US. Nuclear Regul. Com.	US	1,2	90

Jean-Michel TORRENTI, Abdushalamu AILI	University Gustave Eiffel (formerly IFSTTAR)	FR	1,2	47
Jiang-Ying WU	South China University of Technology, Guangzhou	CN	2	
Homayoun ABRISHAMI, Amir GHAEMMAGHAMI	Candu Energy Inc.	CA	2	
Thibault THENINT, Véronique LECORVEC, Shahrokh GHAVAMIAN	Sixence, NECS	FR	1, 2, 3	88

### 3.2 SCIENTIFIC COMMITTEE

The members of the scientific committee are the following ones:

- Secretary: Manuel Corbin, Civil Engineer, EDF SEPTEN (FRA)
- Jacky Mazars, Grenoble INP - Engineering Institute (FRA)
- Nico Herrmann, Head of Department, Institute of Concrete Structures and Building Materials (IMB), Materials Testing and Research Institute (MPA Karlsruhe), Karlsruhe Institute of Technology (KIT) (GER)
- Maria Guimaraes, Principal Project Manager, Electric Power Research Institute (EPRI) (USA)
- Hasan Charkas, Senior Technical Leader, Electric Power Research Institute (EPRI) (USA)
- Miguel Azenha, Assistant Professor, ISISE, University of Minho (POR)
- Kim Calonius, Senior Scientist, VTT Technical Research Centre of Finland (FIN)
- Jean-Philippe Mathieu, Project Manager, EDF R&D (FRA)
- Benoit Masson, Containment and third barrier Expert, EDF SEPTEN (FRA)

## 4 MODEL DESCRIPTION AND CALIBRATION PROCEDURE

The benchmark participants used a wide variety of models to answer the different items proposed by EDF. A brief description of the models used is summarized in section 2.1. In this section, the approaches used by the participants are briefly described in terms of model used (finite elements software, analytical approach, etc.), constitutive laws and calibration procedure. For the sake of conciseness, only a short description of each model is provided in Table 8. Most models were described more accurately in the book of abstracts of the restitution workshop [15], available upon request to EDF and added as supplementary material to this paper, or in published papers referenced in Table 8.

*Table 8 - Models short description*

Team	Short model description	Reference
80	The simulations are performed with Nastran. Concrete is modelled with shell elements. Rebars are not modelled, tendons are modelled with rod elements. Only the response to pressure test is computed.	
88	The simulations are performed with Code_Aster 12.4 [5], the mesh is composed of solid elements for concrete, membranes for rebars, and 1D bars for tendons. Thermal and drying analyses are performed. A creep and a shrinkage model are used and calibrated based on laboratory data. A damage model is used for crack opening prediction. Flow is computed through concrete cracks.	1 <sup>st</sup> benchmark article [16]. 2 <sup>nd</sup> benchmark article [17]
49	The simulations are performed with Code_Aster 10.6 [5], the mesh is composed of solid elements for concrete, rebars are taken into account with EC2, and 1D bars for	

	tendons. The delayed strains of concrete (drying shrinkage, thermal shrinkage, drying creep, basic creep) are considered in the mechanical calculations. The model parameters are calibrated on monitoring data. The damage variable and the macro-crack parameters are obtained using a methodology based on continuum damage mechanics for reinforced concrete. Crack properties are determined according to EC2.	
47	The model used is an analytical model representing a typical section of the cylinder. Superposition principle is applied. The constitutive behaviour is based on Model_Code 2010 [18] formulas for creep and shrinkage (adapted for biaxial loading and with thermal activation) and is calibrated on laboratory results. Relaxation of the prestressing is taken into account.	[19]
82	The simulations are performed with COMSOL Multiphysics 5.3a, concrete is modelled with solid elements, the rebars are not modelled, and tendons are modelled with truss elements. Drying is modelled with a nonlinear diffusion equation, creep and shrinkage are modelled according to EC2.	[20]
50	The simulations are performed with Code_Aster software [5] using a stochastic Representative Structural Volume (RSV) subdivision approach to reduce the computational cost without altering the physical representativeness. Accordingly, different FE models are used for the gusset, wall, dome and opening parts. Boundary conditions are defined to account for the structural rigidity around the RSVs. The used physical model is based on a weakly coupled thermo-hydro-mechanical scheme covering the early age phase and the operational one within a strain-based and energy-regularized damageable and viscoelastic framework. Details of such modeling strategy are presented in [21] [22] [23]. The air tightness of each RSV is assessed over time based on a newly developed damage-permeability law allowing a continuous definition of the concrete transfer properties from a sound (continuous) towards cracked (discontinuous) states. Ultimately, the used deterministic model is coupled to a non-intrusive probabilistic framework in order to quantify the uncertainty level of the model results based on the intrinsic variability of each physical input. Tackled topics concern the stochastic cracking of concrete and the risk of exceeding the regulatory threshold of the air leakage rate [ref: D. E. M. Bouhjiti. Probabilistic analysis of cracking and tightness of large Reinforced Concrete structures. PhD thesis. 2018. Univ. Grenoble Alpes. France].	[21] [22] [23]
90	The simulations are performed with Abaqus 6.14. Thermal and hydric effects are not accounted for. Concrete is modelled as viscoelastic, the model is calibrated on laboratory experiments.	
74	The simulations are performed with VecTor4 v4.0. The containment is modelled with shell elements (including rebars and tendons as smeared reinforced layers). No thermal and hydric calculus are performed. Delayed strains are accounted for using Model Code 2010. VecTor4 uses a smeared, rotating-crack formulation for reinforced concrete based on the Modified Compression Field Theory and the Disturbed Stress Field Model. Flow through cracks is computed from crack distribution.	
84	The simulations are performed using the PLCd code [24]. The analysis is based on the Serial Parallel Rule of Mixtures theory [25] [26] applied on a 3D finite element model of the structure. This approach allows the use of distinct constitutive models [27] for each of the component materials (rebars, concrete and tendons) and predicts both the overall behaviour of the prestressed concrete containment and the stress and strain states of the materials in each finite element. The prestressing steel is modelled through a viscoelastic model (generalized Maxwell) and the reinforcing steel has been homogenized with the concrete whose behaviour is captured through an isotropic	[28]

	damage model together with an uncoupled Kelvin model. No thermal and hydric calculations are performed. The evolution in time of the prestressing has been also studied.	
24	The simulations are performed with Abaqus R2017x. The concrete is modelled with solid elements. Tendons are modelled with bar elements embedded into the solid elements, distributions of forces in the tendons along their length were considered as variable due to friction but bonded tendons were considered since the beginning of analyses. Rebars and cracking of concrete are not represented in the model. A viscoelastic law is used for modelling of delayed strains of concrete and relaxation of tendons. Parameters of the viscoelastic models were set according available laboratory test results and were later modified with the aim to fit strains measured on structure. Temperature history was considered as a temperature boundary condition in the model including the effect of temperature to delayed strains of concrete and relaxation.	
86	The simulations are performed with COMSOL 5.3a. The concrete is modelled with solid elements. Rebars and tendons are not accounted for. A model of the gusset is used.	
56	The simulations are performed with ANSYS 17. The concrete is modelled with solid elements. Rebars are modelled as smeared with the solid elements and tendons using link elements. No thermal calculation is performed. Creep and shrinkage are not accounted for.	
92	The simulations are performed with Abaqus 6.14. The concrete is modelled with solid elements. The rebars are modelled with membranes, the tendons with bars. No thermal and hydric calculations are performed. Elastic and fracture behaviour of concrete.	
76	The simulations are performed with Abaqus 6.14. The concrete is modelled with solid elements. Rebars are taken into account by modifying concrete strength. Tendons are modelled by truss elements. Thermal behaviour and drying are not modelled. A viscoelastic law is used for creep.	
15	The simulations are performed with Abaqus 6.13. The concrete is modelled with solid elements. Rebars and tendons are also modelled as solid elements. No thermal and hydric calculations are performed. The whole model is divided into 10 layers with different material behaviour. A creep and shrinkage model is used (Chinese code GB50010-2020) and calibrated on laboratory data. The criterion for cracking of concrete is the max principal logarithmic strain larger than a given threshold.	
23	The simulations are performed with Abaqus 6.14. The containment is modelled with shell elements in 3D. Rebars are modelled with grid elements (smeared rebar layers within shell elements), tendons with 1D elements. The interaction (sliding of tendons etc.) between the concrete and tendons is modelled with connector elements. In the simulation, all the tendons are tensioned and locked simultaneously. No thermal calculation is performed. Long term strains are calculated according to EC2 separately from the FE simulation. Cracking is determined as a post-processing of the viscoelastic calculus. Leakage through cracks and through concrete is considered with analytical equations.	1 <sup>st</sup> benchmark [29], 2 <sup>nd</sup> benchmark [30]
14	Chained weakly-coupled thermo-hydro-mechanical approach implemented with Code_Aster 12.3 [5] as FE solver and TFEL/MFront 2.0.1 [31] for the mechanical constitutive laws. The concrete is modelled with solid elements, tendons with 1D elements. Rebars are not modelled. No early-age evolution of the structure is considered. Thermal, hydric, shrinkage and creep behaviours are calibrated on provided data. The damage elastic mu-model is used for concrete to consider the cracks' potential closing	1 <sup>st</sup> benchmark article [32]

	and reopening due to cyclic pressure tests. Temperature, saturation degree, stress, strain and damage fields are then used for a final leakage computation, using an in-house 3D concrete FE superimposing the flows through both unsaturated porosity and cracks. Initial defects or cracks arising from early age, which are not modelled, can be patched once characterized in-situ or by reverse identification in order to assess the long-term behaviour of the mock-up.	
66	The simulations are performed with Cast3M2015. The concrete is modelled with solid elements. Rebars and tendons are modelled individually with 1D elements. The Creep and shrinkage are modelling using the EC2-2 formulas. Concrete behaviour is modelled with Ottosen model (smeared crack). The calculation considers the different stages of the construction of the muck-up and the step of tensioning.	

## 5 BENCHMARK RESULTS: MECHANICAL PREDICTIONS

---

As shown earlier, the participants had access to the material characterization information (concrete and steel material properties) for the calibration of their models, and to monitoring data up to VD1/VD1bis (temperature and strain in concrete, displacement measured on the structure, ambient temperature and humidity). One of the difficulties of the benchmark was to take correctly into account the fact that de containment was artificially wet after construction and until prestressing to avoid excessive drying before prestressing, which was communicated to the participants but is not easily visible on relative humidity measurements.

The participants chose different approaches to calibrate their models: some performed a careful calibration of the material parameters on the material data using models including all the necessary terms of delayed strains (teams 14, 47, 82, 50), most of the teams used code laws (EC2, MC2010, etc.) or laws not taking into account the effect of humidity and temperature that could not be easily calibrated on the material data. It should be noted that the muck-up is heated to 35°C to simulate the normal operation of CCB. Therefore, the representativity of the constitutive models for the VERCORS materials is very diverse amongst the participants. For the sake of conciseness, these calibration results could not be detailed in the present paper. However, it is important to notice that this point has a large influence on the results obtained by the different teams.

In the present section, two types of predictions asked to the participants are shown:

1. participants were asked to predict the strains developing from the end of the prestressing phase (with a reference time taken on November 2, 2015) to the beginning of the VD2 pressure test (March 2018), while data was only accessible until VD1 (March 2017), which means that the evolution of temperature, moisture and strain had to be predicted for a time duration of 1 year;
2. participants were asked to predict the strain developing during the VD2 pressure test, between the beginning of the test (with a null relative pressure) and the 4.2 relative bars configuration.

In the following, only the strain results in selected areas will be presented, even though participants had to report strain in several locations. More specifically, the regions of interest on which this paper is focused on are the sensors H6 in the cylindrical part and G1 and G2 in the gusset area. For the cylindrical part only one location was selected because results are similar for the inner and the outer face of the wall, while for the gusset sensors on the inner and outer face were selected because the results (experimental and numerical) are quite different.

The location of the sensors is shown in Figure 15.

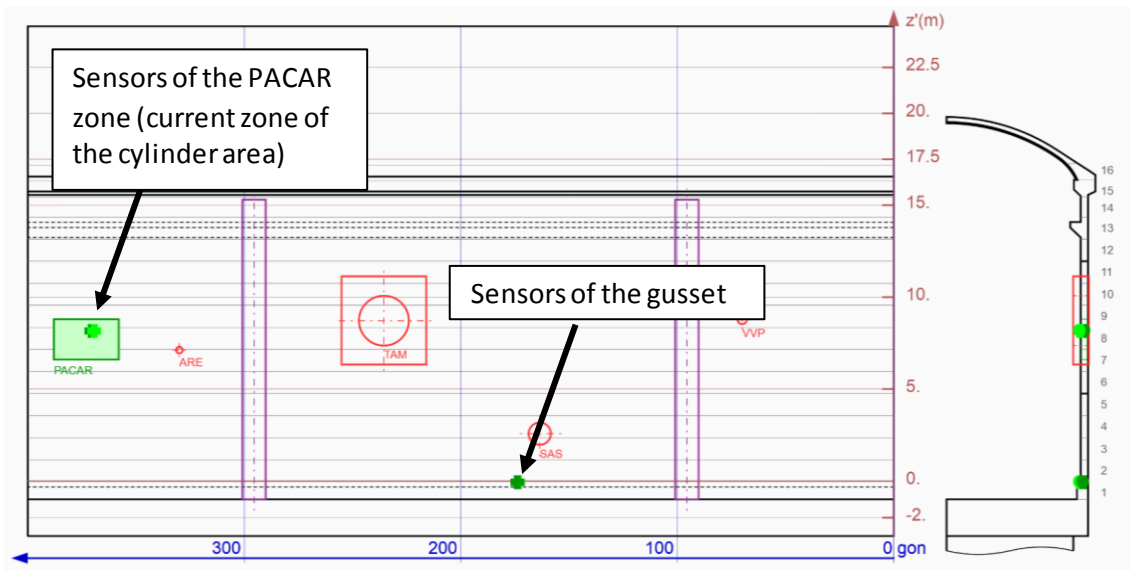

Figure 15 - Location of the strain sensors used for comparison of experimental and numerical strain at VD2. The sensor H6 is located in the PACAR area (current zone of the cylinder area), while G1 and G2 are located in the gusset area (at the bottom of the mock-up).

The strain values (both experimentally and numerically) presented are total strain, which means that they include the thermal expansion of the structure, but not the direct thermal effects on the sensor itself.

### 5.1 STRAINS EVOLUTION FROM THE END OF PRESTRESSING (2/11/2015) TO VD2.

In this part, the participants had to predict one year of ageing of the mock-up. As it can be seen in Figure 16, different teams made different choices to predict the ageing strain. However, the calibration procedure is very different from one participant to another and most of the participants did not reproduce strains at VD1 (which were available) in a satisfactory manner.

One can see that the difference between the vertical (sensor H6IV) and tangential (sensor H6IT) strains is greater in the simulations of the participants than in the experiment. The fact that the vertical and tangential strains in containments evolve very similarly after prestressing has already been noted by different authors (e.g. [33]) but is not very well accounted for by some models. Teams 24, 47, 84 and 88 show relatively more accurate results for the selected sensors.



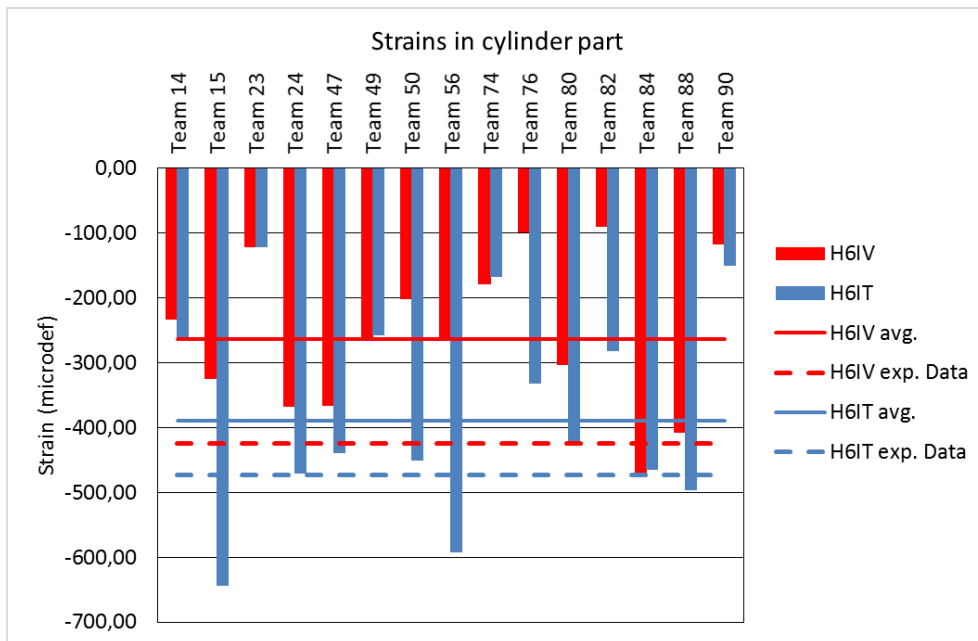

Figure 16 - Vertical and horizontal ageing strains in the cylinder part at VD2

In a second step, the strains related to ageing are compared in the gusset area. For this region, since the inner face and the outer face strains are quite different due to bending effects, both results are presented. The vertical strains in the gusset are presented in Figure 17. A large discrepancy of the results is again observed. On average, computations tend to underestimate strains, as for the cylinder part. Moreover, bending effects, due to the fact that contraction is larger on the inner face than on the outer face, are well reproduced. The results proposed by team 24 are the closest ones to the experimental results.

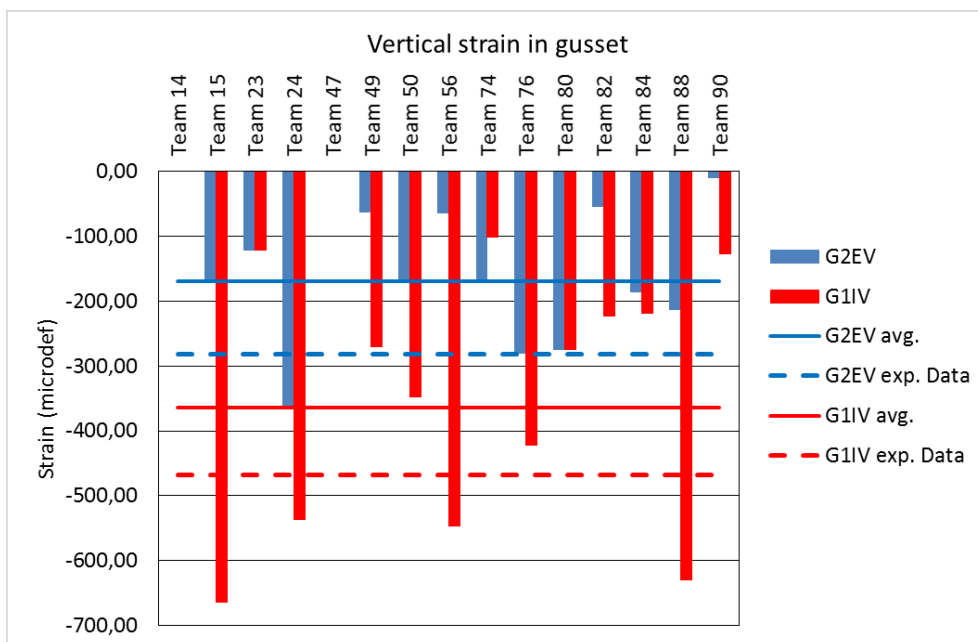

Figure 17 - Vertical ageing strains in the gusset

The horizontal strains in the gusset are presented in Figure 18. Similar conclusions can be drawn, except regarding bending effects that do not seem to occur anymore in the tangential direction. Teams 15, 56 and 80 perform well for these sensors.

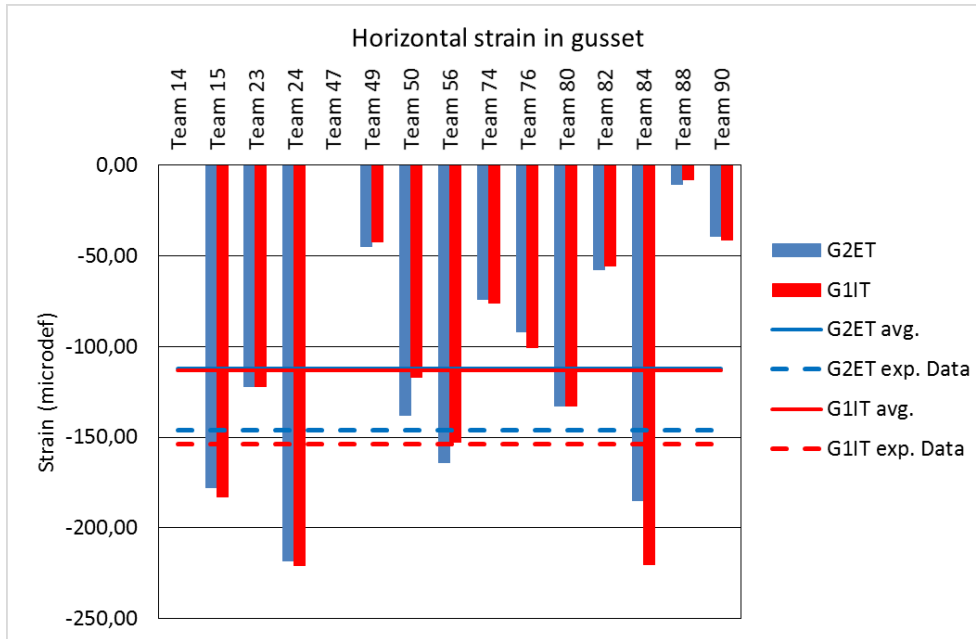

Figure 18 - Horizontal ageing strains in the gusset

## 5.2 STRAINS DURING THE VD2 PRESSURE TEST

The participants had to reproduce the strain induced by the pressure test itself, with a 4.2 bars relative pressure applied inside the containment, by means of an air compressor. First, results for the cylinder part of the mock-up are shown. As it can be seen in Figure 19, strains due to pressurization process is well reproduced by the participants. Teams 14, 24, 49, 50, 56, 74, 76, 80 obtain relatively more accurate results compared to experimental observations. For the other teams, the global stiffness of the mock-up or the effective stress level in concrete seem to have been misestimated.

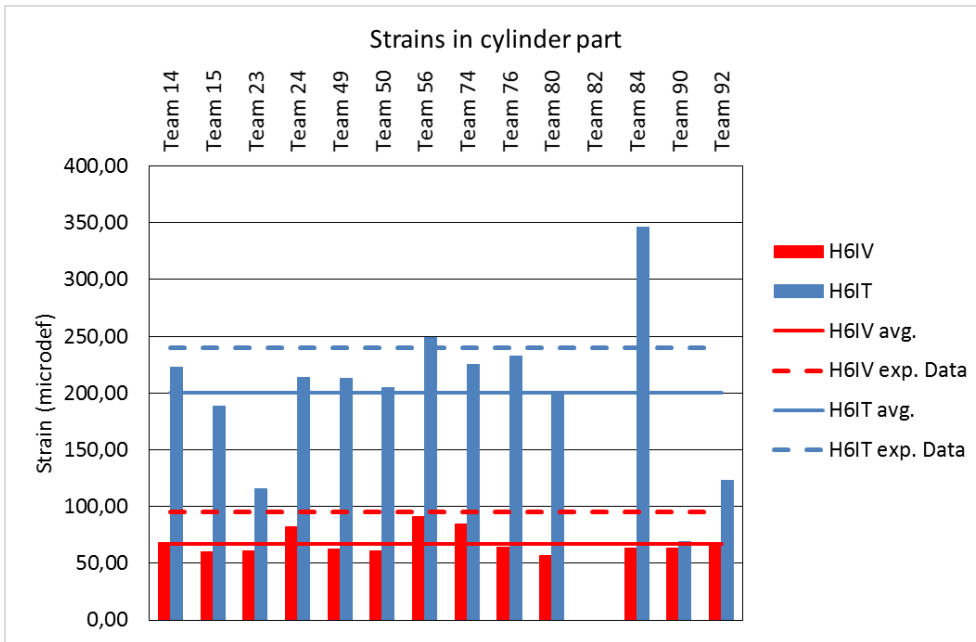

Figure 19 - Vertical and horizontal strains in the cylinder part at VD2 due to pressurization

In the gusset area, the results are more scattered. The strains obtained in this area are more sensitive to mechanical boundary conditions used under the raft. As it can be seen in Figure 20, not many teams correctly catch the bending effect occurring during the pressure test. Indeed, experimental results show a slight contraction of the outer face of the gusset in the vertical direction. It is important to notice that teams 23, 49, 92 are the closest to catch this effect.

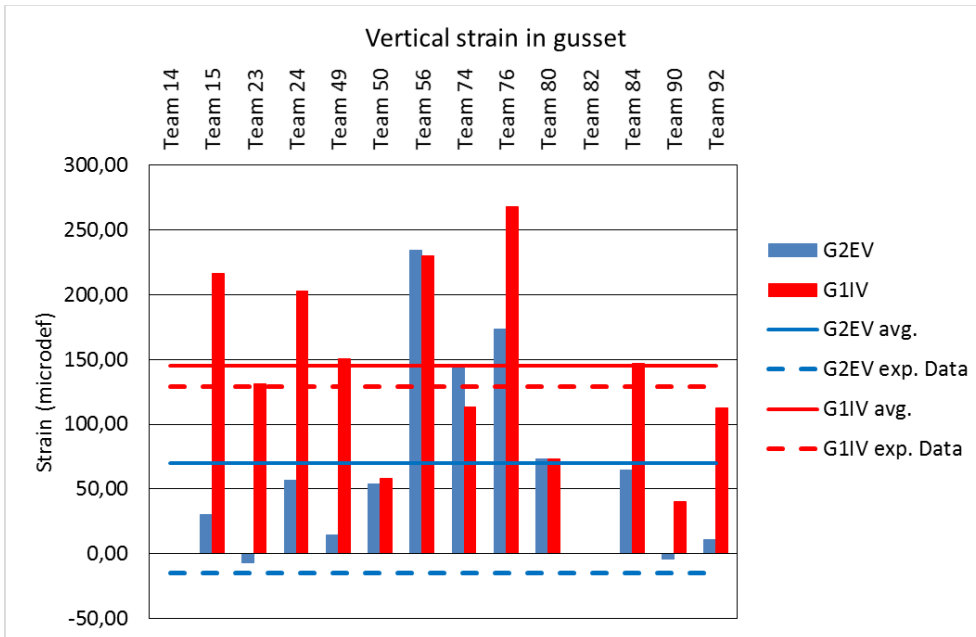

Figure 20 - Vertical strains in the gusset at VD2 due to pressurization

Regarding the horizontal strains in the gusset (Figure 21), experimental results show much lower strains than reported by most of the teams. Only teams 50 and 90 catch this effect. This might be explained by several reasons, mostly the raft stiffness to the gusset strains.

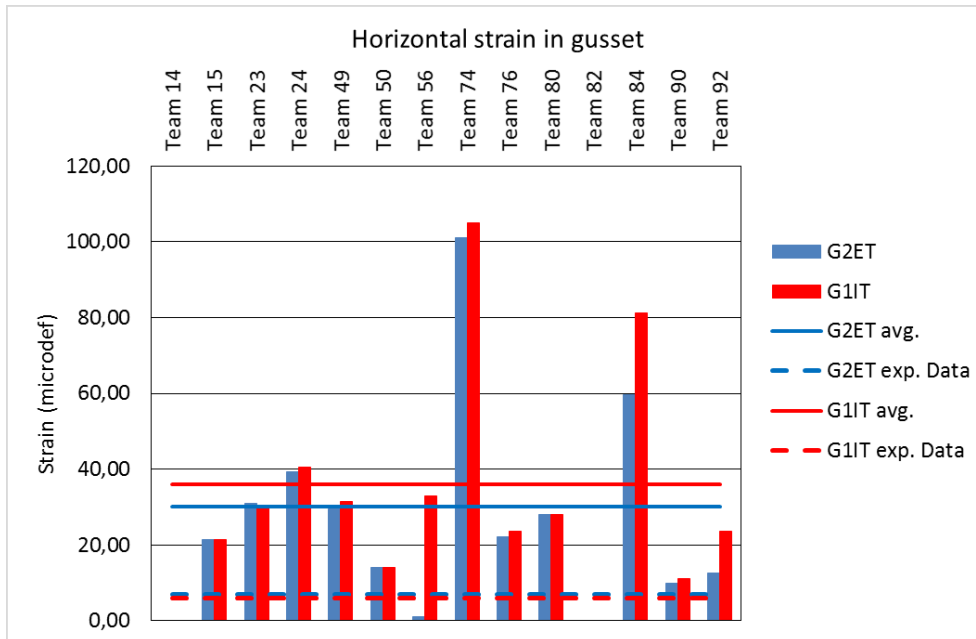

Figure 21 - Horizontal strains in the gusset at VD2 due to pressurization

## 6 BENCHMARK RESULTS: AIR LEAKAGE

VERCORS mock-up has undergone several pressure tests between November 2015 which was the first one and March 2018 which was the fifth (VD2). The global air leakage has been measured at the end of the 4.2 relative bars plateau of each of these pressure tests. During the pressure test, at the 4.2 relative bars plateau, the containment wall was sprayed with soapy water in order to locate leakage and then to quantify the flow through these defects using specific local flow measurement devices. The theme 3 of the benchmark consisted of the prediction of air leakage during the pressure test, at the end of the plateau.

The air leakage flow is expressed in  $\text{Nm}^3/\text{h}$  (Normo  $\text{m}^3$  per hour). The so-called “Normo” volume of a gas (expressed in  $\text{Nm}^3$ ) is the volume it occupies in standard conditions for temperature and pressure:  $T_N = 273.15 \text{ K}$  and  $P_N = 1013.25 \text{ hPa}$ .

The methods used by the different participants to predict air leakage were quite diverse. In most cases, an estimate of cracks location, number and opening was obtained from the mechanical calculation (either using damage models or by post processing results from a linear analysis). Then, the air flow through the cracks was estimated using a more or less refined models.

Even though air leakage data from VD1 bis was available, most teams did not calibrate their model to exactly reproduce the results, so most teams do not reproduce correctly VD2 leakage (see Figure 22). The models were used in a predictive way for VD2. All participants predicted an increase of leakage compared to the previous ILRT, but generally this increase was lower than experimentally observed. Global air leakage was underestimated by all teams except by Team 50 which gave the most accurate prediction.

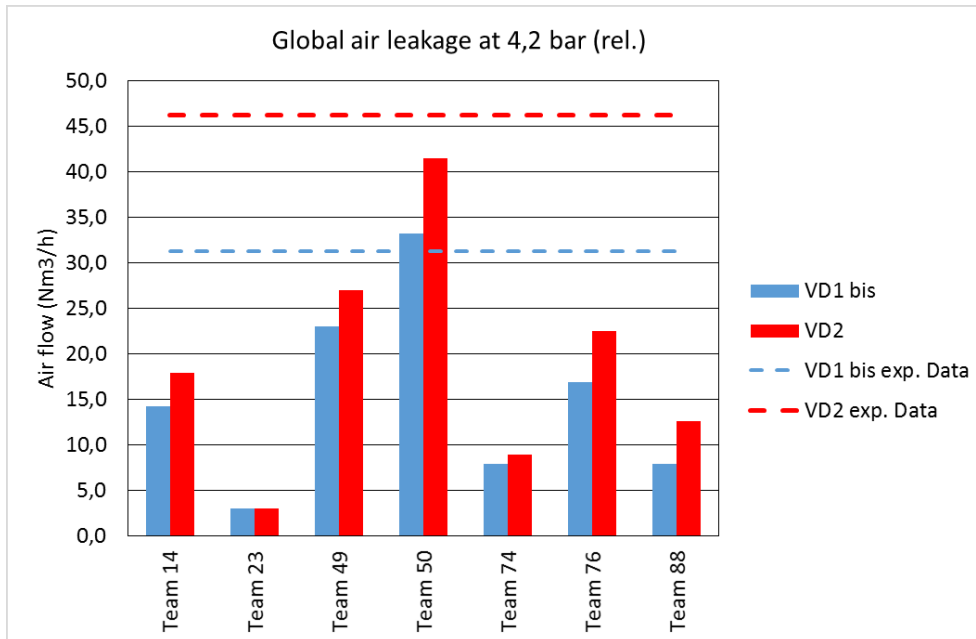

Figure 22 - Global air leakage at 4.2 bar (rel.) - Evolution over experimental program

There is a factor about 14 between the highest and the lowest prediction of global air leakage. In the previous benchmark in 2015, the factor was about 200. The mean deviation from the experimental values is 55 %. Considering the complexity of the models combining hydro-mechanical phenomena and specific leak calculation laws, this is considered as a satisfactory result.

Participants were also asked to predict the location of leakage but the results obtained by most of the teams were very different from the experimental measurements, it was decided for the sake of simplification not to show those results. Most of the teams estimated a large leakage in the cylindrical part of the mock-up, while experimental data show that the largest leakage, stemming from leakage through cracks, occurred in the gusset area. These differences between local leakage predictions and measurements can also probably explain discrepancies on the global predictions.

## 7 CONCLUSION

For this second benchmark, three main themes were proposed:

- theme 1: Creep modelling - Micromechanics and/or Multiphysics approaches;
- theme 2: Mechanical behaviour of the containment during pressure test;
- theme 3: Air leakage.

Regarding the participation, the number of teams for this 2<sup>nd</sup> Benchmark is 18 teams coming from 9 different countries. This shows a strong interest of the scientific community for advanced modelling in civil engineering, especially regarding leak assessment issues. Compared to the previous benchmark in 2015, it is 4 extra teams, and from the total of 18 teams it should be mentioned that 7 teams are new and coming from China, Korea, Canada, Spain, Finland and France.

Following the presentation of the results one can note, like in the previous benchmark, the good quality of the work done by the participants.

About modelling the containment behaviour and the effects of ageing (theme 2), the results provided are numerous as these calculations are indeed more common in the profession.

Some have obtained results very similar to experimental measurements, showing a good understanding of the behaviour of the structure. Nevertheless, there are sometimes significant differences both between the participants and compared with experimental measurements. This could be explained by the fact the effect of thermal creep is not taken into account in some numerical models. A new research program on this topic is proposed in this topic in framework of the Euratom project (WP4 of ACES project).

The gusset area in particular remains complex to model and its behaviour is poorly captured by simulations. Some interesting approaches have been developed since the benchmark took place (i.e. [34]) but there is still room for improvement. But looking at the deviation of the results given in 2015 and in 2018 per zone of the containment (see Figure 23 - Values dispersion per zone of the containment - evolution between 2015 (blue) and 2018 (green to red)), even if the gusset is an area where results should be improved in the future, it can be noted that the deviation has strongly decreased in this area like in other all areas of the containment.

One can also note that the results for cracks predictions deviate a lot from experimental results. Specifically, one can notice - like in the first benchmark - that ignoring the effects associated to early age is a gap in forecasting the state of active cracking during pressurization, particularly in the gusset area.

Finally, regarding the prediction of the leakage flow, even if it is still a difficult exercise, some improvements have been noticed. In 2015, the results showed a factor of 1 to 200 between the lowest and the highest flow. For this second benchmark, the factor has decreased at 1 to 14. On average the global leakage predicted values were 30 times higher than the experimental in 2015.

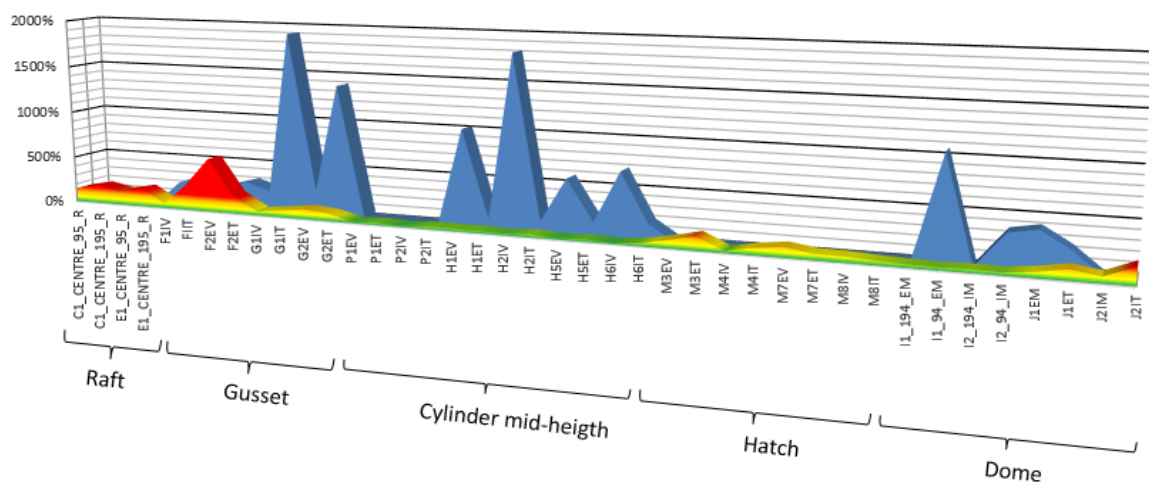

Figure 23 - Values dispersion per zone of the containment - evolution between 2015 (blue) and 2018 (green to red)

In 2018, the average value underestimates the experimental value of 55 %. In addition, we can note that one team predicted the experimental value with a gap equal to 8 %.

Global air flow leakage prediction seems better assessed for the 2<sup>nd</sup> Benchmark in comparison with the 1<sup>st</sup> Benchmark, even for new participants.

However, it appears clearly that the determination of the cracking state is a major element to forecast leakage since the leakage through cracks is predominant. Thus, it is necessary to make additional effort on modelling both cracks apparition and air flow through cracks to get air leakage predictions more accurate for an industrial use.

In the near future, a third benchmark will be organized in the framework of the Euratom project called ACES.

## 8 PERSPECTIVES FOR THE FUTURE

---

Experiences from the previous benchmarks have proven to be helpful for EDF in its mission to improve in the safety assessment of the reactor building. EDF and the scientific community improve themselves in their capacity of prediction by mastering the use of virtual tools (softwares), which are themselves challenged by various data coming from all sorts of instrumentation.

Some lessons learned may be drawn from this second benchmark.

- The quantity and type of data given to the public should be firstly discuss with the receiver (public) in order to improve his predictions.
- The more accurate and easily intelligible the monitoring data is, the more relevant the results will be.
- Time given to perform the simulation has of course a significant impact on the quality of the results, EDF will be giving full year to perform the calculations for the next benchmark.
- Recent progress and use of “new” instrumentation has appeared along the years such as acoustic sensors which gives indirect information that may lead to promising solution to detect where the cracks are and how much they leak, however only few master this technology.
- Optic fibers used in nuclear reactor building is also a “new” sort of instrumentation which gives very dense and rich information however still hard to master without some preliminary precautions.
- During this benchmark no data was available regarding the water content evolution of the concrete as it was still not readily available at the time of the benchmark. Water content is known to be a key parameter.
- Further development and research should be done on the prediction of the localization of the effects (cracks and leaks).

### **Acknowledgements**

EDF thanks all participants for their scientific inputs to the VERCORS project and their participation to the restitution workshop held in Saclay, France, in 2018. EDF also thanks OECD for their support and endorsement of the benchmark. Finally, EDF also thanks the scientific committee.

## REFERENCES

---

- [1] J.-P. Mathieu, L. Charpin, P. Sémété, C. Toulemonde, G. Boulant, J. Haelewyn, F. Hamon, S. Michel-Ponnelle, J.-M. Hénault and F. Taillade, "Temperature and humidity-driven ageing of the VeRCoRs mock-up," in *Euro-C*, Austria, 2018.
- [2] J. Mazars, P. Labbé and B. Masson, "Behavior and assessment of massive structures: an overview of the French research programs CEOS.fr and VERCORS," in *Proceeding of the 9th International Conference on Fracture Mechanics of Concrete and Concrete Structures (FraMCoS-9)*, 2016.
- [3] J. Niepceron, M. Corbin and Masson, "VERCORS ; What is going on ? What will go on ?," in *Transactions, SMiRT-25*, Charlotte, NC, USA, 2019.
- [4] J. Picaut, Bulletin 13, Nuclear Containments, FIB, 2001.
- [5] EDF, "Code\_Aster," [Online]. Available: [www.code-aster.org](http://www.code-aster.org).
- [6] Z. P. Bazant and J. Planas, *Fracture and Size Effect in Concrete and Other Quasi-Brittle Materials*, 1998.
- [7] ANR, "MACENA," [Online]. Available: [www.agence-nationale-recherche.fr/ProjetIA-11-RSNR-0012](http://www.agence-nationale-recherche.fr/ProjetIA-11-RSNR-0012).
- [8] ANR, "ENDE," [Online]. Available: <https://anr.fr/ProjetIA-11-RSNR-0009>.
- [9] COST, "COST action TU1404," [Online]. Available: [www.tu1404.eu](http://www.tu1404.eu).
- [10] M. :. G. M. Corbin, "International benchmark VERCORS 2015 - overview, synthesis and lessons learned," EDF SEPTEN, 2016.
- [11] B. Masson and M. Corbin, "VERCORS mock-up first experimental results and synthesis of the benchmark," in *Service Life of Cement-Based Materials and Structures*, Lyngby, Denmark, 2016.
- [12] M. Corbin, "International benchmark VERCORS 2018 - Overview, synthesis and lessons learnt," EDF, 2018.
- [13] J. Niepceron, M. Corbin and B. Masson, "Appraisal of the VERCORS 2018 benchmark," in *Transactions, SMiRT-25*, Charlotte, NC, USA, 2019.
- [14] M. Irfan-ul-Hassan, B. Pichler, R. Reihnsner and C. Hellmich, "Elastic and creep properties of young cement paste, as determined from hourly repeated minute-long quasi-static tests," *Cement and Concrete Research*, vol. 82, pp. 36-49, 2016.
- [15] M. Corbin, "International benchmark VERCORS 2018 - Benchmark workshop - Modeling the behaviour of the VERCORS mock-up - Program&abstracts," 2018.
- [16] T. Thénint, V. Le Corvec, P. Dec and S. Ghavamian, "Evaluation of aging structural response and leakage rate of VERCORS mock-up," in *Transactions, SMiRT-24*, BEXCO, Busan, Korea, 2017.



- [17] T. Thénint, V. Le Corvec and S. Ghavamian, "Study of the containment history of the VERCORS mock-up and prediction of the leakage rate under pressurization tests," in *FraMCoS-X*, Bayonne, France, 2019.
- [18] FIB, *Fib Bulletin 65: Model Code 2010, Volume 1*, 2012.
- [19] J.-M. :. A. A. Torrenti, "Modelling of the long term behaviour of the prestressed containment of nuclear power plants," in *FIB Congress*, Melbourne, Australia, 2018.
- [20] M. Ahs, R. Malm and C. Bernstone, "Modelling creep in concrete cylinders subjected to different relative humidity levels—the VeRCoRs 2018 benchmark," Lund University, Lund, 2018.
- [21] D. E. M. Bouhjiti, M. Boucher, M. Briffaut, F. Dufour, J. Baroth and B. Masson, "Accounting for realistic Thermo-Hydro-Mechanical boundary conditions whilst modeling the ageing of concrete in nuclear containment buildings: Model validation and sensitivity analysis," *Engineering Structures*, vol. 166, 2018.
- [22] D. E. M. Bouhjiti, J. Baroth, M. Briffaut, F. Dufour and B. Masson, "Statistical modeling of cracking in large concrete structures under Thermo-Hydro-Mechanical loads: Application to Nuclear Containment Buildings. Part 1: Random field effects (reference analysis)," *Nuclear Engineering and design*, pp. 196-223.
- [23] D. E. M. Bouhjiti, M. Ezzedine El Dandachy, F. Dufour, S. Dal Pont, M. Briffaut, J. Baroth and B. Masson, "New continuous strain-based description of concrete's damage-permeability coupling," *International Journal for Numerical and Analytical Methods in Geomechanics*, pp. 1671-1697, 2018.
- [24] P. r. group, "PLCd: Non-linear thermo-mechanic finite element code for research-oriented applications. Free access code developed at CIMNE.," 1991-to present. [Online]. Available: <https://www.cimne.com/PLCd>.
- [25] L. Barbu, A. Cornejo, X. Martínez, S. Oller and A. Barbat, "Methodology for the analysis of post-tensioned structures using a constitutive serial-parallel rule of mixtures: Large scale non-linear analysis," *Composite Structures*, no. 216, pp. 315-330, 2019.
- [26] L. B. C. E. X. M. S. O. A. B. Cornejo, "Methodology for the analysis of post-tensioned structures using a constitutive serial-parallel rule of mixtures," *Composite Structures*, vol. 200, pp. 480-497, 2018.
- [27] S. Oller, *Nonlinear dynamics of structures*, 2014.
- [28] S. Jimenez, A. Cornejo, L. Barbu, S. Oller and A. Barbat, "Analysis of the mock-up of a reactor containment building: Comparison with experimental results," *Nuclear Engineering and Design*, vol. 359, 2020.
- [29] K. Calonius, "Simulation of VERCORS Reactor Containment," in *1st International Conference on Nuclear Power Plants; Structures, Risk & Decommissioning*, London, United Kingdom, 2017.
- [30] K. Calonius, "VeRCoRs experience: predicting containment ageing, from the mockup to the digital twin. Modeling strategies: Airtightness and structural behavior," in *Transactions, SMiRT-*

25, Charlotte, NC, USA, August 4-9, 2019.

- [31] T. Helfer, "MFront website: A code generation tool dedicated to material knowledge," [Online]. Available: <http://tfel.sourceforge.net>.
- [32] M. Asali, B. Capra, J. Mazars and J.-B. Colliat, "Numerical strategy for forecasting the leakage rate of inner containments in double-wall nuclear reactor buildings," *Journal of advanced concrete technology*, vol. 14, 2016.
- [33] J.-M. Torrenti, F. Benboudjema, F. Barré and E. Gallitre, "On the very long term delayed behaviour of concrete," in *Proceedings of the Intern. Conference on Ageing of Materials & Structures*, Delft 26 – 28 May 2014, The Netherlands, 2014.
- [34] J. Mazars, S. Grange and M. Briffaut, "Cracking of reinforced concrete structures: A simplified approach for the gusset of the Vercors mock-up at early age," in *Proceedings of FRAMCOS-X*, Bayonne, France, 2019.
- [35] L. Granger, *Comportement différé du béton dans les enceintes de centrales nucléaires : analyse et modélisation*, Ecole Nationale des ponts et Chaussées, 1996.
- [36] L. Granger, J.-M. Torrenti and P. Acker, "Thoughts about drying shrinkage: scale effect and modelling," *Materials and Structures*, vol. 30, pp. 96-105, 1997.