



HAL
open science

Comparison Analysis of Control Structures For Variable Speed Wind Turbine

S El Aimani, Bruno Francois, F Minne, B Robyns

► **To cite this version:**

S El Aimani, Bruno Francois, F Minne, B Robyns. Comparison Analysis of Control Structures For Variable Speed Wind Turbine. Computational Engineering in Systems Applications (CESA 2003), Jul 2003, Lille, France. hal-03706296

HAL Id: hal-03706296

<https://hal.science/hal-03706296>

Submitted on 27 Jun 2022

HAL is a multi-disciplinary open access archive for the deposit and dissemination of scientific research documents, whether they are published or not. The documents may come from teaching and research institutions in France or abroad, or from public or private research centers.

L'archive ouverte pluridisciplinaire **HAL**, est destinée au dépôt et à la diffusion de documents scientifiques de niveau recherche, publiés ou non, émanant des établissements d'enseignement et de recherche français ou étrangers, des laboratoires publics ou privés.

Comparison Analysis of Control Structures For Variable Speed Wind Turbine

S. El Aimani*, B. Francois*, F. Minne**, B. Robyns***

C.N.R.T. Réseaux et machines électriques du futur, Lille

* L2EP - Ecole Centrale de Lille, Cité Scientifique, BP48, 59651 Villeneuve d'Ascq Cedex, France, Phone: 33-3-20-33-54-59, tel: 33-3-20-33-54-59, e-mail : salma.el_aimani@ec-lille.fr, bruno.francois@ec-lille.fr

** Laborelec, Belgique, Frank.minne@laborelec.com

*** L2EP - HEI, 13, rue de Toul, F-59046 Lille Cedex, France, e-mail : benoit.robyns@hei.fr

Abstract - Due to the increasing number of wind power plants all over the world, many studies have been carried out to assess the interaction of such plants with the distribution grid. In this context, this paper presents investigations in the design of wind turbine control systems to maximize the energy capture and their impact onto the grid. The modeling of the wind turbine is presented. Then three different speed control systems are detailed and evaluated through simulations carried out with Matlab Simulink™. Power fluctuations on the distribution grid are then compared by considering the same wind speed fluctuations.

I. INTRODUCTION

The connection of wind turbines to the electrical distribution grid can induce some power quality problems that may affect users connected onto this grid. The stochastic nature of the wind speed variation leads to voltage and power fluctuations produced by wind turbines, which may cause flicker. The influence of wind power generation on grid power quality will depend on the type of wind turbines installed, the generation level and the characteristics of the grid at the point of common coupling. Flicker produced by power fluctuations and influence of wind turbines on the power quality remains the strongest barrier to the development of wind power generators in the distribution electrical grid (see as example the certification by the International Electrotechnical Commission: 61400-21 standard "Measurement and assessment of power quality of grid connected wind turbines"). In results direct connected wind turbines (fig. 1) represents actually no more than 15% of the electricity consumed in countries which have first oriented their energy policies to the development of wind power generators (Netherlands, ...) [NWCC 01]. Since the last decade new technologies have been introduced in wind power generation systems in order to regulate the power transfers (fig. 2). The main idea is to make the turbine speed variable (and then the wind/electricity conversion) by using power electronic converters and an intermediary dc bus [BAU 02]. However constraints remain and the transferred power is

still limited by the capacitor value and the rated voltage of the dc bus [ELA 02].

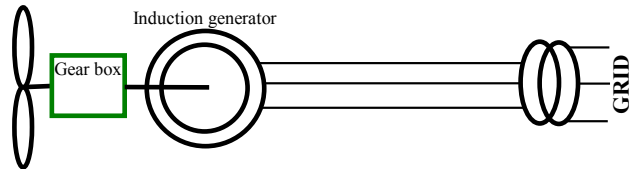

Fig. 1. Example of direct connected wind generators

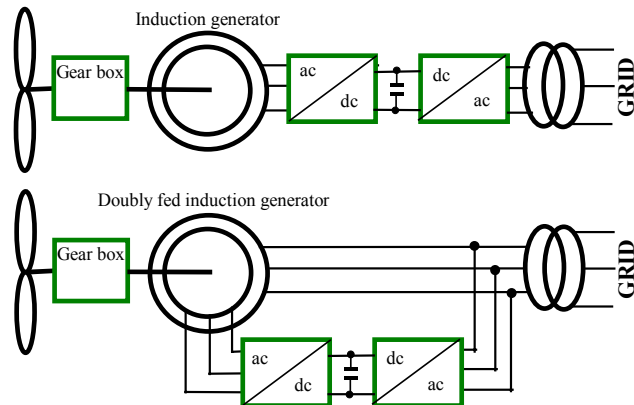

Fig. 2. Example of variable speed wind generators

The purpose of this paper is to present various wind turbine control systems for different objectives as maximum wind power tracking and constant electrical power generation. The first part of this paper presents the wind turbine model, which has been designed to simulate the dynamics of the system from the turbine rotor where the kinetic wind energy is converted to the mechanical energy. Then the principle of the variable speed control is recalled, different control systems are described and compared with the help of simulations.

II. Wind turbine modeling

A. Wind turbine modeling

The studied horizontal wind power generation system is shown on fig. 3. The power of wind is proportional with the cube of the wind speed:

$$P_{wind} = \frac{\rho}{2} A v^3 \quad (1)$$

where ρ is the air density (approx. 1.22 kg/m^3 in standard atmosphere at 15°C), A is the swept area of the turbine and v is the wind speed. The power coefficient (C_p) represents the aerodynamic efficiency of the wind turbine. It depends on the tip speed ratio (λ) and the blade pitch angle (β).

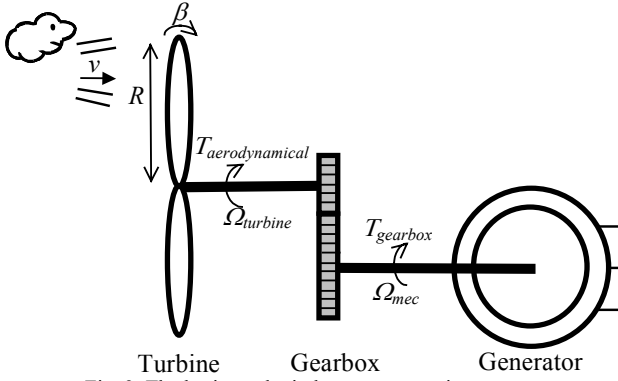

Fig. 3. The horizontal wind power generation system

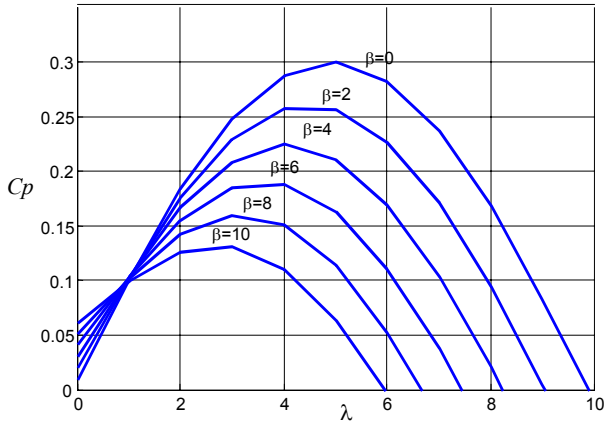

Fig. 4. Power aerodynamic efficiency versus tip speed ratio For a three bladed turbine

For the wind turbine used in the study, the following form has been derived from [EZZ 00]:

$$C_p(\lambda, \beta) = (0.3 - 0.00167 \cdot \beta) \sin \left[\frac{\pi \cdot (\lambda + 0.1)}{10 - 0.3 \cdot \beta} \right] - 0.00184 \cdot (\lambda - 3) \cdot \beta \quad (2)$$

The tip speed ratio is defined as the ratio between the blade tip speed and the wind speed:

$$\lambda = \frac{R \cdot \Omega_{turbine}}{v} \quad (3)$$

R is the blade radius and $\Omega_{turbine}$ is the angular speed of the turbine. The characteristic of the power aerodynamic efficiency is shown on fig. 4.

Using C_p , the aerodynamic power $P_{aerodynamical}$ is determined by:

$$P_{aerodynamical} = C_p \cdot P_{wind} = C_p \cdot \frac{\rho}{2} \cdot A \cdot v^3 \quad (4)$$

The aerodynamic torque $T_{aerodynamic}$ is determined directly according to

$$T_{aerodynamical} = C_p \cdot \frac{\rho}{2} \cdot A \cdot v^3 \cdot \frac{1}{\Omega_{turbine}} \quad (5)$$

B. Gearbox modelling

The gearbox has the task to transfer the aerodynamical power from the slow rotating rotor shaft to the fast rotating shaft, which drives the generator at the mechanical speed Ω_{mec} (fig.3). It is mathematically described by the following equations:

$$T_{gearbox} = \frac{T_{aerodynamical}}{G} \quad (6)$$

$$\Omega_{turbine} = \frac{\Omega_{mec}}{G} \quad (7)$$

G is the gear ratio.

C. Drive train modelling

The drive train is composed of the mass corresponding to the large turbine rotor inertia representing the blades and the hub, and a small inertia representing the rotor mass of the generator. The proposed model only includes the turbine rotor because this part of the wind turbine has the most significant influence on the power fluctuations. The acceleration is governed by the following equation:

$$J \cdot \frac{d\Omega_{mec}}{dt} = T_{mechanical} \quad (8)$$

The total inertia (J), which appears onto the generator rotor, represents the acceleration time constant. Taking into account the electromagnetic torque (T_{em}) and the viscous torque ($T_{viscous}$), the torque balance yields:

$$T_{mechanical} = T_{gearbox} - T_{em} - T_{viscous} \quad (9)$$

The flexibility of the shaft is modeled as a stiffness (f):

$$T_{viscous} = f \cdot \Omega_{mec} \quad (10)$$

D. Overall system modelling

A representation of the overall system is shown on fig. 5 following a Causal Ordered Graph. All used mathematical equations are represented as balloons containing their reference number and are ordered in a causal way. The wind turbine model output is the aerodynamic torque applied on the gearbox. The inputs of the wind turbine model are the wind speed, the pitch angle and the turbine rotor speed. The gearbox model transforms the mechanical speed and the aerodynamical torque respectively into the turbine rotor speed and the gearbox torque. The drive train model output is the mechanical speed and it has two inputs: the gearbox torque and the electromechanical torque provided by the generator. Fig.6 shows the corresponding block diagram, which has been simulated under the Matlab Simulink™ software.

III. WHY VARIABLE SPEED TURBINE CONTROL?

The stored power (in the inertia) is expressed as the product:

$$P_{kinetic} = T_{mechanical} \cdot \Omega_{mec} \quad (11)$$

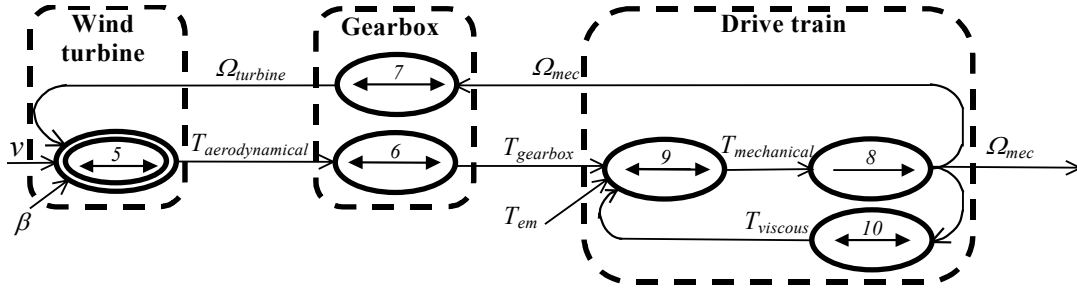

Fig. 5. Causal Ordered Graph of the wind turbine model

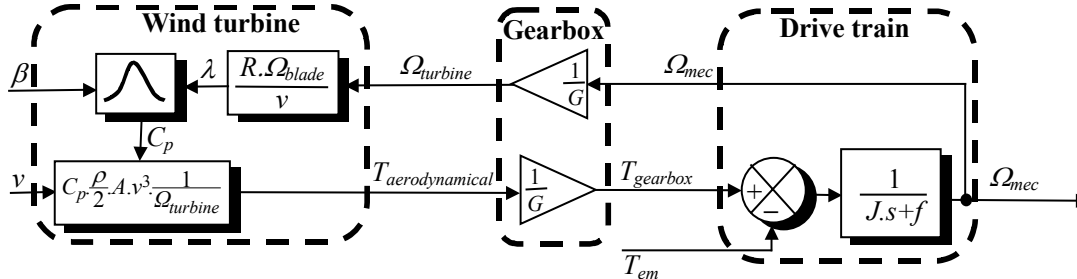

Fig. 6. Block diagram of the wind turbine model

At constant speed operating, the mechanical torque is null and then the aero dynamical power minus the loss power is converted into electrical power as (fig.7):

$$P_{electrical} = P_{aerodynamical} - P_{loss} \quad (12)$$

$$P_{loss} = T_{viscous} \cdot \Omega_{mec} \quad (13)$$

The electrical power vs. speed curves of a typical wind turbine is given by the curves in fig. 8.

For example if the wind velocity is v_1 the output power can be raised to the maximum value at point A by setting the mechanical speed to Ω_1 . If the wind speed changes to v_2 the power output jumps to point B. For this wind velocity the maximum power can be extracted by raising the speed to Ω_2 . This shows that, as the wind speed changes, the generator speed should track these changes in order to extract the maximum power.

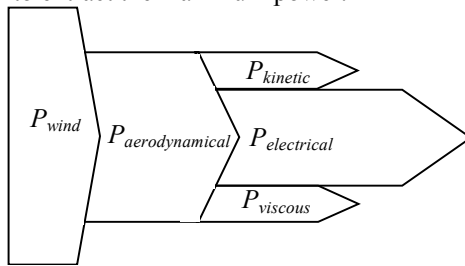

Fig. 7. Conversion transfer of the power

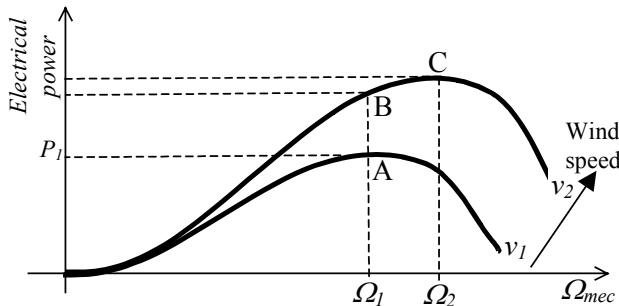

Fig. 8. Turbine Power vs. Speed

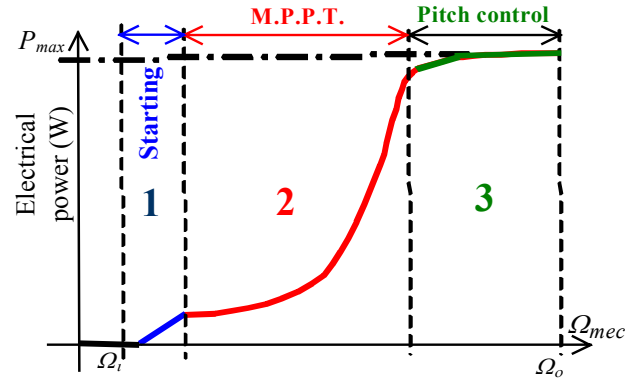

Fig. 9. Electrical power vs. generator rotor speed

Figure 6 shows that the turbine speed can be controlled by acting on two inputs: the blade pitch angle and the electromagnetic torque of the generator. The wind speed must be considered as a perturbation input for the system. In next sections we present various control strategies in order to maximise the electrical power known as Maximum Power Point Tracking (M.P.P.T.). These techniques consist in adjusting the electromagnetic torque of the generator in order to control the speed to the reference value (Ω_{ref}). Other torques, which are applied to the shaft, are then considered as perturbation inputs. For this operation the maximum power must be converted and so the angle (β) is zero. As the power must not exceed the rated generator power a pitch actuator is used to shed the aerodynamic power. For this operation, the angle is therefore increased. The wished characteristic of electrical power versus the generator rotor speed is represented in fig. 9. Whatever the used electrical generator, the obtained electromechanical torque is assumed to be equal to the reference value:

$$T_{em} = T_{em_ref}$$

IV. Direct control of the wind turbine speed

A Principle

Most of variable speed turbines are controlled by a direct control system, which is now detailed [MUL 01]. In a first step one can neglect the effect of the viscous torque. Moreover, around an operating point, the generator rotor speed varies slowly. Then the dynamic equations (4) and (5) yield:

$$T_{gearbox} = T_{em} \quad (14)$$

From this equation we can deduce a first control system function to set the reference value of the electromagnetic torque:

$$T_{em_reg} = T_{gearbox_estimated} = \frac{T_{aerodynamical_estimated}}{G} \quad (C1)$$

The aerodynamical torque can be estimated with a wind speed estimation and the measurement of the generator rotor speed:

$$T_{aerodynamical_estimated} = C_p \cdot \frac{\rho}{2} \cdot A \cdot v_{estimated}^3 \cdot \frac{G}{\Omega_{mec}} \quad (C2)$$

To get the maximum of the extracted power from the wind we must set the particular tip speed ratio (λ_{Cp_max}), which corresponds, to $C_p = C_{p_max}$ (fig.10):

$$T_{aerodynamical_estimated} = C_{p_max} \cdot \frac{\rho}{2} \cdot A \cdot v_{estimated}^3 \cdot \frac{G}{\Omega_{mec}} \quad (15)$$

Thus we can deduce an estimation of the wind speed by measuring the mechanical speed and using the expression of the tip speed ratio [THI 93]:

$$v_{estimated} = \frac{R \cdot \Omega_{turbine}}{\lambda} = \frac{R}{\lambda_{Cp_max}} \cdot \frac{\Omega_{mec}}{G} \quad (C3)$$

The obtained control architecture is represented in fig. 11. For the practical implementation, the reference of the electromagnetic torque is:

$$T_{em_reg} = k \cdot \Omega_{mec}^2 \quad (16)$$

with
$$k = \frac{C_{p_max}}{\lambda_{Cp_max}^3} \cdot \frac{\rho}{2} \cdot \pi \cdot \frac{R^5}{G^3}$$

B Simulation results

An averaged 12.5 m/s wind speed has been used for the simulations (fig. 12.a) with $\theta=0^\circ$. We show that the power coefficient is forced at the maximum value (fig. 12.b); in consequence the rotor generator speed is adapted to wind speed variations (fig.12.c). The produced electrical power has large fluctuations (fig. 12.d). These ones have to be compensated by using the intermediary capacitor storage of dc bus (fig. 2) or any additional storage devices.

An additional noise (see fig. 13.a) has been considered for the generator speed measurement. This causes fluctuations onto the electrical power (fig. 13.b) and shows the filtering requirements for this speed measurement.

We can observe that the dynamic of the power coefficient is low at the starting (fig. 12.b). By consequence the corresponding speed will not induce a maximum power extraction. The converted electrical power may be optimised by using particular fuzzy logic search algorithms based on small variations of the parameters λ_{Cp_max} [SIM 97]. Anyway with these techniques the electrical power cannot be optimised during large transients of the wind speed and two closed loop control systems are now proposed for this purpose.

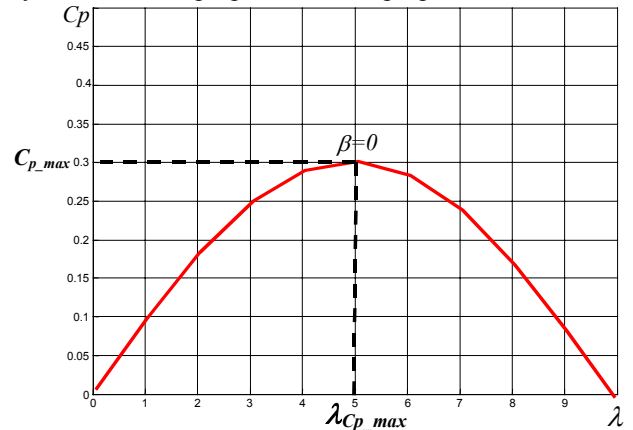

Fig. 10. Power aerodynamic efficiency versus tip speed ratio

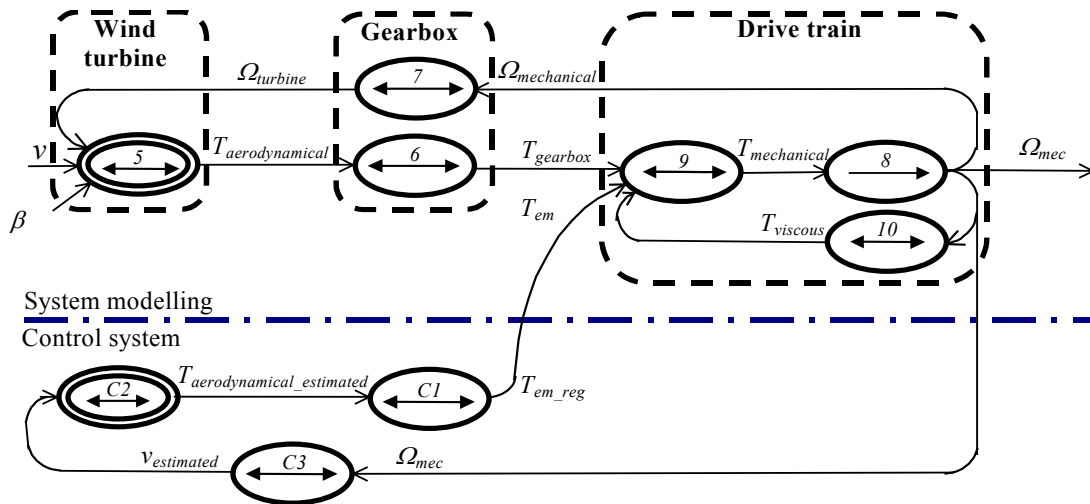

Fig. 11. Direct control of the wind turbine speed

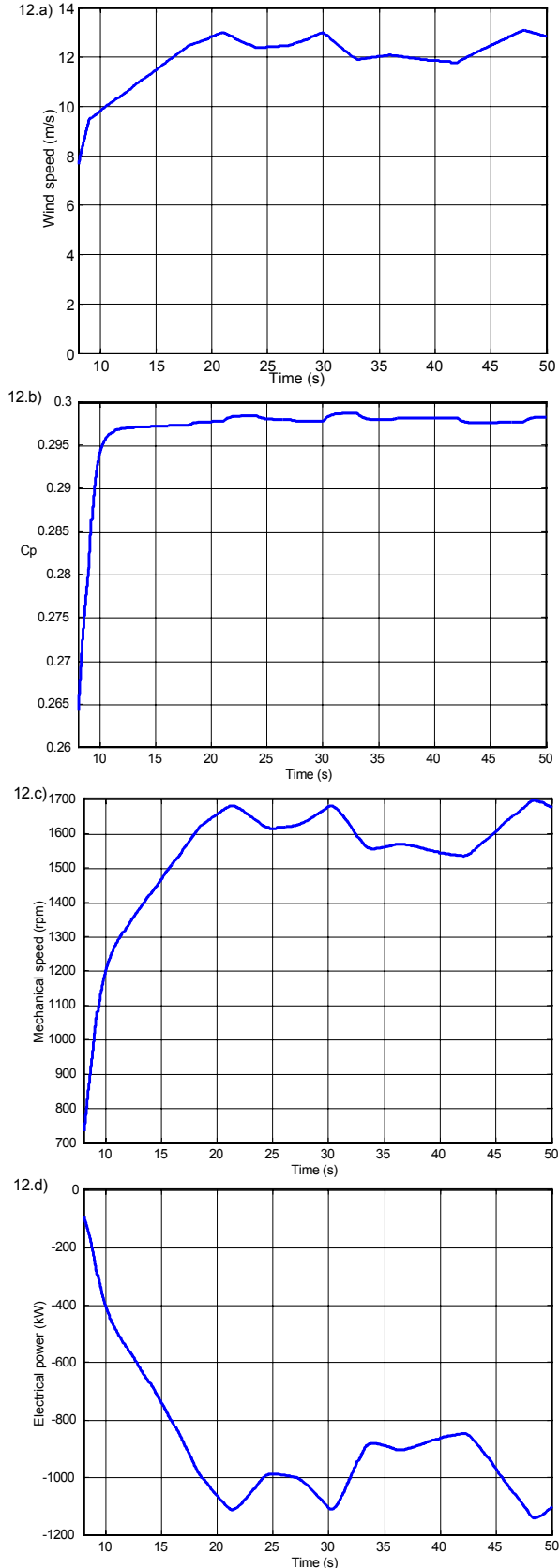

Fig. 12. Obtained results with a direct control

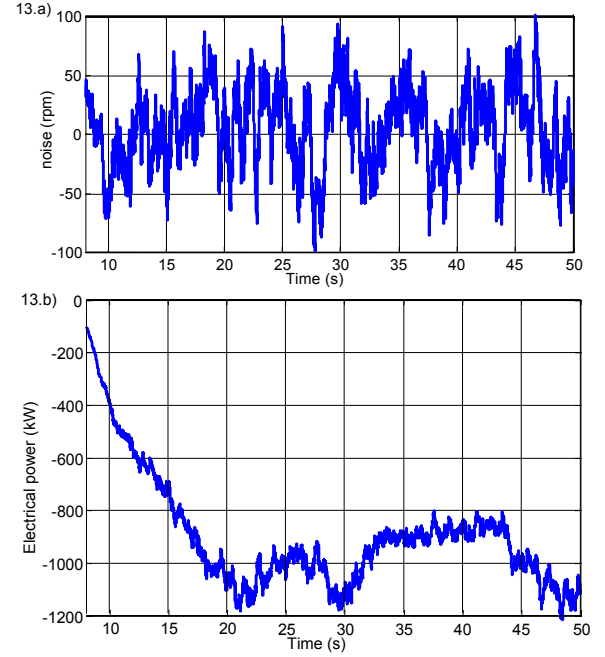

Fig. 13: Direct control with speed noise

V. Closed loop control of the wind turbine speed

A Principle

The speed is measured and compared with a reference value, and then a corrector adjusts the reference torque in order to reduce this error (fig. 14).

$$T_{em_ref} = C_{ass} (\Omega_{mec_ref} - \Omega_{mec}) \quad (Cass)$$

The speed controller has to achieve two tasks:

- It must set the mechanical speed to its reference value.
- It must damp the action of the wind torque, which represents a perturbation.

To obtain an optimal tip speed ratio, the speed reference value is calculated with the knowledge of the wind speed:

$$\Omega_{mec_ref} = \lambda_{C_{p_max}} \frac{G}{R} v \quad (C4)$$

B. Phase delay controller

The first considered speed controller is a phase delay controller (fig. 15):

$$T_{em_ref} = \frac{a_1 s + a_0}{\tau s + 1} (\Omega_{mec_ref} - \Omega_{mec}) \quad (17)$$

a_0 , a_1 and τ are parameters, which have to be determined, and s is the Laplace quantity.

If the electrical machine is suitable controlled then the rotor speed is dependent on the speed reference through the transfer function ($F(s)$) and the gear box torque via a perturbation transfer function ($P(s)$):

$$\Omega_{mec} = F(s) \cdot \Omega_{mec_ref} + P(s) \cdot T_{gearbox} \quad (18)$$

$$\text{with } P(s) = \frac{\tau s + 1}{J \tau s^2 + (f \tau + J + a_1) s + a_0 + f}$$

$$\text{and } F(s) = \frac{a_1 s + a_0}{J \tau s^2 + (f \tau + J + a_1) s + a_0 + f}$$

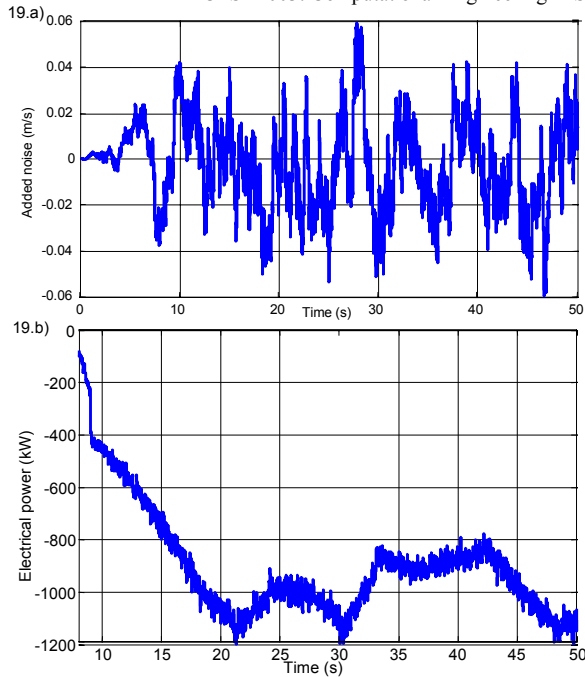

Fig. 19: Obtained results with a noisy wind speed measurement

REFERENCES

- [AME 02] J. L. Rodriguez-Amenedo, S. Arnalte, J. C. Burgos, "Automatic generation control of a wind farm with variable speed wind turbines", IEEE Transactions on energy conversion, vol.17, No.2, June 2002
- [BAU 02] P. Bauer, S. W. H.de Haan, M. R. Dubois, "Windenergy and Offshore Windparks:State of the Art and Trends", 10th International Power Electronics and Motion Control Conference: EPE-PEMC 2002, CD, 9-11 September 2002, Cavtat, Croatia
- [BOU 02] A. Bouscayrol, Ph. Delarue, "Simplifications of the Maximum Control Structure of a wind energy conversion system", Int. J. Renew. Energy Eng, vol. 4 (2), p. 479-485, 2002
- [ELA 02] S. El Aimani, B. Francois, B. Robyns, "Modelling of variable speed wind generators jointly connected to continuous bus", Forum International sur les énergies renouvelables, 8-10 Mai 2002, Maroc
- [EZZ 00] E. S. Abdin, W. Xu, "Control design and Dynamic Performance Analysis of a Wind Turbine-Induction Generator Unit", IEEE Trans. on Energy conversion, vol.15, No1, March 2000
- [MUL 01] E. Muljadi, "Pitch-Controlled Variable-Speed Wind Turbine Generation", IEEE Trans. on Industry Applications, vol.37, No1, Jan./Feb. 2001
- [NWCC 01] National Wind Coordinating Committee, "Distributed Wind Power Assesment", Fevbruary 2001, www.nationalwind.org
- [THI 93] T. Thiringer, J. Linders, "Control by Variable Rotor Speed of a Fixed-Pitch Wind Turbine Operating in a Wide Speed Range", IEEE Trans. on Energy conversion, vol.8, No3, Sept. 1993
- [SIM 97] M. G. Simoes, B.K. Bosse, R.J. Spiegel, "Design and Performance Evaluation of a Fuzzy-logic-Based Variable-Speed Wind Generation System", IEEE Trans. on Industry Applications, vol. 33, No 4, July/August 1997
- [VAN 01] T.G. Van Engelen, E.L. Van Der Hoof, P. Schaak, "Development of wind turbine control algorithms for industrial use", European Wind Energy Conference, Copenhagen 1-7 July 2001