



HAL
open science

Glass in Rome during the transition from late antiquity to the early Middle Ages: materials from the Forum of Caesar

Cristina Boschetti, Jan Kindberg Jacobsen, Claudio Parisi Presicce, Rubina Raja, Nadine Schibille, Massimo Vitti

► To cite this version:

Cristina Boschetti, Jan Kindberg Jacobsen, Claudio Parisi Presicce, Rubina Raja, Nadine Schibille, et al.. Glass in Rome during the transition from late antiquity to the early Middle Ages: materials from the Forum of Caesar. *Heritage Science*, 2022, 10 (1), pp.95. 10.1186/s40494-022-00729-y . hal-03701605

HAL Id: hal-03701605

<https://hal.science/hal-03701605v1>

Submitted on 11 Nov 2024

HAL is a multi-disciplinary open access archive for the deposit and dissemination of scientific research documents, whether they are published or not. The documents may come from teaching and research institutions in France or abroad, or from public or private research centers.

L'archive ouverte pluridisciplinaire **HAL**, est destinée au dépôt et à la diffusion de documents scientifiques de niveau recherche, publiés ou non, émanant des établissements d'enseignement et de recherche français ou étrangers, des laboratoires publics ou privés.



Distributed under a Creative Commons Attribution 4.0 International License

RESEARCH

Open Access



Glass in Rome during the transition from late antiquity to the early Middle Ages: materials from the Forum of Caesar

Cristina Boschetti^{1*}, Jan Kindberg Jacobsen², Claudio Parisi Presicce³, Rubina Raja^{1,4}, Nadine Schibille⁵ and Massimo Vitti³

Abstract

Base glasses from the eastern Mediterranean which circulated in Rome between the fifth and tenth centuries bear witness to the persistence of long-distance trade after the fall of the Western Roman Empire. LA-ICP-MS data of vessel fragments, mosaic tesserae and indicators of production excavated in the Forum of Caesar identify a substantial amount of recycled Roman base glass mixed with later Foy.2.1 glass, flanked by Roman Mn and Sb, Foy 2.1, Foy 3.2, HIMT and Levantine I base glass. Recycled compositions have been documented since the fifth century. Base glasses dating later than the seventh century are completely missing, indicating an interruption or a strong contraction of the commercial flows sometime in the seventh century. The identification of a small number of medieval vessels is coherent with the presence in the area of a dwelling context of elevated status. The compositional features of these glasses reflect the intensification of recycling in the eighth century, when the commerce of cullet became increasingly international and some fresh glass continued to travel along the Adriatic trade routes.

Keywords: Middle Ages, Late antiquity, Glass tesserae, Glass vessels, LA-ICP-MS, Rome, Forum of Caesar

Introduction

In 2017 a large-scale excavation project began focusing on the last non-exposed 2000 square metres of the area known as Caesar's Forum in central Rome [1–4]. This area is known for housing the famous first enclosed forum, the Forum Iulium, which became an architectural model for the self-display of the emperors during the following centuries. Previous excavations undertaken on the Forum of Caesar have produced archaeological remains covering a broad chronological span going from the 12th Century BC up to 1932, when the area, known as the Alessandrino Quarter, was demolished and the present-day Via dei Fori Imperiali was constructed [3, 5, 6]. On the same occasion large parts of the fora areas were

brought to light. The 1932 demolitions were conducted within a narrow time frame and with only partial application of archaeological excavation and registration standards, leaving a void in the understanding of the long-term urban and material cultural transformation of this central area of Rome. Against this backdrop, the current Danish-Italian excavation and research project is based on the careful investigation of all the chronological phases, combining the traditional field exploration with scientific investigations of the finds from the past and present excavations [7] (Fig. 1).

Within the framework of these studies, the analysis of glass finds has a central importance. The state of the art on glass from Rome between late antiquity and the early Middle Ages is rather limited and broad interdisciplinary studies, going beyond the analysis of one single site, lack completely. Research conducted in the last twenty years shows that the end of the Western Roman Empire and the rise of Constantinople did not mark a

*Correspondence: cristina.boschetti@cas.au.dk

¹ Centre for Urban Network Evolutions (UrbNet), Aarhus University, Moesgård Allé 20, 8270 Højbjerg, Denmark
Full list of author information is available at the end of the article



Fig. 1 Plan of the Forum of Caesar, with the areas excavated during the 1998–2000 and 2021 campaigns (The Caesar's Forum Project)

sudden interruption of international commerce that connected the capital to the Mediterranean and northern Europe. Rome continued to be a nodal point for the arrival and distribution of goods until the seventh century [8–11]. This model is mainly based on the identification of imported ceramics and amphorae [12, 13], but the dynamics regulating the glass trade are still blurred [14]. The chronology of glass vessels documented in Rome and Latium between the fourth and the eighth centuries is well defined [15–19], but the few chemical analyses available were mainly published when the division of natron glass into different base glass groups was not yet fully established [15, 20–23]. The primary aim of this article is to clarify the dynamics regulating the glass economy in Rome during the transitional phase between the fifth and the eleventh century, based on the glass finds from the Forum of Caesar. The glass corpus from the Forum includes vessels, window panes, indicators of production, and mosaic tesserae. It was investigated with an interdisciplinary approach to elucidate the relationships between the chronology, typology and provenance of the glasses circulating in Rome. The published chemical data on glass from Rome were at the same time re-evaluated in the light of the most recent advances in the state of the art. The glasses from the Forum of Caesar have thus been placed in the wider

context of the city and the trade networks crossing Europe and the Mediterranean, to evaluate the impact of collecting and recycling on the creation of a new glass economy at the beginning of the Middle Ages.

Archaeological context

The starting point to interpret the complex sequence of occupation in the Forum of Caesar is to define a distinction between primary and infilled contexts, evaluating the date of the archaeological materials and the chronology of their deposition. By the second half of the ninth century the former open square of the Forum was occupied by orchards and vineyards and one-story single-room houses, the *domus terrinee* [24]. These buildings were laid out directly on the level of the Forum of Caesar and often incorporated ancient architectural elements collected from the surroundings, like marble blocks and decorative fragments. The excavation provided a detailed documentation of the practice of reusing soil collected from late antique contexts, during the tenth century [4]. These operations were functional to cover and seal deposits of mud transported by seasonal flooding in the area. The reoccurring character of this practice is evident from the archaeological stratigraphy, where levels of mud with a thickness of circa 10 cm alternate with levels of gravel-rich soil of the same thickness.

The domus terrinee contexts FC2021 US 3034 and 3042, which yielded numerous glass fragments, can be identified as two of these refilled contexts. The vast majority of ceramics from these contexts belong to the Roman and

late antique period (US 3034: 97%; US 3042: 95%), with few medieval fragments (Fig. 2a–d). A similar chronological division was already documented in the domus terrinee *ambiente III* and *ambiente XII*, investigated during

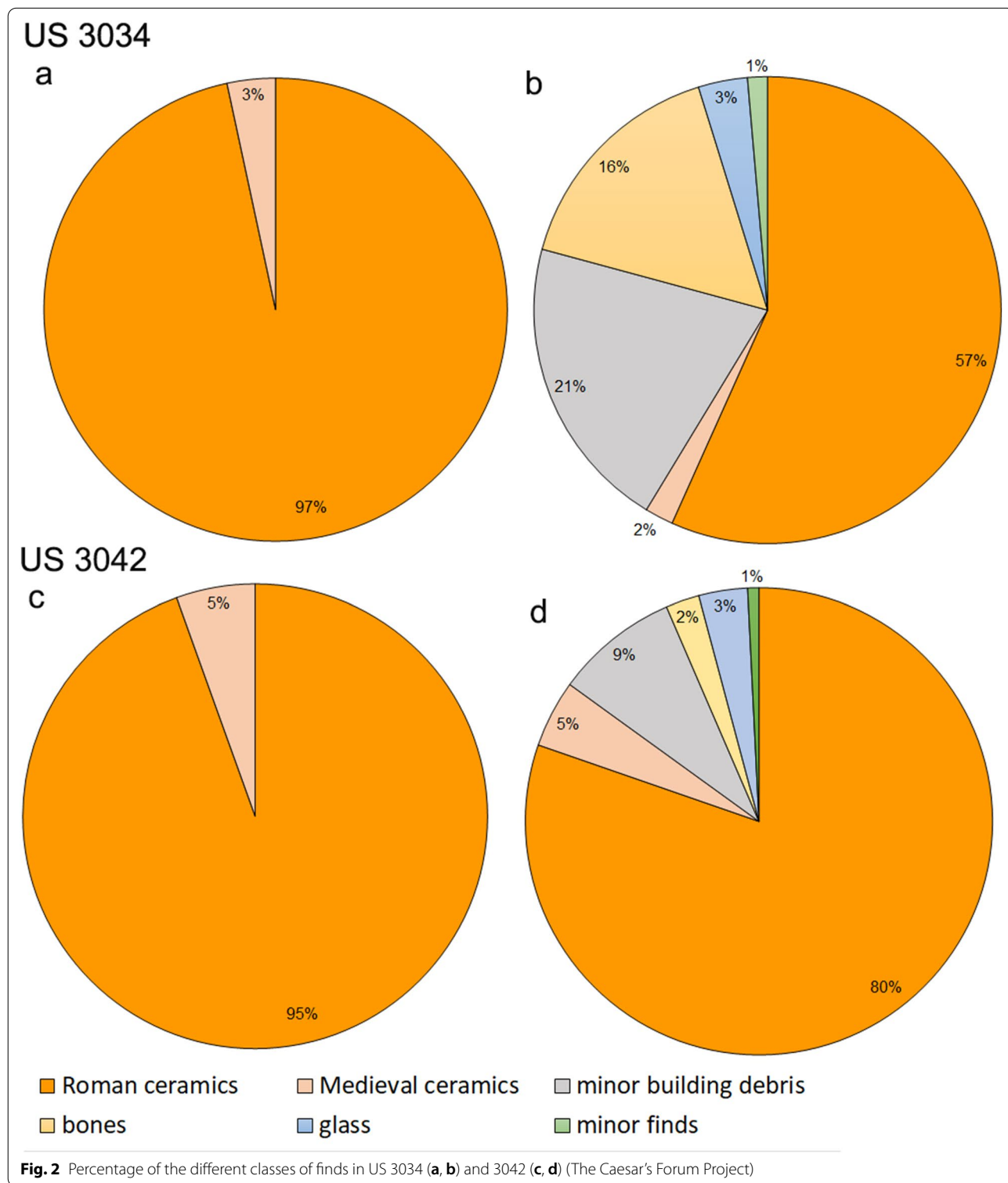

the 1998–2000 campaigns, where the medieval contexts contained up to 94 percent of Roman residual fragments [25]. A comparable situation is documented in the Forum of Trajan [24]. According to the chronological framework of the finds, UUSS 3034 and 3042 can be dated by the residual material between the fourth and the sixth centuries.

Even though the majority of the contexts investigated in the forum are backfills, a few deposits make an exception and can be identified as primary depositions. Context US 198, excavated in 1999, is a layer of building debris. It yielded numerous fragments of Roman window panes, together with ceramics datable to the fifth and sixth centuries, with few intrusions of sixteenth century material. This appears to be true also for US 4067, containing materials from the fourth to the sixth centuries, and for US 4431, containing finds from the fifth to the sixth centuries. Finally, US 4709 is a primary deposit rich in fifth- to sixth-century ceramics, with some intrusions of ceramics of the tenth and thirteenth centuries.

Materials and methods

The glass finds selected for analysis are in total 55. They include all the mosaic tesserae (n=18), the indicators of production (n=2) and the diagnostic fragments of vessels (n=31) recovered during the 1998–2000 and 2021 campaigns. Four fragments of window panes were selected from an assemblage of 79 finds that were all concentrated in the same deposit (US 198) and were homogeneous in terms of colour, fabric and thickness. All the samples are monochrome, with the exception of one bichrome vessel. The two colours of this fragment were analysed individually, making a total of 56 individual data points (Additional file 1: Table S1, Figs. 3, 4, 5). The palette of the mosaic tesserae is varied and includes different shades of blue, turquoise, green and red. They are all opaque, with the exception of four decolorised tesserae, formerly gilded (Fig. 4). The two indicators of production are a thick layer of translucent olive-green glass detached from the bottom of a crucible and a fragment of a failed vessel of the same colour (Fig. 5a–c). The vessels are naturally coloured or decolorised, but two fragments stand out for their vivid shades: the body fragment of a cobalt blue vessel

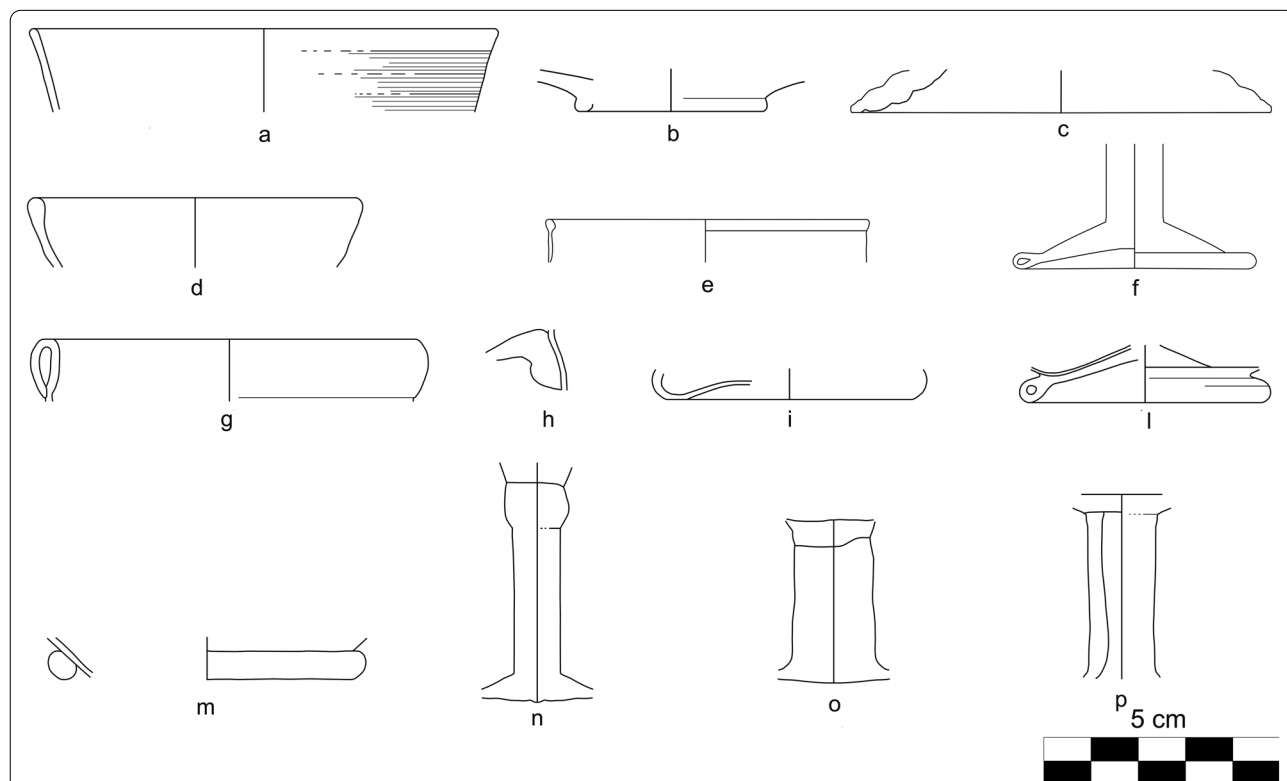

Fig. 3 Vessel types documented at the Forum of Caesar: a. hemispherical bowl Isings 96; b. hemispherical cup Isings 108; c. cup on high foot; d. shallow bowl; e. fire-rounded rim (lamps or beakers Isings 106/106b, or lamp Uboldi IV.2, or goblet Isings 111); f. goblet Isings 111; g. lamp Uboldi I; h. handle (flask?); i. beaker or lamp Uboldi I; l. Beaker with applied ring foot; m. wall with applied filament (funnel-mouth bottle?); n. goblet with knot; o. goblet with short stem; p. goblet with hollow stem. (Sovrintendenza Capitolina-The Caesar’s Forum Project)

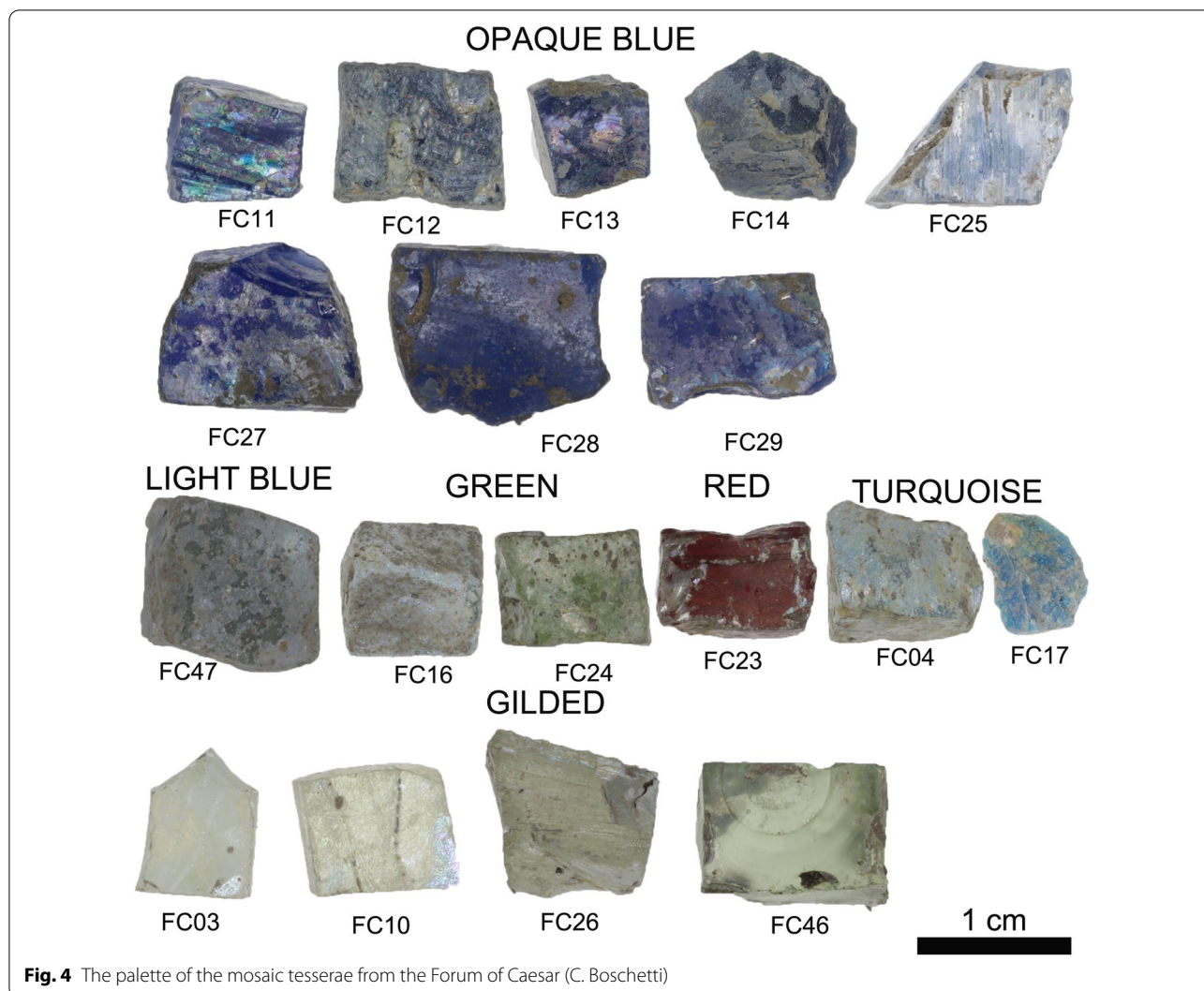

Fig. 4 The palette of the mosaic tesserae from the Forum of Caesar (C. Boschetti)

decorated with an opaque white trail (Fig. 5d) and the base of a turquoise beaker (Fig. 5e). The typological study of vessels was based on the Isings and, for lamps, Ubaldi’s classifications [26–28]. Some fragments correspond to shapes previously documented in Rome, but not typologically classified.

The samples were cleaned and analysed by laser ablation inductively coupled plasma mass spectrometry (LA-ICP-MS) at IRAMAT-CEB in Orléans (France), without any further preparation. A Thermo Fischer Scientific ELEMENT XR mass spectrometer was combined with a Resonetics M50E excimer 193 nm laser, working at a 5 mJ energy and a 10 Hz pulse frequency. A stationary spot with a diameter between 30 and 100 µm was used to collect 58 different isotopes from lithium to uranium for 30 s after a pre-ablation of 20 s, which is set to remove any surface alteration and transient part of the signal [29, 30]. One ablation was performed per glass sample unless

there were inconsistencies in the spectrum. In this case, the analysis was repeated. Reference glasses NIST 610 from the National Institute for Standards and Technology and Corning B, C and D from the Corning laboratory were used for external calibration, while ²⁸Si serves as an internal standard and to calculate fully quantitative concentrations. In order to validate the results and to monitor the stability of the system over the course of the analytical run. Corning A and NIST 612 glass reference standards were analysed at regular intervals throughout the analytical sequence. Precision and accuracy are typically within 5% to 10% of the certified values (Additional file 2: Table S2). Detection limits depend on the beam diameter and the type of glass. The typical ranges of the detection limits for archaeological glass with the standard analytical protocol are listed in Gratuze [30].

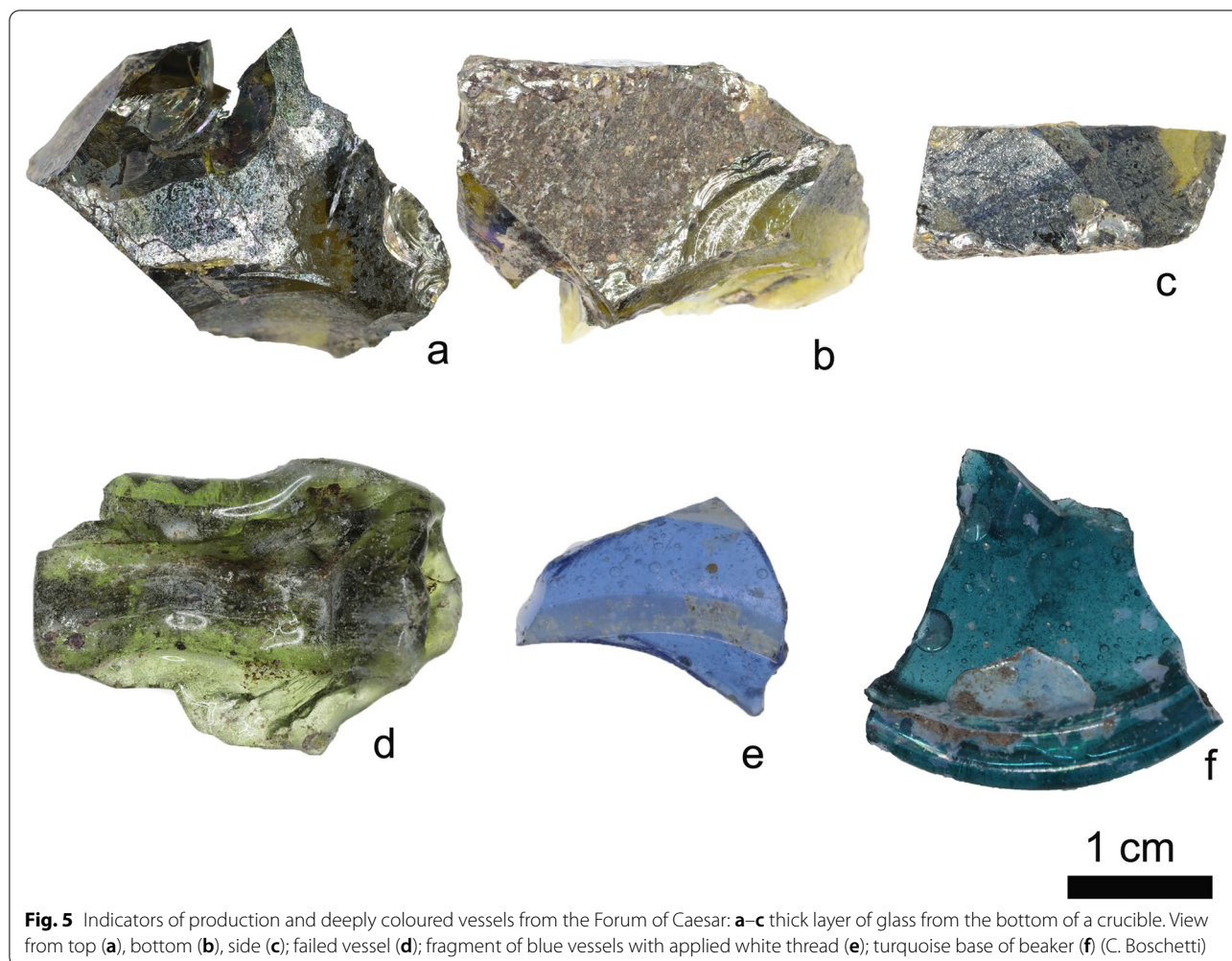

Fig. 5 Indicators of production and deeply coloured vessels from the Forum of Caesar: **a–c** thick layer of glass from the bottom of a crucible. View from top (**a**), bottom (**b**), side (**c**); failed vessel (**d**); fragment of blue vessels with applied white thread (**e**); turquoise base of beaker (**f**) (C. Boschetti)

Results

Vessels typology

The large majority of the vessels from the Forum of Caesar represents types documented in Rome from the end of the fourth to the seventh centuries and in some cases, also during the eighth century. Only six fragments stand out from the main assemblage, because they reflect typological innovations of the early Middle Ages. Two rims (CF14, 35) and one base (CF05) from the main late antique group are potentially the earliest glass vessels of the entire assemblage and can be attributed to types documented as early as the beginning of the fourth century (Fig. 3a, b). The rims are rounded, with parallel wheel-cut lines on the exterior under the lip edge. They belong to hemispherical bowls Isings 96, a type popular in Rome and in Latium during the fourth and the fifth centuries [16, 18, 19]. These vessels were probably produced locally, as suggested by the identification of one failed bowl, in a dump excavated in a backfill on the slopes of

the Palatine hill [14]. The bottom fragment has an applied base ring and belongs to a hemispherical cup of Isings 108, a vessel well recorded from the fourth to the end of the sixth century. All the other fragments correspond to new types that developed from the beginning of the fifth century. Two tronco-conical bases (CF53-54) belong to cups on high foot, popular in Rome throughout the fifth century [18] (Fig. 3c). A similar chronology can be probably assigned to the rim of a shallow bowl (CF57) (Fig. 3d). Six fire-rounded rims are of uncertain typology (CF02, 06, 07, 08, 14, 39). They could belong either to conical lamps or beakers of Isings 106/106b, or to funnel lamps Ubaldi IV.2, or even to goblets of Isings 111 (Fig. 3e). The beakers and the lamps have a common chronology, ranging from the beginning of the fifth to the end of the seventh centuries and they were still available during the eighth century [18, 19]. The goblets of Isings 111 are very widespread in the entire Mediterranean region and were used to serve wine, but also as oil lamps [18]. Whereas

these vessels are documented in the eastern Mediterranean as early as the late fourth century, they appeared in the west and in Rome only during the last quarter of the fifth century [18, 19]. Not surprisingly, the Isings 111 is the most represented vessel of the entire Caesar Forum assemblage, with at least nine specimens, including fragments of feet and stems (CF18, 20, 21, 33, 34, 42, 44, 45, 55) (Fig. 3f). Two tubular rims (CF22, 36), two slightly concave bases (CF31, 32) and one handle (CF30) complete the late antique assemblage (Fig. 3g–i). The rims and the base can all be associated with hanging lamps of the type Uboldi I documented, like the goblets, between the fifth and the eighth century [18, 19]. By contrast, the handle cannot be attributed to any standardised type, but it is coherent with one sixth- to seventh-century flask from Rome [17].

The last six fragments are different from the main late antique assemblage and represent novelties that start to develop from the late sixth century. This small group is particularly important, because these types of glass vessels are quite rare. Two fragments reflect the preference for intense colours that emerges from the late sixth century. The first is the base of a turquoise vessel with applied foot ring and conical pushed-up bottom (CF19) (Figs. 3l, 5f). The other is of a wall of transparent cobalt blue glass, decorated with a thin white thread applied as a spiral around the body of the vessel (Fig. 5e). The turquoise fragment is difficult to interpret and date, because the published parallels are extremely scarce. Similar bases with foot ring are documented in beakers excavated in the phases of abandonment of the domus in the Forum of Nerva, dated between the eleventh and the thirteenth century [31]. A similar base is also documented at San Vincenzo al Volturno, where it is interpreted as part of a bottle, but this fragment is a surface find and cannot be dated stratigraphically [32]. None of these vessels have vivid colours, like the fragment from the Forum of Caesar.

On the basis of the combination of colours, decoration and the pronounced bend, the blue and white fragment can be tentatively identified with a drinking horn of the group Evison IV [33] or with a funnel-mouth bottle [13]. Parallels for similar beakers, drinking horns and bottles exist in several Italian sites, including Rome, and date to the late sixth and first half of the seventh century [13, 33–35]. A similar date can be assigned to the fragment of a wall decorated with a thick thread of glass applied on the external surface (CF37) (Fig. 3m) that shares close similarities with funnel-mouth bottles with a thread applied under the rim, documented from the Crypta Balbi and northern Italy [18, 36]. Finally, three stems of goblets illustrate the evolution of the late antique goblet of Isings 111 into new, larger and less standardised vessels

introduced from the eighth century and documented until the eleventh [35]. Two are made with a solid piece of glass, formed separately from the base and the cup: one is slender and decorated with a knot in proximity of the cup (Fig. 3n) and the other is short and cylindrical (Fig. 3o). Similar vessels have been excavated in the late ninth- to tenth-century phases of the Forum of Nerva [37]. The same chronology can be assigned to the third stem, thick and hollow, formed pulling the hot glass from the base [35] (Fig. 3p).

Chemical composition

In accordance with Roman and late antique glassmaking traditions, all analysed samples can be classified as natron-type glasses, with low magnesium and potassium oxide concentrations (<1.5 wt%; Additional file 1: Table S1). The use of natron as fluxing agent dominated in the Mediterranean until the turn of the ninth century CE, when mineral soda was replaced by soda-rich plant ashes as the main source of alkalis. Roman and late antique natron-type glasses have now been sub-divided into ten major compositional groups, most of which can be successfully distinguished by plotting their $\text{Al}_2\text{O}_3/\text{SiO}_2$ and $\text{TiO}_2/\text{Al}_2\text{O}_3$ ratios that reflect the mineral impurities in the silica source, in addition to their relative concentrations of manganese and antimony that acted as decolourants in Roman glass [38–40]. Roman glass of the first three to four centuries is typically classified according to the decolourant used: Roman antimony-decoloured glass (Roman Sb) produced in Egypt, Roman manganese-decoloured glass (Roman Mn) manufactured predominantly in the Levant, and a mixture of the two (Roman Sb-Mn), for which Sb and Mn-glasses were mixed during the secondary process [41–44]. Thresholds for Mn < 250 ppm and for Sb < 30 ppm need to be applied below which both elements can be considered natural impurities of the silica source [45, 46]. Later Levantine glass of the Apollonia type (Levantine I) that is very similar in composition to Roman Mn glass, differs from the latter, among other things, in the absence of manganese [38, 40]. Late antique glass types from Egypt such as HIMT and Foy 2.1 are furthermore characterised by high but varying impurities of heavy elements (e.g. Ti, Zr, Hf) and elevated manganese contents [39, 45, 47–49].

Applying these criteria to the glass finds from the Forum of Caesar, we find that the assemblage is a mix of different base glass groups, including high iron, manganese and titanium (HIMT) glass, Foy 2.1, Apollonia-type Levantine I, and a mixed group that appears to be a combination of Roman Mn Sb and Foy 2.1 type glass, but with a significant admixture of recycled material as shown by the elevated antimony contents (Fig. 6a, b). The tesserae have been singled out because the attribution of

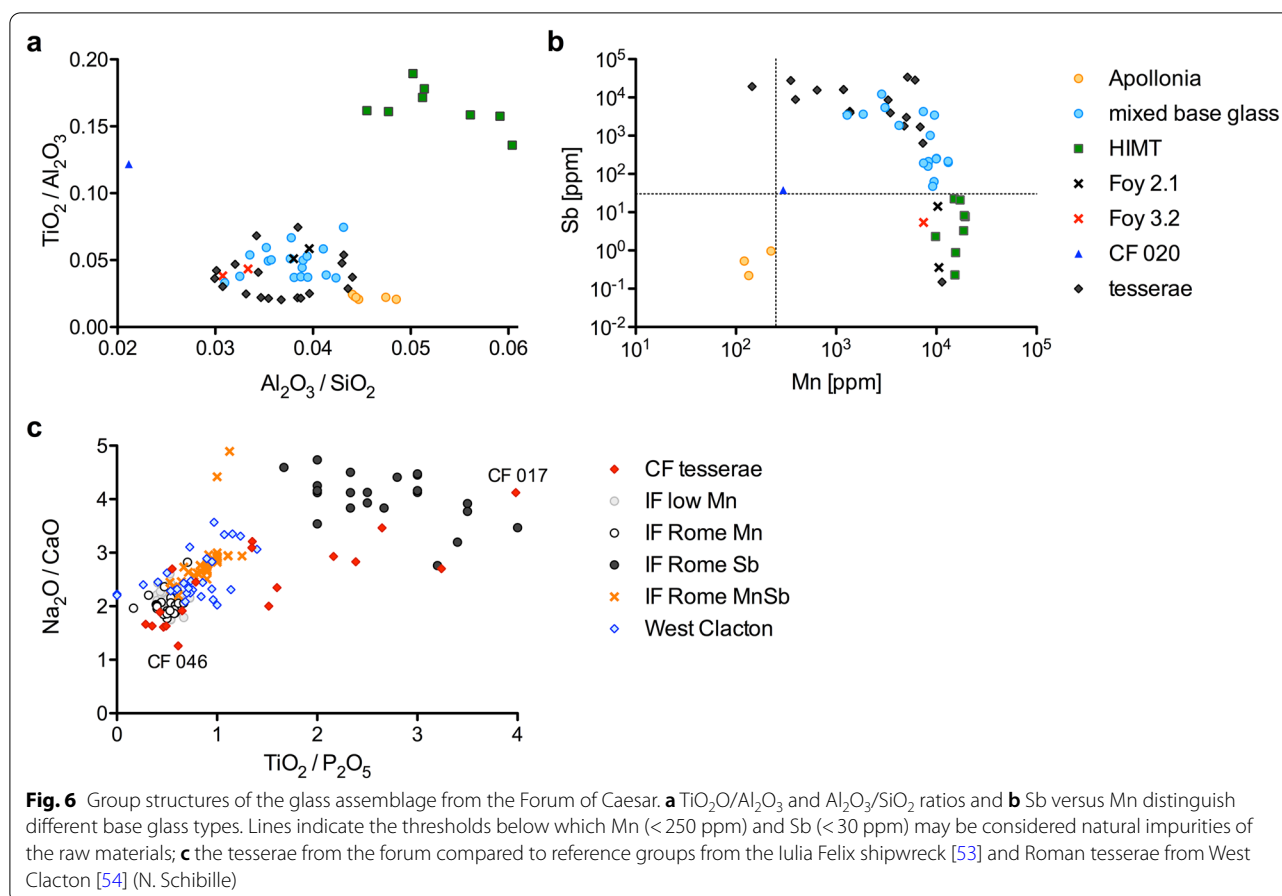

strongly coloured and opaque glasses to a specific primary production group is sometimes hampered by impurities introduced during the colouring processes [50]. The majority of the glass fragments, including most of the tesserae, show both manganese and antimony in excess of the natural concentrations of silica sources (Fig. 6b). These samples have the characteristics of mixed base glass, either Roman Mn Sb or with an addition of a late antique glass group such as Foy 2.1, which augmented the heavy element levels (Fig. 6a; Additional file 1: Table S1). Foy 2.1 is an Egyptian glass that appeared on the market in the middle of the fifth century CE and that often exhibits relatively high contamination levels associated with recycling [49, 51, 52]. At least two samples from the Forum of Caesar represent this type of base glass (Fig. 6a; Additional file 1: Table S1).

Clearly distinct due to the absence of both Mn and Sb is a group (n=7) that matches the composition of Apollonia-type Levantine I glass dating probably to the sixth to seventh centuries CE [38] (Fig. 6a, b). It is compositionally related to the Roman Mn glass but has on average lower soda and higher alumina and lime concentrations (Additional file 1: Table S1) [38]. The glass

with the highest $\text{TiO}_2/\text{Al}_2\text{O}_3$ and $\text{Al}_2\text{O}_3/\text{SiO}_2$ ratios and considerable quantities of manganese, but no antimony, corresponds to HIMT (n=8), a glass produced in Egypt from the fourth century and widely used throughout the Roman Empire at least until the sixth century [39]. This group includes the two indicators of production, the four window panes, together with one lamp Uboldi I and one fire-rounded rim. Two vessel fragments, may represent the so-called Foy 3.2 glass, an Egyptian composition with low alumina and moderate titanium levels (Fig. 6a, b). The earliest examples of Foy 3.2 glass date to the fourth century CE [48, 55–57]. Only one mosaic tessera (CF 17) appears to be a Roman Sb-decoloured glass and one sample (CF 20) has exceptionally low alumina levels ($\text{Al}_2\text{O}_3 < 1.5\%$) coupled with elevated titanium oxide (0.18%) (Fig. 6a).

$\text{Na}_2\text{O}/\text{CaO}$ and $\text{TiO}_2/\text{P}_2\text{O}_5$ ratios have been used effectively before to distinguish different Roman base glasses of mosaic tesserae, as phosphorus and calcium oxide tend to be lowest in Roman Sb glass and highest in Roman naturally coloured and Roman Mn type glasses, while mixed Roman Sb Mn glasses lie in the middle [54]. Accordingly, a handful of blue samples (n=6) can be assigned

to either the Roman naturally (low Mn) or Roman Mn glass by virtue of their low soda to lime and titanium to phosphorus ratios compared to the other groups and their clear similarities with the reference glass from the Iulia Felix shipwreck [53] (Fig. 6c). Another six tesserae are consistent with mixed Roman Mn Sb glass. Tesserae outside of the compositional trend of Roman glasses are difficult to attribute clearly to a compositional group. Four samples may be Foy 2.1 or similar. One decolourised gold leaf tessera (CF 046) appears to represent Levantine I type glass from Apollonia, despite its elevated Mn levels that is probably related to the colouring of the glass to modify the shade of the gold foil [58] (Fig. 6b). Finally, one turquoise coloured tessera (CF 17) corresponds to Roman Sb glass (Fig. 6b, c).

Except for sample CF 03, 10, 026 and 046 that are not opacified, all tesserae show high concentrations of antimony, suggesting that they have been opacified with antimony compounds [59]. The elevated tin in the CF 024 tessera that is otherwise opacified by antimony compounds, was most likely unintentionally introduced with a tin-rich copper source (e.g. bronze scale) used to obtain the green [60]. The same can be said for turquoise tesserae CF 004 that is the only sample identified with a Roman Sb-glass. The ratios of cobalt to nickel may serve as an additional chronological marker. The cobalt blue tesserae of the Roman Mn/low Mn group and sample CF 015 of the mixed base glass group all have $Co/Ni > 20$, in line with the low-Ni cobalt source used until the fourth century CE [61]. Tessera CF 012 and the bottle or drinking horn CF 009 that are tentatively assigned to a mixed glass (probably some Foy 2.1), have slightly higher nickel relative to cobalt concentrations, which may point to a later date of their manufacture and/or colouring (Additional file 1: Table S1). Like most mixed glasses, this sample shows clear signs of recycling in the form of colouring elements that exceed the natural impurity levels of glass raw materials (Additional file 1: Table S1). Apollonia type Levantine I as well as Foy 2.1 and Foy 3.2, in contrast, exhibit the lowest recycling markers, while HIMT has only slightly elevated copper and lead contents (Additional file 1: Table S1) (Fig. 7). This suggests that Roman glass types were recycled more easily, or at least more frequently, than late antique production groups.

Discussion

The comparison between context, typology and chemical composition of the glasses from the Forum of Caesar stimulates reflections on the glass economy in Rome, between the fourth and the tenth centuries. Roman glass in its mixed and recycled form was remarkable for its longevity. The mixed Roman glass is visible at the Forum of Caesar as early as the fifth

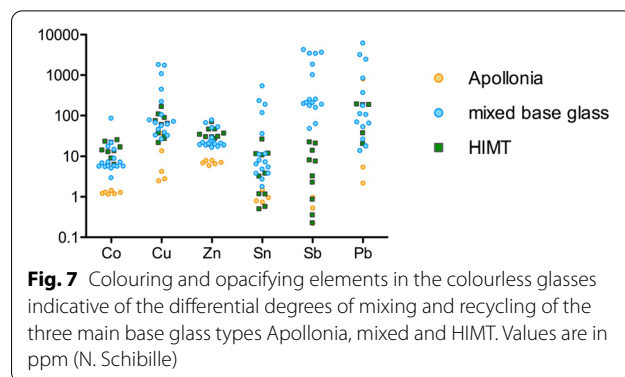

century, as documented by its identification in types produced not later than the end of the fifth century, like the hemispherical cups of Isings 96 and 108 and the shallow bowls and cups on high foot [18]. Its long period of use is confirmed by its identification in fifth- to seventh-century vessels, including the goblet of Isings 111 (CF 21, 42, 55), the lamp Uboldi I (CF 42) and the bottle with applied decoration (CF 37). The blue and white bottle or drinking horn (CF09) is interesting because the blue glass of the body was coloured with a post-fourth century cobalt source, while the white of the decoration is opacified by calcium antimonate, in keeping with pre-fourth-century traditions. A similar combination of base glasses with colourants and opacifiers of a different date is documented from glass beads and reflects the practice of recycling mosaic tesserae, as a readily available source of opaque and coloured glass [62]. Two of the three medieval goblets (CF40, 43) are manufactured using recycled Roman base glass, documenting that the use of Roman cullet extended at least until the beginning of the tenth century. The third medieval goblet (CF41) is made with Apollonia glass and does not show clear signs of recycling. It might represent the late use of an old stock of raw material, or the recycling of clean cullet, which occurred between the ninth and the tenth century.

Published chemical compositions of glass finds from well dated contexts in Rome are useful to complement the results from the Caesar Forum and to discuss them within the broader urban context, tracing a timeline for the glass supply in Rome. The assemblages considered for this purpose include the glasses from the seventh- and eighth-century contexts of the Crypta Balbi [22, 23], the second- to fourth- century vessels from the Esquiline and the Palatine [21] and indicators of glass working excavated in a fifth-century dump on the slopes of the Palatine [15]. There are no chemical data on mosaic tesserae from the urban area of Rome, but

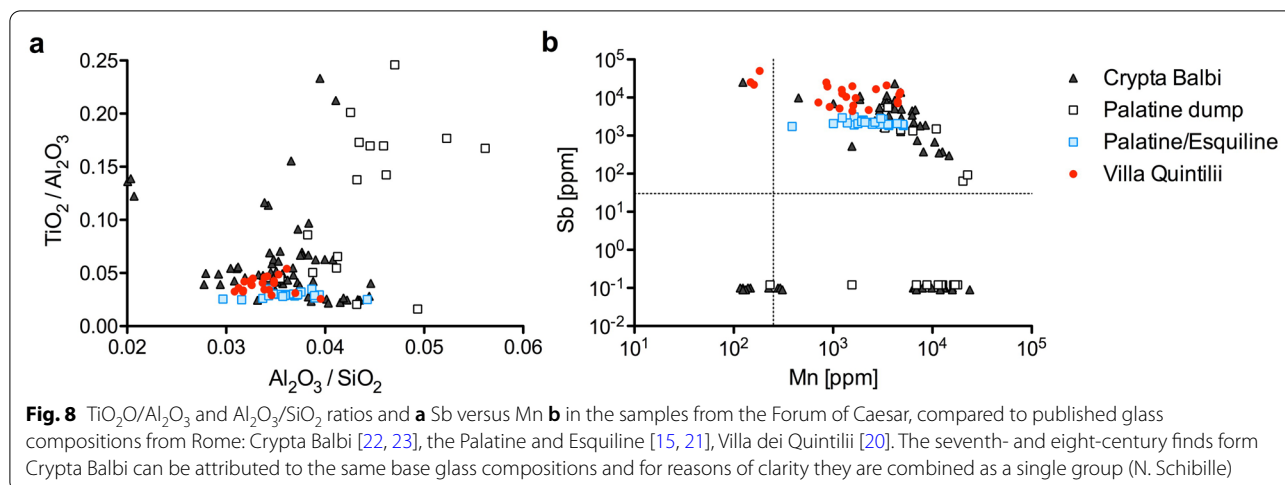

the third-century tesserae from the calidarium of the Villa dei Quintilii offer a good comparison [20].

According to the concentrations of manganese and antimony and the oxide ratios of $\text{Al}_2\text{O}_3/\text{SiO}_2$ and $\text{TiO}_2/\text{Al}_2\text{O}_3$, the published natron glasses can be attributed to the same base glasses found at the Caesar Forum (Fig. 8a). Interestingly, with the exception of one sample from the Palatine dump, Roman glass is documented mainly in the vessels from contexts dated before the fourth century, in the third century tesserae from the Villa dei Quintilii [15, 20, 21] and, to a lesser extent in the Crypta Balbi and in the Palatine dump [15, 22, 23]. Like at Caesar’s Forum, Roman mixed glass is ubiquitous, accompanied by a very limited number of Sb and Mn-glasses (Fig. 8b). These results paint a picture of a market supplied with raw glass manufactured in the Levant and Egypt and frequently mixed during the secondary processes. Later, in the fourth century, new Egyptian compositions are introduced to the market and become predominant. The two indicators of glass-working from the forum are HIMT glass, as are most of the indicators of production from the Palatine Hill [15]. The identification of Foy 3.2 glass in the forum is particularly interesting, because the full picture of the availability and distribution of this type of base glass in Italy is still unclear [55]. The Crypta Balbi offers three parallels for the low-alumina outlier in the Forum of Caesar assemblage (CF 020) [23]. Imports of fresh glass from the Levant are visible again from the sixth century onwards, with Levantine I glass found in the Forum of Caesar, the Crypta Balbi and the Palatine dump [15, 23] (Fig. 8a, b).

At the Forum of Caesar and in the other glass assemblages considered for comparison the new base glasses produced in Egypt and the Levant from the seventh

century are absent. The two intensely-coloured vessels and two of the three medieval goblets are made from recycled glass or from old stocks of glass. The parallels for similar vessels in the Italian archaeological record, from burials of aristocrats [35] and elite residential contexts [37], identify them as valuable objects. Their chemical composition shows that recycled glass was acceptable for the production of valuable artefacts. The identification of the three medieval goblets is also useful in defining the quality of life in the medieval residential contexts in the forum. The contexts of the three goblets (US 4148, 4219 and 4230 from the 1998–2000 excavation campaigns) contain a broad range of medieval ceramics from the ninth to the tenth centuries, in the form of coarse and cooking ware, but the majority of the material dates between the fifth and the sixth century. A more detailed interpretation of the contexts is not possible at this stage of research, but it is reasonable to assume that in the Forum of Caesar the domus terrinee coexisted with more prestigious buildings, probably similar to the domus solarate [37].

The Latin sources mention the collection of cullet in Rome as early as the first century [63]. The cargo of the Iulia Felix, a ship that sank in the Adriatic in the second century CE, currently offers the earliest archaeological evidence of the trade of cullet in the Mediterranean region [64]. Recycling workshops are clearly documented in Britain [43, 65], while they are only visible in the archaeological record of Italy from the fourth century [66]. At the Forum of Caesar, recycled compositions are documented from the fifth century, when the city was regularly supplied by imports of raw glass. At the turn of the eight century, when the imports of raw glass were interrupted or at least, drastically reduced, all the crafts practised in Rome were in sharp decline, with the

exception of glass recycling [14, 22]. After the eight century, glass is extremely rare in Rome, including the Forum of Caesar, but this lack of visibility does not necessarily mean that glass was no longer used. Rather, we suggest that this might be the result of more intensive collection and recycling activities [67]. This change was not only the response to the shortage of fresh glass, but also reflects a profound transformation in the glass market. Cullet and tesserae were commodities regularly exchanged, even over long distances. The marked demographic decline registered in Rome and other cities of the former Western Empire in this period led to an increasing volume of cullet and tesserae, which were readily available from the abandoned buildings and certainly contributed to the development of the commerce of cullet. The transformation of recycling from punctual activity integrated in a local system of supply to a large-scale craft is probably the explanation for the large recycling workshops comprising several activities, as documented in Rome at the Crypta Balbi [9] and in Tuscany at Aiano and Spolverino [62, 68, 69]. It is well known that in Italy Roman glass was recycled in monasteries and in proximity to churches for the production of stained windows and vessels [70, 71]. However, there is reason to believe that cullet travelled far beyond the borders of the peninsula. The occasional finds of loose Roman tesserae along the roads crossing the Apennine passes suggest that cullet and perhaps recycled glass in the form of ingots were transported overland from central Italy to the north [72] to reach the large recycling workshops in northern Europe and Scandinavia, where glass was not easily available [73]. Interestingly, the data available for eight- to eleventh-century glass from the emporia of the Adriatic coast offer a slightly different scenario, with recycled Roman glass and pre-seventh-century base glasses occasionally flanked by fresh natron and plant ash glasses imported from the Middle east and Asia Minor [74, 75]. The general picture for the glass economy of the peninsula during the early Middle Ages is still very fragmentary, but it seems that the Byzantine territories of the Adriatic coast were supplied by a flux of eastern products that did not reach the trade routes crossing the Tyrrhenian Sea and touching Rome.

Conclusions

The history of glass in Rome between late antiquity and the early Middle Ages is still very patchy, but the results obtained with the glass corpus from the Caesar Forum have shed light on the changes in the dynamics of the glass supply during a period of political and economic transition. The identification of the different base glasses and their chronologies traces the main changes of the glass market, which was dominated by a shifting

hegemony of the Levant and Egypt as exporters of raw glass. Rome, the capital of the empire, was for centuries one of the most important centres where goods, including glass, from the south of the Mediterranean converged and were redistributed across Europe. From at least the fifth century, fresh glass circulated in Rome alongside recycled compositions, which were probably obtained locally by collecting and recycling the glass from the waste produced in the city. The eight century marks the drastic contraction of these commercial flows and the interruption of imports of raw glass, but this dramatic change did not exclude Rome from the glass economy. Some fresh eastern glass continued to travel along the trade routes crossing the Adriatic, but the volume of these imports was limited. The experience acquired during centuries of glass recycling in the peninsula was certainly fundamental in responding to the sudden shortage of raw glass and in opening the way for a parallel market based on the exploitation of glass as a renewable material.

Supplementary Information

The online version contains supplementary material available at <https://doi.org/10.1186/s40494-022-00729-y>.

Additional file 1: Table S1. Chemical composition of the glass samples analysed by LA-ICP-MS (oxides wt%, elements ppm, bd = below detection).

Additional file 2: Table S2. Average LA-ICP-MS data of glass standards compared to published values for Corning glass standards A, B, C, D, and NIST SRM 612.

Acknowledgements

Photos, drawings and cataloguing was conducted at the Danish Institute in Rome in inhouse research staff (Francisca Corsetti, Laura di Siena and Gloria Mittica). Additional drawings were made by Nadia Andersen, Amalie Mølgaard Becker and Neena Pernille Øelund Pagh. Nadia Andersen conducted the statistic on artifact distribution.

Author contributions

CB: designed and conceptualised the work, prepared the samples, conducted the typological study, collected references on glass from Rome and Italy, interpretation the chemical and typological data, contributed to writing [introduction; materials and methods; results (typological study, chemical composition); discussion; conclusions], and reviewing the paper. JKJ, RR: collected the data on the archaeological contexts, curating their analysis, discussion and interpretation, and contributed to writing, editing and reviewing the paper. CPP, MV: conducted the archaeological analysis of old and recent excavation data and contributed to writing and reviewing. NS: conducted the chemical analyses, interpreted and visualised the analytical data, contributed to writing [materials and methods; results (chemical composition); discussion], reviewing and editing the paper. All authors read and approved the final manuscript.

Authors information

Cristina Boschetti (Ph.D. 2009, University of Padua) is postdoctoral research fellow at UrbNet, Aarhus University, Denmark. She has previously covered postdoctoral positions at the Universities of Nottingham (UK), Padua (IT), Cairo (Egypt) and at CNRS IRAMAT-CEB, Orléans (FR). She has curated exhibitions on ancient jewellery. Her research interests include glass typology and the application to archaeometric analyses to investigate the economy and technology of glass, jewellery, mosaics and paintings, with a focus on the period from the Hellenism to the Middle Ages.

Jan Kindberg Jacobsen (Ph.D. 2007, University of Groningen) is curator of ancient art at Ny Carlsberg Glyptotek, Copenhagen, and an associated researcher at the Danish National Research Foundation's Centre of Excellence for Urban Network Evolutions at Aarhus University, as well as at the Danish Institute in Rome. He directs the Danish research group involved in the excavations at Caesar's Forum, together with Prof. Dr. Rubina Raja.

Claudio Parisi Presicce (Ph.D. 1988, Università di Roma "La Sapienza") is general director of the Sovrintendenza Capitolina ai Beni Culturali, Direzione Musei Archeologici e Storico-Artistici. He is the concession holder of the Caesar's Forum excavations, which he directs in collaboration with Dr. Jan Kindberg Jacobsen and Prof. Dr. Rubina Raja. He has directed numerous excavations in Rome and curated several special exhibitions at the Musei Capitolini and other museums.

Rubina Raja (D.Phil. 2005, University of Oxford) is professor of Classical Archaeology at Aarhus University, Denmark, and center director of the Danish National Research Foundation's Centre of Excellence for Urban Network Evolutions. She co-directs the Danish-Italian excavations of Caesar's Forum in Rome together with Dr. Jan Kindberg Jacobsen and Dr. Claudio Parisi Presicce. Her research interests include the Mediterranean from the Hellenistic to the medieval periods, high-definition archaeology, and the intersection between archaeology and natural sciences, iconography, and portrait studies, as well as the history of religion in the Roman world.

Nadine Schibille (Ph.D. 2004, University of Sussex) is senior research scientist at the Institut de Recherche sur les Archéomatériaux (IRAMAT-CEB) of the Centre national de la recherche scientifique (CNRS) in France. She was the P.I. of a recently completed ERC-CoG-2014 project entitled *GlassRoutes* and her research interests range from the application of scientific methods to the investigation of ancient vitreous materials and technologies to questions of artistic productions and aesthetics. Her current projects focus on the production and circulation of glass throughout the Mediterranean region during the first and early second millennium CE.

Massimo Vitti (massimo.vitti@comune.roma.it, Scuola di Specializzazione 1992, Università di Roma "La Sapienza") is an official at Sovrintendenza Capitolina ai Beni Culturali. He has conducted countless excavations and research activities in Rome, among others at the Palatine Hill, the Imperial Fora, and Trajan's Markets. Within the Caesar's Forum Project, he is responsible for the organizational aspects of the excavation and he is field supervisor.

Funding

The Caesar's Forum Excavation Project is conducted as a collaboration between the Sovrintendenza Capitolina ai Beni Culturali in Rome (concession holder Claudio Parisi Presicce), Danish National Research Foundation's Centre of Excellence, Centre for Urban Network Evolutions (UrbNet) at Aarhus University (directed by Rubina Raja) and the Danish Institute in Rome (DIR) (directed by Charlotte Bundgaard). The project is funded since 2017 by the Carlsberg Foundation (grant held Marianne Pade 2017–2021, Charlotte Bundgaard, 2021-) and since 2019 by Aarhus University Research Foundation through a flagship grant (held by Rubina Raja). Further support comes from Centre for Urban Network Evolutions, under the grant DNRF 119. The project is directed by Claudio Parisi Presicce, Rubina Raja and Jan Kindberg Jacobsen. The open access fee for this publication was covered by the DNRF grant 119 held by Rubina Raja.

Availability of data and materials

All data generated or analysed during this study are included in this published article and its supplementary information files.

Declarations

Competing interests

The authors declare that they have no competing interests.

Author details

¹Centre for Urban Network Evolutions (UrbNet), Aarhus University, Moesgård Allé 20, 8270 Højbjerg, Denmark. ²Accademia di Danimarca, Via Omero 18, 00197 Rome, RM, Italy. ³Sovrintendenza Capitolina ai Beni Culturali, Direzione Musei archeologici e storico-artistici, Via delle Tre Pile 1, 00186 Rome, RM, Italy. ⁴Department of History and Classical Studies, Aarhus University, Jens Chr. Skous Vej 5, 8000 Aarhus, Denmark. ⁵IRAMAT-CEB, UMR7065, CNRS/Université d'Orléans, 3D, rue de la Férollerie, 45071 Orléans Cedex 2, France.

Received: 14 April 2022 Accepted: 26 May 2022

Published online: 22 June 2022

References

- Kindberg Jacobsen J, Parisi Presicce C, Raja R, Vitti M. Excavating Caesar's Forum: present results of the Caesar's Forum Project. *Analecta Rom Instituti Danici*. 2019;44:239–45.
- Kindberg Jacobsen J, Murro G, Parisi Presicce C, Raja R, Saxkjær SG. Practicing urban archaeology in a modern city: the Alessandrino Quarter of Rome. *J Field Archaeol*. 2021;46:36–51.
- Kindberg Jacobsen J, Murro G, Parisi Presicce C, Raja R, Saxkjær SG, Vitti M. High-definition urban narratives from central Rome: virtual reconstructions of the past and the new Caesar's Forum excavations. *J Urban Archaeol*. 2021;3:65–86.
- Corsetti Lobrera F, Di Siena L, Kindberg Jacobsen J, Mittica G, Murro G, Parisi Presicce C et al. The Danish-Italian Excavations on Caesar's Forum 2021. Report. *Analecta Rom Instituti Danici*. 45.
- Delfino A. Forum Iulium. L'area del Foro di Cesare alla luce delle campagne di scavo 2005–2008. Le fasi arcaica, repubblicana, e cesariano-augustea (BARIntSer 2607). Oxford: British Archaeological Reports; 2014.
- De Santis A, Mieli G, Rosa C, Matteucci R, Celant A, Minniti C, et al. Le fasi di occupazione nell'area centrale di Roma in età protostorica: nuovi dati dagli scavi nel Foro di Cesare. *ScAnt*. 2010;16:259–84.
- Kindberg Jacobsen J, Meneghini R, Parisi Presicce C, Raja R, Saxkjær SG, editors. *Foro Di Cesare—Volume II. I materiali ceramici dallo scavo del 1998–2000 (The Roman Fora in Rome Studies)*. Turnhout.
- Delogu P. Roma in età bizantina. In: Arena MS, Delogu P, Paroli L, Ricci M, Sagui L, Venditelli L, editors. *Roma dall'antichità al Medioevo. Archeologia e storia nel Museo Nazionale della Crypta Balbi*. Milan: Electa; 2001. p. 251.
- Giannichedda E, Mannoni T, Ricci M. I cicli produttivi. In: Arena MS, Delogu P, Paroli L, Ricci M, Sagui L, Venditelli L, editors. *Roma dall'antichità al Medioevo. Archeologia e Storia nel Museo Nazionale della Crypta Balbi*. Milan: Electa; 2001. p. 331–9.
- Sagui L. Roma e il Mediterraneo: la circolazione delle merci. In: Arena MS, Delogu P, Paroli L, Ricci M, Sagui L, Venditelli L, editors. *Roma dall'antichità al Medioevo. Archeologia e storia nel Museo Nazionale della Crypta Balbi*. Roma: Electa; 2001. p. 62–8.
- Sagui L. Roma, i centri privilegiati e la lunga durata nella tarda antichità. *Dati archeologici dal deposito di VII secolo della Crypta Balbi. Archeol Mediev*. 2002;29:7–42.
- Moncada S. Le anfore orientali in Sicilia tra il V ed il VII secolo d.C.: alcune considerazioni sul commercio mediterraneo. *Pyrenae*. 2018;49:61–85.
- La circolazione delle merci: il deposito della fine del VII secolo nell'edera della Crypta Balbi. In: Arena MS, Delogu P, Paroli L, Ricci M, Sagui L, Venditelli L, editors. *Roma dall'antichità al Medioevo. Archeologia e Storia nel Museo Nazionale della Crypta Balbi*. Roma: Electa; 2001. p. 266–330.
- Sagui L, Lepri B. La produzione del vetro a roma: continuità e discontinuità fra tardoantico e altomedioevo. In: Molinari A, Santangeli Valenzani R, Spera L, editors. *L'archeologia della Prod a Roma (secoli V–XV) Atti del Convegno Internazionale di Stud (Collection l'École Française Rome)*. Bari: Edipuglia; 2014. p. 225–41.
- Gliozzo E, Lepri B, Sagui L, Memmi I. Glass ingots, raw glass chunks, glass wastes and vessels from fifth century AD Palatine Hill (Rome, Italy). *Archaeol Anthropol Sci*. 2017;9:709–25.
- Rossi M. Vetri tardo antichi da Villa Medici. *Mélanges l'École française Rome. Antiq*. 2019.
- Sagui L. Vetro. In: Arena MS, Delogu P, Paroli L, Ricci M, Sagui L, Venditelli L, editors. *Roma dall'antichità al Medioevo. Archeologia e Storia nel Museo Nazionale della Crypta Balbi*. Roma: Electa; 2001. p. 194–5.
- Sagui L. Produzioni vetrarie a Roma tra tardo-antico e alto medioevo. In: Paroli L, Delogu P, editors. *La storia di Roma nell'alto Medioevo alla luce dei recenti scavi archeologici*. Firenze: All'Insegna del Giglio; 1993. p. 113–36.
- Sternini M. I reperti in vetro provenienti dalla basilica cristiana di Pianabella (Ostia). *J Glass Stud*. 2017;59:135–51.
- Barca D, Basso E, Bersani D, Galli G, Invernizzi C, Francesco M, et al. Vitreous tesserae from the calidarium mosaics of the Villa dei Quintili,

- Rome. Chemical composition and production technology. *Microchem J.* 2015;124:726–35. <https://doi.org/10.1016/j.microc.2015.10.037>.
21. Gliozzo E, Lepri B, Sagui L, Turbanti Memmi I. Colourless glass from the Palatine and Esquiline hills in Rome (Italy). New data on antimony- and manganese-decoloured glass in the Roman period. *Archaeol Anthropol Sci.* 2017;9:165–80.
 22. Mirti P, Davit P, Gulmini M, Sagui L. Glass fragments from the Crypta Balbi in Rome: the composition of eighth-century fragments. *Archaeometry.* 2001;43:491–502.
 23. Mirti P, Lepora A, Sagui L. Scientific analysis of seventh-century glass fragments from the Crypta Balbi in Rome. *Archaeometry.* 2000;42:359–74.
 24. Santangeli Valenzani R. I Fori Imperiali nel Medioevo e nell'età Moderna. I Fori Imperiali negli scavi del Comune di Roma. Rome: Viviani; 2008. p. 125–58.
 25. Delfino A. Contesti ceramici da due Domus Terrinee del Foro di Cesare (BARIntSer 2455). In: Ceci M, editor. *Contesti Ceramici dai Fori Imperiali.* Oxford: BAR; 2013. p. 129–38.
 26. Isings C. Roman glass from dated finds. Groningen: Wolters, J.B.; 1957.
 27. Ubaldi M. Diffusione delle lampade vitree in età tardoantica e altomedievale e spunti per una tipologia. *Archeol Mediev.* 1995;XXII:93–145.
 28. Ubaldi M. Aggiornamento sulle lampade vitree di età tardoantica e altomedievale in Italia settentrionale. *Hortus Artium Mediaev.* 2020;26:126–32.
 29. Gratuze B. Glass characterisation using laser ablation inductively coupled plasma mass spectrometry methods. In: *Modern methods for analysing archaeological and historical glass*, vol. I. New York: Wiley; 2013. p. 201–34.
 30. Gratuze B. Glass characterization using laser ablation-inductively coupled plasma mass spectrometry methods. In: Dussubieux L, Golitko M, Gratuze B, editors. *Recent advances in laser ablation ICP-MS for archaeology.* Berlin: Springer; 2016. p. 179–96. https://doi.org/10.1007/978-3-662-49894-1_12.
 31. de Luca I, Del Vecchio F. Le Domus del Foro di Nerva. Le fasi di abbandono e di riuso (XI–XIII secolo). In: Arena MS, Delogu P, Paroli L, Ricci M, Sagui L, Venditelli L, editors. *Roma dall'antichità al Medioevo. Archeologia e Storia nel Museo Nazionale della Crypta Balbi.* Milano: Electa; 2001. p. 580–5.
 32. San Vincenzo al Volturno 3. The Finds from the 1980–86 Excavations, I-II. Mitchell. Spoleto: Centro Italiano di Studi sull'Alto Medioevo; 2001.
 33. Evison VI. Germanic glass drinking horns. *J Glass Stud.* 1975;17:74–87.
 34. Jorio S, Ferrucci S. Vetri d'élite: il caso di Laus. In: Ciappi S, Diani MG, Ubaldi M, editors. *XVIII Giornate nazionali di studio sul vetro. Vetro e Alimentazione* (Pavia, 16–17 maggio 2015). Cremona: Fantigrafica; 2017. p. 161–6.
 35. Sannazaro M, Lusuardi Siena S, Giostra C, Ubaldi M. Manufatti del quotidiano: pietra ollare, ceramiche e vetri tra VIII e XIII secolo. In: Sannazaro M, Lusuardi Siena S, Giostra C, editors. *1287 e dintorni. Ricerche su Castelseprio a 730 anni dalla distruzione.* Quingentole: SAP Società Archeologica s.r.l.; 2017. p. 129–59.
 36. Ubaldi M, Verità M. Scientific analyses of glasses from Late Antique and Early Medieval archaeological sites in Northern Italy. *J Glass Stud.* 2003;45:115–37.
 37. de Luca I. La Domus del Foro di Nerva Le fasi di vita (IX–X secolo). In: Arena MS, Delogu P, Paroli L, Ricci M, Sagui L, Vanditelli L, editors. *Roma dall'antichità al Medioevo. Archeologia e storia nel Museo Nazionale della Crypta Balbi.* Roma: Electa; 2001. p. 578–9.
 38. Freestone IC. Apollonia glass and its markets: an analytical perspective. In: Tal O, editor. *Apollonia-Arsuf final report of the excavations. Volume II. Excavations outside the Medieval town walls 2020.* p. 341–8.
 39. Freestone IC, Degryse P, Lankton J, Gratuze B, Schneider J. HIMT, glass composition and commodity branding in the primary glass industry. In: Rosenow D, Phelps M, Meek A, Freestone I, editors. *Things that Travelled. Mediterranean Glass in the First Millennium CE 2018:* 159–190.
 40. Schibille N. Islamic glass in the making. Chronological and geographical dimensions. Leuven: Leuven University Press; 2022.
 41. Paynter S, Jackson C. Clarity and brilliance: antimony in colourless natron glass explored using Roman glass found in Britain. *Archaeol Anthropol Sci.* 2019;11(4):1533–51.
 42. Jackson CM. Making colourless glass in the Roman period. *Archaeometry.* 2005;47:763–80.
 43. Jackson CM, Paynter S. A great big melting pot: exploring patterns of glass supply, consumption and recycling in Roman Coppergate, York. *Archaeometry.* 2016;58:68–95. <https://doi.org/10.1111/arc.12158>.
 44. Freestone IC. The recycling and reuse of Roman glass: analytical approaches. *J Glass Stud.* 2015;57:29–40.
 45. Schibille N, Sterrett-Krause A, Freestone IC. Glass groups, glass supply and recycling in late Roman Carthage. *Archaeol Anthropol Sci.* 2017;9:1223–41.
 46. Brems D, Degryse P. Trace elements in sand raw materials. In: Degryse P, editor. *Glass Making in the Greco-Roman world. Results of the ARCH-GLASS Project.* Leuven: Leuven University Press; 2014. p. 69–86.
 47. Cholakova A, Rehren T, Freestone IC. Compositional identification of 6th c. AD glass from the Lower Danube. *J Archaeol Sci Rep.* 2016;7:625–32.
 48. Cholakova A, Rehren T. A late antique manganese decolourised glass composition: interpreting patterns and mechanisms of distribution. In: Rosenow D, Phelps M, Meek A, Freestone I, editors. *Things that travelled. Mediterranean glass in the first Millennium AD.* London: UCL Press; 2018. p. 46–71.
 49. Foy D, Picon M, Vichy M, Thirion Merle V. Caractérisation des verres de la fin de l'Antiquité en Méditerranée occidentale: l'émergence de nouveaux courants commerciaux. In: Foy D, Nenna M-D, editors. *Échanges et commerce du verre dans le monde antique: actes du colloque de l'Association française pour l'Archéologie du verre, Aix-en-Provence Marseille, 7–9 juin 2001.* Éditions Monique Mergoil; 2003.
 50. Schibille N, Neri E, Ebanista C, Ammar MR, Bisconti F. Something old, something new: the late antique mosaics from the catacomb of San Gennaro (Naples). *J Archaeol Sci Rep.* 2018;20:411–22. <https://doi.org/10.1016/j.jasrep.2018.05.024>.
 51. Ceglia A, Cosyns P, Schibille N, Meulebroeck W. Unravelling provenance and recycling of late antique glass from Cyprus with trace elements. *Archaeol Anthropol Sci.* 2019;11:279–91.
 52. De Juan Ares J, Vigil-Escalera Guirado A, Cáceres Gutiérrez Y, Schibille N. Changes in the supply of eastern Mediterranean glasses to Visigothic Spain. *J Archaeol Sci.* 2019;107:23–31. <https://doi.org/10.1016/j.jas.2019.04.006>.
 53. Silvestri A, Molin G, Salvulo G. The colourless glass of Iulia Felix. *J Archaeol Sci.* 2008;35(2):331–41.
 54. Paynter S, Kearns T, Cool H, Chenery S. Roman coloured glass in the West-ern provinces: the glass cakes and tesserae from West Clacton in England. *J Archaeol Sci.* 2015;62:66–81.
 55. Balvanović RV, Šmit Ž. Emerging glass industry patterns in late antiquity Balkans and beyond: new analytical findings on Foy 3.2 and Foy 2.1 glass types. *Materials.* 2022;15:1086.
 56. Balvanović R, Šmit Ž. Sixth-century AD glassware from Jelica, Serbia—an increasingly complex picture of late antiquity glass composition. *Archaeol Anthropol Sci.* 2020;12:1–17.
 57. Stojanović MM, Šmit Ž, Glumac M, Mutić J. PIXE-PIGE investigation of roman imperial vessels and window glass from Mt Kosmaj, Serbia (Moesia Superior). *J Archaeol Sci Rep.* 2015;1:53–63.
 58. Boschetti C, Lichtenberger A, Raja R, Wootton W, Schibille N. Loose glass tesserae and lost decorations: chronology and production of mosaics from Gerasa's Northwest Quarter. *Archaeometry.* 2021;63:960–74. <https://doi.org/10.1111/arc.12654>.
 59. Boschetti C, Leonelli C, Rosa R, Romagnoli M, Ángel M, Tévar V, et al. Preliminary thermal investigations of calcium antimonate opacified white glass tesserae. *Heritage.* 2020;2:549–60.
 60. Boschetti C, Henderson J, Evans J, Leonelli C. Mosaic tesserae from Italy and the production of Mediterranean coloured glass (4 century BCE–4 century CE). Part I: Chemical composition and technology. *J Archaeol Sci Rep.* 2016;7:303–11. <https://doi.org/10.1016/j.jasrep.2016.05.006>.
 61. Gratuze B, Pactat I, Schibille N. Changes in the signature of cobalt colorants in late antique and early Islamic glass production. *Minerals.* 2018;8:225.
 62. Boschetti C, Gratuze B, Cavalieri M, Lenzi S, Schibille N. Production or consumption? Glass beads from the Roman Villa of Aiano, Tuscany. *Eur J Archaeol.* 2022;25(2):196–215.
 63. Whitehouse D. Glass in the epigrams of Martial. *J Glass Stud.* 1999;41:73–81.
 64. Lopreato P, Iulia Felix. La nave romana di Grado. *Antich Altoadriatiche.* 1993;60:271–7.

65. Wardle A, Freestone I, McKenzie M. Glass working on the margins of Roman London: excavations at 35 Basinghall Street, City of London, 2005. London: MOLa (Museum of London Archaeology); 2015.
66. Boschetti C, Mantovani V, Leonelli C. Glass coloring and recycling in late antiquity: a new case study from Aquileia (Italy). *J Glass Stud.* 2016;58:69–86.
67. Molinari A. La produzione artigianale a Roma tra V e XV secolo. Riflessioni sui risultati di uno studio archeologico sistematico e comparativo. In: Molinari A, SantangeliValenzani R, Spera L, editors. *L'archeologia della produzione a Roma (secoli V-XV) Atti del Convegno Internazionale di Studi* (Collection l'École Française Rome). Roma: Edipuglia; 2014. p. 613–35.
68. Sebastiani A, Derrick TJ. A Regional economy of recycling over four centuries at Spolverino (Tuscany) and environs. In: Duckworth CN, Wilson A, editors. *Recycling and reuse in the Roman Economy*. Oxford: Oxford University Press; 2020. p. 359–82.
69. Cavalieri M. Investigating Transformations through Archaeological Records in the Heart of Tuscany. The Roman Villa at Aiano between Late Antiquity and the Early Middle Ages. In: Cimadomo P, Palermo R, Pappalardo R, Pierobon Benoit R, editors. *Before/After. Transformation, change, and abandonment in the Roman and Late Antique Mediterranean*. Oxford: Access Archaeology; 2020. p. 97–113.
70. Gelichi S, Grandi E, Negrelli C, editors. *Un emporio e la sua cattedrale: gli scavi di piazza XX Settembre e Villaggio San Francesco a Comacchio*. Firenze: All'insegna del Giglio; 2021.
71. Schibille N, Freestone IC. Composition, production and procurement of glass at San Vincenzo al Volturno: an early medieval monastic complex in southern Italy. *PLoS ONE.* 2013;8(10):e76479.
72. Ghiretti A. Il ritrovamento delle tessere musive. In: Ghiretti A, editor. *Alla scoperta della Cisa Romana. Scavi archeologici alla Sella del Valoria (2012–2015)*. Parma: Grafiche Step Editrice; 2017. p. 41–8.
73. Crocco R, Huisman H, Sablerolles Y, Henderson J, van Os B, Nieuwhof A. Hunting colours: origin and reuse of glass tesserae from the Wierum terp. *Archaeol Anthropol Sci.* 2021;13:1–22.
74. Bertini C, Henderson J, Chenery S. Seventh to eleventh century CE glass from Northern Italy: between continuity and innovation. *Archaeol Anthropol Sci.* 2020;12:1–23.
75. Neri E, Schibille N, Pellegrino M, Nuzzo D. A Byzantine connection: Eastern Mediterranean glasses in medieval Bari. *J Cult Herit.* 2019;38:253–60. <https://doi.org/10.1016/j.culher.2018.11.009>.

Publisher's Note

Springer Nature remains neutral with regard to jurisdictional claims in published maps and institutional affiliations.

Submit your manuscript to a SpringerOpen® journal and benefit from:

- Convenient online submission
- Rigorous peer review
- Open access: articles freely available online
- High visibility within the field
- Retaining the copyright to your article

Submit your next manuscript at ► [springeropen.com](https://www.springeropen.com)
