



**HAL**  
open science

# Influence of the Physical Interface on the Quality of Human–Exoskeleton Interaction

Dorian Verdel, Guillaume Sahn, Simon Bastide, Olivier Bruneau, Bastien Berret, Nicolas Vignais

► **To cite this version:**

Dorian Verdel, Guillaume Sahn, Simon Bastide, Olivier Bruneau, Bastien Berret, et al.. Influence of the Physical Interface on the Quality of Human–Exoskeleton Interaction. IEEE Transactions on Human-Machine Systems, 2022, 10.1109/THMS.2022.3175415 . hal-03689018

**HAL Id: hal-03689018**

**<https://hal.science/hal-03689018>**

Submitted on 6 Jun 2022

**HAL** is a multi-disciplinary open access archive for the deposit and dissemination of scientific research documents, whether they are published or not. The documents may come from teaching and research institutions in France or abroad, or from public or private research centers.

L'archive ouverte pluridisciplinaire **HAL**, est destinée au dépôt et à la diffusion de documents scientifiques de niveau recherche, publiés ou non, émanant des établissements d'enseignement et de recherche français ou étrangers, des laboratoires publics ou privés.

# Influence of the physical interface on the quality of human-exoskeleton interaction

Dorian Verdel , Guillaume Sahn, Simon Bastide , Olivier Bruneau , Bastien Berret , Nicolas Vignais 

**Abstract**—Despite exoskeletons becoming widespread tools in industrial applications, the impact of the design of human-exoskeleton physical interfaces has received little attention. The present study aims at thoroughly quantifying the influence of different physical human-exoskeleton interfaces on subjective and objective biomechanical parameters. To this aim, 18 participants performed elbow flexion/extension movements while wearing an active exoskeleton with three different physical interfaces: a strap without any degree of freedom, a thermoformed orthosis with one (translation) and three degrees of freedom (translation and rotations). Interaction efforts, kinematic parameters, electromyographic activities and subjective feelings were collected and examined during the experiment. Results showed that increasing the interaction area is necessary to improve the interaction quality at a subjective level. The addition of passive degrees of freedom allows significant improvements on both subjective and objective measurements. Outcomes of the present study may provide fundamental insights to select physical interfaces when designing future exoskeletons.

**Index Terms**—Exoskeleton design, Human-exoskeleton interaction, Physical interfaces, Self-aligning mechanism

## I. INTRODUCTION

Active exoskeletons are promising devices for multiple health and occupational applications and their potential benefits have been examined through numerous studies since the first models of exoskeletons were developed in the late 1960s. In particular, their potential benefits in terms of preventing musculoskeletal disorders [1], [2], [3], [4] and fatigue [5], [6] have been thoroughly investigated in the recent literature. However, exoskeletons are still significantly altering human motor control and these potential benefits are not yet fully achieved. Transparency can be defined as the ability of an exoskeleton to affect as little as possible the human movement [7] both in terms of trajectories and in terms of muscular synergies and muscle activities [8]. Even though reaching a perfect transparency (i.e. null interaction forces [9] between the exoskeleton and the user) is impossible [10], [11], getting as near as possible to this situation is desirable for numerous applications [12]. Currently, the simple fact of wearing an exoskeleton in "transparent" mode still generates undesired

modifications of the human movement. In particular, a decrease in movement velocity [13], [14] and an increase in the muscular activity of the muscle groups that are not directly targeted by the exoskeleton [6] are amongst the basic issues that are still encountered. Furthermore, a reduction in the movement's relative efficiency [15], [16] has been observed and comfort issues [2] have been reported.

Some of these problems are rooted in the very way exoskeletons have been designed. Indeed, the major importance given to the quantification of human motor control alterations in the evaluation of the human-exoskeleton interaction quality is quite recent [11], [17], [18], [19]. The first step towards this symbiotic interaction is to reach the highest possible level of "transparency", considered as a baseline condition prior to the implementation of more advanced assistive strategies. To quantify transparency on the basis of objective parameters, previous studies inspired by the human motor control literature [13], [16] focused on simple arm movements, i.e. implying one degree of freedom, as it has been commonly studied in this area [20], [21], [22].

The transparency of active exoskeletons can be improved through two main methods: through control laws and through the mechanical design of the exoskeleton [23]. Significant improvements have already been achieved by improving control laws, in particular by introducing prediction features [10], by constructing adapted control architectures [23] and by improving the dynamic identification procedures [16]. In terms of mechanical design, traditional methods have focused on the internal transmission design to improve backdrivability and compliance [24], [25].

Another approach is to design compliant, self-aligning, human-exoskeleton interfaces (HEIs). This approach is motivated by the joint misalignments (JM) that inevitably occur when wearing an exoskeleton [11], [26], [27]. Compensating for these JM to prevent the appearance of unwanted interaction efforts is the main objective. It should be noted that improving the design of the HEIs not only has an impact on transparency, but also on the quality of human-exoskeleton interaction in general. Transparency is, however, an ideal framework to study these interfaces because the interaction forces are supposed to be minimized, so the measured forces are all unwanted residual forces. This approach has been studied from a theoretical point of view by geometric modeling [28], [29] and by a more general modeling relying on the theory of mechanisms [11]. These theories have led to the design of numerous self-aligning interfaces for the major joints of the upper and lower limbs. For the knee, a compact solution based on a passive rotation and a passive translation [30] and a more complex solution

Manuscript received xxx; revised xxx.

D. Verdel, G. Sahn, S. Bastide, N. Vignais and B. Berret were with the CIAMS, Université Paris-Saclay, 91405 Orsay, France and with the CIAMS, Université d'Orléans, Orléans, France. Corresponding e-mail: dorian.verdel@universite-paris-saclay.fr.

O. Bruneau was with the LURPA, ENS Paris-Saclay, 91190 Gif-sur-Yvette, France.

B. Berret was with the Institut Universitaire de France, Paris, France.

This work is supported by the "IDI 2017" project funded by the IDEX Paris-Saclay, ANR-11-IDEX-0003-02. This work is supported by the French National Agency for Research (grant ANR-19-CE33-0009).

based on a five-bar mechanism [31] have been proposed. For the hip, solutions of various complexity ranging from two passive degrees of freedom [32], [33] (on both active and non-motorized exoskeletons) to nine passive degrees of freedom [34] have been proposed. Furthermore, a solution decoupling rotation and translation joints has been introduced [35] for the shoulder (see [36] for a review on shoulder exoskeleton design strategies aiming to align robot and human joints without modifying interfaces). Several solutions have also been proposed to compensate for the elbow JM, which is the focus of the present study. In particular, a first solution based on a passive rotation parallel to the elbow axis and a passive translation along the exoskeleton forearm has been proposed [37]. A second solution introducing a ball joint allowing three passive rotations of the interface instead of one, while keeping the same passive translation as the first solution, has also been suggested [11]. All the previous solutions have led to significant reductions of unwanted interaction forces. Concerning the elbow joint, introducing only one passive rotation [37] seems to be an incomplete solution. Indeed, variations in the orientation of the rotation axis of the elbow during flexion have been reported in [38], which might have an influence on joint misalignments and therefore on the kinematic compatibility between the user and the exoskeleton. The design introduced in [11] seems to be promising but has not been systematically investigated in terms of interaction forces, kinematics, muscular activities and subjective feeling of participants. Furthermore, these studies [11], [37] suggested that increasing the interaction area should result in lower interaction pressures, which is a critical factor in terms of perceived comfort [37]. To our knowledge, the impact of larger contact surfaces has not been thoroughly studied either. Therefore, the present study aims at providing a systematic comparison of different HEIs, including passive degrees of freedom or not, and at quantifying the impact of a thermoformed orthosis to maximize the interaction area.

The present study is organized as follows: in Section II, participants and materials (Section II-A), experimental procedure (Section II-B), data processing (Section II-C) and statistical analyses (Section II-D) used to assess the impact of the different HEIs are introduced. In Section III, the results obtained from both objective (Sections III-A and III-B) and subjective measurements (Section III-C) are presented. These results are then discussed in Section IV.

## II. METHODS

### A. Participants and materials

*a) Participants:* The experimentations were conducted on 18 healthy right-handed participants (11 females and 7 males). Anthropometric characteristics of the participants were the following: age  $25 \pm 6$  years old, height  $171.9 \pm 7.9$  cm, weight  $64.8 \pm 11$  kg, arm length  $28.6 \pm 2.8$  cm, forearm length  $25.3 \pm 1.8$  cm and hand length  $19.2 \pm 1.3$  cm. The length of the arm was measured between the acromion and the epicondyle of the elbow, the length of the forearm was measured between the epicondyle of the elbow and styloid process of the ulna and the length of the hand was measured between the styloid process of the radius and the tip of the

middle finger. The experimental protocol was approved by the ethical committee for research (CER-Paris-Saclay-2021-048) and the written consent of participants was obtained as required by the Helsinki declaration [39].

*b) ABLE exoskeleton:* The present study was performed with an ABLE active upper-limb exoskeleton (see Figure 1a) which includes four actuated joints. This robot was designed to be highly backdrivable and compliant in order to maximize the human-exoskeleton symbiosis [24], [25].

As previously motivated, in the present study, only motions involving elbow flexion/extension have been used. A slider moving along the forearm segment of the robot, thereby allowing a passive translation motion of the human-exoskeleton interface, has been added to prevent the occurrence of hyperstatic forces at the level of the connection between ABLE and the user [11]. In addition to the conventional real-time measurements of motor positions obtained by incremental encoders, a Force-Torque (FT) sensor (1010 Digital FT, ATI©, maximum sample rate: 7 kHz) was added at the interface between ABLE and the user (see Figure 1a). This FT sensor allows to measure the 6 components of the interaction efforts: three forces  $F_x$ ,  $F_y$ ,  $F_z$  and three torques  $\tau_x$ ,  $\tau_y$ ,  $\tau_z$  respectively acting along and around  $\mathbf{x}_s$ ,  $\mathbf{y}_s = \mathbf{z}_s \times \mathbf{x}_s$  and  $\mathbf{z}_s$  (see Figure 1b for axis definitions). The exoskeleton transparent control is based on an accurate identification of its dynamic parameters and on a feedback loop using the FT sensor measurements [15], [16] as presented in Figure 2.

*c) Tested interfaces:* The first tested HEI (Figure 1b, top) is composed of a strap coupled to a splint as detailed in Section II-B and the slider allowing a translation of the human forearm with respect to the exoskeleton is blocked with 3D printed parts. This interface is used as a baseline condition (referred to as "BAS" in the rest of the present paper) as it reflects the design of the majority of current exoskeletons. As described in Section II-B and illustrated in Figure 1b, a light splint was used to ensure that participants cannot use their wrist. This splint does not modify the distribution of interaction forces because the only rigid part it contains is not in contact with the exoskeleton. The only mechanical effect it could possibly introduce is a slight decrease in the pressures felt due to the thickness of the tissue. Therefore, this condition remains comparable to what exists on most exoskeletons.

The other HEIs tested (Figure 1b, bottom) are based on a thermoformed orthosis (Ort.) that can be deformed to ensure the best possible fit for the participant's forearm and palm of the hand and increase the interaction area. This orthosis is placed on two passive joints that enable it to rotate around the axes  $\mathbf{y}_s$  and  $\mathbf{z}_s$ , which  $\mathbf{x}_s$  supported by the exoskeleton forearm (see Figure 1b). These joints can be mechanically locked with screws. Therefore, two conditions are tested with this orthosis: the first one (called "ORT\_T" in the rest of the present paper) only includes the passive translation enabled by the slider and the second one (called "ORT\_R" in the rest of the present paper) includes both the passive translation enabled by the slider and the two passive rotations enabled by the HEI joints.

*d) Human-exoskeleton interaction measurements:* Kinematic features of the human movement were measured by means of 10 infrared cameras (Oqus 500+, Qualisys optoelec-

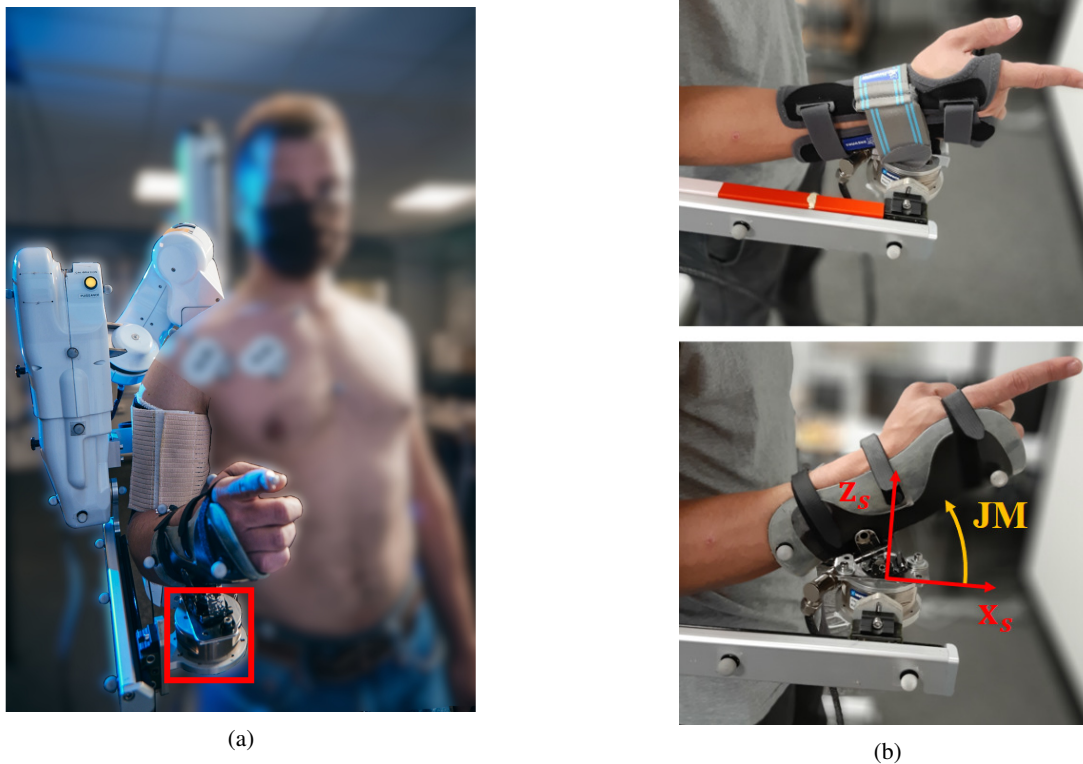

Figure 1: Robot and experimental set-up. (a) ABLExoskeleton used in the present study, the FT sensor is the part in the red square. (b) Physical human-exoskeleton interfaces (top: BAS HEI, bottom: ORT\_T and ORT\_R HEIs, reference frame and an example of JM). This JM is produced by the differences between the human elbow and robot elbow positions. These position differences create both angular misalignments as illustrated (they have proven to be particularly impacting when trying to apply an accurate force on the user [40]) or bending effort ( $\tau_y$  in our case). They also induce either a varying distance between the robot elbow and the physical interface (if a slider is present) or shear effort ( $F_x$  in our case) along the human forearm while moving [11], [37].

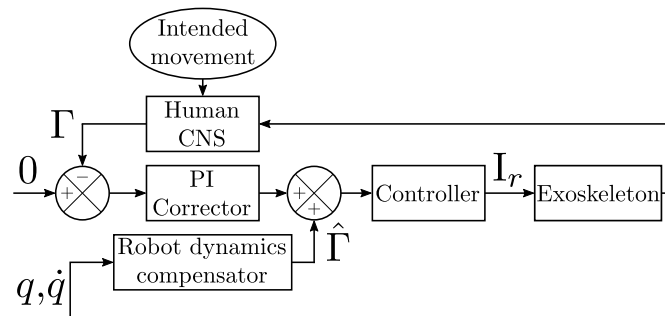

Figure 2: Exoskeleton control [15].

tronic system, Göteborg, Sweden ©) at 179 Hz, twenty-two 10 mm reflective markers (14 on the exoskeleton and the HEI and 8 on the participant) and a 3 mm reflective marker at the tip of the index finger. The eight 10 mm reflective markers were placed as follows: base of the index finger, styloid process of the radius (given the position of the participant in the exoskeleton, it was not possible to place a marker on the styloid process of the ulna to track the wrist), middle of the forearm, two on the elbow (Epicondyle and Epitrochlea), Acromion, clavicle at the level of the sternoclavicular joint

and solar plexus. The interaction efforts (forces and torques) were measured by the FT sensor previously introduced.

e) *Electromyographic measurements*: The muscular activity of participants was measured by means of four electromyographic sensors (EMGs) (Wave Plus wireless EMG system, Cometa, Italy). As only elbow flexion/extension were performed in the present study, two of these four sensors were placed on the flexors of the elbow: one on the biceps brachii and one on the brachio radialis and the two others were placed on the extensors of the elbow: one on the long head and one on the lateral head of the triceps brachii. These sensors were placed as recommended by the SENIAM [41]. The participant's skin was first shaved locally and then cleaned with alcohol. The electrodes were then placed approximately two-thirds of the way down the muscle.

f) *Individual feeling questionnaire*: In addition to the objective measurements previously introduced, the subjective feelings of participants were collected through a semi-directed questionnaire inspired from previous studies [42], [43]. This questionnaire was composed of the following six questions (3 focusing on comfort, 2 focusing on the ability to move with the HEI and 1 focusing on the perceived performance in terms of accuracy):

- Comfort:

- Did you feel any friction or irritation during the movement?
- Did you experience any pressure points at the level of the HEI?
- Rate the general comfort of movement of the HEI.
- Ability to move:
  - Rate the level of mobility at the level of the HEI.
  - Rate the perceived global motion range.
- Accuracy: Rate the perceived precision level that you were able to achieve with the HEI.

For each of these questions, participants were asked to give a grade between 1 (if they completely agreed with a bad behavior or completely disagreed with a good behavior) and 5 (if they completely disagreed with a bad behavior or completely agreed with a good behavior).

### B. Motor task

As previously explained, participants were asked to perform movements of flexion/extension of the elbow. Four conditions were tested, each one during one block of movements, the first block was the No Exoskeleton condition (identified as NE in the rest of the present paper) and serves as a baseline measurement for future comparisons. The three following blocks were performed in the exoskeleton with the different HEI presented in Section II-A. The order of these three blocks was randomized. During NE and BAS blocks, the participants were carrying a 400 g mass to compensate for the weight of the thermoformed orthosis, thereby allowing a more meaningful comparison of the different HEI. Participants pointed to the targets with their index finger while grasping the mass with their other fingers. During the conditions using the thermoformed orthosis, ORT\_T and ORT\_R, participants were asked to also point to the targets with their index finger while grasping the orthosis with their other fingers. Pre-tests in a resting position showed no differences in the recorded muscular activation between grasping the mass and grasping the orthosis. For the same comparison purpose, they were also wearing a splint during these two blocks to prevent unintended movements of the wrist, in the same way as with the thermoformed orthosis conditions. Each block consisted of 30 movements (15 flexions and 15 extensions) with an amplitude of 60 degrees that was chosen with respect to previous studies on this exoskeleton [13], [16]. The starting and ending points of the movement were represented by two LED that were successively lit. The LEDs were placed approximately 3 cm away from the tip of the index finger when pointing, to avoid any collision while allowing visual feedback. They were also adjusted in height so that the movement was symmetrical with respect to a horizontal line crossing the elbow of the participant. Each lighting period lasted  $4 \pm 0.5$  seconds (to prevent the participants from anticipating the lighting of the next LED) and participants were asked to finish their movement before the LED turns off. A three-minute break was taken between each block to avoid fatigue effects. At the end of the five blocks, the participants were asked to answer the questionnaire presented in Section II-A.

### C. Data analysis

a) *Robot measurements*: The angular positions of the elbow are measured by means of internal encoders and filtered with a low-pass filter (Butterworth, fifth-order, 5 Hz cut-off frequency). The angular velocities and accelerations are estimated through numerical differentiation. The estimated velocity is filtered with a low-pass filter (Butterworth, fifth-order, 5 Hz cut-off frequency) before the angular acceleration estimation. These data are only recorded and estimated to ensure that data from the robot and from the motion capture device are coherent. The interaction efforts are measured at 1 kHz with the FT sensor introduced in Section II-A. The maximum interaction efforts analyzed in Section III-A are defined as the maximum absolute values measured during each movement on each component of the FT sensor. These values are then averaged for each participant and each condition separately.

b) *Motion capture measurements*: The positions measured by the motion capture device are filtered by means of a low-pass filter (Butterworth, fifth-order, 5 Hz cut-off frequency). Then, the velocities and accelerations are estimated by numerical differentiation. Motion intervals are defined as 5% of the peak velocity of each movement. To quantify local alterations at the end of the human movement, the relative time to peak deceleration ( $rt_{PD}$ ), analyzed in Section III-B, is computed as presented in Equation (1),

$$rt_{PD} = \frac{t_{PD}}{D} \quad (1)$$

where,  $t_{PD}$  is the time to peak deceleration and  $D$  is the duration of the movement.

c) *Electromyographic measurements*: A band-pass filter (Butterworth, fourth order, [20, 450] Hz cut-off frequencies) is applied on the EMG signals [44]. They are then centered, rectified and normalized by the maximal value of the measured muscular activity during the whole experiment for each subject and each muscle [13], [40]. The envelope of the signals is determined by applying a low-pass filter (Butterworth, fifth order, 3 Hz cut-off frequency) as recommended by previous studies [44].

The Root Mean Square (RMS) of the signal is computed over each movement and is used to represent the amount of muscular activation used by the participants. The activity of extensors is computed as the averaged activities of the triceps brachii long and lateral heads. The activity of flexors is computed as the averaged activities of the brachio-radialis and the biceps brachii [13], [16].

d) *Movement efficiency*: The movement relative efficiency can be defined as a ratio between the peak acceleration and the RMS of the agonist muscles, normalized by the same ratio obtained in the NE condition [16]. This ratio can indeed be seen as an efficiency index because the activation of the agonist muscles is related to the resulting acceleration and any change in the nominal value of this ratio would be attributed to a lack of transparency of the exoskeleton, all other factors being unchanged [45]. This is summarized in Equation (2),

$$EMG/A_{CC} = \frac{PA_{NE}}{RMS_{ag,NE}} \left( \frac{RMS_{ag}}{PA} \right) - 1 \quad (2)$$

where  $RMS_{ag}$  is the mean RMS activation of the agonist muscles, PA is the peak acceleration of the movement and  $RMS_{ag,NE}/PA_{NE}$  is the same ratio obtained with the NE condition. When this index is equal to 0, it means that the so-defined movement efficiency is the same as for a NE condition, when this index is greater than 0, it means that the so-defined movement efficiency is reduced. The case lower than 0 should not happen in the present study as it would mean that the exoskeleton is providing movement assistance without this being one of its objectives. This index can only be computed for upward movements in transparent mode because self-paced downward movements result more from the deactivation of the flexors than from the activation of the extensors [46], [16], which makes this index less relevant in this case.

#### D. Statistical analysis

For all the parameters analyzed in Section III, the descriptive and inferential statistical analyses were performed as follows: participants' averaged values of every parameter were computed so that the resulting variability was between participants and normality (*Shapiro-Wilk* test) and sphericity (*Mauchly's* test) of the values distribution were verified. Then, a repeated measurements ANOVA was applied with a level of significance set at  $p = 0.05$ . If the result was significant, then a pairwise *t*-test comparison was used as post-hoc. The post-hoc *t*-tests were also deemed significant at  $p = 0.05$ . All the statistical analyses are conducted with the Pingouin package [47].

### III. RESULTS

#### A. Effects on interaction efforts

a) *Averaged observations on interaction efforts*: The interaction efforts are the first focus of the present paper because, as hyperstatism is a geometric problem, their evolution is the origin of the modifications observed on kinematics in Section III-B. The averaged evolution of the different interaction forces and torques during upward movements is illustrated in Figure 3. Only upwards movement have been described in Figure 3 because the problem of the hyperstatism of the closed human-exoskeleton chain is a geometric problem [11], which means that describing the upward movements is sufficient to describe the overall evolution of the interaction forces. Thus similar observations were made for downward movements. The maximum values of the interaction efforts are given in Table I.

b) *Statistics on interaction efforts*: The results of the different ANOVAs performed on the maximum of the absolute value of interaction efforts reached are given in Table I. This maximum interaction effort is an interesting parameter because it is directly linked to the maximum pressure inflicted on participants, which has been shown to be an important parameter to improve human-exoskeleton interaction [37].

The results given in Table I reveal that the ANOVA conducted on  $\tau_x$  is the only one that is not significant, which is coherent with the averaged observations. The results of the subsequent post-hoc analyses are compiled in Table II. These analyses show that  $F_x$  is 3 times greater in the BAS

condition than in the other conditions, thereby showing that the exoskeleton applies more shear effort along the human segment in this condition. Furthermore, they show that  $\tau_y$  is on average 3.7 greater and  $\tau_z$  is on average more than 10 times greater in the ORT\_T condition than in the other two conditions. They also show that  $\tau_y$  is on average 1.7 greater in the BAS condition than in the ORT\_R condition, thereby showing that the exoskeleton applies more bending torques under the ORT\_T and BAS conditions. Eventually, the analyses show that the interaction efforts are overall lower in the ORT\_R condition than in the other two conditions.

#### B. Effects on kinematics and muscular activity

a) *Effects on kinematics*: The first point of interest in this Section is the analysis of human trajectories through the shape of the different obtained profiles to quantify any modifications of the kinematics with the different used HEI. This will also allow to ensure that the known characteristics of point-to-point reaching movements are still present with the different HEIs. In particular, velocity profiles should be bell-shaped as it is a very-well known characteristic of human motion that is normally conserved when wearing a transparent exoskeleton [13], [16]. The averaged upward trajectories are described in Figure 4. The averaged peak velocities (PV) and peak accelerations (PA), that are classical descriptors of human movement [14], are illustrated in Figure 5 for upward movements.

The ANOVAs conducted on PV and PA were both significant (see Figure 5) and the post-hoc comparisons both led to the conclusion that participants were significantly slower when using the BAS and ORT\_T HEIs than in the NE condition (PV : BAS vs NE :  $p < 0.05$ , ORT\_T vs NE :  $p < 0.05$ ; PA: BAS vs NE :  $p < 0.01$ , ORT\_T vs NE :  $p < 0.01$ ) whereas no significant differences appeared between the NE and ORT\_R conditions. Finally, the BAS and ORT\_T conditions induce an average 30% PV reduction and an average 40% PA reduction when compared to the NE condition.

In addition to these PV and PA modifications, the variations in averaged movement amplitude and in averaged relative time to peak deceleration ( $rt_{PD}$ ) are given in Table III.

The ANOVAs conducted on movement amplitude and  $rt_{PD}$  were both significant as exposed in Table III. In terms of movement amplitude, the ORT\_T condition was significantly different from the NE and the ORT\_R conditions when applying post-hoc comparisons (ORT\_T vs NE :  $p < 0.05$ ; ORT\_T vs ORT\_R :  $p < 0.05$ ) which is coherent with the values given in Table III. The post-hoc comparisons conducted on the  $rt_{PD}$  data showed that only the ORT\_R HEI allowed to conserve a normal deceleration profile as it was the only HEI to induce statistically equivalent behaviors when compared to the NE condition (BAS vs NE :  $p < 0.01$ ; ORT\_T vs NE :  $p < 0.001$ ; ORT\_R vs ORT\_T :  $p < 0.05$ ). It should be noted that in terms of amplitude and  $rt_{PD}$ , the ORT\_T HEI was less efficient and affected more the natural human behavior than the BAS HEI.

b) *Effects on muscular activity*: RMS of the flexors and extensors are presented in Figure 6 for all movements

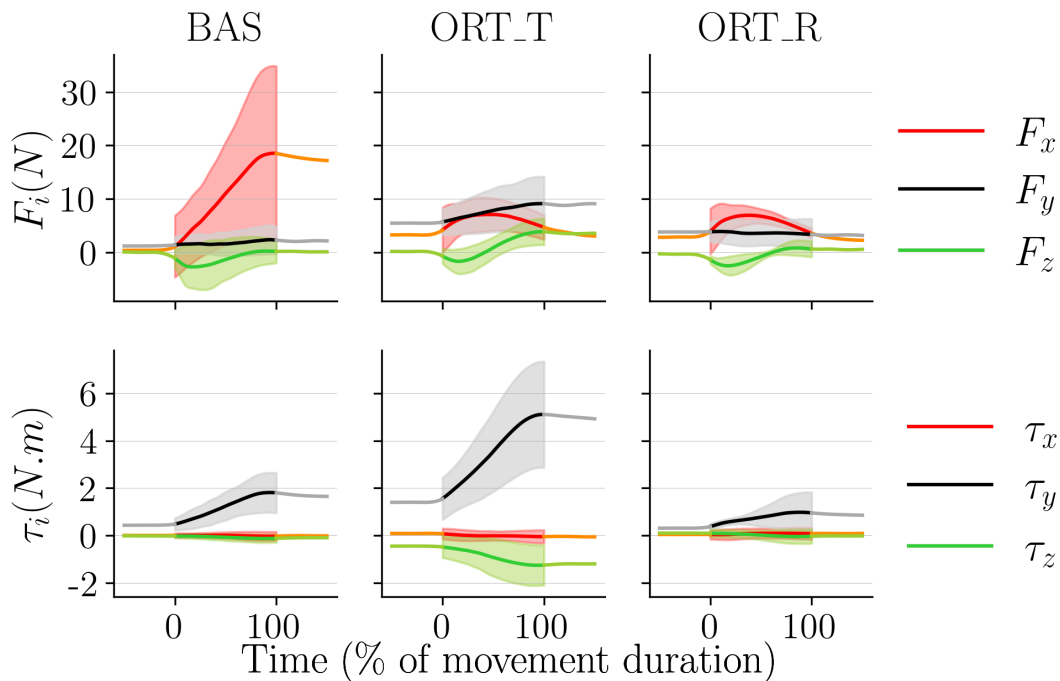

Figure 3: Averaged evolution of the measured interaction efforts during upward movements. The graphs depict the averaged effort evolution and their associated standard deviation as a shaded area.

	Max $F_x$ (N)	Max $F_y$ (N)	Max $F_z$ (N)	Max $\tau_x$ (Nm)	Max $\tau_y$ (Nm)	Max $\tau_z$ (Nm)
BAS	$22.5 \pm 17.3$	$3.7 \pm 1.5$	$2.36 \pm 1.73$	$0.03 \pm 0.2$	$1.9 \pm 0.8$	$0.14 \pm 0.2$
ORT_T	$7.5 \pm 2.7$	$10.2 \pm 5.6$	$4.5 \pm 2.3$	$0.03 \pm 0.5$	$5.3 \pm 2.3$	$1.3 \pm 0.9$
ORT_R	$7.5 \pm 2.2$	$5.8 \pm 2$	$2.46 \pm 1.3$	$0.12 \pm 0.4$	$1.1 \pm 0.9$	$0.02 \pm 0.4$
ANOVAs	$p < 0.001$	$p < 0.001$	$p < 0.001$	$p > 0.05$	$p < 0.001$	$p < 0.001$

Table I: Averaged maximum interaction efforts values and standard deviations obtained with each HEI. Last row gives the level of significance of the repeated measurements ANOVA conducted on each component of the interaction efforts.

	Max $F_x$	Max $F_y$	Max $F_z$	Max $\tau_y$	Max $\tau_z$
BAS vs ORT_T	$p < 0.01$	$p < 0.001$	$p < 0.01$	$p < 0.001$	$p < 0.001$
BAS vs ORT_R	$p < 0.01$	$p < 0.01$	$p < 0.001$	$p < 0.05$	$p > 0.05$
ORT_T vs ORT_R	$p > 0.05$	$p < 0.01$	$p < 0.001$	$p < 0.001$	$p < 0.001$

Table II: Results of post-hoc pairwise comparisons on averaged maximum interaction forces and torques.

	Amplitude (m)	rt <sub>PD</sub>
NE	$0.38 \pm 0.06$	$0.72 \pm 0.13$
BAS	$0.32 \pm 0.09$	$0.8 \pm 0.12$
ORT_T	$0.29 \pm 0.1$	$0.82 \pm 0.12$
ORT_R	$0.37 \pm 0.06$	$0.76 \pm 0.12$
ANOVAs	$p < 0.001$	$p < 0.001$

Table III: Measured movement amplitude and relative time to peak deceleration (rt<sub>PD</sub>) averaged for all movements performed in each condition. Last row gives the level of significance of the repeated measurements ANOVA conducted on these two parameters.

(upward and downward) to obtain an overview of the amount of effort used by participants. Contrary to kinematic and interaction effort data, the EMG measurements are dependent on movement direction, which is why downward movements are also used in the subsequent analyses.

The ANOVAs conducted on flexors and extensors RMS both returned significant differences across conditions (see Figure 6). The post-hoc comparisons performed on flexors RMS show that the BAS and ORT\_T conditions required significantly more flexors activity than the NE condition (BAS vs NE:  $p < 0.05$ ; ORT\_T vs NE:  $p < 0.001$ ) whereas the ORT\_R condition did not. Moreover, the ORT\_T condition required significantly more flexors activity than the ORT\_R condition ( $p < 0.01$ ). The post-hoc comparisons performed on extensors RMS lead to the same conclusions as the ones performed on flexors RMS in terms of significant differences (BAS vs NE:  $p < 0.01$ ; ORT\_T vs NE:  $p < 0.001$ ; ORT\_R vs ORT\_T:  $p < 0.05$ ) and the ORT\_R extensors RMS is also statistically equivalent to the RMS obtained in the NE condition.

c) *Effects on movement efficiency*: The movement efficiency index, as defined in Section II-C, is computed for each

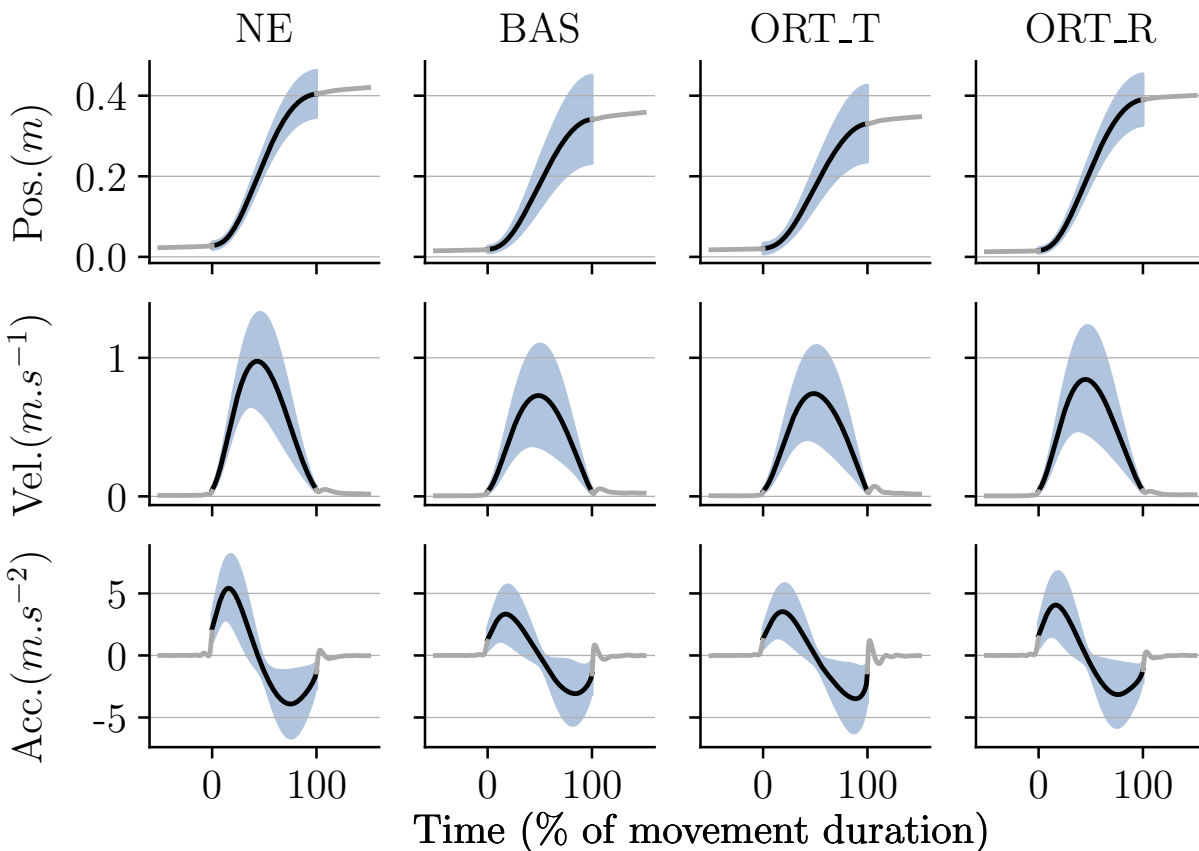

Figure 4: Averaged evolution of the measured trajectories during upward movements. The graphs depict the averaged position, velocity and acceleration evolution in black and their associated standard deviation as a blue shaded area.

condition, which leads to the following averaged results: for the BAS condition, the average movement efficiency index is  $0.86 \pm 0.72$ ; for the ORT\_T condition, it is equal to  $1.55 \pm 0.88$  and for the ORT\_R condition, it is equal to  $0.51 \pm 0.49$ . The ANOVA performed on the efficiency index returns significant differences ( $p < 0.05$ ). The post-hoc comparisons return significant differences between the ORT\_T condition and the two other conditions (ORT\_T vs BAS:  $p < 0.05$  and ORT\_T vs ORT\_R:  $p < 0.01$ ). These analyses show that movement relative efficiency is better in the ORT\_R condition than in the other conditions and that the worst condition in terms of movement relative efficiency is the ORT\_T condition with a division by 3 of the movement efficiency when compared with the ORT\_R condition.

### C. Subjective feeling

The averaged grades obtained by the different HEI for the different questions are presented in Figure 7.

The results of the ANOVAs conducted on the different subjective parameters are given in Figure 7 and show that subjective precision was not impacted by the different conditions. The results of the post-hoc comparisons are compiled in Tables IV. These analyses show that the ORT\_R condition is overall significantly better rated than the two other conditions. They

also show that the differences appearing on averaged values between BAS and ORT\_T are not statistically significant.

## IV. DISCUSSION

a) *Effects on interaction efforts:* Overall, the results presented in Section III-A confirm that the interaction efforts are heavily impacted by the design of the HEI. In particular interaction forces and torques are significantly reduced by introducing a passive translation and two passive rotations. The observed effects are similar to those obtained in previous studies on the elbow [11], [29], [37]. In particular, the magnitudes of the interaction forces and torques obtained in the BAS condition are very similar to those observed previously and their evolution during the movement follows the same trend as in [37]. Furthermore, the great variability observed between participants in the BAS condition is a consequence of the morphological differences between participants as discussed in the existing theoretical studies [11], [29]. The results obtained with the ORT\_T condition show that introducing a thermoformed orthosis, and thereby increasing the interaction area and length alone, does not necessarily reduce unwanted interaction efforts (see Table I). In particular, as the interaction area increases, the lever arms of interaction efforts also increase which generates higher interaction torques around  $y_s$  and  $z_s$ . Therefore, the introduction of a thermoformed orthosis



	Friction/Irritation	Pressure points	General comfort	Mobility	Motion Range
BAS vs ORT_R	$p < 0.001$	$p < 0.01$	$p < 0.01$	$p < 0.001$	$p < 0.001$
ORT_T vs ORT_R	$p < 0.05$	$p < 0.01$	$p > 0.05$	$p < 0.01$	$p < 0.05$

Table IV: Levels of significance of post-hoc pairwise comparisons on average grades given by participants.

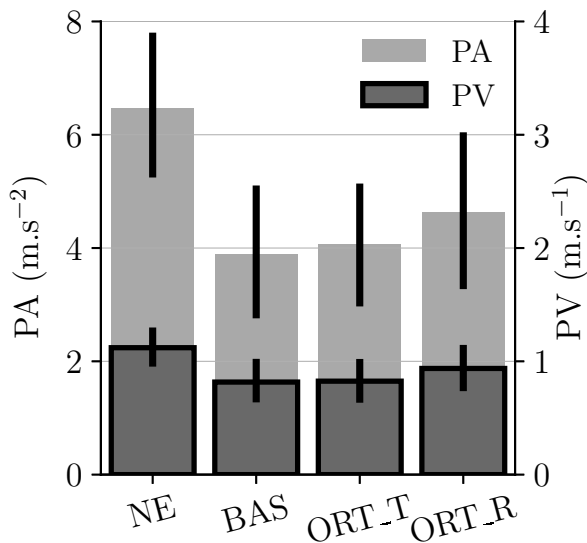

Figure 5: Averaged maximum acceleration and velocity values computed on all participants across all conditions. The repeated measurements ANOVA conducted on peak velocity (PV) was significant ( $p < 0.001$ ), as well as the one conducted on peak acceleration (PA) ( $p < 0.001$ ).

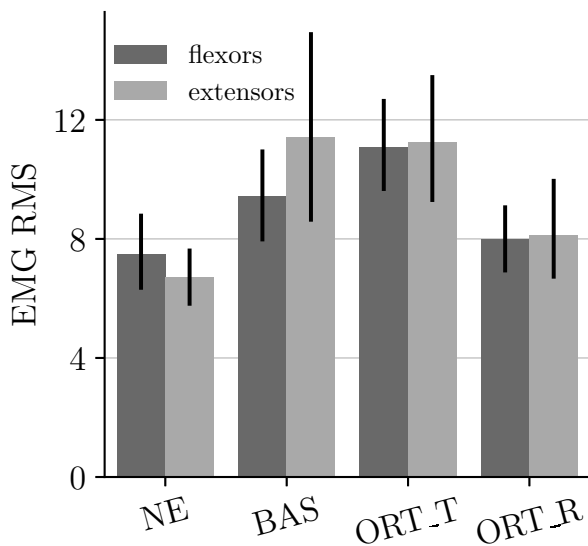

Figure 6: Repartition of the averaged RMS of EMG signals obtained for each condition. The repeated measurements ANOVA conducted on flexors RMS was significant ( $p < 0.01$ ), as well as the one conducted on extensors RMS ( $p < 0.05$ ).

alone generates significantly poorer interaction conditions in

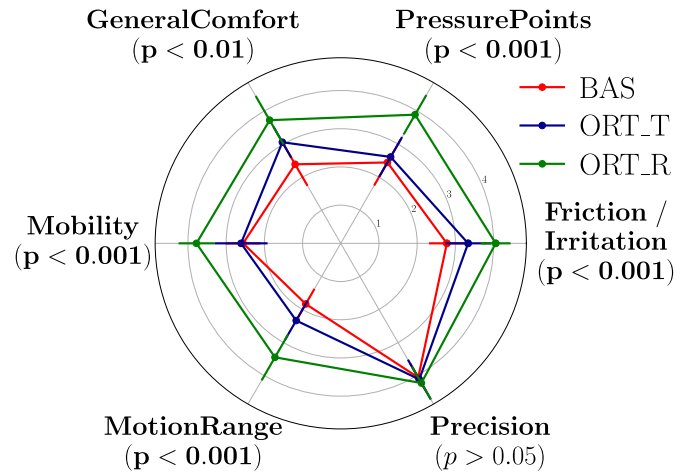

Figure 7: Averaged grades given by participants and level of significance of the repeated measurements ANOVAs.

terms of interaction efforts than a simple strap (see Table II). The introduction of two passive degrees of freedom allowed to significantly reduce these unwanted interaction torques. The obtained results also show that considering only a planar problem as in [29], [37] is not sufficient to minimize interaction torques around  $z_s$ . Furthermore, introducing a rotation around  $x_s$  at the connection level, as in [11], might not be necessary in our framework, despite its necessity from a theoretical point of view. Indeed, the residual interaction torques around  $x_s$  were negligible across all the tested conditions and the ANOVA on their maxima was not significant (see Table I). Finally, the significant increases in maximal interaction forces (see Table I) along  $z_s$  (i.e. the axis considered in the exoskeleton control) with the ORT\_T and the ORT\_R physical interfaces relate to a problem known in the literature. These augmentations are probably due to the increase in inertia when adding a heavier thermoformed orthosis, which was discussed in [26]. This problem can be mitigated by introducing human movement prediction in the exoskeleton control [10]. The last remark that can be done on the interaction efforts is that even with a passive translation, the efforts along  $x_s$  are never completely canceled because of the weight of the moving part.

b) *Effects on kinematics:* One of the first results is the conservation of the global shape of the velocity and acceleration profiles across all the tested HEIs as illustrated in Figure 4. In particular, under the ORT\_R condition, the participants' behavior is not significantly affected in terms of amplitude, PV, PA and  $rt_{PD}$ . These observations are consistent with the low interaction efforts measured under this condition. On the contrary, the behaviors observed under the BAS and ORT\_T conditions were significantly different from the one observed under the NE condition for all the tested parameters. The

effects on PV and PA are probably due to a greater difficulty of movement in general with these two HEIs. Furthermore, the observed differences in terms of amplitude and  $rt_{PD}$  are correlated with the local increase in  $F_x$  with the BAS interface and the local increase in  $\tau_y$  with the ORT\_T interface observed around the upper target. Indeed, both the amplitude reduction and the  $rt_{PD}$  increase reflect that participants are confronted to an important resisting effort around the upper target. The participants seem to have integrated these resisting efforts in their motion planning as they use it to stop their movement (which is illustrated by the increase in  $rt_{PD}$ ). Eventually, the kinematic observations performed during the present study are coherent with the performed interaction efforts measurements as they suggest that the increase of the interaction area without the introduction of passive degrees of freedom can be counter productive. Indeed, the modifications observed in the shape of the acceleration profiles are higher, on average, than with a simple strap. Overall, the decrease in velocity observed with the BAS and ORT\_T conditions is coherent with previous studies [13], [14], thereby demonstrating that a poorly conceived physical interface can cancel improvements obtained through the exoskeleton control [15], [16].

c) *Effects on muscular activity*: The RMS values given in Figure 6, and the corresponding statistics, show clear differences between conditions for both flexors and extensors activity. According to the averaged data, the BAS and ORT\_T HEIs induce movements requiring more muscular activity, the ORT\_T condition requiring even more flexors activity than the BAS condition. These variations further reinforce the previous observations as the ORT\_R condition is the only condition under which participants produced the same amount of muscular activity to perform the movements. Furthermore, these increases in muscular activity occur for conditions that also decrease movement velocity as illustrated in Figure 5. These two results combined show a global deterioration of the movement quality under these two conditions.

The results obtained on the movement efficiency index [16] are coherent with the results obtained on flexors RMS and on PA. Indeed, the ORT\_T HEI is the one inducing the less efficient movements and it was also the one requiring the largest amount of muscular activity with the lowest velocities. Therefore, the motion efficiency calculated for the ORT\_T condition confirmed that an increase in the area of interaction without the inclusion of passive degrees of freedom significantly alters the human movement and is even worse than basic solutions such as straps. The absence of significant differences between the BAS and the ORT\_R conditions in terms of movement efficiency might be due to the fact that the exoskeleton is geometrically adapted to certain participants (i.e. the BAS condition alters less these participants' movement). There is nevertheless a difference in the averaged RMS values that seems coherent with the effects observed on interaction efforts and kinematics. Furthermore, the averaged movement efficiency value obtained in the ORT\_R condition is comparable with the best results obtained in previous works on transparency using this index [15].

Eventually, objective measurements show that an increase in the interaction area, coupled with the introduction of passive

degrees of freedom, significantly improves the quality of the human-exoskeleton interaction. Indeed, with these mechanical solutions, participants performed movements closer to those performed in conditions without an exoskeleton. Nevertheless, these objective results do not allow to conclude that the participants' perception was also improved when using the developed physical interface.

d) *Subjective feeling*: The trend identified with the objective measurements is confirmed in the answers of the participants, indeed, the ORT\_R HEI is significantly better rated by the participants on all the criteria, except subjective precision. What is more surprising is that, despite having the lowest efficiency and the highest energetic cost to move, participants still preferred the ORT\_T HEI to the BAS HEI on average. Nevertheless, no significant differences are found between these two conditions. This suggests that the repartition of interaction efforts on a wider area is sufficient to compensate for the higher energetic cost, thereby confirming the importance of the interaction area in terms of perceived interaction quality [11]. Nevertheless, passive degrees of freedom should be included natively as much as possible in the design of future exoskeletons, despite the fact that their introduction complicates this design.

There are two main limitations in this study. The first is the lack of quantification of the impact of the HEI on more complex motions, which has not been accurately done in the literature either. The second is that it does not provide insight into the effect of multiple HEIs incorporating passive degrees of freedom used simultaneously. Future work could therefore focus on the implementation of several self-aligning HEIs simultaneously and their impact on human-exoskeleton interaction.

## V. CONCLUSION

The present study provides a thorough analysis of the quality of human-exoskeleton interaction with respect to the physical interface used. This analysis led to the conclusion that increasing the interaction area is necessary to improve the interaction quality. Nevertheless, this increase should be contingent on the addition of passive degrees of freedom to allow a self-alignment of the physical interface. This is crucial to be able to exploit its benefits and enhance the overall human-exoskeleton interaction.

## REFERENCES

- [1] R. Bogue, "Robotic exoskeletons: a review of recent progress," *Industrial Robot: An International Journal*, pp. 5–10, Jan. 2015.
- [2] M. P. de Looze, T. Bosch, F. Krause, K. S. Stadler, and L. W. O'Sullivan, "Exoskeletons for industrial application and their potential effects on physical work load," *Ergonomics*, vol. 59, no. 5, pp. 671–681, May 2016.
- [3] C. Latella, Y. Tirupachuri, L. Tagliapietra, L. R. and Benjamin Schirmeister, J. Bornmann, D. Gorjan, J. a. Pauline Maurice, and L. Fritzsche, "Analysis of human whole-body joint torques during overhead work with a passive exoskeleton," *IEEE Transactions on Human-Machine Systems*, pp. 1–9, Dec. 2021.
- [4] N. Sylla, V. Bonnet, F. Colledani, and P. Fraisse, "Ergonomic contribution of ABLE exoskeleton in automotive industry," *International Journal of Industrial Ergonomics*, vol. 44, no. 4, pp. 475–481, Jul. 2014.
- [5] L. M. Mooney, E. J. Rouse, and H. M. Herr, "Autonomous exoskeleton reduces metabolic cost of human walking during load carriage," *Journal of NeuroEngineering and Rehabilitation*, vol. 11, no. 1, p. 80, 2014.

- [6] J. Theurel, K. Desbrosses, T. Roux, and A. Savescu, "Physiological consequences of using an upper limb exoskeleton during manual handling tasks," *Applied Ergonomics*, vol. 67, pp. 211–217, 2018.
- [7] T. Proietti, V. Crocher, A. Roby-Brami, and N. Jarrasse, "Upper-Limb Robotic Exoskeletons for Neurorehabilitation: A Review on Control Strategies," *IEEE Reviews in Biomedical Engineering*, vol. 9, pp. 4–14, 2016.
- [8] E. Pirondini, M. Coscia, S. Marcheschi, G. Roas, F. Salsedo, A. Frisoli, M. Bergamasco, and S. Micera, "Evaluation of the effects of the Arm Light Exoskeleton on movement execution and muscle activities: a pilot study on healthy subjects," *Journal of NeuroEngineering and Rehabilitation*, 2016.
- [9] H. Kim, L. M. Miller, Z. Li, J. R. Roldan, and J. Rosen, "Admittance control of an upper limb exoskeleton - reduction of energy exchange," in *2012 Annual International Conference of the IEEE Engineering in Medicine and Biology Society*, aug 2012.
- [10] N. Jarrasse, J. Paik, V. Pasqui, and G. Morel, "How can human motion prediction increase transparency?" *IEEE International Conference on Robotics and Automation*, pp. 2134–2139, May 2008.
- [11] N. Jarrasse and G. Morel, "Connecting a Human Limb to an Exoskeleton," *IEEE Transactions on Robotics*, vol. 28, no. 3, pp. 697–709, Jun. 2012.
- [12] A. Ajoudani, A. M. Zanchettin, S. Ivaldi, A. Albu-Schäffer, K. Kosuge, and O. Khatib, "Progress and prospects of the human-robot collaboration," *Autonomous Robots*, pp. 957–975, Oct. 2018.
- [13] S. Bastide, N. Vignais, F. Geffard, and B. Berret, "Interacting with a "transparent" upper-limb exoskeleton: a human motor control approach," *IEEE/RSJ International Conference on Intelligent Robots and Systems (IROS)*, pp. 4661–4666, 2018.
- [14] N. Jarrassé, M. Tagliabue, J. V. G. Robertson, A. Maiza, V. Crocher, A. Roby-Brami, and G. Morel, "A Methodology to Quantify Alterations in Human Upper Limb Movement During Co-Manipulation With an Exoskeleton," *IEEE Transactions on Neural Systems and Rehabilitation Engineering*, vol. 18, no. 4, pp. 389–397, Aug. 2010.
- [15] D. Verdel, S. Bastide, O. Bruneau, B. Berret, and N. Vignais, "Improving and quantifying the transparency of an upper-limb robotic exoskeleton with a force sensor and electromyographic measures," *46ème Congrès Société Biomécanique, Computer Methods in Biomechanics and Biomedical Engineering*, vol. 24:sup1, pp. 261–263, 2021.
- [16] D. Verdel, S. Bastide, N. Vignais, O. Bruneau, and B. Berret, "An identification-based method improving the transparency of a robotic upper-limb exoskeleton," *Robotica*, vol. 39, no. 9, pp. 1711–1728, 2021.
- [17] G. Ercolini, E. Trigili, A. Baldoni Simona Crea, and N. Vitiello, "A novel generation of ergonomic upper-limb wearable robots: design challenges and solutions," *Robotica*, pp. 2056–2072, Nov. 2018.
- [18] D. Martelli, F. Vannetti, M. Cortese, P. Tropea, G. Francesco, S. Micera, V. Monaco, and N. Vitiello, "The effects on biomechanics of walking and balance recovery in a novel pelvis exoskeleton during zero-torque control," *Robotica*, vol. 32, no. 08, pp. 1317–1330, Jun. 2014.
- [19] M. Xiloyannis, D. Chiaradia, A. Frisoli, and L. Masia, "Physiological and kinematic effects of a soft exosuit on arm movements," *Journal of NeuroEngineering and Rehabilitation*, vol. 16, no. 1, p. 29, Feb. 2019.
- [20] B. Berret, C. Castanier, S. Bastide, and T. Deroche, "Vigour of self-paced reaching movement: cost of time and individual traits," *Scientific Reports*, 2018.
- [21] J. Gaveau, B. Berret, D. E. Angelaki, and C. Papaxanthis, "Direction-dependent arm kinematics reveal optimal integration of gravity cues," *eLife*, vol. 5, pp. 1–17, Nov. 2016.
- [22] R. Gentili, V. Cahouet, and C. Papaxanthis, "Motor planning of arm movements is direction-dependent in the gravity field," *Neuroscience*, vol. 1, no. 145, pp. 20–32, 2007.
- [23] O. Baser and E. I. Konukseven, "Utilization of motor current based torque feedback to improve the transparency of haptic interfaces," *Mechanism and Machine Theory*, vol. 52, pp. 78–93, jun 2012.
- [24] P. Garrec, "Screw and Cable Actuators (SCS) and Their Applications to Force Feedback Teleoperation, Exoskeleton and Anthropomorphic Robotics," *Robotics Current and Future Challenges*, pp. 167–191, 2010.
- [25] P. Garrec, J. P. Fricconneau, Y. Méasson, and Y. Perrot, "ABLE, an Innovative Transparent Exoskeleton for the Upper-Limb," *IEEE/RSJ International Conference on Intelligent Robots and Systems (IROS)*, pp. 1483–1488, Sep. 2008.
- [26] R. Mallat, M. Khalil, G. Venture, V. Bonnet, and S. Mohammed, "Human-exoskeleton joint misalignment: a systematic review," in *2019 Fifth International Conference on Advances in Biomedical Engineering (ICABME)*. IEEE, oct 2019.
- [27] N. Neckel, W. Wisman, and J. Hidler, "Limb alignment and kinematics inside a lokomat robotic orthosis," in *2006 International Conference of the IEEE Engineering in Medicine and Biology Society*, 2006, pp. 2698–2701.
- [28] A. Schiele and F. C. T. van der Helm, "Kinematic design to improve ergonomics in human machine interaction," *IEEE Transactions on Neural Systems and Rehabilitation Engineering*, vol. 14, no. 4, pp. 456–469, dec 2006.
- [29] A. Schiele, "An explicit model to predict and interpret constraint force creation in pHRI with exoskeletons," in *2008 IEEE International Conference on Robotics and Automation*, may 2008.
- [30] S. V. Sarkisian, M. K. Ishmael, and T. Lenzi, "Self-aligning mechanism improves comfort and performance with a powered knee exoskeleton," *IEEE Transactions on Neural Systems and Rehabilitation Engineering*, vol. 29, pp. 629–640, 2021.
- [31] Y. Niu, Z. Song, and J. S. Dai, "Design of the planar compliant five-bar mechanism for self-aligning knee exoskeleton," in *2018 International Conference on Reconfigurable Mechanisms and Robots (ReMAR)*. IEEE, jun 2018.
- [32] K. Junius, N. Lefeber, E. Swinnen, B. Vanderborght, and D. Lefeber, "Metabolic effects induced by a kinematically compatible hip exoskeleton during STS," *IEEE Transactions on Biomedical Engineering*, vol. 65, no. 6, pp. 1399–1409, jun 2018.
- [33] A. S. Koopman, M. Näf, S. J. Baltrusch, I. Kingma, C. Rodriguez-Guerrero, J. Babič, M. P. de Looze, and J. H. van Dieën, "Biomechanical evaluation of a new passive back support exoskeleton," *Journal of Biomechanics*, vol. 105, p. 109795, may 2020.
- [34] J. Beil, C. Marquardt, and T. Asfour, "Self-aligning exoskeleton hip joint: Kinematic design with five revolute, three prismatic and one ball joint," in *2017 International Conference on Rehabilitation Robotics (ICORR)*, jul 2017.
- [35] A. H. A. Stienen, E. E. G. Hekman, F. C. T. van der Helm, and H. van der Kooij, "Self-aligning exoskeleton axes through decoupling of joint rotations and translations," *IEEE Transactions on Robotics*, vol. 25, no. 3, pp. 628–633, 2009.
- [36] A. S. Niyetkaliyev, S. Hussain, M. H. Ghayesh, and G. Alici, "Review on design and control aspects of robotic shoulder rehabilitation orthoses," *IEEE Transactions on Human-Machine Systems*, vol. 47, no. 6, pp. 1134–1145, dec 2017.
- [37] A. Schiele and F. C. T. van der Helm, "Influence of attachment pressure and kinematic configuration on pHRI with wearable robots," *Applied Bionics and Biomechanics*, vol. 6, no. 2, pp. 157–173, 2009.
- [38] A. Ericson, A. Arndt, A. Stark, P. Wretenberg, and A. Lundberg, "Variation in the position and orientation of the elbow flexion axis," *The Journal of Bone and Joint Surgery, British volume*, vol. 85-B, no. 4, pp. 538–544, may 2003.
- [39] World Medical Association., "World Medical Association Declaration of Helsinki. Ethical principles for medical research involving human subjects," *Bulletin of the World Health Organization*, vol. 79, no. 4, pp. 373–374, 2001.
- [40] D. Verdel, S. Bastide, N. Vignais, O. Bruneau, and B. Berret, "Human weight compensation with a backdrivable upper-limb exoskeleton: identification and control," *Frontiers in Bioengineering and Biotechnology*, vol. 9, jan 2022.
- [41] H. J. Hermens, R. Research, and B. V. Development, Eds., *European recommendations for surface ElectroMyoGraphy: results of the SENIAM project*, ser. SENIAM. Roessingh Research and Development, 1999, no. 8.
- [42] S. G. Hart and L. E. Staveland, "Development of NASA-TLX (task load index): results of empirical and theoretical research," in *Advances in Psychology*. Elsevier, 1988, pp. 139–183.
- [43] P. Maurice, J. Camernik, D. Gorjan, B. Schirrmeister, J. Bornmann, L. Tagliapietra, C. Latella, D. Pucci, L. Fritzsche, S. Ivaldi, and J. Babič, "Objective and subjective effects of a passive exoskeleton on overhead work," *IEEE Transactions on Neural Systems and Rehabilitation Engineering*, vol. 28, no. 1, pp. 152–164, jan 2020.
- [44] J. R. Potvin and S. H. M. Brown, "Less is more: high pass filtering, to remove up to 99% of the surface EMG signal power, improves EMG-based biceps brachii muscle force estimates," *Journal of Electromyography and Kinesiology*, vol. 14, no. 3, pp. 389–399, Jun. 2004.
- [45] J. D. Cooke and S. H. Brown, "Movement-related phasic muscle activation: III. The duration of phasic agonist activity initiating movement," *Experimental Brain Research*, vol. 99, no. 3, pp. 473–482, 1994.
- [46] C. Papaxanthis, T. Pozzo, and M. Schieppati, "Trajectories of arm pointing movements on the sagittal plane vary with both direction and speed," *Experimental Brain Research*, vol. 148, no. 4, pp. 498–503, 2003.
- [47] R. Vallat, "Pingouin: statistics in python," *Journal of Open Source Software*, vol. 3, no. 31, p. 1026, nov 2018.