



**HAL**  
open science

# Microwave-Assisted Pyrolysis of Biomass with and without Use of Catalyst in a Fluidised Bed Reactor: A Review

C. Mohabeer, N. Guilhaume, D. Laurenti, Y. Schuurman

► **To cite this version:**

C. Mohabeer, N. Guilhaume, D. Laurenti, Y. Schuurman. Microwave-Assisted Pyrolysis of Biomass with and without Use of Catalyst in a Fluidised Bed Reactor: A Review. *Energies*, 2022, 15 (9), pp.3258. 10.3390/en15093258 . hal-03686455

**HAL Id: hal-03686455**

**<https://hal.science/hal-03686455>**



Submitted on 15 Nov 2022

**HAL** is a multi-disciplinary open access archive for the deposit and dissemination of scientific research documents, whether they are published or not. The documents may come from teaching and research institutions in France or abroad, or from public or private research centers.

L'archive ouverte pluridisciplinaire **HAL**, est destinée au dépôt et à la diffusion de documents scientifiques de niveau recherche, publiés ou non, émanant des établissements d'enseignement et de recherche français ou étrangers, des laboratoires publics ou privés.

Review

# Microwave-Assisted Pyrolysis of Biomass with and without Use of Catalyst in a Fluidised Bed Reactor: A Review

Chetna Mohabeer <sup>\*</sup>, Nolven Guillaume, Dorothée Laurenti and Yves Schuurman 

University of Lyon, CNRS, IRCELYON—UMR 5256, 2 Avenue Albert Einstein, CEDEX, F-69626 Villeurbanne, France; nolven.guillaume@ircelyon.univ-lyon1.fr (N.G.); dorothee.laurenti@ircelyon.univ-lyon1.fr (D.L.); yves.schuurman@ircelyon.univ-lyon1.fr (Y.S.)  
\* Correspondence: chetna.mohabeer@gmail.com; Tel.: +33-472445394

**Abstract:** Lignocellulosic biomass and waste, such as plastics, represent an abundant resource today, and they can be converted thermo-chemically into energy in a refinery. Existing research works on catalytic and non-catalytic pyrolysis performed in thermally-heated reactors have been reviewed in this text, along with those performed in microwave-heated ones. Thermally-heated reactors, albeit being the most commonly used, present various drawbacks such as superficial heating, high thermal inertia and slow response times. That is why microwave-assisted pyrolysis (MAP) appears to be a very promising technology, even if the process does present some technical drawbacks as well such as the formation of hot spots. The different types of catalysts used during the process and their impacts have also been examined in the text. More specifically, studies conducted in fluidised bed reactors (FBR) have been detailed and their advantages and drawbacks discussed. Finally, future prospects of MAP have been briefly presented.

**Keywords:** microwave pyrolysis; MAP; catalytic pyrolysis; HDO; biomass; plastics



**Citation:** Mohabeer, C.; Guillaume, N.; Laurenti, D.; Schuurman, Y. Microwave-Assisted Pyrolysis of Biomass with and without Use of Catalyst in a Fluidised Bed Reactor: A Review. *Energies* **2022**, *15*, 3258. <https://doi.org/10.3390/en15093258>

Academic Editors: Dushyant Shekhawat, Swarom Kanitkar and Daniel Haynes

Received: 14 March 2022

Accepted: 27 April 2022

Published: 29 April 2022

**Publisher's Note:** MDPI stays neutral with regard to jurisdictional claims in published maps and institutional affiliations.



**Copyright:** © 2022 by the authors. Licensee MDPI, Basel, Switzerland. This article is an open access article distributed under the terms and conditions of the Creative Commons Attribution (CC BY) license (<https://creativecommons.org/licenses/by/4.0/>).

## 1. Introduction

Since the start of the twenty-first century, rapid population and technological growth have put relentless pressure on already ever-dwindling fossil fuel resources. The peak in energy demand is not expected to diminish in the coming years. More people existing on the planet translates into more waste, and so, more biomass being produced. Hence, biomass as an energy source could be a viable replacement for fossil sources in the coming years. Various products such as biodiesel, bioethanol and biohydrogen have successfully been produced from biomass, supporting its potential as a reliable and clean energy source. Biofuels can be classified into three broad categories: first, second and third generations. Table 1 catalogues the different known biomass resources.

**Table 1.** Biofuel resource classification (Adapted from [1]).

<b>First-Generation Sources</b>	Virgin resources	Forest resources	Wood such as pine, woody and forest biomass such as willow, poplar, aspen
		Oil crops	Wheat, barley, corn, canola, rapeseed, palm oil, soybean, sugarcane, flax, oat, straw, pasture grasses
<b>Second-Generation Sources</b>	Residues	Wood residues	Bark, branches, leftover treetop, leaves from harvest, sawdust, shavings from pulp and sawmills
		Agricultural residues and waste	Residual fraction from oil crop harvest, waste oil/fat
		Livestock residues	Livestock excrement and carcass
	Municipal solid waste (MSW)	Residential	Cardboard and mixed paper, glass, various metals, electronics, plastics, tyres, organics
		Non-residential	Sewage sludge
<b>Third-Generation Sources</b>	Algae	-	Macroalgae, microalgae

A plethora of conversion processes—physical, thermal, biochemical, microbial or chemical—have been used to transform biomass into fuels [2,3]. Among all the processes, thermochemical ones present a better choice so as to convert biomass feedstock more rapidly at a lesser cost [3]. Interesting thermochemical transformation processes include combustion or incineration, catalytic liquefaction, gasification and pyrolysis, which is the main focus of this review.

### 2. Pyrolysis and Catalytic Pyrolysis

Pyrolysis is a thermal conversion process that heats and decomposes a substance in an oxygen-inert atmosphere. This process is classified into three distinct technologies, and forms three main products, as illustrated in Figures 1 and 2, respectively. The process has largely been examined in literature and can be optimised to maximise the production of any of its product constituents by altering process parameters such as the operational temperature and residence time, among others [4–8].

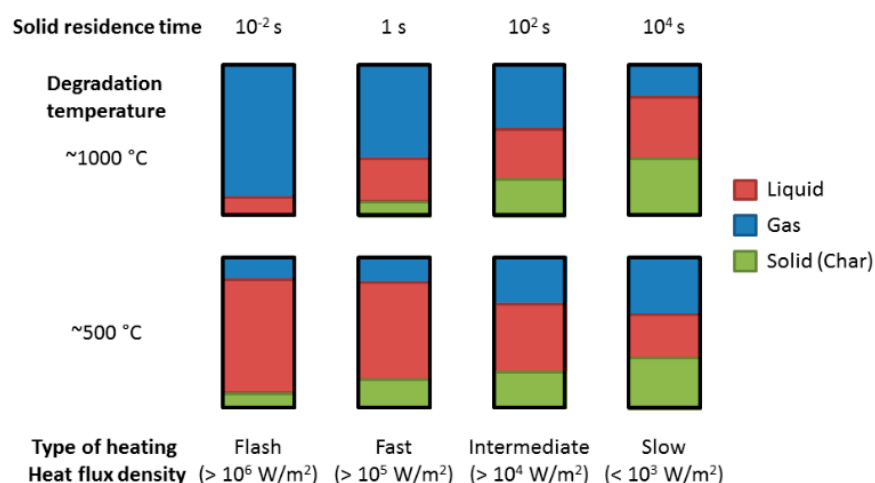

**Figure 1.** Pyrolysis technologies classification (Adapted from [9]).

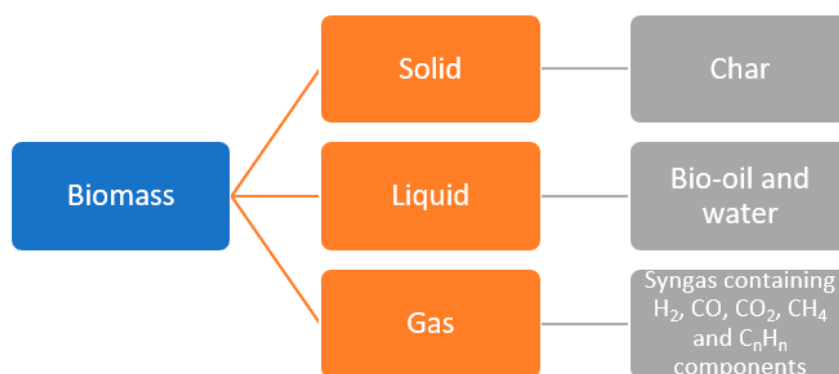

**Figure 2.** Biomass pyrolysis products (Adapted from [10]).

Different types of reactors have been used to conduct pyrolysis reactions over time [11]. The more common ones are: ablative, conical spouted bed, rotating cone, Auger and fluidised bed (bubbling and circulating) reactors [12–14]. Lam et al. [15] state that most studies pertaining to biomass pyrolysis at the laboratory scale are performed in batch reactors as the latter are simple to use, no high-pressure pump or compressor is needed, all types of biomass can be used and no complex separation means needs to be applied to recover the remaining bio-char. However, the drawbacks presented by this technology, extended reaction, heating and cooling times, product inconsistency and difficulty of large-scale production, have geared more recent research towards semi-continuous and continuous processes [16].

Now, it should be noted that the bio-oil produced from biomass pyrolysis has a high oxygen content, which translates to it also having high acidity, high viscosity, low calorific value and thermal instability [17]. The latter characteristics present a challenge for bio-oil to be used as a substitute for conventional fuels. Therefore, the main objective of most pyrolysis systems is to maximise the yield of bio-oil and improve the selectivity of the compounds within the bio-oil. Various methods have been studied in literature to enhance the properties of these bio-oils. One method commonly used in literature is catalytic fast pyrolysis (CFP). Different upgrading methods have also been researched in the literature; one of the most studied methods is catalytic hydrodeoxygenation (HDO).

Some studies have shown that catalytic HDO presents an increase in liquid hydrocarbons, gaseous olefin yields and a decrease in coke yield with respect to untreated bio-oil [18]. On the other hand, it does exhibit some drawbacks such as its need for rare metals and high-pressure hydrogen, and its rather expensive cost. Most research studies on catalytic HDO have been conducted on model compounds such as guaiacol, phenol or cresol; Am-bursa et al. [19] and Wang et al. [20] present an exhaustive summary of these studies in their respective publications. Some of the most notable research works concerning catalytic HDO have been summarised in Table 2.

As for CFP, only the research performed on the upgrading of pyrolytic vapours, that is, ex situ CFP, have been considered. The most commonly used catalysts in literature are zeolite-based. Their efficiency in deoxygenating bio-oils and increasing their hydrocarbon content has been widely researched and proven, as shown in Table 3.

**Table 2.** Notable research works on catalytic HDO.

Feed	Reaction Conditions				Bio-Oil Yield (wt. %)	Results	Ref.
	Catalyst Used	Reactor Used	Temperature (°C), Pressure (bar), H <sub>2</sub> Percentage	WHSV * (g feed/g cat. h), Contact Time (s) or F/C * Ratio			
Guaiacol	MoS <sub>2</sub>	Fixed bed	300 °C, 40 bar, 100% H <sub>2</sub>	0.3–1 s	-	HDO transformation of guaiacol was significantly enhanced by promoting MoS <sub>2</sub> -based catalysts with Co. However, the use of Al <sub>2</sub> O <sub>3</sub> as support gave rise to demethylation and production of methyl-substituted products, which render de-oxygenation more difficult.	[21]
	CoMoS						
	MoS <sub>2</sub> /Al <sub>2</sub> O <sub>3</sub>						
	CoMoS/Al <sub>2</sub> O <sub>3</sub>						
Guaiacol	MoS <sub>2</sub> /γ-Al <sub>2</sub> O <sub>3</sub>	Fixed bed	300 °C, 40 bar, 100% H <sub>2</sub>	0.3–1 s	-	Out of MoS <sub>2</sub> -based catalysts, the TiO <sub>2</sub> -supported one gave the most interesting improvements. As for CoMoS, ZrO <sub>2</sub> proved to have the most significant catalytic activities. The CoMoS/ZrO <sub>2</sub> system was very selective towards aromatic (C-O) hydrogenolysis as demethoxylation and direct de-oxygenation were both observed.	[22]
	MoS <sub>2</sub> /TiO <sub>2</sub>						
	MoS <sub>2</sub> /ZrO <sub>2</sub>						
	CoMo/γ-Al <sub>2</sub> O <sub>3</sub>						
	CoMo/TiO <sub>2</sub>						
	CoMo/ZrO <sub>2</sub>						
Guaiacol	NiCu/ CeO <sub>2</sub> -ZrO <sub>2</sub>	Batch	280–360 °C, 170 bar, 100% H <sub>2</sub>	337.5:1	-	NiCu/SiO <sub>2</sub> -ZrO <sub>2</sub> -La <sub>2</sub> O <sub>3</sub> was the most efficient catalyst. Deoxygenation degree increased with temperature, while guaiacol conversion decreased due to catalyst coking at higher temperatures.	[23]
	NiCu/Al <sub>2</sub> O <sub>3</sub>						
	NiCu/SiO <sub>2</sub>						
	NiCu/SiO <sub>2</sub> -ZrO <sub>2</sub> - La <sub>2</sub> O <sub>3</sub>						
	Ni/SiO <sub>2</sub>						
	Ni-Cu-MgO						

Table 2. Cont.

Feed	Reaction Conditions				Bio-Oil Yield (wt. %)	Results	Ref.
	Catalyst Used	Reactor Used	Temperature (°C), Pressure (bar), H <sub>2</sub> Percentage	WHSV * (g feed/g cat. h), Contact Time (s) or F/C * Ratio			
Yellow poplar bio-oil	Ni/C	Autoclave	300 °C, 30 bar, 100% H <sub>2</sub>	25:1	63.8	The mesoporous silica supports (SBA-15 and Al-SBA-15) showed greater catalytic activity than Ni/C. this could be correlated to a higher surface area and pore size, which caused uniform dispersion of Ni particles.	[24]
	Ni/SBA-15				76.0		
	Ni/Al-SBA-15				74.8		
Methyl oleate (as model compound for green diesel)	NiMo/C	Fixed bed	260 °C, 30 bar, 90% H <sub>2</sub> and 10% H <sub>2</sub> S	6.5 g feed/g cat. h	-	NiMo/Al <sub>2</sub> O <sub>3</sub> and NiMo/ASA showed the highest global HDO activity, however, they de-activated during the run—owing to Lewis acidity of Al surface active in methyl oleate hydrolysis. NiMo/SiO <sub>2</sub> had similar overall activity than the two previous, but did not de-activate. NiMo/C did not de-activate either, and was more active than the others at the end of the run.	[25]
	NiMo/SiO <sub>2</sub>						
	NiMo/ASA						
	NiMo/Al <sub>2</sub> O <sub>3</sub>						
Rice husk bio-oil	Ni-Cu/HZSM-5	Autoclave	270 °C, 20 bar, 100% H <sub>2</sub>	12:1	33.9	Addition of CeO <sub>2</sub> to Ni-Cu/HZSM-5 improved the performance of the catalyst. It caused an improvement in the Ni dispersion, redox ability and the Bronsted acidity ratio. It also decreased the particle size of the catalyst and diminished coke deposition on the catalyst surface, which causes catalyst deactivation. In total, 15% CeO <sub>2</sub> -Ni-Cu/HZSM-5 was the best in terms of catalyst efficiency.	[26]
	5% CeO <sub>2</sub> -Ni-Cu/HZSM-5				37.4		
	15% CeO <sub>2</sub> -Ni-Cu/HZSM-5				47.6		
	20% CeO <sub>2</sub> -Ni-Cu/HZSM-5				35.3		
Anisole, m-cresol and phenol	5% Pd/C	Parr batch	250–350 °C, 50 bar, 100% H <sub>2</sub>		-	Residence time of 4 h allowed the formation of high yields of deoxygenated compounds. Pt/Al <sub>2</sub> O <sub>3</sub> promoted hydrogenation (ring saturation) and removal of the pendant groups, and a significant pathway shift was observed as temperature increased. Pd/C showed ring saturation followed by methanol abstraction.	[27]
	5% Pt/Al <sub>2</sub> O <sub>3</sub>						

Table 2. Cont.

Feed	Reaction Conditions				Results		Ref.
	Catalyst Used	Reactor Used	Temperature (°C), Pressure (bar), H <sub>2</sub> Percentage	WHSV * (g feed/g cat. h), Contact Time (s) or F/C * Ratio	Bio-Oil Yield (wt. %)	Products and Conclusions	
<i>Saccharina Japonica</i> bio-oil	HZSM-5	Autoclave	350 °C, 3–15 bar, 100% H <sub>2</sub>	10:1	80.4	Pressures of 3 to 15 bar were tested and 15 bar provided the highest bio-oil yield; all catalytic tests were hence performed at 15 bar. HHV* of HDO-upgraded bio-oils improved with use of Co/ $\gamma$ -Al <sub>2</sub> O <sub>3</sub> , but decreased with use of metal phosphide catalysts. The latter promoted decarboxylation while metal catalysts elevated demethylation. An increase in kerosene fraction of bio-oil was also observed with the use of catalytic HDO.	[28]
	Co/ $\gamma$ -Al <sub>2</sub> O <sub>3</sub>				77.6		
	Fe// $\gamma$ -Al <sub>2</sub> O <sub>3</sub>				82.1		
	CoP// $\gamma$ -Al <sub>2</sub> O <sub>3</sub>				82.7		
	Fe <sub>2</sub> P// $\gamma$ -Al <sub>2</sub> O <sub>3</sub>				78.8		
	CoMoP// $\gamma$ -Al <sub>2</sub> O <sub>3</sub>				68.0		
Guaiacol and furfural	Zeolite Y (Si/Al: 5.1:1)	Pyroprobe (Py-GC/MS)	500 °C, 1.01 bar, 100% H <sub>2</sub>	1:10	-	Conversion over catalysts with low Si/Al ratios gave rise to the production of aromatics (benzene, toluene, xylene and phenol). Highest benzene yield was 19.5 wt. % over zeolite Y (30:1). Trend of overall BTX yield was: Zeolite Y (30:1), 30.5% > Zeolite Y (5.1:1), 28.1% > Zeolite Y (80:1), 12.0% > Zeolite Y (60:1), 6.4%. It was also shown that zeolite acidity played an important role in the deoxygenation of guaiacol, but not in that of, furfural,	[29]
	Zeolite Y (Si/Al: 30:1)						
	Zeolite Y (Si/Al: 60:1)						
	Zeolite Y (Si/Al: 80:1)						
Guaiacol	$\gamma$ -Al <sub>2</sub> O <sub>3</sub> -SiO <sub>2</sub>	Fixed bed	275 or 300 °C, 1.01 bar, 25% H <sub>2</sub>	6.50 g guaiacol/g cat. h	-	Catalyst with a 50:50 Al/Si ratio after calcination at 450 °C exhibited the highest guaiacol conversion (81.79%).	[30]

\* WHSV: Weight hourly space velocity. F/C ratio: Feed to catalyst ratio. HHV: Higher heating value.

**Table 3.** Notable research works on CFP using zeolite-based catalysts.

Feed	Reaction Conditions				Results		Ref.
	Catalyst Used	Reactor Used	Temperature (°C)	WHSV (g feed/g cat. h) or F/C Ratio	Bio-Oil Yield (wt. %)	Product Quality, Oxygen Content and Conclusions	
Waste wood shavings	HZSM-5	Fluidised bed	500–550	1.05–1.14 g biomass/g cat. h	28.8	Good aromatics yield (15.9 wt. %)	[31]
	Na-ZSM-5				24.3	Higher aromatics yield (21.3 wt. %)	
	Y-Zeolite				28.6	Average aromatics yield (14.0 wt. %)	
	Activated alumina				31.2	Lowest aromatics yield (8.0 wt. %)	
Radiata pine sawdust	HZSM-5	Bubbling fluidised bed	475–625	4 g biomass/g cat. h	43.7	Formation of mainly aromatic hydrocarbons	[32,33]
	H-Y			8 g biomass/g cat. h	45.7	Almost no formation of aromatics	
	Ga/HZSM-5			4 g biomass/g cat. h	51.3	Higher selectivity for aromatics (as compared to HZSM-5)	
Radiata pine sawdust	HZSM-5	Fixed bed	500	10:1	46.6	Reduction of non-phenolic oxygenates	[34]
	MMZ <sub>HZSM-5</sub> (mesoporous material from HZSM-5)				50.6	No change in phenols; reduction in other oxygenates	
	MFI zeolite				45.9	High aromatics yield; reduction in non-phenolic oxygenates and in phenols	
	1% Ga/MFI						
	5% Ga/MFI					Similar to HZSM-5; less efficient than 1% Ga/MFI	



Table 3. Cont.

Feed	Reaction Conditions				Results		Ref.
	Catalyst Used	Reactor Used	Temperature (°C)	WHSV (g feed/g cat. h) or F/C Ratio	Bio-Oil Yield (wt. %)	Product Quality, Oxygen Content and Conclusions	
Pine sawdust	H- $\beta$	Dual fluidised bed	450	8.33:1	37.8	$\beta$ -zeolite was the most efficient for deoxygenation, followed by Y and ferrierite zeolites	[35]
	Fe-H- $\beta$				37.0		
	H-Y				39.7		
	Fe-H-Y				34.3		
	H-Ferrierite				43.8		
	Fe-H-Ferrierite				44.5		
Pine wood	ZSM-5	Fluidised bed	450–600	0.35 g biomass/g cat. h	-	Increase in selectivity of aromatics	[36]
<i>Jatropha</i> wastes	HZSM-5	Fixed bed	550	2:1	4.1–8.7	Conversion of 76.7–91.6% found; production of mainly aromatics	[37]
Particle board	HZSM-5	Batch	500	10:1	42.5	Reduction in oxygenates and increase in aromatics and phenolics	[38]
	Ga/HZSM-5				46.3	Larger reduction in oxygenates and higher increase in aromatics (compared to HZSM-5); lower phenolic content	
	H- $\beta$				44.6	Similar to HZSM-5, but less efficient	
Pine wood	$\beta$ /Al <sub>2</sub> O <sub>3</sub>	Auger	450	12 g biomass/g cat. h	52.0	Si/Al and $\beta$ -zeolite contributed to increase of liquid product while HZSM-5 and H-Y led to formation of aromatics and higher gas percentage. HZSM-5 reduced oxygen content of 46.4 wt. % to 30 wt. %.	[39]
	Si/Al				51.0		
	H-Y				43.0		
	HZSM-5				41.0		

Table 3. Cont.

Feed	Reaction Conditions				Results		Ref.
	Catalyst Used	Reactor Used	Temperature (°C)	WHSV (g feed/g cat. h) or F/C Ratio	Bio-Oil Yield (wt. %)	Product Quality, Oxygen Content and Conclusions	
Oak wood cylinder particles	HZSM-5	Micro fluidised bed	500	0.85:1	8.3–10.1	High selectivity in monoaromatic compounds (4.4 wt. %); CO <sub>2</sub> :CO = 0.5	[40]
	Desilicated HZSM-5					Higher selectivity in monoaromatic compounds (6.2 wt. %); same CO <sub>2</sub> :CO	
	HZSM-5	Fixed bed			-	High selectivity in monoaromatics (4.1 wt. %), but less efficient than FBR *	
	Desilicated HZSM-5				Higher selectivity than parent HZSM-5 (5.1 wt. %), but less efficient than FBR *		
Beech wood (BW)	HZSM-5	Semi-continuous	500	4:1	50.0	Fe-HZSM-5 was the most efficient in deoxygenation (33.82 to 17.50% for BW and 34.76 to 17.31% for FS). Zeolites were found to cause decomposition of carboxylic acids to form phenols, H <sub>2</sub> , H <sub>2</sub> O, CO <sub>2</sub> and CO, mostly. Pt and CoMo-based catalysts did not show high efficiencies; these catalysts might be better suited for HDO applications.	[17]
	Fe-HZSM-5				58.8		
	H-Y				49.0		
	Fe-H-Y				61.0		
	Pt/Al <sub>2</sub> O <sub>3</sub>				60.0		
	CoMo/Al <sub>2</sub> O <sub>3</sub>				54.0		
Flax shives (FS)	HZSM-5	Semi-continuous	500	4:1	50.0	Fe-HZSM-5 was the most efficient in deoxygenation (33.82 to 17.50% for BW and 34.76 to 17.31% for FS). Zeolites were found to cause decomposition of carboxylic acids to form phenols, H <sub>2</sub> , H <sub>2</sub> O, CO <sub>2</sub> and CO, mostly. Pt and CoMo-based catalysts did not show high efficiencies; these catalysts might be better suited for HDO applications.	[17]
	Fe-HZSM-5				58.8		
	H-Y				41.0		
	Fe-H-Y				51.0		
	Pt/Al <sub>2</sub> O <sub>3</sub>				52.0		
	CoMo/Al <sub>2</sub> O <sub>3</sub>				47.0		

\* FBR: Fluidised bed reactor.

Nowadays, research is tending more and more towards a cleaner way of disposing of plastic waste, which has been increasing at an alarming rate in recent years. Pyrolysis, and hence, microwave pyrolysis, has emerged as a very promising technology to this end. Kaminsky [41] performed the chemical recycling of different types of plastics in an FBR. His results have been summarised in Table 4.

**Table 4.** Results of pyrolysis of different plastics by Kaminsky [Adapted from 41].

Feed	Temperature (°C)	Fluidising Gas	Products
Polyethylene (PE), Polypropylene (PP)	400–550	Nitrogen, steam and pyrolysis gas	70–90% waxy products, oil, 2–9% gas
Polymethylmethacrylate (PMMA), Polystyrene (PS)	400–500	Pyrolysis gas	70–95% monomers, 5–30% gas, oil
Polyethylene terephthalate (PET)	400–550	Steam	45–60% monomers, 40–45% gas, oil
PE, PP	700–800	Nitrogen, steam	70–80% gas (olefins), 20–30% oil
PE, PP, polyamide (PA)	700–800	Pyrolysis gas	30–50% aromatics, 30–40% oil, gas, 1–10% soot

The authors found that PE and PP formed mostly waxy products around temperatures of 400–550 °C and gas and oil around 700 °C. By using pyrolysis gas as a fluidising agent, aromatics were produced. It was also observed that up to 98 wt. % of MMA could be recovered from the pyrolysis of pure PMMA wastes. As for styrene recovery from PS, it was limited to about 77 wt. % and the remainder was oligomers. PET was hydrolysed through this process with steam as a fluidising agent and PA, at low temperatures, produced aromatics and gas; soot formation was found to be low. Finally, PTFE was pyrolysed into high amounts of TFE and HEP, its monomers. Hence, it was concluded that the pyrolysis of plastics in a fluidised bed reactor was a real option for an industrial application.

Now, conventional pyrolysis systems making use of electrical heating have by far been the most-studied types of systems in the literature. However, these systems are energy-intensive, which compromises their economic viability on an industrial scale. Over recent years, research has been focusing on new, innovative ways to build energy-efficient systems for pyrolysis. One of the most promising routes found is microwave-assisted pyrolysis. It should also be noted that the addition of proper catalysts to a microwave pyrolysis process can dramatically influence the process' product selectivity; gas and liquid yields, as well as heating performance, can be importantly promoted through this addition of catalysts [42]. The distinction between the effects of the two (microwave heating and catalyst use) will try to be made throughout the text.

### 3. Fundamentals on Microwaves

Microwaves are electromagnetic irradiation with a wavelength range of 0.01 to 1 m, and a frequency range of 0.3 to 300 GHz, correspondingly [43]. Most microwave reactors used for chemical syntheses, as well as all domestic microwave ovens, function at a frequency of 2.45 GHz, correlating to a 12.25 cm wavelength. This is conducted in order to prevent any interference with telecommunications and cellular phone frequencies [44]. Microwaves are typically defined as electromagnetic waves having two perpendicular components, electric and magnetic fields, as shown in Figure 3.

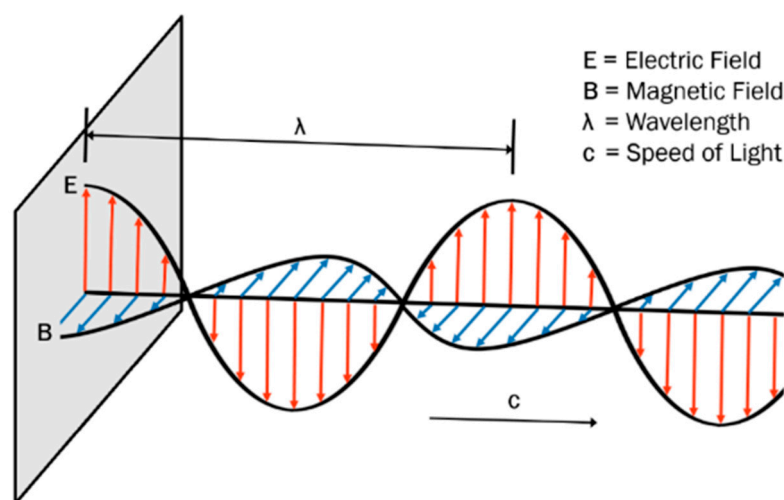

**Figure 3.** Electric (E) and magnetic (H) field components in microwaves [45].

Microwave dielectrics are known as materials able to absorb microwave irradiation, and thus, microwave heating is called dielectric heating [46]. Dielectric heating generally functions by transforming electromagnetic energy into thermal energy; it is more of an energy conversion than direct heating. The microwaves penetrate materials and deposit energy; thus, the heat can be diffused throughout the volume of the material. In this case, the centre of the material is at a higher temperature than its surroundings [1]. On the other hand, during conventional heating, heat is transferred from the surface to the core of the material via conduction driven by temperature gradients [47]. This difference is illustrated in Figure 4.

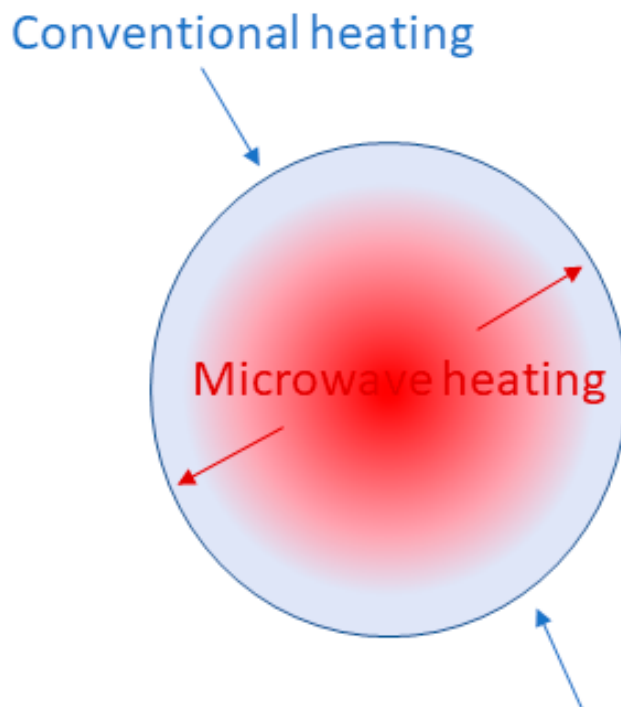

**Figure 4.** Microwave and conventional heating systems (Adapted from [1]).

Some advantages of microwave heating over conventional heating are presented in Table 5 [48].

**Table 5.** Microwave-assisted heating compared to conventional heating.

Microwave-Assisted Heating	Conventional Heating
Conversion of energy	Transfer of energy
Uniform heating at a molecular level from core	Superficial heating through conduction, convection and radiation
Frequent hot spot formation	Rarer hot spot formation
Rapid	Slow
Higher electricity conversion efficiency	Low electricity conversion efficiency
Selective	Non-selective
Dependent on material properties	Less dependent
Precise heating	Less precise
Lower thermal inertia and faster response	Higher thermal inertia and slower response

Now, according to the dielectric properties of a material, it may be categorised in three possible ways [2,39]:

1. Insulators or microwave-transparent materials, through which microwaves may pass without any losses (e.g., quartz, Teflon and so on), commonly possess low dielectric loss factors and have very large penetration depths;
2. Conductors or reflectors, which microwaves cannot penetrate and are reflected, are generally materials with high conductance and low capacitance (e.g., metals) that have high dielectric loss factors and hence, near-zero penetration depth for microwaves, and;
3. Absorbers, where microwave irradiation may be absorbed most effectively (e.g., water, oils and so on), have dielectric loss factors in the middle of the conductivity range.

According to the literature [49,50], there are three ways of enhancing a chemical reaction using the microwave irradiation technology:

1. Thermal effects (the influence of a high reaction temperature rapidly attained when irradiating polar materials in a microwave field);
2. Specific effects (caused by the unique nature of the heating mechanism of microwave irradiation in a microwave field; this cannot be achieved using conventional heating) and;
3. Non-thermal, non-specific effects (chemical transformation accelerations that have not been attributed to either thermal or specific microwave effects).

Indeed, as a result of rapid heating within the material due to the use of microwaves, reaction times of many microwave-assisted organic reactions are shortened and allow higher yields and selectivity to be obtained. Another good reason to use microwave heating is that there is no direct contact between the energy source and the reactor walls as microwaves pass through the vessel walls, which are almost transparent to them, directly to interact with the reactants [50].

#### 4. Microwave-Assisted Pyrolysis (MAP)

As mentioned previously, when compared to conventional heating, microwave heating presents various advantages, which influence significantly the yield and characteristics of the resulting products. Products from microwave pyrolysis obtained by using appropriate power levels may have high heating values; they may also yield higher gas and solid fractions, but lower liquid products than conventional pyrolysis. Indeed, through the use of microwave pyrolysis, almost half of the lignocellulosic biomass can be converted to gaseous products, mainly consisting of H<sub>2</sub>, CH<sub>4</sub>, CO and CO<sub>2</sub> and this gas product will possess a higher energetic value because of its high H<sub>2</sub> and CO yields [42].

Many researchers have devoted time and resources to microwave-assisted pyrolysis of biomass since recent years due to its advantages [2,6,7,51–58]. These studies have mostly

focused on what the use of microwaves can bring to the pyrolysis process when compared to the use of conventional heating. This review will endeavour to group together significant research works performed in recent years concerning microwave-assisted catalytic pyrolysis while focusing mainly on the reactions carried out in fluidised bed reactors.

Setups used at the laboratory scale are typically fixed beds utilising continuous gas flow ones [59]. Microwave reactors may be differentiated based on applicator design, wavelength, flow and power source type [59]. Firstly, the applicator, also known as the cavity, is the structure where the dielectric material to be heated is placed. There are three types of applicators [59]:

1. Multimode applicators: the most commonly used types of applicators for domestic and laboratory purposes, where a large number of resonant modes for operational frequency are hosted.
2. Single-mode applicators: most widely used for heterogeneous gas-phase reactions; capacity to attain high temperatures at low powers. These applicators are able to deliver a highly concentrated energy field, leading to faster heating rates.
3. Travelling-wave applicators: microwaves travel in only one direction, ensuring no back-reflection of waves and hence, no non-uniform interference in the waveguide (channel through which microwave energy propagates from transmitter to receiver) and no standing wave formation.

Secondly, the type of waveguide used is important as each type can only support specific modes of wave propagation [59]. Rectangular ones are the most commonly used types owing to their compatibility with the operational modes needed and their ease of being fabricated [59]. Next to be considered are the generator types. Microwave reactors are typically powered by magnetron tubes. However, magnetrons function at a unique frequency and have short lifetimes (2000–10,000 h). New emerging technologies include solid-state amplifiers which can vary frequency during their operation. The advantage of changing frequency is to mitigate hot spot formation and random wave interactions [59]. Finally, a microwave system can be dimensioned and optimised for specified reaction flow conditions. Depending on various cases, fixed bed, batch or fluidised bed reactors may be used.

Lab-scale microwave setups include a microwave power generator, waveguides, a cavity withholding the reactor, an autotuner, sliding short, temperature and flow controllers, gas supply units and a cooling system [59]. Figure 5 illustrates an example of a common type of microwave setup used for the pyrolysis of biomass waste. The setup presented here was used by Mokhtar et al. [60].

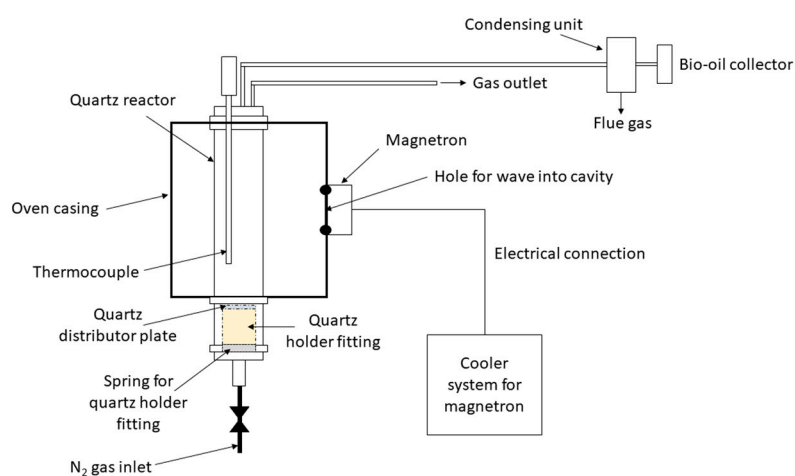

**Figure 5.** Schematic of microwave reactor as used by Mokhtar et al. (Adapted from [60]).

#### 4.1. Effect of MAP on Pyrolysis Product Distribution

Based on the literature, MAP is reported to be much better than conventional pyrolysis in terms of product distribution, yield and quality. Indeed, Ge et al. [55] found by comparing the effects of different heating sources (direct thermal, solar, infrared and microwave heating) on liquid yield obtained from pyrolysis under the same operational conditions that microwave heating was the most efficient heating method in order to achieve the highest bio-oil yield. Several studies have been performed on the effect of the intensity of power used for microwave heating on the products [61–65]. These have shown that the minimum power required to initiate the pyrolysis process is 300 W. However, powers less than 480 W yielded low bio-oil quantities. Increasing the microwave power used resulted in enhancing gas and bio-oil formation while diminishing char formation. It can also be noted that maximum gas yield is obtained at the maximum wattage used.

Domínguez et al. [65] studied the MAP and conventional pyrolysis of sewage sludge using graphite as a microwave absorber at temperatures ranging from 800 to 1000 °C. They used a multimode microwave cavity oven with a flow of 10 mL/min in a quartz reactor, maintaining a constant power input of 1000 W and microwave frequency of 2450 MHz. The temperature of the sample was monitored throughout the experiment through an infrared optical pyrometer. They found that a higher amount of bio-oil was obtained from MAP and these oils were found to contain virtually no polycyclic aromatic hydrocarbons (PAHs), which are undesirable since they are carcinogenic (present in significant amounts in oil obtained from conventional pyrolysis). Moreover, Fernández and Menéndez [66] examined the conventional pyrolysis and MAP of a series of biomass wastes: sewage sludges, coffee hulls and glycerol using the same reactor and conditions as Domínguez et al. [65]. They found higher quantities of syngas and less CO<sub>2</sub> in the gaseous components from MAP as compared to those from conventional pyrolysis. They also observed that glycerol gave the highest concentration of syngas out of all the feedstock, but it also gave the lowest H<sub>2</sub>/CO ratio. Sewage sludges exhibited the opposite tendency while coffee hulls showed an intermediate behaviour.

Liu et al. [67] investigated the MAP and conventional pyrolysis of sewage sludge over a range of temperatures of 600 to 900 °C. The reactor used for conventional pyrolysis was a horizontal fixed-bed quartz tubular one, having a 60 mm internal diameter (i.d.) × 900 mm length. It was heated in a 2200 W electrical furnace. The power used for MAP was 1400 W, the reactor a 2.45 GHz multimode tubular quartz one with a 45 mm i.d. and 750 mm length. A flow of 300 mL/min of N<sub>2</sub> was used to ensure an inert atmosphere. Despite the two setups not being identical, the authors found that when the temperature was increased, the product yields for conventional pyrolysis varied significantly, while those for microwave pyrolysis showed only a slight change. For instance, during conventional pyrolysis, H<sub>2</sub> yield went from 1.26 mmol/g at 600 °C to 9.07 mmol/g at 900 °C whereas the yield during MAP changed from 1.84 mmol/g to 3.67 mmol/g at the same temperatures. This difference was attributed to the fact that more hydrogen atoms were converted to tar compounds instead of being released into the syngas under MAP, as observed by a higher H/C ratio under MAP.

Furthermore, microwave-induced pyrolysis of palm oil biomass using char as a microwave absorber was carried out by Salema and Ani [68]. The authors used a 1 kW modified domestic microwave system with a 2450 MHz frequency. The microwave cavity was modified to accommodate a fluidised bed quartz reactor (0.1 m i.d. × 0.15 m height). Their setup is illustrated in Figure 6. They used a microwave power of 450 W and an exposure time of 25 min for each experiment. Different ratios of biomass to microwave absorber (1:0.25, 1:0.5 and 1:1) and an N<sub>2</sub> flow rate of 20 L/min were used in the experiment series. They found the maximum bio-oil yield and lowest char yield at a biomass to microwave absorber ratio of 1:0.5, showing that the quantity of microwave absorbers or catalysts used did affect the pyrolysis product yields. They also concluded that the use of an eco-friendly microwave absorber (bio-char, in this case) can help operate the microwave reactor at a lower power input, thus reducing the need for high power MAP.

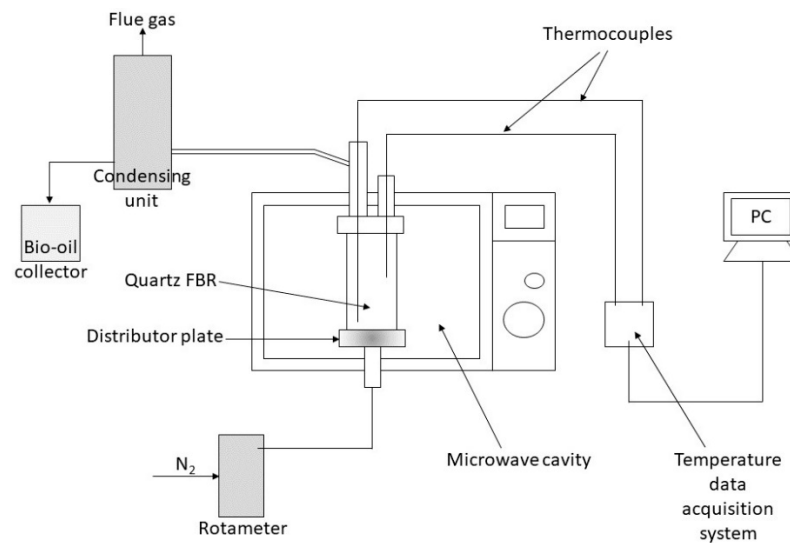

**Figure 6.** MAP setup used by Salema and Ani (Adapted from [68]).

#### 4.2. MAP in Fluidised Bed Reactors

Besides the study led by Salema and Ani [68] mentioned earlier, other researchers have also tried out MAP experiments in FBRs. One such example is Adam et al. [69], who developed a methodology for a microwave fluidised bed system based on processing raw biomass, without adding any microwave absorbents (Figure 7). The authors determined the minimum fluidisation velocity ( $u_{mf}$ ) of the biomass used, sycamore, through cold fluidisation tests in a 50 mm i.d. and 70 cm height acrylic column. They found  $u_{mf}$  values of 0.06–0.81 m/s corresponding to 45–2360  $\mu\text{m}$  particle sizes, respectively.

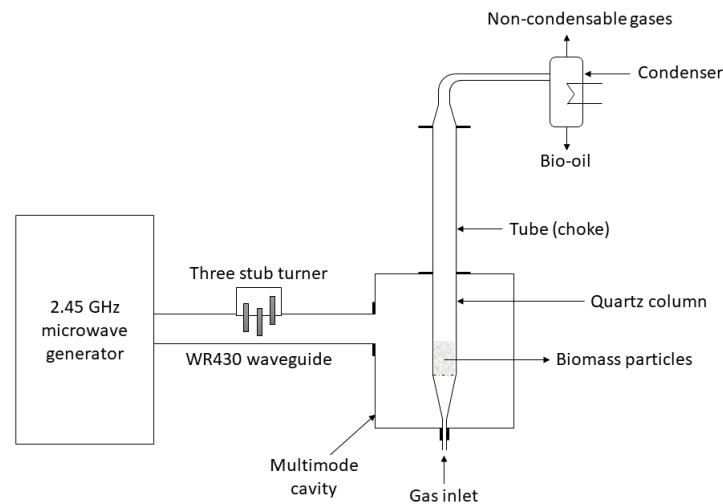

**Figure 7.** MAP FBR used by Adam et al. (Adapted from [69]).

The authors found that particle sizes  $<600 \mu\text{m}$  exhibited homogeneous fluidisation, with no channel formation, contrary to bigger particle sizes. It was also found that a minimum power density of  $54 \text{ W/m}^3$  was needed to reach  $400 \text{ }^\circ\text{C}$ ; a higher power density value would enable reaching the temperature more quickly. According to the simulations run by Adam et al. [66], the optimum dimensions and operating conditions of the microwave cavity would be a height of 30 cm, a width of 24 cm, waveguide position of  $20.10 \text{ mm} \times 162.50 \text{ mm}$  (Y and Z positions, respectively), an input power of 6 kW and a microwave frequency of 2450 MHz. However, the authors noted that a compromise would be needed on the input power when designing an actual experimental setup.



### 4.3. Catalytic MAP

It was found that through the use of catalysts during MAP, the yield and quality of bio-oil may be enhanced [70]. However, depending on the type of catalyst used, the production of bio-char or syngas may be favoured at the expense of that of bio-oil. Ge et al. [71] and Morgan et al. [57] have made an exhaustive list of relevant studies having been performed on different catalysts and process parameters used during MAP of biomass in recent years. The most significant and pertinent ones to the aim of this review have been detailed further down this text.

As with conventional pyrolysis, MAP also includes two processes for the use of catalysts: *in situ* and *ex situ* catalytic MAP [57]. The difference between the two is that during *ex situ* MAP, the biomass and catalyst are not in contact with one another; the volatiles generally pass through a packed-bed catalyst reactor after they leave the quartz reactor where pyrolysis takes place under microwaves.

The most common type of catalysts used in MAP, as with conventional catalytic pyrolysis, are zeolites such as HZSM-5, H-Ferrierite, H-Modernite and H-Y. These catalysts, as mentioned earlier, are very effective in enhancing the properties of bio-oil through cracking [72]. One noteworthy article written by Muley et al. [73] deals with the *ex situ* catalytic upgrading of pine sawdust pyrolysis vapours using a zeolite catalyst in a travelling wave microwave reactor. The authors then compared the results obtained with those from conventional pyrolysis. A catalyst:biomass ratio of 1:2 was used and it was noticed that when catalyst temperature increased, liquid yield slightly decreased. The latter amount was also found to be comparable to that obtained from conventional pyrolysis (25–35%). The use of catalysts resulted in higher amounts of aromatic and aliphatic hydrocarbons while the non-upgraded bio-oil mostly consisted of ketones, phenols, alcohols and aldehydes. The gas yield, on the other hand, increased as the catalyst bed temperature increased. Gas composition went from CO (the highest) to CO<sub>2</sub> to CH<sub>4</sub> to finally, C<sub>2</sub>-C<sub>5</sub> gases (the lowest). No mention of H<sub>2</sub> was made. As for coke, a high C/H ratio was observed for coke that was deposited on the catalyst surface, making it aromatic in nature. This ratio increased with temperature when MAP was used.

A selective summary of recent notable research works published on microwave pyrolysis using zeolites as a catalyst has been presented in Table 6. It should also be noted that the table also contains those performed on pyrolysis or co-pyrolysis of plastic wastes since, as mentioned earlier, more recent research studies have been focusing on this type of feedstock.

Other types of catalysts used in the catalytic MAP of biomass are metal oxides, most commonly NiO, CaO, CuO and MgO [57]. Wu et al. [72] performed the catalytic MAP of waste cooking oil under temperatures ranging from 350 to 550 °C, using CoO, NiO, ZrO<sub>2</sub>, SrO, CeO<sub>2</sub> and CaO as catalysts, both *in-* and *ex situ*. They also studied the reaction using a mixture of different ratios of HZSM-5 and metal oxides. The reactor used was a catalytic MAP system with a frequency of 2450 MHz and a power input of 0–800 W. The microwave-absorber used was 300 g of 5 mm diameter SiC beads.

Their results showed that using higher pyrolytic temperatures increased monocyclic aromatic hydrocarbon formation despite diminishing overall bio-oil yield. However, increasing the temperature from 500 to 500 °C only resulted in a 1.16% increase in benzene-toluene-xylene (BTX) production. Using metal oxides, especially CaO, as a catalyst, promoted the formation of polycyclic aromatic hydrocarbons, which were produced in significantly less proportions when only HZSM-5 was used as a catalyst. The authors also found that an *ex situ* configuration suited co-catalysis of metal oxides and HZSM-5 more than an *in situ* one. The highest BTX yield found by the authors (702.20 mg/mL) was produced at 500 °C, using an HZSM-5:CaO ratio of 2:1 in an *ex situ* configuration. Other researchers have also used metal oxides during their catalytic MAP experimental works. Some significant findings have been summarised in Table 7.

**Table 6.** Summary of recent works on catalytic MAP using zeolites as catalyst.

Feed	Reaction Conditions				Bio-Oil Yield (wt. %)	Results	Ref.
	Catalyst Used	Reactor Used (Power and Frequency)	Temperature (°C)	WHSV (g feed/g cat. h) or F/C Ratio			
Waste cooking oil (WCO) and low-density polyethylene (LDPE)	HZSM-5	Fixed bed (-)	550	2:1	-	WCO:LDPE used was 1:1. Reaction conditions used produced maximum yield of BTX and minimum yield of polyaromatic hydrocarbons. Efficiency of catalysts on formation increased as follows: SAPO-34 < H-β < H-Y < HZSM-5.	[74]
	H-β						
	H-Y						
	SAPO-34						
Corn straw	MCM-41 mixed with ZSM-5	Fixed bed (750 W and 2450 MHz)	450–650	1:2	-	Carbon outputs of aromatics and olefins peaked at 550 °C. Addition of MCM-41 inhibited formation of coke on ZSM-5 surface.	[75]
Rice straw	HZSM-5	Fixed bed (3.2 kW and 2.45 GHz)	500	44.4, 14.7, 11.1 g feed/g cat. h	21.5	Catalytic upgradation of pyrolytic vapours of biomass and polymer mixtures produced de-oxygenated bio-oils with properties similar to conventional fuel oil. WHSP of 11 yielded higher selectivity to unsaturated aliphatics and aromatic hydrocarbons.	[76]
Bagasse					22.4		
PP					74.2		
PS					92.3		
LDPE	NiO	2 stage fixed bed (1.8 kW and 2.45 GHz)	450–600	20:1, 15:1, 10:1, 5:1	32–57	Optimum conditions were found to be 500 °C pyrolysis temperature, 450 °C catalytic temperature and LDPE:H-Y of 10:1. Results obtained at these conditions were 56.53 wt. % oil and 93.80% gasoline-range fraction. Addition of catalysts favoured formation of aromatics and inhibited that of aliphatics.	[53]
	H-Y						

Table 7. Notable works on MAP using metal oxides as catalyst.

Configuration	Catalyst	Feedstock	Microwave Power (W)	Feedstock:Catalyst Ratio	Pyrolytic Temperature (°C)	Findings	Ref.
In situ	NiO, CuO, CaO, MgO	Corn stover	500	10:1–33:1	450–520	The authors found that pyrolysis under an N <sub>2</sub> atmosphere was more efficient than one under a CO <sub>2</sub> atmosphere due to the fact that CO <sub>2</sub> possesses better heat absorbability and so, its use reduced heat for pyrolysis. The catalysts were found to increase maximum temperature and mass reduction ratio, but they also decreased the solids' calorific values. Moreover, use of catalysts diminished PAHs formation, making the bio-oil less toxic.	[77]
In situ	NiO, CuO, CaO, MgO	Sugarcane bagasse	500	10:1–33:1	490–532	Addition of catalysts resulted in an increase in mass reduction ratio and reaction rate, but in a decrease in maximum temperature. Use of NiO and CaO enhanced H <sub>2</sub> production while use of NiO and CuO lessened it. Addition of CaO and MgO improved gas production while NiO and CuO favoured liquid production.	[78]
In situ	CaO, CaCO <sub>3</sub> , NiO, Ni <sub>2</sub> O <sub>3</sub> , $\gamma$ -Al <sub>2</sub> O <sub>3</sub> , TiO <sub>2</sub>	Sewage sludge	700	10:1	-	Addition of catalysts was found to affect temperature evolution of sludge, product distribution and gas composition. The temperature rise rate was found to be highest with CaCO <sub>3</sub> , followed by, respectively, NiO, TiO <sub>2</sub> , Ni <sub>2</sub> O <sub>3</sub> $\approx$ $\gamma$ -Al <sub>2</sub> O <sub>3</sub> and CaO, which caused virtually no temperature rise. Ni-based catalysts used favoured decomposition of organic matters in sludge and highly increased bio-oil and CO-rich syngas yields. CaO gave rise to a H <sub>2</sub> -rich syngas while $\gamma$ -Al <sub>2</sub> O <sub>3</sub> and TiO <sub>2</sub> showed no impact on gas percentage or H <sub>2</sub> :CO ratio.	[79]
In situ	CaO, Fe <sub>2</sub> O <sub>3</sub>	Sludge	-	10:1	500–900	Fe <sub>2</sub> O <sub>3</sub> was found to favour bio-oil production while CaO improved gas formation. The best quality of bio-oil was obtained at 800 °C while using CaO. It was also observed that CaO privileged H <sub>2</sub> formation while Fe <sub>2</sub> O <sub>3</sub> enhanced CH <sub>4</sub> production.	[80]
Ex situ	HZSM-5, MgO	Low-density polyethylene (LDPE)	750	0, 1:2, 1:1 and 2:1	450–600	LDPE was found to be a good H <sub>2</sub> donor to improve bio-oil properties; methoxy phenols were converted to phenols and alkylated phenols. HZSM-5 favoured aromatics production while MgO improved alkylation of phenols. Optimum parameters were found to be 500 °C and feedstock to catalyst ratio of 1:1.	[81]

Apart from zeolites and metal oxides, carbon-based catalysts have also been considered good candidates for catalytic MAP studies as they can act as both catalysts and microwave absorbers [58]. One important research work was led by Omoriyekomwan et al. [82]. The latter studied phenol production from palm kernel shell pyrolysis at 400, 500 and 600 °C using a 2000 W microwave generator. The authors used 10% activated carbon or 20% lignite char as a catalyst. It was found that the addition of the catalysts enabled pyrolysis temperature to increase as biomass alone is a poor microwave absorber. Bio-oil yield also improved with the presence of the catalysts. The highest concentration of total phenolics was 71.24%, with the highest concentration of phenol of 64.58% in bio-oil, was obtained at 500 °C using activated carbon. Other research works performed using carbon-based catalysts for MAP include those made by Zhang et al. [83] and Chen et al. [84]. All in all, significant results included that carbon-based catalysts gave rise to higher heating rates. When these catalysts are doped with metal precursors, syngas yield increased importantly, while bio-oil yield was mostly impacted positively by the use of activated carbon as catalyst.

## 5. Conclusions

Even though conventional and microwave pyrolysis technologies are difficult to put on par because of the presence of microwave irradiation, a comparison between their respective products is helpful to shed some light on their efficiency. Recent research works performed on microwave pyrolysis of different feedstocks with and without the use of catalysts were reviewed in this work. This technology presents very favourable odds of being successfully scaled up to an industrial scale, given its practicality and interesting results. Indeed, given the fact that MAP has proven to have a more rapid volumetric heating, have more precise control and be more energy saving, it can be established to be more interesting than the conventional means of performing pyrolysis. However, as of today, the most common type of reactor used for industrial pyrolysis applications is the fluidised bed reactor [85]. MAP being a fairly recent technology, most of the research was conducted on fixed bed reactors. Few studies have been performed in FBR and they have mostly shown that these reactors need a fair microwave power for efficient pyrolysis to take place. So as to find a valid compromise, the use of an eco-friendly microwave absorber such as bio-char may be warranted. However, more detailed studies such as studying the reaction kinetics and numerical simulation of the overall process need to be performed in this direction so as to prove this technology's worth in being used in upcoming industrial applications.

**Author Contributions:** Investigation, C.M.; writing—original draft preparation, C.M.; writing—review and editing, N.G., D.L. and Y.S.; supervision, Y.S.; funding acquisition, Y.S. All authors have read and agreed to the published version of the manuscript.

**Funding:** This project has received funding from the European Union's Horizon 2020 research and innovation programme "Waste2Road" under grant agreement N° 818120.

**Data Availability Statement:** Not applicable.

**Conflicts of Interest:** The authors declare no conflict of interest.

## References

1. Motasemi, F.; Afzal, M.T. A review on the microwave-assisted pyrolysis technique. *Renew. Sustain. Energy Rev.* **2013**, *28*, 317–330. [[CrossRef](#)]
2. Hemansi; Gupta, R.; Yadav, G.; Kumar, G.; Yadav, A.; Saini, J.K.; Kuhad, R.C. Second Generation Bioethanol Production: The State of Art. In *Sustainable Approaches for Biofuels Production Technologies: From Current Status to Practical Implementation*; Srivastava, N., Srivastava, M., Mishra, P.K., Upadhyay, S.N., Ramteke, P.W., Gupta, V.K., Eds.; Springer International Publishing: Cham, Switzerland, 2019; pp. 121–146. [[CrossRef](#)]
3. Maj, G.; Najda, A.; Klimek, K.; Balant, S. Estimation of Energy and Emissions Properties of Waste from Various Species of Mint in the Herbal Products Industry. *Energies* **2020**, *13*, 55. [[CrossRef](#)]
4. Bridgwater, A.V. Review of fast pyrolysis of biomass and product upgrading. *Biomass Bioenergy* **2012**, *38*, 68–94. [[CrossRef](#)]

5. Mettler, M.S.; Vlachos, D.G.; Dauenhauer, P.J. Top ten fundamental challenges of biomass pyrolysis for biofuels. *Energy Environ. Sci.* **2012**, *5*, 7797–7809. [CrossRef]
6. Oasmaa, A.; Czernik, S. Fuel Oil Quality of Biomass Pyrolysis Oils State of the Art for the End Users. *Energy Fuels* **1999**, *13*, 914–921. [CrossRef]
7. Venderbosch, R.H. Fast Pyrolysis. In *Thermochemical Processing of Biomass*; John Wiley & Sons, Ltd.: Hoboken, NJ, USA, 2019; pp. 175–206. [CrossRef]
8. Onwudili, J.; Insura, N.; Williams, P. Composition of products from the pyrolysis of polyethylene and polystyrene in a closed batch reactor: Effects of temperature and residence time. *J. Anal. Appl. Pyrolysis* **2009**, *86*, 293–303. [CrossRef]
9. Deglise, X. La gazéification thermo-chimique: Histoire et développement de la recherche. In *Colloque ATEE/CIBE: Cogénération Biomasse Dans L'industrie Et Sur Les Réseaux de Chaleur*; 2007; p. 39. Available online: [https://cibe.fr/wp-content/uploads/2017/01/12\\_-\\_Historique\\_gazeification.pdf](https://cibe.fr/wp-content/uploads/2017/01/12_-_Historique_gazeification.pdf) (accessed on 28 April 2022).
10. Fagbemi, L.; Khezami, L.; Capart, R. Pyrolysis products from different biomasses: Application to the thermal cracking of tar. *Appl. Energy* **2001**, *69*, 293–306. [CrossRef]
11. Rousset, P. From Biomass to Fuel, Power and Chemicals Brazilian Charcoal-Based Pig Iron. 2014. Available online: <http://agritrop.cirad.fr/578836/> (accessed on 6 August 2018).
12. Garcia-Nunez, J.A.; Pelaez-Samaniego, M.R.; Garcia-Perez, M.; Fonts, I.; Ábrego, J.; Westerhof, R.J.M. Historical Developments of Pyrolysis Reactors: A Review. *Energy Fuels* **2017**, *31*, 5751–5775. [CrossRef]
13. Jiang, J.; Xu, J.; Song, Z. Review of the direct thermochemical conversion of lignocellulosic biomass for liquid fuels. *Front. Agric. Sci. Eng.* **2015**, *2*, 13–27. [CrossRef]
14. Ronsse, F. Biochar Production. In *Biochar*; Bruckman, V.J., Apaydin Varol, E., Uzun, B.B., Liu, J., Eds.; Cambridge University Press: Cambridge, UK, 2016; pp. 199–226. [CrossRef]
15. Lam, S.S.; Liew, R.K.; Jusoh, A.; Chong, C.T.; Ani, F.N.; Chase, H.A. Progress in waste oil to sustainable energy, with emphasis on pyrolysis techniques. *Renew. Sustain. Energy Rev.* **2016**, *53*, 741–753. [CrossRef]
16. Qureshi, K.M.; Lup, A.N.K.; Khan, S.; Abnisa, F.; Daud, W.M.A.W. A technical review on semi-continuous and continuous pyrolysis process of biomass to bio-oil. *J. Anal. Appl. Pyrolysis* **2018**, *131*, 52–75. [CrossRef]
17. Mohabeer, C.; Reyes, L.; Abdelouahed, L.; Marcotte, S.; Buvat, J.-C.; Tidahy, L.; Abi-Aad, E.; Taouk, B. Production of liquid bio-fuel from catalytic de-oxygenation: Pyrolysis of beech wood and flax shives. *J. Fuel Chem. Technol.* **2019**, *47*, 153–166. [CrossRef]
18. Si, Z.; Zhang, X.; Wang, C.; Ma, L.; Dong, R. An Overview on Catalytic Hydrodeoxygenation of Pyrolysis Oil and Its Model Compounds. *Catalysts* **2017**, *7*, 169. [CrossRef]
19. Ambursa, M.M.; Juan, J.C.; Yahaya, Y.; Taufiq-Yap, Y.; Lin, Y.-C.; Lee, H.V. A review on catalytic hydrodeoxygenation of lignin to transportation fuels by using nickel-based catalysts. *Renew. Sustain. Energy Rev.* **2021**, *138*, 110667. [CrossRef]
20. Wang, X.; Arai, M.; Wu, Q.; Zhang, C.; Zhao, F. Hydrodeoxygenation of lignin-derived phenolics—A review on the active sites of supported metal catalysts. *Green Chem.* **2020**, *22*, 8140–8168. [CrossRef]
21. Bui, V.N.; Laurenti, D.; Afanasiev, P.; Geantet, C. Hydrodeoxygenation of guaiacol with CoMo catalysts. Part I: Promoting effect of cobalt on HDO selectivity and activity. *Appl. Catal. B Environ.* **2011**, *101*, 239–245. [CrossRef]
22. Bui, V.N.; Laurenti, D.; Delichère, P.; Geantet, C. Hydrodeoxygenation of guaiacol: Part II: Support effect for CoMoS catalysts on HDO activity and selectivity. *Appl. Catal. B Environ.* **2011**, *101*, 246–255. [CrossRef]
23. Bykova, M.; Ermakov, D.; Kaichev, V.; Bulavchenko, O.; Saraev, A.; Lebedev, M.; Yakovlev, V. Ni-based sol-gel catalysts as promising systems for crude bio-oil upgrading: Guaiacol hydrodeoxygenation study. *Appl. Catal. B Environ.* **2012**, *113–114*, 296–307. [CrossRef]
24. Oh, S.; Choi, H.S.; Choi, I.-G.; Choi, J.W. Evaluation of hydrodeoxygenation reactivity of pyrolysis bio-oil with various Ni-based catalysts for improvement of fuel properties. *RSC Adv.* **2017**, *7*, 15116–15126. [CrossRef]
25. Coumans, A.; Hensen, E. A real support effect on the hydrodeoxygenation of methyl oleate by sulfided NiMo catalysts. *Catal. Today* **2017**, *298*, 181–189. [CrossRef]
26. Wang, W.; Zhang, C.; Chen, G.; Zhang, R. Influence of CeO<sub>2</sub> Addition to Ni-Cu/HZSM-5 Catalysts on Hydrodeoxygenation of Bio-Oil. *Appl. Sci.* **2019**, *9*, 1257. [CrossRef]
27. Funkenbusch, L.T.; Mullins, M.E.; Salam, M.A.; Creaser, D.; Olsson, L. Catalytic hydrotreatment of pyrolysis oil phenolic compounds over Pt/Al<sub>2</sub>O<sub>3</sub> and Pd/C. *Fuel* **2019**, *243*, 441–448. [CrossRef]
28. Ly, H.V.; Kim, J.; Hwang, H.T.; Choi, J.H.; Woo, H.C.; Kim, S.-S. Catalytic Hydrodeoxygenation of Fast Pyrolysis Bio-Oil from *Saccharina japonica* Alga for Bio-Oil Upgrading. *Catalysts* **2019**, *9*, 1043. [CrossRef]
29. Kavimonica, V.; Parasuraman, S.; Ravikrishnan, V. Kinetic Studies of Catalytic Upgradation of Biomass Model Compounds Using Analytical Py-gc/ms. *Chem. Eng. Trans.* **2020**, *80*, 1–6. [CrossRef]
30. Tran, Q.K.; Han, S.; Ly, H.V.; Kim, S.-S.; Kim, J. Hydrodeoxygenation of a bio-oil model compound derived from woody biomass using spray-pyrolysis-derived spherical  $\gamma$ -Al<sub>2</sub>O<sub>3</sub>-SiO<sub>2</sub> catalysts. *J. Ind. Eng. Chem.* **2020**, *92*, 243–251. [CrossRef]
31. Williams, P.; Horne, P.A. The influence of catalyst type on the composition of upgraded biomass pyrolysis oils. *J. Anal. Appl. Pyrolysis* **1995**, *31*, 39–61. [CrossRef]
32. Park, H.J.; Dong, J.I.; Jeon, J.K.; Yoo, K.S.; Yim, J.H.; Sohn, J.M.; Park, Y.K. Conversion of the Pyrolytic Vapor of Radiata Pine over Zeolites. *J. Ind. Eng. Chem.* **2007**, *13*, 182–189.

33. Park, H.J.; Park, Y.K.; Kim, J.S.; Jeon, J.K.; Yoo, K.S.; Yim, J.H.; Sohn, J.M. Bio-oil upgrading over Ga modified zeolites in a bubbling fluidized bed reactor. In *Studies in Surface Science and Catalysis*; Rhee, H.-K., Nam, I.-S., Park, J.M., Eds.; Elsevier: Amsterdam, The Netherlands, 2006; Volume 159, pp. 553–556. [CrossRef]
34. Park, H.J.; Heo, H.S.; Jeon, J.-K.; Kim, J.; Ryoo, R.; Jeong, K.-E.; Park, Y.-K. Highly valuable chemicals production from catalytic upgrading of radiata pine sawdust-derived pyrolytic vapors over mesoporous MFI zeolites. *Appl. Catal. B Environ.* **2010**, *95*, 365–373. [CrossRef]
35. Aho, A.; Kumar, N.; Lashkul, A.; Eränen, K.; Ziolk, M.; Decyk, P.; Salmi, T.; Holmbom, B.; Hupa, M.; Murzin, D.Y. Catalytic upgrading of woody biomass derived pyrolysis vapours over iron modified zeolites in a dual-fluidized bed reactor. *Fuel* **2010**, *89*, 1992–2000. [CrossRef]
36. Zhang, H.; Carlson, T.R.; Xiao, R.; Huber, G.W. Catalytic fast pyrolysis of wood and alcohol mixtures in a fluidized bed reactor. *Green Chem.* **2012**, *14*, 98–110. [CrossRef]
37. Murata, K.; Liu, Y.; Inaba, M.; Takahara, I. Catalytic fast pyrolysis of jatropha wastes. *J. Anal. Appl. Pyrolysis* **2012**, *94*, 75–82. [CrossRef]
38. Choi, S.J.; Park, S.H.; Jeon, J.-K.; Lee, I.G.; Ryu, C.; Suh, D.J.; Park, Y.-K. Catalytic conversion of particle board over microporous catalysts. *Renew. Energy* **2013**, *54*, 105–110. [CrossRef]
39. Guda, V.K.; Toghiani, H. Catalytic upgrading of pinewood fast pyrolysis vapors using an integrated Auger-packed bed reactor system: Effects of acid catalysts on yields and distribution of pyrolysis products. *J. For. Prod. Ind.* **2015**, *4*, 33–43.
40. Jia, L.Y.; Raad, M.; Hamieh, S.; Toufaily, J.; Hamieh, T.; Bettahar, M.M.; Mauviel, G.; Tarrighi, M.; Pinard, L.; Dufour, A. Catalytic fast pyrolysis of biomass: Superior selectivity of hierarchical zeolites to aromatics. *Green Chem.* **2017**, *19*, 5442–5459. [CrossRef]
41. Kaminsky, W. Chemical recycling of plastics by fluidized bed pyrolysis. *Fuel Commun.* **2021**, *8*, 100023. [CrossRef]
42. Huang, Y.-F.; Chiueh, P.-T.; Lo, S.-L. A review on microwave pyrolysis of lignocellulosic biomass. *Sustain. Environ. Res.* **2016**, *26*, 103–109. [CrossRef]
43. Zlotorzynski, A. The Application of Microwave Radiation to Analytical and Environmental Chemistry. *Crit. Rev. Anal. Chem.* **1995**, *25*, 43–76. [CrossRef]
44. van Loock, W. European Regulations, Safety Issues in RF and Microwave Power. In *Advances in Microwave and Radio Frequency Processing*; Springer: Berlin/Heidelberg, Germany, 2006; pp. 85–91. [CrossRef]
45. CEM Corporation. Microwave Heating-Mechanism and Theory. 2020. Available online: <https://cem.com/de/microwave-heating-mechanism-and-theory> (accessed on 30 March 2022).
46. Kappe, C.O.; Stadler, A.; Dallinger, D. *Microwaves in Organic and Medicinal Chemistry*; John Wiley & Sons: Hoboken, NJ, USA, 2012.
47. Xie, Q. Fast Microwave-Assisted Thermochemical Conversion of Biomass for Biofuel Production. 2015. Available online: <http://conservancy.umn.edu/handle/11299/177123> (accessed on 14 September 2021).
48. Nomanbhay, S.; Salman, B.; Hussain, R.; Ong, M.Y. Microwave pyrolysis of lignocellulosic biomass—A contribution to power Africa. *Energy Sustain. Soc.* **2017**, *7*, 23. [CrossRef]
49. Prielcel, P.; Lopez-Sanchez, J.A. Advantages and Limitations of Microwave Reactors: From Chemical Synthesis to the Catalytic Valorization of Biobased Chemicals. *ACS Sustain. Chem. Eng.* **2018**, *7*, 3–21. [CrossRef]
50. Quitain, A.T.; Sasaki, M.; Goto, M. Microwave-Based Pretreatment for Efficient Biomass-to-Biofuel Conversion. In *Pretreatment Techniques for Biofuels and Biorefineries*; Fang, Z., Ed.; Springer: Berlin/Heidelberg, Germany, 2013; pp. 117–130. [CrossRef]
51. Lam, S.S.; Chase, H.A. A Review on Waste to Energy Processes Using Microwave Pyrolysis. *Energies* **2012**, *5*, 4209–4232. [CrossRef]
52. Ding, K.; Liu, S.; Huang, Y.; Liu, S.; Zhou, N.; Peng, P.; Wang, Y.; Chen, P.; Ruan, R. Catalytic microwave-assisted pyrolysis of plastic waste over NiO and HY for gasoline-range hydrocarbons production. *Energy Convers. Manag.* **2019**, *196*, 1316–1325. [CrossRef]
53. Ethaib, S.; Omar, R.; Kamal, S.M.M.; Biak, D.R.A.; Zubaidi, S.L. Microwave-Assisted Pyrolysis of Biomass Waste: A Mini Review. *Processes* **2020**, *8*, 1190. [CrossRef]
54. Ge, S.; Shi, Y.; Xia, C.; Huang, Z.; Manzo, M.; Cai, L.; Ma, H.; Zhang, S.; Jiang, J.; Sonne, C.; et al. Progress in pyrolysis conversion of waste into value-added liquid pyro-oil, with focus on heating source and machine learning analysis. *Energy Convers. Manag.* **2021**, *245*, 114638. [CrossRef]
55. Giorcelli, M.; Das, O.; Sas, G.; Försth, M.; Bartoli, M. A Review of Bio-Oil Production through Microwave-Assisted Pyrolysis. *Processes* **2021**, *9*, 561. [CrossRef]
56. Morgan, H.M.; Bu, Q.; Liang, J.; Liu, Y.; Mao, H.; Shi, A.; Lei, H.; Ruan, R. A review of catalytic microwave pyrolysis of lignocellulosic biomass for value-added fuel and chemicals. *Bioresour. Technol.* **2017**, *230*, 112–121. [CrossRef]
57. State, R.N.; Volceanov, A.; Muley, P.; Boldor, D. A review of catalysts used in microwave assisted pyrolysis and gasification. *Bioresour. Technol.* **2019**, *277*, 179–194. [CrossRef]
58. Suresh, A.; Alagusundaram, A.; Kumar, P.S.; Vo, D.-V.N.; Christopher, F.C.; Balaji, B.; Viswanathan, V.; Sankar, S. Microwave pyrolysis of coal, biomass and plastic waste: A review. *Environ. Chem. Lett.* **2021**, *19*, 3609–3629. [CrossRef]
59. Muley, P.D.; Wang, Y.; Hu, J.; Shekhawat, D. Microwave-assisted heterogeneous catalysis. *Catalysis* **2021**, *33*, 1–37. [CrossRef]
60. Mokhtar, N.M.; Ethaib, S.; Omar, R. Effects of microwave absorbers on the products of microwave pyrolysis of oily sludge. *J. Eng. Sci. Technol.* **2018**, *13*, 3313–3330.
61. Du, Z.; Li, Y.; Wang, X.; Wan, Y.; Chen, Q.; Wang, C.; Lin, X.; Liu, Y.; Chen, P.; Ruan, R. Microwave-assisted pyrolysis of microalgae for biofuel production. *Bioresour. Technol.* **2011**, *102*, 4890–4896. [CrossRef]

62. Hu, Z.; Ma, X.; Chen, C. A study on experimental characteristic of microwave-assisted pyrolysis of microalgae. *Bioresour. Technol.* **2012**, *107*, 487–493. [[CrossRef](#)] [[PubMed](#)]
63. Tian, Y.; Zuo, W.; Ren, Z.; Chen, D. Estimation of a novel method to produce bio-oil from sewage sludge by microwave pyrolysis with the consideration of efficiency and safety. *Bioresour. Technol.* **2011**, *102*, 2053–2061. [[CrossRef](#)] [[PubMed](#)]
64. Yu, F.; Deng, S.; Chen, P.; Liu, Y.; Wan, Y.; Olson, A.; Kittelson, D.; Ruan, R. Physical and chemical properties of bio-oils from microwave pyrolysis of corn stover. *Appl. Biochem. Biotechnol.* **2007**, *137–140*, 957–970. [[CrossRef](#)]
65. Domínguez, A.; Menéndez, J.A.; Inguanzo, M.; Bernad, P.L.; Pis, J.J. Gas chromatographic–mass spectrometric study of the oil fractions produced by microwave-assisted pyrolysis of different sewage sludges. *J. Chromatogr. A* **2003**, *1012*, 193–206. [[CrossRef](#)]
66. Fernández, Y.; Menéndez, J. Influence of feed characteristics on the microwave-assisted pyrolysis used to produce syngas from biomass wastes. *J. Anal. Appl. Pyrolysis* **2011**, *91*, 316–322. [[CrossRef](#)]
67. Liu, Y.; Chen, T.; Gao, B.; Meng, R.; Zhou, P.; Chen, G.; Zhan, Y.; Lu, W.; Wang, H. Comparison between hydrogen-rich biogas production from conventional pyrolysis and microwave pyrolysis of sewage sludge: Is microwave pyrolysis always better in the whole temperature range? *Int. J. Hydrogen Energy* **2021**, *46*, 23322–23333. [[CrossRef](#)]
68. Salema, A.; Ani, F.N. Microwave induced pyrolysis of oil palm biomass. *Bioresour. Technol.* **2011**, *102*, 3388–3395. [[CrossRef](#)]
69. Adam, M.; Beneroso, D.; Katrib, J.; Kingman, S.; Robinson, J.P. Microwave fluidized bed for biomass pyrolysis. Part I: Process design. *Biofuels Bioprod. Biorefining* **2017**, *11*, 601–612. [[CrossRef](#)]
70. Ong, H.C.; Chen, W.-H.; Farooq, A.; Gan, Y.Y.; Lee, K.T.; Ashokkumar, V. Catalytic thermochemical conversion of biomass for biofuel production: A comprehensive review. *Renew. Sustain. Energy Rev.* **2019**, *113*, 109266. [[CrossRef](#)]
71. Ge, S.; Yek, P.N.Y.; Cheng, Y.W.; Xia, C.; Mahari, W.A.W.; Liew, R.K.; Peng, W.; Yuan, T.-Q.; Tabatabaei, M.; Aghbashlo, M.; et al. Progress in microwave pyrolysis conversion of agricultural waste to value-added biofuels: A batch to continuous approach. *Renew. Sustain. Energy Rev.* **2021**, *135*, 110148. [[CrossRef](#)]
72. Wu, Q.; Wang, Y.; Peng, Y.; Ke, L.; Yang, Q.; Jiang, L.; Dai, L.; Liu, Y.; Ruan, R.; Xia, D.; et al. Microwave-assisted pyrolysis of waste cooking oil for hydrocarbon bio-oil over metal oxides and HZSM-5 catalysts. *Energy Conv. Manag.* **2020**, *220*, 113124. [[CrossRef](#)]
73. Muley, P.; Henkel, C.; Aguilar, G.; Klasson, K.; Boldor, D. Ex situ thermo-catalytic upgrading of biomass pyrolysis vapors using a traveling wave microwave reactor. *Appl. Energy* **2016**, *183*, 995–1004. [[CrossRef](#)]
74. Zeng, Y.; Wang, Y.; Liu, Y.; Dai, L.; Wu, Q.; Xia, M.; Zhang, S.; Ke, L.; Zou, R.; Ruan, R. Microwave catalytic co-pyrolysis of waste cooking oil and low-density polyethylene to produce monocyclic aromatic hydrocarbons: Effect of different catalysts and pyrolysis parameters. *Sci. Total Environ.* **2022**, *809*, 152182. [[CrossRef](#)] [[PubMed](#)]
75. Xue, Z.; Zhong, Z.; Zhang, B. Microwave-Assisted Catalytic Fast Pyrolysis of Biomass for Hydrocarbon Production with Physically Mixed MCM-41 and ZSM-5. *Catalysts* **2020**, *10*, 685. [[CrossRef](#)]
76. Suriapparao, D.V.; Vinu, R.; Shukla, A.; Haldar, S. Effective deoxygenation for the production of liquid biofuels via microwave assisted co-pyrolysis of agro residues and waste plastics combined with catalytic upgradation. *Bioresour. Technol.* **2020**, *302*, 122775. [[CrossRef](#)]
77. Huang, Y.-F.; Kuan, W.-H.; Chang, C.-C.; Tzou, Y.-M. Catalytic and atmospheric effects on microwave pyrolysis of corn stover. *Bioresour. Technol.* **2013**, *131*, 274–280. [[CrossRef](#)]
78. Kuan, W.-H.; Huang, Y.-F.; Chang, C.-C.; Lo, S.-L. Catalytic pyrolysis of sugarcane bagasse by using microwave heating. *Bioresour. Technol.* **2013**, *146*, 324–329. [[CrossRef](#)]
79. Yu, Y.; Yu, J.; Sun, B.; Yan, Z. Influence of catalyst types on the microwave-induced pyrolysis of sewage sludge. *J. Anal. Appl. Pyrolysis* **2014**, *106*, 86–91. [[CrossRef](#)]
80. Ma, R.; Huang, X.; Zhou, Y.; Fang, L.; Sun, S.; Zhang, P.; Zhang, X.; Zhao, X. The effects of catalysts on the conversion of organic matter and bio-fuel production in the microwave pyrolysis of sludge at different temperatures. *Bioresour. Technol.* **2017**, *238*, 616–623. [[CrossRef](#)]
81. Fan, L.; Chen, P.; Zhang, Y.; Liu, S.; Liu, Y.; Wang, Y.; Dai, L.; Ruan, R. Fast microwave-assisted catalytic co-pyrolysis of lignin and low-density polyethylene with HZSM-5 and MgO for improved bio-oil yield and quality. *Bioresour. Technol.* **2017**, *225*, 199–205. [[CrossRef](#)]
82. Omoriyekomwan, J.E.; Tahmasebi, A.; Yu, J. Production of phenol-rich bio-oil during catalytic fixed-bed and microwave pyrolysis of palm kernel shell. *Bioresour. Technol.* **2016**, *207*, 188–196. [[CrossRef](#)] [[PubMed](#)]
83. Zhang, S.; Dong, Q.; Zhang, L.; Xiong, Y. High quality syngas production from microwave pyrolysis of rice husk with char-supported metallic catalysts. *Bioresour. Technol.* **2015**, *191*, 17–23. [[CrossRef](#)] [[PubMed](#)]
84. Chen, W.; Chen, Y.; Yin, J.; Li, Z. Bi-objective Mixed Optimal Planning for Distributed Energy Storage System of Active Distribution System. In Proceedings of the 2018 8th International Conference on Power and Energy Systems (ICPES), Colombo, Sri Lanka, 21–22 December 2018; pp. 34–39. [[CrossRef](#)]
85. Guda, V.K.; Steele, P.H.; Penmetsa, V.K.; Li, Q. Chapter 7-Fast Pyrolysis of Biomass: Recent Advances in Fast Pyrolysis Technology. In *Recent Advances in Thermo-Chemical Conversion of Biomass*; Pandey, A., Bhaskar, T., Stöcker, M., Sukumaran, R.K., Eds.; Elsevier: Boston, MA, USA, 2015; pp. 177–211. [[CrossRef](#)]