

Brain mechanisms for foveating a visual target here-and-now (i.e., where it is and when it is there)

Laurent Goffart

CNRS

Laurent.Goffart@univ-amu.fr

Two types of goal-directed foveating movements

rapid : saccade

slow : smooth pursuit

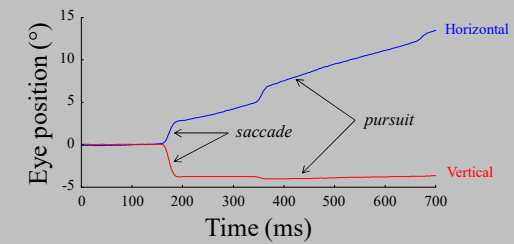

Two types of goal-directed foveating movements

rapid : saccade

slow : smooth pursuit

Ultimately, they involve separate populations of neurons

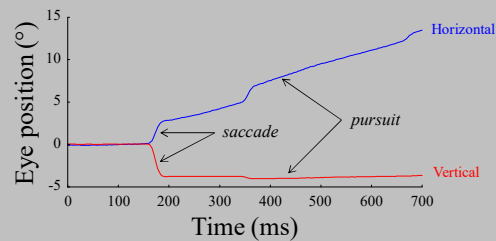

The saccade :

a rapid and accurate transition between *dynamic equilibrium states*

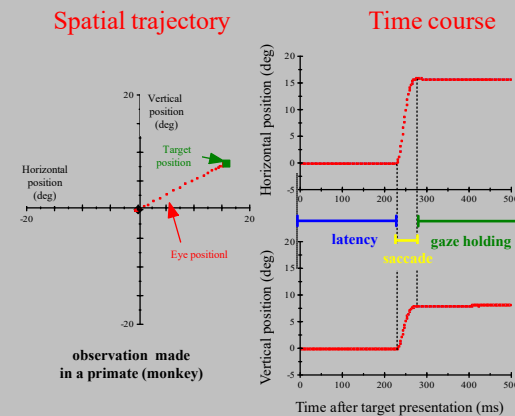

The saccade : a reaction shared by most animals

Amphibian



Schülert & Dicke J. Exp Biol 2002

Insect



Goffart & Yamawaki in preparation

Crustacean

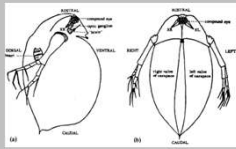

Body Size : approx. 2-3 mm

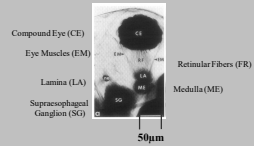

The saccade : A transition which is *irreversible* and *goal-directed*

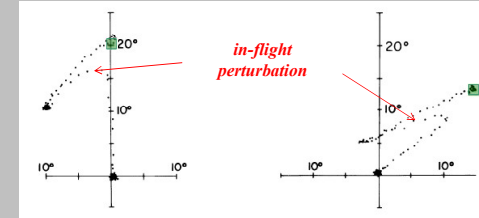

Sparks & Mays J Neurophysiol 1983

observation made
in a primate (monkey)

Extra-ocular muscles

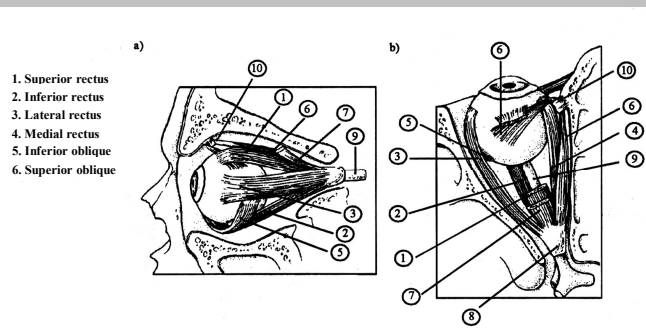

Horizontal rotation

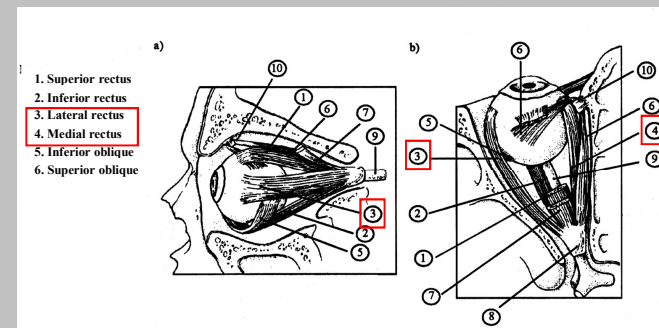

Upward rotation

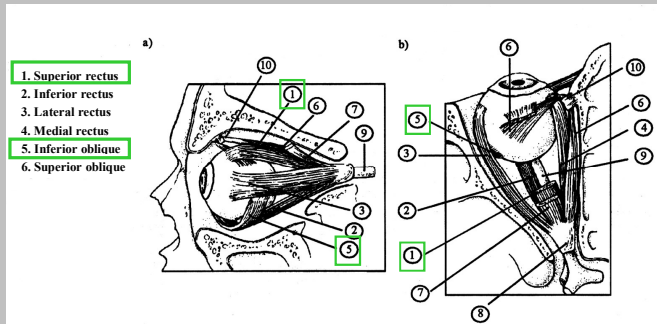

Downward rotation

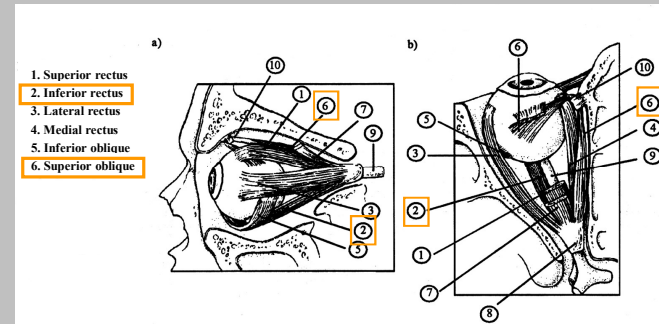

Vector decomposition and synergy

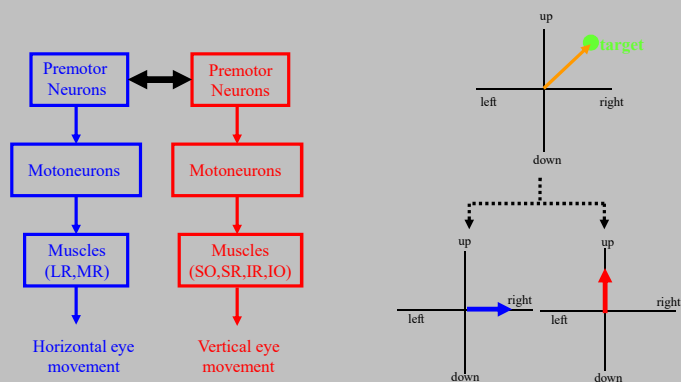

Synergy between H and V components

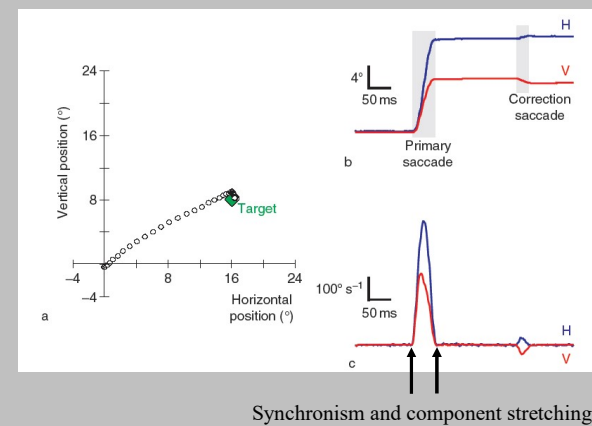

The horizontal saccade generator

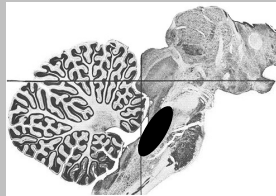

Relaxation of antagonist muscles

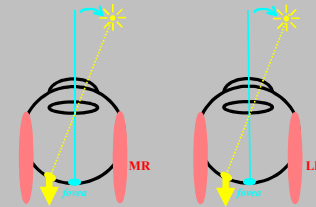

Contraction of agonist muscles

LR : Lateral Rectus
MR : Medial Rectus

Relaxation of antagonist muscles

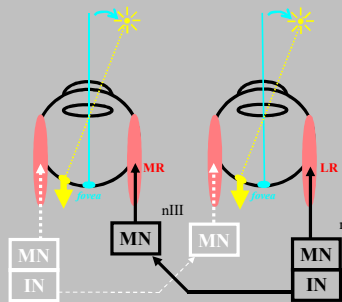

Contraction of agonist muscles

nVI = Abducens Nucleus
nIII = Oculomotor Nucleus

Phasic command

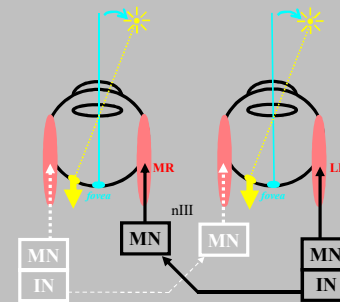

Contraction of agonist muscles

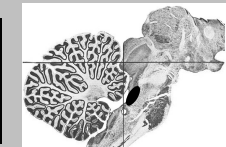

EBN = Excitatory Burst Neurons (Paramedian Pontine RF)

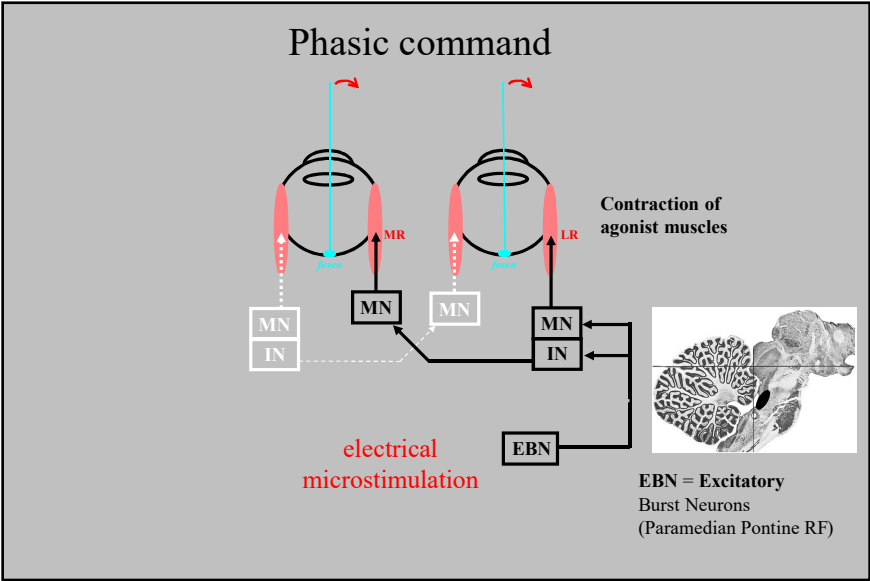
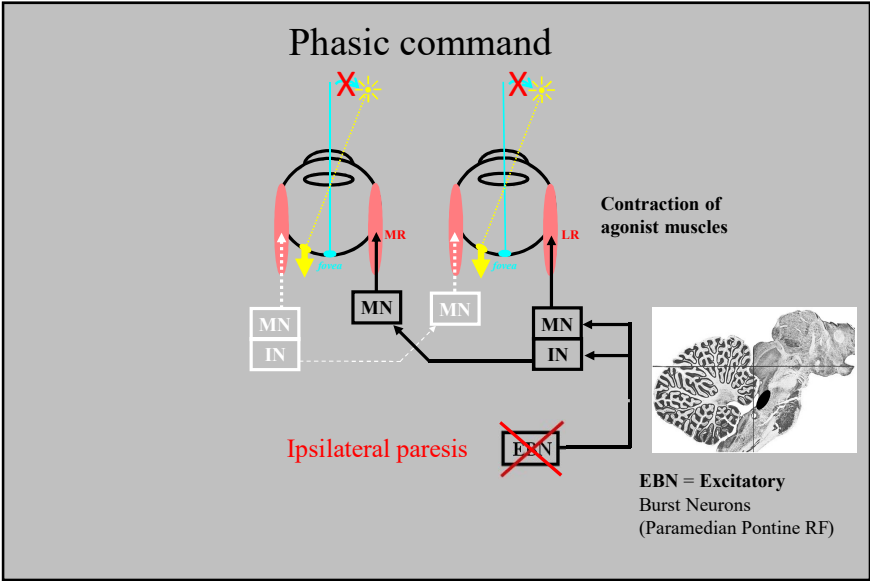
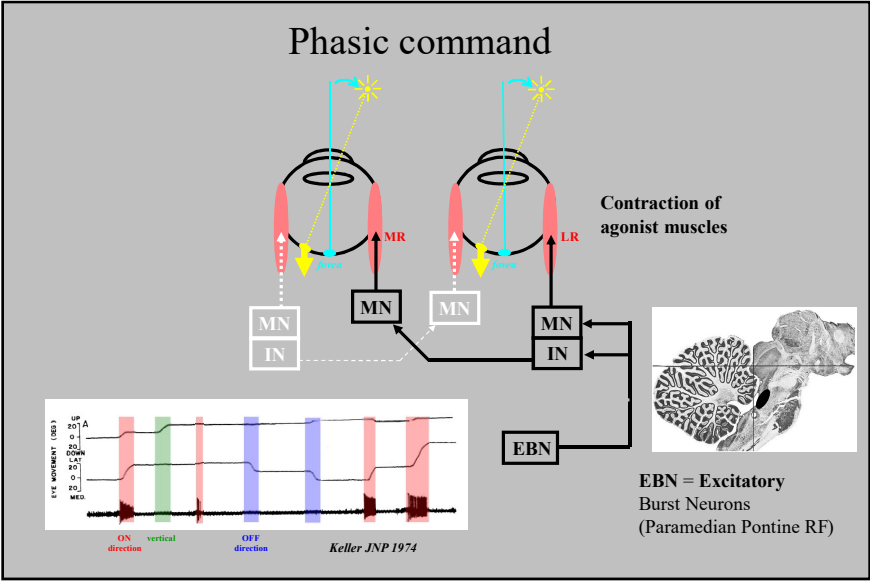
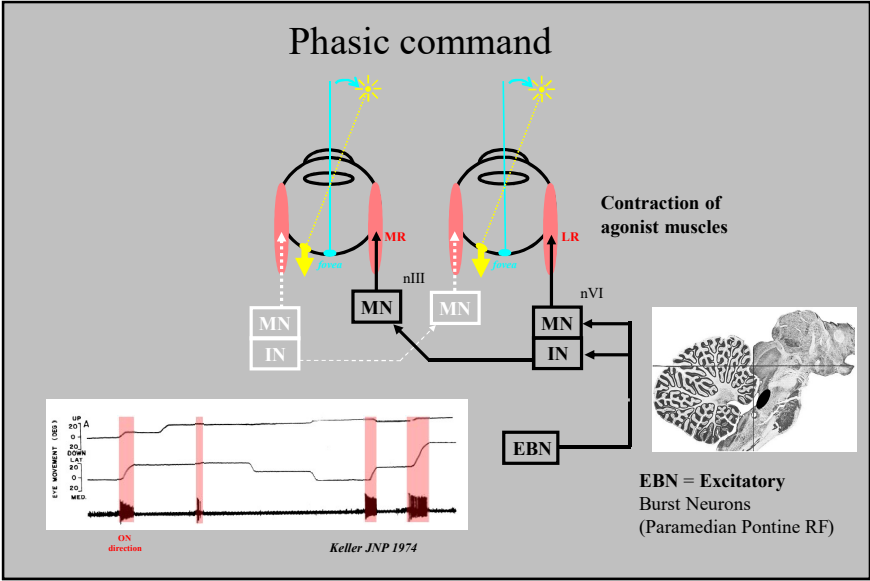

Reciprocal innervation (push-pull)

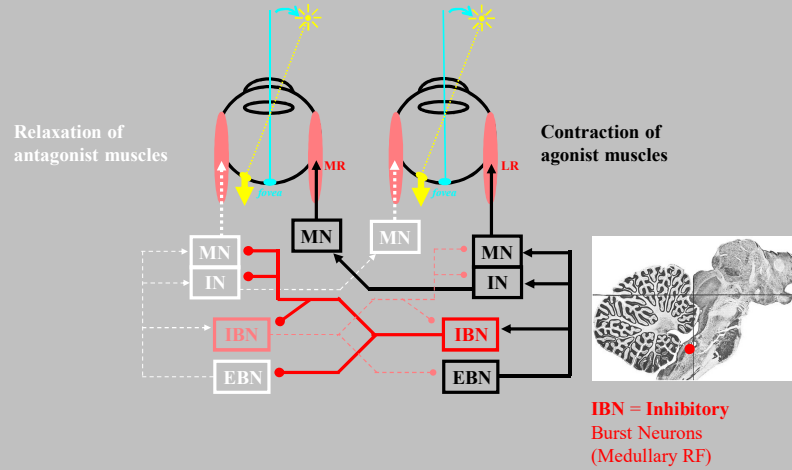

Reciprocal innervation (push-pull)

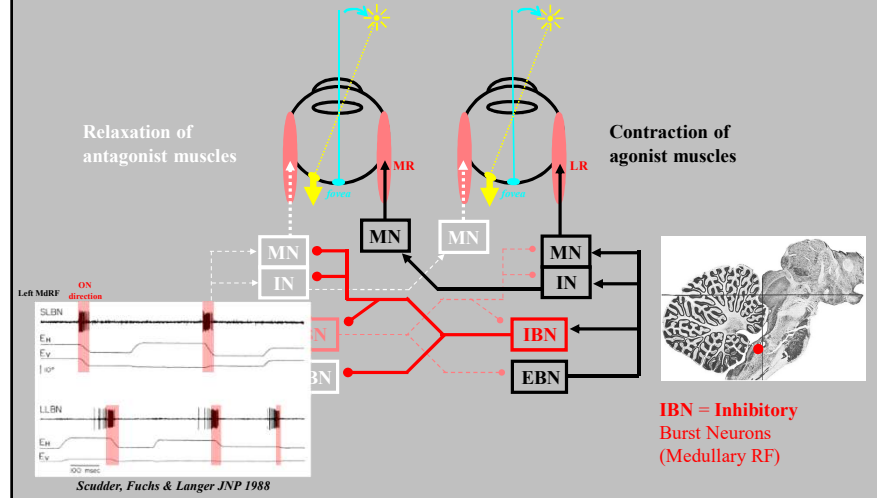

Reciprocal innervation (push-pull)

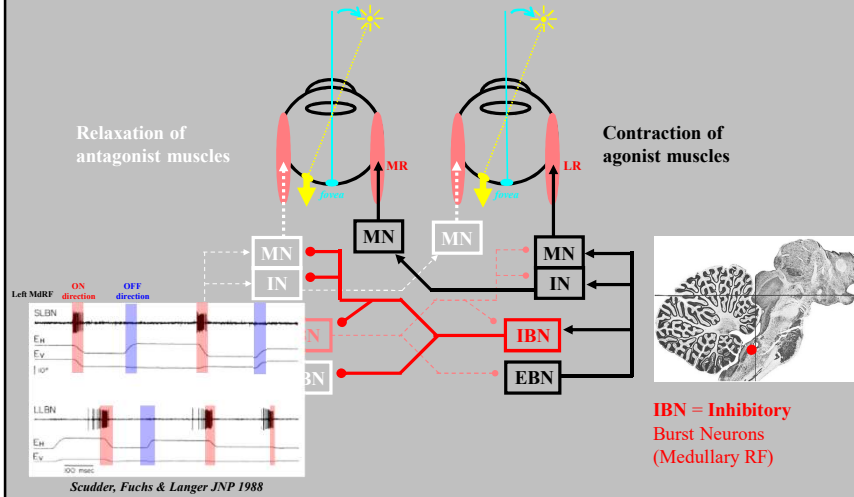

Bilateral phasic command

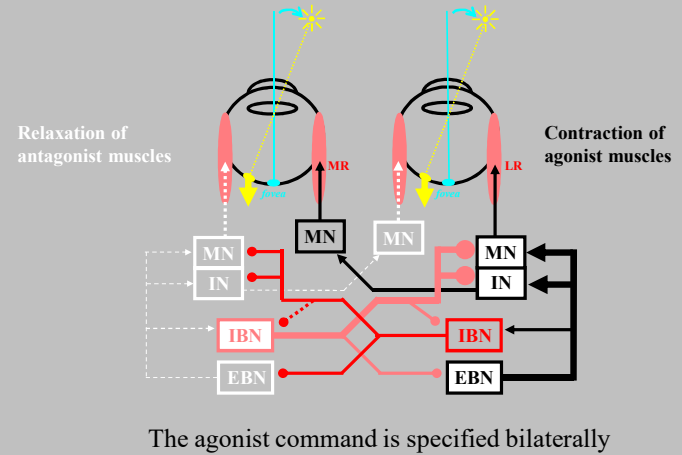

Bilateral phasic command

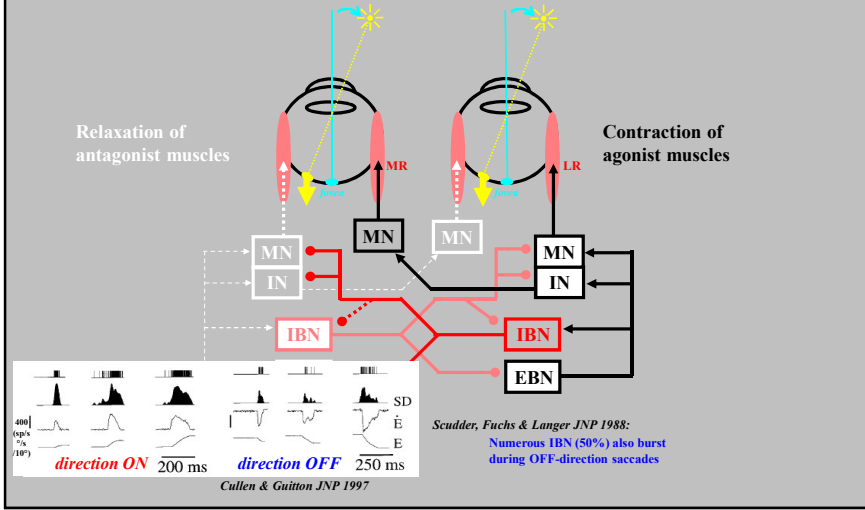

Bilateral phasic command

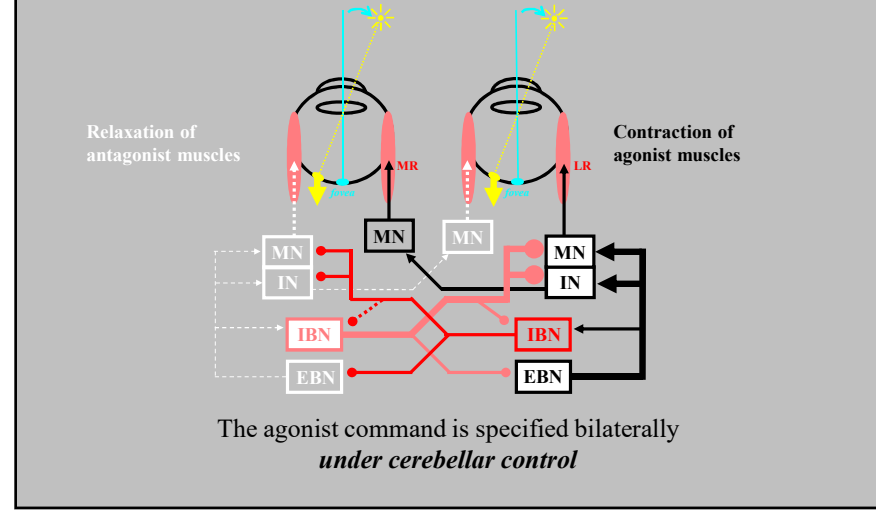

Tonic command (gaze holding)

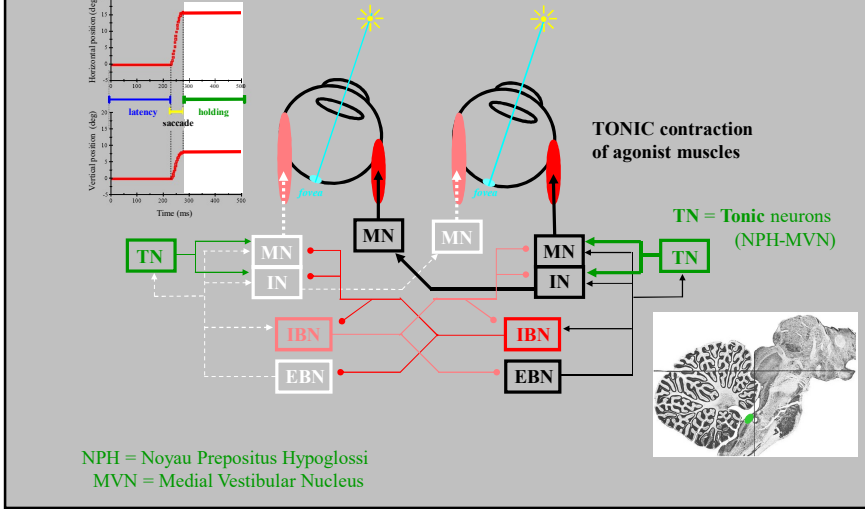

Tonic command (gaze holding)

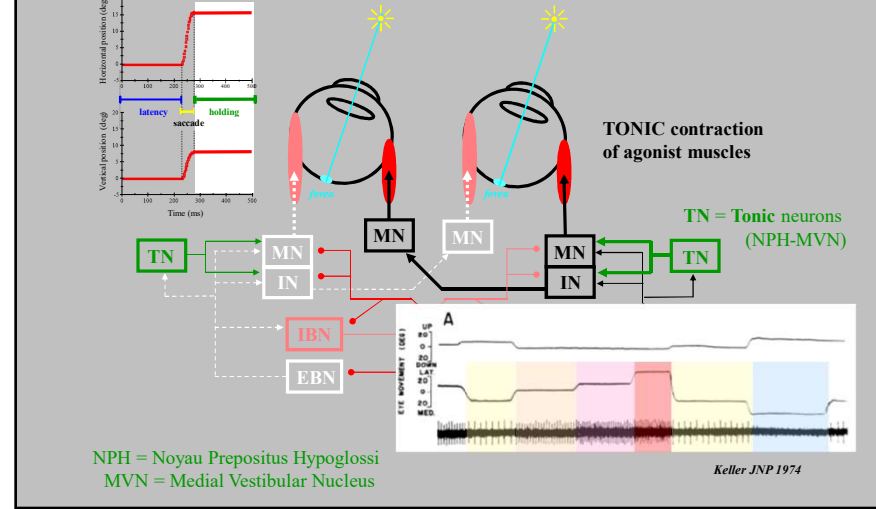

Tonic command (gaze holding)

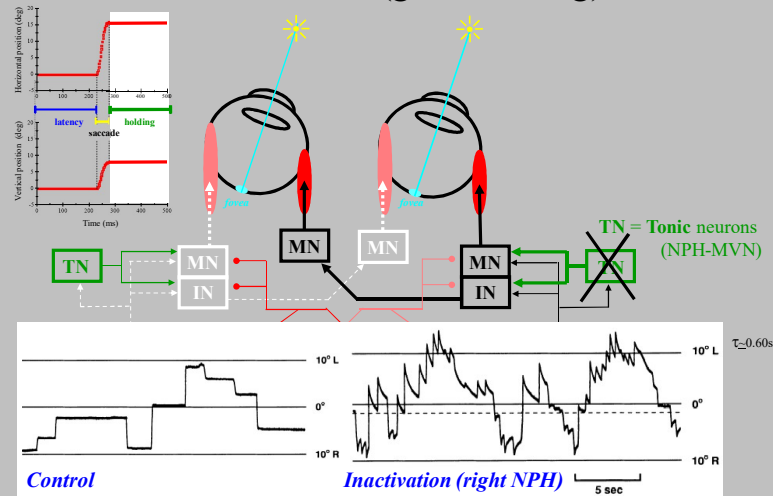

Slow eye movement commands

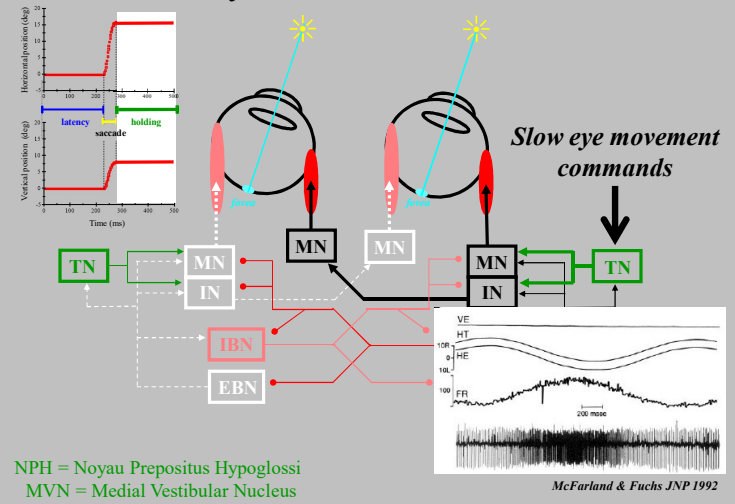

Intersaccadic inhibition of burst neurons

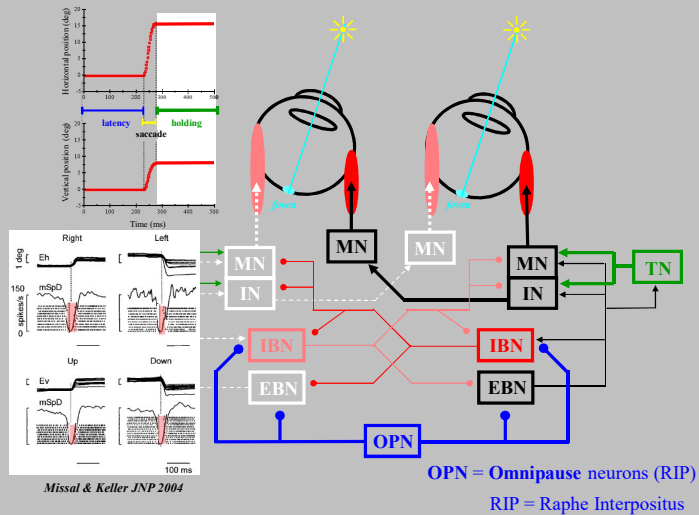

Intersaccadic inhibition of burst neurons

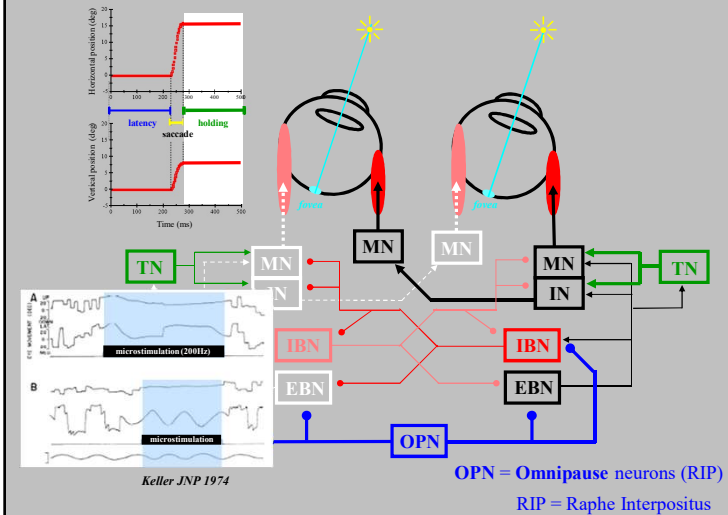

Fixation instability : saccade intrusions (unstable equilibrium)

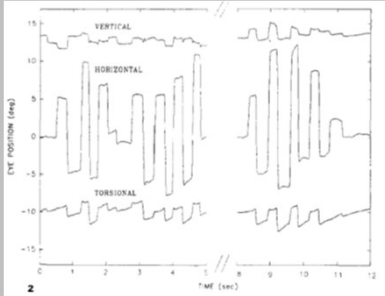

L. Averbuch-Heller
A. A. Kori
K. G. Rottach
L. F. Dell'Osso
B. F. Remler
R. J. Leigh

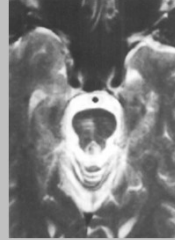

Problem : no fixation instability in the monkey after RIP lesion/inactivation

OPN : a solution for synchronizing H and V components ?

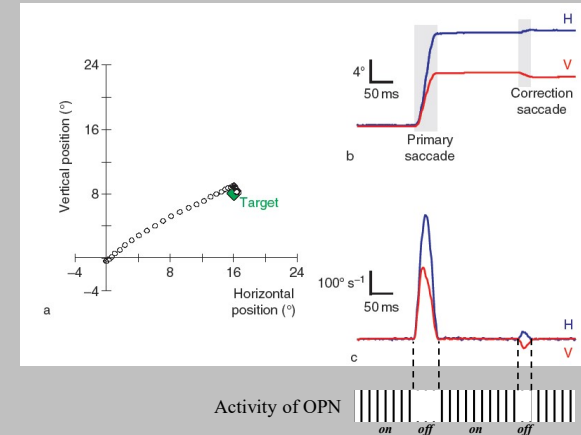

Reduction of inhibition during pursuit

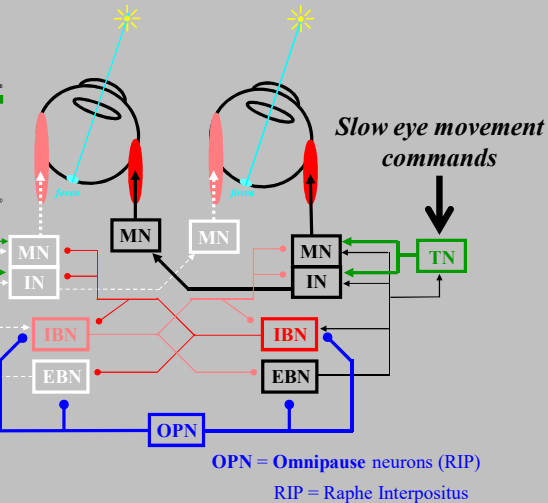
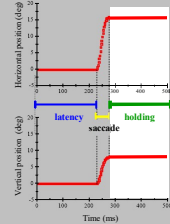

Missal & Keller JNP 2004

Generating a new saccade

Transmit a goal to EBN
Remove OPN inhibition

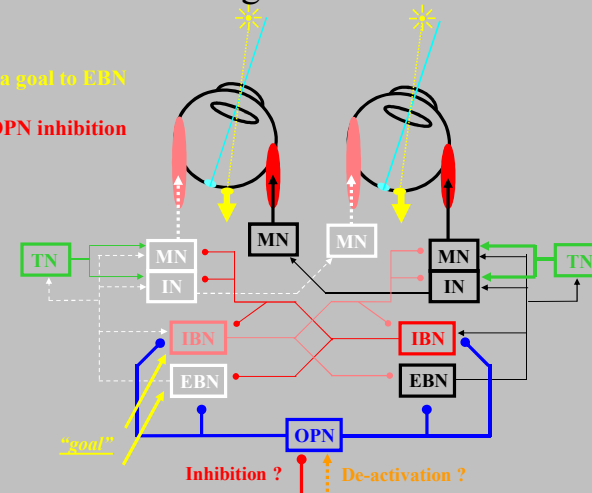

How to generate different amplitudes ?

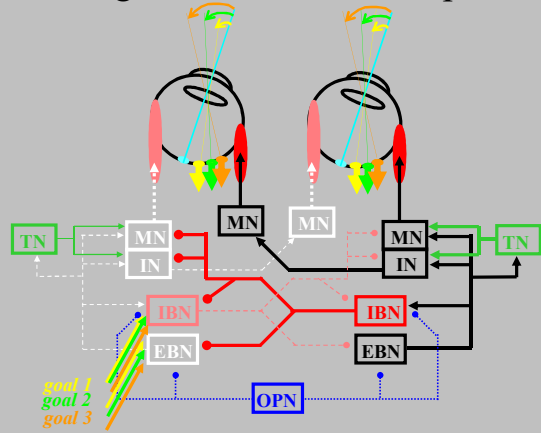

Burst neuron (temporal code)

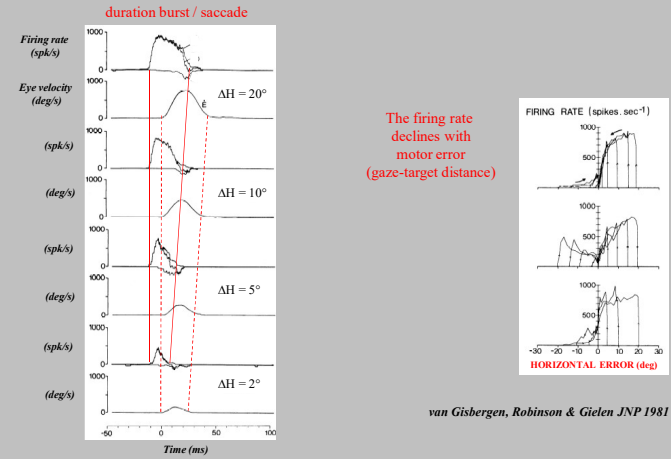

How to generate different amplitudes ?

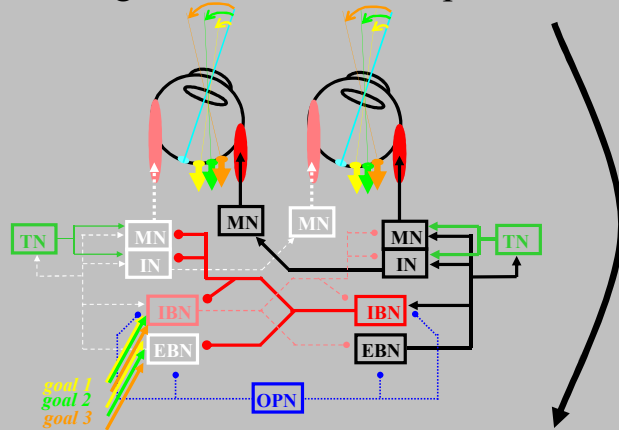

How is the burst duration specified ?

The deep Superior Colliculus

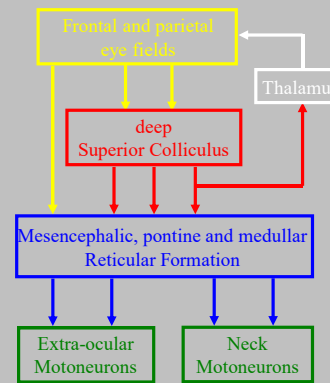

For a given saccade, a population of active neurons

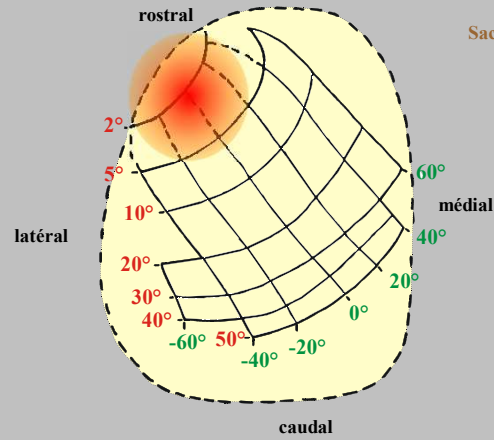

For a given saccade, a population of active neurons

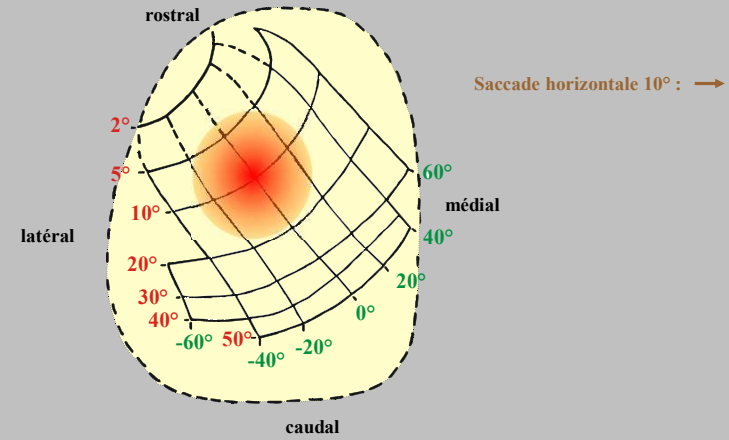

For a given saccade, a population of active neurons

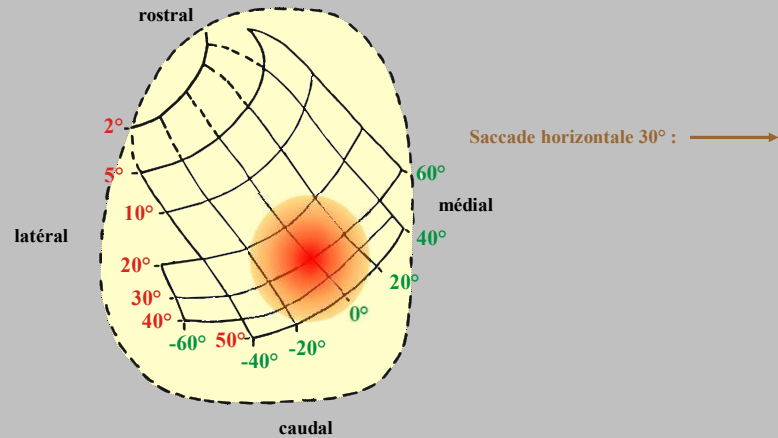

For a given saccade, a population of active neurons

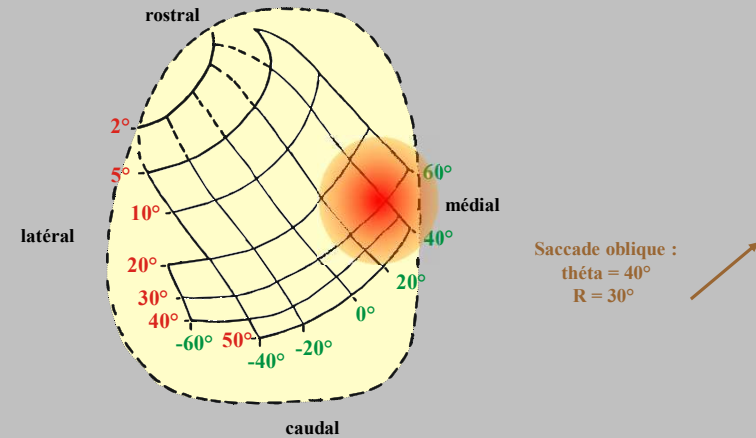

For a given saccade, a population of active neurons

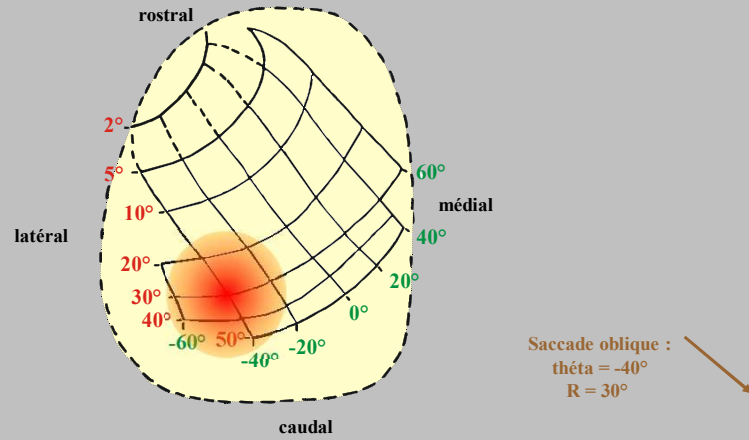

Topography of saccades evoked by electrical microstimulation

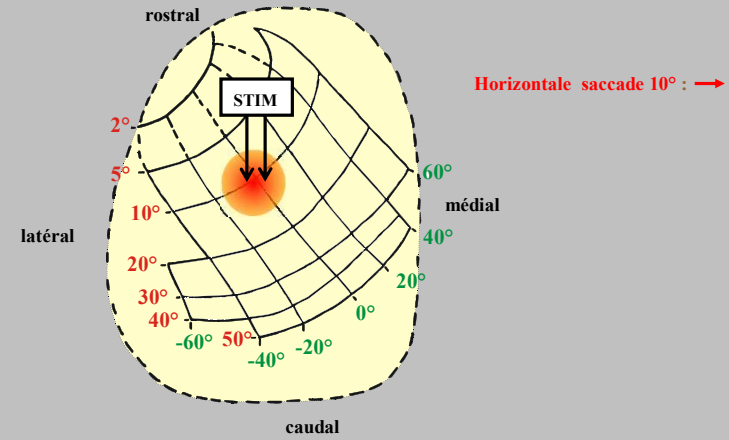

Gaze-related command (eye + head)

Microstimulation in the head-unrestrained monkey

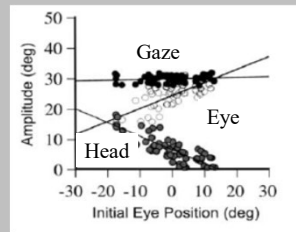
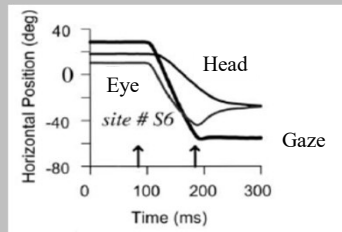

Sparks, Freedman, Gandhi & Chen VR 2001

Topographical encoding of goal for gaze

Muscimol injection (Gaba-A agonist)

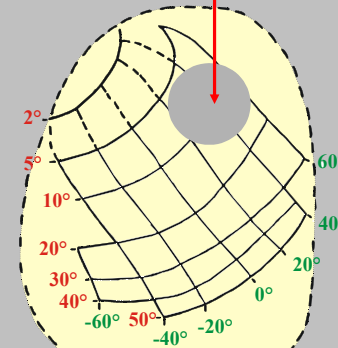

No saccade with amplitude and direction corresponding to vector represented at inactivated site

Increase of latency for saccades represented at adjacent sites

The spatio-temporal transformation

HOW is
the position of active cells
transformed into a
a duration of burst ?

The dichotomist hypothesis

FIXATION / SACCADE ZONE

(MUNOZ and colleagues 1989;1993)

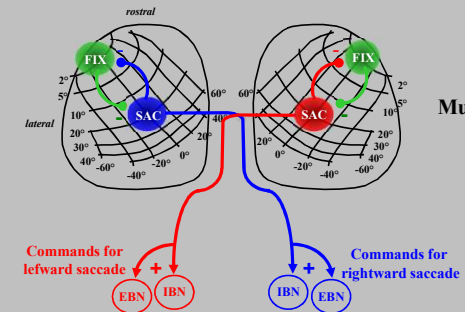

The dichotomist hypothesis

FIXATION / SACCADE ZONE

(MUNOZ and colleagues 1989;1993)

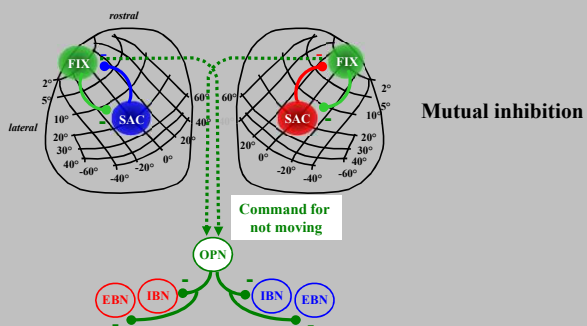

The dichotomist hypothesis

FIXATION / SACCADE ZONE

(MUNOZ and colleagues 1989;1993)

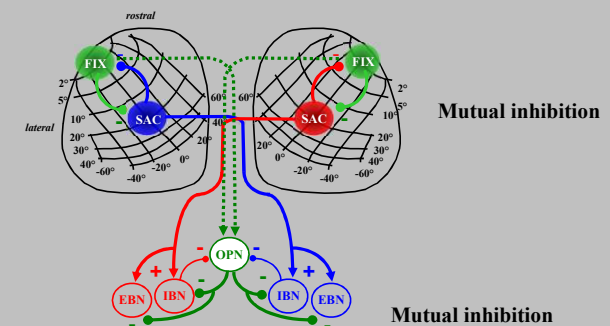

Dichotomy : MOVE versus DO NOT MOVE

The "moving hill" hypothesis

(Munoz, Pélisson & Guitton *Science* 1991)

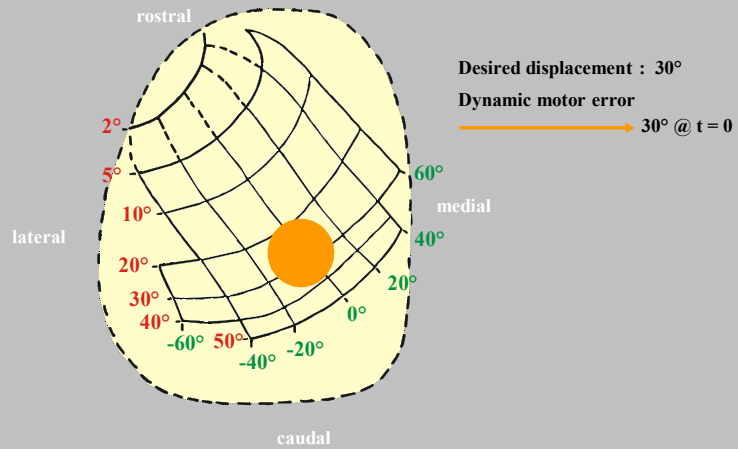

The "moving hill" hypothesis

(Munoz, Pélisson & Guitton *Science* 1991)

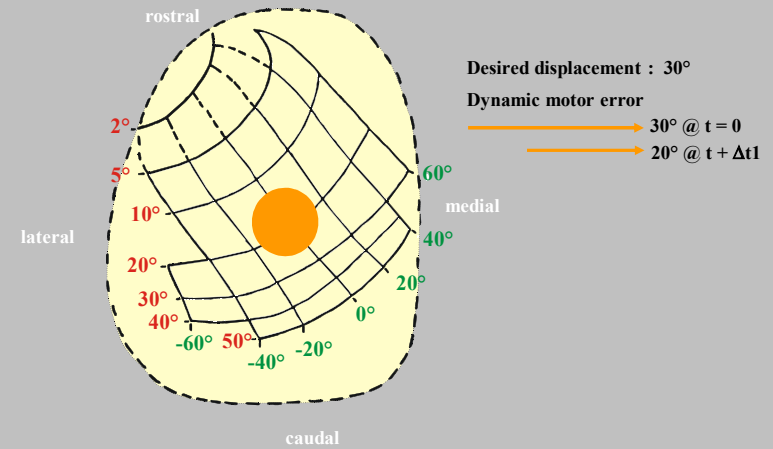

The "moving hill" hypothesis

(Munoz, Pélisson & Guitton *Science* 1991)

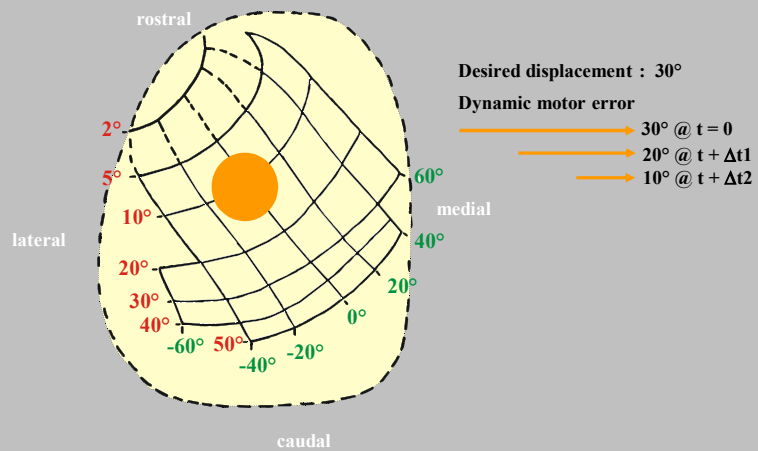

The "moving hill" hypothesis

(Munoz, Pélisson & Guitton *Science* 1991)

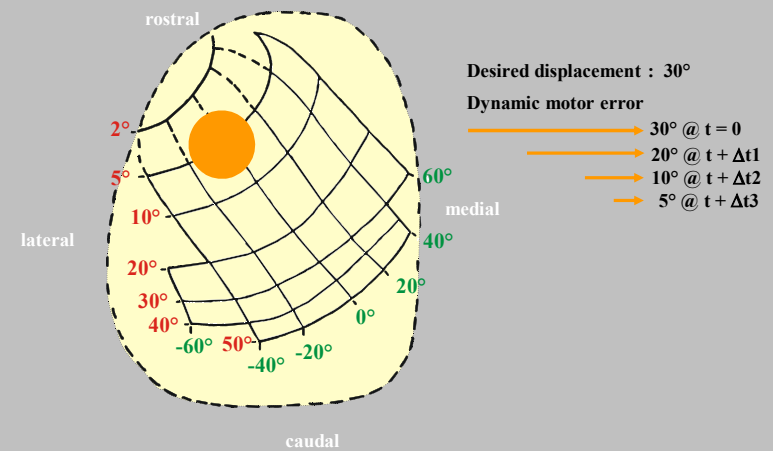

The "moving hill" hypothesis

(Munoz, Pélisson & Guitton *Science* 1991)

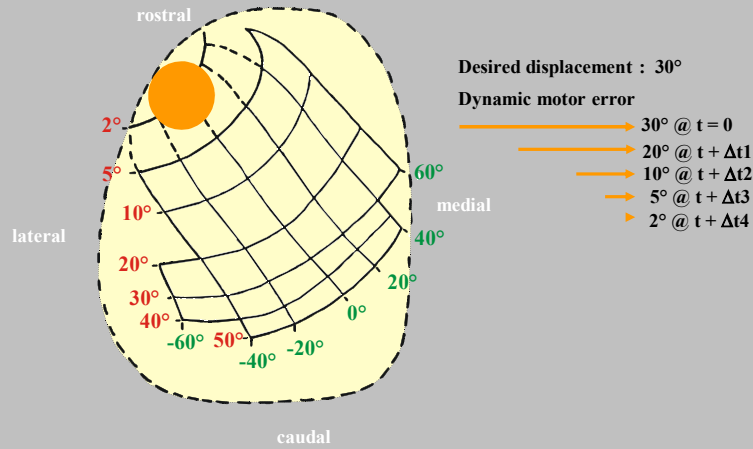

The "moving hill" hypothesis

(Munoz, Pélisson & Guitton *Science* 1991)

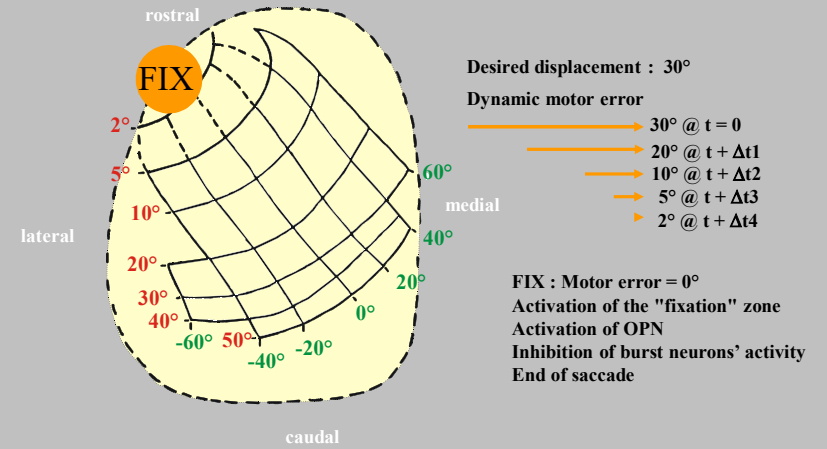

The "spreading wave" hypothesis

(Munoz & Wurtz *J. Neurophysiol.* 1993)

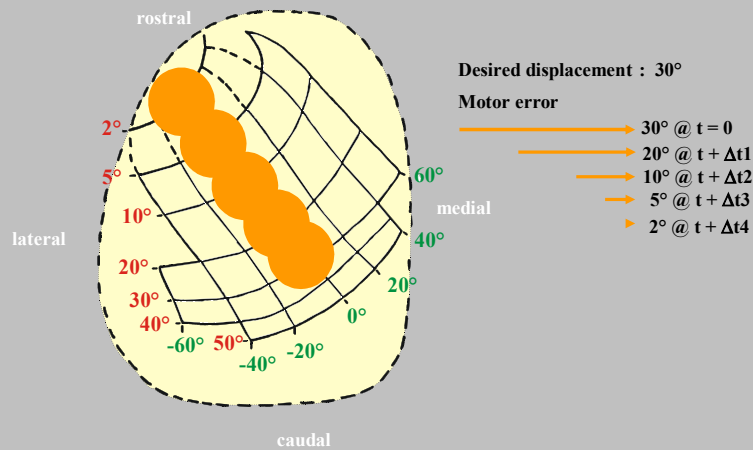

The "spreading wave" hypothesis

(Munoz & Wurtz *J. Neurophysiol.* 1993)

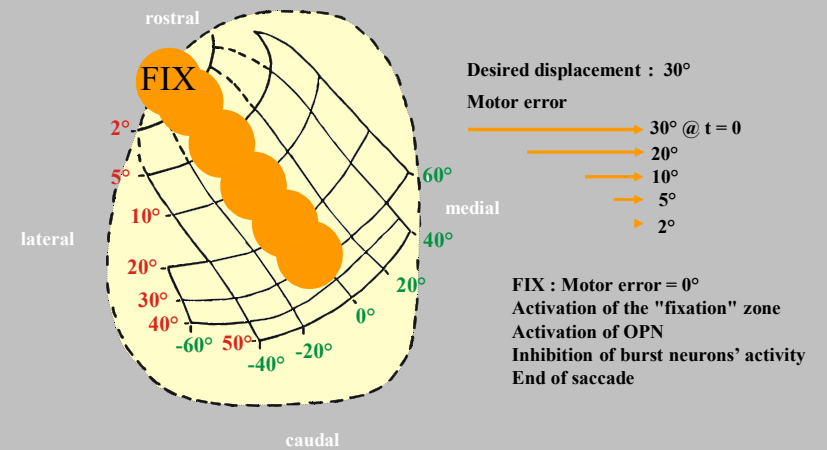

The "spreading wave" hypothesis

(Munoz & Wurtz *J. Neurophysiol.* 1993)

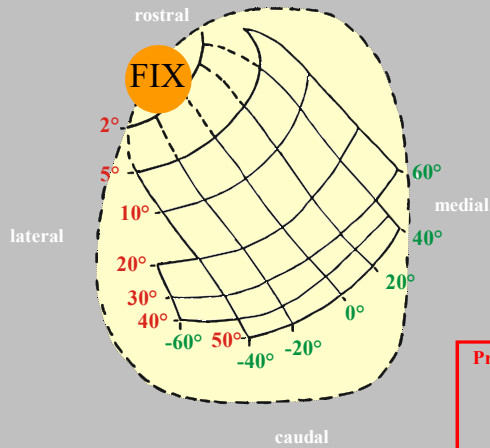

Problems :

- non reproducible (> 3 labs)
- inactivation of rostral SC
- > What happens ?

The "spreading wave" hypothesis

(Munoz & Wurtz *J. Neurophysiol.* 1993)

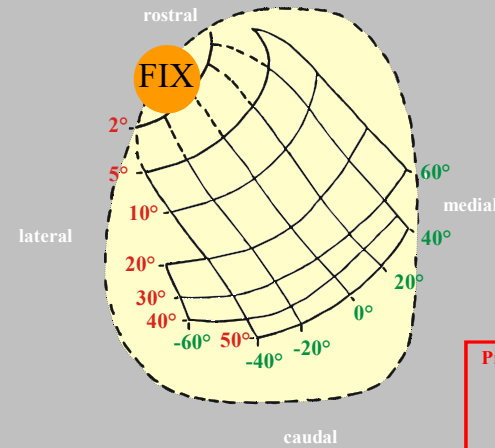

Problems :

- non reproducible (>3 labs)
- inactivation of rostral SC
- > no hypermetria

“moving hill” or “spreading wave” hypotheses
=> assume a dichotomy FIX/SAC

FIXATION / SACCADE ZONE

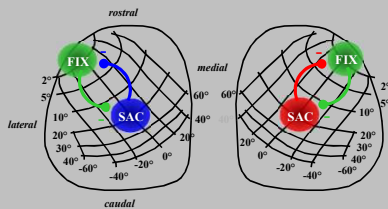

1. Recording of FIX
→ sustained activity during fixation
2. Microstimulation of FIX
→ delays the onset of saccades (+ hypometria)
3. Inactivation of FIX
→ irrepressible saccades

dichotomy

IF assumption (dichotomy) is wrong
THEN WHAT ?

FIXATION / SACCADE ZONE

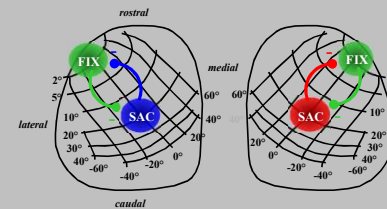

dichotomy

IF assumption (dichotomy) is wrong
THEN the SC is a homogeneous map

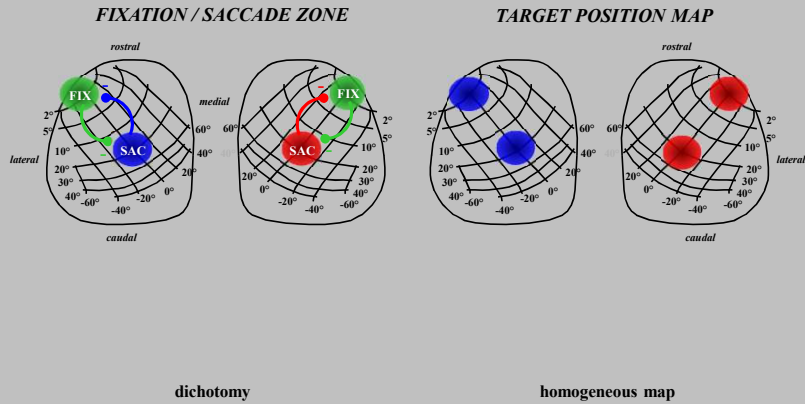

IF assumption (dichotomy) is wrong
THEN the SC is a homogeneous map

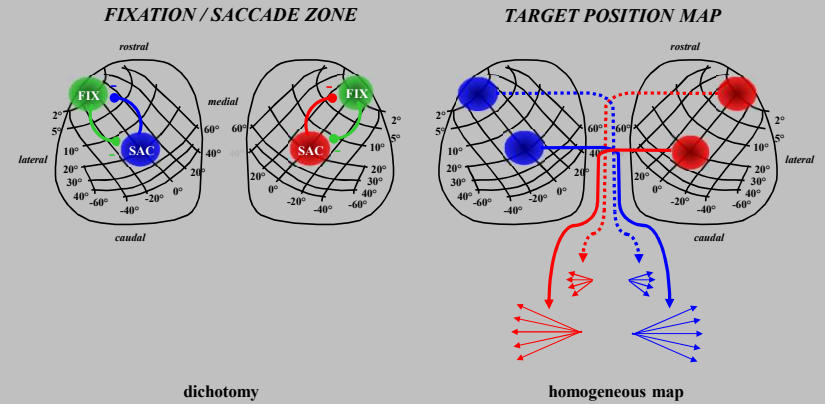

Fixation is not a "rigid" / "frozen" state

1. Recording of FIX

→ burst of action potentials during microsaccades

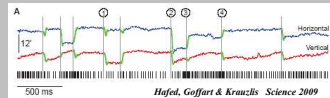

TARGET POSITION MAP

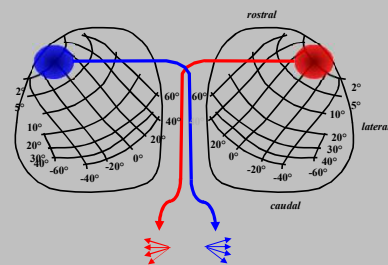

homogeneous map

Fixation is the maintenance of gaze
within a spatio-temporal window

1. Recording of FIX

→ burst of action potentials during microsaccades

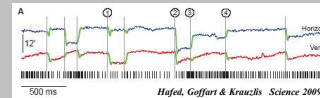

TARGET POSITION MAP

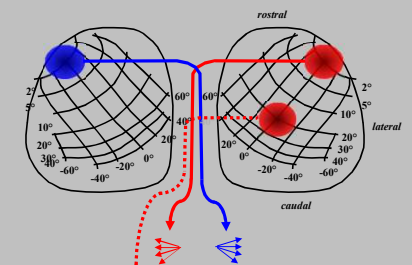

homogeneous map

2. Microstimulation of FIX

→ delays saccade because of competition

Fixation is the maintenance of gaze within a spatio-temporal window

1. Recording of FIX

→ burst of action potentials during microsaccades

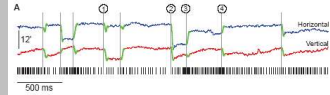

2. Microstimulation of FIX

→ delays saccade because of competition

3. Inactivation of FIX

→ irrepressible saccades when two competing targets

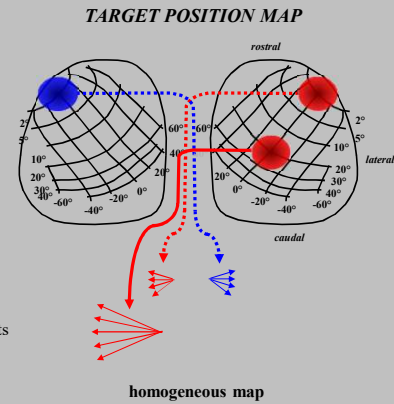

Visual Fixation as Equilibrium: Evidence from Superior Colliculus Inactivation

Journal of Neuroscience 2012

Laurent Goffart,¹ Ziad M. Hafed,² and Richard J. Krauzlis^{3,4}
¹Institut de Neurosciences de la Timone, UMR 7289, Centre National de la Recherche Scientifique, Aix-Marseille Universit s, 13385 Marseille, France; ²Werner Reichardt Centre for Integrative Neuroscience, 72076 T ubingen, Germany; ³Systems Neurobiology Laboratory, Salk Institute for Biological Studies, La Jolla, California 92037; and ⁴Laboratory of Sensorimotor Research, National Eye Institute, National Institutes of Health, Bethesda, Maryland 20892

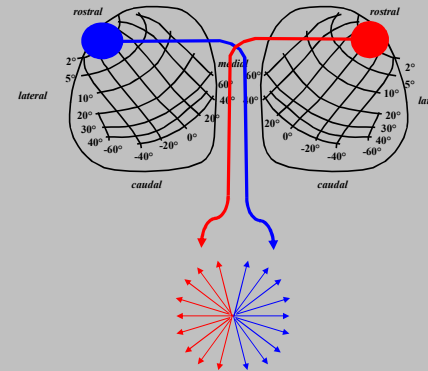

Visual Fixation as Equilibrium: Evidence from Superior Colliculus Inactivation

Journal of Neuroscience 2012

Laurent Goffart,¹ Ziad M. Hafed,² and Richard J. Krauzlis^{3,4}
¹Institut de Neurosciences de la Timone, UMR 7289, Centre National de la Recherche Scientifique, Aix-Marseille Universit s, 13385 Marseille, France; ²Werner Reichardt Centre for Integrative Neuroscience, 72076 T ubingen, Germany; ³Systems Neurobiology Laboratory, Salk Institute for Biological Studies, La Jolla, California 92037; and ⁴Laboratory of Sensorimotor Research, National Eye Institute, National Institutes of Health, Bethesda, Maryland 20892

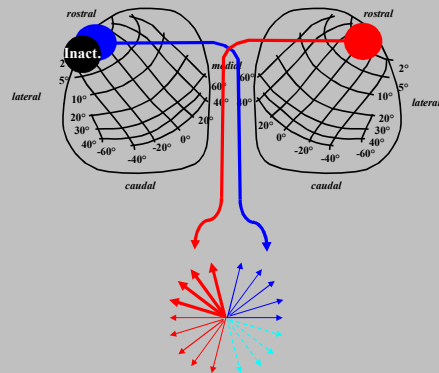

RESULT

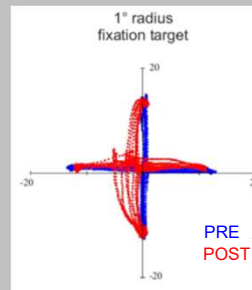

The accuracy of saccades toward peripheral targets is not altered

PREDICTION Fixation offset to the left and upward

Visual Fixation as Equilibrium: Evidence from Superior Colliculus Inactivation

Journal of Neuroscience 2012

Laurent Goffart,¹ Ziad M. Hafed,² and Richard J. Krauzlis^{3,4}
¹Institut de Neurosciences de la Timone, UMR 7289, Centre National de la Recherche Scientifique, Aix-Marseille Universit s, 13385 Marseille, France; ²Werner Reichardt Centre for Integrative Neuroscience, 72076 T ubingen, Germany; ³Systems Neurobiology Laboratory, Salk Institute for Biological Studies, La Jolla, California 92037; and ⁴Laboratory of Sensorimotor Research, National Eye Institute, National Institutes of Health, Bethesda, Maryland 20892

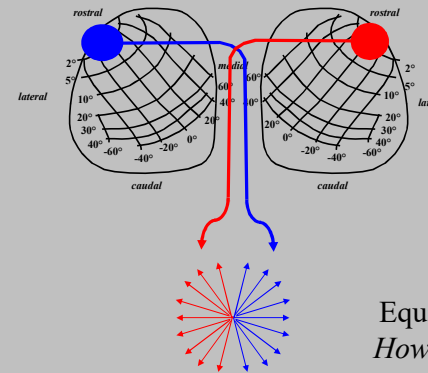

Equilibrium requires symmetry
 How is the symmetry achieved?
 → cerebellum?

Spatio-temporal transformation

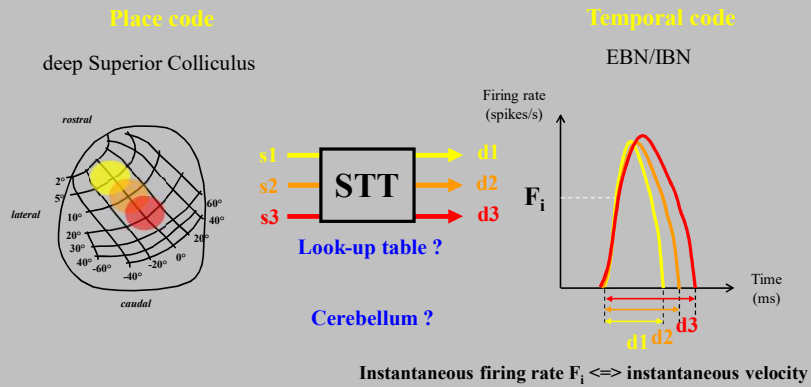

The medio-posterior cerebellum

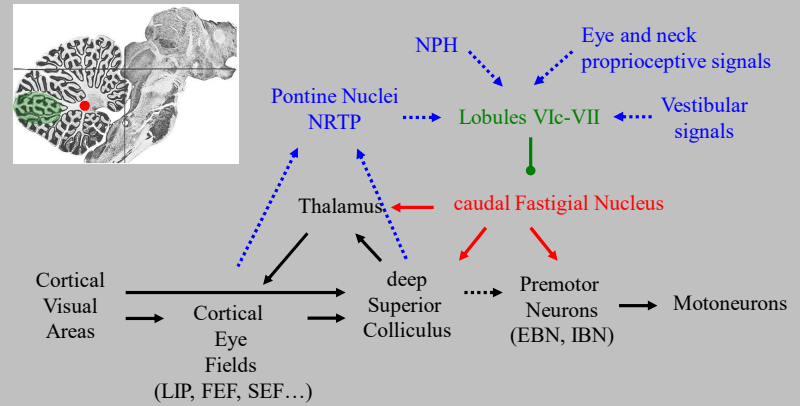

Horizontal dysmetria after inactivation of caudal Fastigial Nucleus

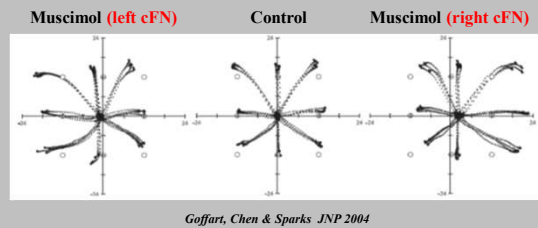

Neuronal activity

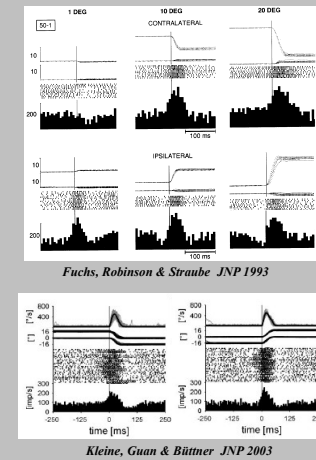

Time window of perturbation

Presaccadic, intrasaccadic, both ?

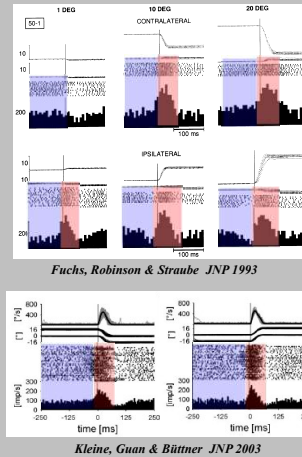
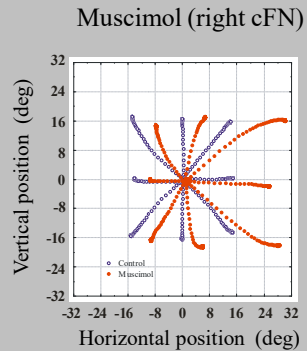

Transient inhibition of caudal Fastigial Nucleus

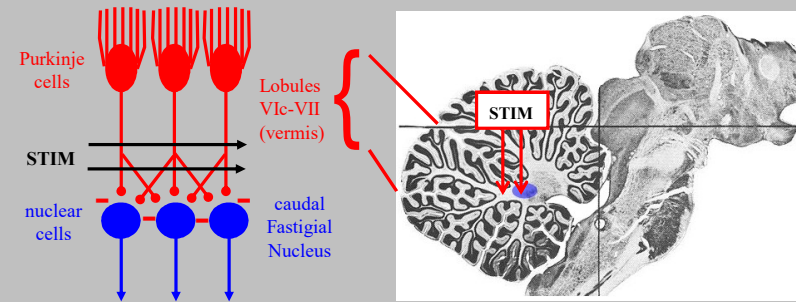

Mimic the effects of muscimol on saccades with a microstimulation train

Inhibitory perturbation

Right cFN

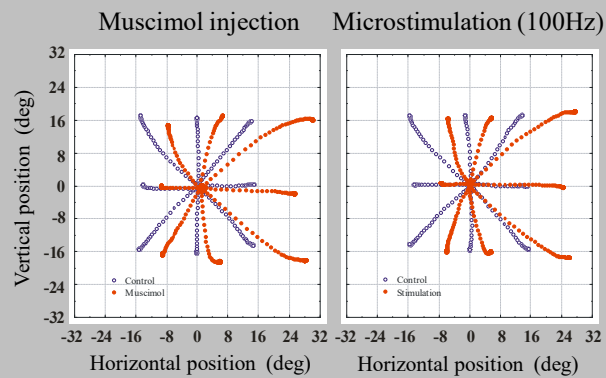

Goffart & Quinet to be published

Horizontal dysmetria is due to the unilateral suppression of the saccade-related burst

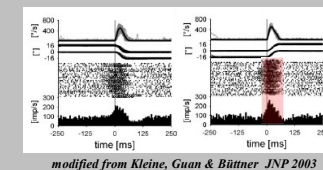
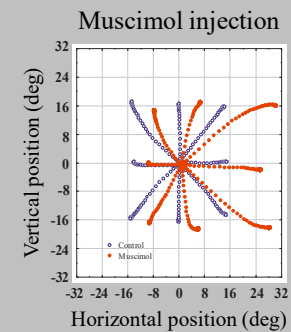

Fastigio-reticular projections and the cerebellar control of saccade amplitude

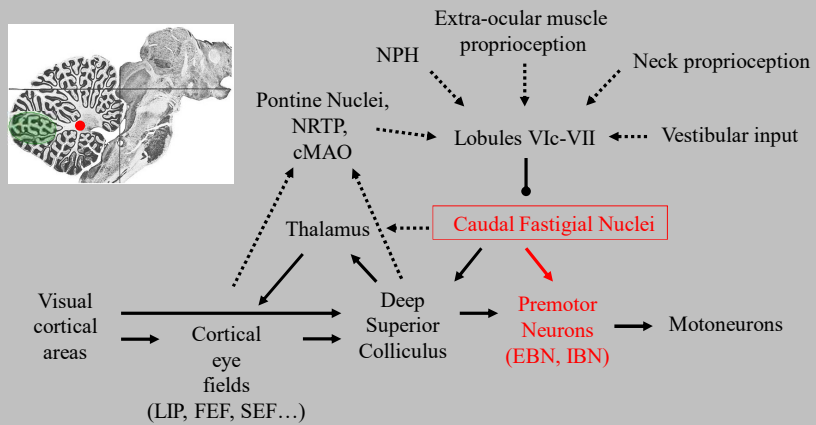

Bilateral cerebellar control of the dynamic balance between EBN and IBN during the *saccadic transition*

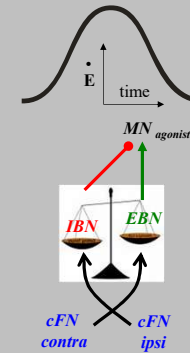

For each saccade, the bilateral activity of cFN modulates the balance of activity between the EBN and IBN that innervate the agonist MN.

IBN do not participate in the feedback control of saccade amplitude.

Goffart, Chen & Sparks JNP 2004

Does the sustained activity in cFN influence anything ?

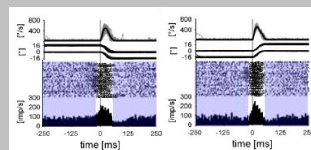

Kleine, Guan & Büttner JNP 2003

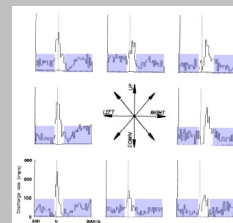

Ohtsuka & Noda JNP 1991

Deficit in fixation after cFN inactivation

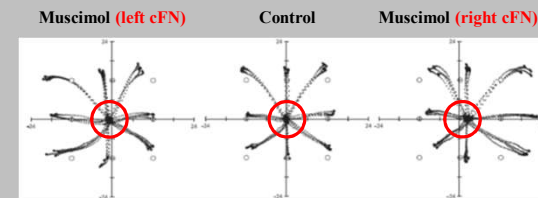

Goffart, Chen & Sparks JNP 2004

Ipsilesional fixation offset

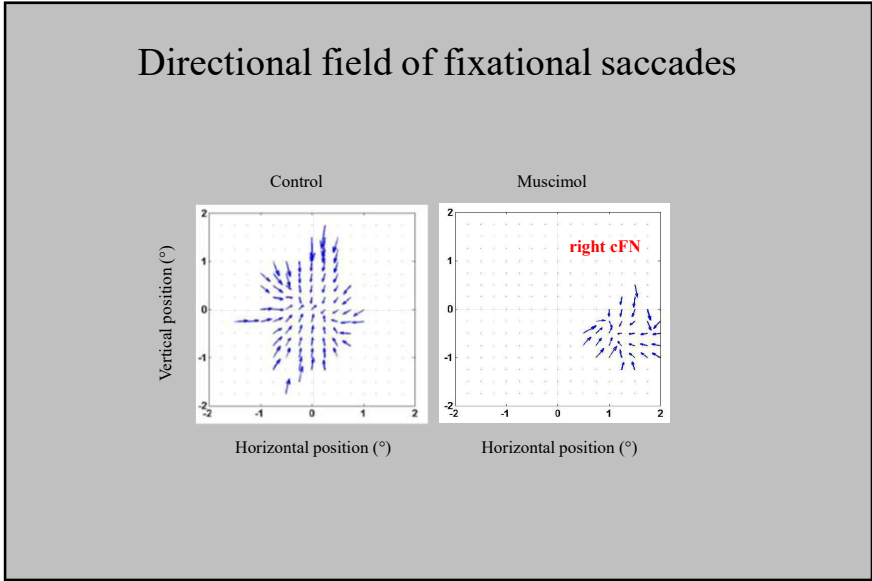
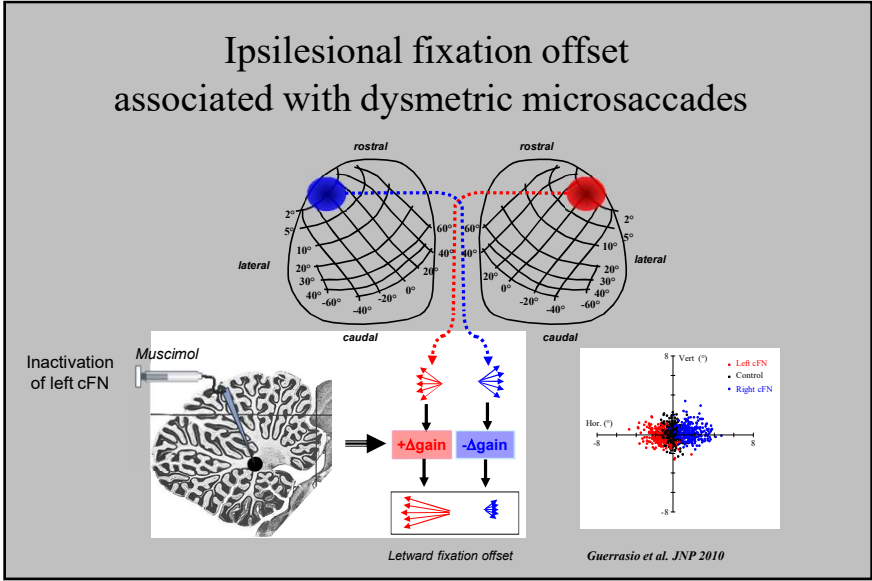
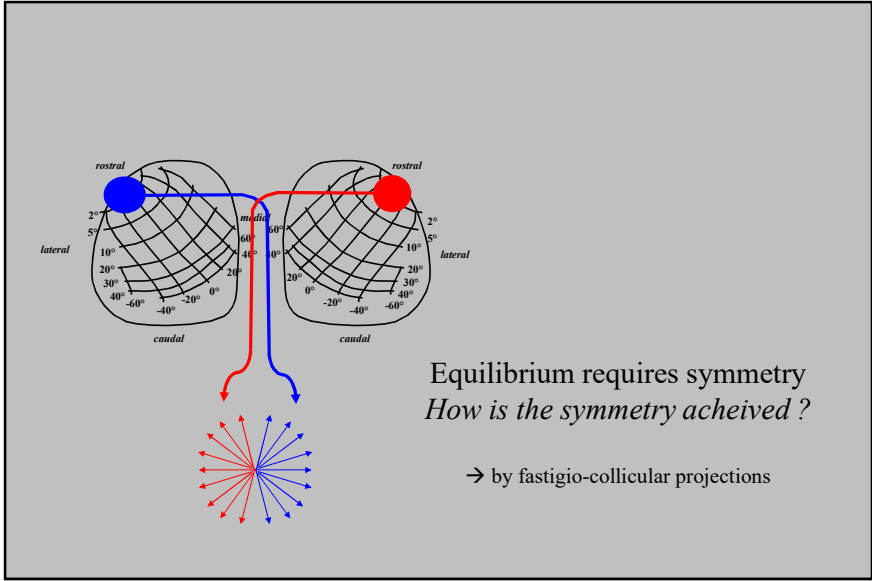

J Neurophysiol 103: 1988–2001, 2010.
First published February 3, 2010; doi:10.1152/jn.00771.2009.

Fastigial Oculomotor Region and the Control of Foveation During Fixation

Lorenzo Guerrasio,¹ Julie Quinet,² Ulrich Büttner,¹ and Laurent Goffart³

¹Department of Neurology, Klinikum Großhadern, LMU, München, Germany; ²Unité 534, Institut National de la Santé et de la Recherche Médicale/Université Claude Bernard- Lyon 1, IFR 19 Institut Fédératif des Neurosciences de Lyon, Bron, France; and ³Institut de Neurosciences Cognitives de la Méditerranée, Unité Mixte Recherche 6193, Centre National de la Recherche Scientifique, Aix-Marseille Universités, Marseille, France

Journal of Neurophysiology 2010

"Given the general role of the cerebellum in motor learning (Ito 1984), the FORs could play a specific role in the learning phase of the foveating behavior, compensating for idiosyncratic differences in neuromuscular morphology and anisotropies in the mechanisms triggering and executing fixational saccades."

Subcortical control of foveation

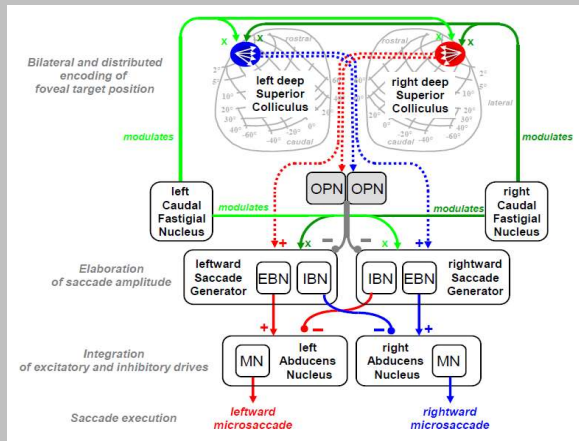

IF fixation is the maintenance of gaze within a spatio-temporal window
THEN how do we foveate a moving target ?

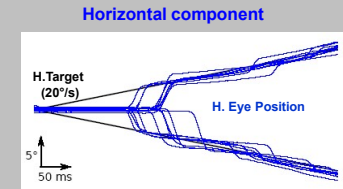
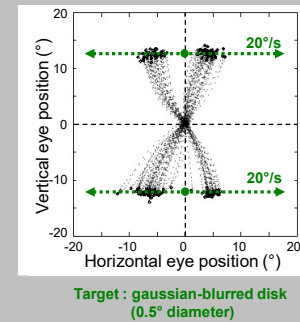

The *hic-et-nunc* (here-and-now) of saccade endpoints

Animals can make saccadic eye movements to visually intercept the trajectory of a moving object and foveate it *at the right place and time*, and initiate its pursuit.

Such interceptive saccades indicate that, in spite of variable sensorimotor delays, the brain is able to estimate the *hic-et-nunc* (here-and-now) coordinates of a target at least at the time of saccade landing.

How is this possible ?

From the behavior to its analysis

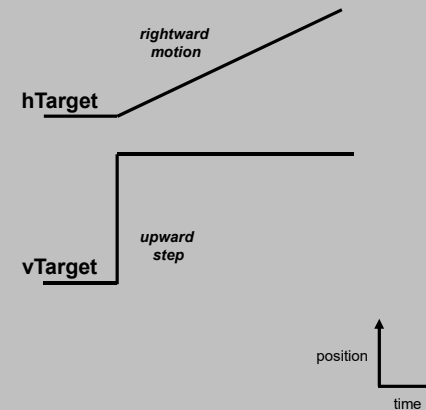

From the behavior to its analysis

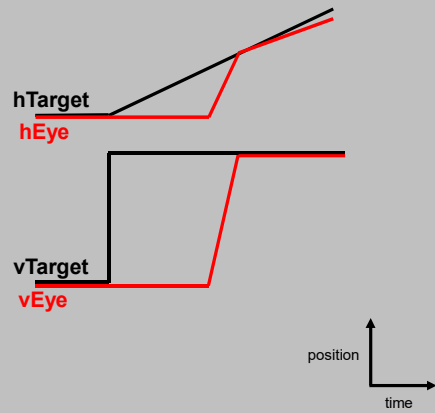

From the behavior to its analysis

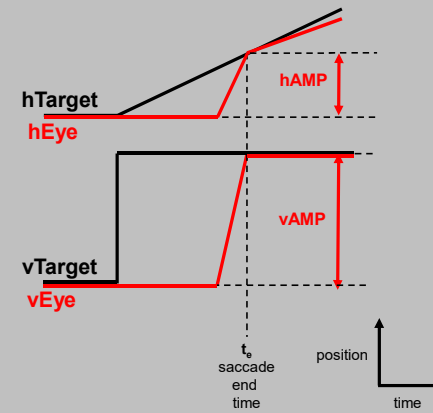

The dual-drive hypothesis

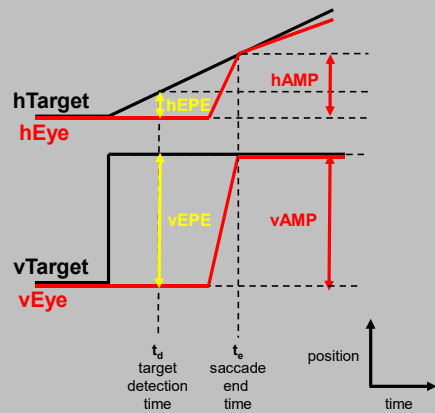

ASSUMPTIONS :

1. Snapshot of **Eye Position Error (EPE)**
→ discrete sampling

The dual-drive hypothesis

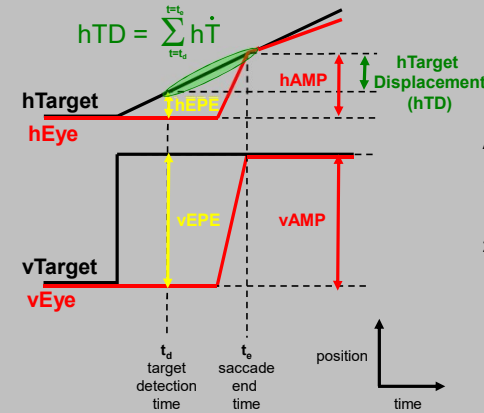

ASSUMPTIONS :

1. Snapshot of **Eye Position Error (EPE)**
→ discrete sampling
2. Estimate of **Target Displacement (TD)**
→ time window delimited by discrete events

The dual-drive hypothesis

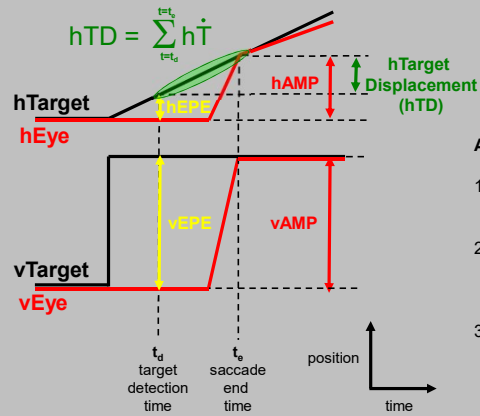

ASSUMPTIONS :

1. Snapshot of **Eye Position Error (EPE)**
→ discrete sampling
2. Estimate of **Target Displacement (TD)**
→ time window delimited by discrete events
3. **AMP = EPE + TD** (additive hypothesis)

The dual-drive hypothesis

Keller et al. JNP 1996
Optican & Quaia ANYAS 2002
Optican Encyclopedia of Neurosc. 2010

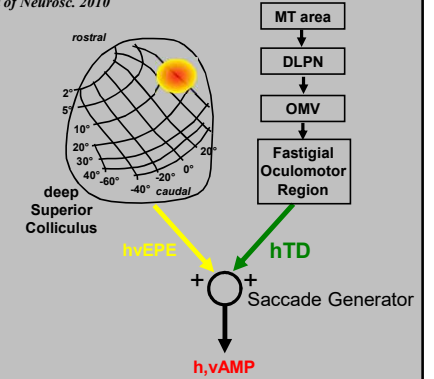

The dual-drive hypothesis

Keller et al. JNP 1996
Optican & Quaia ANYAS 2002
Optican Encyclopedia of Neurosc. 2010

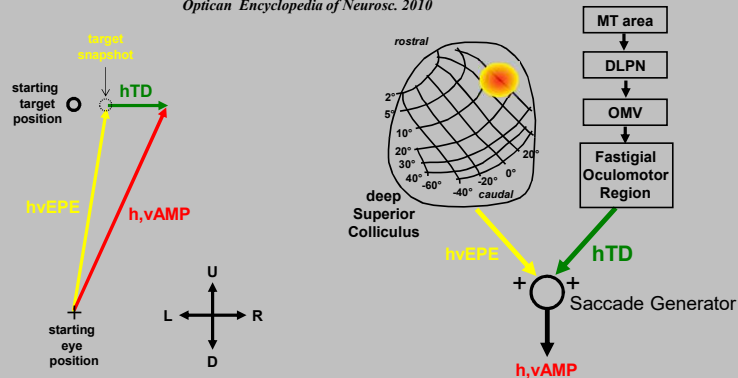

An alternative hypothesis is possible

'Dual drive' hypothesis

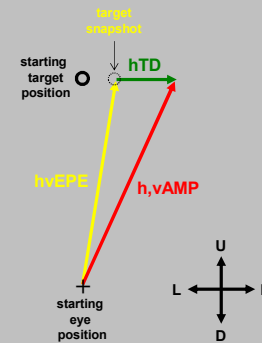

The "dynamic remapping" hypothesis

Saccadic Foveation of a Moving Visual Target in the Rhesus Monkey

Jérôme Fleuriel, Sandrine Hugues, Laurent Perrinet, and Laurent Goffart
 Institut de Neurosciences Cognitives de la Méditerranée, Unité Mixte de Recherche 6193, Centre National de la Recherche Scientifique,
 Aix-Marseille Universités, Marseille, France

Journal of Neurophysiology 2011

The "hic-et-nunc" hypothesis

Saccadic Interception of a Moving Visual Target after a Spatiotemporal Perturbation

Jérôme Fleuriel and Laurent Goffart
 Institut de Neurosciences Cognitives de la Méditerranée, UMR 6193, Centre National de la Recherche Scientifique, Aix-Marseille Université, 13331 Marseille
 Cedex 03, France

Journal of Neuroscience 2012

An alternative hypothesis

'Dual drive' hypothesis

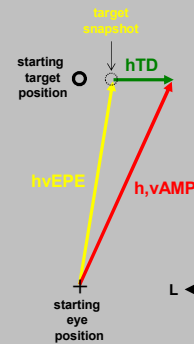

'Hic-et-nunc' hypothesis

Fleuriel et al. JNP 2011
 Fleuriel & Goffart JN 2012

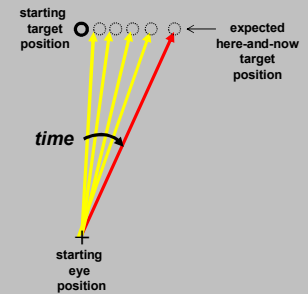

Experimental test in the monkey

Perturb the interceptive saccade and
 test the ability to keep track of the moving target and intercept it

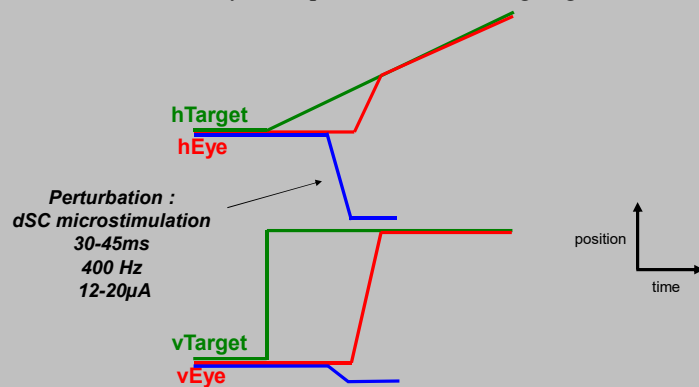

Predictions

IF the saccade goal =
 hic-et-nunc target position
 THEN change in eye position
 and added delay
 should be taken into account
 (accurate saccades)

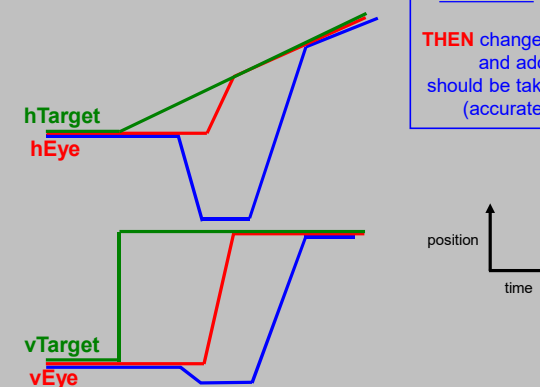

Visual feedback is removed

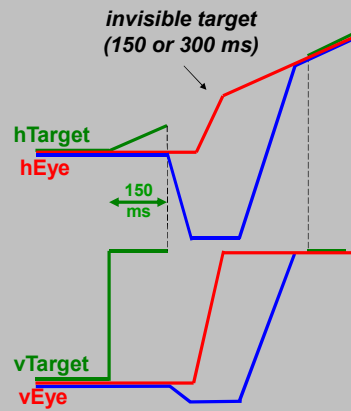

IF the saccade goal = *hic-et-nunc* target position
THEN change in eye position and added delay should be taken into account (accurate saccades)

Saccadic interception of an occluded target

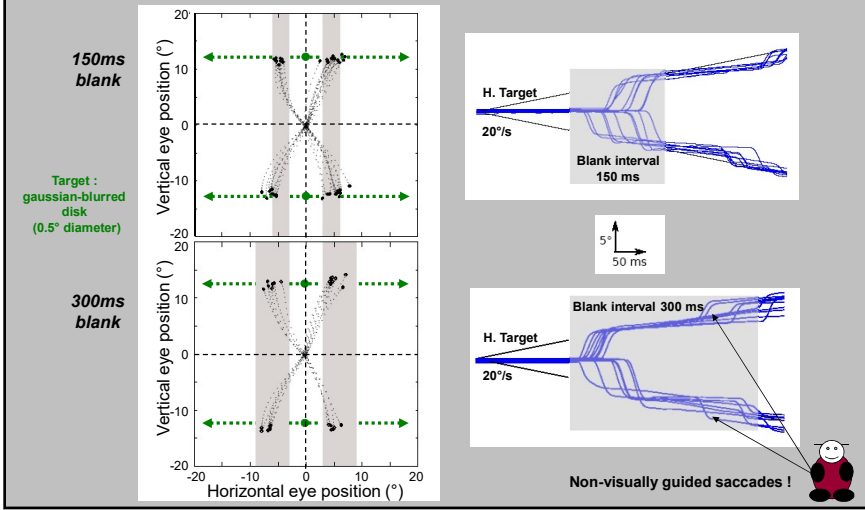

Perturbation of interceptive saccades

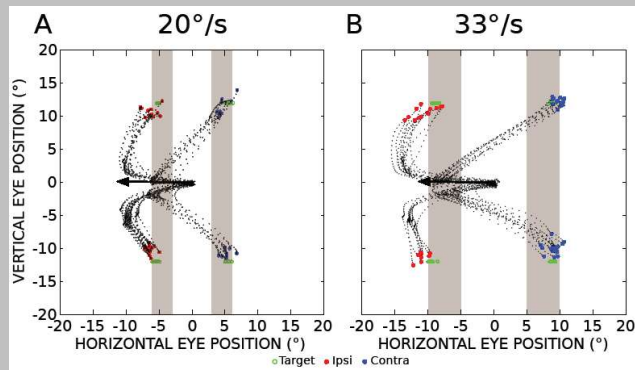

Fleuriet & Goffart JN 2012

Perturbation of interceptive saccades

Microstimulation in the right deep Superior Colliculus (30ms 400Hz 12μA)

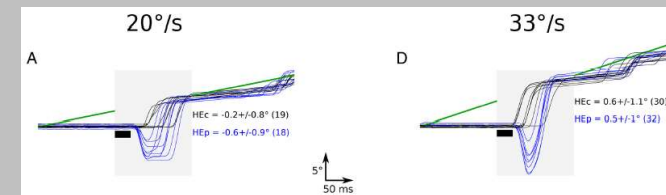

Fleuriet & Goffart JN 2012

Perturbation of interceptive saccades

Microstimulation in the right deep Superior Colliculus (30ms 400Hz 12 μ A)

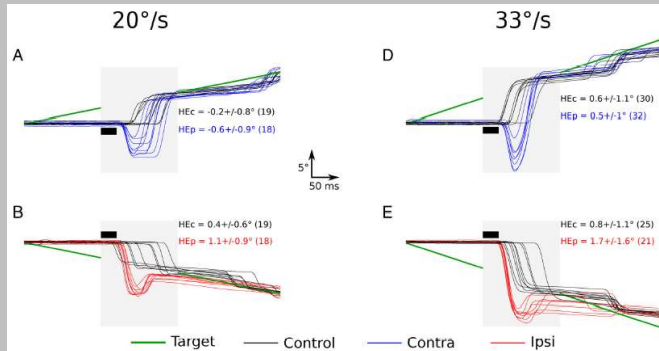

Fleuriet & Goffart JN 2012

Conclusions

In spite of the “spatio-temporal blurring” (Pellionisz & Llinas 1982) that a visual event undergoes when the retinal activity propagates toward the oculomotor system, *in fine*, the brain is able to estimate the here-and-now (*hic-et-nunc*) coordinates of the target.

Fleuriet & Goffart (2012) showed that this estimate is *robust* enough for animals to capture the target even after an unexpected spatiotemporal perturbation (i.e., a change in eye position and associated delay).

Working hypothesis

Gaze direction is driven by a *flow of expected target positions*

This flow is an *internal model* that has been *learned* and *embodied*.

→ There is no need for encoding the location of the target in the future.

→ The brain needs to build up an estimate of *expected here-and-now* target position.

→ Obviously, this estimate is not stationary, the oculomotor system reads out a signal out of a memory (register) that *temporally unfolds*.

This dynamic signal feeds the same local feedback loop involved in the generation of saccades toward a stationary target.

On-going work

Investigations are being performed

with **Julie Quinet** and **Clara Bourrelly** to study :
 - the build-up of this “*dynamic attractor*” and its long-term storage
 - its *spatiotemporal conformation* with the on-going event (*dynamic morphing*)



Julie Quinet Clara Bourrelly

with **Neeraj Gandhi**, University of Pittsburgh to test :
 - whether an encoding of the “here-and-now” coordinates can be found in the deep superior colliculus

with **Yoshifumi Yamawaki**, Kyushu University to understand :
 - the neurobiological foundations of *what is going on here-and-now* in a much simpler organism (praying mantis)

Building-up an internal model of expected target positions

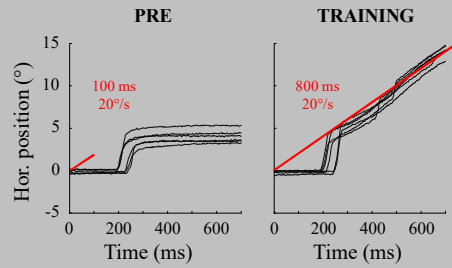

Blocked trials

Building-up an internal model of expected target positions

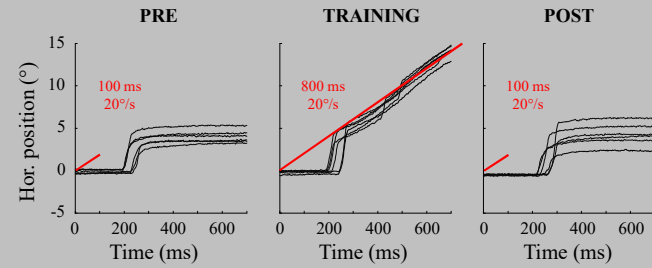

Blocked trials

Building-up an internal model of expected target positions

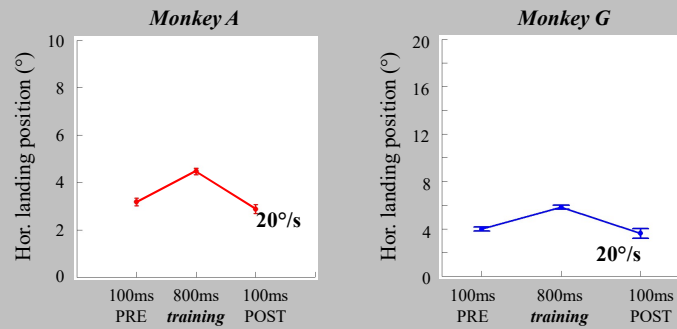

Building-up an internal model of expected target positions

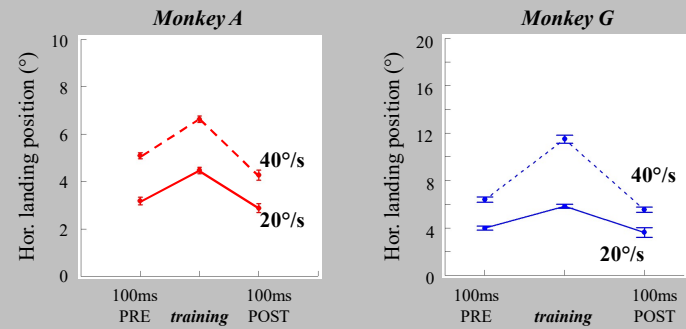

The putative "internal model" can not be reduced to a velocity / trajectory storage

Do we really need an internal model to explain this?

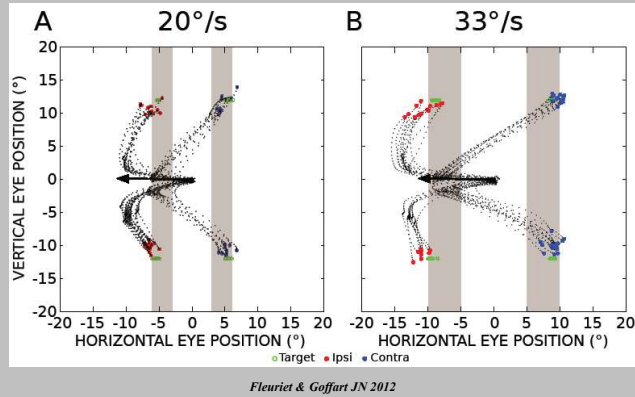

What internal model are we looking for ?

Our working hypothesis : Gaze direction is driven by a *flow of expected target positions here-and-now*

This flow is an internal model that has been *learned* (requires training) and *embodied* (some long-term maintenance)
 - an estimate of *expected here-and-now* target position,
 - a non stationary estimate that is read out by the oculomotor system and that *temporally unfolds* (observable).

Does such an internal model exist ?

Evidence for an internal model of here-and-now

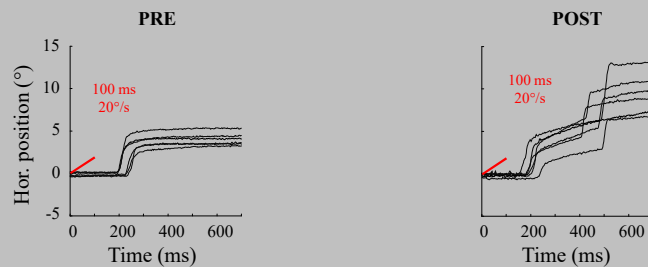

Evidence for an internal model of here-and-now

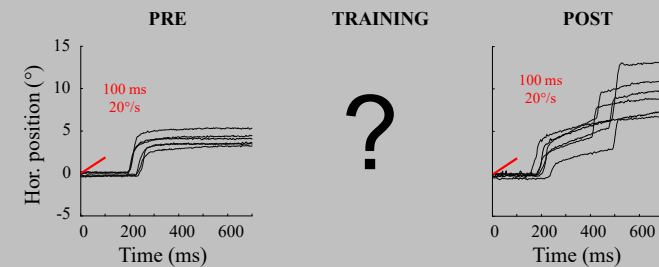

Evidence for an internal model of here-and-now

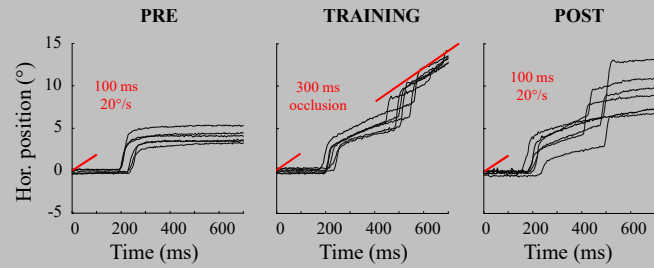

Evidence for an internal model of here-and-now

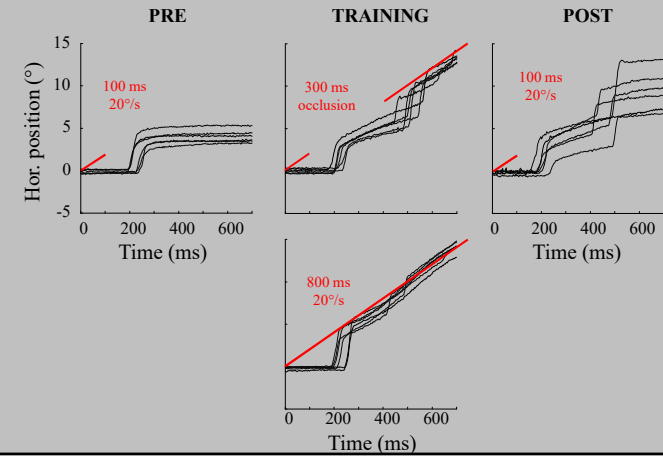

*“L’expérience ne nous donne qu’un certain nombre de points isolés ;
il faut les réunir par un trait continu”*

Henri Poincaré



*Il faut les réunir en se gardant de ne pas faire trop d’extrapolations
lorsqu’il s’agit d’envisager l’avenir*

