



HAL
open science

Cophylogeny Reconstruction Allowing for Multiple Associations Through Approximate Bayesian Computation

Blerina Sinimeri, Laura Urbini, Marie-France Sagot, Catherine Matias

► **To cite this version:**

Blerina Sinimeri, Laura Urbini, Marie-France Sagot, Catherine Matias. Cophylogeny Reconstruction Allowing for Multiple Associations Through Approximate Bayesian Computation. 2022. hal-03673256v2

HAL Id: hal-03673256

<https://hal.science/hal-03673256v2>

Preprint submitted on 12 Oct 2022 (v2), last revised 29 Aug 2023 (v4)

HAL is a multi-disciplinary open access archive for the deposit and dissemination of scientific research documents, whether they are published or not. The documents may come from teaching and research institutions in France or abroad, or from public or private research centers.

L'archive ouverte pluridisciplinaire **HAL**, est destinée au dépôt et à la diffusion de documents scientifiques de niveau recherche, publiés ou non, émanant des établissements d'enseignement et de recherche français ou étrangers, des laboratoires publics ou privés.

Cophylogeny Reconstruction Allowing for Multiple Associations Through Approximate Bayesian Computation

BLERINA SINAIMERI^{1,2,†}, LAURA URBINI^{2,†}, MARIE-FRANCE SAGOT² AND CATHERINE MATIAS³

¹ *LUISS University, Rome, Italy*

² *Inria Lyon, 56 Bd Niels Bohr, 69100 Villeurbanne, France, and Université de Lyon, F-69000, Lyon; Université Lyon 1; CNRS, UMR5558; 43 Boulevard du 11 Novembre 1918, 69622 Villeurbanne cedex, France*

³ *Sorbonne Université, Université de Paris Cité, Centre National de la Recherche Scientifique, Laboratoire de Probabilités, Statistique et Modélisation, Paris, France*

Corresponding author: Blerina Sinaimeri, LUISS University, Rome, Italy; E-mail: bsinaimeri@luiss.it.

Abstract

Nowadays, the most used method in studies of the coevolution of hosts and symbionts is phylogenetic tree reconciliation. A crucial issue in this method is that from a biological point of view, reasonable cost values for an event-based parsimonious reconciliation are not easily chosen. Different approaches have been developed (Alcala et al., 2017; Baudet *et al.*, 2015; Szöllösi et al., 2013) to infer such cost values for a given pair of host and symbiont trees. However, a major limitation of these approaches is their inability to model the *invasion* of different host species by the same symbiont species (referred to as a spread event), which is thought to happen in symbiotic relations. To mention one example, the same species of insects may pollinate different species of plants (see the example of wasps and figs in Silvius et al., 2008). This results in multiple associations observed between the symbionts and their hosts (meaning that a symbiont is no longer specific to a host), that are not compatible with the current methods of coevolution.

In this paper, we propose a method, called AMOCOALA (a more realistic version of a previous tool called COALA) which for a given pair of host and symbiont trees, estimates the probabilities of the cophylogeny events, in presence of spread events, relying on an approximate Bayesian computation (ABC) approach.

The algorithm that we propose, by including spread events, enables the multiple associations to be taken into account in a more accurate way, inducing more confidence in the estimated sets of costs and thus in the reconciliation of a given pair of host and symbiont trees. Its rooting in the tool COALA allows it to estimate the probabilities of the events even in the case of large datasets. We evaluate our method on synthetic and real datasets. The software is available at <https://sites.google.com/view/blerinasinaimeri/software/amocoala> reconciliation, cophylogeny, ABC method, spread.

[†]First co-authors.

1 Introduction

A powerful framework for modelling host-symbiont coevolution is provided by cophylogeny, a method which allows to infer combined evolutionary scenarios for a pair of phylogenetic trees of hosts and symbionts. In the following, we refer to symbionts in a wide sense: an organism living in symbiosis, which is not necessarily detrimental nor beneficial to any of the organisms. The cophylogeny problem is usually envisioned as a problem of mapping the phylogenetic tree of the symbionts into the one of the hosts (see *e.g.* Charleston, 2003; Merkle and Middendorf, 2005; Page, 1994; Donati *et al.*, 2015). Such mapping, called a *reconciliation*, allows the identification of (up to) four types of biological events: (a) cospeciation, when the symbiont diverges in correspondence to the divergence of a host species; (b) duplication, when the symbiont diverges but not the host; (c) host switch, when a symbiont switches from one host species to another independently of any host divergence; and (d) loss, which can describe for instance speciation of the host species independently of the symbiont, which then follows just one of the new host species.

The reconciliation method is abstract enough that it may actually be applied to different types of data, of which a common one is gene-species associations (Bansal *et al.*, 2012; Doyon *et al.*, 2011; Hallett and Lagergren, 2001; Stolzer *et al.*, 2012; Tofigh *et al.*, 2011). In fact, the trees that are compared do not even need to be representations of phylogenies. For instance in Becerra (1997), the phylogenetic tree of the beetle genus *Blepharida* is compared to a tree of the host plants (genus *Bursera*) whose construction is based on chemical similarity. Such generality may be seen as an advantage since the methods developed for host-symbiont associations (Conow *et al.*, 2010; Merkle *et al.*, 2010; Baudet *et al.*, 2015; Donati *et al.*, 2015) could be applicable to other situations (such as the gene-species context). However, this also shows that these models do not fully capture the specificity of the host-symbiont context. Among the most important aspects that have been only partially addressed is the fact that the same symbiotic species can interact, and therefore be associated with more than one host species; we refer to this as a *multiple association*. This is in sharp contrast with the gene-species context where a gene (sequence) is naturally associated to only one species (the one it is extracted from) (Stolzer *et al.*, 2012; Bansal *et al.*, 2018). We refer to the recent review by Libeskind-Hadas (2022) focusing on the theory of reconciliation in the context of host-symbiont cophylogenetics.

In host-symbiont systems, a multiple association can result from a combination of biologically different situations. Following Banks and Paterson (2005), such association can indeed be explained by: (i) cryptic symbiont species (that is, different symbiont species that are morphologically indistinguishable); (ii) misclassified (over-split) hosts (if the apparently different host species to which the symbiont is related represent in fact a same single species); (iii) recent host switches (when the symbiont has recently colonised a new host species and in the newly established population, there is very limited genetic diversity compared to the original symbiont population); (iv) failure to speciate by the symbiont population despite the fact that the host diverged (which might happen if the symbiont populations maintain genetic contact despite the host

speciation); and (v) incomplete host switching (if a symbiont colonised a sister taxon of its original host, and maintained genetic contact with the source population).

While in the cases (i)-(ii) the multiple associations are due to errors in defining the real input, in the cases (iii)-(v) those are caused by the ability of the symbiont to be associated to more than one host species and hence require the introduction of an additional biological event that has been called *spread* in the literature. The first use of such term seems to be in Brooks and McLennan (1991). Several methods in the literature deal with multiple associations in a more or less ad-hoc way but to the best of our knowledge none of them fully considers spread events. As multiple associations can be caused by spread events, any method that deals with multiple associations without considering spread events is not satisfying. Below, we briefly review the state of the art of cophylogenetic methods that consider multiple associations.

The methods presented in the literature on host and symbiont trees reconciliation can be divided into two main groups: parsimony methods and statistical methods of inference. The first group is based on an optimisation problem where, given a cost for each of the events, an optimal reconciliation is found by minimising its total cost. An advantage of parsimony methods is that they allow not only to estimate the frequencies of each of the events but also to infer the past associations. However, a major problem with these methods is that the solutions obtained are strongly dependent on the costs that have to be chosen *a priori*. Indeed, costs are inversely proportional to the obtained frequencies: the larger an event cost, the smaller the corresponding frequency of this event. Statistical approaches can then be used in addition to or as an alternative as they remove the subjective step of cost parameter choice and rely instead on a simultaneous inference of parameter values (*i.e.* event probabilities) and events.

To the best of our knowledge, the parsimony-based methods that address multiple associations are the following: TREEFITTER (Ronquist, 2003), CORE-PA (Merkle et al., 2010), JANE 4 (Conow et al., 2010) and WISPA (unpublished, see Drinkwater et al. (2016)). The tool TREEFITTER (Ronquist, 2003) treats each multiply associated symbiont as “an unresolved clade consisting of one lineage for each host in its repertoire. The ancestral host of this terminal clade can then be determined according to one of three separate methods: the ancient, recent and free options (Sanmartín and Ronquist, 2002).” CORE-PA (Merkle et al., 2010) deals only with the case of cryptic species and solves the multiple associations locally in a parsimonious way. In JANE 4 (Conow et al., 2010) and WISPA (Drinkwater et al., 2016), only parasite tips are permitted to fail to diverge (case (iv) above).

For what concerns the statistical approaches, only Alcalá et al. (2017) proposed a method of inference addressing multiple associations. The authors develop an approximate Bayesian computation (ABC) method to infer the rates of only two events: host switch and cospeciation. Their approach is different from the current literature on tree reconciliation in many ways. First, their method relies on symbiont genomic sequences to produce sets of dated phylogenies instead of relying on a single symbiont tree. Moreover, they pre-estimate extinction and speciation rates from the set of reconstructed symbiont phylogenies. As cospeciation occurs independently from the speciation process in their cophylogeny model, one might expect that the symbiont

trees obtained with this method exhibit more speciations than expected. Finally, their method outputs only a host-shift rate and a cospeciation probability but no quantification of duplication or loss events. Note that a very recent work addresses multiple associations in host-parasite systems, by modelling host repertoire evolution along the branches of a parasite tree (Braga et al., 2020). However, this method is far from the reconciliation approach and uses the host tree only through host pairwise distances.

In this paper, we introduce spread as a fifth event in the method called COALA (for *CO*evolution *A*ssessment *b*y a *L*ikelihood-*f*ree *A*pproach) originally proposed in Baudet *et al.* (2015) which to our knowledge was the first method to rely on ABC in the context of tree reconciliation. COALA infers a probability for each of the four cophylogeny events: cospeciation, duplication, host switch and loss but requires that the input has no multiple association. Introducing a spread event is a challenge and there is yet no canonical way to do this.

We choose to introduce two kinds of spread events, called vertical and horizontal spreads respectively. In this way, we capture the two different situations occurring in the cases (iii)-(v) above. The first event, called vertical spread, corresponds to a spread of a symbiont in the entire subtree below a host species. This event could also be called a *freeze* in the sense that the evolution of the symbiont *freezes* while the symbiont continues to be associated with a host and with the new species that descend from this host. As will be further detailed in Section Model and Method, this event covers case (iv) above and is related to what is known in the literature as *failure to diverge* (see for example Conow et al. (2010)). This also corresponds to the *speciation as a generalist* introduced in Alcalá et al. (2017). The second event, called horizontal spread, informally corresponds to the combination of a “host switch” with 2 different vertical spreads, one occurring in the initial host subtree and the second in the new host subtree. Thus, this horizontal spread event includes both an *invasion* of the symbiont which remains with the initial host but at the same time gets associated with (*invades*) another host that is not a descendant of the first, plus a *freeze*, actually a double freeze as the evolution of the symbiont *freezes* in relation to the evolution of the host to which it was initially associated and to the evolution of the second host it *invaded*. This event is useful to describe the cases (iii) and (v) from above. It allows to explain the case where two host clades that are phylogenetically distant are associated with the same symbiont species. Notice that a fundamental difference between host switch and horizontal spread is that in the former, the symbiont that switches hosts will further create 2 different symbionts, each one associated to the initial and to the new host respectively. In particular, a host switch never induces a multiple association, in sharp contrast with a horizontal spread. Notice also that cases (i) and (ii) above correspond to input errors rather than real biological events. Nonetheless, these situations are dealt with by our model. Indeed, case (i) is considered as a horizontal spread while case (ii) counts as a vertical spread. Our goal here is not to correct for these potential input errors but to provide a comprehensive framework that handles the diversity of biological situations.

In this paper, we propose a method, called AMOCOALA, which for a given pair of host and symbiont trees, first pre-estimates the probabilities of spread events directly

from the input (relying on heuristic frequencies estimates) and second estimates the probabilities of the remaining four classical cophylogeny events, relying on an ABC approach. In doing so, we also define a new distance to compare two symbiont trees that are associated with the same host tree in presence of multiple associations. Indeed, ABC methods heavily rely on the ability to compare observations with simulated datasets. In the cophylogeny context, this means comparing trees (as these are the most complete information on the data), a task that is far from trivial. Our new distance is an extension of the classical Maximum Agreement Subtree distance (*MAS*) (Ganapathy *et al.*, 2005) to what we call *set-labelled* trees. We believe this new distance can be of independent interest (see Section Model and Method and also Section B.3 in the Supplementary Material).

We test AMOCOALA on both synthetic and real datasets and compare the results with COALA. We could not compare our approach with the tool Alcalá *et al.* (2017) due to the, previously described, substantial differences both in the model and in the input. Our tests show that AMOCOALA produces results that seem closer than those of COALA to what is expected from the judgment of a biological expert.

2 Model and method

2.1 Reconciliations and cophylogeny events

Similarly to COALA, AMOCOALA is built on the event-based model presented in Charleston (2002); Tofigh *et al.* (2011). The *input* of AMOCOALA consists of a triple (H, S, ϕ) where H and S correspond to the phylogenetic trees of the hosts and symbionts, respectively, and ϕ is a relation from the leaves of the symbiont tree $L(S)$ to the leaves of the host tree $L(H)$. The relation ϕ describes the existing associations between currently living symbiont species and their hosts. More precisely, ϕ is a function from the set of symbiont leaves to the set of all subsets of host leaves. Notice that a multiple association will correspond to a leaf in the symbiont tree that is associated to more than one leaf in the host tree. The number of multiple associations is computed as the total number of those supernumerary leaf associations (*e.g.* a symbiont leaf associated to 2 different host leaves amounts to 1 multiple association). In COALA, as well as in all the models that do not allow for multiple associations, the relation ϕ assigns to each $s \in L(S)$ exactly one host leaf in $L(H)$ (notice however that one host can be associated to more than one symbiont). In AMOCOALA, this constraint will be dropped and thus we have that each leaf $s \in L(S)$ in the symbiont tree is associated to $\phi(s)$, a subset of $L(H)$.

A *reconciliation* λ is a function from the vertices of the symbiont species tree to the set of all subsets of vertices of the host tree that is an extension of ϕ , *i.e.* that is the same function as ϕ when restricted to the sets of leaves. In the classical setting, a reconciliation can be associated to a set of cospeciations, duplications, host switches and losses (the four classical cophylogeny events). For more details about the reconciliation model, we refer to Charleston (2002); Tofigh *et al.* (2011); Stolzer *et al.* (2012); Donati *et al.* (2015); Baudet *et al.* (2015) and Section A.2 in our Supplementary Material. In this paper, we extend the classical reconciliation model to include other biological

events.

Finally notice that here we focus on models that do not require the host tree to be dated. This is a clear advantage of the method as this information is rarely available and when it is available, is often not reliable. However, as we do not require the host tree to be dated some combinations of host switches can introduce an incompatibility due to the temporal constraints imposed by the host and symbiont trees, as well as by the reconciliation itself. We say that a reconciliation is *time-feasible* if it does not violate the time-feasibility constraints. The exact criterion we use to assess time-feasibility is the one defined in Stolzer *et al.* (2012) and that was already the one used in COALA.

Spread events. In AMOCOALA, we introduce two new additional cophylogeny events: vertical and horizontal spreads. We now define and illustrate both of them.

Vertical Spread. When for a symbiont s and with probability $p_{vs}(h)$, a vertical spread happens at a host h , the evolution of the symbiont s freezes in h , *i.e.* s continues to be associated with h and with the new species that descend from h . In the toy example depicted in Figure 1(a), we see that the symbionts s_1, s_2 are both related to all the hosts h_3, h_4, h_5 . One possible explanation is that the symbiont s_5 (the most recent common ancestor of s_1, s_2) was present in all the clade of h_8 (which is the most recent common ancestor of h_3, h_4, h_5). In that case, we say that h_8 is the ancestral host of s_5 and the two clades S_{s_5} (which denotes the symbiont clade rooted in s_5) and H_{h_8} (the host clade rooted in h_8) are related. We say that a vertical spread has happened at symbiont s_5 and we associate s_5 with all the vertices in the subtree rooted in h_8 (see Figure 1(b)).

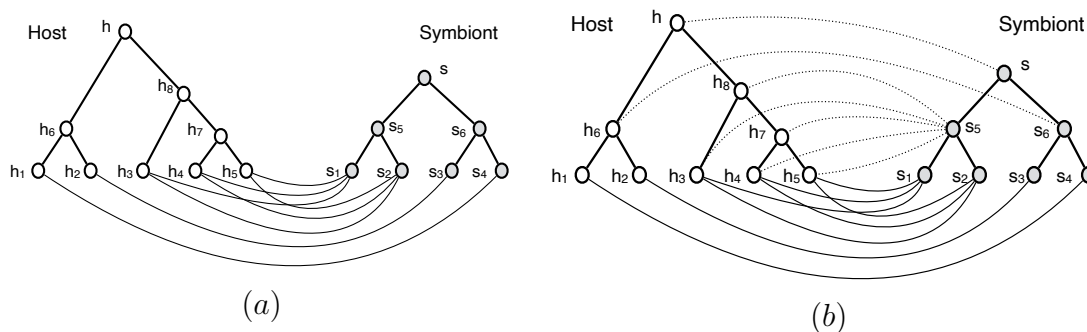


Figure 1: (a) Example of a dataset with multiple associations. The leaf associations are represented by plain lines and given by $\phi(s_1) = \{h_3, h_4, h_5\}$; $\phi(s_2) = \{h_3, h_4, h_5\}$; $\phi(s_3) = \{h_2\}$; $\phi(s_4) = \{h_1\}$. (b) In dotted lines, a reconciliation involving 2 cospeciations in s and s_6 and 1 vertical spread in s_5 . More precisely, the reconciliation is given by $\lambda(s) = \{h\}$; $\lambda(s_6) = \{h_6\}$ and $\lambda(s_5) = \{h_3, h_4, h_5, h_7, h_8\}$ (on the symbiont leaves, we have $\lambda = \phi$).

Horizontal Spread. In some datasets, we see the occurrence of the same symbiont in two different clades of the host tree. Such a situation cannot occur when relying only on cospeciation, duplication, loss, host switch or vertical spread events. Indeed, as already

underlined, the four initial events never produce multiple associations, while the vertical spread produces them only within clades. For this reason, we introduce a horizontal spread event. In the horizontal spread event, the symbiont remains with the initial host but at the same time gets associated with (*invades*) another host incomparable with the first, and undergoes a freeze, actually a double freeze as the evolution of the symbiont *freezes* in relation to the evolution of the host to which it was initially associated and in relation to the evolution of the second one it *invaded*. A horizontal spread event involves two probabilities: the probability $p_{\text{hs}}(h)$ that the horizontal spread occurs at node h of the host tree, and for any other host node h' that is incomparable to h , a probability $p_{\text{jump}}(h \rightarrow h')$ (symmetric wrt h, h') that the symbiont jumps from host h to host h' (and then freezes both under h and h'). In fact, $p_{\text{hs}}(h)$ is deduced from the values $\{p_{\text{vs}}(h), p_{\text{vs}}(h'), p_{\text{jump}}(h \rightarrow h')\}_{h'}$ for all h' incomparable to h (details are given in Section A.4 from the Supplementary Material). For illustrative purposes only, we show in Figure 2 an example of a reconciliation involving a horizontal spread event. The horizontal spread event happens in vertex s_5 as it is associated to two subtrees of the host tree, rooted in h_6 and h_7 , respectively.

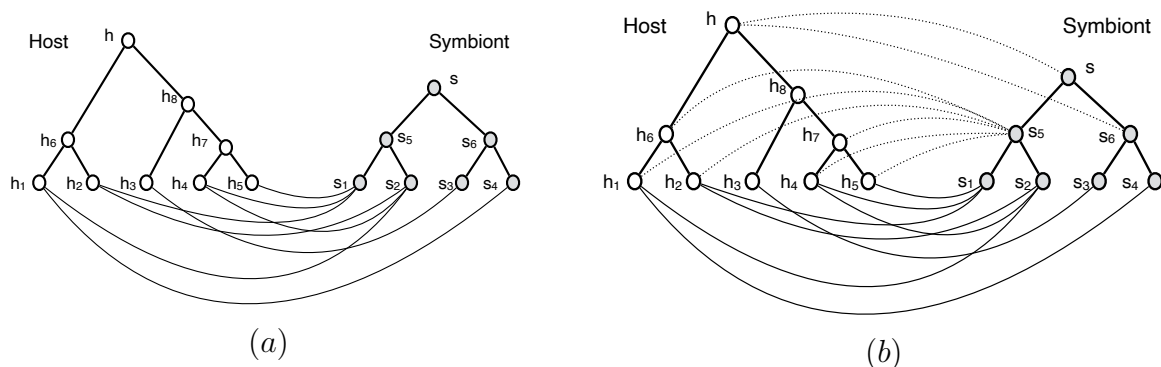


Figure 2: (a) Example of a dataset with multiple associations. The leaf associations are represented by plain lines and given by $\phi(s_1) = \{h_2, h_4, h_5\}$; $\phi(s_2) = \{h_1, h_2, h_4\}$; $\phi(s_3) = \{h_3\}$; $\phi(s_4) = \{h_1\}$. (b) In dotted lines, a reconciliation involving a horizontal spread event is shown. The symbiont s_5 makes a horizontal spread from h_6 to h_7 (or from h_7 to h_6) and thus is associated to the two subtrees H_{h_6} and H_{h_7} (*i.e.* $\lambda(s_5) = H_{h_6} \cup H_{h_7}$). The symbiont s is associated to a duplication (and $\lambda(s) = \{h\}$) and the symbiont s_6 to a cospeciation (and $\lambda(s_6) = \{h\}$).

2.2 General framework of AMOCOALA

The method we propose is based on the approximate Bayesian computation (ABC) method that was already used in COALA (Baudet *et al.*, 2015). We briefly recall it here for the sake of completeness. ABC methods belong to a family of likelihood-free Bayesian inference algorithms that attempt to estimate posterior densities for problems where the likelihood is unknown or may not be easily computed. ABC only requires that simulations under the statistical model at stake are possible. We recall that the

likelihood function expresses the probability of the observed data under a particular statistical model. More specifically, given a set of observed data D_0 (in our case the input (H, S, ϕ)) and starting with a prior distribution π on the space of the parameters of the model (here, the probabilities of the four classical cophylogeny events), the objective is to estimate the parameter values θ that could lead to the observed data using a Bayesian framework. Formally, we are interested in the posterior distribution $p(\theta|D_0) = p(D_0|\theta)\pi(\theta)/p(D_0)$.

For simple models, the likelihood function $p(D_0|\theta)$ can typically be derived. However, for more complex models the likelihood function might be computationally very costly to evaluate. In these cases, ABC methods approximate the posterior distribution by simulations, the outcomes of which are compared with the observed data. First, a population of N parameter values θ_i is sampled from the prior distribution. Then, for each sampled parameter θ , a dataset \tilde{D}_θ is simulated. It consists of a simulated symbiont tree \tilde{S}_θ together with a reconciliation $\tilde{\lambda}$ from \tilde{S}_θ to H . This dataset \tilde{D}_θ is then compared with the real dataset D_0 through a summary measure which is used as a *quality measure* to accept or reject the candidate parameter value θ . In many cases when it is believed that the prior and posterior densities are very different, the acceptance rate is very low. To deal with that issue, we can rely more specifically on a likelihood-free Sequential Monte Carlo (SMC) search that involves many iterations of the simulation procedure, each iteration targeting more precisely good candidate parameter values.

Given an input dataset (H, S, ϕ) , an ABC-SMC method was developed in COALA (Baudet *et al.*, 2015) to infer the posterior density of the probability of each of the four classical events, namely cospeciation, duplication, host switch and loss. COALA includes two main parts. The first consists in a simulation algorithm of the coevolutionary history of symbionts and their hosts. More specifically, given the host tree H and a vector $\theta = \langle p_c, p_d, p_s, p_l \rangle$ specifying the probability of each of the classical cophylogeny events, the model generates a symbiont tree \tilde{S}_θ together with a reconciliation from \tilde{S}_θ to H describing the ancient host-symbiont associations. In AMOCOALA, this first part is improved by introducing spread events whose probabilities of occurrence are fixed throughout all the simulations, while being heterogeneous along the host tree and specific to the original dataset. More precisely, these probabilities are pre-estimated on each dataset through simple frequency estimates related to the symbiont and host associations. Their values are specific to each node h of the host tree. The second part concerns a method to select the most likely probability vectors based on an ABC-SMC variant. It relies on the main idea that the most likely vectors θ will generate trees \tilde{S}_θ together with reconciliations $\tilde{\lambda}_\theta$ from \tilde{S}_θ to H that are similar to the original input (H, S, ϕ) .

In COALA, the symbiont trees together with their leaf associations were summarised through labelled trees and this step thus relied on a phylogenetic distance between labelled trees. In AMOCOALA, this part is improved by the introduction of a new distance that accounts for the possibility of multiple associations between \tilde{S}_θ and H . Indeed, the symbiont trees together with their leaf association may now be summarised through set-labelled trees (*i.e.* trees with leaves labelled by subsets of $L(H)$). We thus

provide and rely here on a new phylogenetic distance metric, called d_{MAS} between set-labelled trees. To the best of our knowledge, distances between set-labelled trees have not been considered in the literature and our proposal for such may be of independent interest.

In a nutshell, to deal with multiple associations coming from spread events, we thus extend COALA as follows: (i) we first propose estimators p_{spread} for all the probabilities needed to define spreads (namely, vertical spreads $p_{\text{vs}}(h)$, jumps $p_{\text{jump}}(h \rightarrow h')$ and horizontal spreads $p_{\text{hs}}(h)$ probabilities) given the input (H, S, ϕ) ; (ii) we introduce a new method to simulate the cophylogeny of the symbiont tree, along the host tree and given a candidate probability for each of the four classical cophylogeny events (cospeciation, duplication, host switch and loss) which also takes into account the probabilities of vertical and horizontal spread; (iii) we introduce a new distance to compare the simulated to the real symbiont trees in presence of multiple associations to the host tree.

2.3 Estimation of the probabilities of the events

In AMOCOALA, the probabilities $\langle p_c, p_d, p_s, p_l \rangle$ of the four classical cophylogeny events (cospeciation, duplication, host switch and loss) are parameters inferred relying on the ABC-SMC approach, namely they are first sampled from a prior distribution and then later selected according to some criteria that are specified later. **On the contrary, the probabilities $p_{\text{vs}}(h)$ and $p_{\text{hs}}(h)$ for the (vertical and horizontal) spread events at each host node h are not estimated within the ABC-SMC method but rather in a preliminary step, directly from the input.** This choice is mainly driven by the fact that in a realistic model the spread probabilities are not constant throughout the host tree. For instance, a spread event appearing near to the root is less likely to happen than one close to the leaves. Indeed, spread events were introduced partly to account for recent host switches (see point (iii) in the introduction) and more generally they are motivated by the fact that symbionts may not diversify immediately, which is less likely close to the root. Then, as the probability of a spread event is specific to each vertex of the host tree, sampling the spread events will increase significantly the size of the parameter space and thus the size of the space of the generated symbiont trees. Hence, in this framework the spread probabilities cannot be inferred in the ABC procedure. Nevertheless, these probabilities are clearly related to the shape of the host and symbiont trees and to the associations between their leaves. For this reason, we exploit the signal from the input to pre-estimate the probabilities of the spread events. These probabilities are used in the generation of the putative symbiont trees and are not inferred through the ABC-SMC method. Details about these estimators as well as an assessment of the robustness of the ABC method with respect to these pre-estimated values are given in Sections A.4 and D.3 from the Supplementary Material, respectively.

2.4 Simulation of a symbiont tree in AMOCOALA

We now describe the procedure of generation of simulated symbiont trees in AMOCOALA. Similarly to COALA, our algorithm takes as input (H, S, ϕ) and the probabil-

ities of each of the events, and simulates the evolution of the symbionts by following the evolution of the hosts, *i.e.* by traversing H from the root to the leaves, and progressively constructing the phylogenetic tree \tilde{S} for the symbionts and at the same time mapping them to subsets of vertices of the host tree, *i.e.* constructing $\tilde{\lambda}$. In this process, a symbiont vertex can be in two different states: mapped or unmapped. At the moment of its creation, a new vertex \tilde{s} is unmapped and is assigned a temporary position on an arc a of the host tree H . We denote this situation by $\langle \tilde{s} : a \rangle$. We let $h(a)$ denote the head of the arc a (*i.e.* the vertex at the endpoint of a that is farthest from the root). Then vertex \tilde{s} is mapped to either vertex $h(a)$ of H (*i.e.* $\tilde{\lambda}(\tilde{s}) = \{h(a)\}$ for cospeciation, duplication and host switch) or to a subset \mathcal{H} of vertices of H (*i.e.* $\tilde{\lambda}(\tilde{s}) = \mathcal{H}$ for vertical and horizontal spread). Notice that for the vertical spread, the subset of vertices \mathcal{H} corresponds to a clade in H , while for the horizontal spread it corresponds to the union of two clades in H .

In the cases of cospeciation, duplication, and host switch, a speciation has occurred in the symbiont tree and hence two children are created for \tilde{S} , denoted by \tilde{s}_1 and \tilde{s}_2 . Their positioning along the arcs of the host then depends on which of the three events took place. In the case of a loss, no child for \tilde{S} is created (at this step) since there is no symbiont speciation, and \tilde{S} is just moved to one of the two arcs outgoing from $h(a)$ chosen randomly.

The case of a spread event is different. Consider for instance the example in Figure 3. A vertical spread occurs at the symbiont s_6 on the host h_8 and thus s_6 is associated to all the subtree H_{h_8} (the host clade rooted in h_8). Moreover, we choose that all the symbionts descendent from s_6 are associated to the same clade as s_6 (see Definition A.2 in the Supplementary Material). We now need to choose a realistic way of continuing the simulation of the symbiont subtree below s_6 . We call the subtree of the symbiont tree rooted at a vertex associated to a spread event (vertical or horizontal) a *ghost subtree*. In Figure 3, the subtree S_{s_6} is a ghost subtree. Then during the generation of the symbiont tree \tilde{S} when a symbiont \tilde{s} undergoes a spread event, we need to simulate the ghost subtree rooted in \tilde{s} up to its leaves, in order to end the simulation in this part of the tree. After a spread event, with the passing of time, both the host and the symbiont have evolved and in addition, it could be that some hosts have lost some of their symbionts. Taking into account all the possible evolutions of the symbiont is computationally unfeasible in practice. Therefore, for computational reasons, we decide to promote the simplest situation. In particular, no other event takes place after a spread event and we mimic in this part of the simulated symbiont tree the evolution occurring in the real symbiont tree. Therefore we choose a topology and leaf associations that are identical to those present in S . More formally, if a vertical spread occurs at \tilde{s} on the host h , we consider the set of host leaves descendent from h , namely $L = L(H_h)$. Let L' be the set of symbiont leaves that are associated to the leaves in L , *i.e.* $L' = \phi^{-1}(L) \cap L(S)$. The ghost subtree $\tilde{S}_{\tilde{s}}$ is then set equal to $S_{|L'}$, the subtree of the *real* symbiont tree induced by leaves L' . The case of horizontal spread is analogous, except that the set of leaves L is given by the union of $L(H_h)$ and $L(H_{h'})$ where h, h' are the two host vertices involved in the horizontal spread. Once the ghost tree is set, the simulation ends in this part of the tree. Notice that as already mentioned, the

spread events are more likely to occur far from the root, so that the loss of variability in the simulated tree \tilde{S} induced by this choice is counterbalanced by the fact that it should affect a small part of the tree. More details are given in Section B.1 from the Supplementary Material.

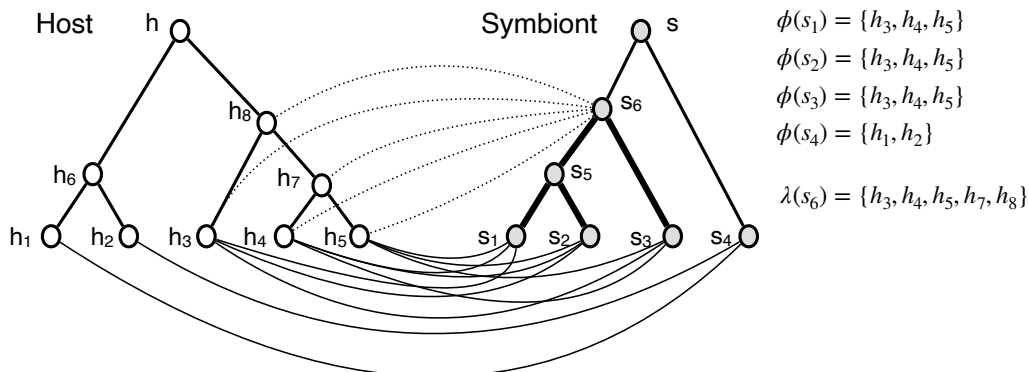


Figure 3: The symbiont s_6 is associated to a vertical spread on the host h_8 and thus is associated to all the subtree H_{h_8} . As we do not know exactly how the symbiont s_5 is associated, we symbolically associate it to all the vertices in H_{h_8} . The subtree of S in bold corresponds to a ghost subtree.

The symbiont tree simulation algorithm is summarised in Algorithm 1. It relies on the following notation. A generic arc from the host tree H is denoted by a , its outgoing arcs are a_1, a_2 and its head (end node farthest from the root) is $h(a)$. $L(T)$ is the set of leaves of T , while the subtree of T rooted at node h is denoted by T_h . Finally, for any set of leaves L , we let $T|_L$ denote the subtree of T whose set of leaves is exactly L . This $T|_L$ is also the subtree of T rooted at the most recent common ancestor of the elements in L . During the algorithm, before defining the simulated association $\tilde{\lambda}(\tilde{s})$ of a simulated symbiont node \tilde{s} , the node is temporarily positioned on an arc a , which is denoted by $\langle \tilde{s} : a \rangle$.

Finally, Figures 4 to 7 illustrate the different steps of the symbiont tree generation procedure.

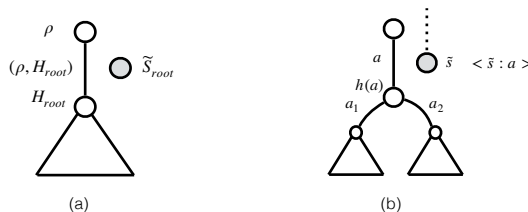


Figure 4: Simulation algorithm. (a) Starting configuration. (b) Unmapped vertex \tilde{s} .

Algorithm 1 Generation of a symbiont tree under model allowing for spreads

- 1: **Input:** (H, S, ϕ) and parameter vector $\langle p_{\text{spread}}, \theta \rangle$
 - 2: Create the root vertex \tilde{s}_{root} and position it on the arc a before the root of H :
 $\langle \tilde{s}_{\text{root}} : a \rangle$
 - 3: Add \tilde{s}_{root} to the set U of unmapped nodes of \tilde{S}
 - 4: **while** U not empty **do**
 - 5: **for all** $\tilde{s} \in U$ with position $\langle \tilde{s} : a \rangle$ **do**
 - 6: **if** $h(a)$ is a leaf of H **then** remove \tilde{s} from U and go to line 4
 - 7: **end if**
 - 8: **Horizontal spread:** Sample $HS \sim \text{Bern}(p_{\text{hs}}(h(a)))$
 - 9: **if** $HS = 1$ **then**
 - 10: **if** no vertex h' is incomparable to $h(a)$ **then** go to line 14
 - 11: **else** sample with probability $p_{\text{jump}}(h(a) \rightarrow h')$ a vertex h' incomparable to $h(a)$, map $\tilde{\lambda}(\tilde{s}) = H_{h(a)} \cup H_{h'}$ and go to line 32
 - 12: **end if**
 - 13: **end if**
 - 14: **Vertical spread:** Sample $VS \sim \text{Bern}(p_{\text{vs}}(h(a)))$
 - 15: **if** $VS = 1$ **then** map $\tilde{\lambda}(\tilde{s}) = H_{h(a)}$. Let $L = L(H_{h(a)})$ and $L' = \phi^{-1}(L) \cap L(S)$. Paste $S_{|L'}$ in \tilde{S} below \tilde{s} ; for all $s' \in S_{\tilde{s}}$, map $\tilde{\lambda}(s') = H_{h(a)}$ and go to line 32
 - 16: **end if**
 - 17: **Classical event:** Sample $E \sim \mathcal{M}(1, \theta)$ multinomial event among $\{C, D, S, L\}$
 - 18: **if** $E \in \{C, D, S\}$ **then** map $\tilde{\lambda}(\tilde{s}) = \{h(a)\}$ and create \tilde{s}_1, \tilde{s}_2 children of \tilde{s}
 - 19: **end if**
 - 20: **if** $E = C$ (cospeciation) **then** position $\langle \tilde{s}_1 : a_1 \rangle$ and $\langle \tilde{s}_2 : a_2 \rangle$ and go to line 31
 - 21: **end if**
-

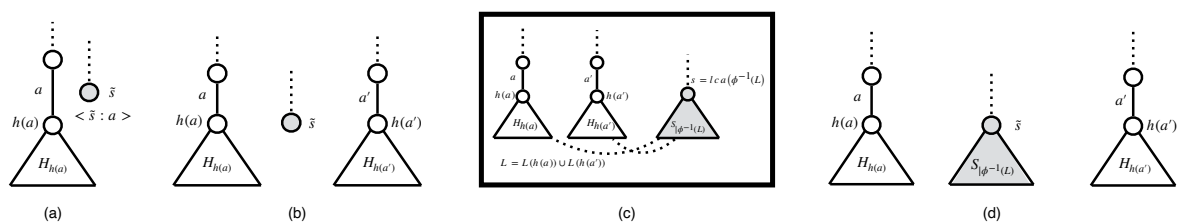


Figure 5: Simulation of a horizontal spread. (a) Initial configuration. (b) Mapping of vertex \tilde{s} : we let $\tilde{\lambda}(\tilde{s}) = H_{h(a)} \cup H_{h(a')}$. (c) Looking in the real symbiont tree for the ghost subtree to be used in the next step. (d) Creating the ghost subtree in \tilde{s} and stopping the evolution of the leaves of $\tilde{S}_{\tilde{s}}$.

22: **if** $E = D$ (duplication) **then** position $\langle \tilde{s}_1 : a \rangle$ and $\langle \tilde{s}_2 : a \rangle$ and go to line 31
 23: **end if**
 24: **if** $E = S$ (switch) **then** position $\langle \tilde{s}_1 : a \rangle$
 25: **if** no vertex h' is incomparable to $h(a)$ OR there is no arc a' in H such
 that $\langle \tilde{s}_2 : a' \rangle$ does not violate time feasibility condition **then** sample $E \sim \mathcal{M}(1, \theta')$
 multinomial event among $\{C, D, L\}$ with $\theta' = \langle p_c, p_d, p_l \rangle / (p_c + p_d + p_l)$ and go to
 line 18
 26: **else** uniformly choose arc a' (among those that do not violate time fea-
 sibility condition) in H ; position $\langle \tilde{s}_2 : a' \rangle$ and go to line 31
 27: **end if**
 28: **end if**
 29: **if** $E = L$ (loss) **then** randomly choose $a' \in \{a_1, a_2\}$, position $\langle \tilde{s} : a' \rangle$ and go
 to line 5
 30: **end if**
 31: Add \tilde{s}_1, \tilde{s}_2 in U
 32: Remove \tilde{s} from U
 33: **end for**
 34: **end while**
 35: **Output:** Simulated symbiont tree \tilde{S} and reconciliation $\tilde{\lambda}$ to host H

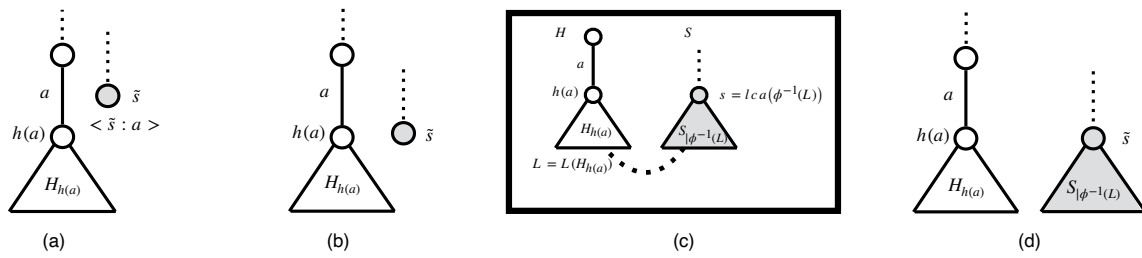


Figure 6: Simulation of a vertical spread. (a) Initial configuration. (b) Mapping of vertex \tilde{s} : we let $\tilde{\lambda}(\tilde{s}) = H_{h(a)}$. (c) Looking in the real symbiont tree for the ghost subtree to be used in the next step. (d) Creating the ghost subtree in \tilde{s} and stopping the evolution of the leaves of $\tilde{S}_{\tilde{s}}$.

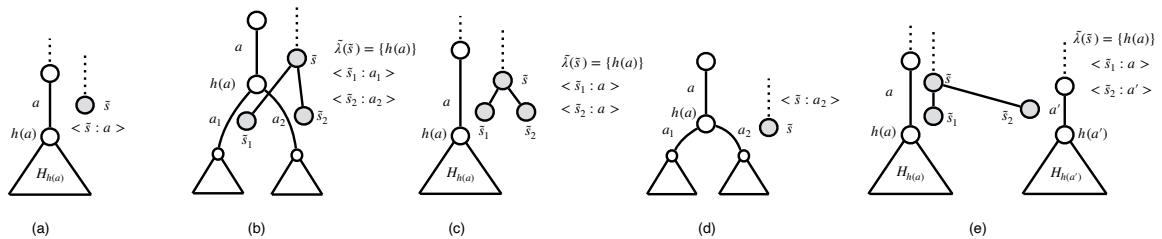


Figure 7: Simulation of a classical event. (a) Initial configuration. (b) Cospeciation. (c) Duplication. (d) Host switch. (e) Loss.

2.5 ABC-SMC inference method

AMOCOALA is based on the same ABC-SMC method presented in COALA. It is an iterative method with many rounds, and it involves a summary discrepancy that describes the quality of any candidate vector θ (*i.e.* how much it is susceptible to have generated the observed dataset). We first present Algorithm 2 that describes how we rely on simulated trees in a reconciliation model with spreads produced through Algorithm 1, to characterize the quality of a candidate vector $\theta = \langle p_c, p_d, p_s, p_l \rangle$ with respect to the observed dataset (H, S, ϕ) . In particular, for each candidate vector θ , we produce many different trees and summarise them into a discrepancy d_θ that characterizes the quality of θ as a candidate to produce the observed data. The structure of this procedure is unchanged from COALA, except for the way we compute the discrepancy d_θ .

Algorithm 2 Symbiont tree simulation algorithm overview

- 1: **Input:** (H, S, ϕ) , parameter vector $\langle p_{\text{spread}}, \theta \rangle$
 - 2: **Parameters:** M number of simulated symbiont trees
 - 3: **for** $m=1$ to M **do**
 - 4: Apply Algorithm 1 with input (H, S, ϕ) and parameters $\langle p_{\text{spread}}, \theta \rangle$ and output $(\xi_{\theta,m}, \lambda_{\theta,m})$
 - 5: **if** $|S_{\theta,m}| \geq 2|S|$ **then** discard the tree and return to line 4
 - 6: **end if**
 - 7: Compute $d_{\theta,m}$ discrepancy between $(\tilde{S}_{\theta,m}, \tilde{\lambda}_{\theta,m})$ and (S, ϕ)
 - 8: **end for**
 - 9: Compute d_θ as the average value of $\{d_{\theta,m}\}_{1 \leq m \leq M}$
 - 10: **Output:** d_θ
-

We then present a general overview of the ABC-SMC procedure in Algorithm 3. We include all the details of the method in Section B.2 from the Supplementary Material. Moreover, we report below the differences between this procedure and the one at stake in COALA.

The main difference between Algorithms 2 and 3 and their respective corresponding versions in AMOCOALA lies in the summary discrepancy d_θ used to quantify the quality of the vector θ . The summary discrepancy between a simulated dataset (the generated symbiont tree and its host associations) and the observed one (the real symbiont tree and its host associations) is measured through a distance between phylogenetic trees which can be calculated in polynomial time. Similarly as in COALA, this discrepancy is built from two components: (i) d_1 , that describes how much the simulated tree \tilde{S}_θ is representative of the vector θ , and ii) d_2 that measures how much is \tilde{S}_θ (and its labels) topologically similar to S (and its labels). The value of d_1 is computed identically as in COALA. As concerns point (ii), the distance used here is different from the one used in COALA and we detail its definition and motivation in the next paragraph.

Algorithm 3 ABC-SMC procedure

```

1: Input:  $(H, S, \phi, p_{\text{spread}})$ 
2: Parameters:  $R$  rounds,  $N$  initial number of vectors,  $\{\tau_i\}_{1 \leq i \leq R}$  tolerance values at
   each round,  $M$  simulated symbiont trees for each vector
3: Sample  $N$  vectors  $\theta = \langle p_c, p_d, p_s, p_l \rangle \sim \mathcal{D}(1, 1, 1, 1)$ , stored in set  $\Theta$ 
4: for all  $\theta$  in  $\Theta$  do
5:   Apply Algo 2 with input  $(H, S, \phi, p_{\text{spread}})$ , parameter  $M$ . Output  $d_\theta$ 
6:   Select  $Q_1 = \tau_1 \times N$  parameter vectors with smallest  $d_\theta$ , stored in set  $A_1$  and
   set  $\epsilon_1 = \text{Argmax}_{\theta \in A_1} d_\theta$ 
7: end for
8: for  $r = 2$  to  $R$  do
9:   Sample  $\theta^*$  uniformly in  $A_{r-1}$  and create  $\theta^{**}$  by perturbing  $\theta^*$ 
10:  Apply Algo 2 with input  $(H, S, \phi, p_{\text{spread}}, \theta^{**})$ , parameter  $M$ . Output  $d_{\theta^{**}}$ 
11:  if  $d_{\theta^{**}} \leq \epsilon_{r-1}$  then add  $\theta^{**}$  to quantile set  $Q_r$ 
12:  end if
13:  if  $|Q_r| \leq Q_{r-1}$  then return to line 9
14:  end if
15:  Select  $Q_r = \tau_r \times Q_{r-1}$  parameter vectors with smallest  $d_{\theta^{**}}$ , stored in set  $A_r$ 
   and set  $\epsilon_r = \text{Argmax}_{\theta \in A_r} d_\theta$ 
16: end for
17: Output: Selected vectors  $\theta$ 

```

2.6 A distance between set-labelled trees

There are many distances between tree topologies, though not all are simple to compute. However, the topology of a simulated tree is not sufficient to characterize its similarity in the reconciliation context. Here, we want to consider, on top of the topology, the leaf labels of the tree. Indeed, the sets that label the leaves of the (simulated) symbiont tree contain information on the associations given by the coevolution of symbionts with their hosts. In AMOCOALA, the leaves of both the observed and the simulated symbiont trees (S and \tilde{S} respectively) are labelled by the host leaves to which they are associated. Thus, due to possible multiple associations in AMOCOALA, those symbiont trees are what we call *set-labelled* trees, that is, their leaves are labelled with sets and not with singletons. To the best of our knowledge, distances for set-labelled trees have not been considered in the literature and we believe our proposal for such is thus of independent interest.

We first recall that the MAST distance of two phylogenetic trees T_1 and T_2 corresponds to the number of leaves in the largest isomorphic subtree that is common to the two trees (subtrees common to the two trees are called agreement subtrees and we look for the one with the largest number of leaves). Clearly this isomorphism takes into account the labels of the trees. The MAST distance can be calculated in $O(n^2)$ time where n is the size of the largest input tree (Ganapathy et al., 2006). For set-labelled trees, we need to take into account the sizes of the sets of labels in the possible

agreement subtrees.

Thus, given a set-labelled tree T , we denote its *weight* by $w(T) = \sum_{v \in L(T)} |l(v)|$, where $l(v)$ is the set of labels associated to the leaf v . Now, a *maximum agreement set-labelled subtree*, denoted by $MAS(T_1, T_2)$, is a set-labelled subtree that is common to the two trees T_1, T_2 and which has largest weight. Notice that a common subtree may have leaf labels that are subsets of the original ones. As a consequence, the MAS of two trees does not necessarily have the maximum number of leaves among the set-labelled agreement subtrees, as shown in Figure 8. In the same way as the MAST distance is defined, we introduce the *maximum agreement set distance*, denoted by d_{MAS} , between two set-labelled phylogenetic trees T_1, T_2 as well as a normalized related quantity d_2 , respectively defined as

$$d_{MAS}(T_1, T_2) = \max\{w(T_1), w(T_2)\} - w(MAS(T_1, T_2))$$

$$d_2(T_1, T_2) = \frac{d_{MAS}(T_1, T_2)}{\max\{w(T_1), w(T_2)\}} = 1 - \frac{w(MAS(T_1, T_2))}{\max\{w(T_1), w(T_2)\}}.$$

We can prove that d_{MAS} is a distance metric and that it can be calculated in polynomial time using a dynamic programming algorithm. Note that the normalized quantity d_2 has the advantage of lying in $[0, 1]$ and is computed with the same complexity as d_{MAS} . It is only a pseudo-distance (as it does not satisfy the triangular inequality). The resulting d_θ defined relying on d_2 is a *summary discrepancy* (see details in Section B.3 from the Supplementary Material).

2.7 Summary of AMOCOALA

Algorithm 4 presents a final summary of the algorithm at stake in AMOCOALA. The output of the ABC-SMC procedure is a specified number of selected vectors θ . Similarly as COALA, AMOCOALA further performs a hierarchical clustering procedure, with an automatic selection of the number of groups, to cluster the final list of accepted parameter vectors. The clusters and their number are automatically selected through the R package `dynamicTreeCut` (for details, see Langfelder et al., 2007).

Algorithm 4 AMOCOALA general structure

- 1: **Input:** (H, S, ϕ)
 - 2: **Parameters:** R rounds, N initial number of vectors, $\{\tau_i\}_{1 \leq i \leq R}$ tolerance values at each round, M simulated symbiont trees for each vector
 - 3: **Compute:** Vertical spread $p_{vs}(h)$ and jump $p_{jump}(h \rightarrow h')$ probabilities for any incomparable nodes $h, h' \in H$; deduce horizontal spread $p_{hs}(h)$ probabilities. Gather these quantities in vector p_{spread}
 - 4: **ABC-SMC procedure:** Apply Algo 3 with input (H, S, ϕ, p_{spread}) and parameters $(R, N, \{\tau_i\}_{1 \leq i \leq R}, M)$
 - 5: **Output:** Selected vectors θ , and (optional) clusters of these vectors
-

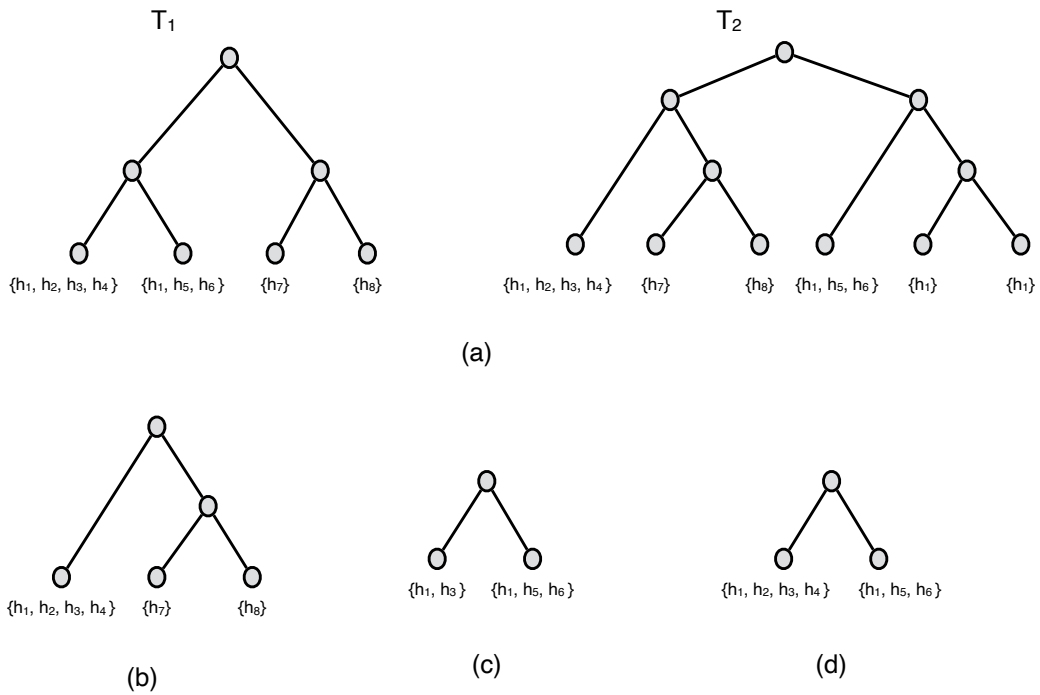


Figure 8: (a) Two set-labelled phylogenetic trees. T_1 has weight 9 and T_2 has weight 11. In (b), (c), (d), three different agreement set-labelled subtrees of weights 6, 5 and 7 respectively. The maximum agreement set-labelled subtree is the one depicted in (d) and notice that it does not have the maximum number of leaves.

3 Experimental results and discussion

3.1 Experimental settings

Parameter settings. For each (synthetic or biological) dataset (H, S, ϕ) , we ran AMOCOALA with the following parameter values. We simulated $N = 2000$ vectors θ^i , ($1 \leq i \leq 2000$) in the first round of simulation. For each vector θ^i , we simulated $M = 1000$ symbiont trees. We discarded the simulated trees whose size is larger than twice the one of the real symbiont tree S in input as being too different from the original one. The tolerance value used in the first round was $\tau_1 = 0.1$. We ran $R = 3$ rounds and we defined $\tau_i = 0.25$. Notice that $\tau_1 \times N = 200$ defines the size Q of the quantile set which must be produced in each new round. Thus, after the last round, we have $\tau_3 \times Q = 50$ accepted vectors.

Synthetic datasets generation. Synthetic datasets are obtained in a similar way as in COALA (see Baudet *et al.*, 2015, for more details), the only difference lying on the fact that the simulation algorithm now includes spread events. In particular, we use the real symbiont tree and its (multiple) associations to the host tree to derive the spread probabilities. To obtain realistic datasets, we started from a real biological tree and chose the dataset SFC described in the next section. This host tree H (and associated spread probabilities) is combined with 8 different parameter values. We thus simulated 8 datasets $(H, S_{\theta_j}, \phi_j)$ for $1 \leq j \leq 8$ associated with the following 8 probability vectors, in the form $\theta = \langle p_c, p_d, p_s, p_l \rangle$. We used $\theta_1 = \langle 0.70, 0.10, 0.10, 0.10 \rangle$, $\theta_2 = \langle 0.80, 0.15, 0.01, 0.04 \rangle$, $\theta_3 = \langle 0.75, 0.01, 0.16, 0.08 \rangle$, $\theta_4 = \langle 0.70, 0.05, 0.02, 0.23 \rangle$, $\theta_5 = \langle 0.60, 0.20, 0.00, 0.20 \rangle$, $\theta_6 = \langle 0.55, 0.00, 0.20, 0.25 \rangle$, $\theta_7 = \langle 0.45, 0.10, 0.15, 0.30 \rangle$ and $\theta_8 = \langle 0.40, 0.20, 0.10, 0.30 \rangle$. The choice of these vectors was done with the aim to cover some typical coevolution patterns of probability. Indeed, vectors with very low probability of cospeciation correspond to situations where there is almost no signal of the coevolution of the species at a macroevolutionary level. In these cases, the cophylogeny reconciliation methods are not appropriate (Baudet *et al.*, 2015; Althoff *et al.*, 2014). Moreover, a high probability of host switches or duplications is not appropriate to produce synthetic datasets due to the variability of the simulated trees. Note that for these reasons, a ninth parameter value used in COALA was discarded here.

3.2 Results of the self-test

The objective of this test is to check whether AMOCOALA produces the correct results for synthetic datasets where we know the truth. To this purpose, we ran AMOCOALA 50 times on each of the 8 synthetic datasets generated as explained in the previous subsection with true parameter value θ_i . We expected to find a vector “very close” to θ among the vectors accepted on the last round of AMOCOALA. Note that contrarily to what we did in COALA, we here rely on an Euclidean distance over the parameter vectors. At the end of the third round, we therefore took note of the clus-

ter whose representative parameter vector had the smallest Euclidean distance to θ_i (we call it the "best" cluster). We also stress again that parameter vectors do not include the probabilities of spread events, which are pre-estimated before applying the ABC-SMC approach.

The results for the first parameter value θ_1 are presented in Figure 9. The results for the other vectors are similar and given in Figures Ba to Cd from the Supplementary Material.

The first column shows the histograms of the distances between θ_i and the representative parameter in the best cluster. Then, columns 2 to 5 show the histograms of the distribution of the event probabilities in these best clusters. The solid vertical red line indicates the true parameter value. The dashed vertical black line indicates the mean value. Overall the distances (first columns) are rather small and the parameters are correctly estimated (columns 2 to 5). In some specific cases, the slightly lower performance of the method may often be explained by the difficulty of the problem. For instance, for parameter vector θ_8 , the low cospeciation level makes the reconciliation problem less relevant. It results in over-estimation of the cospeciation and underestimation of the loss probabilities. Overall, these simulations show that AMOCOALA is able to select parameter vectors that are close to the true ones.

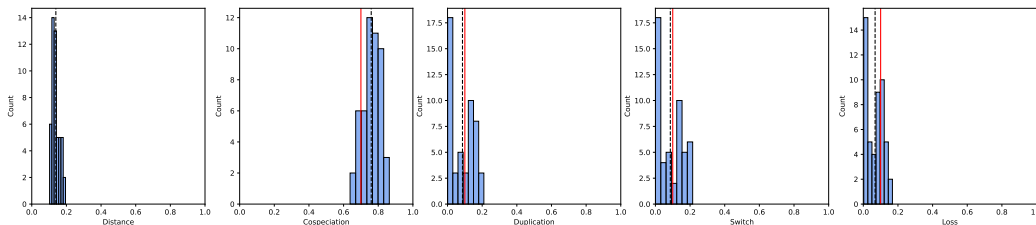


Figure 9: For each simulated dataset with true parameter value $\theta_1 = \langle 0.70, 0.10, 0.10, 0.10 \rangle$, we ran AMOCOALA 50 times and, at the end of the third round, we took note of the cluster whose representative parameter vector had the smallest euclidean distance (histograms shown in the first column) to θ_1 . Columns 2 to 5 show the histograms of the distributions of the event probabilities in these "best" clusters. The dashed vertical black line indicates the mean value. The solid vertical red line indicates the true parameter value.

3.3 Biological datasets

To test our method, we selected 4 biological datasets from the literature. The choice of these datasets was dictated by: (1) the availability of the data in public databases, (2) the desire to cover for situations as widely different as possible in terms of the topology of the trees and the presence of multiple associations. The phylogenetic trees of each dataset can be found in Figures D to G from the Supplementary Material. As already mentioned, any dataset D containing multiple associations cannot be analysed with COALA. Thus, in order to compare the results with those obtained by COALA (Baudet *et al.*, 2015), for each real dataset D we generated a dataset D_{Coala} which is

obtained from D by randomly choosing exactly one association (among existing ones and whenever there are more than 2 such associations) for each symbiont leaf. Notice that this is what is usually done in the literature when analysing such datasets with a method that does not allow for multiple associations. We detail here the results obtained for only two datasets, the reader can find the remaining ones in Section D.1 from the Supplementary Material. Computing times are also presented in Section D.2 from the Supplementary Material.

Dataset 1: AP - Acacia & Pseudomyrmex. This dataset was extracted from Gómez-Acevedo *et al.* (2010) and displays the interaction between *Acacia* plants and *Pseudomyrmex*, a genus of ants. Although the authors did not use a cophylogeny reconstruction tool to analyse the dataset, this is considered as a typical example of mutualism between ants and plants, and the authors show that their relationship originated in Mesoamerica between the late Miocene to the middle Pliocene, with eventual diversification of both groups in Mexico. The host and symbiont trees include 9 and 7 leaves, respectively. The dataset has 22 multiple-associations. The corresponding dataset with no multiple association is called AP_{Coala} .

Dataset 2: SFC - Smut Fungi & Caryophyllaceus plants. This dataset was extracted from Refrégier *et al.* (2008). The host and symbiont trees include 15 and 16 leaves, respectively. The dataset has 4 multiple associations. The corresponding dataset with no multiple association is called SFC_{Coala} . Notice that this is the same dataset used in Baudet *et al.* (2015).

In Figures 10 and 11, we present for each of the cophylogeny events, the distribution of the inferred probabilities obtained by running AMOCOALA and COALA. First notice that the results change substantially when we consider the complete dataset instead of the one obtained by removing the multiple associations. Indeed, from the graphics in the third row of Figure 10, we see that if we ignore multiple associations, then COALA explains the dataset using a very low cospeciation frequency and a high number of switches and losses. In general, we can say that COALA detects a high incongruence between the trees which cannot be explained by cospeciations. However, if the complete dataset is considered, *i.e.* the one including all the multiple associations, we see from the first two rows of Figure 10 that the dataset can be explained by only 2-3 horizontal spreads, a high number of cospeciations, a very low number of duplications and switches and also a significantly lower number of losses. Thus, the incongruence between the two phylogenetic trees can be explained by approximately 3 horizontal spreads and then most of the events correspond to cospeciations, which is an indication of coevolution. This is in accordance with what is expected for this dataset, which, as already mentioned in the previous paragraph, is considered as a typical example of mutualism between ants and plants.

Next, we considered the dataset SFC with multiple associations proposed in Refrégier *et al.* (2008). From Figure 11, we can see that both methods show similar results concerning cospeciations, duplications and host switches while AMOCOALA outputs a smaller number of losses (less than 25%) compared to COALA (less than 40%). In Refrégier *et al.* (2008), the different analyses performed indicated that the most plausible reconciliations presented for the SFC dataset have from 0 to 3 cospeciations, no

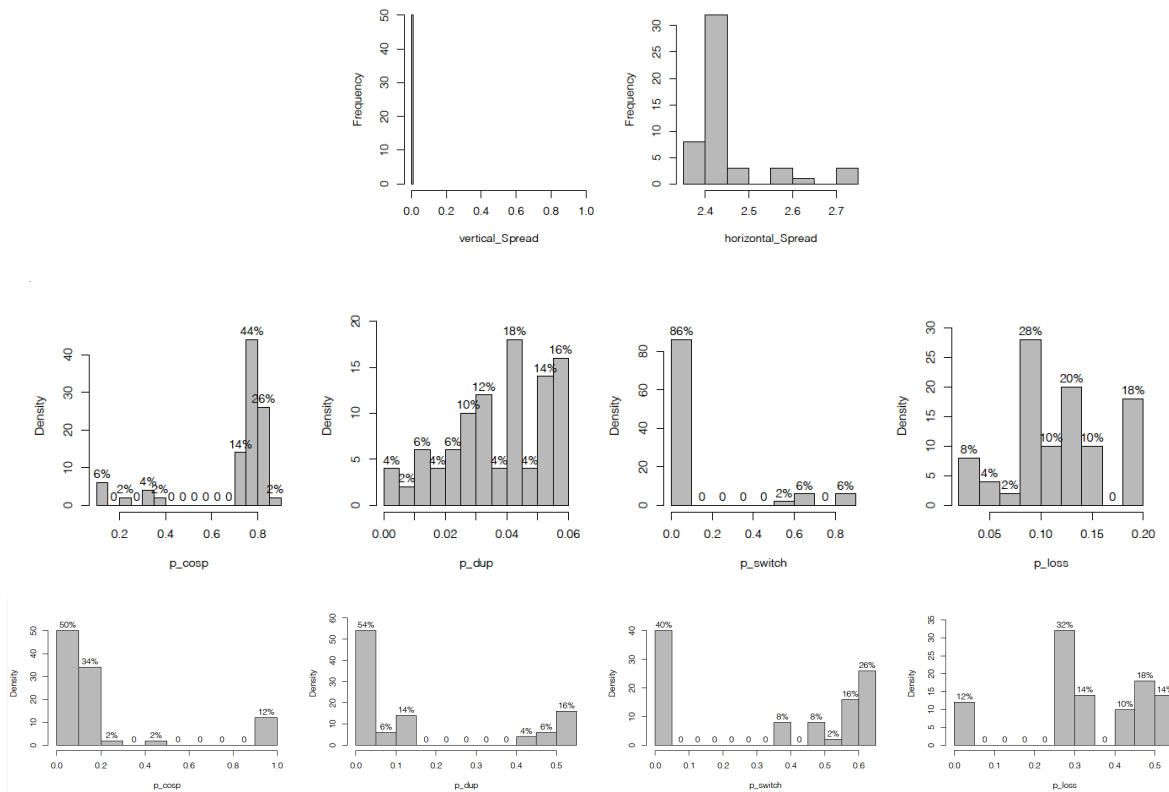


Figure 10: Comparison of the results obtained with AMOCOALA and COALA for the dataset AP. In each graphic, we show for each event type, the distribution of the parameter values. In the first two rows, the results provided by AMOCOALA and in the third row, the ones provided by COALA.

duplication, 12 to 15 host switches and 0 to 2 losses. It is impossible for us to calculate the number of events in a parsimony framework because there is no parsimonious algorithm for computing optimal reconciliations in the presence of vertical and horizontal spreads. Nonetheless, we have access to estimated frequencies of the reconstructed events. Moreover, from the definition of the model (see Sections A.2 and A.3 from the Supplementary Material) we know that the sum of the classical events (cospeciation, duplication and host switch), excluding the loss event, is equal to the number of internal vertices of the symbiont tree. The symbiont tree (that is the same for SFC and SFC_{Coala}) has 15 internal vertices. Based on the analyses presented in Refrégier *et al.* (2008), we expect to have events with the following frequencies: between 0% and 20% for cospeciations (from 0 to 3 events), 0% for duplications (no duplications), between 80% and 100% for host switches (from 12 to 15 events) and between 0% and 13% for losses (from 0 to 2 events). To compare the results output by the two methods (COALA and AMOCOALA) with those expected from the analyses of Refrégier *et al.* (2008), we cluster the parameter vectors output by the methods. Indeed, both COALA and AMOCOALA perform a hierarchical clustering procedure to group the final list of accepted parameter vectors. We then compared the cluster patterns found by the two

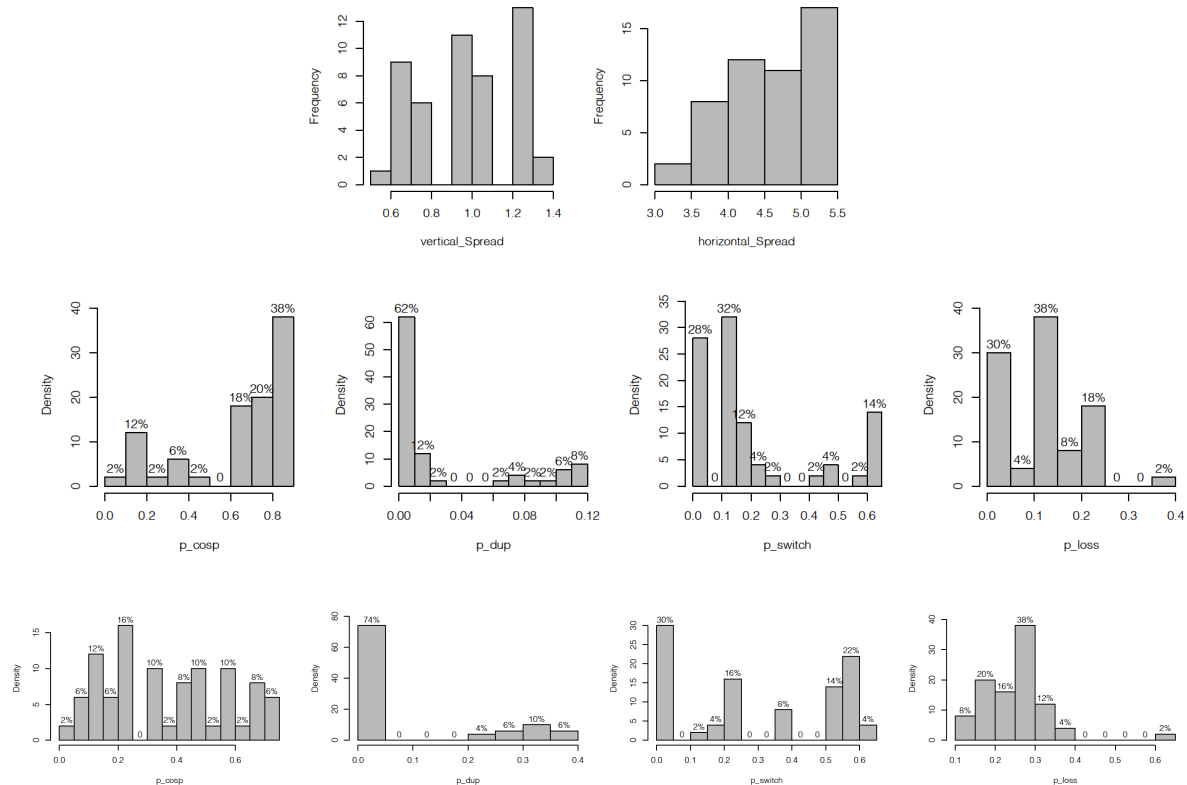


Figure 11: Comparison of the results obtained with AMOCOALA and COALA for the dataset SFC. In each graphic, we show for each event type, the distribution of the parameter values. In the first two rows, the results provided by AMOCOALA and in the third row, the ones provided by COALA.

methods. Table 1 shows the representative vectors of each of the clusters output by AMOCOALA (for the SFC dataset) and by COALA (for the SFC_{Coala} dataset). Notice that as already mentioned in Baudet *et al.* (2015), a vector with a high frequency of host switches can generate a large space of simulated trees, many of which can have a high distance from the real symbiont tree. Thus, it is clear that such vectors are more difficult to be output by both COALA and AMOCOALA.

From the results in Table 1, we have that the event vector that is most similar to the expected one according to Refrégier *et al.* (2008) is Cluster 2 for AMOCOALA run on the SFC dataset (22.6% for cospeciations, 0.4% for duplications, 54.3% for host switches and 22.8% for losses). It is also important to note that the number of vectors that are part of this cluster is high (14 out of 50 vectors accepted in the third round). Notice that Cluster 5 of COALA run on SFC_{Coala} is also close to these values, however this cluster is supported by only 2 of the accepted vectors. Moreover, all the representative vectors of the clusters output by AMOCOALA have a frequency of duplication close to 0, which is in agreement with what is expected from Refrégier *et al.* (2008).

Table 1: Representative vectors of the clusters produced by AMOCOALA (for the SFC dataset) and by COALA (for the SFC_{Coala} dataset). The column *#vectors* indicates the number of vectors in the cluster.

<i>Dataset</i>	<i>Cluster</i>	p_c	p_d	p_s	p_l	<i>#vectors</i>
SFC	1	0.531	0.004	0.282	0.183	19
	2	0.226	0.004	0.543	0.228	14
	3	0.898	0.020	0.040	0.042	12
	4	0.859	0.062	0.002	0.077	5
SFC _{Coala}	1	0.437	0.002	0.357	0.204	20
	2	0.417	0.274	0.003	0.306	19
	3	0.850	0.002	0.005	0.144	5
	4	0.005	0.418	0.003	0.575	4
	5	0.144	0.001	0.548	0.308	2

Overall the results obtained with AMOCOALA are closer to the result presented in Refrégier *et al.* (2008) than those that were obtained by COALA which ignores such multiple associations. This shows again the importance of taking into account the latter.

4 Concluding comments

In this paper, we propose a method, called AMOCOALA, which for a given pair of host and symbiont trees, estimates the probabilities of the cophylogeny events, in presence of spread events, relying on an approximate Bayesian computation (ABC) approach. In AMOCOALA, it is possible to estimate the probabilities of the classical cophylogeny events (cospeciation, duplication, host switch and loss) and also the probabilities of horizontal and vertical spreads. These two latter events allow to study datasets that contain multiple associations. The model uses set-labelled trees and to compare them we introduced a new distance, called MAS, which we believe can be of independent interest.

AMOCOALA on one hand provides more confidence in the set of costs to be used for the reconciliation of a given pair of host and symbiont trees, while on the other hand, it allows to estimate the probabilities of the events even in the case of large datasets. We evaluate our method on synthetic and real datasets.

This work leads to different research directions. First, it would be interesting to define better distances for set-labelled trees. To the best of our knowledge, these types of trees have not been considered in the literature and it would be interesting to generalise (if possible) some of the well-known phylogenetic distances to set-labelled trees. Another direction is to include the vertical and horizontal spreads in the parsimonious reconciliation framework. Thus, a perspective to this work is to design a reconciliation procedure that includes these switches.

5 Software and Supplementary Material

The software, datasets and Supplementary Material are available at <https://sites.google.com/view/blerinasinaimeri/software/amocoala>.

6 Disclosure statement

The authors state they have no conflicts of interest to declare.

References

- Alcala, N., T. Jenkins, P. Christe, and S. Vuilleumier. 2017. Host shift and cospeciation rate estimation from co-phylogenies. *Ecology Letters* 20:1014–1024.
- Althoff, D. M., K. A. Segraves, and M. T. J. Johnson. 2014. Testing for coevolutionary diversification: linking pattern with process. *Trends in Ecology & Evolution* 29:82 – 89.
- Banks, J. C. and A. M. Paterson. 2005. Multi-host parasite species in cophylogenetic studies. *International Journal for Parasitology* 35:741 – 746.
- Bansal, M. S., E. Alm, and M. Kellis. 2012. Efficient algorithms for the reconciliation problem with gene duplication, horizontal transfer and loss. *Bioinformatics* 28:i283–i291.
- Bansal, M. S., M. Kellis, M. Kordi, and S. Kundu. 2018. RANGER-DTL 2.0: rigorous reconstruction of gene-family evolution by duplication, transfer and loss. *Bioinformatics* 34:3214–3216.
- Baudet, C., B. Donati, B. Sinaimer, P. Crescenzi, C. Gautier, C. Matias, and M.-F. Sagot. 2015. Cophylogeny reconstruction via an Approximate Bayesian Computation. *Systematic Biology* 64:416–31.
- Becerra, J. X. 1997. Insects on plants: Macroevolutionary chemical trends in host use. *Science* 276:253–256.
- Braga, M. P., M. J. Landis, S. Nylin, N. Janz, and F. Ronquist. 2020. Bayesian inference of ancestral host-parasite interactions under a phylogenetic model of host repertoire evolution. *Systematic biology* 69:1149–1162.
- Brooks, D. R. and D. A. McLennan. 1991. *Phylogeny, Ecology, and Behavior: A Research Program in Comparative Biology*. University of Chicago press.
- Charleston, M. A. 2002. Biological Evolution and Statistical Physics vol. 585 of *Lecture Notes in Physics* chap. Principles of cophylogenetic maps, Pages 122–147. Springer Berlin Heidelberg.
- Charleston, M. A. 2003. Recent results in cophylogeny mapping. *Advances in Parasitology* 54:303–330.

- Conow, C., D. Fielder, Y. Ovadia, and R. Libeskind-Hadas. 2010. Jane: A new tool for the cophylogeny reconstruction problem. *Algorithms for Molecular Biology* 5:10 pages.
- Donati, B., C. Baudet, B. Sinaimer, P. Crescenzi, and M. Sagot. 2015. EUCALYPT: efficient tree reconciliation enumerator. *Algorithms for Molecular Biology* 10:3.
- Doyon, J.-P., S. Hamel, and C. Chauve. 2011. An efficient method for exploring the space of gene tree/species tree reconciliations in a probabilistic framework. *IEEE/ACM Transactions on Computational Biology and Bioinformatics* 9:26–39.
- Drinkwater, B., A. Qiao, and M. A. Charleston. 2016. WiSPA: A new approach for dealing with widespread parasitism. *ArXiv:1603.09415*.
- Ganapathy, G., B. Goodson, R. Jansen, H. Le, V. Ramachandran, and T. Warnow. 2006. Pattern identification in biogeography. *IEEE/ACM Trans. on Comput. Biol. Bioinf.* 3:334–346.
- Ganapathy, G., B. Goodson, R. Jansen, V. Ramachandran, and T. Warnow. 2005. Pattern Identification in Biogeography. Pages 116–127 in *Algorithms in Bioinformatics* (R. Casadio and G. Myers, eds.) vol. 3692 of *Lecture Notes in Computer Science* Springer Berlin Heidelberg.
- Gómez-Acevedo, S., L. Rico-Arce, A. Delgado-Salinas, S. Magallón, and L. E. Eguiarte. 2010. Neotropical mutualism between *Acacia* and *Pseudomyrmex*: Phylogeny and divergence times. *Molecular Phylogenetics and Evolution* 56:393–408.
- Hallett, M. T. and J. Lagergren. 2001. Efficient algorithms for lateral gene transfer problems. In Lengauer, T. (ed), *Proceedings of the fifth Annual International Conference on Research in Computational Molecular Biology (RECOMB)*, ACM (New York) Pages 149–156.
- Langfelder, P., B. Zhang, and S. Horvath. 2007. Defining clusters from a hierarchical cluster tree: the Dynamic Tree Cut package for R. *Bioinformatics* 24:719–720.
- Libeskind-Hadas, R. 2022. Tree reconciliation methods for host-symbiont cophylogenetic analyses. *Life* 12.
- Merkle, D. and M. Middendorf. 2005. Reconstruction of the cophylogenetic history of related phylogenetic trees with divergence timing information. *Theory in Biosciences* 123:277–299.
- Merkle, D., M. Middendorf, and N. Wieseke. 2010. A parameter-adaptive dynamic programming approach for inferring cophylogenies. *BMC Bioinformatics* 11:S60.
- Page, R. D. M. 1994. Parallel phylogenies: reconstructing the history of host-parasite assemblages. *Cladistics* 10:155–173.

- Refrégier, G., M. Le Gac, F. Jabbour, A. Widmer, J. A. Shykoff, R. Yockteng, M. E. Hood, and T. Giraud. 2008. Cophylogeny of the anther smut fungi and their caryophyllaceous hosts: Prevalence of host shifts and importance of delimiting parasite species for inferring cospeciation. *BMC Evolutionary Biology* 8:100.
- Ronquist, F. 2003. Tangled trees: phylogeny, cospeciation, and coevolution chap. Parsimony analysis of coevolving species associations, Pages 22–64. University of Chicago Press.
- Sanmartín, I. and F. Ronquist. 2002. New solutions to old problems: widespread taxa, redundant distributions and missing areas in event-based biogeography. *Animal Biodiversity and Conservation* 25.2:75–93.
- Silvieus, S. I., W. L. Clement, and G. D. Weiblen. 2008. Specialization, Speciation, and Radiation chap. Cophylogeny of figs, pollinators, gallers and parasitoids, Pages 225–237. University of California Press.
- Stolzer, M. L., H. Lai, M. Xu, D. Sathaye, B. Vernot, and D. Durand. 2012. Inferring duplications, losses, transfers and incomplete lineage sorting with nonbinary species trees. *Bioinformatics* 28:i409–i415.
- Szöllősi, G. J., W. Rosikiewicz, B. Boussau, E. Tannier, and V. Daubin. 2013. Efficient exploration of the space of reconciled gene trees. *Syst. Biol.* 62:901–912.
- Tofigh, A., M. T. Hallett, and J. Lagergren. 2011. Simultaneous identification of duplications and lateral gene transfers. *IEEE/ACM Trans. Comput. Biology Bioinform.* 8:517–535.

Supplementary Material for: Cophylogeny reconstruction allowing for multiple associations through approximate Bayesian computation

BLERINA SINAIMERI^{1,2,†}, LAURA URBINI^{2,†}, MARIE-FRANCE SAGOT² AND CATHERINE MATIAS³

¹ *LUISS University, Rome, Italy*

² *Inria Lyon, 56 Bd Niels Bohr, 69100 Villeurbanne, France, and Université de Lyon, F-69000, Lyon; Université Lyon 1; CNRS, UMR5558; 43 Boulevard du 11 Novembre 1918, 69622 Villeurbanne cedex, France*

³ *Sorbonne Université, Université de Paris Cité, Centre National de la Recherche Scientifique, Laboratoire de Probabilités, Statistique et Modélisation, Paris, France*

Corresponding author: Blerina Sinaimeri, LUISS University, Rome, Italy; E-mail: bsinaimeri@luiss.it.

Contents

A	The event-based model	28
A.1	Tree-related basic definitions	28
A.2	Reconciliation model from Tofigh et al.	28
A.3	Reconciliation model allowing for spreads	29
A.4	Pre-estimating probabilities for the spread events	31
B	AMOCOALA algorithm	33
B.1	Simulation algorithm in AMOCOALA	33
B.2	ABC-SMC inference method in AMOCOALA	35
B.3	Distance measure in AMOCOALA	36
B.4	A proof that dMAS is a distance	37
B.5	Polynomial time algorithm for computing the dMAS distance	38
C	Additional results for the self-test	39
D	Biological datasets	39
D.1	Results on biological datasets	39
D.2	Running times	40
D.3	Robustness analysis wrt the pre-estimated spread probabilities	40

[†]First co-authors.

A The event-based model

AMOCOALA relies on the event-based model presented in Charleston (2002); Tofigh *et al.* (2011). For the sake of completeness, we detail the model here. We first start with some basic definitions related to phylogenetic trees.

A.1 Tree-related basic definitions

A rooted phylogenetic tree is a leaf-labelled tree that models the evolution of a set of taxa from their most recent common ancestor (placed at the root). The internal vertices of the tree correspond to the speciation events. In a rooted phylogenetic tree, a direction is assumed from the root to the leaves that corresponds to the direction of evolutionary time. Specifically, a phylogenetic tree is a rooted tree with labelled leaves where the root has in-degree 0 and out-degree 2, the leaves have in-degree 1 and out-degree 0 and every internal vertex has in-degree 1 and out-degree 2. For such a tree T , the set of vertices is denoted by $V(T)$, the set of arcs by $A(T)$, and the set of leaves by $L(T)$. The cardinality of set A is denoted by $|A|$. The root of T is denoted by $r(T)$. For a vertex v in a tree T , we denote by T_v the subtree of T rooted in v (often referred to as a *clade*), and we write $L(v)$ for the set $L(T_v)$. For a vertex $v \in V(T)$, we denote by $Des(v)$ the set of *descendants* of v , *i.e.* the set of vertices in the subtree of T_v . Similarly, we denote by $Anc(v)$ the set of *ancestors* of v , that is the set of vertices in the unique path from $r(T)$ to v (including the end points). For a vertex $v \in V(T)$ different from the root, we call its *parent*, denoted by $par(v)$, the vertex x for which there is the arc $(x, v) \in A(T)$. We denote by $mrca(v, w)$ the most recent common ancestor of v and w in T . Finally, we denote by \leq the partial order induced by the ancestry relation in the tree. Formally, for $x, y \in V(T)$, we say that $x \leq y$ if $x \in Anc(y)$. If neither $x \in Anc(y)$ nor $y \in Anc(x)$, the vertices x and y are said to be *incomparable*.

For any tree T and any set of leaves t_1, \dots, t_n , we denote by $T_{\{t_1, \dots, t_n\}}$ the phylogenetic subtree of T induced by the leaves t_1, \dots, t_n and eventually suppressing the vertices of out-degree 1. When a vertex u with parent vertex v and child vertex w is suppressed, both vertex u and arcs $(v, u), (u, w)$ are removed and the arc (v, w) is added to the tree.

A.2 Reconciliation model from Tofigh et al.

In this section, we describe the classical reconciliation model, where 4 coevolutionary events are allowed, producing no multiple associations. Let H and S be respectively the rooted phylogenetic trees of the host and symbiont species, both binary and full (*i.e.* each internal vertex has exactly two children). Let ϕ be a function from $L(S)$ to $L(H)$, representing the symbiont/host associations between extant species. A reconciliation is a function λ that assigns, for each symbiont vertex $s \in V(S)$, a host vertex $\lambda(s) \in V(H)$, and satisfies the conditions stated in Definition 1.

In its classical form, a reconciliation associates to each vertex s in $V(S)$ an event $E(\lambda(s))$ among cospeciation (\mathbb{C}), duplication (\mathbb{D}) and host switch (\mathbb{S}).

Definition 1. Given two phylogenetic trees S and H , and a function $\phi : L(S) \rightarrow L(H)$, a reconciliation of (S, H, ϕ) is a function $\lambda : V(S) \rightarrow V(H)$ satisfying the following:

1. For every leaf vertex $s \in L(S)$, we have $\lambda(s) = \phi(s)$.
2. For every internal vertex $s \in V(S) \setminus L(S)$ with children s_1, s_2 , exactly one of the following applies:
 - (a) $E(\lambda(s)) = \mathbb{S}$, that is, either $\lambda(s_1)$ and $\lambda(s_2)$ are incomparable and $\lambda(s)$ is a descendant of $\lambda(s_1)$, or $\lambda(s_2)$ and $\lambda(s)$ are incomparable and $\lambda(s)$ is a descendant of $\lambda(s_2)$,
 - (b) $E(\lambda(s)) = \mathbb{C}$, that is, $\text{mrca}(\lambda(s_1), \lambda(s_2)) = \lambda(s)$, and $\lambda(s_1)$ and $\lambda(s_2)$ are incomparable,
 - (c) $E(\lambda(s)) = \mathbb{D}$, that is, $\lambda(s_1)$ and $\lambda(s_2)$ are both descendants of $\lambda(s)$, and the previous two cases do not apply.

The loss event is denoted by \mathbb{L} and is identified by a multiset (generalisation of a set where the elements are allowed to appear more than once) whose elements are in $V(H)$ containing all the vertices $h \in V(H)$ that are in the path between the image of a vertex $s \in V(S)$ and the image of one of its children. The images themselves are not included in the count, except for the duplication event, where one of the images is included.

The function λ partitions the set of internal symbiont tree vertices into three disjoint subsets according to the coevolutionary event occurring at that vertex. The number of occurrences of each of the three events and the number of losses make up the *event vector* of the reconciliation. The *event vector* of a reconciliation is a vector of integers consisting of the total number of each type of events \mathbb{C} , \mathbb{D} , \mathbb{S} , \mathbb{L} .

We say that a reconciliation is *time-feasible* if it does not violate the time-feasibility constraints. The exact criterion we use to assess time-feasibility is the one defined in Stolzer *et al.* (2012) and that was already in force in COALA.

A.3 Reconciliation model allowing for spreads

The introduction of spread events modifies the previous setting in the following way. Let again H and S be respectively the rooted phylogenetic trees of the host and symbiont species, both binary and full (*i.e.* every internal vertex has exactly two children). Now, let ϕ be a relation between $L(S)$ and $L(H)$, representing the symbiont/host associations between extant species. More precisely, let us denote $\mathcal{P}(L(H))$ the set of all subsets of $L(H)$. Then ϕ is now a function from $L(S)$ to $\mathcal{P}(L(H))$. For any extant symbiont species $s \in L(S)$, whenever the cardinality $|\phi(s)| \geq 2$ (*i.e.* whenever the

symbiont is associated to more than one host), we say that this symbiont has multiple associations and we count the total number of multiple associations in the dataset as:

$$\text{Nb of multiple associations} = \sum_{s \in L(S)} (|\phi(s)| - 1).$$

A reconciliation is now a function λ from $V(S)$ to $\mathcal{P}(V(H))$ that assigns, for each symbiont vertex $s \in V(S)$, a set of host vertices $\lambda(s) \subset V(H)$, and satisfies the conditions stated in Definition 2. A reconciliation now associates to each vertex s in $V(S)$ an event $E(\lambda(s))$ among cospeciation (\mathbb{C}), duplication (\mathbb{D}), host switch (\mathbb{S}), vertical spread (\mathbb{VS}) and horizontal spread (\mathbb{HS}).

Definition 2. *Given two phylogenetic trees S and H , and a function $\phi : L(S) \rightarrow \mathcal{P}(L(H))$, a reconciliation of (S, H, ϕ) is a function $\lambda : V(S) \rightarrow \mathcal{P}(V(H))$ satisfying the following:*

1. For every leaf vertex $s \in L(S)$, we have $\lambda(s) = \phi(s)$.
2. For every internal vertex $s \in V(S) \setminus L(S)$ with children s_1, s_2 , such that $\lambda(s)$ is a singleton, exactly one of the following applies:
 - (a) $E(\lambda(s)) = \mathbb{S}$, that is, either $\lambda(s)$ and one element of $\lambda(s_1)$ are incomparable and $\lambda(s_2)$ contains a descendant of $\lambda(s)$, or $\lambda(s)$ and one element of $\lambda(s_2)$ are incomparable and $\lambda(s_1)$ contains a descendant of $\lambda(s)$,
 - (b) $E(\lambda(s)) = \mathbb{C}$, that is, there is some $h_1 \in \lambda(s_1)$ (resp. $h_2 \in \lambda(s_2)$) such that $\text{mrca}(h_1, h_2) = \lambda(s)$, and h_1 and h_2 are incomparable,
 - (c) $E(\lambda(s)) = \mathbb{D}$, that is, there is some $h_1 \in \lambda(s_1)$ (resp. $h_2 \in \lambda(s_2)$) such that both h_1, h_2 are descendants of $\lambda(s)$, and the previous two cases do not apply.
3. For every internal vertex $s \in V(S) \setminus L(S)$ such that $\lambda(s)$ is not a singleton, exactly one of the following applies:
 - (a) $E(\lambda(s)) = \mathbb{VS}$, that is $\lambda(s)$ is a clade in H , and all the descendants s' of s are also associated to the same clade, i.e. $\lambda(s') = \lambda(s)$.
 - (b) $E(\lambda(s)) = \mathbb{HS}$, that is $\lambda(s)$ is the union of two clades in H whose respective roots are incomparable. Moreover, all the descendants s' of s are also associated to the same clades, i.e. $\lambda(s') = \lambda(s)$.
 - (c) s is the descendant of a node s' where a spread (either vertical or horizontal) occurred (cases (3a) and (3b)). Then $\lambda(s) = \lambda(s')$. In that case, no additional coevolutionary event is recorded at that vertex.

The loss event denoted by \mathbb{L} is identified by a multiset (generalisation of a set where the elements are allowed to appear more than once) whose elements are in $V(H)$ containing all the vertices $h \in V(H)$ that are in the path between the image of a vertex $s \in V(S)$ which is a singleton and the image of one of its children. Note that no other event and thus no losses can happen below spread events.

Now, the function λ partitions the set of internal symbiont tree vertices into five disjoint subsets according to the coevolutionary event occurring at that vertex, plus an additional subset of all internal symbiont vertices that descend from a vertex where a spread occurred. The number of occurrences of each of the five events and the number of losses make up the *event vector* of the reconciliation. The *event vector* of a reconciliation is a vector of integers consisting of the total number of each type of events \mathbb{C} , \mathbb{D} , \mathbb{S} , \mathbb{L} , \mathbb{VS} , \mathbb{HS} . Note that in the case of spread events (either vertical or horizontal) occurring at internal vertex $s \in V(S) \setminus L(S)$, the event is counted only once and the internal vertices s' descendants of s have no coevolutionary event associated to them.

The time feasibility condition is unchanged when adding spreads in the list of coevolutionary events.

A.4 Pre-estimating probabilities for the spread events

Given an input dataset (H, S, ϕ) , we rely on frequency estimators for the spread probabilities that will be used in our algorithm. Note that the ‘‘classical events’’ (cospeciation, duplication, host switch and loss) have the same probability to occur everywhere in the tree, while the probability of a vertical or horizontal spread is specific to each vertex of the host tree. These probabilities are pre-estimated based on the input (H, S, ϕ) as described below rather than in the full ABC procedure. They are estimated through heuristic frequencies observed in the associations of the two trees. In Section D.3, we explore the robustness of our results with respect to these pre-computed estimators.

Probability that a vertical spread occurs at host h . A probability $p_{\text{vs}}(h)$ is associated to a vertical spread event at host h as follows. If $h \in L(H)$, then $p_{\text{vs}}(h)$ is estimated to 1. Otherwise, for any internal vertex h of the host tree H , the probability $p_{\text{vs}}(h)$ is estimated to

$$p_{\text{vs}}(h) = \left(\frac{1}{|S^{L(h)}|} \right) \frac{\sum_{s \in S^{L(h)}} |\phi(s) \cap L(h)| - 1}{|L(h)| - 1} \quad (\text{S.1})$$

where $L(h)$ is the set of leaves in H_h (the subtree of H rooted in h), $S^{L(h)}$ is the set of leaves in the symbiont tree S that are associated with at least one leaf of H_h (formally $S^{L(h)} = \{s \in L(S) : \phi(s) \cap L(h) \neq \emptyset\}$), and $|\phi(s) \cap L(h)|$ is the number of host leaves in H_h associated with a symbiont s .

Intuitively, the probability $p_{\text{vs}}(h)$ is large whenever a large proportion of the symbionts in $S^{L(h)}$ are associated to a large proportion of the hosts $L(h)$ (*i.e.* most of the symbionts are generalists) and is low when most of those symbionts are associated only with a few hosts of $L(h)$ (*i.e.* most of the symbionts are specialists). Notice that for a host h that is high in the tree, *i.e.* that is near to the root of H , the set $L(h)$ is large. Thus, a vertical spread to occur at h with high probability requires that some symbiont leaves are associated to an unrealistically large set of hosts $L(h)$. Hence usually the

probability of a vertical spread is lower in hosts that are high in the tree. As explained in the next paragraph, the same holds for the horizontal spread event.

Probability that a symbiont present in h invades an incomparable host h' . For two incomparable vertices h and h' , a probability $p_{\text{jump}}(h \rightarrow h')$ is estimated as follows

$$p_{\text{jump}}(h \rightarrow h') = \frac{|S^{L(h)} \cap S^{L(h')}|}{|S^{L(h)} \cup S^{L(h')}|}. \quad (\text{S.2})$$

The notion of “jump” does not refer to a coevolutionary event and should not be confused with a host switch. The jump probability is specific to each pair of vertices of the host tree. It is a symmetric quantity, *i.e.* $p_{\text{jump}}(h \rightarrow h') = p_{\text{jump}}(h' \rightarrow h)$. It is high whenever the leaves of the subtrees H_h and $H_{h'}$ share a large proportion of associated symbionts. In particular, it is zero when they do not share any associated symbiont, and 1 when they have exactly the same set of associated symbionts.

Probability that a horizontal spread occurs at host h . From the probabilities $p_{\text{jump}}(h \rightarrow h')$, we estimate a probability of horizontal spread at each vertex h . The associated probability depends on all the vertices h' that are incomparable with h . Indeed, such vertices are all those that may be reached from h through a horizontal spread event. In fact, a horizontal spread corresponds to a jump combined with two vertical spreads. We thus associate a probability of horizontal spread $p_{\text{hs}}(h)$ to each vertex h of the host tree that takes into account both a jump and two vertical spreads and is set as

$$p_{\text{hs}}(h) = \min\{1, p^*(h)\}, \quad (\text{S.3})$$

where

$$p^*(h) = p_{\text{vs}}(h) \sum_{\substack{h' \in V(H) \\ h, h' \text{ incomparable}}} p_{\text{vs}}(h') p_{\text{jump}}(h \rightarrow h').$$

The probability of a horizontal spread $p_{\text{hs}}(h)$ is high whenever $p_{\text{vs}}(h)$ is high and there exist vertices h' incomparable to h with large $p_{\text{vs}}(h')$ and large value $p_{\text{jump}}(h \rightarrow h')$ (so that the leaves below h and h' share many symbionts). Observe that $p^*(h)$ is not a probability but a positive value, that in particular may be larger than 1.

Probability for sampling a horizontal spread to some specific host h' . In the simulation process, once a horizontal spread is sampled for symbiont s at vertex h , we need to choose an incomparable vertex h' where the symbiont s has to jump to. In this case, we need to guarantee that the jump satisfies the time-feasibility constraints as given in Stolzer *et al.* (2012) and Baudet *et al.* (2015). This constraint depends on the symbionts mapped so far (see Section *Simulation algorithm in AMOCOALA* below). For a current partial mapping λ from the vertices of S to the subsets of vertices of H , the probability $p_{\text{invasion}}(h \rightarrow h', \lambda)$ of a vertex h' to be invaded by a symbiont s mapped

in h is estimated as

$$\begin{aligned} p_{\text{invasion}}(h \rightarrow h', \lambda) &= \frac{p_{\text{jump}}(h \rightarrow h') 1\{E_{h,h',\lambda}\} p_{\text{vs}}(h) p_{\text{vs}}(h')}{p_{\text{vs}}(h) \sum_{h''} p_{\text{vs}}(h'') p_{\text{jump}}(h \rightarrow h'') 1\{E_{h,h'',\lambda}\}}, \\ &= \frac{p_{\text{jump}}(h \rightarrow h') 1\{E_{h,h',\lambda}\} p_{\text{vs}}(h')}{\sum_{h''} p_{\text{vs}}(h'') p_{\text{jump}}(h \rightarrow h'') 1\{E_{h,h'',\lambda}\}}, \end{aligned} \quad (\text{S.4})$$

where $1\{E_{h,h',\lambda}\} = 1$ whenever the horizontal spread of the symbiont mapped in h to the new host h' induces a time feasible reconciliation, and the sum in the denominator is restricted to the vertices h'' that are incomparable to h . If no vertex induces a time feasible reconciliation (namely $p_{\text{invasion}}(h \rightarrow h', \lambda) = 0$ for any h' incomparable to h), the horizontal spread is not applied and another event is sampled. Otherwise, as the probabilities $p_{\text{invasion}}(h \rightarrow h', \lambda)$ sum up to one, a vertex h' is necessarily chosen.

Computing the pre-estimated spread probabilities. The estimated spread probabilities are calculated at the beginning of the algorithm. These values depend only on the host tree H , the symbiont tree S and the associations between the leaves ϕ . In a first step, we start by setting to 1 the probabilities p_{vs} for the leaves. Then, for the internal vertices h , these probabilities are computed as in Equation (S.1). In a second step, the probabilities of a jump are calculated for each pair of incomparable vertices h and h' as in Equation (S.2). In the last step, the probabilities of a horizontal spread for vertex h are computed as in Equation (S.3). Observe that the probabilities of invasion (Equation (S.4)) depend on the current simulation. Indeed, one has to take into account the time-feasibility in order to choose the target h' of a horizontal spread. Therefore, it may happen that the invasion $p_{\text{invasion}}(h \rightarrow h', \lambda) > 0$ for the current partial mapping λ but after some steps $p_{\text{invasion}}(h \rightarrow h', \lambda') = 0$ for the new mapping λ' . These probabilities are then updated, during the simulation algorithm, each time a horizontal spread is selected.

B AMOCOALA algorithm

B.1 Simulation algorithm in AMOCOALA

The simulation of a symbiont tree \tilde{S} together with its reconciliation $\tilde{\lambda}$ starts with the creation of its root vertex \tilde{s}_{root} . This vertex is positioned before the root of H on the arc $a = (\rho, H_{\text{root}})$. We add the arc (ρ, H_{root}) to allow the simulation of events that happened in the symbiont tree before the most recent common ancestor of all host species in H . Figure 4 in main text depicts this starting configuration.

For any vertex \tilde{s} of \tilde{S} that is not yet mapped and whose position is $\langle \tilde{s} : a \rangle$ (see Figure 4 in main text), AMOCOALA successively considers the six allowed operations, and chooses one depending on the probability of each event (once an event is picked, the others are not considered). In what follows, we denote by a_1, a_2 the arcs outgoing from the head $h(a)$ of the arc a .

- I. If $h(a)$ is a leaf, we *STOP* the evolution of \tilde{s} .

- II. We first sample a horizontal spread according to the probability $p_{\text{hs}}(h(a))$. When a horizontal spread occurs (Figure 5 in main text), we apply the mapping $\tilde{\lambda}(\tilde{s}) = H_{h(a)} \cup H_{h(a')}$. The choice of the incomparable vertex $h(a')$ varies in order to preserve time feasibility (Stolzer *et al.*, 2012; Baudet *et al.*, 2015), thus the probabilities described in Equation (S.4) are updated according to the new set of incomparable vertices. If there is no incomparable vertex, it is not possible for a horizontal spread to occur and we go to Step III. To select the ghost subtree rooted in \tilde{s} , we mimic the real symbiont tree as shown in Figure 5 in main text.
- III. If a horizontal spread did not occur, we sample a vertical spread according to the probability $p_{\text{vs}}(h(a))$. When a vertical spread occurs (Figure 6 in main text), we apply the mapping $\tilde{\lambda}(\tilde{s}) = H_{h(a)}$. To select the ghost subtree rooted in \tilde{s} , we mimic the real symbiont tree as shown in Figure 6 from main text.
- In both cases of vertical and horizontal spreads, the evolution of \tilde{s} stops after the creation of the ghost subtree and its descendants are not processed anymore.
- IV. If a spread was not sampled, then we sample with a multinomial distribution a classical event according to the probabilities $\theta = \langle p_c, p_d, p_s, p_l \rangle$. Notice that $p_c + p_d + p_s + p_l = 1$ so that one of the four events is selected. This case is handled identically as in COALA and the symbiont is associated to a single host. We briefly recall the procedure below.

- Cospeciation (Figure 7(b) in main text): We apply the mapping $\tilde{\lambda}(\tilde{s}) = \{h(a)\}$ and we create the vertices \tilde{s}_1 and \tilde{s}_2 as children of \tilde{s} . We position them as follows: $\langle \tilde{s}_1 : a_1 \rangle$ and $\langle \tilde{s}_2 : a_2 \rangle$. This operation is executed with probability p_c .
- Duplication (Figure 7(c) in main text): We apply the mapping $\tilde{\lambda}(\tilde{s}) = \{h(a)\}$ and we create the vertices \tilde{s}_1 and \tilde{s}_2 as children of \tilde{s} . Both \tilde{s}_1 and \tilde{s}_2 are positioned on a . This operation is executed with probability p_d .
- Host switch (Figure 7(e) in main text): We apply the mapping $\tilde{\lambda}(\tilde{s}) = \{h(a)\}$ and we create the vertices \tilde{s}_1 and \tilde{s}_2 as children of \tilde{s} . We then randomly choose one of the two children and position it on a . Finally, we randomly choose an arc a' that does not violate the time feasibility of the reconstruction so far (Stolzer *et al.*, 2012; Baudet *et al.*, 2015). If such an arc does not exist, it is not possible for a host switch to take place. In this case, we choose between the three remaining events with probability $p_i/(p_c + p_d + p_l)$ with $i \in \{c, d, l\}$. Otherwise, we position \tilde{s}_2 on a' . This operation is executed with probability p_s .
- Loss (Figure 7(e) in main text): This operation consists of randomly choosing an arc outgoing from the head $h(a)$ of a and positioning \tilde{s} on it. This operation is executed with probability p_l .

In any of these four cases, the simulation process recursively continues with the new vertices created (back to Step I).

Note that in our modelling, losses never occur after a spread event. Indeed, in the case of a vertical spread, a symbiont and its entire clade are associated to one host clade, while in the case of a horizontal spread, they are then associated to two host clades. This might appear unrealistic. However, this choice is made for computational reasons. Indeed, as mentioned in the Main Manuscript, there is no simple way of simulating the symbiont tree below a symbiont where a spread occurs.

B.2 ABC-SMC inference method in AMOCOALA

AMOCOALA is based on the same ABC-SMC method as the one developed in COALA (Baudet *et al.*, 2015). For the sake of completeness, we now recall the procedure.

The ABC-SMC procedure is composed of a sequence of $R > 1$ rounds. At each round, parameter vectors θ are sampled in a specific way, symbiont trees \tilde{S}_θ are generated under the reconciliation model allowing for spreads with parameter values given by θ (and relying on the simulation algorithm described in the previous section). Then, these symbiont trees are compared to the original dataset through a summary distance d whose details are given in the next section. The parameters with the smallest discrepancies are selected.

For each of these rounds, we define a tolerance value τ_r ($1 \leq r \leq R$) which determines the percentage of parameter vectors to be accepted. Associated with a tolerance value τ_r , we have a threshold ϵ_r which is the largest value of the summary distance associated with the accepted parameter vectors.

- Initial round ($r = 1$):
 - Draw an initial set of N parameter vectors $\{\theta_1^i\}_{(1 \leq i \leq N)}$ from the prior π .
 - Then, for each θ_1^i , simulate M trees $\{\tilde{S}_j(\theta_1^i)\}_{(1 \leq j \leq M)}$. Compute the corresponding discrepancies $\{d_j(\theta_1^i)\}_{(1 \leq j \leq M)}$ and summarise them into the summary discrepancy $d_{\theta_1^i}$ through the mean value.
 - Select $Q_1 = \tau_1 \times N$ parameter vectors θ_1 that have the smallest value d_{θ_1} , thus defining the threshold ϵ_1 and the set A_1 of accepted parameter vectors.
- Following rounds ($2 \leq r \leq R$):
 1. Sample a parameter vector θ^* from the set $A_{(r-1)}$.
 2. Create a parameter vector θ^{**} by perturbing θ^* (through a kernel proposal).
 3. Simulate M trees relying on the parameter value θ^{**} and compute $d_{\theta^{**}}$. If $d_{\theta^{**}} \leq \epsilon_{(r-1)}$, add θ^{**} into the quantile set \mathcal{Q}_r . If $|\mathcal{Q}_r| < Q_{r-1}$, return to Step 1.
 4. Based on the set \mathcal{Q}_r , select $Q_r = \tau_r \times Q$ parameter vectors θ_r that have the smallest d_{θ_r} , thus defining the threshold ϵ_r and the set A_r of accepted parameters.

Prior distribution. We sample from a uniform distribution on the simplex $\mathcal{S}_3 = \{(p_1, p_2, p_3, p_4); p_i \geq 0 \text{ and } \sum_i p_i = 1\}$ (we recall that $p_c + p_d + p_s + p_l = 1$).

Kernel proposal. We add to each coordinate of θ a randomly chosen value in $[-0.01, +0.01]$ and normalise the result. The final set of accepted parameter vectors is the result of the ABC-SMC procedure and characterises the list of vectors that may explain the evolution of the pair of host and symbiont trees given as input. Observe that, since in all experiments a uniform prior distribution is assumed and also the perturbations are performed in a uniform way, the weights induced by the proposals will also appear to be uniform (Beaumont *et al.*, 2009). However, in the case of a different prior, weights should be used in the process in order to correct the posterior distribution according to the perturbation made.

Clustering of the vectors. The final list of accepted vectors are clustered using a hierarchical clustering procedure implemented in COALA (Baudet *et al.*, 2015). As final result, we therefore obtain a list of clusters to each one of which a representative vector is associated.

B.3 Distance measure in AMOCOALA

The discrepancy between the simulated and the original datasets is measured through a distance between set-labelled phylogenetic trees which can be calculated in polynomial time. Similarly as in COALA, this distance contains two components: (i) d_1 , that describes how much the simulated tree \tilde{S}_θ is representative of the vector θ , and (ii) d_2 that measures how much is \tilde{S}_θ (and its labels) topologically similar to S (and its labels).

Let us recall the definition of this first component. For a given vector $\theta = \langle p_c, p_d, p_s, p_l \rangle$ and for each simulated tree \tilde{S}_θ that was simulated according to this vector, we keep track of the vector of the number of classical cophylogeny events $\langle o_c, o_d, o_s, o_l \rangle$ associated to this simulation. We compute the corresponding expected vector $\langle e_c, e_d, e_s, e_l \rangle$ as follows

$$\forall i \in \{c, d, s, l\}, \quad e_i = |S| \times \theta_i = |S| \times p_i,$$

where $|S|$ is the size of the symbiont tree, *i.e.* its number of internal leaves. Then by comparing the observed and expected vectors, we define a measure $d_1(S, \tilde{S}_\theta)$ as follows:

$$d_1(S, \tilde{S}_\theta) = \frac{1}{4} \times \sum_{i \in \{c, d, s, l\}} \frac{|e_i - o_i|}{\max\{e_i, o_i\}}.$$

Note that we did not consider the number of observed spread events, which does not depend on the choice of θ as the corresponding probabilities are pre-estimated before applying the ABC-SMC approach.

As concerns point (ii), we extend the well-known *maximum agreement subtree* (MAST) distance (Finden and Gordon, 1985; Farach-Colton *et al.*, 1995) to handle set-labelled trees. This part is the novelty with respect to the proposal in COALA and

details were given in the Main Manuscript. We establish in the next sections that d_{MAS} is a distance and that it can be computed in polynomial time.

We use a normalised version of d_{MAS} and define the distance d_2 (see Main Manuscript). The two components are then combined to form the following distance

$$d_\theta = \alpha_1 d_1(S, \tilde{S}_\theta) + \alpha_2 d_2(S, \tilde{S}_\theta).$$

According to our experiments and also the ones presented in COALA, the most appropriate values are $\alpha_1 = 0.7$ and $\alpha_2 = 0.3$.

B.4 A proof that dMAS is a distance

We show that the distance d_{MAS} is a metric. For this, we check that d_{MAS} satisfies the following properties:

1. $d_{MAS}(T_1, T_2) \geq 0$ for all T_1, T_2 : this is trivial.
2. $d_{MAS}(T_1, T_2) = 0$ if and only if $T_1 = T_2$. Clearly if $T_1 = T_2$ then $d_{MAS}(T_1, T_2) = 0$. Otherwise, let $d_{MAS}(T_1, T_2) = 0$. Then $\max\{w(T_1), w(T_2)\} = MAS(T_1, T_2)$. The proof follows by observing that if T^* is a subtree of T such that $w(T^*) = w(T)$ then $T^* = T$.
3. $d_{MAS}(T_1, T_2) = d_{MAS}(T_2, T_1)$: this is trivial.
4. For any triplet of trees T_1, T_2, T_3 , it holds that $d_{MAS}(T_1, T_2) + d_{MAS}(T_2, T_3) \geq d_{MAS}(T_1, T_3)$. For simplicity, we set $w_i = w(T_i)$ and $w_{i,j} = w(MAS(T_i, T_j))$. Hence $d_{MAS}(T_i, T_j) = \max\{w_i, w_j\} - w_{i,j}$. Furthermore, we denote by $w_{1,2,3}$ the weight of the maximum agreement subtree that is common to the three trees T_1, T_2, T_3 . We then have:

$$\begin{aligned} & d_{MAS}(T_1, T_2) + d_{MAS}(T_2, T_3) \\ &= \max\{w_1, w_2\} - w_{1,2} + \max\{w_2, w_3\} - w_{2,3} \\ &= \max\{w_1, w_2\} + \max\{w_2, w_3\} - (w_{1,2} + w_{2,3} - w_{1,2,3} + w_{1,2,3}) \\ &\geq \max\{w_1, w_2, w_3\} + w_2 - (w_2 + w_{1,2,3}) \\ &\geq \max\{w_1, w_3\} - w_{1,3}, \end{aligned}$$

where for the first inequality, we use the fact that $\max\{w_1, w_2\} + \max\{w_2, w_3\} \geq \max\{w_1, w_2, w_3\} + w_2$ and we show in the next Lemma that $w_{1,2} + w_{2,3} - w_{1,2,3}$ is at most w_2 . The last inequality uses $w_{1,2,3} \leq w_{1,3}$.

This concludes the proof.

Lemma. *For any three set-labelled trees T_1, T_2, T_3 (using the notation from the above proof) it holds that $w_{1,2} + w_{2,3} - w_{1,2,3} \leq w_2$.*

Proof. Let $T_{1,2}$ and $T_{2,3}$ be the MAS of T_1, T_2 and T_2, T_3 , respectively. Consider any pair of leaf, label that belongs to T_2 , i.e. $(l, lab) \in T_2$. There are only four possibilities: (i) $(l, lab) \in T_{1,2}$ and $(l, lab) \notin T_{2,3}$ (we call these leaves of type A), (ii) $(l, lab) \notin T_{1,2}$ and $(l, lab) \in T_{2,3}$ (we call these leaves of type B), (iii) $(l, lab) \in T_{1,2}$ and $(l, lab) \in T_{2,3}$ (we call these leaves of type C), (iv) $(l, lab) \notin T_{1,2}$ and $(l, lab) \notin T_{2,3}$ (we call these leaves of type D). Then we have

$$\begin{aligned} w_2 &= |A| + |B| + |C| + |D| \\ &= w_{12} - |C| + w_{23} - |C| + |C| + |D| \\ &= w_{12} + w_{23} - |C| + |D|. \end{aligned}$$

Or equivalently

$$w_{12} + w_{23} = w_2 + |C| - |D|. \quad (\text{S.5})$$

Moreover, we define the tree \tilde{T} as the subtree obtained from T_2 by taking all the pairs of leaf, label that belong to T_{12} and T_{23} . Notice that \tilde{T} is also a subtree of T_1 and of T_3 . Thus, \tilde{T} is included in T_{123} . This implies that $|C| \leq w_{123}$. Going back to (S.5), we thus obtain

$$\begin{aligned} w_{12} + w_{23} &= w_2 + |C| - |D| \\ &\leq w_2 + |C| \\ &\leq w_2 + w_{123}. \end{aligned}$$

This concludes the proof of the lemma. \square

Remark. *The previous proof and comments show that the MAS distance d_{MAS} is very similar to the MAAC one (Ganapathy et al., 2005) for multi-labelled trees. Thus, it is natural to ask whether comparing two set-labelled trees can be reduced to comparing two multi-labelled trees. One idea is to transform a set-labelled tree into a multi-labelled tree. However, the straightforward transformation seems not to work well for our purpose. For instance, we can transform each set-labelled tree into a multi-labelled tree by substituting each set-labelled leaf by a subtree with a fixed topology (say a complete binary tree, or a multifurcating vertex) as in Figure S.1. However, in these cases the two trees in Figure S.1 would be considered equivalent, but in our context they are different. In fact, the set-labelled tree in Figure S.1(a) indicates that there is a symbiont that infects 4 different hosts h_1, h_2, h_3, h_4 , while in Figure S.1(b), we will have 4 different symbionts infecting each a different host.*

B.5 Polynomial time algorithm for computing the dMAS distance

We show that it is possible to calculate the distance $d_{MAS}(T_1, T_2)$ in polynomial time with respect to the size of the trees. This boils down to computing the weight of the maximum agreement subtree $w(MAS(T_1, T_2))$ in polynomial time. The algorithm is based on dynamic programming and extends quite straightforwardly the algorithm for

calculating the MAAC distance (Ganapathy *et al.*, 2005). We abbreviate to $w(v_1, v_2)$ the weight of the maximum agreement subtree between the two trees T_1 and T_2 rooted in v_1 and v_2 , respectively. For a leaf v , we denote by $l(v)$ the set of labels associated with it. Finally, for an internal vertex v , we denote by $ch_1(v)$ and $ch_2(v)$ the two children of v .

The dynamic programming algorithm starts from the leaves and ends in the roots of T_1 and T_2 following a recursion. We have that $w(v_1, v_2)$ is given by:

- If v_1 and v_2 are both leaves then $w(v_1, v_2) = |l(v_1) \cup l(v_2)|$
- If v_1 or v_2 (could be both) are internal vertices, $w(v_1, v_2)$ is the maximum value among the following three quantities
 1. $\max\{w(ch_1(v_1), v_2), w(ch_2(v_1), v_2)\}$;
 2. $\max\{w(v_1, ch_1(v_2)), w(v_1, ch_2(v_2))\}$;
 3. $\max\{w(ch_1(v_1), ch_1(v_2)) + w(ch_2(v_1), ch_2(v_2)), w(ch_1(v_1), ch_2(v_2)) + w(ch_2(v_1), ch_1(v_2))\}$.

C Additional results for the self-test

The results for parameter values θ_2 to θ_8 are presented in Figures S.2a to S.3d.

D Biological datasets

We provide here a description of the 4 datasets used. The corresponding phylogenetic trees are shown in Figures S.4 - S.7.

Dataset 1: AP - Acacia & Pseudomyrmex. This dataset was extracted from Gómez-Acevedo *et al.* (2010) and displays the interaction between *Acacia* plants and *Pseudomyrmex* species of ants. The host and symbiont trees include 9 and 7 leaves, respectively. The dataset has 22 multiple-associations.

Dataset 2: MP - Myrmica & Phengaris. This dataset was extracted from Jansen *et al.* (2011) and is composed of a pair of host and symbiont trees which have each 8 leaves. The dataset has 8 multiple-associations.

Dataset 3: SBL - Seabirds & Lice. This dataset was extracted from Paterson *et al.* (1997). The host and symbiont trees include 15 and 8 leaves, respectively. The dataset has 15 multiple-associations.

Dataset 4: SFC - Smut Fungi & Caryophyllaceus plants. This dataset was extracted from Refrégier *et al.* (2008). The host and symbiont trees include 15 and 16 leaves, respectively. The dataset has 4 multiple-associations.

D.1 Results on biological datasets

We ran AMOCOALA on all the real datasets and plotted in Figures S.8 to S.19 the histograms of the summary discrepancies and event probabilities (except for the

spread probabilities which are not inferred) obtained at the end of each one of the 3 rounds, for each of the 4 datasets. We see on the histograms that the summary discrepancies for the accepted parameter vectors decrease after each round. We recall that the summary discrepancy measures the similarity between the simulated trees and the original symbiont tree, and hence is related to the quality of the vectors. Thus, our result shows that the set of accepted vectors is refined at each round, leading to vectors which can generate trees that are increasingly more similar to the original symbiont tree (and its host associations).

D.2 Running times

Table S.1 shows the running times obtained on the 4 biological datasets, together with their sizes (as expressed by the number of leaves in the host and symbiont trees) and the number of multiple associations. The results have been obtained on a computer with a AMD EPYC 7542 32-Core processor and 128 CPU (2 sockets of 32 double threads cores) and 675Gb RAM. We used just one core ('nthreads 1', though AMOCOALA has a parallelized version) and AMOCOALA was run with default values on these datasets.

Dataset	(Host,Symbiont) leaves	Multiple associations	Running time
AP	(9,7)	22	23m20.859s
MP	(8,8)	8	21m25.631s
SBL	(15,8)	15	28m53.597s
SFC	(15,16)	4	117m45.919s

Table S.1: For each of the 4 biological datasets, we indicate the pairs of numbers of host and symbiont trees leaves (2nd column), the number of multiple associations (3rd column) and the running time of AMOCOALA on this dataset (4th column).

D.3 Robustness analysis wrt the pre-estimated spread probabilities

In this section, we explore the robustness of our results with respect to the pre-estimated values of the spread events probabilities. On each of the 4 biological datasets, we ran AMOCOALA with perturbed values of $p_{hs}(h), p_{vs}(h)$. More precisely, to each non zero probability $p_{hs}(h)$ or $p_{vs}(h)$, we added a noise value uniformly drawn in $[-0.1; 0.1]$ (and then took the infimum with 1 and the supremum with 0, in order to ensure the modified probabilities remain in $[0, 1]$). With these perturbed values, we ran AMOCOALA and output (after 3 rounds) 50 accepted vectors $\theta = \langle p_c, p_d, p_s, p_l \rangle$. The results are presented in Figures S.20 to S.23. Let us recall that AMOCOALA is a stochastic algorithm and any two runs will give similar but not identical results. The results obtained adding these perturbations are qualitatively the same for the first

3 datasets (namely AP, MP and SBL) as the ones without perturbations (see Figures S.10 to S.16). The results for dataset SFC show more variability wrt those of the unperturbed version (Figure S.19). Thus we also looked at the clusters output by AMOCOALA in this case in Table S.2. We recall that in Refrégier *et al.* (2008), the different analyses performed indicated that the most plausible reconciliations presented for the SFC dataset have from 0 to 3 cospeciations, no duplication, 12 to 15 host switches and 0 to 2 losses. Here we find that the first main cluster (31 vectors out of 50) has a representative vector with around 50% of cospeciations (about 7 or 8 events), almost no duplication (about 0 or 1 event), 31% of host switches (about 4 or 5 events) and 18% of losses (about 2 or 3 losses). The second main cluster has a higher probability of cospeciation and less switches. Only the third cluster could correspond to Refrégier *et al.* (2008)'s scenario, with 1 or 2 cospeciations, no duplication, 8 or 9 host switches and 4 to 5 losses; though it is supported by only 3 selected vectors out of 50. Thus for the SFC dataset, the detection of the biological scenario presented in Refrégier *et al.* (2008) is more difficult to detect with perturbed values of the spread probabilities. To conclude, our results are overall robust with respect to potential errors in the estimation of the spread events probabilities.

References for Supplementary Material

- Baudet, C., Donati, B., Sinimeri, B., Crescenzi, P., Gautier, C., Matias, C., and Sagot, M.-F. 2015. Cophylogeny reconstruction via an Approximate Bayesian Computation. *Systematic Biology*, 64(3): 416–31.
- Beaumont, M. A., Cornuet, J.-M., Marin, J.-M., and Robert, C. P. 2009. Adaptive approximate Bayesian computation. *Biometrika*, 96: 983–990.
- Charleston, M. A. 2002. *Biological Evolution and Statistical Physics*, volume 585 of *Lecture Notes in Physics*, chapter Principles of cophylogenetic maps, pages 122–147. Springer Berlin Heidelberg.
- Farach-Colton, M., Przytycka, T. M., and Thorup, M. 1995. On the agreement of many trees. *Inform. Process. Lett.*, 55: 297–301.
- Finden, C. R. and Gordon, A. D. 1985. Obtaining common pruned trees. *J. Classif.*, 2: 255–276.
- Ganapathy, G., Goodson, B., Jansen, R., Ramachandran, V., and Warnow, T. 2005. Pattern Identification in Biogeography. In R. Casadio and G. Myers, editors, *Algorithms in Bioinformatics*, volume 3692 of *Lecture Notes in Computer Science*, pages 116–127. Springer Berlin Heidelberg.
- Gómez-Acevedo, S., Rico-Arce, L., Delgado-Salinas, A., Magallón, S., and Eguiarte, L. E. 2010. Neotropical mutualism between *Acacia* and *Pseudomyrmex*: Phylogeny and divergence times. *Molecular Phylogenetics and Evolution*, 56(1): 393–408.

- Jansen, G., Vepsäläinen, K., and Savolainen, R. 2011. A phylogenetic test of the parasite-host associations between *Maculinea* butterflies (Lepidoptera: Lycaenidae) and *Myrmica* ants (Hymenoptera: Formicidae). *European Journal of Entomology*, 108(1): 53–62.
- Paterson, A., Gray, R. D., Clayton, D. H., and Moore, J. 1997. Host-parasite co-speciation, host switching, and missing the boat. In D. H. Clayton and J. Moore, editors, *Host-parasite evolution: General principles and avian models*, pages 236–250. Oxford University Press.
- Refrégier, G., Le Gac, M., Jabbour, F., Widmer, A., Shykoff, J. A., Yockteng, R., Hood, M. E., and Giraud, T. 2008. Cophylogeny of the anther smut fungi and their Caryophyllaceae hosts: Prevalence of host shifts and importance of delimiting parasite species for inferring cospeciation. *BMC Evolutionary Biology*, 8(1): 100.
- Stolzer, M. L., Lai, H., Xu, M., Sathaye, D., Vernet, B., and Durand, D. 2012. Inferring duplications, losses, transfers and incomplete lineage sorting with nonbinary species trees. *Bioinformatics*, 28(18): i409–i415.
- Tofigh, A., Hallett, M. T., and Lagergren, J. 2011. Simultaneous identification of duplications and lateral gene transfers. *IEEE/ACM Trans. Comput. Biology Bioinform.*, 8(2): 517–535.

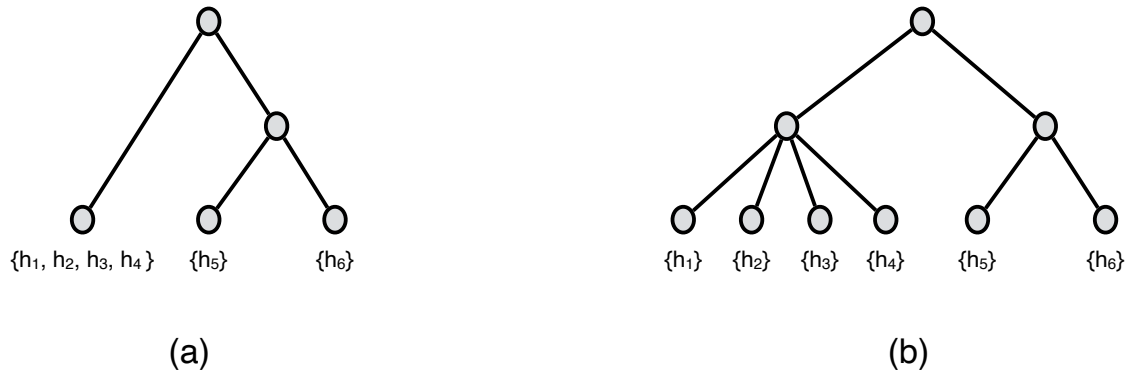


Figure S.1: The two phylogenetic trees will be considered at distance 0 if we substitute the vertex labelled by the set h_1, h_2, h_3, h_4 by a multifurcated vertex.

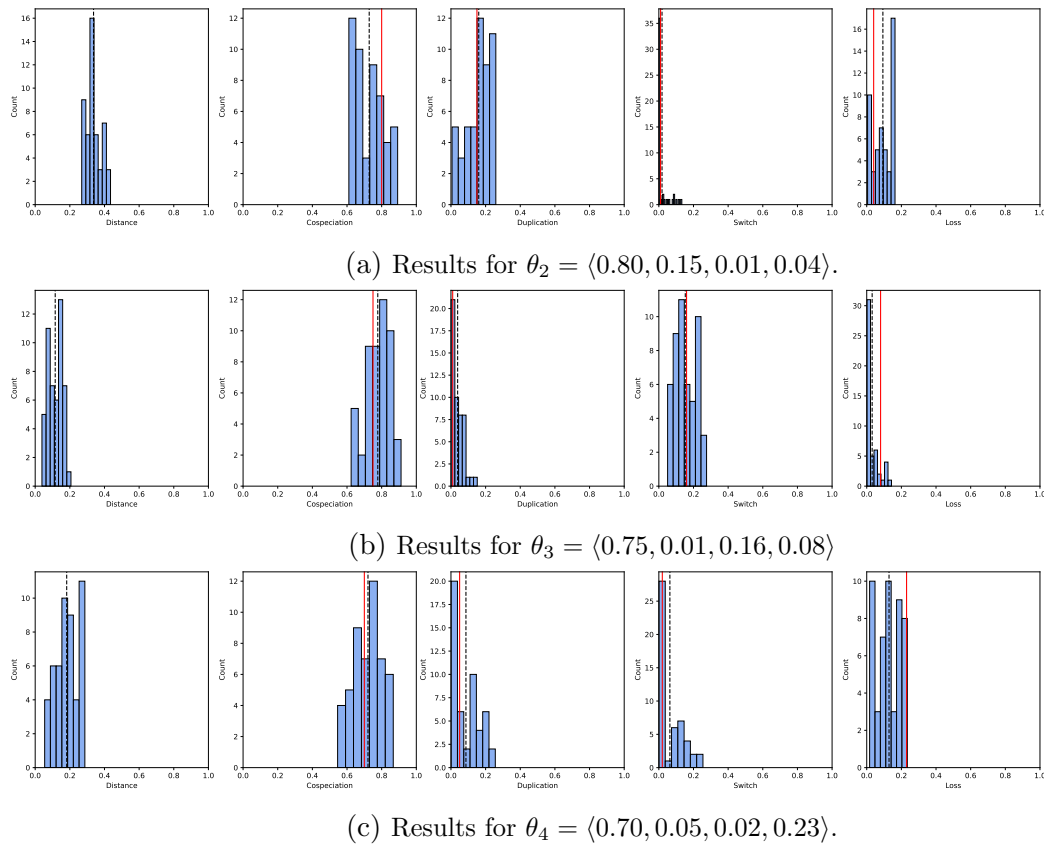


Figure S.2: For each simulated dataset with true parameter value θ_i and $2 \leq i \leq 8$, we ran AMOCOALA 50 times and, at the end of the third round, we took note of the cluster whose representative parameter vector had the smallest euclidean distance (histograms shown in the first column) to θ_i . Columns 2 to 5 show the histograms of the distributions of the event probabilities in these "best" clusters. The dashed vertical black line indicates the mean value. The solid vertical red line indicates the true parameter value.

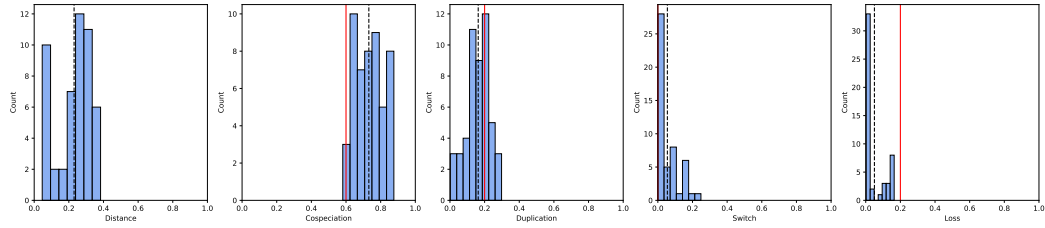
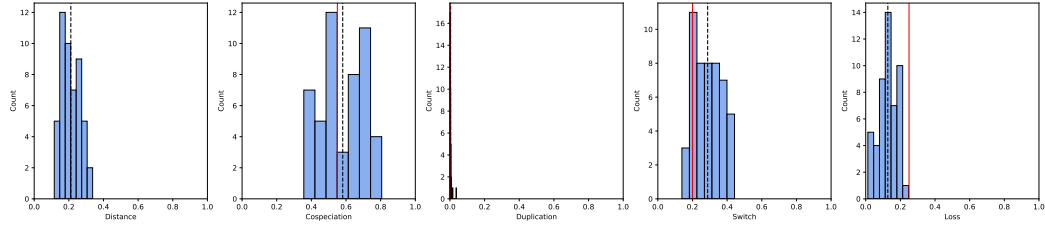
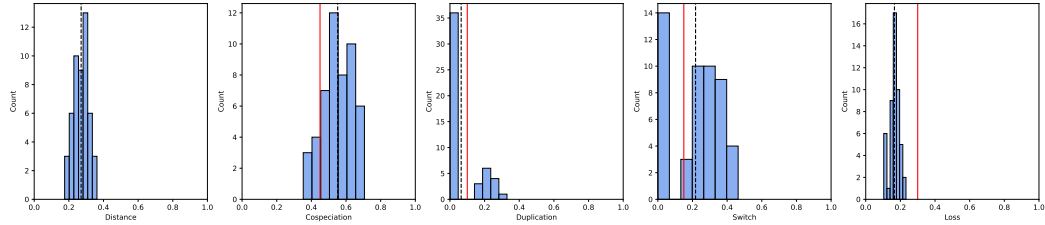
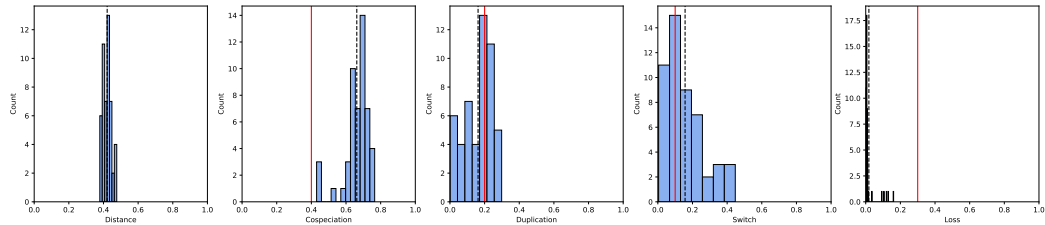
(a) Results for $\theta_5 = \langle 0.60, 0.20, 0.00, 0.20 \rangle$ (b) Results for $\theta_6 = \langle 0.55, 0.00, 0.20, 0.25 \rangle$.(c) Results for $\theta_7 = \langle 0.45, 0.10, 0.15, 0.30 \rangle$ (d) Results for $\theta_8 = \langle 0.40, 0.20, 0.10, 0.30 \rangle$.

Figure S.3: For each simulated dataset with true parameter value θ_i , we ran AMOCOALA 50 times and, at the end of the third round, we took note of the cluster whose representative parameter vector had the smallest euclidean distance (histograms shown in the first column) to θ_i . Columns 2 to 5 show the histograms of the distributions of the event probabilities in these "best" clusters. The dashed vertical black line indicates the mean value. The solid vertical red line indicates the true parameter value.

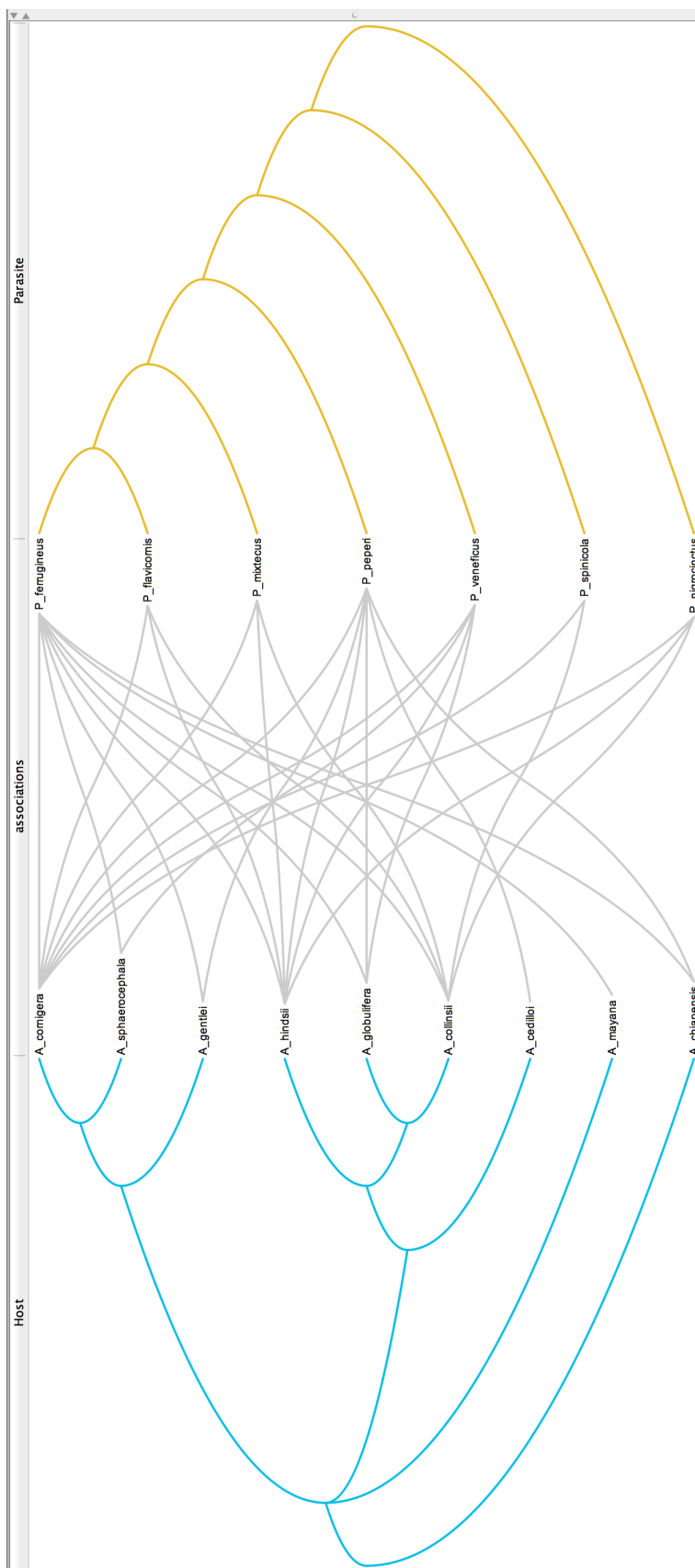


Figure S.4: AP dataset.

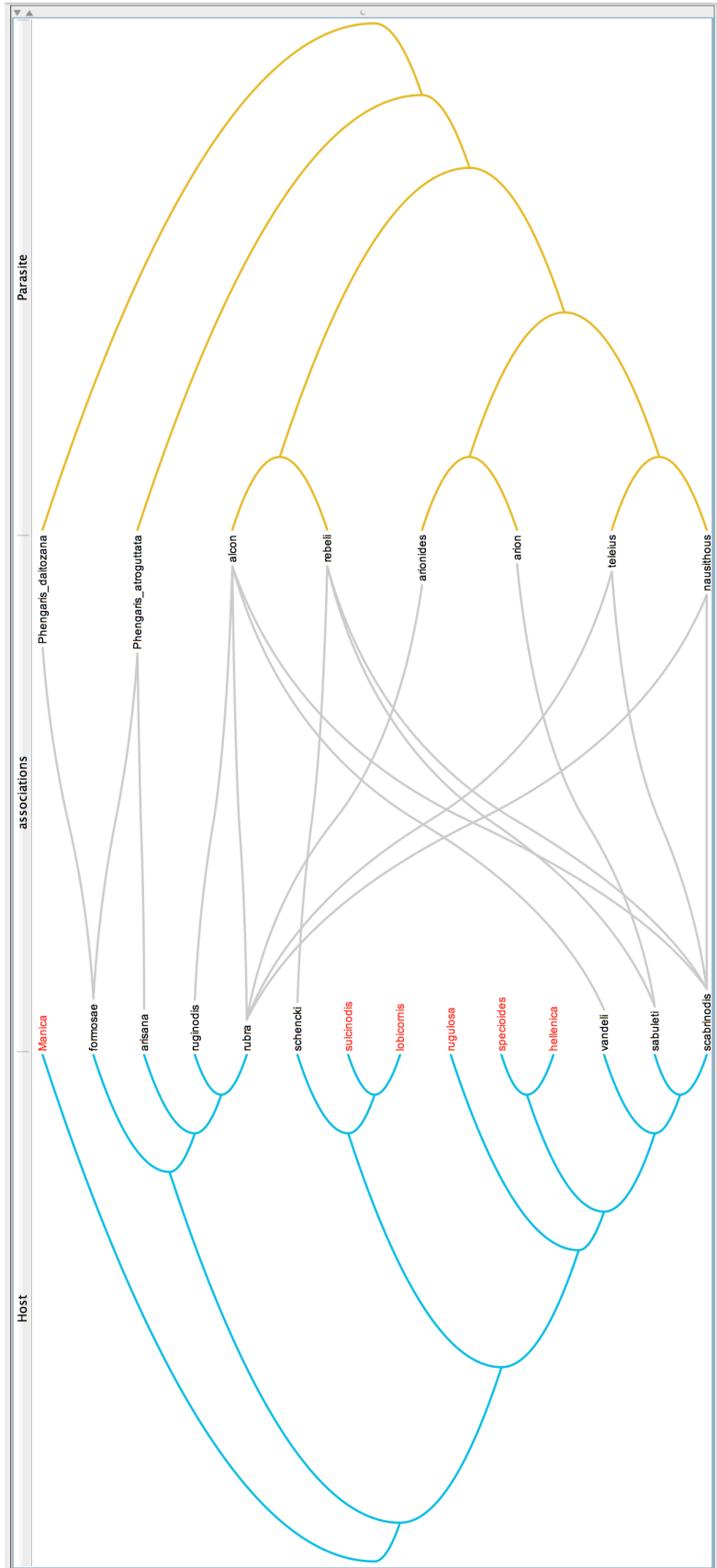


Figure S.5: MP dataset.

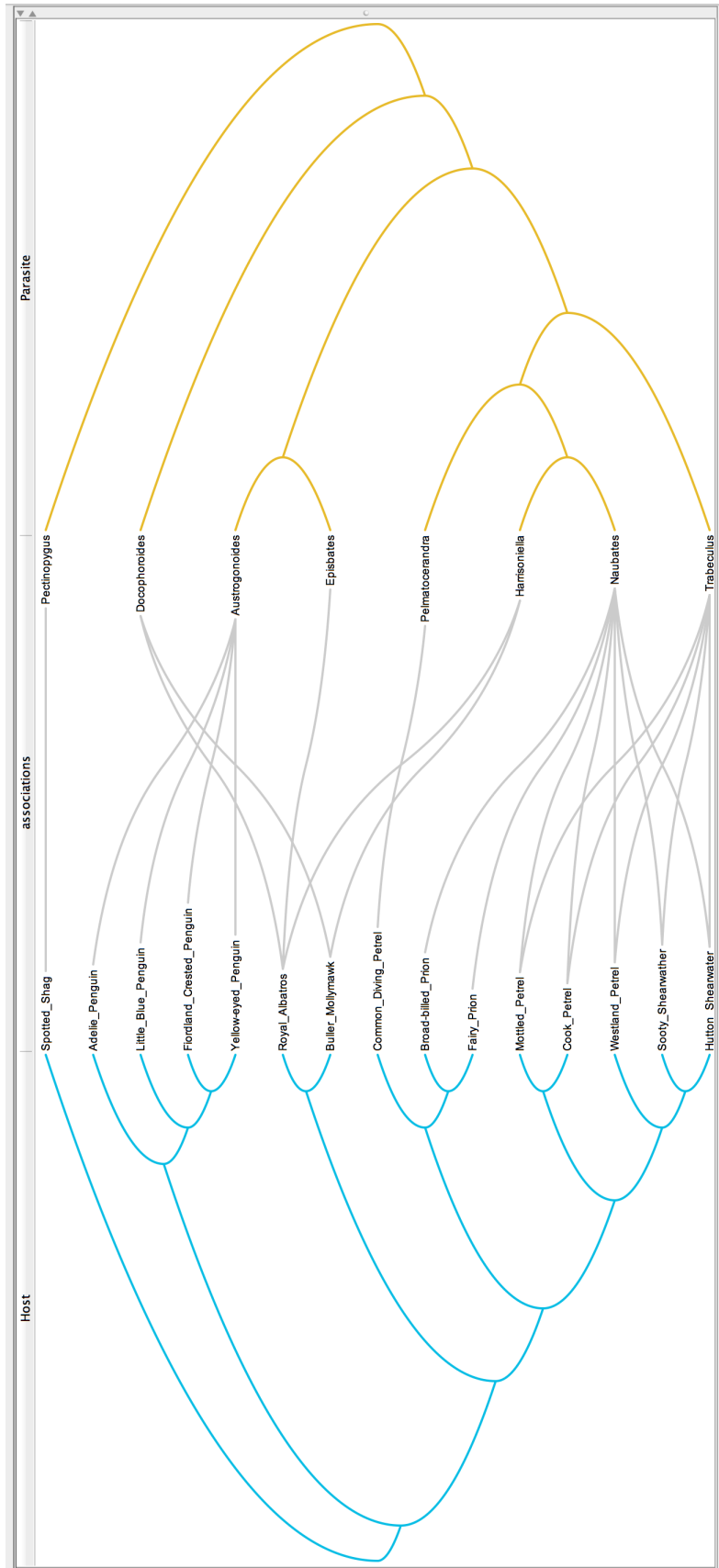


Figure S.6: SBL dataset.

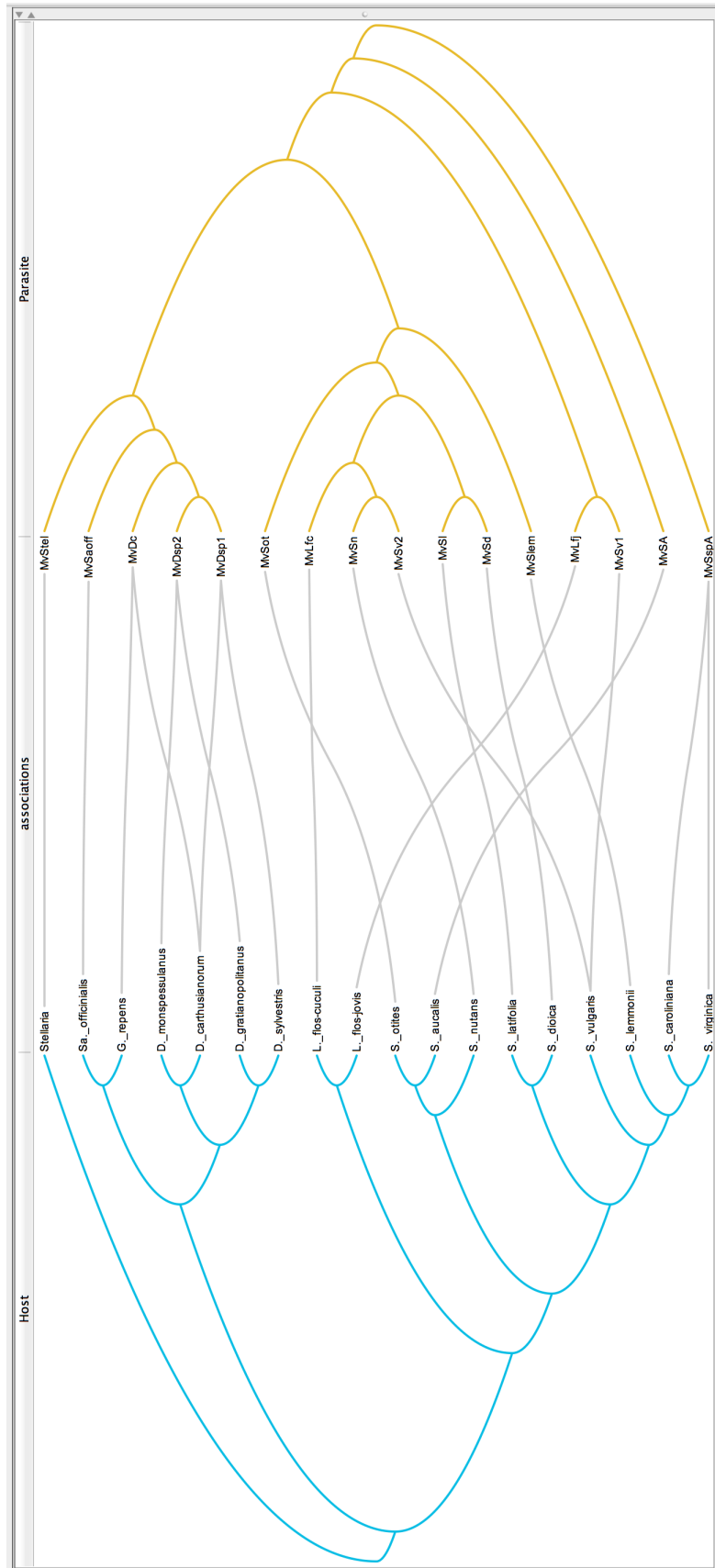


Figure S.7: SFC dataset.

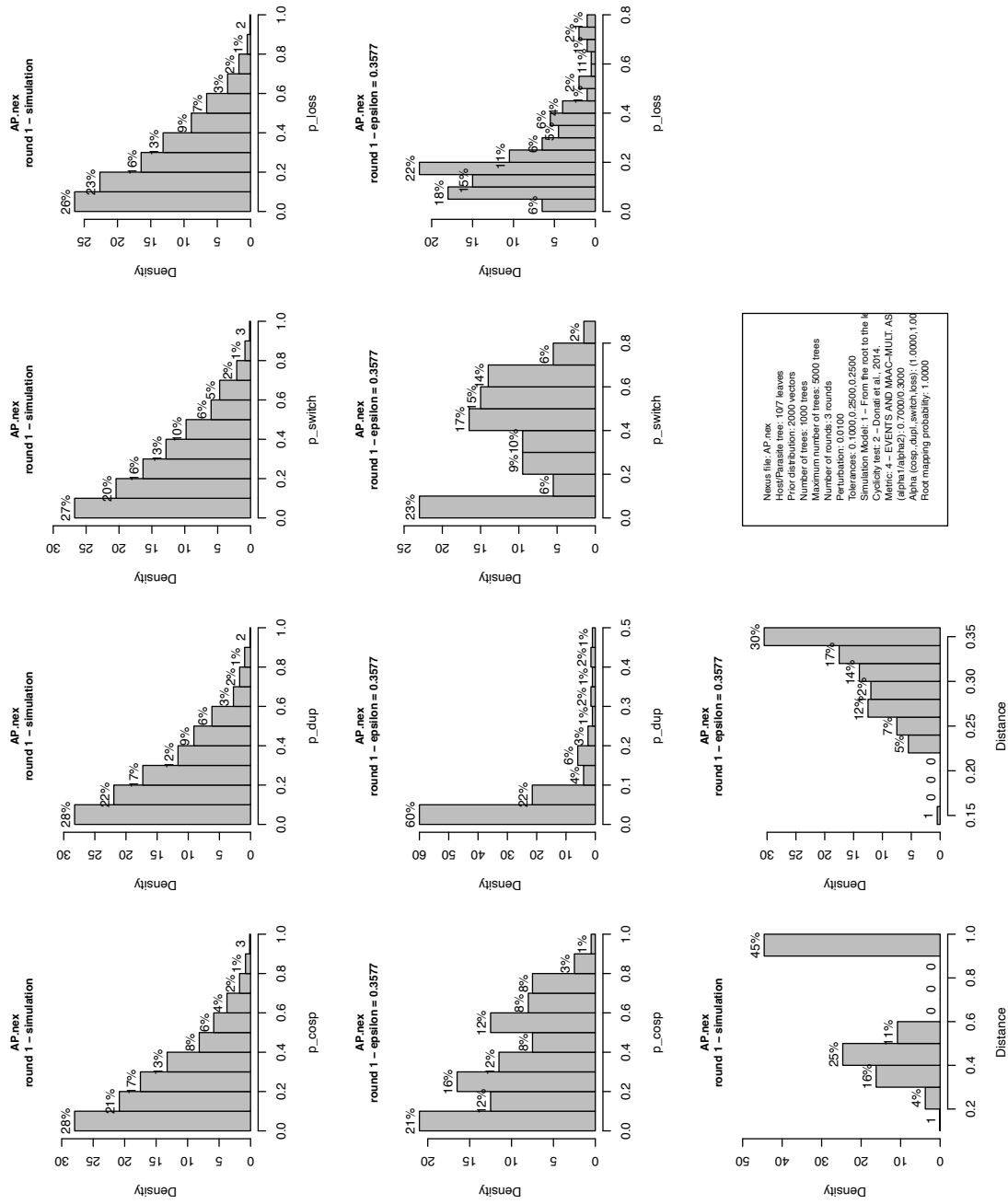


Figure S.8: AP dataset. First row: histograms of the input parameters. Second row: histograms of the parameters after round 1. Third row: summary discrepancies of the input parameters and of the parameters after round 1.

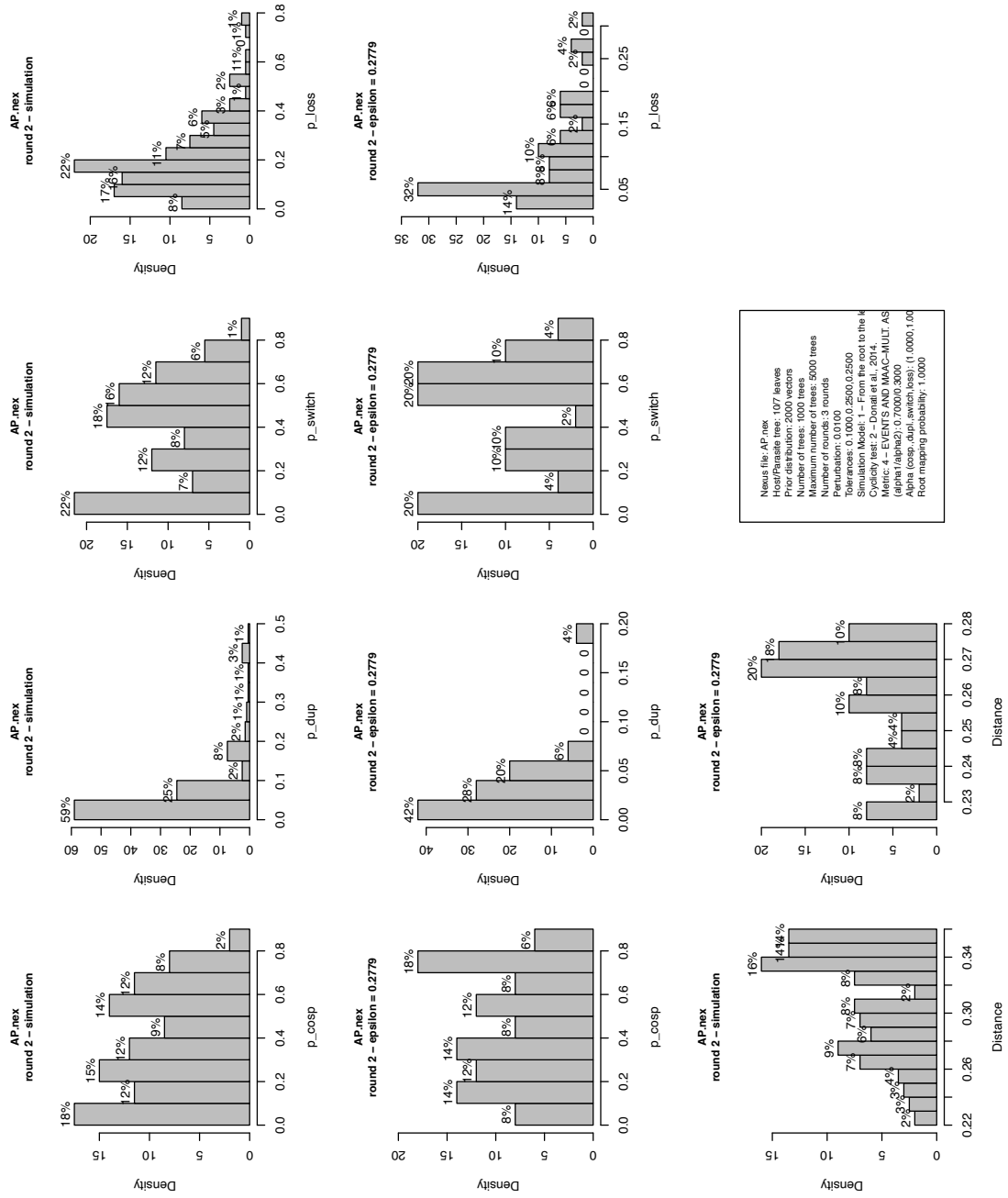


Figure S.9: AP dataset. First row: histograms of the input parameters. Second row: histograms of the parameters after round 2. Third row: summary discrepancies of the input parameters and of the parameters after round 2.

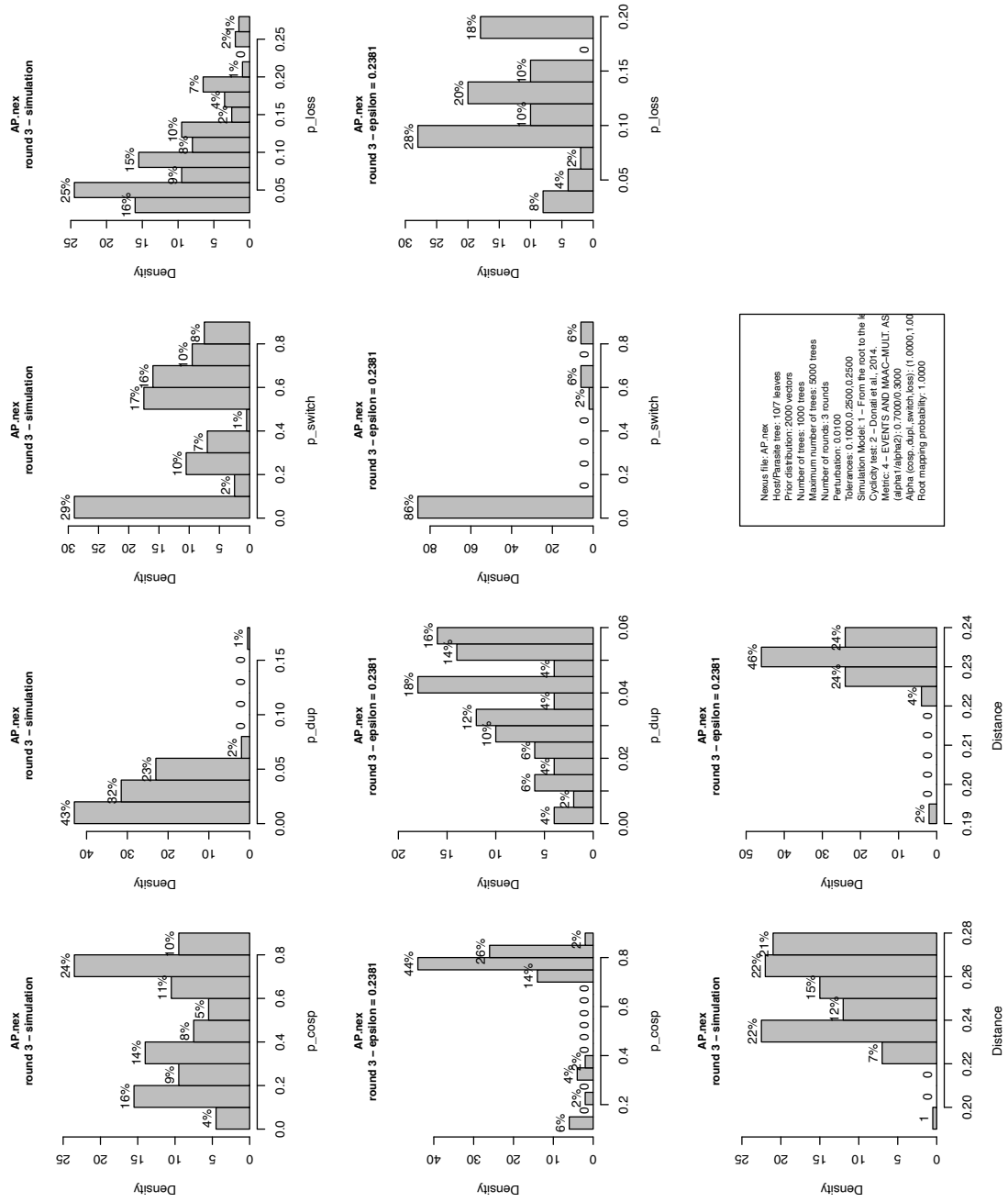


Figure S.10: AP dataset. First row: histograms of the input parameters. Second row: histograms of the parameters after round 3. Third row: summary discrepancies of the input parameters and of the parameters after round 3.

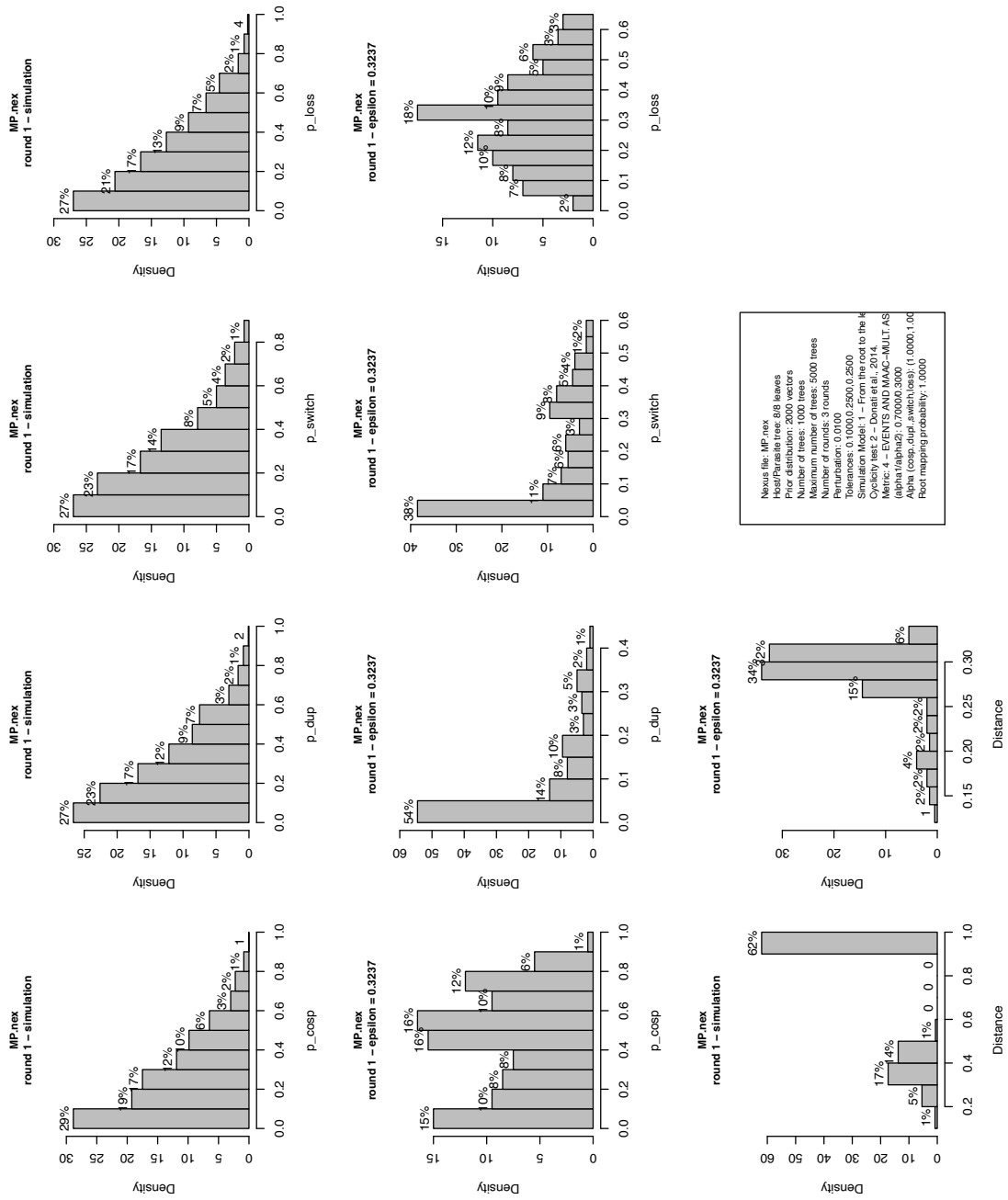


Figure S.11: MP dataset. First row: histograms of the input parameters. Second row: histograms of the parameters after round 1. Third row: summary discrepancies of the input parameters and of the parameters after round 1.

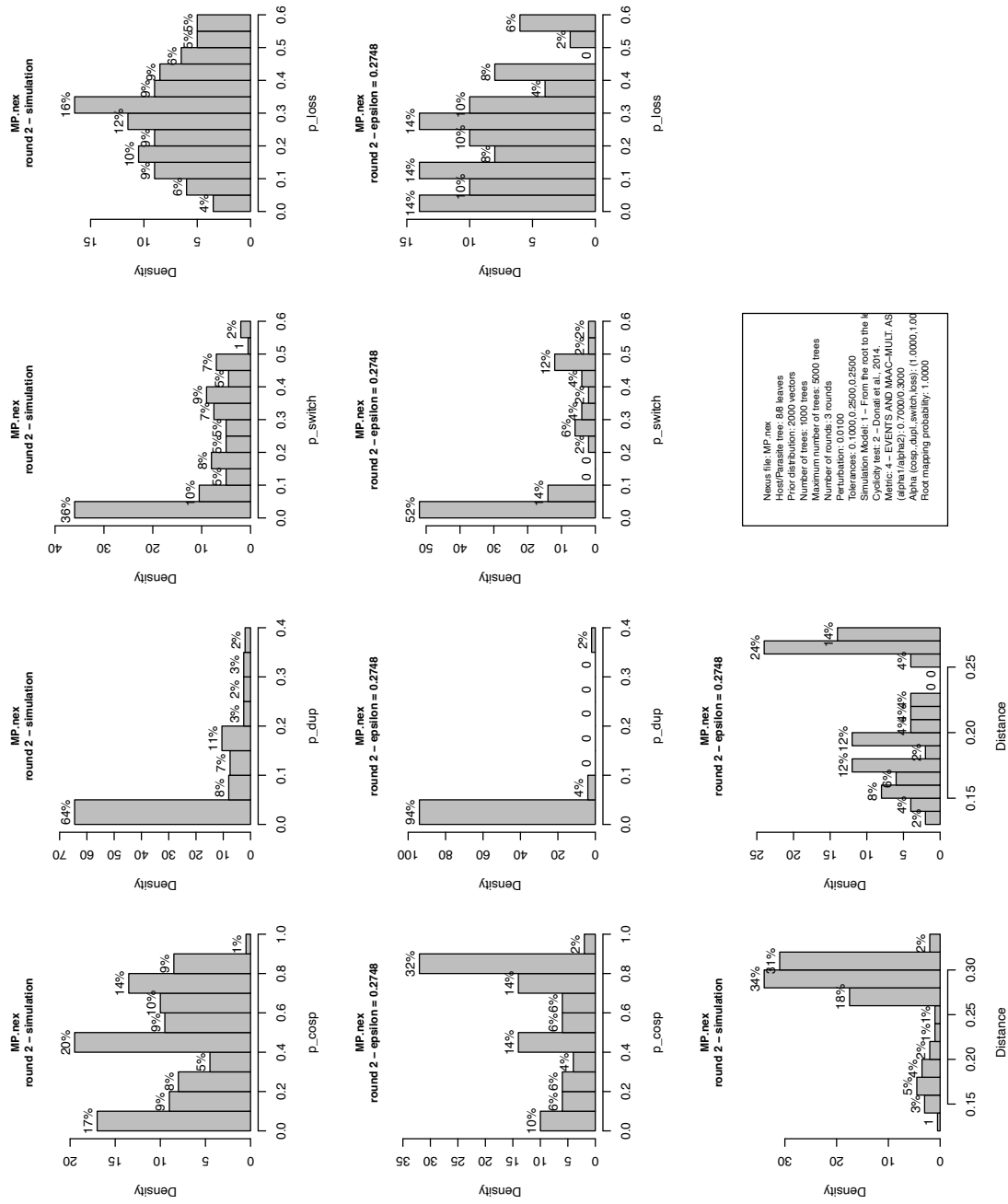


Figure S.12: MP dataset. First row: histograms of the input parameters. Second row: histograms of the parameters after round 2. Third row: summary discrepancies of the input parameters and of the parameters after round 2.

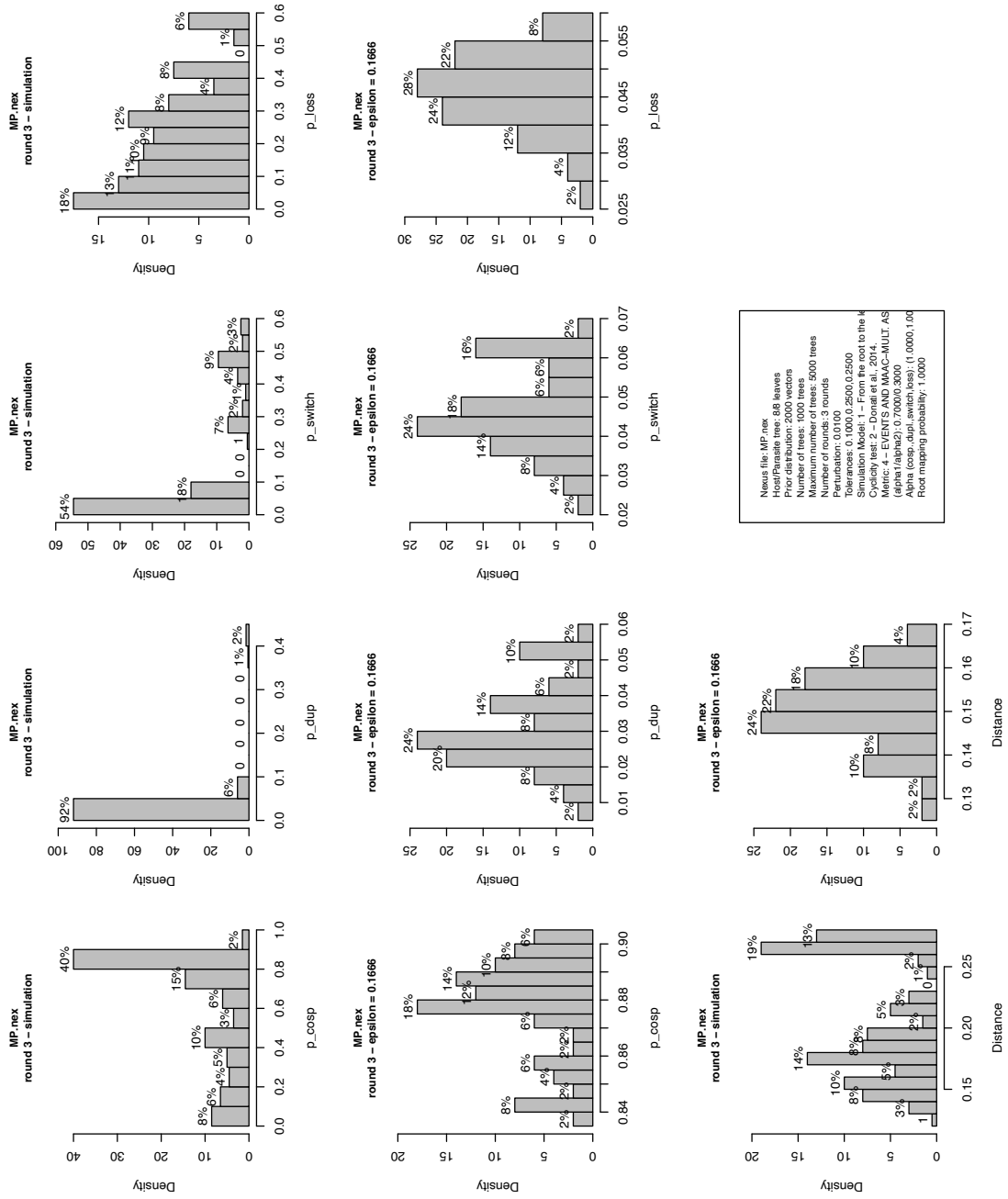


Figure S.13: MP dataset. First row: histograms of the input parameters. Second row: histograms of the parameters after round 3. Third row: summary discrepancies of the input parameters and of the parameters after round 3.

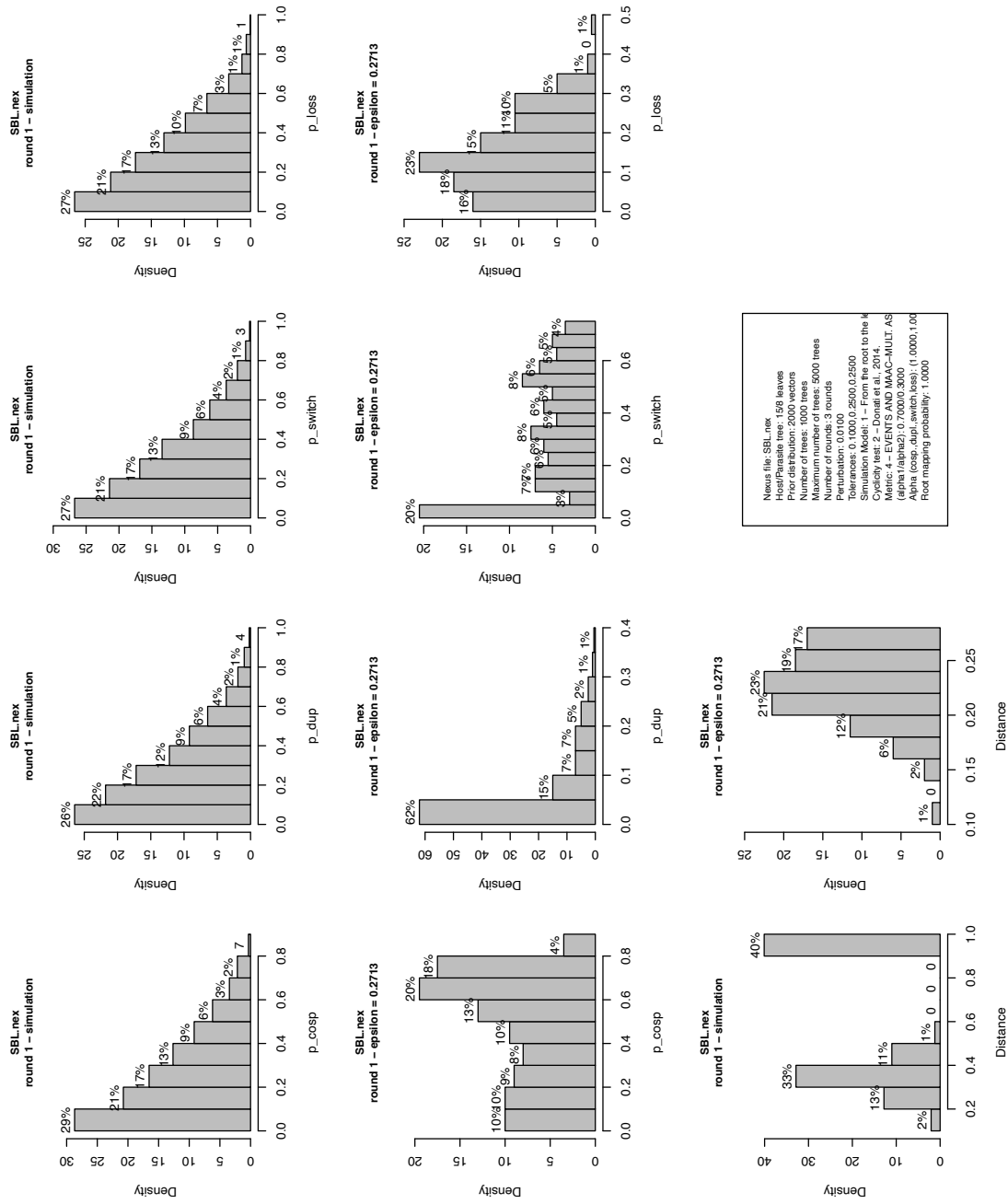


Figure S.14: SBL dataset. First row: histograms of the input parameters. Second row: histograms of the parameters after round 1. Third row: summary discrepancies of the input parameters and of the parameters after round 1.

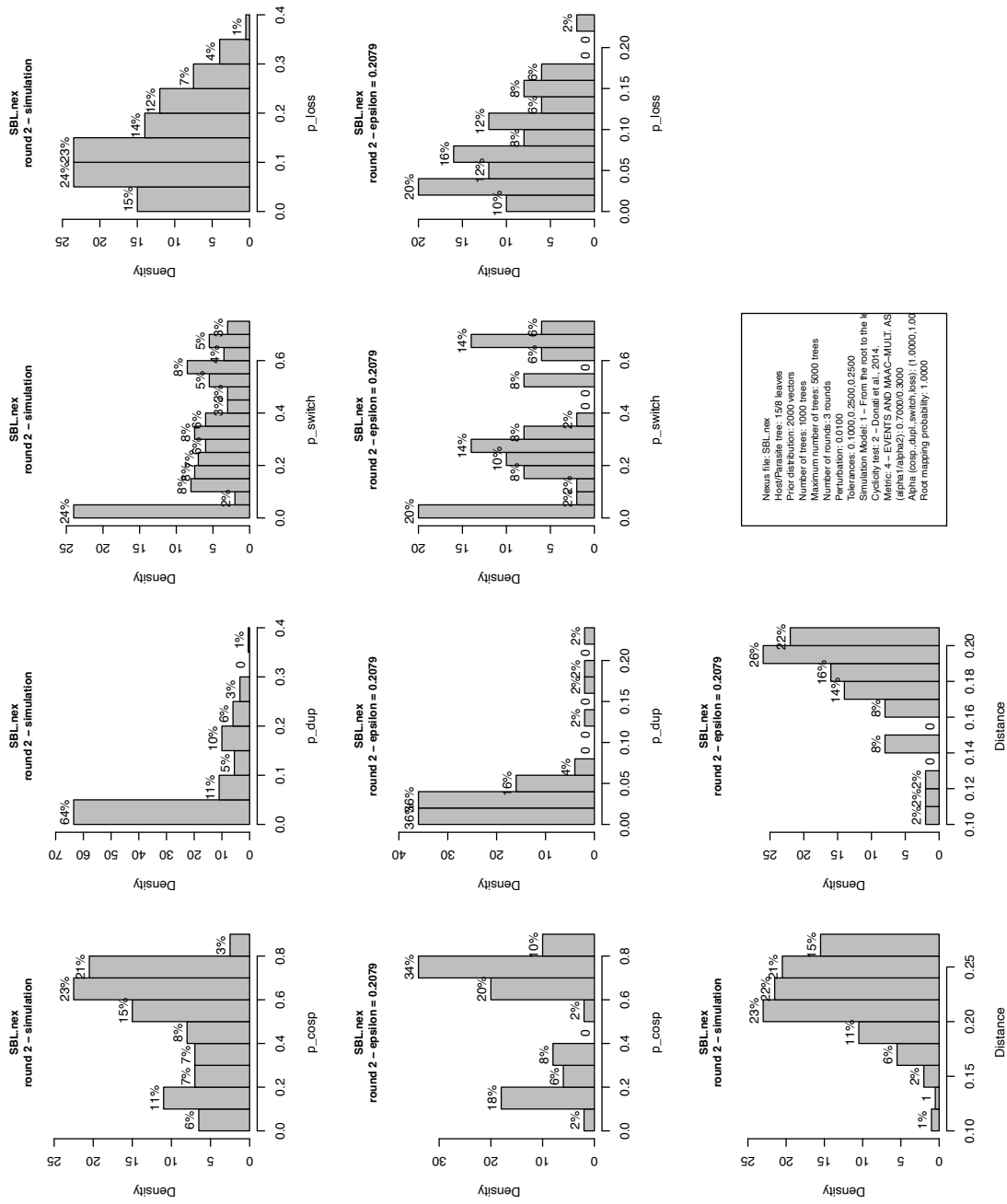


Figure S.15: SBL dataset. First row: histograms of the input parameters. Second row: histograms of the parameters after round 2. Third row: summary discrepancies of the input parameters and of the parameters after round 2.

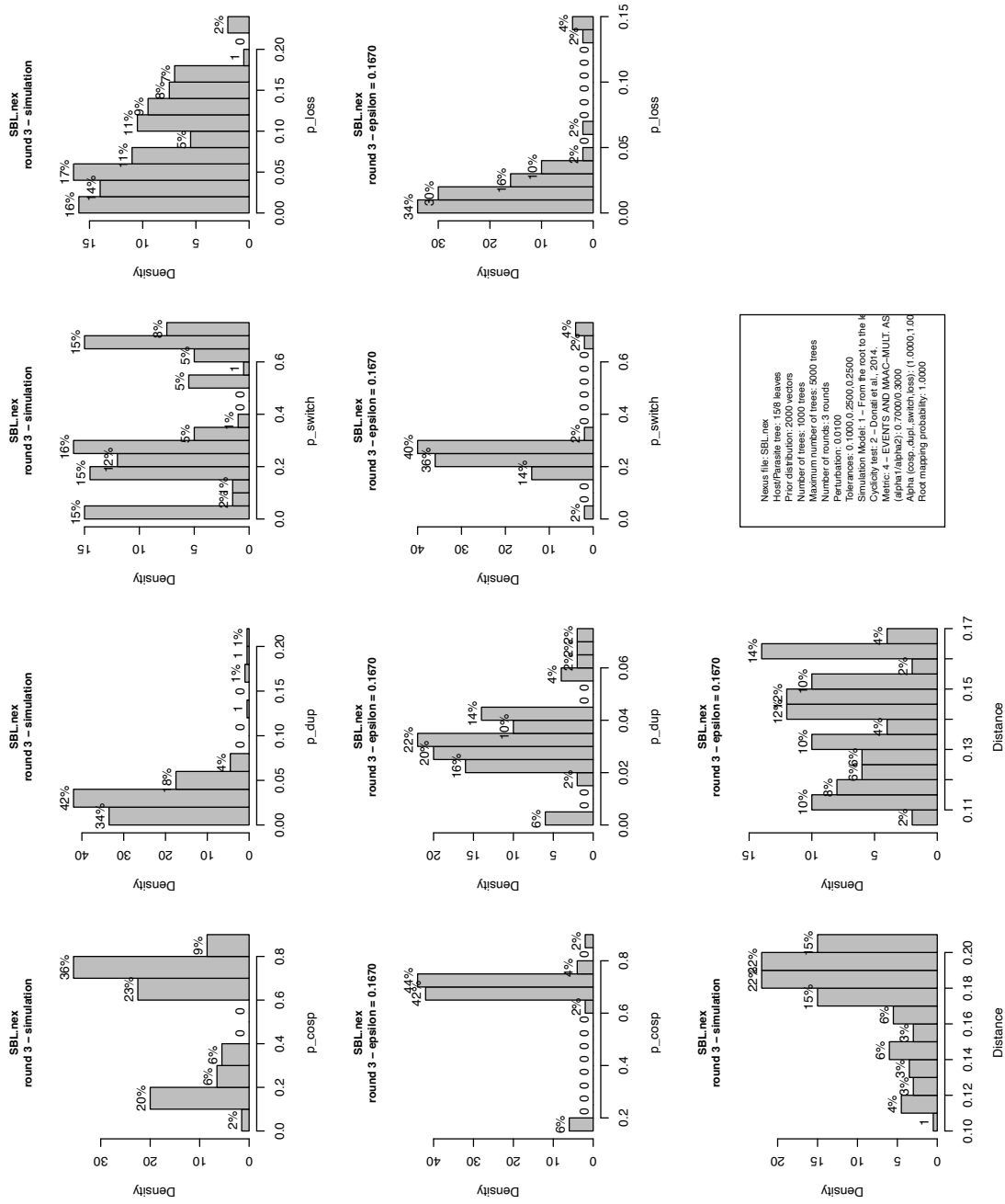


Figure S.16: SBL dataset. First row: histograms of the input parameters. Second row: histograms of the parameters after round 3. Third row: summary discrepancies of the input parameters and of the parameters after round 3.

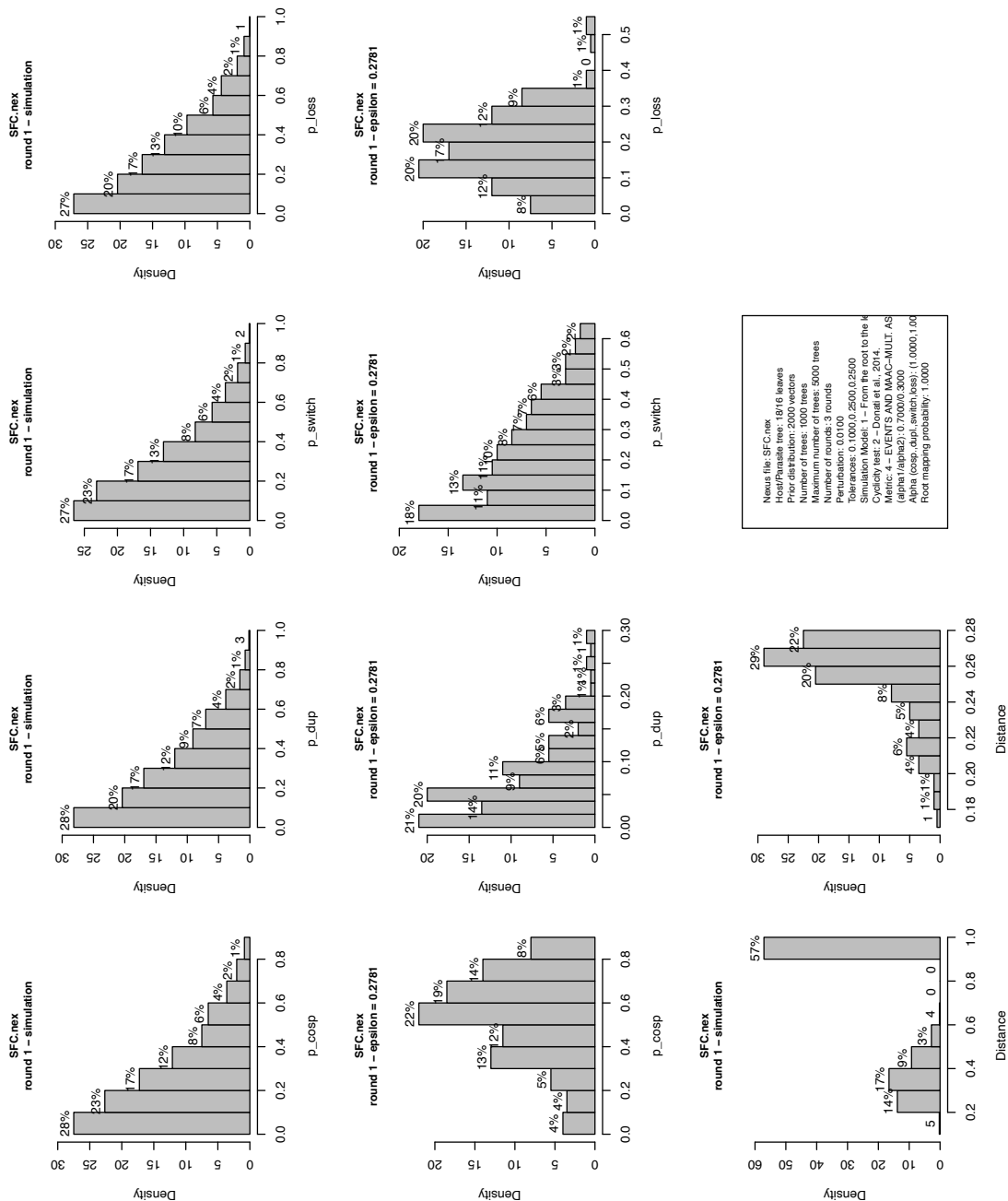


Figure S.17: SFC dataset. First row: histograms of the input parameters. Second row: histograms of the parameters after round 1. Third row: summary discrepancies of the input parameters and of the parameters after round 1.

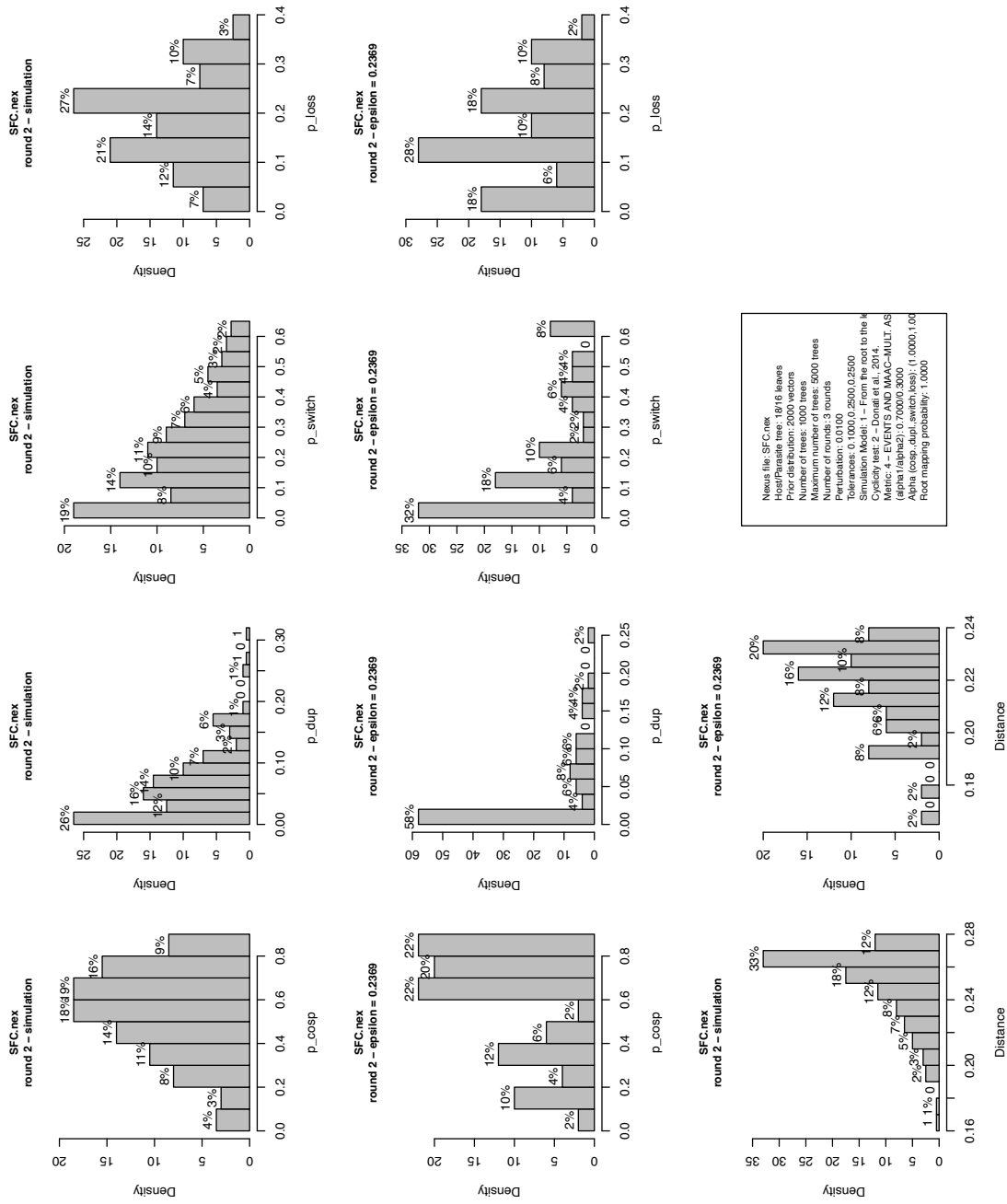


Figure S.18: SFC dataset. First row: histograms of the input parameters. Second row: histograms of the parameters after round 2. Third row: summary discrepancies of the input parameters and of the parameters after round 2.

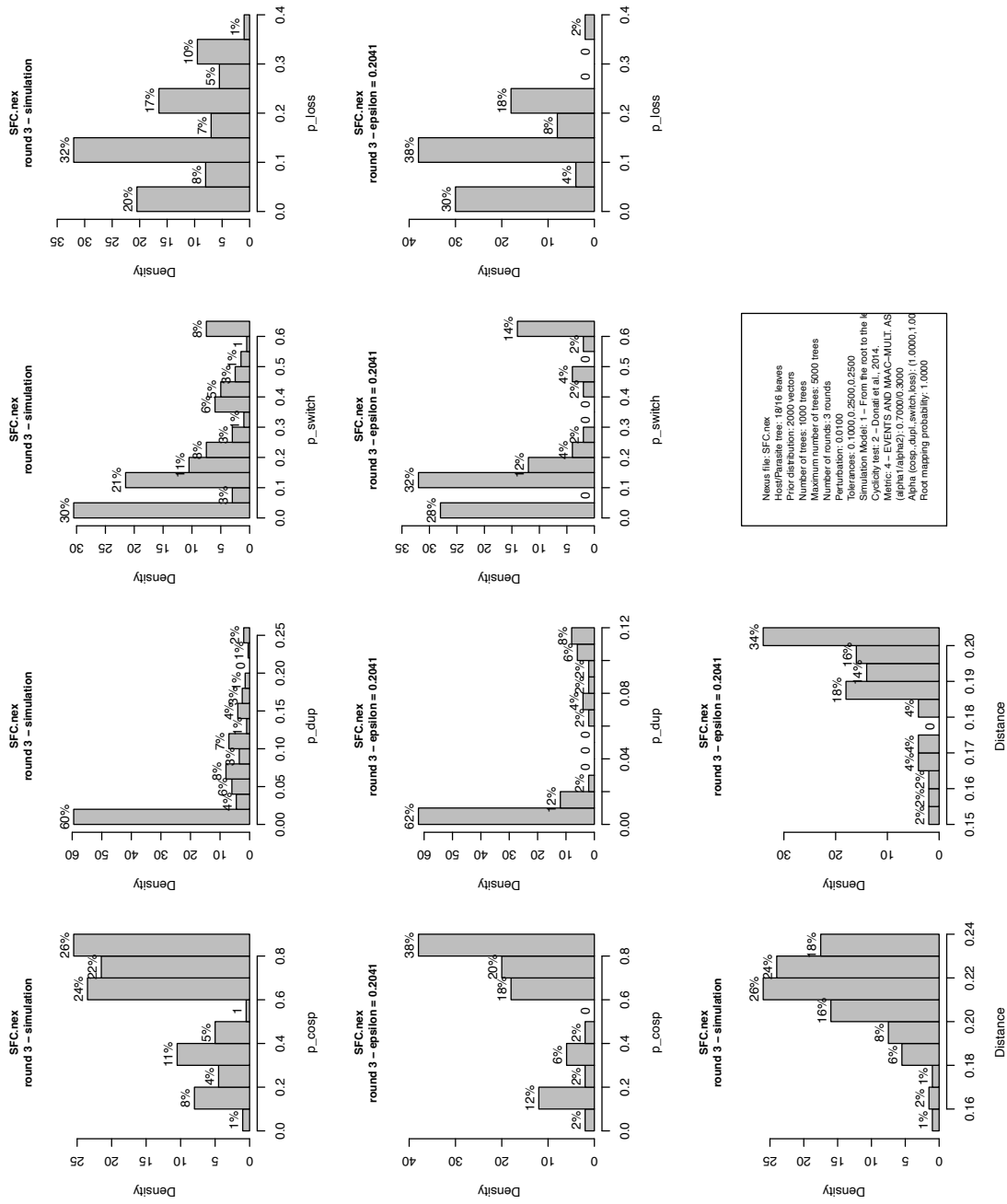


Figure S.19: SFC dataset. First row: histograms of the input parameters. Second row: histograms of the parameters after round 3. Third row: summary discrepancies of the input parameters and of the parameters after round 3.

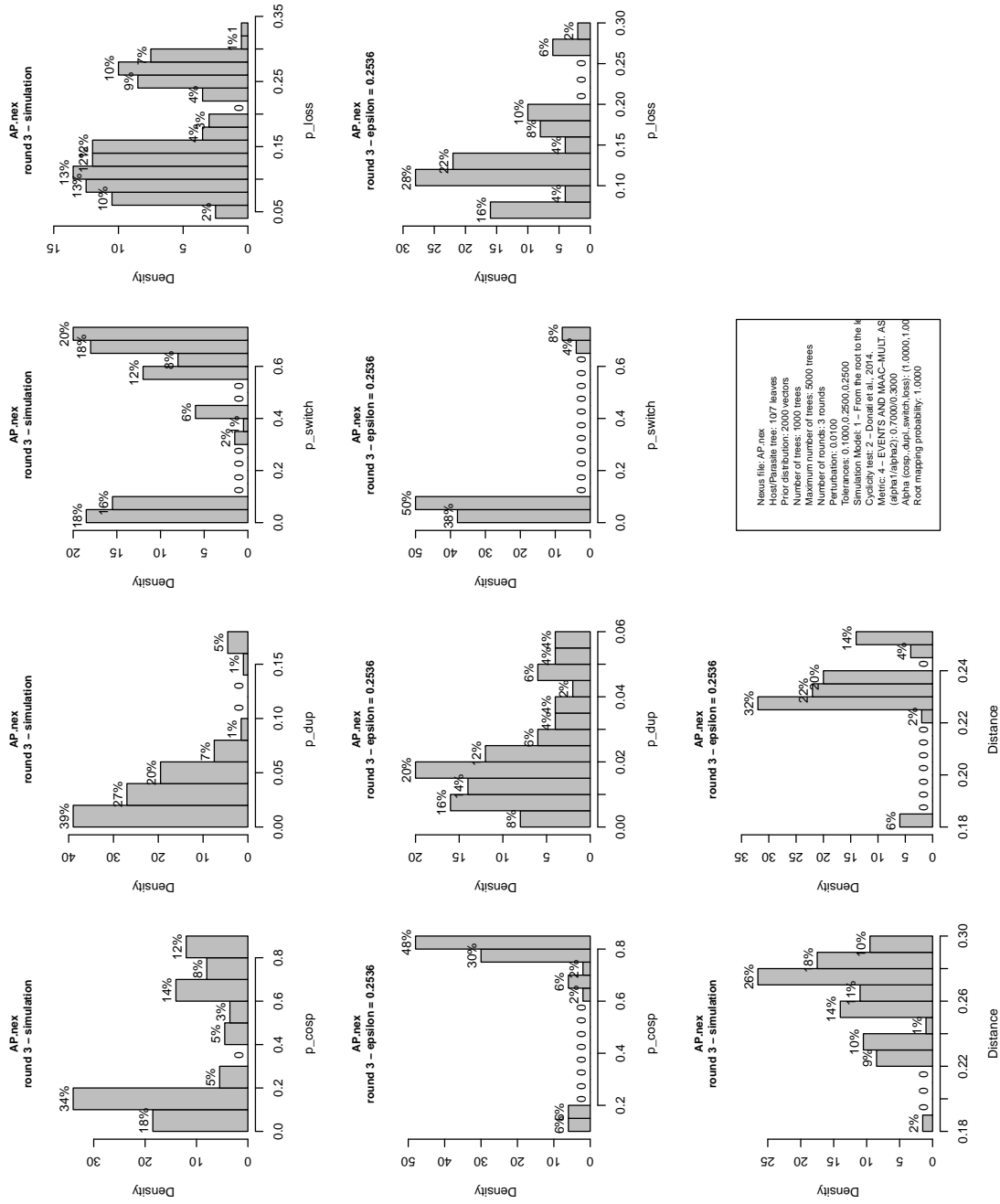


Figure S.20: AP dataset with perturbed spread probabilities. First row: histograms of the input parameters. Second row: histograms of the parameters after round 1. Third row: summary discrepancies of the input parameters and of the parameters after round 1.

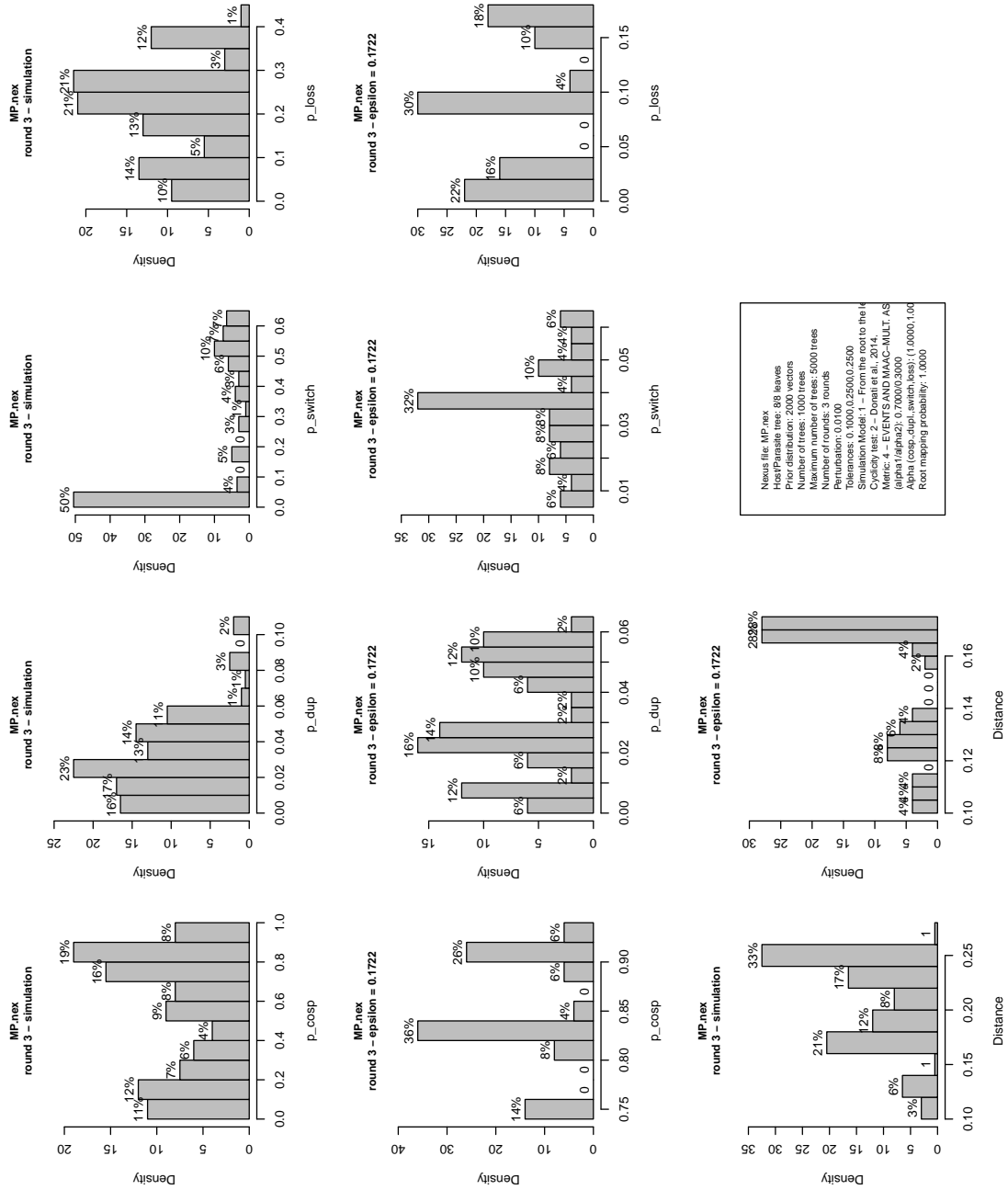


Figure S.21: MP dataset with perturbed spread probabilities. First row: histograms of the input parameters. Second row: histograms of the parameters after round 1. Third row: summary discrepancies of the input parameters and of the parameters after round 1.

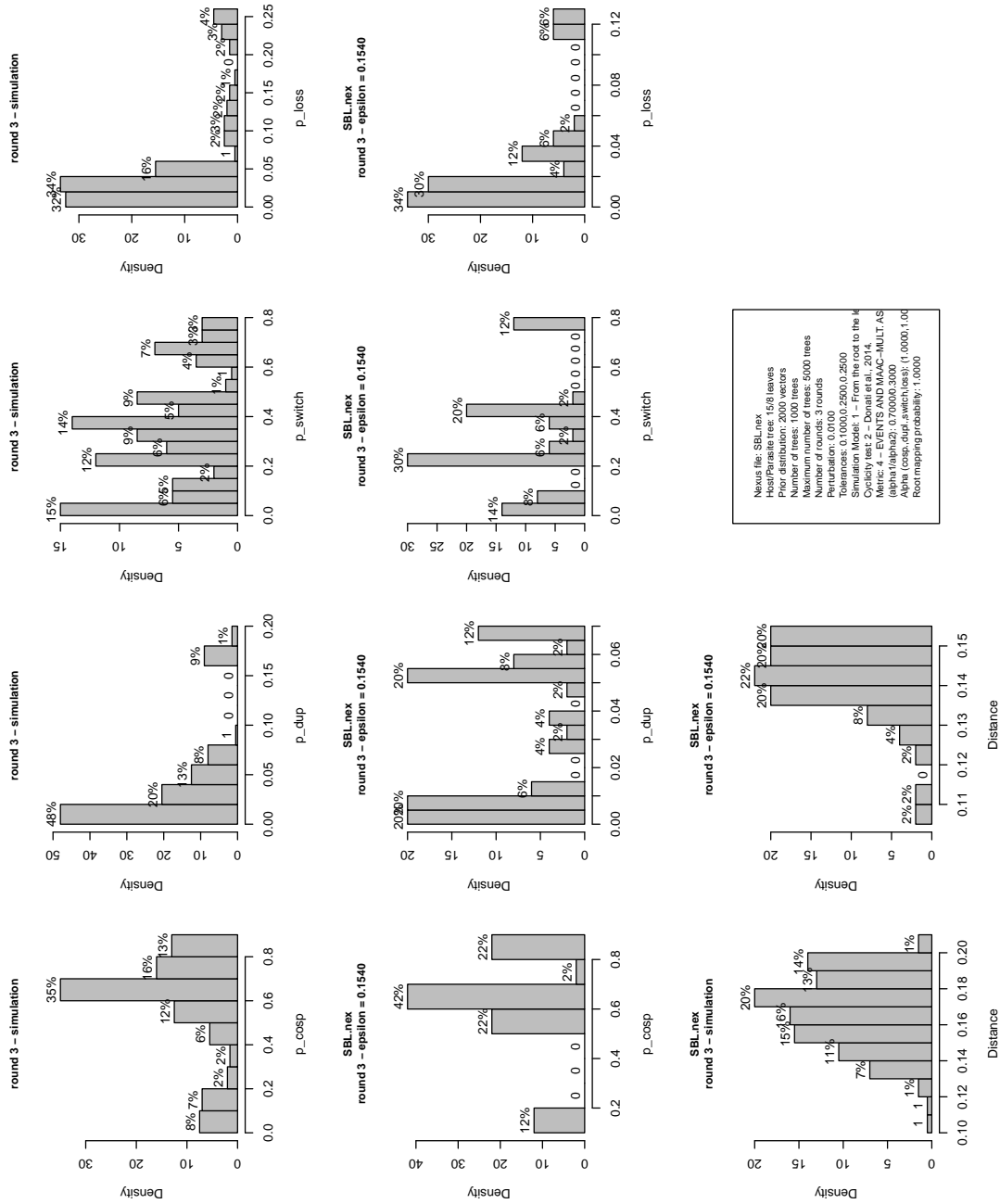


Figure S.22: SBL dataset with perturbed spread probabilities. First row: histograms of the input parameters. Second row: histograms of the parameters after round 1. Third row: summary discrepancies of the input parameters and of the parameters after round 1.

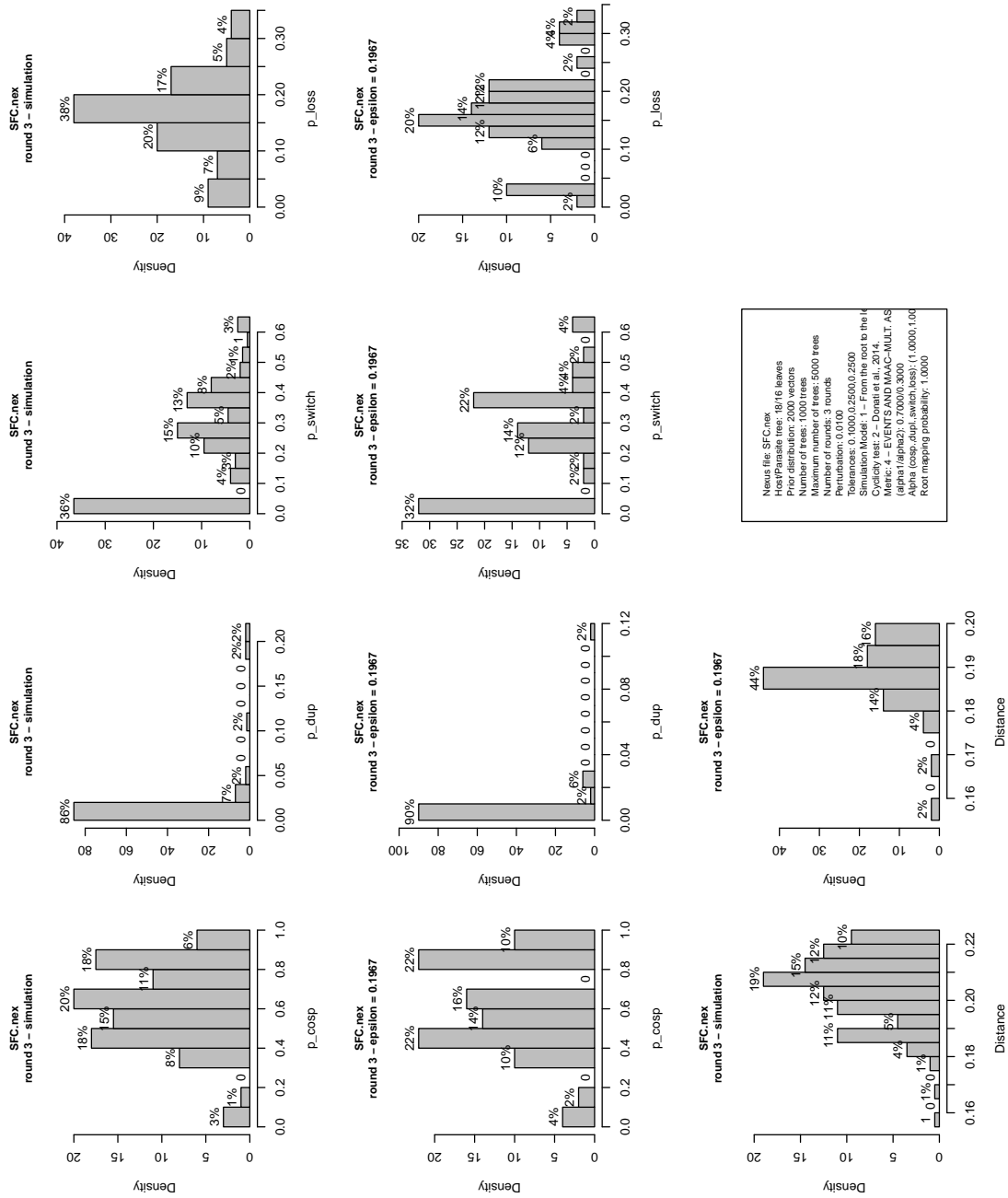


Figure S.23: SFC dataset with perturbed spread probabilities. First row: histograms of the input parameters. Second row: histograms of the parameters after round 1. Third row: summary discrepancies of the input parameters and of the parameters after round 1.

Table S.2: Representative vectors of the clusters produced by AMOCOALA with perturbations for the SFC dataset. The column *#vectors* indicates the number of vectors in the cluster.

<i>Dataset</i>	<i>Cluster</i>	p_c	p_d	p_s	p_l	<i>#vectors</i>
SFC	1	0.4985	0.0024	0.3162	0.1829	31
	2	0.8738	0.0147	0.0180	0.0935	16
	3	0.1087	0.0012	0.5770	0.3131	3