



HAL
open science

Neuromorphic Event-Based Spatio-temporal Attention using Adaptive Mechanisms

Amélie Gruel, Antonio Vitale, Jean Martinet, Michele Magno

► **To cite this version:**

Amélie Gruel, Antonio Vitale, Jean Martinet, Michele Magno. Neuromorphic Event-Based Spatio-temporal Attention using Adaptive Mechanisms. International Conference on Artificial Intelligence Circuits and Systems (AICAS), Jun 2022, Incheon, South Korea. hal-03671778v1

HAL Id: hal-03671778





<https://hal.science/hal-03671778v1>

Submitted on 18 May 2022 (v1), last revised 13 Oct 2022 (v2)

HAL is a multi-disciplinary open access archive for the deposit and dissemination of scientific research documents, whether they are published or not. The documents may come from teaching and research institutions in France or abroad, or from public or private research centers.

L'archive ouverte pluridisciplinaire **HAL**, est destinée au dépôt et à la diffusion de documents scientifiques de niveau recherche, publiés ou non, émanant des établissements d'enseignement et de recherche français ou étrangers, des laboratoires publics ou privés.

Event data downscaling for embedded computer vision

Amélie Gruel¹^a, Jean Martinet¹^b, Teresa Serrano-Gotarredona²^c, Bernabé Linares-Barranco²^d

¹Université Côte d'Azur, CNRS, I3S, France

²Instituto de Microelectrónica de Sevilla IMSE-CNM, Sevilla, Spain
{amelie.gruel, jean.martinet}@univ-cotedazur.fr

Keywords: Event cameras, Computer vision, Data reduction, Preprocessing, Visualisation

Abstract: Event cameras (or silicon retinas) represent a new kind of sensor that measure pixel-wise changes in brightness and output asynchronous events accordingly. This novel technology allows for a sparse and energy-efficient recording and storage of visual information. While this type of data is sparse by definition, the event flow can be very high, up to 25M events per second, which requires significant processing resources to handle and therefore impedes embedded applications. Neuromorphic computer vision and event sensor based applications are receiving an increasing interest from the computer vision community (classification, detection, tracking, segmentation, etc.), especially for robotics or autonomous driving scenarios. Downscaling event data is an important feature in a system, especially if embedded, so as to be able to adjust the complexity of data to the available resources such as processing capability and power consumption. To the best of our knowledge, this work is the first attempt to formalize event data downscaling. In order to study the impact of spatial resolution downscaling, we compare several features of the resulting data, such as the total number of events, event density, information entropy, computation time and optical consistency as assessment criteria. Our code is available online at <https://github.com/amygruel/EvVisu>.

1 INTRODUCTION

Event-based camera are slowly but surely integrating many embedded systems, such as autonomous vehicles and other robotic applications. However, this novel type of asynchronous data comes with a heavy flow of information which can be too much to handle and not always relevant for the task at hand. In order to optimize the information carried by events, we believe that it is necessary to formalize the different methods for event data spatial downscaling, as defined in Fig 1.

1.1 Event cameras

The idea of a novel bio-inspired event-based sensor, akin to a "silicon retina" (Mahowald and Mead, 1991), has been developed since the 1990s. In bio-inspired retinas, the transmitted information is coded as spikes. Pixels emit spikes whenever relevant

information is captured in the visual field. Retinas converting luminance to spike frequency, spatial contrast retinas as well as retinas implementing some spatio-temporal filtering have been proposed. In 2008, Lichtsteiner, Posch and Delbruck presented the first complete design of a Dynamic Vision Sensor (DVS) (Lichtsteiner et al., 2008) responding only to temporal brightness change in a scene with no consideration for colours, similar to the organic retina.

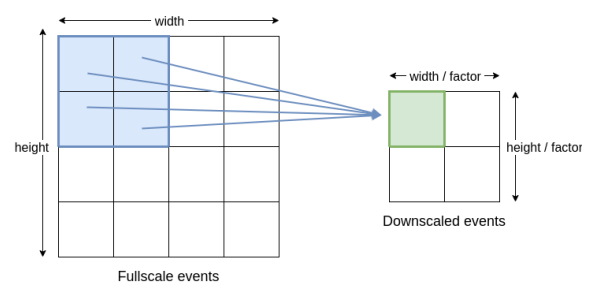





Figure 1: A set of fullscale events captured by a sensor of size $width \times height$ is downscaled according to a downscaling factor $factor$, set to 2 in this example. Here, all the events of the original sample occurring in the blue area's pixels will correspond to the events occurring in the red pixel after reduction.

^a <https://orcid.org/0000-0003-3916-0514>

^b <https://orcid.org/0000-0001-8821-5556>

^c <https://orcid.org/0000-0001-5714-2526>

^d <https://orcid.org/0000-0002-1813-4889>

The main advantages of such an artificial retina are (Gallego et al., 2020):

- the high temporal resolution, thanks to which an event can be emitted on the timescale of microseconds and avoiding motion blur,
- the high dynamic range, which makes it possible to use them for extremely dim as well as under bright sun illumination,
- the high contrast range which allows for highly contrasted images avoiding dazzling effect caused by sudden illumination changes, thus scenes with illumination expanding over 120dB can be sensed without suffering saturation,
- the low latency and asynchronicity enabled by the independence between each pixel,
- the absence of redundancy in the information transmitted, as compared to frame-based sensors,
- the low power consumption, following the model of biological retinas and substituting the biological photoreceptors by photodiodes in the electrical circuits.

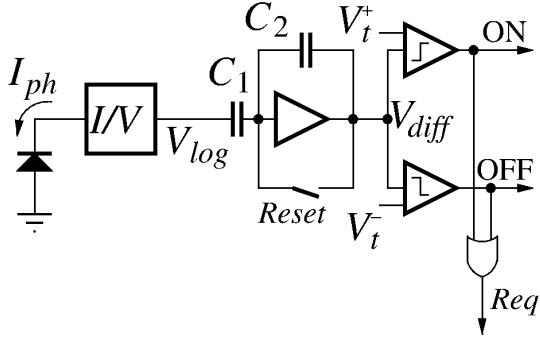

Figure 2: Block diagram of an event camera pixel.

Fig. 2 shows the conceptual schematic of an event camera pixel. A photosensor produces a current I_{ph} proportional to the illumination. A transimpedance logarithmic circuitry converts the detected current into a voltage $V_{log} = A_T \log(I_{ph})$ which depends logarithmically on the photocurrent. This voltage is the input to a differencing capacitive amplifier, so that the voltage difference

$$\Delta V_{diff} = -C_1/C_2 \Delta V_{log} = -C_1/C_2 A_T \Delta I_{ph}/I_{ph} \quad (1)$$

That way voltage V_{diff} is proportional to the relative temporal variation of the photocurrent. Voltage V_{diff} is compared with an upper and a lower voltage thresholds. Each time it goes over the upper (or below the lower) threshold, the pixel will generate an output ON (or OFF) event and voltage V_{diff} is reset to a resting value V_R .

Fig. 3 illustrates the resulting behavior of the event camera pixel. The upper subfigure plots the variation of a pixel photocurrent along time, while the lower subfigure illustrates the generated ON and OFF output events. As can be observed, each time the photocurrent increases (or decreases) by a certain relative variation given by,

$$\Delta I_{ph}/I_{ph} = C_2(V_t - V_R)/(C_1 A_T) \quad (2)$$

the pixel generates an ON (OFF) output event.

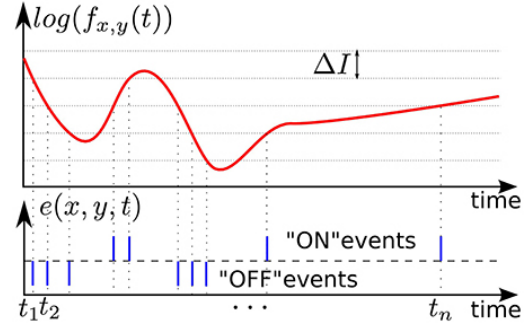

Figure 3: Illustration of event-based encoding of visual signals with respect to the predefined threshold ΔI , from (Lagorce et al., 2015). The luminance captured by the sensor varies over time, and an event is only produced when its log intersects with lines of equation $y = \Delta I$. The corresponding event is positive when the log-luminance's slope is positive at the intersection, and negative otherwise. The interval between each t_i and t_{i+1} is not monotonous, which is consistent with the event data asynchronicity.

The event cameras' particularities described above grant them advantages in many application cases compared to more traditional visual sensors (Gallego et al., 2020). A significant field of applications is robotics: autonomous vehicles, drones and other embedded systems requiring low latency and low power data handling. Furthermore, they evolve in uncontrolled lightning conditions thus require a high dynamic range and high contrast range.

Because of their operating mode, event based cameras are useful in tasks featuring movements, such as object tracking (Glover and Bartolozzi, 2016), gesture recognition (Amir et al., 2017), optical flow estimation (Orchard et al., 2013; Paredes-Valles et al., 2020), Simultaneous Localization and Mapping (SLAM) (Kim et al., 2016; Vidal et al., 2018), etc. Their high resolution and contrast range also valuable for astronomical studies (Cohen et al., 2017; Chin et al., 2019). Research on their combined use with traditional RGB camera becomes more common, with applications on high-resolution image reconstruction (Zhang et al., 2021b; Rebecq et al., 2021) and video deblurring (Zhang et al., 2021a).

1.2 Motivations

While desktop event vision solutions can afford large amount of computing resources, embedded application typically face limitations in CPU, memory, and energy usage. Event data is sparse, and yet in some highly dynamic and textured scenes, the event flow can be very high, up to 25M event per second, which requires significant processing resources to handle.

Most existing event vision approaches preprocess event data by simply downscaling the pixel coordinates, which is actually a max-pooling operation in the event domain. One obvious issue of this simple event funnelling is that the resulting event density drastically increases in the reduced spatial dimension, causing an important information loss.

In embedded systems, only relevant information should be stored and processed under the form of downscaled event data. For example, event-based odometry applied to robotics requires only movement information in order to process the information in real time: this need is typically answered by pooling the events in frames (Rebecq et al., 2017), resulting in the loss of the data’s asynchronicity.

In neuromorphic machine learning, spiking neural networks usually can’t handle the flow of information the event data represents and downscale this input by a first preprocessing layer, before actually learning anything.

We can also mention the residual graph convolutional techniques which handles each input event as a node in the graph (Bi et al., 2019): this leads to a low computational efficiency and a substantial simulation run, which can be improved solely by spatially reducing the input neuromorphic data.

The aforementioned examples are just a few reasons why event downscaling is a real challenge in neuromorphic computer vision and needs to be formalized.

The contributions of this paper are twofold: we design and implement a number of methods to reduce the size of event data and we assess the proposed reduction methods by analysing reduced data and also based on the classification results.

The remainder of the paper is organized as follows: firstly an introduction to event-based cameras and the motivations behind this work, then a review of previous use of event data, followed by a complete description of the 6 spatial downscaling methods implemented in this work, and finally a comparison summarising the advantages and disadvantages of each method.

2 RELATED WORK

Reducing the size of visual data is straightforward for grayscale and RGB images with interpolation. When it comes to event data, size reduction is much less trivial. And yet, many papers discussing neuromorphic computer vision are faced with a substantial event flow, sometimes too great to perform the task at hand. In those case, the authors address this issue with various techniques presented below.

A first solution simply consists in creating event frames, then processing this data as standard visual images, as seen in (Fang et al., 2021) and (Huang, 2021). This enables the same model to be applied to any kind of visual data, neuromorphic or not. However its main drawback is that all the data’s asynchronicity, which is a real advantage of event data, is disregarded; all events are gathered and their timestamps discretised.

Spiking neural networks handling event data can consider each pixel as an input neuron, and each event produced as an input spike to the neural model. However this first layer is often too important for efficient computation, thus most authors applying this type of neuromorphic computing on event data resolve to convolve the input. For example, (Cordone et al., 2021) apply multiple convolution layers to the dataset *DVS128 Gesture* before processing it.

The non uniform sampling employed by (Bi et al., 2019) can also be mentioned, although it only produces satisfying results on a sparse dataset with well-defined empty areas like the one they use. This simply amounts to implement a non-uniform grid sampling inspired from traditional data processing to event data.

To the best of our knowledge, the only existing tool for event data downscaling is *Tonic*’s “Downsample” method (Lenz et al., 2021). *Tonic* is a Python library for neuromorphic data handling, which has been created on an original idea dating back from the 2019 Telluride neuromorphic workshop. It facilitates dataset downloads and its conversion to different event representations (frames, time surfaces, voxel grids, etc). It also proposes event transformation, such as denoising, event dropping, polarities merging, spatial and temporal jittering and downsampling.

The “Downsample” method simply multiplies the event coordinates by a spatial factor without dropping any event. It can also be applied to temporal downsampling following the same mechanism. Although it is extremely fast, it has the major flaw of keeping all the original events thus leading to an increasingly high density in the produced visual data.

3 PROPOSED METHODS

The following subsections present the 7 methods considered in this work to downscale spatially the data produced by an event camera. Each method takes as input a sample of events at maximum resolution as well as the factor by which to reduce this sample, and returns the downsampled events as illustrated in Fig. 1. Depending on the downscaling method used, the number and frequency of the downsampled events will not necessarily equal those of the events occurring in the corresponding fullscale regions.

3.1 Simple Event Funnelling

A first solution to reduce event data simply is to divide each event’s coordinates in x and y by the downscaling factor, then remove all the reduced events duplicates (i.e., keep only one occurrence of each event for a specific set of coordinates (x, y, t, p) – see Fig. 4). This method follows the same logic as *Tonic*’s downscaling approach and can also be extended to temporal reduction.

Thanks to its quickness and simplicity, this solution could answer the need for downscaling events in real time on embedded systems. However, the main drawback is that this process does not drop any event. The reduced area undergoes a high density of events, yielding an information loss due to the accumulation of pixel activation (see Fig. 4). Event funnelling tends to drastically increase pixel activity (see Fig. 4), especially when the downscale factor is large. In the extreme yet unlikely case where the data is downsampled to a 1×1 size, the resulting pixel is likely to be constantly active.

Finally, the behavior does not correlate with the physical mechanism of an actual event camera: the optical consistency is very low for this method.

3.2 Log-luminance Reconstruction

From an optical point of view, downscaling the spatial size of an event recording boils down to averaging the luminance captured by a subset of pixels in the original sensor. In a physical implementation of an event camera formed by a 2D array of pixels as the one shown in Fig. 2, this method could be implemented by averaging the photocurrents I_{ph} generated by neighbor pixels and performing the transimpedance logarithmic conversion and posterior voltage amplification and differentiations as explained in Section. Introduction. In order to implement this behavior, the log-luminance is reconstructed for each pixel in the fullscale dataset: each event occurring on the same pixel increases (if positive) or decreases (if negative) the log-luminance level by one unit. The mean log-luminance is then computed for each region of size $factor^2$ in the sensor. Lastly, the downsampled events are generated: an event occurs at every timestep where the average log-luminance crosses a threshold line; the event is positive if the gradient is positive, and vice-versa.

To achieve a pixel’s log-luminance reconstruction, all events from this pixel is translated into points of coordinates (x show the timestamps, y is the level reached) where the initial level is arbitrarily set to 0 and contrast threshold set to 1 (see Fig. 3).

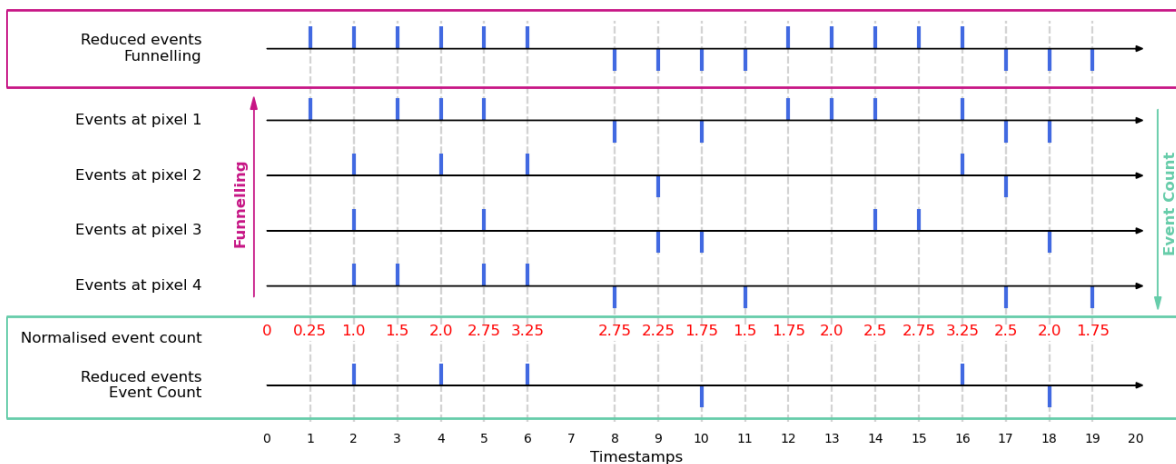

Figure 4: Schematic illustration for event funnelling and event counts methods. A sensor of size 2×2 outputs negative and positive at each pixel across time, which are downsampled using Simple Event Funnelling (red frame on top) and Log-Luminance Event count (green frame at the bottom). In this example, the downscaling factor is set to 2.

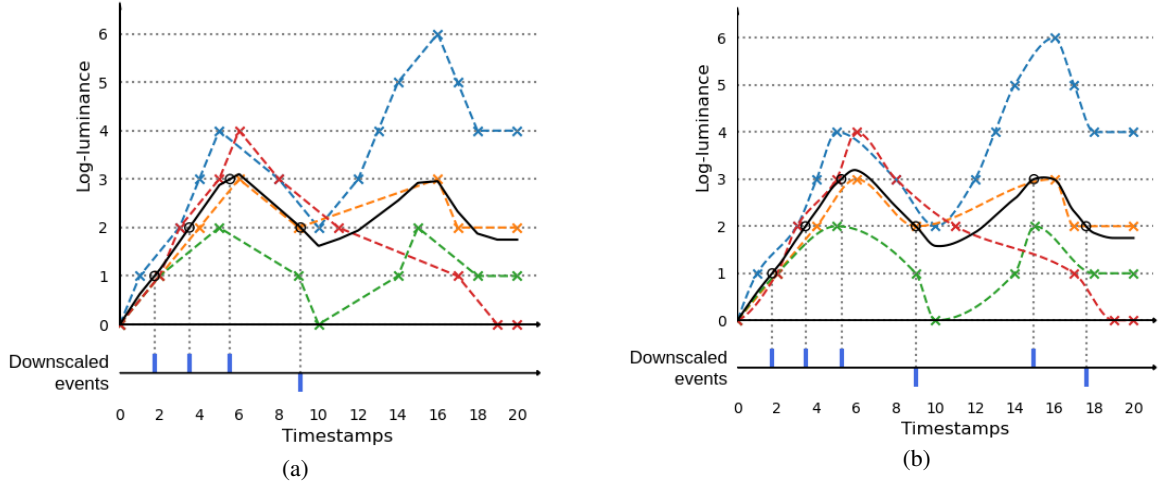

Figure 5: Schematic illustration for log-luminance reconstruction. A sensor of size 2×2 outputs negative and positive at each pixel across time, which are downscaled using log-luminance reconstruction with linear (a) and cubic (b) interpolation. In this example, the downscaling factor is set to 2.

3.2.1 Event Count

A first approach to log-luminance reconstruction consists in estimating the mean log-luminance reached by a downsampled pixel every time an event occurs in the corresponding fullscale region - in other words, realise a normalised event count in the fullscale region as presented in Fig. 4. If its value crosses a contrast threshold, an event is produced; an additional value keeps track of the slope, in order to set this event's polarity depending on the slope. It is also necessary to handle the constraint posed by the fact that an event is only produced if the entire threshold has been covered since the last event. The slope value allows to answer this by identifying the extrema, thus preventing events to occur when the log-luminance crosses a threshold directly following an extremum.

This approach's main disadvantage is the loss of neuromorphic asynchronicity. A reduced event can only occur at the timesteps where a fullscale event took place, which wouldn't be the case with actual log-luminance reconstruction, as depicted in the following paragraphs. This drawback is also an asset: this reduction method can easily downscale events as they are being recorded, and its algorithm simplicity is a plus for an embedded system.

3.2.2 Linear Estimation

The second approach is to actually reconstruct the log-luminance curve as a polyline, where each event in the log-luminance graph is linked to its neighbors in time by a line as presented in Fig. 5a. This allows for a quick computation and interpolation of the inter-

sections between the thresholds and the curve. However, it is not as faithful to the physical reality as we would like it to be.

3.2.3 Cubic Estimation

In this final approach, the log-luminance of each neuron is interpolated as a cubic curve strictly running through the events on the log-luminance graph as seen in Fig. 5b. The cubic interpolation was implemented using *Scipy's* method *PChipInterpolator*, an implementation of the Piecewise Cubic Hermite Interpolating Polynomial. This algorithm is a third-degree piecewise polynomial function which seeks to match the derivatives of each point with its neighbors. Thus its extrema coincide with the data's extrema, which is not the case of all cubic interpolation algorithm who tend to greatly overshoot (Rabbath and Corriveau, 2019). As similar tools, this cubic interpolator I takes as input a set of values (x, y, x') and returns the y' data interpolated for all x' values with respect to the relation between y and x :

$$I(x, y, x') = y' \quad (3)$$

$$\text{with } x' = \sum_{x=x_{min}/threshold}^{x_{max}/threshold} (x)$$

In our case, the coordinates are those of the events in the corresponding log-luminance graph: the x -axis correspond to the events' log-luminance and the ordinates to the timestamps. From a set of known log-luminance levels x' , the cubic interpolation outputs the timestamps y' where the events' log-luminance crosses those levels.

This approach reconstructs a curve close to an actual log-luminance curve recorded by an event camera, granting a high score of optical consistency to this approach. However, the existing tools allowing the cubic interpolation of y values according to a set of x parameters requires the x set to be strictly monotonous, without any duplicates. The first hinder can be removed by splitting the (x, y) dataset presented in Eq. 3 at the different log-luminance’s extrema:

$$S_i(x, y) = \sum_{t=t_{y_{ext_i}}^{y_{ext_{i+1}}}} (x_t, y_t) \quad (4)$$

with S_i the i^{th} subset of the events comprised between two extrema, n_{ext} the total number of extrema in the dataset i.e. the number of segments S_i , and $t_{y_{ext_i}}$ and $t_{y_{ext_{i+1}}}$ respectively the timestamps of the i^{th} and $(i + 1)^{th}$ extrema.

The second hinder mentioned above is more complex to avoid: although it is a rare occurrence, multiple events still happen at the same coordinates and in the same timestamps with a frequency of X . This requires us to only keep one specimen of duplicates, thus lightly skewing the data processing.

Furthermore, it shares one disadvantage with the linear estimation approach: both those approach cannot be computed strictly in real time since they need to know the future behavior of the curve, that is to say the next events that will occur on the monitored pixel. We can work around this problem by inserting a slight delay between the data recording and processing.

3.3 Events to video to events

Since it is possible to reconstruct a grayscale video from an event stream, a last simple technique would be to use existing downscaling methods on a grayscale reconstruction of the event data, then translate this reduced image back into events. This is equivalent to reconstructing a downscaled luminance and computing downscaled events from it, but it has some important drawbacks. The main one lies in the total loss of event data’s asynchronicity since the grayscale video produced from the neuromorphic data is built from the pooling of information into frames.

Moreover, its implementation in practice is computationally heavy, which is not suited for embedded applications. Lastly, this method needs two sets of grayscale data to be created during the process (fullscale from events, then downscale) leading to high memory consumption, while embedded systems are limited in data storage.

A pipeline implementing such a downscaling process is the following:

1. translate the event data into grayscale frames thanks to *Events-to-Video* library introduced in (Rebecq et al., 2019). This module actually consists in a machine learning model trained on a set of datasets comprising neuromorphic and grayscale recordings of the same scenes.
2. rescale the grayscale frames thus obtained with one of the many existing image processing tools.
3. finally translate the downscaled grayscale frames into events by using the library *Video-to-Events* from (Gehrig et al., 2020). This library reconstructs the log-luminance variations between each grayscale frame, then outputs the corresponding events according to user-defined negative and positive contrast thresholds.

This pipeline requires the event dataset to be downscaled either to be one of the datasets the *Events-to-Video* model has been trained on, or to contain a set of grayscale frames recorded simultaneously as the neuromorphic data. Since this method is very arguable considering the motivations for event downscaling, it was not implemented to be compared in this paper. Note that the dataset used in our experiments (see Section Datasets) does not meet either of these two criteria.

4 EXPERIMENTS

4.1 Datasets

The different methods of reduction where applied to the neuromorphic dataset *DVS128 Gesture* widely

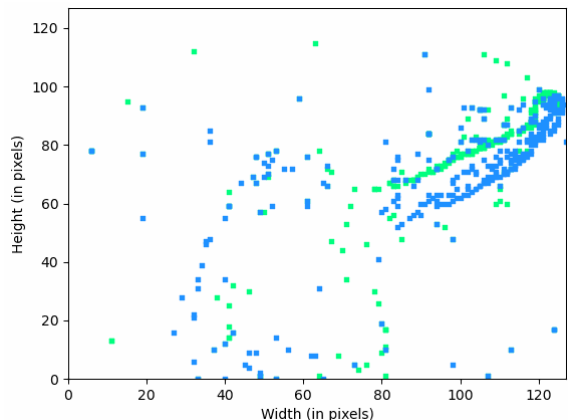

Figure 6: Events grouped in a frame from a sample of the gesture "left hand clockwise" (class 7) of the *DVS128 Gesture* dataset. Positive events are depicted in green, negative in blue.

Table 1: Features of the original DVS128 Gesture dataset, and of the 5 downscaling methods described in Section 3.

Methods	Number of events	Temporal density	Information entropy	Computation time	Optical consistency
Original fullscale data	194,398	$1.95e^{-7}$	$2.94e^{-6}$	-	-
Simple Event Funnelling	186,414	$2.95e^{-6}$	$3.65e^{-5}$	103.20 ms	*
Tonic Downscale	194,312	$5.40e^{-5}$	$4.31e^{-4}$	3.20 ms	*
Log-luminance					
Event Count	7,778	$1.25e^{-7}$	$1.88e^{-6}$	0.83 s	**
Linear Estimation	624	$8.58e^{-9}$	$1.56e^{-7}$	2.63 s	***
Cubic Estimation	435	$8.92e^{-9}$	$1.66e^{-7}$	2.94 s	****

used as a benchmark in event data processing, and we assessed the results according to the criteria described in the following sections.

Hand gesture recognition is a skill used daily in the human society and is tightly integrated with verbal communication, hence the need of computational learning of such data. Since it relies heavily low latency, this task is well suited for event-based computation. Building on this notion, Amir et al. presented at CVPR 2017 a complete hand gesture neuromorphic dataset called *DVS128 Gesture* (Amir et al., 2017). To this end, 29 subjects were recorded performing 11 different hand gestures under 3 kinds of illumination conditions, by a DVS128 camera (see Fig 6). A total of about 133 samples are available for each gesture, each composed roughly of 400,000 events and of dimension 128×128 pixels, for a duration of 6 seconds approximately. The dataset is split in two sub-datasets to facilitate machine learning training: the train sub-category received 80% of the recorded samples and the test 20%, with an even distribution of the 11 gestures between them.

This dataset was chosen according to its relevance to our motivations: DVS128 Gesture represents dynamic information to be processed temporally, which would be the case in most embedded systems.

4.2 Comparison

Table 1 compares between the 6 methods presented above and with the *Tonic*'s "Downsample" tool according to 5 criteria described in the following section.

Number of events The mean number of events per sample was calculated over the whole *DVS28 Gesture* dataset at fullscale and downscaled by the 7 methods mentioned in Table 1.

Temporal density Events temporal density D corresponds to the activation probability of pixels averaged over the whole sensor:

$$D = \frac{\sum_{x=0}^w \sum_{y=0}^h P_{x,y}}{w \cdot h} \quad (5)$$

with w and h respectively the width and height of the sensor. The activation probability $P_{x,y}$ is calculated as the number of events (positive or negative) occurring at a given pixel divided by the time length of the sample:

$$P_{x,y} = \frac{\sum_{t=t_{min}}^{t_{max}} \delta(x_t, x) \cdot \delta(y_t, y)}{t_{max} - t_{min}} \quad (6)$$

with $P_{x,y}$ the activation probability of one pixel of coordinates (x, y) , t_{min} and t_{max} respectively the minimum and maximum timestamp of the sample, and δ the Kronecker delta function, which returns 1 if the variables are equal, and 0 otherwise.

Information entropy If we consider the information brought by positive (or negative) events according to Shannon's information theory, we can estimate the entropy H of the dataset as the average over all pixels and polarities p of the entropy $H_{x,y,p}$:

$$H = \frac{\sum_{p \in \{-, +\}} \sum_{x=0}^w \sum_{y=0}^h H_{x,y,p}}{2 \cdot w \cdot h} \quad (7)$$

with $H_{x,y,p} = \sum_{P_e \in \{P_{x,y,p}, \overline{P_{x,y,p}}\}} -P_e \cdot \log_2(P_e)$

where $P_{x,y,p}$ is the probability of *event* (probability for the pixel of being active), and $\overline{P_{x,y,p}} = 1 - P_{x,y,p}$ is the dual probability of *no event*, for the polarity p at location (x, y) . $H_{x,y,p}$ becomes lower when the pixel is either never active or always active. Entropy values in Table 4.2 are averaged from both polarities.

Computation time The computation time of each method presented in this paper was calculated on a panel of over 500,000,000 events. The values presented in the Table 1 correspond to the average calculation period for the downscaling of 100,000 events, expressed in seconds.

It should be noted that the values produced for the SNN Pooling method are not obtained from the similar panel of event data as the other. As a matter of fact, since the computation time for one sample using either technique exceeds 10 min, we chose to assess our criteria on a small set of downsampled events using SNN Pooling.

The values of these criteria confirm the hypotheses we outlined above. *Tonic*'s "Downscale" method has the highest number of events, thus the highest event density; this spatial reduction does not lead to a significant drop of event flow, thus does not answer our need for reduced data to handle. The same goes for the Simple Event Funneling, which does ignore all event duplicates. Even though the computation time of those two methods is low, the output data is too important to be processed more efficiently than the original one. We should also point out that their information entropy is quite low, due to the constant activation of the sensor's pixels.

The log-luminance techniques are the most consistent with the optical reality behind event data recording. It drops a large amount of data, thus significantly improving any embedded computation, while maintaining a relatively high level of information entropy. SNN Pooling is also promising by its behavior closely related to one of an event-camera, but it is extremely sensible to the weight of its connection: here the weight is probably too high hence its poor results. We intend to take advantage of the high computational efficiency offered by SpiNNaker (Furber et al., 2013) or Loihi (Davies et al., 2018) in order to assess the optimal hyperparameters.

5 Conclusion

Event cameras take an increasing part in current trend in computer vision, with a number of possible applications in robotics and autonomous driving. While standard frame-based data (grayscale and RGB) are easily downscaled – which is a very common pre-processing step, there currently exists no straightforward equivalent for event data.

In this paper, we introduce and compare 7 methods for event data downscaling for embedded computer vision applications. Our results show that the

choice of the reduction methods greatly influences the event features of the reduced dataset, namely the number of events, the density, and information entropy. The proposed methods offer a panel of solutions to choose from depending on the target task (classification, detection, tracking, etc.)

Our future work include the assessment of the proposed methods on a classical computer vision tasks such as classification, in order to evaluate the accuracy loss brought by the proposed methods. Along this line of research, we intend to develop event reduction using spiking neural networks, a relevant spatial downscaling method for the neuromorphic processing of event based data. This new type of asynchronous artificial neural network is closer to biology than traditional artificial networks, mainly because they seek to mimic the dynamics of neural membrane and action potentials over time. The Leaky Integrate-and-Fire neuron model more specifically simulates the increase of the membrane potential lead by the frequency of input spikes coupled with a constant slow decrease. We believe that this mechanism is well suited to implement an event downscaling method which temporally pools input events. Preliminary results lead us to understand that hyperparametrisation may have a significant influence on this preprocess, which we would like to discuss in the foreseeable future. Besides, one important aspect for real time applications is the ability of the proposed methods to operate in real time, so as to directly reduce the input event flow and save compute, memory and energy in embedded systems. Therefore we will evaluate the real time capability of the methods. A relevant application of the proposed methods is to implement a foveation mechanism, such as in (Gruel et al., 2021). Finally, it will be useful to extend the spatial downscaling to temporal downscaling to further adjust the density of event flow.

ACKNOWLEDGEMENTS

This work was supported by the European Union's ERA-NET CHIST-ERA 2018 research and innovation programme under grant agreement ANR-19-CHR3-0008.

The authors are grateful to the OPAL infrastructure from Université Côte d'Azur for providing resources and support.

REFERENCES

- Amir, A., Taba, B., Berg, D., Melano, T., McKinstry, J., Di Nolfo, C., Nayak, T., Andreopoulos, A., Garreau, G., Mendoza, M., Kusnitz, J., Debole, M., Esser, S., Delbruck, T., Flickner, M., and Modha, D. (2017). A Low Power, Fully Event-Based Gesture Recognition System. In *Computer Vision and Pattern Recognition (CVPR)*, pages 7388–7397, Honolulu, HI. IEEE.
- Bi, Y., Chadha, A., Abbas, A., Boursoulatzé, E., and Andreopoulos, Y. (2019). Graph-based object classification for neuromorphic vision sensing.
- Chin, T.-J., Bagchi, S., Eriksson, A., and Schaik, A. V. (2019). Star tracking using an event camera. *2019 IEEE/CVF Conference on Computer Vision and Pattern Recognition Workshops (CVPRW)*.
- Cohen, G., Afshar, S., van Schaik, A., Wabnitz, A., Bessell, T., Rutten, M., and Morreale, B. (2017). Event-based sensing for space situational awareness.
- Cordone, L., Miramond, B., and Ferrante, S. (2021). Learning from Event Cameras with Sparse Spiking Convolutional Neural Networks. In IEEE, editor, *International Joint Conference On Neural Networks 2021 (IJCNN 2021)*, page 8, Conférence virtuelle, China.
- Davies, M., Srinivasa, N., Lin, T.-H., Chinya, G., Cao, Y., Choday, S. H., Dimou, G., Joshi, P., Imam, N., Jain, S., Liao, Y., Lin, C.-K., Lines, A., Liu, R., Mathaikutty, D., McCoy, S., Paul, A., Tse, J., Venkataraman, G., Weng, Y.-H., Wild, A., Yang, Y., and Wang, H. (2018). Loihi: A neuromorphic many-core processor with on-chip learning. *IEEE Micro*, 38(1):82–99.
- Fang, W., Yu, Z., Chen, Y., Masquelier, T., Huang, T., and Tian, Y. (2021). Incorporating learnable membrane time constant to enhance learning of spiking neural networks. In *International Conference on Computer Vision (ICCV)*, pages 2661–2671.
- Furber, S. B., Lester, D. R., Plana, L. A., Garside, J. D., Painkras, E., Temple, S., and Brown, A. D. (2013). Overview of the spinnaker system architecture. *IEEE Transactions on Computers*, 62(12):2454–2467.
- Gallego, G., Delbruck, T., Orchard, G., and al. (2020). Event-based vision: A survey. *IEEE Transactions on Pattern Analysis and Machine Intelligence*.
- Gehrig, D., Gehrig, M., Hidalgo-Carrió, J., and Scaramuzza, D. (2020). Video to events: Recycling video datasets for event cameras. In *IEEE Conf. Comput. Vis. Pattern Recog. (CVPR)*.
- Glover, A. and Bartolozzi, C. (2016). Event-driven ball detection and gaze fixation in clutter. *2016 IEEE/RSJ International Conference on Intelligent Robots and Systems (IROS)*.
- Gruel, A., Martinet, J., Linares-Barranco, B., and Serrano-Gotarredona, T. (2021). Stakes of foveation on event cameras. In *ORASIS 2021*, Saint Ferréol, France. Centre National de la Recherche Scientifique [CNRS].
- Huang, C. (2021). Event-based timestamp image encoding network for human action recognition and anticipation. In *2021 International Joint Conference on Neural Networks (IJCNN)*, pages 1–9.
- Kim, H., Leutenegger, S., and Davison, A. J. (2016). Real-time 3d reconstruction and 6-dof tracking with an event camera. *Computer Vision – ECCV 2016 Lecture Notes in Computer Science*, page 349–364.
- Lagorce, X., Ieng, S.-H., Clady, X., Pfeiffer, M., and Benosman, R. (2015). Spatiotemporal features for asynchronous event-based data. *Front. Neurosci. - Neuromorphic Engineering*.
- Lenz, G., Chaney, K., Shrestha, S. B., Oubari, O., Picaud, S., and Zarrella, G. (2021). Tonic: event-based datasets and transformations. Documentation available under <https://tonic.readthedocs.io>.
- Lichtsteiner, P., Posch, C., and Delbruck, T. (2008). A 128x128 120 db 15 us latency asynchronous temporal contrast vision sensor. *IEEE Journal of Solid-State Circuits*.
- Mahowald, M. and Mead, C. (1991). The Silicon Retina. *Sci. American*.
- Orchard, G., Benosman, R., Etienne-Cummings, R., and Thakor, N. V. (2013). A spiking neural network architecture for visual motion estimation. *2013 IEEE Biomedical Circuits and Systems Conference (BioCAS)*.
- Paredes-Valles, F., Scheper, K. Y. W., and Croon, G. C. H. E. D. (2020). Unsupervised learning of a hierarchical spiking neural network for optical flow estimation: From events to global motion perception. *IEEE Transactions on Pattern Analysis and Machine Intelligence*, 42(8):2051–2064.
- Rabbath, C. and Corriveau, D. (2019). A comparison of piecewise cubic hermite interpolating polynomials, cubic splines and piecewise linear functions for the approximation of projectile aerodynamics. *31st International Symposium on Ballistics*.
- Rebecq, H., Horstschaefer, T., and Scaramuzza, D. (2017). Real-time visual-inertial odometry for event cameras using keyframe-based nonlinear optimization.
- Rebecq, H., Ranftl, R., Koltun, V., and Scaramuzza, D. (2019). Events-to-video: Bringing modern computer vision to event cameras. *IEEE Conf. Comput. Vis. Pattern Recog. (CVPR)*.
- Rebecq, H., Ranftl, R., Koltun, V., and Scaramuzza, D. (2021). High speed and high dynamic range video with an event camera. *IEEE Transactions on Pattern Analysis and Machine Intelligence*, 43(6):1964–1980.
- Vidal, A. R., Rebecq, H., Horstschaefer, T., and Scaramuzza, D. (2018). Ultimate slam? combining events, images, and imu for robust visual slam in hdr and high-speed scenarios. *IEEE Robotics and Automation Letters*, 3(2):994–1001.
- Zhang, L., Zhang, H., Zhu, C., Guo, S., Chen, J., and Wang, L. (2021a). Fine-grained video deblurring with event camera. In Lokoč, J., Skopal, T., Schoeffmann, K., Mezaris, V., Li, X., Vrochidis, S., and Patras, I., editors, *MultiMedia Modeling*, pages 352–364, Cham. Springer International Publishing.
- Zhang, Z., Yezzi, A., and Gallego, G. (2021b). Image reconstruction from events. why learn it? *arXiv:2112.06242*.