



HAL
open science

Analysis of SET Propagation in a System in Package Point of Load Converter

T. Rajkowski, Frédéric Saigné, Vincent Pouget, F. Wrobel, A. Touboul, J. Boch, P. Kohler, P. Dubus, P. X. Wang

► **To cite this version:**

T. Rajkowski, Frédéric Saigné, Vincent Pouget, F. Wrobel, A. Touboul, et al.. Analysis of SET Propagation in a System in Package Point of Load Converter. IEEE Transactions on Nuclear Science, 2020, 67 (7), pp.1494-1502. 10.1109/TNS.2020.2992808 . hal-03671272

HAL Id: hal-03671272

<https://hal.science/hal-03671272v1>

Submitted on 19 May 2022

HAL is a multi-disciplinary open access archive for the deposit and dissemination of scientific research documents, whether they are published or not. The documents may come from teaching and research institutions in France or abroad, or from public or private research centers.

L'archive ouverte pluridisciplinaire **HAL**, est destinée au dépôt et à la diffusion de documents scientifiques de niveau recherche, publiés ou non, émanant des établissements d'enseignement et de recherche français ou étrangers, des laboratoires publics ou privés.

Analysis of SET propagation in a system in package point of load converter

T. Rajkowski, F. Saigné, V. Pouget, F. Wrobel, A. Touboul, J. Boch, P. Kohler, P. Dubus and P. X. Wang

Abstract— Power cycling of the Point-of-Load converter is observed during system level heavy ions tests. This event has low cross section and is observed for reduced supply voltage of device under test. Laser tests are used to reproduce this effect and show that it might be due to propagation of single event transients from the voltage reference to operational amplifier being part of the undervoltage protection circuit. Laser tests show that propagating transients are the ones with high enough positive peak and insignificant negative peak value whereas some transients with bigger maximum and/or peak to peak value do not propagate. SPICE simulation shows that in operational amplifier with low voltage difference between V_+ and V_- , there is difference in propagation of unipolar and bipolar transients from input to output of the amplifier. Analysis of the voltage controlled current source in the amplifier explains also difference in propagation of bipolar transients with negative peak followed by positive peak and with positive peak followed by negative peak.

Index Terms— single event transients, laser tests, heavy ions tests, transient propagation, system-level tests

I. INTRODUCTION

Single event transient (SET) generation and propagation in analog systems is a known problem, of a special concern in power supply components and systems. SETs on output of power supply may lead to damage or intermittent work of the device that is supplied [1]. SET in the internal circuitry of power supply may lead to e.g. unexpected power shutdowns [2].

The goal of this work is to investigate a phenomenon observed during heavy ion irradiation of a Point of Load (PoL) converter. We have shown in this paper that the effect observed is the power cycling of the device under test (DUT), induced by a SET. Analysis of the PoL converter schematics leads to the conclusion that the most probable source of the power cycling is due to triggering of UnderVoltage Protection (UVP) circuit. Complementary laser tests were then performed on voltage reference and main part of the UVP trigger circuit (operational amplifier, OpAmp), to understand the processes at play.

Using laser tests, we have shown that propagation of SET from voltage reference to OpAmp output is possible and it may lead to power cycling of the DUT in specific supply conditions. The worst case SET observed in our system is not the one with maximum amplitude, as is commonly described in the literature [3]–[9]. In our results, SET with high enough positive peak and

T. Rajkowski is with 3DPlus, 408 rue Hélène Boucher, 78532 Buc, France and with IES, University of Montpellier, CNRS, Montpellier, France, trajkowski@3d-plus.com

F. Saigné, V. Pouget, F. Wrobel, A. Touboul and J. Boch are with IES, University of Montpellier, CNRS, Montpellier, France

P. Kohler, P. Dubus and P. X. Wang are with 3DPlus, 408 rue Hélène Boucher, 78532 Buc, France

insignificant negative peak value are shown to be the only able to propagate up to the output of the circuit.

We then have used SPICE simulation to explain how changing voltage difference on inputs of OpAmp enable propagation of transients observed during laser tests. It also explains processes inside OpAmp chip leading to propagation or no propagation of different types of SET during laser tests and heavy ions tests.

II. EXPERIMENT DESCRIPTION

A. Device under test

DUT is the prototype board of PoL converter, electrically and functionally equivalent with 3DPM-0024 module from 3D-Plus. Block diagram of DUT is presented on Fig 1. Main focus of this work was put on analysis of effects inside the UVP circuit and the reference voltage chip. The UVP circuit (Fig. 2) is based on OpAmp chip (IC2). Supply voltage (V_{IN}) of the DUT is divided by voltage divider (R1 and R2) and connected to the non-inverting input of OpAmp. Reference voltage from VRef (IC1) is directly connected to the inverting input of OpAmp. In nominal operating conditions, the voltage value at non-inverting input of OpAmp is above VRef (and OpAmp output is driven high).

B. Heavy ion tests at CHARM facility

The DUT was tested with high energy (5.4 GeV/n), low Linear Energy Transfer (LET) ($8.0 \text{ MeV} \cdot \text{cm}^2/\text{mg}$) and high flux

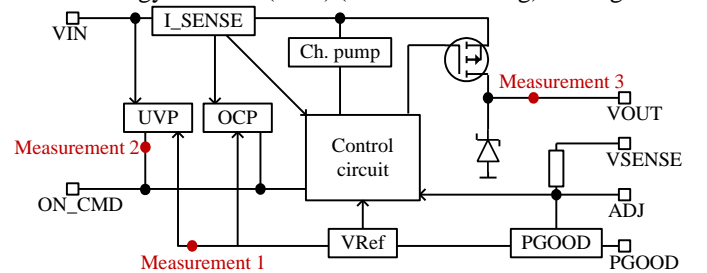

Fig. 1. DUT block diagram (3 measurement points refer to laser tests).

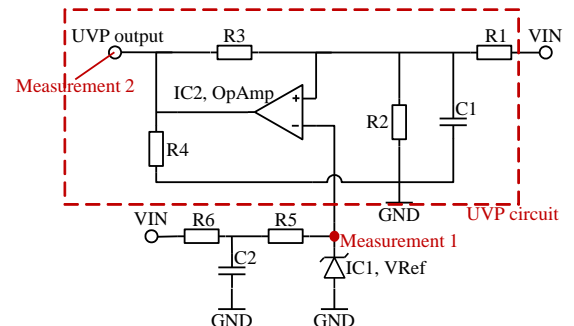

Fig. 2. Electrical drawing of the UVP circuit of DUT.

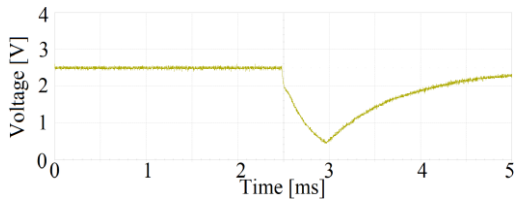

Fig. 3. Output voltage of DUT during an SET-induced power cycling observed under heavy-ions.

($\sim 5 \times 10^4$ ions/cm²/s) Pb ions at CHARM facility (CERN) [10][11]. The beam flux was not constant - ions were delivered in spills with flux of about $\sim 0.5\text{-}4 \times 10^6$ ions/cm²/spill, with spill duration of about 200 ms, repeated every 5 to 60 seconds. Supply voltage used was 5.3 V, but due to setup characteristics (supply cables ~ 30 m long, leading to voltage drop and infeasibility of use of 4-wire connecting) the voltage at board level was ~ 4.6 V. Higher supply voltage was not used in order to not damage the DUT with too high voltage when switching on the device (for the short time after switching on the DUT, current draw is low, there is no significant voltage drop on cables and voltage at the board level is close to the supply voltage level).

One of the rare events observed during test was power cycling of the DUT: output voltage of the DUT was switching (Fig. 3). The calculated cross-section for this event is between 1.3×10^{-8} and 2.3×10^{-8} cm². For comparison, the cross-section for SETs observed at output of voltage reference chip is in order of $\sim 1 \times 10^{-5}$ cm². The source of the power cycling event remained unknown after heavy ion test campaign. Analysis of the DUT schematics and of the output voltage switching sequence suggested that the most probable reason of the event is activation of the UVP circuit.

C. Laser tests

In order to better understand events observed during heavy ion tests, laser tests of VRef and OpAmp chips were performed with use of single photon laser facility of the IES PRESERVE platform of the University of Montpellier. Laser pulse energies between 150 pJ and 500 pJ were used. Both IC1 and IC2 were tested with laser, from the front side of the chip. Due to the low metal-coverage of those devices, this approach was assumed to be sufficient to reveal the mechanisms under investigation while reducing the sample preparation and board adaptation costs. Three types of signals were measured and recorded during laser tests: VRef output (with record of SETs), OpAmp

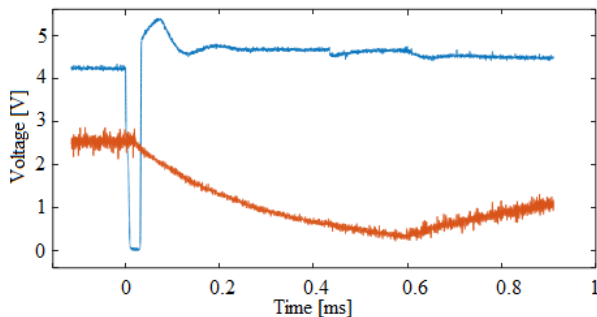

Fig. 4. OpAmp output (blue) and PoL output (red) voltage waveforms recorded during power cycling caused by SET propagation from IC1. Waveforms recorded during laser tests.

output (UVP output from Fig. 2) and PoL output – those measurement points were marked on Fig. 1 and Fig. 2.

Laser testing of IC2 was performed with laser energy of 500 pJ and the DUT was supplied with nominal voltage of 5 V (~ 4.6 V measured on board - this corresponds to the voltage during CHARM tests). No power cycling event was observed after scan of the whole chip die with laser pulses.

Similar scan with laser pulses was performed for IC1 chip, also no power cycling event was observed. At this point, supply voltage was reduced down to 4.87 V (4.43 V measured directly on the DUT board, which is close to the threshold of acceptable input voltage of the UVP, decreasing this value by few mV triggers the UVP). 4.43V voltage level is below specified supply voltage for the DUT, but is within supply voltage ranges specified for IC1 and IC2. Testing at this new supply voltage level let find areas of the IC1 chip die producing specific SETs, which were propagating through OpAmp and switching output of OpAmp, resulting in power cycling of the DUT (Fig. 4).

It was checked that propagation of those SETs was not correlated with the phase of operation of the PoL converter – for more than 10 laser pulses hitting single specific point of the die at random time, each of them was leading to power cycling of the DUT. The threshold laser energy to induce such SETs was measured at 150 pJ.

III. LASER TESTS RESULTS ANALYSIS AND DISCUSSION

To understand what kind of SETs are propagating from VRef through to OpAmp and result in power cycling of PoL converter output, different parameters of those SETs were calculated. All calculations presented in this section are based on data from tests with a laser energy of 300 pJ.

Figure 5 presents the laser mapping of maximum values of VRef output signals (measurement 1 on Fig. 1). Figure 6 presents the mapping of minimum values of the OpAmp output (measurement 2, blue curve in Fig. 4). Figure 7 presents the mapping of minimum values of the PoL output (measurement 3, red curve in Fig. 4).

During nominal operation of PoL, OpAmp output is close to supply voltage (4.43 V during this test) and PoL output is 2.5 V. Blue areas on Fig. 6 mean that OpAmp output signal was close to GND level, orange areas mean that OpAmp output signal was lower than nominally, but didn't reach less than

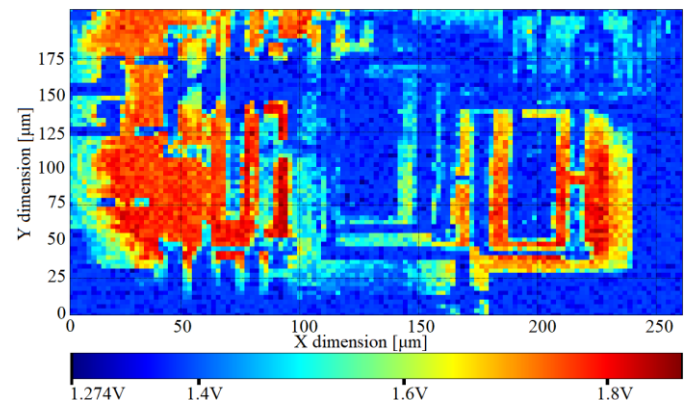

Fig. 5. Maximum values of VRef output (measurement 1) corresponding to laser pulse hits at different points of IC1 die.

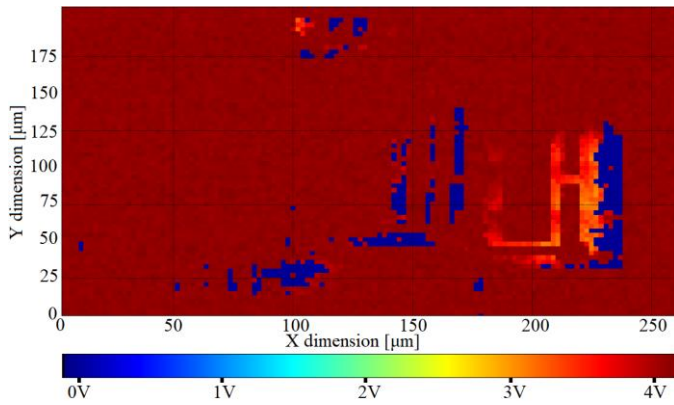

Fig. 6. Minimum values of OpAmp output (measurement 2) corresponding to laser pulse hits at different points of IC1 die.

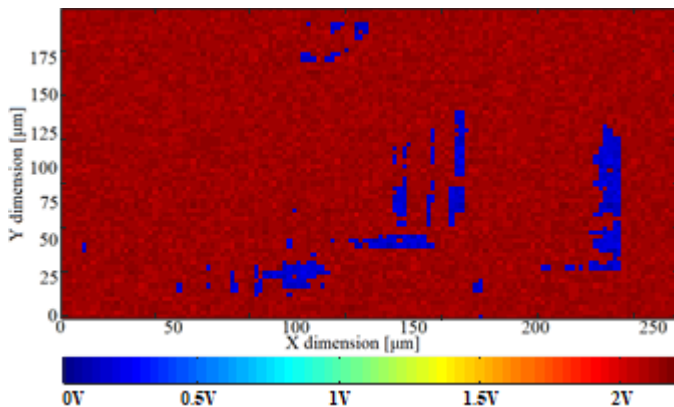

Fig. 7. Minimum values of PoL output (measurement 3) corresponding to laser pulse hits at different points of IC1 die.

about 2.5 V. Comparison of this result with mapping for measurement 3 (Fig. 7) shows that SET which propagated through OpAmp and forced it to reduce voltage to GND, also forced power cycling of PoL (low values on Fig. 6 (blue color) match low values on Fig. 7 (also blue color)). Such SET was called “propagating SET”. SETs which propagated through OpAmp but didn’t force it to reduce output voltage down to GND, didn’t provoke PoL power cycling. Those SETs were called “partially propagating SETs” (orange areas in Fig. 6 – corresponding points on Fig. 7 are dark red – PoL output value has nominal level).

Analysis of Fig. 5 shows that there are also many SETs generated at the output of the voltage reference by laser pulses

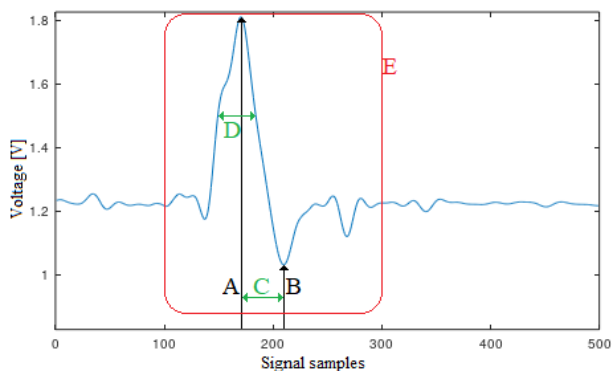

Fig. 8. Description of different parameters of SET that were calculated: A-maximum value, B-minimum value (measured from the level of 0V, not from average value of the waveform), C-delay between maximum and minimum peaks, D-SET width; average value was calculated basing on waveform range marked with letter E

hitting different parts of IC1 (all areas with color different than dark blue), which do not propagate to output of OpAmp – they were called “not propagating SETs”.

As it was mentioned in the introduction of this paper, in the literature, the maximum value is commonly used to characterize worst case SETs. Comparison of Fig. 5 with Fig. 6 and Fig. 7 shows that SETs which propagate in our system are not the ones with highest peak value. Further analysis was performed to investigate this unexpected behavior.

Different parameters of SET signals (measurement 1) were calculated in order to characterize SETs of different groups: minimum, maximum, average values, widths of SET peaks, delays between positive and negative peaks. See Fig. 8 for description of those parameters. The most important results are presented below.

Figures 9 and 10 present SET plots with minimum and maximum voltage value of each SET signal (measurement 1), both values are absolute values. For better readability, data sets are split between two plots: plot on figure 9 presents data for

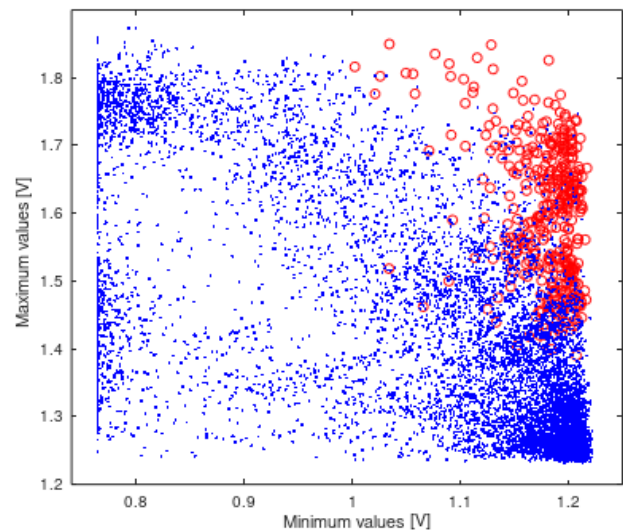

Fig. 9. SET plot presenting minimum and maximum voltage value of each signal from measurement 1. Not propagating SETs (blue color) and propagating SETs (red color) are plotted.

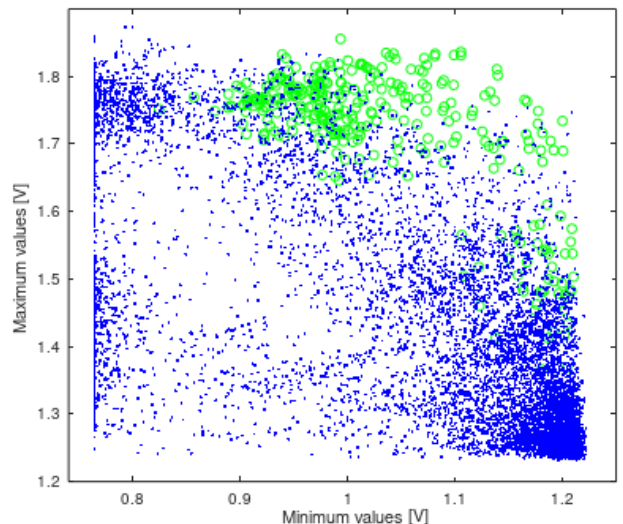

Fig. 10. SET plot presenting minimum and maximum voltage value of each signal from measurement 1. Not propagating SETs (blue color) and partially propagating SETs (green color) are plotted.

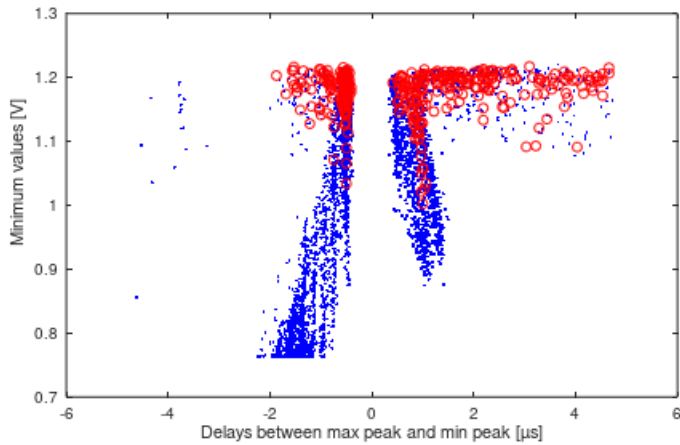

Fig. 11. SET plot presenting minimum voltage value of signals from measurement 1 and its delay between maximum and minimum value. Blue color corresponds to not propagating SETs, red to propagating SETs. For better readability, only signals with maximum value higher than 1.35V were plotted.

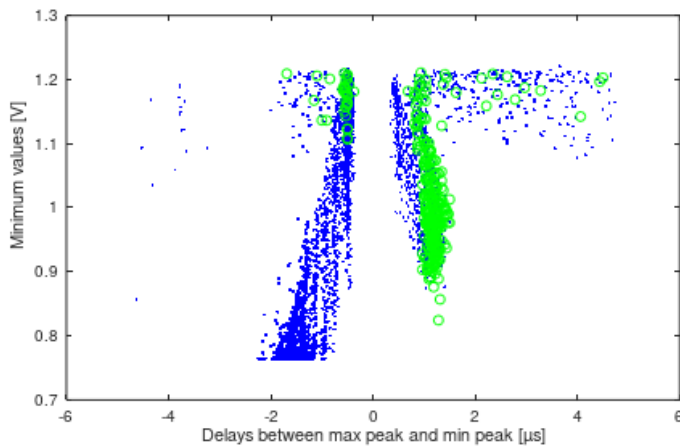

Fig. 12. SET plot presenting minimum voltage value of signals from measurement 1 and its delay between maximum and minimum value. Blue color corresponds to not propagating SETs, green to partially propagating SETs. For better readability, only signals with maximum value higher than 1.35V were plotted.

not propagating SETs (blue dots) and propagating SETs (red circles), whereas plot on figure 10 presents data for not propagating SETs (blue dots) and partially propagating SETs (green circles). According to these plots, propagating SETs (red circles) are the ones with maximum value of above ~ 1.4 V and minimum value usually not below 1.1 V (due to not strong minimum peak, their peak-to-peak value is usually low). Partially propagating SETs (green circles) usually have high maximum values and minimum values lower than propagating SETs (between 0.9 V and 1.1 V). However there is also small group of partially propagating SETs with parameters similar to propagating SETs. Not propagating SETs (blue dots) are of different types. There is big subgroup located in bottom right corner, that's area of SETs with small maximum and small minimum values – small positive peak and small negative peak. There is a big subgroup on left side of the plot – SETs with low minimum values and broad range of maximum values. There are also subgroups of not propagating SETs mixed with group of propagating SETs and group of partially propagating SETs.

Figures 11 and 12 present plots with same parameters on axes X and Y: minimum voltage value of each signal from

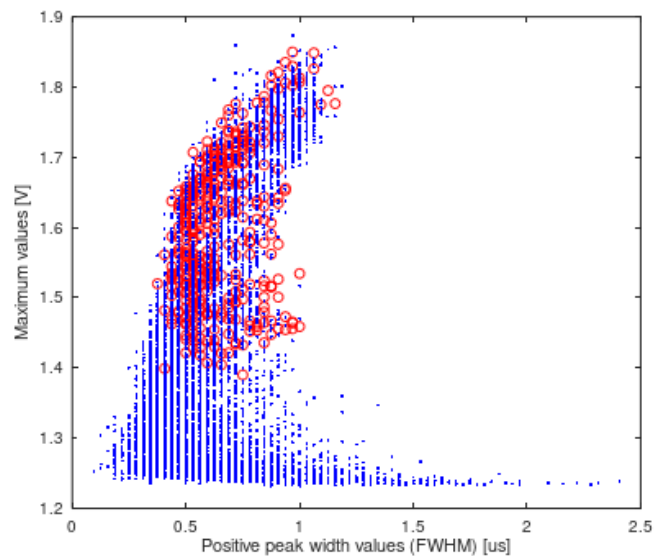

Fig. 13. SET plot presenting maximum voltage value and positive peak width value (full width at half maximum, FWHM) of signals from measurement 1. Not propagating SETs (blue color) and propagating SETs (red color) are plotted.

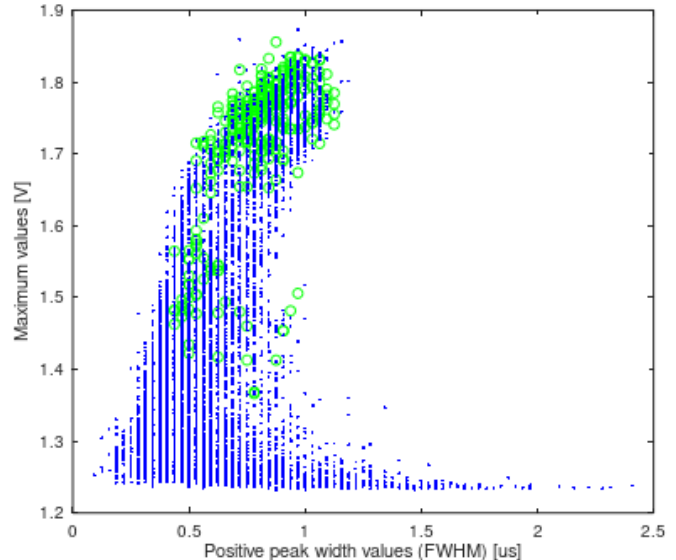

Fig. 14. SET plot presenting maximum voltage value and positive peak width value of signals from measurement 1. Not propagating SETs (blue color) and partially propagating SETs (green color) are plotted.

measurement 1 and its delay between maximum and minimum value. This delay represents delay between highest positive and lowest negative peak in the signal, delay less than 0 means that lowest negative peak is before highest positive peak. For better readability, only signals with maximum value higher than 1.35 V were plotted, this includes all propagating SETs, all partially propagating SETs and 57% of not propagating SETs.

According to figures 11 and 12, propagating SETs have their negative peak in different points before or after positive peak, but the common characteristics is - as it was already mentioned - that the negative peak is not very deep in this kind of SETs. Contrary, most of partially propagating SETs have their negative peak at specific point after positive peak and the negative peak is quite deep (down to ~ 0.85 V).

Figures 13 and 14 present SET plots with maximum voltage value and positive peak width value of each signal from

measurement 1. It might be observed that SET plots presenting maximum voltage value and positive peak width value do not allow to differentiate propagating (or partially propagating) SETs from not propagating SETs and they do not allow to define a template for propagation. Analysis of Fig. 9-12 shows that the most important parameters used to distinguish SETs of different groups are minimum, maximum values and delay between maximum and minimum value.

Presented laser test results show that the peak to peak value or maximum value of SET are not the point to state that we have a propagating signal. SETs that propagated in the IC and whole system are the ones with high enough positive peak and insignificant negative peak value.

IV. SPICE SIMULATIONS

Experimentally we have seen that those SET propagation occurs for a specific supply voltage. In order to evaluate the influence of the supply voltage on the SETs propagation, LTSpice simulation has been used. For OpAmp chip, original SPICE model provided by the manufacturer of the chip was used. VRef chip was replaced in simulations by voltage source reproducing different kinds of transients (triangle-shaped transient signals were used with slew rate of $0.4 \text{ V}/\mu\text{s}$). Schematics of circuit model used for SPICE simulations were presented in figure 15. Supply voltage used during described simulations was 4.442 V and it was just above the threshold of activation of undervoltage protection – reducing the VIN voltage in simulation by 0.2 mV was leading to activation of UVP circuit without any SET at VRef node.

Simulations show that strong reduction of supply voltage, and resulting reduction of voltage difference on inputs of OpAmp, enable propagation of transients similar to observed during laser tests (SET sensitivity of comparator working in similar conditions was described in [12]). Analysis of the OpAmp SPICE model (OP484) shows that important in understanding this effect is the role of voltage controlled current source (VCCS) at output stage of OpAmp. This VCCS is modelling the transformation of voltage from first and second stage of the OpAmp and is directly connected to capacitance of output stage and indirectly controls output transistor of OpAmp. If difference between input voltages is big, then VCCS is fully charging or discharging that capacitance. But if this difference is small, then that capacitance is partially charged and the base voltage of the output transistor is close to the switching threshold between cut-off state and active state. In this case,

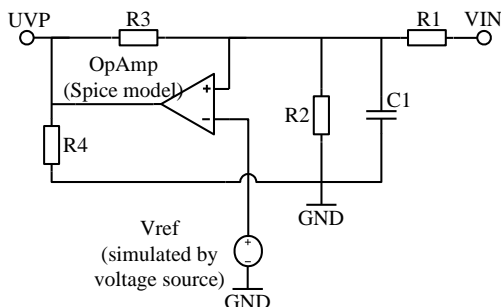

Fig. 15 Schematics of circuit model used for SPICE simulations.

even small SET might be enough to force VCCS to charge capacitance of the output stage and raise base voltage of the output transistor and switch it to active state – and thus switch the output of OpAmp.

SPICE simulation results showing propagation of SET are presented on figure 16. SET at VRef (green color) has maximum value of 1.7 V and the FWHM width is $0.625 \mu\text{s}$. During the positive peak of SET, the VCCS starts to drive the current (orange color) and to charge capacitors on VCCS output (blue color). This is followed by increase of the voltage on output transistor base (black color), resulting in switching the output of OpAmp (magenta color). Propagating SETs with signature as on figure 16 (with positive peak only) were observed during laser tests.

Figure 17 presents simulation results for not propagating SET with negative peak going to 0.7 V (FWHM width $0.625 \mu\text{s}$)

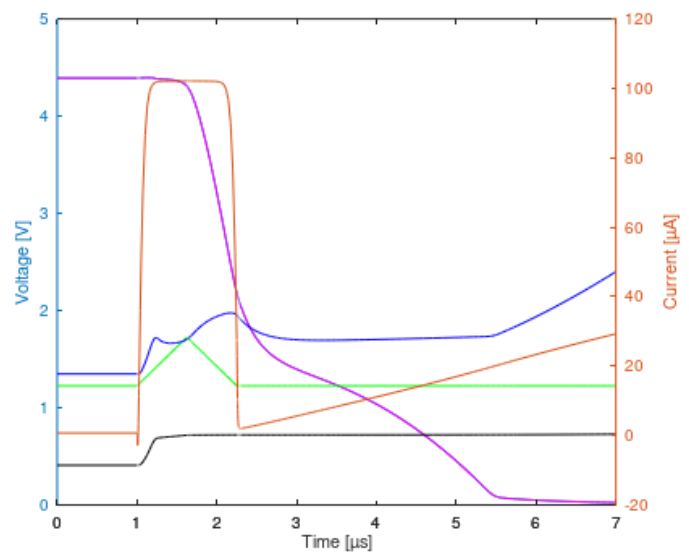

Fig. 16. Plot with different waveforms obtained during SPICE simulation of propagating SET: VRef voltage (green), OpAmp output (magenta), VCCS output voltage - capacitance of the output stage (blue), OpAmp output transistor base voltage (black), VCCS current (orange).

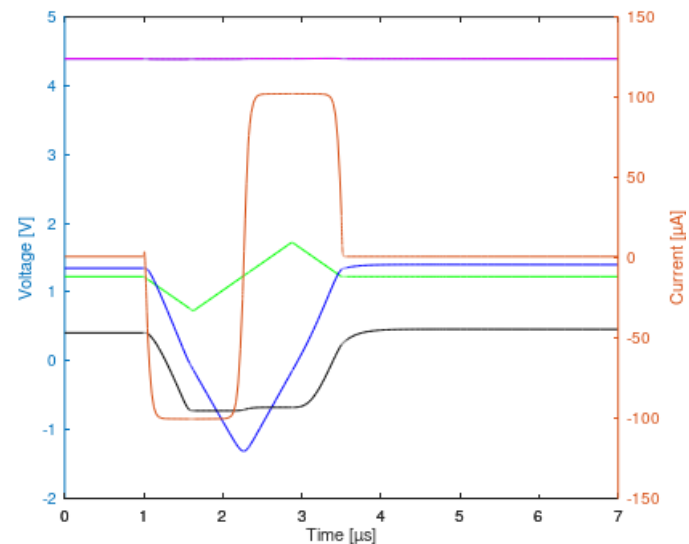

Fig. 17. Plot with different waveforms obtained during SPICE simulation of not propagating SET: VRef voltage (green), OpAmp output (magenta), VCCS output voltage - capacitance of the output stage (blue), OpAmp output transistor base voltage (black), VCCS current (orange).

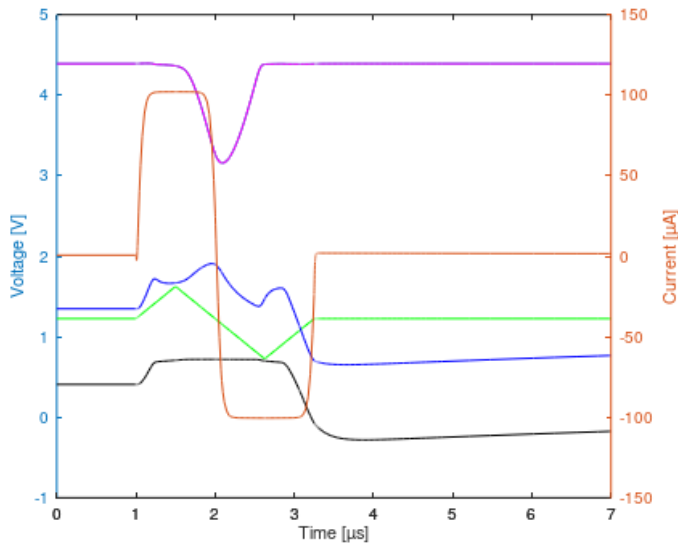

Fig. 18. Plot with different waveforms obtained during SPICE simulation of partially propagating SET: VRef voltage (green), OpAmp output (magenta), VCCS output voltage - capacitance of the output stage (blue), OpAmp output transistor base voltage (black), VCCS current (orange).

and positive peak going to 1.7 V (FWHM width 0.625 μ s). It was observed, that if the positive peak of SET is preceded by the strong negative part, the capacitance of OpAmp is first discharged by VCCS (during negative part of SET) and then it is recharged by VCCS during the positive part of SET. It takes some time until positive SET will charge capacitance to the initial value, and additional time would be needed to charge even more and finally to switch the output of OpAmp. That's why even very high positive peaks, if they are preceded by low enough negative peaks, will not switch the output of OpAmp. Not propagating SETs with such signature were observed during laser tests.

Figure 18 presents simulation results for partially propagating SET with positive peak going to 1.6 V (FWHM width 0.5 μ s) and negative peak going to 0.7 V (FWHM width 0.625 μ s). During positive part of SET, capacitors on VCCS output are charged, output transistor's base voltage increase and the output voltage of OpAmp starts to decrease. But simulation shows that if the negative peak is following closely the positive peak, the charging of capacitance is stopped and discharging starts, the base voltage of output transistor is decreased - transistor stops conduction and the output comes back to high state. Partially propagating SETs with deep negative part following the positive part, were observed during laser tests.

V. COMPLEMENTARY HEAVY ION TESTS AT CYCLONE FACILITY

Additional heavy ion tests of PoL 2D board were performed in the end of June 2019 in the Cyclotron of Louvain la Neuve (CYCLONE) at Université catholique de Louvain (UCL) in order to better understand effects observed during previous test campaigns. PoL was tested in conditions of reduced supply voltage: 4.5 V measured on board and it was several millivolts above the level of autonomous trigger of the undervoltage protection of the DUT. This level is different than measured during laser tests (4.43 V). This might be explained by higher

external interference during heavy ion tests and the fact that supply cables were longer at UCL (~6 metres) than during laser tests (less than 4 metres), which gives higher voltage drop during each cycle of operation of the converter (PoL). LET values used during tests at UCL were 62.5 MeV·cm²/mg (¹²⁴Xe³⁵⁺ ion), 45.8 MeV·cm²/mg (¹⁰³Rh³¹⁺ ion) and 20.4 MeV·cm²/mg (⁵⁸Ni¹⁸⁺ ion). The maximum flux during test was 1.5x10⁴ ions/cm²/s.

For LET equal to 62.5 MeV·cm²/mg and 45.8 MeV·cm²/mg, transient propagation and partial propagation was observed during direct irradiation of the voltage reference chip. Signatures of different types of SET had characteristics as observed in SPICE simulations or during laser tests. For LET equal to 20.4 MeV·cm²/mg, the propagation of SETs was not observed (fluence used for this test was 1x10⁷ ions/cm²).

Direct irradiation of the OpAmp chip during PoL test at UCL showed that for reduced supply voltage conditions, power cycling of PoL is also possible after ion hit at OpAmp. This effect was observed for LET values 62.5 MeV·cm²/mg, 45.8 MeV·cm²/mg and 20.4 MeV·cm²/mg.

VI. DISCUSSION

SPICE simulation explains results observed during laser tests but is also a strong background to propose a hypothesis on why propagation of specific SETs was observed also during heavy ions tests at CHARM facility. Most of the SETs observed during heavy ions tests had similar signature: negative peak followed by positive peak. But all the recorded SETs that did propagate in the system had different signature: negative peak was followed by much longer positive peak, or double positive peaks (see figure 19 for examples of SET waveforms captured during test campaign at CHARM). Most probably this longer positive part of SET was responsible for longer charging of OpAmp output stage capacitance, and finally for switching of the output. Specific signature of the propagating SETs gives the idea that pile-up of two SETs (due to two ions passing through voltage reference chip in close time) could give signature of the propagating SET. Facts that the flux was high during CHARM tests and that cross section for SET propagation was low, do support this hypothesis.

To verify this hypothesis, rough calculations with use of Monte-Carlo method were performed to estimate the probability of two SETs appearing at VREF close in time. Input data used was the SET cross-section (10⁻⁵ cm²), ion flux (according to the test log it was ~3-3.5x10⁶ ions/cm²/spill during the period when power cycling was observed) and spill

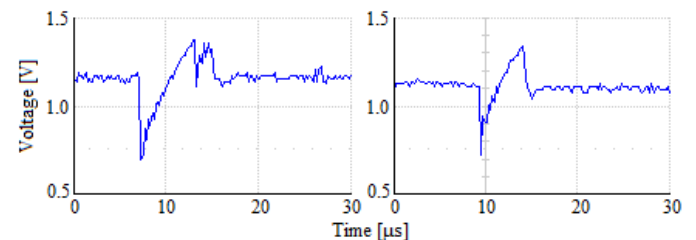

Fig. 19. Example of SETs measured at VRef node, which caused power cycling (left) and which didn't cause power cycling (right) during PoL heavy ion test at CHARM facility.

duration (200 ms). Resulting number of SETs at VREF output is 30-35 per spill. In proposed method, each spill was simulated as a group of 30 SETs, each SET having random time stamp in range from 0 to 200 ms. If in certain spill the difference between time stamps was smaller than 5 μ s, it was marked as double-hit; time shift of 5 μ s was chosen based on analysis of figure 19. According to simulation, for 10^4 simulated spills, number of double-hits is around 220. This means that for 3×10^5 simulated SETs there are around 220 double hits, so the difference is 3 orders of magnitude. This is compliant with experimental result showing that power cycling event cross-section is 3 orders of magnitude smaller than VREF SET cross-section. Uncertainty of proposed calculation is related to the choice of time shift between two SETs defined as double-hit (expected to lead to power cycling). Simulation for time shift of 10 μ s (instead of 5 μ s) gives result of around 420 double-hits per 10^4 simulated spills; whereas for 3 μ s the result is around 120 double hits per 10^4 simulated spills. If we take number of SETs in spill equal to 35, for time shift of 5 μ s we have result of around 305 double-hits per 10^4 simulated spills (3.5×10^5 SETs). These results show that there is still difference of around 3 orders of magnitude between number of simulated SETs and resulting number of double-hits.

Presented results show that the very high particle flux may lead to double (or multiple) SEEs in short time. This may lead to unexpected component-level or system-level effects, that would not be observed when testing with lower flux, and that may be very unlikely in target environment (like space). This leads to a conclusion that such over-testing is possible in the very high flux facility and it should be taken into account during test preparation phase or during results analysis. But it should be also reminded in this point, that although double SETs are supposed to generate power cycles during tests at CHARM, it was also possible to generate a power cycle by single SET (with different signature) during heavy ion tests at CYCLONE facility.

Synergistic effects between cumulative effects and analog SET were discussed e.g. in [13][14]. In our work it was observed that power cycling event rate (due to SET propagation) was changing with time during the experiment. Figure 20 presents average number of power cycles per minute during last ~ 3 hours of the test at CHARM (15 minutes

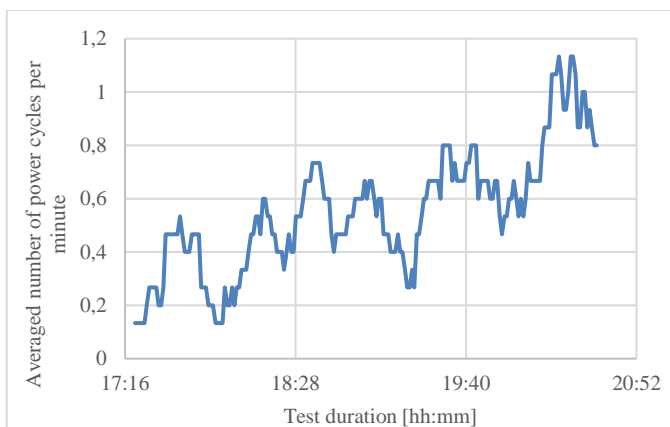

Fig. 20. Averaged number of power cycles per minute during last ~ 3 hours of the test at CHARM (15 minutes averaging period was used).

averaging period was used). It might be observed that number of power cycles is gradually increasing during the test (with local variations, as expected for a random process), although the flux (number of ions per spill) doesn't increase. This effect is expected to be result of degradation of PoL due to cumulative effects which lead to increase of current consumption and resulting decrease of the VIN voltage at level of the DUT (due to higher voltage drop on the supply cables). This lower VIN level lead to smaller difference between V+ and V- of OpAmp and this is supposed to have been the source of higher rate of power cycling events in time. Therefore, observed effect might be considered as a synergistic effect, but occurring at system level.

Unexpected power cycling of a power converter module is a very undesired situation from the user/application point of view. However, for the PoL 2D board (prototype version of the 3DPM-0024) which was the DUT during all the tests described, power cycling events were observed only for supply voltage below specified operating voltage range (4.75 V - 5.25 V). Presented analysis shows that observed power cycling should not be considered as a threat when nominal supply voltage is applied.

From the more general point of view, SET propagation observed and described in this work can only appear when the voltage difference between V+ and V- inputs of operational amplifier is very small. (Behaviour verified for OP484, but expected for other amplifiers with similar internal structure, i.e. with output stage capacity being charged by internal current source which might be controlled by high enough transients on OpAmp input, when the voltage difference between V+ and V- inputs is small). It is important to note, that in the conditions described SET worst case signature is a unipolar, positive peak (for V+ nominally higher than V-) and therefore testing with bipolar only transients might not uncover sensitivity of the circuit for propagation of unipolar transients with even lower amplitude.

Although in many applications, the difference between V+ and V- of operational amplifier will be higher than during tests presented in this work, the effect described in the paper might become important for a system end of life conditions: in this situation, parameters drift due to aging and/or radiation effects may lead to decrease of the V+ and V- voltages difference and increase of sensitivity to unipolar transients. In order to protect the PoL system against this effect, the Vref source (which is the input to the OpAmp) should be filtered to suppress SETs. For other systems/circuits where it is expected that OpAmp might work in the configuration of low V+ and V- difference, it should be verified if the IC/circuitry at input of OpAmp may generate unipolar SETs that could propagate through OpAmp. If such risk is not negligible, it should be also considered to use filters to suppress SETs.

Propagation of analog SETs was already broadly discussed in literature. In [6] parameter influence on analog SETs in OpAmps is discussed. Different external factors (operating configuration, supply voltage, input voltage, output load, and gain) and internal factors (like compensating capacitor) are discussed and it is shown how they affect SET width, amplitude

and sensitivity to SET propagation. It is also presented in [6] that analog SETs are propagating from input to output of the SET-hardened IS-139ASRH voltage comparator only when the overdrive voltage is as low as 5.8 mV, but the propagation mechanism is different from the one discussed in this paper.

[7] describes use of macromodels (based on SPICE) and micromodels (involving 3-D device physics code with the layout geometry of the transistor) to model ion hit inside OpAmp and to verify if generated SET will produce any malfunction in the system. It is a complex tool using IC model created by the user of a IC, not by the manufacturer. However, the only SET parameters that are claimed to be important to define if there is SET propagation or not, are the SET height and width. [8] presents how computer simulations can be used to develop system-level design hardening methodologies against SETs. Worst-case SET signatures are extracted from the simulations, confirmed with OpAmp heavy-ion test and used to propose mitigation techniques. Worst-case is defined here in terms of the maximum SET amplitude and width. However in [15], it is stressed that although macromodel of the ICs/circuit might be successfully used to analyze system-level propagation of SET, for the analysis of SET inside of the IC, the device micromodel should be used.

In [16], SET propagation in Schmitt trigger based on OpAmp is analysed. It is shown that SETs induced in this kind of circuit can change the state of the OpAmp output depending on the circuit design, the input voltage and the injected energy into the device. Particularly, it is presented that for lower difference of $V+$ and $V-$, lower laser energy is needed to produce the SET that will change the state of the output, but there is no analysis of SET signatures. [17] demonstrates that SETs can induce instability in another type of circuit: linear voltage regulators. Simulations and analysis with use of the OpAmp micromodel show that oscillation is initiated by a change in current flow between the current mirror of the differential input stage and the compensation capacitor of the OpAmp (SET is generated inside of the OpAmp and propagates to its output).

According to the best knowledge of authors of this paper, it is the first time to observe and present that in OpAmp with low voltage difference between $V+$ and $V-$, there is difference in propagation of unipolar and bipolar SETs from input to output of the OpAmp. It is also the first time to observe and explain (by analysis of VCCS in OpAmp) difference in propagation of bipolar SETs with negative peak followed by positive peak and with positive peak followed by negative peak.

VII. CONCLUSIONS

Laser tests are used to reproduce rare event observed during system level heavy ions tests: SEE provoking power cycling of the DUT (Point of Load converter) with reduced supply voltage. In the DUT analyzed, reduction of the supply voltage leads to reduction of voltage difference between $V+$ and $V-$ inputs of OpAmp in the undervoltage protection circuit. Laser tests show that in these conditions, specific SETs generated at voltage reference chip might propagate to OpAmp output and up to the output of the DUT. SETs that do propagate are the ones with high enough positive peak and insignificant negative

peak value whereas some transients with bigger maximum and/or peak to peak value will not propagate. SPICE simulation results show that important for understanding the observed effects is operation of the voltage controlled current source inside OpAmp, which is charging and discharging capacitance of the output stage of the OpAmp.

VIII. ACKNOWLEDGMENTS

This work has received funding from the European Union's Horizon 2020 research and innovation program under the Marie Skłodowska-Curie grant agreement number 721624.

Laser tests have been performed using the University of Montpellier PRESERVE Platform which has been funded thanks to the financial support of the Region Occitanie and the European Union via European Regional Development Fund.

IX. REFERENCES

- [1] J. W. Swonger et al., "Radiation-Hardened Point-of-Load Buck Regulators for Space Applications", 2012 IEEE Radiation Effects Data Workshop, pp. 149-156, July 2012.
- [2] A. H. Johnston et al., "Single-Event Transients in Voltage Regulators", IEEE Trans. Nucl. Sci., vol. 53, no. 6, pp. 3455 – 3461, Dec. 2006.
- [3] S. P. Buchner, F. Miller, V. Pouget, and D. P. McMorro, "Pulsed-laser testing for single-event effects investigations," IEEE Trans. Nucl. Sci., vol. 60, no. 3, pp. 1852–1875, Jun. 2013.
- [4] S. Buchner, J. Howard, C. Poivey, D. McMorro, R. Pease, "Pulsed-laser testing methodology for single event transients in linear devices", IEEE Trans. Nucl. Sci. vol. 51, no. 6, p. 3716 - 3722, Dec. 2004.
- [5] N. J.-H. Roche et al., "Correlation of Dynamic Parameter Modification and ASET Sensitivity in a Shunt Voltage Reference", IEEE Trans. Nucl. Sci., vol. 59, no. 6, p. 2756 – 2763, Dec. 2012.
- [6] S. Buchner et al., "Single-Event Transients in Bipolar Linear Integrated Circuits", IEEE Trans. Nucl. Sci., vol. 53, no. 6, p. 3079 – 3102, Dec 2006.
- [7] R. L. Pease, "Modeling Single Event Transients in Bipolar Linear Circuits", IEEE Trans. Nucl. Sci., vol. 55, no. 4, p. 1879 – 1890, Aug 2008.
- [8] Y. Boulghassoul et al., "System-Level Design Hardening Based on Worst-Case ASET Simulations", IEEE Trans. Nucl. Sci., vol. 51, no. 5, p. 2787 – 2793, Oct 2004.
- [9] R. Marec et al., "Toward a single event transient hardness assurance methodology", Radiation Effects on Components and Systems Conference, pp. 343–350, Sep. 2001.
- [10] R. García Alía et al., "Ultraenergetic heavy-ion beams in the CERN accelerator complex for radiation effects testing", IEEE Trans. Nucl. Sci., vol. 66, no. 1, pp. 458–465, Jan. 2019.
- [11] P. Fernández-Martínez et al., "SEE Tests with Ultra Energetic Xe Ion Beam in the CHARM Facility at CERN", IEEE Trans. Nucl. Sci., vol. 66, no. 7, pp. 1523–1531, Jul. 2019.
- [12] R. Koga et al., "Single event upset (SEU) sensitivity dependence of linear integrated circuits (ICs) on bias conditions", IEEE Trans. Nucl. Sci., vol. 44, no. 6, p. 2325 – 2332, Dec 1997.
- [13] N. J.-H. Roche et al., "Impact of Cumulative Irradiation Degradation and Circuit Board Design on the Parameters of ASETs Induced in Discrete BJT-based Circuits", IEEE Trans. Nucl. Sci., vol. 62, no. 6, pp. 2732 – 2742, Dec. 2015.
- [14] N. J.-H. Roche et al., "Development of a new methodology to model the synergistic effects between TID and ASETs", IEEE Trans. Nucl. Sci., vol. 57, no. 4, p. 1861 - 1868, Aug 2010.
- [15] Y. Boulghassoul et al., "Applicability of Circuit Macromodeling to Analog Single-Event Transient Analysis", IEEE Trans. Nucl. Sci., vol. 50, no. 6, p. 2119 – 2125, Dec 2003.
- [16] N. J.-H. Roche et al., "Investigation of Flip-Flop Effects in a Linear Analog Comparator-With-Hysteresis Circuit", IEEE Trans. Nucl. Sci., vol. 60, no. 4, p. 2542 – 2549, Aug 2013.
- [17] P. C. Adell et al., "Single Event-Induced Instability in Linear Voltage Regulators", IEEE Trans. Nucl. Sci., vol. 53, no. 6, pp. 3506 – 3511, Dec. 2006.