



**HAL**  
open science

# Metamaterial-based LTCC Compressed Luneburg Lens Antenna at 60 GHz for Wireless Communications

Dmitry Zelenchuk, Camilla Kärnfelt, François Gallée, Irina Munina

► **To cite this version:**

Dmitry Zelenchuk, Camilla Kärnfelt, François Gallée, Irina Munina. Metamaterial-based LTCC Compressed Luneburg Lens Antenna at 60 GHz for Wireless Communications. 2021 IEEE International Conference on Microwaves, Antennas, Communications and Electronic Systems (COMCAS), Nov 2021, Tel Aviv, Israel. pp.513-515, 10.1109/COMCAS52219.2021.9629111 . hal-03670114

**HAL Id: hal-03670114**

**<https://hal.science/hal-03670114>**

Submitted on 3 Jun 2024

**HAL** is a multi-disciplinary open access archive for the deposit and dissemination of scientific research documents, whether they are published or not. The documents may come from teaching and research institutions in France or abroad, or from public or private research centers.

L'archive ouverte pluridisciplinaire **HAL**, est destinée au dépôt et à la diffusion de documents scientifiques de niveau recherche, publiés ou non, émanant des établissements d'enseignement et de recherche français ou étrangers, des laboratoires publics ou privés.

# Metamaterial-based LTCC Compressed Luneburg Lens Antenna at 60 GHz for Wireless Communications

Dmitry Zelenchuk<sup>1</sup>, Camilla Kärnfelt<sup>2</sup>, Francois Gallee<sup>2</sup>, and Irina Munina<sup>3</sup>

<sup>1</sup> The ECIT Institute, Queen's University Belfast, Belfast, BT3 9DT, United Kingdom, d.zelenchuk@qub.ac.uk

<sup>2</sup> IMT Atlantique, Lab-STICC, UMR CNRS 6285, F-29238 Brest, France; camilla.karnfelt@imt-atlantique.fr; francois.gallee@imt-atlantique.fr

<sup>3</sup> Department of Microelectronics and Radio Engineering, St. Petersburg Electrotechnical University «LETI», St. Petersburg, 197376, Russia, ivmunina@etu.ru

**Abstract** The paper presents a metamaterial based LTCC compressed Luneburg lens antenna for wireless communications. The antenna is designed at 60 GHz to utilize the unlicensed mm-wave spectrum available for short-range high-data-rate communications. The gradient index compressed Luneburg lens antenna is designed using the quasi-conformal transformation optics method. The design of the antenna is fully compliant with the standard LTCC process with a high-permittivity host material. The diameter of the antenna is 19 mm and the thickness is less than 2 mm. The peak antenna gain at 60 GHz of 16 dBi is demonstrated. Beam scanning capacity is demonstrated with 1 dB scan loss within  $\pm 25$  degree field of view.

**Index Terms** — metamaterials, antenna, lens, scattering.

## I. INTRODUCTION

Modern wireless communications systems have put new demands on connection reliability and data throughput. To respond to these challenges, the wider use of mm-wave spectrum has been proposed as well as MIMO technologies. A particular interest presents an unlicensed spectrum around 60 GHz that enables high-data-rate communications for multiple consumer applications [1]. This in turn requires antenna engineers to propose multi-user high gain antenna designs to compensate for the path loss incurred at high frequencies [2].

Among the candidate antenna designs one can highlight active phased arrays with high functionality but high cost. Alternatively, reflector and lens antenna can provide high-gain multi-user performance at a lower cost. The Luneburg lens antenna has drawn the attention of researchers for theoretically enabling multibeam performance without scan loss within a wide field of view [3]. The antenna has been realised in a full spherical shape as well as in compressed form.

The compressed form lens uses transformation optics approach and has been realised in X-band with a set of ceramic shapes [4] as well as by an assembly of stacked multilayer printed circuit boards [5]. In this paper we employ the latter approach to design a compressed Luneburg lens antenna with low-temperature co-fired ceramics (LTCC) process for 60 GHz mm-wave spectrum.

## II. COMPRESSED LUNEBURG LENS

The Luneburg lens is a gradient index lens with spherical symmetry with relative permittivity varying radially as

$$\epsilon_r(r) = 2 - (r/a)^2 \quad (1)$$

where  $a$  is the lens radius. The spherical gradient-index lens can be readily manufactured with different 3D printing techniques and various designs have been proposed in the literature.

In order to reduce the volume of the lens and make it better compatible with various feeding antennas and integrated electronics, the use of transformation optics method has been proposed and the lens was either partially or fully transformed to a cylindrical shape with a flat surface.

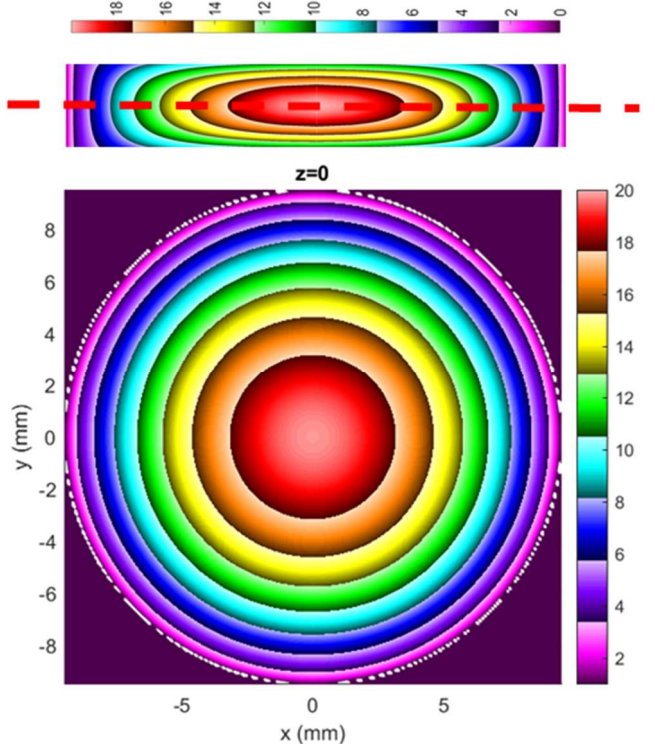

Fig. 1. 3D distribution of permittivity for the compressed Luneburg lens. Top: vertical cut of the permittivity, bottom: horizontal cut in the central plane.

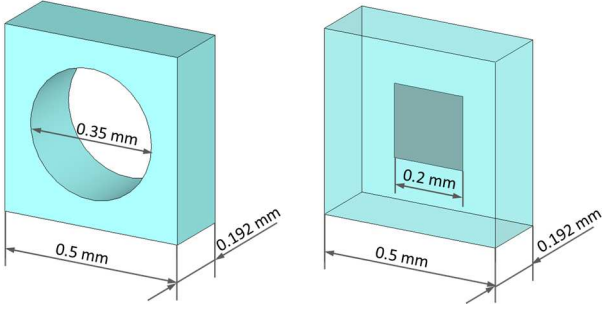

Fig. 2. Metamaterial unit cells.

By employing the following coordinate transformations

$$z' = \frac{\delta}{\sqrt{a^2 - y^2}} z, y' = y \quad (2)$$

and applying the equations of transformation optics one can calculate the permittivity and permeability distributions on of a flat Luneburg lens with radius  $a$  and height  $\delta$ . The full set equations for the transformation can be found in [4], [6]. It has been shown in [4] that reducing the resultant anisotropic structure to the inhomogeneous isotropic distribution does not lead to significant discrepancies in the implementation.

The structure with a radius of 9.5 mm and a height of 1.92 mm has been simulated and the resultant permittivity is

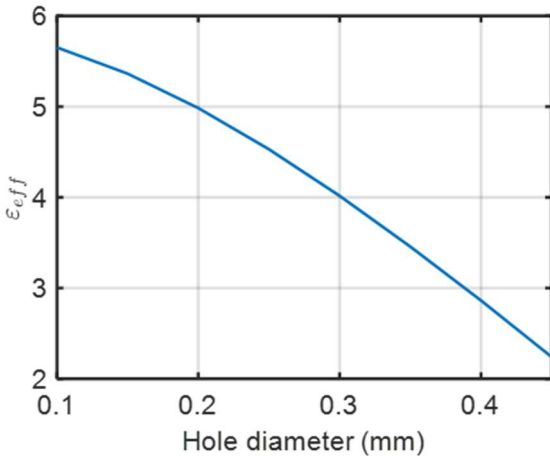
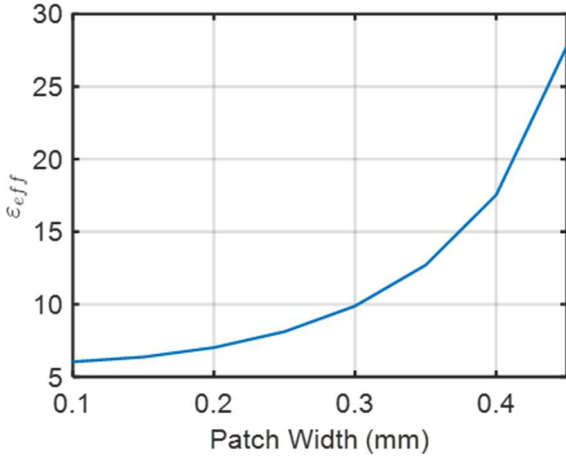

Fig. 3. The permittivity of the metamaterial. Top: vs patch width; bottom: vs hole diameter.

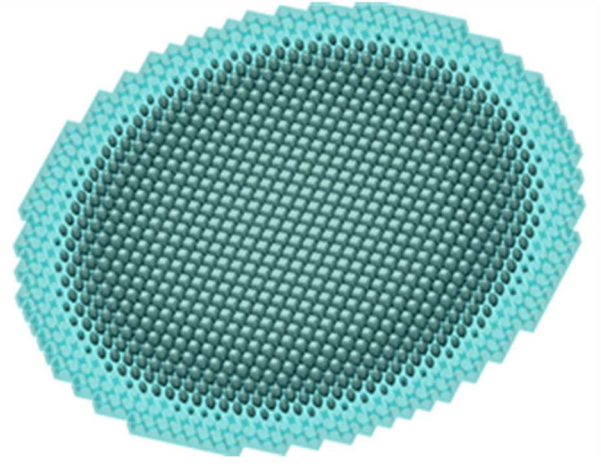

Fig. 4. LTCC Metamaterial Luneburg lens.

presented in Fig. 1. One can see that the permittivity must be as high as 20 for this realisation.

The lens was designed compatible with the LTCC process with host material Ferro A6M-E  $\epsilon_r = 5.9$ ,  $\tan \delta = 0.02$  and layer thickness of  $0.096 \text{ mm}$ . In order to achieve the permittivity variation shown in Fig.1 two types of unit cells with the period of  $0.5 \text{ mm}$  were implemented: with a patch and with a hole, see Fig. 2. The structures were simulated with CST Microwave Studio and the extracted permittivity is shown in Fig. 3.

### III. RESULTS AND DISCUSSION

The resultant metamaterial Luneburg lens model for a 20-layer LTCC process is shown in Fig. 4. One can see that the majority of the structure is composed of patch unit cells with the hole unit cells occupying a small area close to the outer surface of the lens.

The lens has been simulated in the CST Microwave Studio using an open-ended waveguide (OEWG) excitation at 60 GHz. It has been noted elsewhere [4] that for the compressed lens an optimal focal position is not at the surface of the lens, but has to be found empirically. In our case, a focal distance of 5 mm has been chosen after a parametric study.

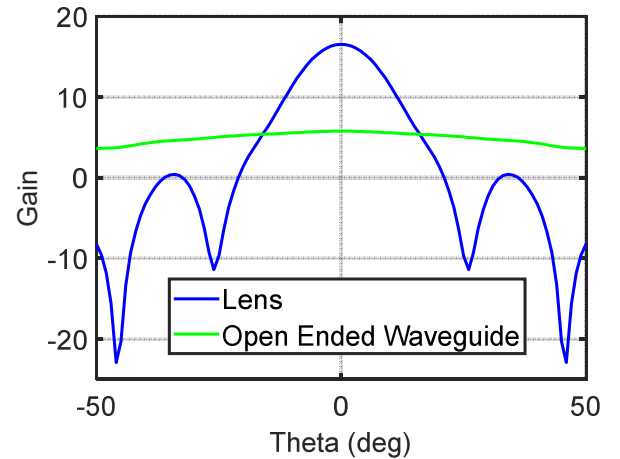

Fig. 5. Simulated gain enhancement with the compressed Luneburg lens.

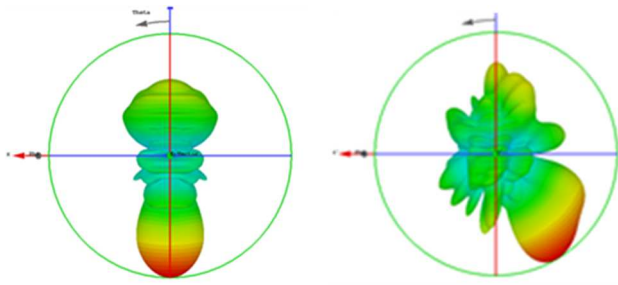

Fig. 6. The radiation pattern of the metamaterial lens that is fed by the OEWG antenna. Left: the OEWG is centered; right: the OEWG is displaced laterally by 5 mm.

The radiation properties of the Luneburg lens antenna have been simulated in CST Microwave Studio. In comparison to the OEWG without the lens the antenna gain has been enhanced by 11 dB to 16.5 dBi, see Fig. 5. The sidelobe level in this particular case is 15 dB.

By moving the horn antenna in lateral position by 5 mm the beam has been steered to 25 degrees from the broadside, see Fig. 6. The simulations have also shown that the peak gain 16 dBi could be achieved with 1 dB scan loss within the specified field of view.

As the structure is designed for industrially compliant LTCC process it can be further integrated with more complex feeding arrangements, e.g. a multi-feed structure for multiple user wireless communications.

#### ACKNOWLEDGEMENT

This research was funded by The Royal Society, grant number IES\R1\191236.

#### REFERENCES

- [1] C. Jouanlanne *et al.*, "Wideband Linearly Polarized Transmitarray Antenna for 60 GHz Backhauling," *IEEE Trans. Antennas Propag.*, vol. 65, no. 3, 2017, doi: 10.1109/TAP.2017.2655018.
- [2] M. Imbert, J. Romeu, M. Baquero-Escudero, M. T. Martinez-Ingles, J. M. Molina-Garcia-Pardo, and L. Jofre, "Assessment of LTCC-Based Dielectric Flat Lens Antennas and Switched-Beam Arrays for Future 5G Millimeter-Wave Communication Systems," *IEEE Trans. Antennas Propag.*, vol. 65, no. 12, 2017, doi: 10.1109/TAP.2017.2767821.
- [3] M. Kamran Saleem, H. Vettikaladi, M. A. S. Alkanhal, and M. Himdi, "Lens Antenna for Wide Angle Beam Scanning at 79 GHz for Automotive Short Range Radar Applications," *IEEE Trans. Antennas Propag.*, vol. 65, no. 4, 2017, doi: 10.1109/TAP.2017.2669726.
- [4] C. Mateo-Segura, A. Dyke, H. Dyke, S. Haq, and Y. Hao, "Flat luneburg lens via transformation optics for directive antenna applications," *IEEE Trans. Antennas Propag.*, vol. 62, no. 4, pp. 1945–1953, 2014, doi: 10.1109/TAP.2014.2302004.
- [5] Y. Su, Z. N. Chen, and A. K. Skrivervik, "A Compact Transformation Optics-based Luneburg Lens Antenna using Curved Reactive Impedance Surface," pp. 8–11.
- [6] Y. Su and Z. N. Chen, "A Radial Transformation-Optics Mapping for Flat Ultra-Wide-Angle Dual-Polarized Stacked GRIN MTM Luneburg Lens Antenna," *IEEE Trans. Antennas Propag.*, vol. 67, no. 5, 2019, doi: 10.1109/TAP.2019.2900346.