



HAL
open science

COMBUSTION OF A SYNGAS FROM SEWAGE SLUDGE GASIFICATION ENRICHED WITH AMMONIA IN A SPARK-IGNITION ENGINE

Pierre Brequigny, Etienne Pacaud, Christine Mounaïm-Rousselle

► To cite this version:

Pierre Brequigny, Etienne Pacaud, Christine Mounaïm-Rousselle. COMBUSTION OF A SYNGAS FROM SEWAGE SLUDGE GASIFICATION ENRICHED WITH AMMONIA IN A SPARK-IGNITION ENGINE. 30th European Biomass Conference and Exhibition (EUBCE), etaflorence, May 2022, virtual event, France. ⟨hal-03668925⟩

HAL Id: hal-03668925

<https://hal.science/hal-03668925v1>

Submitted on 16 May 2022

HAL is a multi-disciplinary open access archive for the deposit and dissemination of scientific research documents, whether they are published or not. The documents may come from teaching and research institutions in France or abroad, or from public or private research centers.

L'archive ouverte pluridisciplinaire **HAL**, est destinée au dépôt et à la diffusion de documents scientifiques de niveau recherche, publiés ou non, émanant des établissements d'enseignement et de recherche français ou étrangers, des laboratoires publics ou privés.



HAL Authorization

COMBUSTION OF A SYNGAS FROM SEWAGE SLUDGE GASIFICATION ENRICHED WITH AMMONIA IN A SPARK-IGNITION ENGINE

P. Brequigny, E.Pacaud, C. Mounaïm-Rousselle

Université d'Orléans, INSA-CVL, PRISME, EA 4229, F45072 Orléans, France

ABSTRACT: Syngas (Synthetic Gas), also known as producer gas or wood gas, is a gaseous fuel which could be produced by the gasification of biomass. It is mainly composed of hydrogen and carbon monoxide with a smaller share of methane, all diluted by nitrogen and carbon dioxide. Although it contains carbon in its composition, it is considered as a low or zero carbon fuel as soon as it is made from biomass, which makes it a strong candidate for reducing the global warming impact of combustion engines. This work focuses on the combustion development and performances of a Spark-Ignition engine, fuelled with a syngas enriched with ammonia, from a nitrogen-rich sample, typical of ammonia-enriched sewage sludge. Results show that, by replacing part of the syngas by ammonia, even as expected the combustion development is slowed down, the indicated work increases. Last exhaust emissions measurement shows a decrease in CO and CO₂ as a function of ammonia addition in the fuel but a slight increase of NO_x.

Keywords: combustion, engine, alternative fuel, ammonia, syngas

1 INTRODUCTION

The Intergovernmental Panel on Climate Change IPCC (<https://www.ipcc.ch/>) report has brought clear insight concerning climate change with the estimated global warming scenarios. The most optimistic forecast expects a 2°C global warming for the next century. To limit it as much as possible, the global emissions of the Greenhouse Gases (GHG) must significantly decrease in the next few years. Electricity and Heat production along with Agriculture Forestry and other Land Use (AFOLU) contribute to half of these world's emissions.

The agro-industrial feedstock such as the municipal sewage sludge is a source of renewable gases making them attractive fuels. These gaseous fuels can be obtained by different processes as hydrothermal gasification (375-500°C), gasification (800–1000°C) and methanization (40°C). The choice between wet and dry processes depends

on the nature of the feed and its water content. Among these processes, gasification takes place in the presence of water and is especially suited for the valorization of wet feedstock (water content >50%), such as wet animal manures and municipal sewage sludge (SS). Gasification or Pyro-gasification is well suited for biomass with low water content, such as agricultural and forestry waste but wet wastes can also be used if a drying step is applied on them. As demonstrated by Wu et al. [1], GHG emissions from agriculture can be reduced by changing the current use of manure by using gasification. This process shows an improvement regarding waste's life cycle and a GHG emissions reduction turning biomass into energy supply. By using such fuel in a cogeneration process or an electricity power unit, it would enable locally better waste management while providing sustainable energy and could potentially reduce GHG emissions from both the energy and agricultural sectors.

The purpose of a gasification system is to transform solid fuels (crude biomass or char obtained from pyrolysis or hydrothermal carbonization) into combustible gaseous mixtures. The gaseous products, mainly composed of hydrogen (H_2), carbon monoxide (CO), methane (CH_4), nitrogen (N_2) and carbon dioxide (CO_2) forming syngas, can be used directly as a gaseous fuel for thermal energy converter. One gasification challenge is to keep the gas free of harmful components (i.e. nitrogenous species) prior to subsequent combustion and power generation. As a waste-to-energy process, biomass thermal conversion competes with landfilling and methanization, but the carbon utilization of the syngas road is higher than landfilling [2] and can be in some case better than the biogas road [3]. Methanization is limited where livestock manure can be considered as waste when it is in surplus, especially in areas with structural nitrogen surplus. Indeed, the nitrogen concentrated in the digestate limits its spreading in this situation because of possible ammonia emission and soil and water contamination.

Yet, the thermal conversion remains challenging because the properties of the producer gases, thus its combustion potential, vary significantly with the feedstock characteristics (chemical composition, moisture content, structure, reactivity, physical properties, impurities, etc.) [4–7], the gasification reactor type [8] and the key operating parameters (temperatures, reaction atmosphere, stoichiometric ratios, gas flow rates and heating rates) [9–11]. During the gasification, different impurities (nitrogen-impurities, sulphur-impurities, and chloride-impurities) may be produced favourably [12,13], depending on their quantity in the original sample [14]. Agro-industrial manures and SS have similar properties with higher nitrogen (N) and water contents produced in large quantities, and therefore are considered good candidates for energy production. Thus, many efforts have been made to investigate the N conversion during sewage sludge pyrolysis [15,16]. During the thermal conversion, nitrogen is released as nitrogen-containing volatiles including NO_x precursor gases such as ammonia (NH_3) and hydrogen cyanide (HCN). Besides, the composition of these volatiles is dependent on the procedure applied and

temperature range. The nitrogen conversion and the emission of nitrogenous compounds (NH_3 , HCN) or N-Tar yields production is strongly dependent on the temperature [15], the heating rate, and the residence time [16]. The choice of the gasifying agent (e.g. steam or CO_2) is also affecting the quality of the gas (hydrogen or methane-rich gas with less CO_2 and tar formation at the exit). Hence, such feedstocks provide favourable conditions for the yield of N-impurities such as ammonia. However, in most processes, especially engines for Combined Heat and Power (CHP), these undesired yields are avoided as much as possible to obtain a “purer” syngas, i.e. mostly composed of H_2 and CO.

The use of syngas in thermal energy converters dates back to World War II when gasoline shortages stimulated the conversion of vehicles to fuel derived from wood gasification. A renewed interest appeared last decades with a use of syngas in CHP application. Despite being a well-established technology, researches on the characteristics of syngas fuelled energy converters are limited especially considering the syngas composition impact. As underlined in the review of Fiore et al. [17]: “difficulties in predicting the actual flame speed essentially derives from the wide variability of syngas composition, which results from a number of factors related to its production technology” or the nature of the feedstock as underlined above. The questions are therefore what could be the impact of the “raw” syngas composition on the combustion as a function of the feedstock type and how the presence of impurities in the gas would affect the engine performances (possibly in a CHP system). If the presence of these impurities does not affect the gasification process itself, nor the thermal conversion via combustion, the overall cost of resource recovery would decrease due to one less step. It is, nonetheless, necessary to have a flexible and robust installation to provide the highest efficiencies whatever the syngas compositions.

As for application, syngas is nowadays successfully used in thermal converters based on spark-ignition (SI) engines. However, since those kinds of engines are usually designed and optimized for gasoline or natural gas, specific arrangements are required to operate on syngas. The important variability of composition exacerbates this issue decreasing operation stability and strengthen the need of optimizing operating parameters through prevention and regulation systems. Moreover, the use of syngas generally results in a decrease in engine power, which can be compensated by increasing the compression ratio as much as possible, as highlighted by Szwaja et al. [18,19] for a synthesis gas representative of sewage sludge gasification. As underlined by Fiore et al. [17], a significant number of studies, both numerical and experimental deals with the use of syngas in SI engines. However, most of them focus on the knock limit strongly affected by the syngas composition. Studies on the impact of the syngas composition in SI engine by considering a complete syngas composition (not only H_2/CO blends) are quite sparse. Bhaduri et al. [20] fueled a compression ignition engine in homogeneous combustion mode by connecting directly

a gasifier, which results in composition variation as a function of time of the gasification process itself. Recently, Rabello de Castro et al. [21] studied 3 different syngas compositions previously identified by Bridgwater [8], in a dual-fuel compression ignition engine. They showed that: i) H₂ content has a strong influence on the Heat Release Rate as well as on the combustion phasing and duration; ii) the presence of CO₂ in the syngas plays an important role in reducing NO_x emissions but too much CO₂ can lead to poor efficiency and emissions increase; iii) the combustion development can be empirically predicted by fundamental properties of the syngas composition such as laminar flame speed or adiabatic flame temperature. One other interesting study was proposed by Tsiakmakis et al. [22] with the use of three different compositions in SI engine coming from three different feedstocks namely olives, peaches and grapes showing engine performances but pollutant emissions were not measured. They blended these compositions with propane and compared it with pure propane showing that increasing the syngas content leads to reduced in-cylinder pressures, heat release rates and power output but that stable operation is ensured with a power output reduction less than 10% for mixtures of 55% w/w producer gas and 45% w/w propane compared to neat propane. As a result, the impact of impurities on engine operation is not well covered by the literature currently and considering that N impurities can lead to NO_x emissions at the exhaust, this requires quantification.

Moreover, ammonia recently gains a renewed interest as a potential zero-carbon fuel in internal combustion engine especially in Spark-ignition (SI) ones. Indeed, despite its unfavorable combustion properties [23], stable operation was achieved with neat ammonia in SI engines with different architectures [24–29]. It could be also noticed that one of the first uses of ammonia in engines dates back to WWII in Belgium, where the bus fleet operated with the first dual fuel engine ever reported: coal gas (so syngas) composed of 50% H₂ directly injected in the combustion chamber filled with ammonia [30].

The objective of this study is therefore to consider this ammonia content no longer as an impurity but as part of the fuel. For this purpose, a syngas composition representative of sewage sludge gasification (likely to contain ammonia) is selected and investigated in a Spark-Ignition engine in terms of performances and emissions. For reference, the syngas is first compared to pure methane. The second part of the present paper studied the effect of blending ammonia with syngas on the engine performances and emissions to assess its impact either considered as an impurity or a co-fuel by varying the ammonia share in the blend.

2 EXPERIMENTAL SETUP

2.1 Engine characteristics

The experiments were conducted in a research single cylinder SI engine. All specifications are presented on the Table I.

Table I: Engine specifications

Displaced volume	535.5 cm ³
Bore	77 mm
Stroke	115 mm
Connecting rod length	177 mm
Compression ratio	11.7
Intake valve opening	5 CAD
	After Top Dead Center
	(ATDC)
Exhaust valve closing	5 CAD
	Before Bottom Dead Center
	(BBDC)

For all operating conditions, the engine is driven by an electric motor at a fixed engine speed of 1400 rpm. The optical encoder placed in the main crankshaft enables the monitoring of the angular position with a 0.1 Crank Angle Degree (CAD) resolution. The bench is described in more details by Mounaïm-Rousselle et al. [29]. The in-cylinder pressure is measured using a Kistler piezoelectric pressure transducer (6045A). Intake and exhaust temperature and pressure are monitored using K-type thermocouples and piezoresistive absolute pressure transducers respectively. The absolute in-cylinder pressure is obtained by its equalization with the average absolute pressure at the inlet, P_{in} , at 20 CAD after the intake valve opening. The charge duration for the ignition coil was set to 2ms. For all the data presented below, the Spark Ignition Timing (SIT) was optimized to obtain the maximum Indicated Mean Effective Pressure (IMEP), with a covariance, COV_{IMEP} , below 5%.

All gaseous flows are measured and controlled using Brooks thermal mass flowmeters with a 0.7% precision to ensure control of the equivalence ratio below a 1.5% variation. All gases are preheated to the intake temperature of 30°C and premixed in a plenum before their introduction into the combustion chamber. The engine exhaust emissions were measured with the Horiba MEXA 7100HEGR. This exhaust gas analyser measures CO, CO₂, NO_x, O₂ and unburned hydrocarbon (HC). As these results are given in dry share (except for HC), a calculation

considering the share of water vapour in the exhaust enables to readjust the content of each gas. A global scheme of the experimental setup is displayed in Fig. 1.

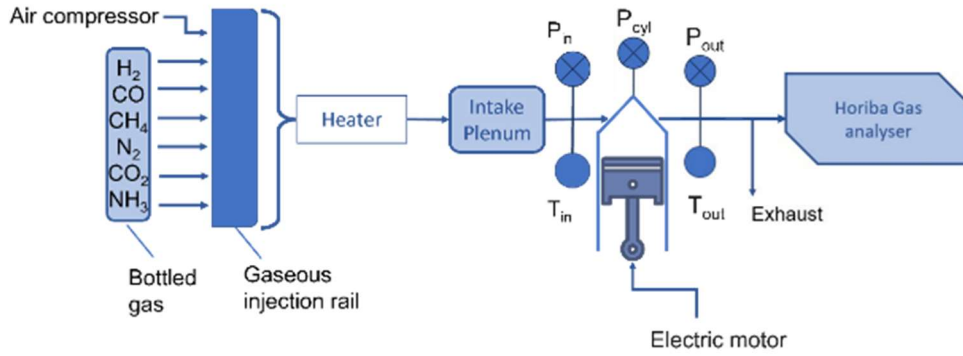

Figure 1. Layout of the experimental setup

2.2 Syngas composition

A syngas composition from the gasification of sewage sludge was chosen to evaluate its combustion characteristics. This kind of feedstock is usually nitrogen-rich and able to produce ammonia as impurity when gasified. The composition chosen for this study was the one from Szwaja et al. [19] which was configured to be in an optimal gas production condition. This syngas composition is displayed on Table II and will be blended with ammonia to evaluate the impact of ammonia in combustion development in a spark-ignition engine.

Table II: Syngas compositions from Szwaja et al. [19]

Gas	H ₂	CO	CH ₄	CO ₂	N ₂
	%mol	%mol	%mol	%mol	%mol
Content	13.00	16.00	3.00	15.00	53.00

The stoichiometric ammonia-added syngas reaction can be expressed as follows:

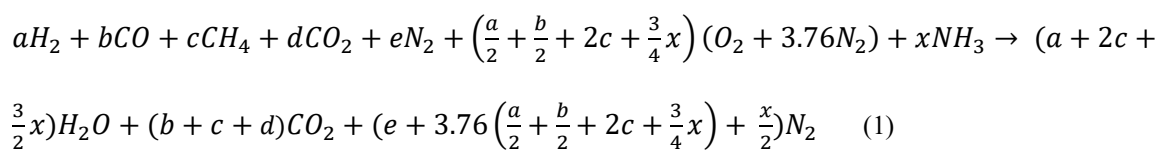

From Eq. 1, air-fuel ratios and mole fraction of each gas based on the equivalence ratio are calculated for all conditions.

2.3 Experimental conditions

For this study, methane was firstly used as a reference fuel with three equivalence ratios as displayed in Table III. These values provide a relevant comparison with pure syngas in the same conditions, and then with ammonia-added syngas, for two different intake pressures. The amount of ammonia in the syngas was incremented by 2.5% up to 10% then with a last point at 15%, to observe the impact of ammonia ‘impurity’ on the syngas performance. Table III summarizes all experimental conditions of this study and Table IV displays the main characteristics for each blend.

Table III: Engine test condition, N=1400 rpm, intake temperature $T_{in}=30^{\circ}\text{C}$

Fuel	Equivalence		Intake
	Ratio (ϕ)	% NH_3	pressure P_{in} (bar)
CH4	0.9;1;1.1	0	1
Pure syngas	0.9;1;1.1	0	1;1.2
Syngas + NH_3	1	0;2.5;5; 7.5;10;15	1;1.2

Table IV: Mixture properties

Fuel composition	Stoichiometric air-fuel ratio (AFR st)	LHV (MJ.kg ⁻¹)
Methane	9.520	50.33
100% syngas	1.512	3.35
97.5% syngas 2.5% NH ₃	1.474	3.53
95% syngas 5% NH ₃	1.436	3.71
92.5% syngas 7.5% NH ₃	1.399	3.89
90% syngas 10% NH ₃	1.361	4.08
85% syngas 15% NH ₃	1.285	4.44

2.4 Post Processing

The Net Heat Release Rate (HRR) is calculated from the in-cylinder pressure as follows:

$$\frac{dQ}{d\alpha} = \frac{\gamma}{\gamma - 1} \cdot P \cdot \frac{dV}{d\alpha} + \frac{\gamma}{\gamma - 1} \cdot V \cdot \frac{dP}{d\alpha} \quad (1)$$

Where γ is the heat capacity ratio, P the in-cylinder pressure, V the in-cylinder volume and α the CAD. Only the net heat release rate is calculated, heat losses were not estimated. The HRR is initially computed with a constant heat capacity ratio to estimate the share of burnt and unburnt gases as a function of the crank angle. Then, the process is repeated with γ depending on the gas composition and temperature at each CAD.

The indicated efficiency is computed as follows:

$$\eta_i = \frac{W_{ind}}{Q_{fuel}} = \frac{IMEP \cdot V_{cyl}}{m_{fuel} \cdot LHV_{fuel}} \quad (2)$$

where W_{ind} corresponds to the indicated work, Q_{fuel} the energy content of the mixture, $IMEP$ the indicated mean effective pressure, V_{cyl} the displaced volume, m_{fuel} the mass of the fuel and LHV_{fuel} the low heating value of the fuel.

Two methods have been established regarding the combustion efficiency. The first one computes the efficiency by taking into consideration the unburnt or partially burned exhaust gases with this equation as follows:

$$\eta_c^{pollu} = 1 - \frac{\dot{V}_{HC}LHV_{HC} + \dot{V}_{CO}LHV_{CO}}{\dot{V}_{fuel}LHV_{fuel}} \quad (3)$$

Where \dot{V}_{HC} , \dot{V}_{CO} and \dot{V}_{fuel} are respectively the volume flow rate of hydrocarbon, monoxide carbon and fuel multiplied by their Low Heating Value in MJ/L. This method must include all unburned or partially burned gases to be totally accurate. Since not all these gases can be assessed from the analyser, this method is only an estimate of the combustion efficiency considering only the hydrocarbon and monoxide carbon reactions.

The second method is based on oxygen balance between intake and exhaust and computed as follows:

$$\eta_c^{O_2} = 1 - \frac{O_{2exhaust}}{O_{2intake}} \quad (4)$$

Where $O_{2exhaust}$ and $O_{2intake}$ are the volumetric flow rate of oxygen at the exhaust and at the intake respectively.

2.4 Kinetics simulation setup

Numerical simulations were carried out using the premixed laminar flame-speed calculation module PREMIX of ANSYS CHEMKIN-PRO [27] to estimate the laminar flame speed and adiabatic flame temperature in engine conditions. Simulations were carried out with an average number of 1000 meshes on a 10 cm grid, a curvature of 0.1, and a gradient of 0.05 with 5 continuations. The selected mechanism is the one of Okafor et al. [31] since it is one of the only ones able to simulate syngas/ammonia blend. This mechanism is based on the GRI-Mech 3.0 [32] for the carbon chemistry, well suited for methane and natural gas and on the mechanism of Tian et al. [33] for ammonia chemistry. It consists in 59 species and 356 elementary reactions and was validated on laminar flame speed of methane/ammonia mixture with an ammonia energy share up to 30% of the total energy content, at atmospheric conditions, i.e 1 atm and 298 K, and equivalence ratios ranging from 0.8 to 1.3. In our case, the 90% syngas/10 % ammonia blend corresponds to an ammonia energy share of 33% and the 15% ammonia blend corresponds to 53% of ammonia energy share.

3 RESULTS AND DISCUSSION

3.1 Syngas versus methane

Figure 2 2 displays the in-cylinder pressure of methane and syngas for three equivalence ratios. As expected,

the maximum of pressure obtained with syngas as fuel is lower than for methane only, not really affected by the equivalence ratio, where the maximum of pressure is around 42 bar.

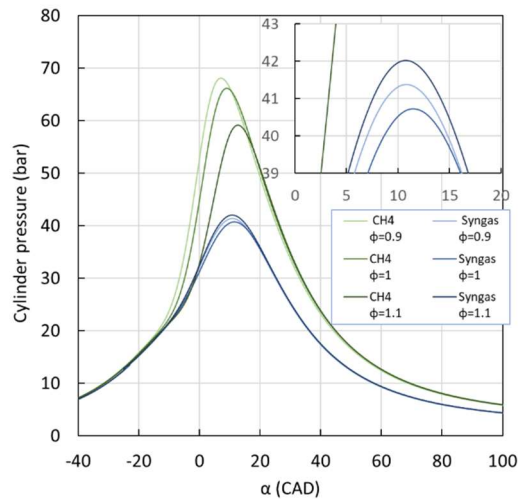

Figure 2: In-cylinder pressure evolution for syngas compared to pure methane for three equivalence ratios at 1 bar intake pressure.

As consequence, the IMEP for pure syngas is lower than for methane only, respectively 5.5 bar and 9 bar as it can be seen in Fig. 3, due to the presence of high amounts of inert gases ($N_2=53\%$ and $CO_2=15\%$) which induces lower LHV and lower energy input. These results are in good agreement with those from Szwaja and Cupial [18]. The increase of the intake pressure (from 1 to 1.2 bar) enables a higher IMEP thus showing potential for boosted operation especially due to the knock resistance of syngas compared to methane. This way, even though methane combustion is more efficient than syngas, the increase of intake pressure could be a way to compensate the performance depletion provoked by syngas. For both fuels, the combustion was stable with COV_{IMEP} between 0.74% and 1.5% for methane and 0.9% on average for syngas.

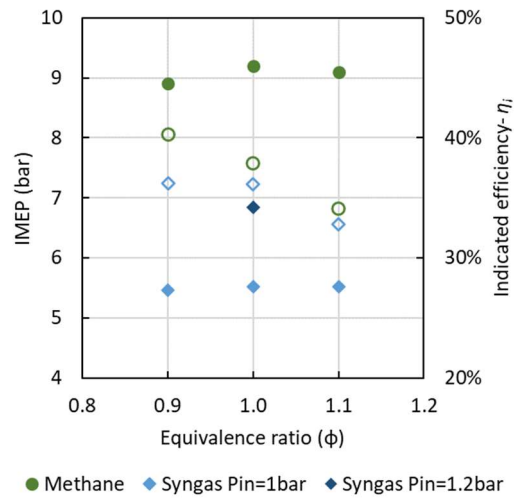

Figure 3: IMEP (filled symbols) and Indicated efficiency (empty symbols) of syngas compared to methane as a function of the equivalence ratio

From Figure 3, it can be noted the decreasing trend of the indicated efficiency can be observed with both gaseous fuels as the air/fuel ratio increases, with also lower values reached for syngas fuel than methane only (36% and 38% at ER=1 and 36% and 40% at ER=0.9, respectively).

The heat release rate comparison between syngas and pure methane as a function of ϕ is shown in Figure 4. Its evolution tends to follow the in-cylinder pressure one due to LHV and energy input difference (about 0.82 kJ for syngas vs. 1.20 kJ for CH₄): a maximum peak at 17 J/CAD for syngas at ER=1.1 against 76 J/CAD for methane at $\phi=1$. However, the HRR evolution is wider for syngas than methane, which means that the combustion duration is longer.

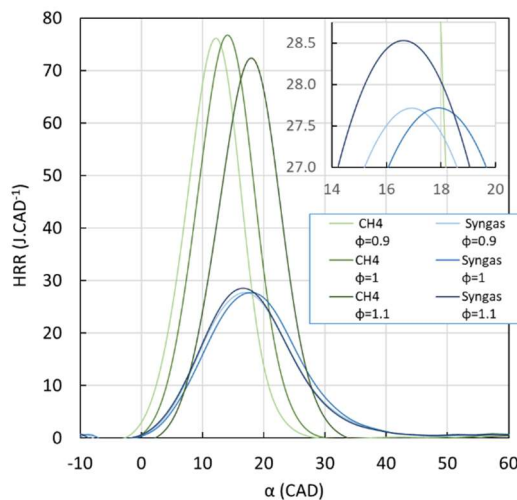

Figure 4: Net heat release rate of syngas and methane for several equivalence ratios at 1 bar intake pressure

This difference is highlighted in Figure 5 where the three different combustion phases are given : from the start, i.e. early flame kernel development (CA10-SIT), the mid, i.e. self-sustained propagation (CA50-CA10) to the end, i.e. post-flame combustion (CA90-CA50), with the variable CAXX, representing the crank angle degree when XX% of mass is burned. As shown in this bar chart, the syngas has a longer combustion mainly during the first phase (20 CAD for syngas against 15 CAD for methane only). As highlighted in [34,35], the laminar flame speed of a similar syngas composition is much smaller than for methane. As the laminar flame speed is one of the main parameters driving the combustion process in Spark-Ignition engine, it is one of the main reasons for the slower combustion explained by the dilution effect of nitrogen and carbon dioxide within the syngas. This figure also shows the negligible impact of the equivalence ratio on the different combustion phases for the syngas in contrary with the methane whose combustion duration decreases when increasing the equivalence ratio up to 1.1 corresponding to the maximum laminar flame speed.

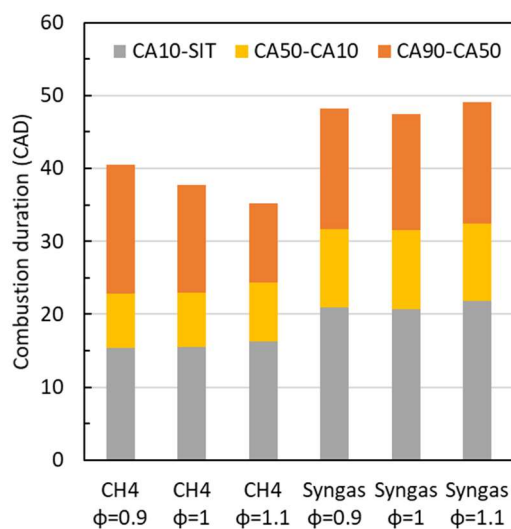

Figure 5: Combustion duration analysis comparing methane and syngas as a function of the equivalence ratio at 1 bar of intake pressure

The emission comparison between methane and pure syngas is displayed in the Figure 6. As expected, the CO₂ emissions for syngas (17%) is twice that of methane (8%), due to the presence of CO₂ in syngas composition (15%). NO_x and unburnt HC are lower for syngas, respectively 50ppmv and 720ppmv, than for methane (1500ppmv and 2130ppmv), at $\phi=1$. The amount of NO_x produced with methane as fuel is due to the highest temperature, favouring thermal NO_x formation. The specific composition of the syngas tends to provoke similar effect than the dilution by exhaust gas recirculation (EGR), preventing thermal NO_x production due to the decrease

of the combustion temperature. By considering HC and CO emissions, the difference induced by the two fuels might be related to the lower carbon content of the syngas. As a function of the equivalence ratio, no real impact can be noted for the syngas; contrary to the case of methane, as already well studied in literature [36]. NOx emissions increase in lean side (4300 ppmv at ER=0.9 versus 320 ppmv at ER=1.1) as expected but HC and CO emissions respectively follow the opposite trend.

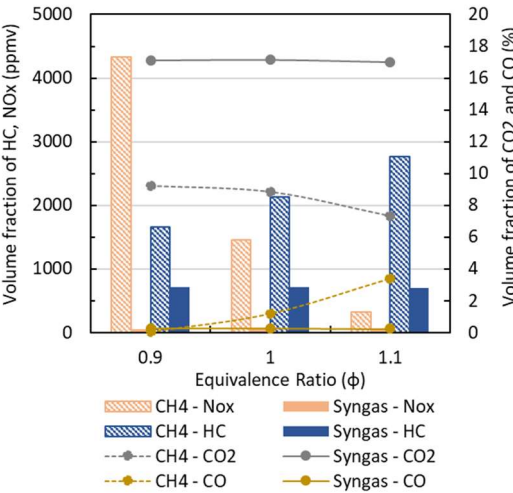

Figure 6: Comparison of exhaust emissions for syngas and pure methane for 3 equivalence ratios at 1 bar of intake pressure

3.2 Syngas blended with ammonia performances

Figure 7.a. and b. show the in-cylinder pressure and HRR evolution as a function of ammonia addition in syngas at 1.2 bar intake pressure and $\phi=1.0$. Their peaks values do not seem affected by the presence of ammonia in the fuel, only a small change on combustion duration can be distinguished. Since IMEP is the integral of the in-cylinder pressure, more indicated work is then obtained when ammonia is added due to the increase of LHV and energy input (Table IV), as it can be seen in Figure 8, for 1 bar and 1.2 bar intake pressure. According to this figure, the addition of NH3 to the syngas' mixture increases the IMEP. As expected, and already highlighted for pure syngas, the 20% intake pressure increase enables to increase the IMEP of more than 1 bar, more than 22%, without any knock occurrence.

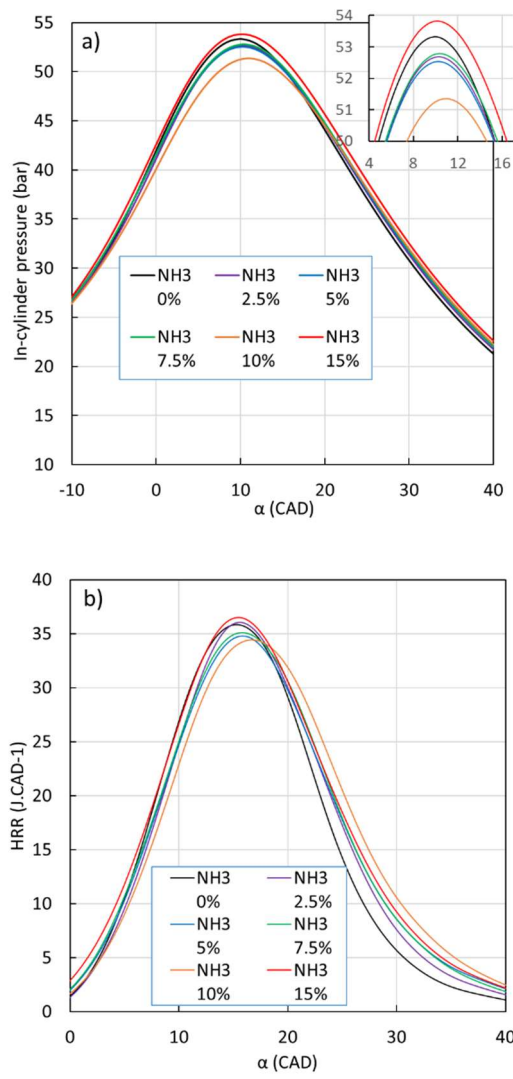

Figure 7: In-cylinder pressure (a) and HRR evolution as a function of ammonia content (%Vol), in the syngas/ammonia blend at 1.2 bar intake pressure – $\phi=1$

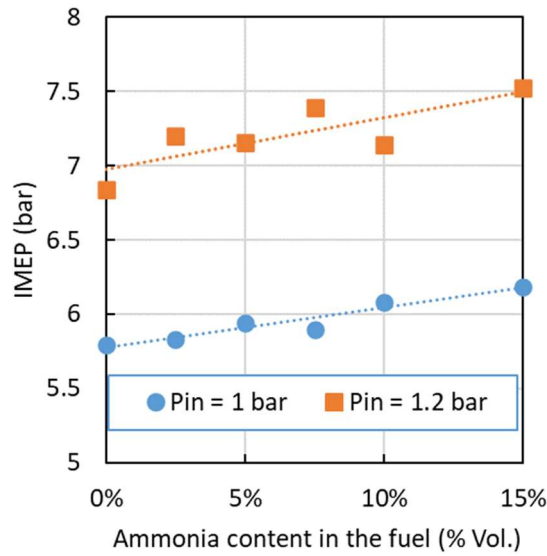

Figure 8: IMEP of syngas as a function of the ammonia content for both intake pressures – $\phi=1$

Figure 9 displays the evolution of optimized spark ignition timing (SIT) as a function of ammonia content in the syngas/ammonia blend. The optimized value is set when the IMEP is at its highest. When ammonia is added, the SIT must be advanced (from 23 CAD with pure syngas to 35 CAD with 15% ammonia). These SIT guarantee stable conditions whatever the ammonia content in the blend with a COV_{IMEP} around 1%, apart 15% ammonia at 1.2 bar, where COV_{IMEP} reaches up to 4%.

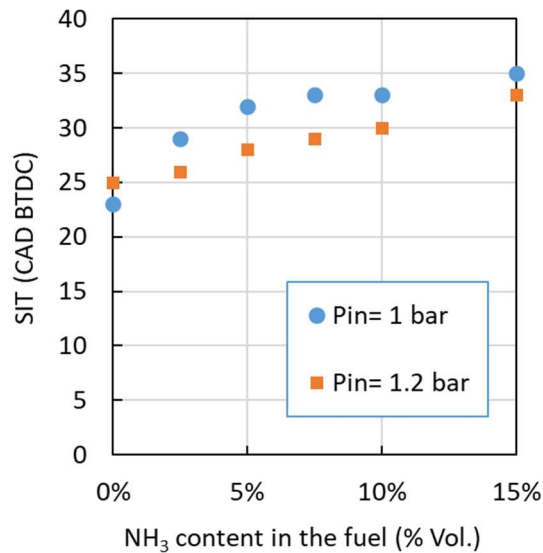

Figure 9: Optimised SIT as a function of ammonia content in syngas for two intake pressures – $\phi=1$

Figure 10 shows the evolution of indicated efficiency as a function of the ammonia content in syngas: for both

intake pressures, a slight decrease can be observed with the increase of ammonia content from $\eta_i=36\%$ for pure syngas until 35% when 15% ammonia is added. This decrease remains yet restrained without significant tendency with the intake pressure increases.

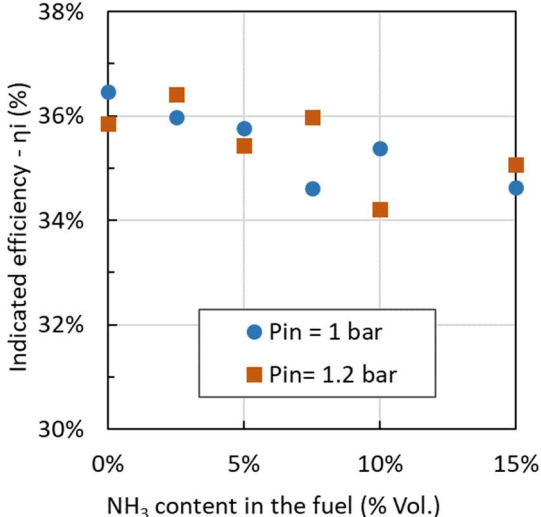

Figure 10: Indicated efficiency as a function of ammonia content in the blend for both intake pressures – $\phi=1$

The addition of ammonia in the blend has an impact on the different combustion durations as highlighted in Figure 11. The greater the concentration is, the longer the start of the combustion will last, mainly due to the low flame speed of ammonia as demonstrated in Lhuillier et al. [23,37].

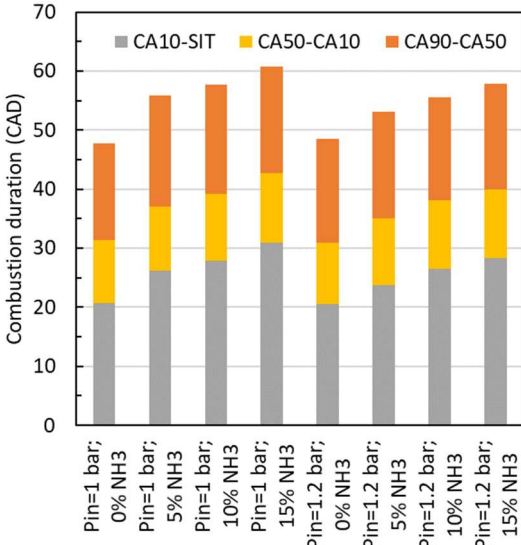

Figure 11: Combustion duration analysis of syngas as a function of the ammonia content in the blend for both intake pressures – $\phi=1$

To confirm this analysis, CA10-SIT and CA50-CA10 are plotted against the laminar flame speed estimated by kinetics OD simulations with the in-cylinder pressure and temperature at SIT conditions as initial conditions. Figure 12 indicates how the initiation phase strongly depends on the laminar flame speed: the higher the flame speed the shorter the CA10-SIT. The highest flame speed (65.1 cm/s) is reached for pure syngas and the lowest (29.1 cm/s) for the 15%NH3 in blend. Yet, the decrease of the flame speed as function of the ammonia content in the blend is twofold: i) the lower flame speed of ammonia which decreases the flame speed of the blend; ii) because of this lower flame speed, the SIT value must be advanced to keep the best IMEP with the lowest cycle to cycle variations (Figure 9), thus leading to different in-cylinder pressure and temperature conditions. During the initial phase, the flame is not yet strongly affected by the turbulence inside the combustion chamber. On the contrary, for the self-sustained propagation phase, i.e. CA50-CA10, the combustion duration is constant as function of the laminar flame speed. Once the combustion is well initiated, i.e. after CA10, the flame-turbulence interaction would enable a better oxidation of the fuel, counterbalancing the impact of ammonia.

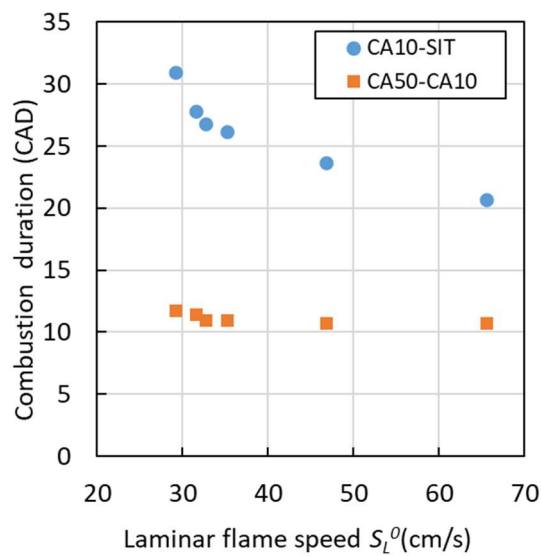

Figure 12: Combustion duration as function of the laminar flame speed calculated at SIT conditions and for intake pressure of 1 bar – $\phi=1$

The Figure 13 displays the evolution of the exhaust emissions as function of the ammonia content. Once ammonia is introduced into the fuel, the NOx emissions increase drastically: from 50 ppmv without ammonia to 2000 ppmv with just only 2.5% of ammonia in the fuel. However, after this jump, NOx emission is not sensitive to the ammonia content and remains around 2100 ppmv, due to the different kinetic mechanisms of nitrogen “fuel road” [38], involving a set of recombination reactions between ammonia and oxygen to form NOx. Indeed, the

adiabatic flame temperature (estimated with kinetics simulations), one parameter to enhance thermal NO_x production, is not really affected by this small addition of ammonia: about 2130 K constant from 0 to 7.5% of ammonia and a slight increase up to 2165 and 2186 K for 10 and 15%NH₃ respectively. The combustion efficiency might explain the stabilisation of NO_x emissions as the amount of unburned ammonia tends to rise which prevent from further oxidation and thus NO_x production. Since the HORIBA analyser cannot measure ammonia at the exhaust, this statement is still uncertain if this stabilisation is caused by a mitigation between the high NO_x concentration and oxidation or if the combustion of ammonia is incomplete.

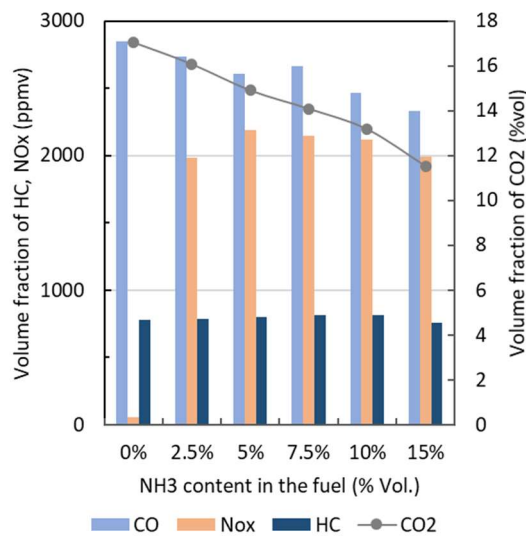

Figure 13: Evolution of syngas emissions as function of ammonia content at 1 bar intake pressure

The Figure 14 shows the evolution of the combustion efficiency with the addition of ammonia content by using Eq. 4 and 5. As observed, the combustion efficiency calculated from pollutants (Eq. 4) seems stable through the entire campaign with a 98.2% average efficiency at 1 bar intake and a 98.3% average efficiency at 1.2 bar intake. This result proves the low impact of the exhaust gases HC and CO on the combustion efficiency regardless of the intake pressure and ammonia content. The second estimate (Eq. 5) clearly indicates a decreasing trend with the addition of ammonia from 94% with 0% NH₃ to 87% with 15% NH₃ at 1 bar intake pressure, highlighting that a larger part of the fuel is unburned as the ammonia is added. Unlike the first approach, the second one considers the unburned part of ammonia in the exhaust gas. As seen above, since the combustion efficiency is not affected by the HC and CO, its decrease is mainly due to the rise of unburned part of ammonia as the share of ammonia in the syngas increase. Also, increasing the intake pressure tends to improve the combustion efficiency from 86.9% with 15%NH₃ at 1 bar to 93.9% with 15% NH₃ at 1.2 bar. Hence, a fewer quantity of unburned ammonia might be present in the exhaust gas at higher intake pressure. The O₂ combustion efficiency decrease as function of the

ammonia content is also less pronounced when increasing the intake pressure: from 97% at 0% NH₃ down to 94% at 15% NH₃.

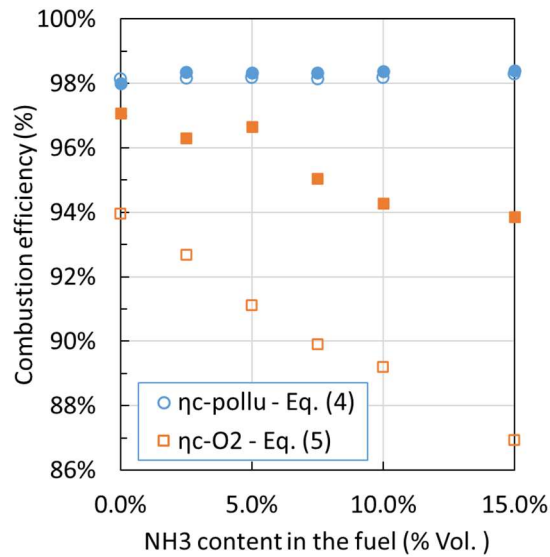

Figure 14: Combustion efficiency of syngas as a function of ammonia content calculated from Eq.4 and 5.

Empty symbols: intake pressure of 1 bar; Filled symbols: intake pressure of 1.2 bar

4 CONCLUSION

In this work, a syngas composition, representative of sewage sludge feedstock on SI engine performances and exhaust emissions was studied. First, a comparison with pure methane was established and confirmed that the global performances with syngas were decreased in comparison to those with CH₄ only. However, increasing the intake pressure (only by 20%) showed that slightly boosted operation allows to reach similar performances. In the other hand, fuelled an engine with syngas exhibits less pollutant emissions than with methane and especially NO_x ones. Secondly, syngas was blended with small ammonia amount (maximum 15% volume) to evaluate the impact of this impurity specie, which can be present after the gasification process. The presence of ammonia induces an increase of the energy content in the fuel, which provides higher output produced work. But with this syngas specific composition, the presence of ammonia tends to slow down the global flame speed hence to extend the combustion duration and to slightly decrease the indicated efficiency. The NO_x emissions of the 15% ammonia-added syngas were comparable to the methane whereas HC and CO showed lower values for the ammonia-syngas blend compared to methane. However, for the highest additions of ammonia (10 and 15% vol), the combustion efficiency decreases probably because of the amount of unburned ammonia in the exhaust especially for

atmospheric intake pressure.

Thus, ammonia impurities produced through gasification with a N-rich sample might not be as disadvantageous as expected to be used in genset if a catalytic exhaust aftertreatment system is mounted because of the amount of NO_x and possible unburned ammonia emissions. The lack of quantification about the exhaust ammonia is also an issue to conclude entirely on the ammonia-added syngas properties and should be further investigated. It could be also interesting to study experimentally the fundamental properties of ammonia syngas blends such as laminar flame speed in order to validate potential kinetic mechanisms.

As a perspective, the usage of ammonia could potentially be beneficial in financial and technological terms since it could save a purification process during the gasification or because blending syngas from waste on one side and ammonia as an e-fuel on the other side could increase the flexibility of the system and prevent from shortage.

5 REFERENCES

- [1] H. Wu, M.A. Hanna, D.D. Jones, *Biomass and Bioenergy* 54 (2013) 260–266.
- [2] B. Dastjerdi, V. Strezov, M.A. Rajaeifar, R. Kumar, M. Behnia, *J. Clean. Prod.* 290 (2021) 125747.
- [3] F. Ardolino, U. Arena, *Waste Manag.* 87 (2019) 441–453.
- [4] D. Schweitzer, A. Gredinger, M. Schmid, G. Waizmann, M. Beirow, R. Spörl, G. Scheffknecht, *Biomass and Bioenergy* 111 (2018) 308–319.
- [5] H. Chen, Y. Wang, G. Xu, K. Yoshikawa, *5* (2012) 5418–5438.
- [6] H. Zhan, X. Zhuang, Y. Song, X. Yin, C. Wu, *Appl. Energy* 219 (2018) 20–33.
- [7] G.-L. Noemí, A. Zainab, A. María, F. Isabel, *J. Clean. Prod.* (2020) 124417.
- [8] A.V. Bridgwater, *Fuel* 74 (1995) 631–653.
- [9] M. Aznar, M.S. Anselmo, J.J. Manyà, M.B. Murillo, *Energy and Fuels* 23 (2009) 3236–3245.
- [10] Y.K. Choi, J.H. Ko, J.S. Kim, *Energy* 118 (2017) 139–146.
- [11] F. Pinto, H. Lopes, R.N. André, M. Dias, I. Gulyurtlu, I. Cabrita, *Energy and Fuels* 21 (2007) 2737–2745.
- [12] H. Zhan, X. Zhuang, Y. Song, X. Yin, J. Cao, Z. Shen, C. Wu, *Chem. Eng. J.* 344 (2018) 320–331.
- [13] J. Zhang, Y. Tian, J. Zhu, W. Zuo, L. Yin, *J. Anal. Appl. Pyrolysis* 105 (2014) 335–341.
- [14] A. Anca-Couce, P. Sommersacher, N. Evic, R. Mehrabian, R. Scharler, *Fuel* 222 (2018) 529–537.
- [15] J.P. Cao, L.Y. Li, K. Morishita, X. Bin Xiao, X.Y. Zhao, X.Y. Wei, T. Takarada, *Fuel* 104 (2013) 1–6.

- [16] O.S. Djandja, Z.-C. Wang, F. Wang, Y.-P. Xu, P.-G. Duan, *Ind. Eng. Chem. Res.* 59 (2020) 16939–16956.
- [17] M. Fiore, V. Magi, A. Viggiano, *Appl. Energy* 276 (2020) 115415.
- [18] S. Szwaja, K. Cupial, in: 18th World Hydrog. Energy Conf., Essen, Germany, 2010.
- [19] S. Szwaja, V.B. Kovacs, A. Bereczky, A. Penninger, *Fuel Process. Technol.* 110 (2013) 160–166.
- [20] S. Bhaduri, F. Contino, H. Jeanmart, E. Breuer, *Energy* 87 (2015) 289–302.
- [21] R. Rabello de Castro, P. Brequigny, C. Mounaïm-Rousselle, *Fuel* 318 (2022) 123736.
- [22] S. Tsiakmakis, D. Mertzis, A. Dimaratos, Z. Toumasatos, Z. Samaras, *Fuel* 122 (2014) 126–139.
- [23] C. Lhuillier, P. Brequigny, N. Lamoureux, F. Contino, C. Mounaïm-Rousselle, *Fuel* 263 (2020) 116653.
- [24] S. Grannell, D. Assanis, D. Gillespie, S. Bohac, in: *Proc. ASME Intern. Combust. Engine Division 2009 Spring Tech. Conf.*, Milwaukee, Wisconsin, USA, 2009.
- [25] C.S. Mørch, A. Bjerre, M.P. Gøttrup, S.C. Sorenson, J. Schramm, *Fuel* 90 (2011) 854–864.
- [26] C. Lhuillier, P. Brequigny, F. Contino, C. Rousselle, *SAE Tech. Pap.* (2019).
- [27] C. Lhuillier, P. Brequigny, F. Contino, C. Mounaïm-Rousselle, *Fuel* 269 (2020) 117448.
- [28] C. Mounaïm-Rousselle, A. Mercier, P. Brequigny, C. Dumand, J. Bouriot, S. Houillé, *Int. J. Engine Res.* (2021) 146808742110387.
- [29] C. Mounaïm-Rousselle, P. Bréquigny, C. Dumand, S. Houillé, *Energies* 2021, Vol. 14, Page 4141 14 (2021) 4141.
- [30] E. Koch, *J. Inst. Pet.* 31 (1949) 21–32.
- [31] E.C. Okafor, Y. Naito, S. Colson, A. Ichikawa, T. Kudo, A. Hayakawa, H. Kobayashi, *Combust. Flame* 187 (2018) 185–198.
- [32] Gregory P. Smith, David M. Golden, Michael Frenklach, Nigel W. Moriarty, Boris Eiteneer, Mikhail Goldenberg, C. Thomas Bowman, Ronald K. Hanson, Soonho Song, William C. Gardiner, Vitali V. Lissianski, Zhiwei Qin, (n.d.).
- [33] Z. Tian, Y. Li, L. Zhang, P. Glarborg, F. Qi, *Combust. Flame* 156 (2009) 1413–1426.
- [34] R. Rabello de Castro, P. Brequigny, J.P. Dufitumukiza, C. Mounaïm-Rousselle, *Fuel* 301 (2021) 121025.
- [35] E. Monteiro, M. Bellenoue, J. Sotton, N.A. Moreira, S. Malheiro, *Fuel* 89 (2010) 1985–1991.
- [36] J. Zheng, J. Wang, Z. Zhao, D. Wang, Z. Huang, *Appl. Therm. Eng.* 146 (2019) 738–751.
- [37] C. Lhuillier, P. Brequigny, F. Contino, C. Mounaïm-Rousselle, *Proc. Combust. Inst.* 38 (2020) 5859–5868.
- [38] K.P. Shrestha, C. Lhuillier, A.A. Barbosa, P. Brequigny, F. Contino, C. Mounaïm-Rousselle, L. Seidel, F. Mauss, *Proc. Combust. Inst.* 38 (2021) 2163–2174.

6 ACKNOWLEDGEMENTS

- This work was made possible by the financial support of the CNRS/FITe (FR2036): “Fédération pour l’Innovation et la Transition énergétique”.
- The Authors are grateful to B. Raitiere of Univ. Orléans, PRISME for technical support.