



HAL
open science

Impact of Thermal Cycling Frequency on IGBT Power Module Lifetime

Guillaume Pellecuer, Jean-Jacques Huselstein, Thierry Martiré, François Forest, André Chrysochoos, Olivier Arnould

► **To cite this version:**

Guillaume Pellecuer, Jean-Jacques Huselstein, Thierry Martiré, François Forest, André Chrysochoos, et al.. Impact of Thermal Cycling Frequency on IGBT Power Module Lifetime. PCIM Europe 2022, International Exhibition and Conference for Power Electronics, Intelligent Motion, Renewable Energy and Energy Management, May 2022, Nuremberg, Germany. 10.30420/565822120 . hal-03668732

HAL Id: hal-03668732

<https://hal.science/hal-03668732>

Submitted on 16 May 2022

HAL is a multi-disciplinary open access archive for the deposit and dissemination of scientific research documents, whether they are published or not. The documents may come from teaching and research institutions in France or abroad, or from public or private research centers.

L'archive ouverte pluridisciplinaire **HAL**, est destinée au dépôt et à la diffusion de documents scientifiques de niveau recherche, publiés ou non, émanant des établissements d'enseignement et de recherche français ou étrangers, des laboratoires publics ou privés.

Impact of Thermal Cycling Frequency on IGBT Power Module Lifetime

Guillaume Pellecuer^{1,2}, Jean-Jacques Huselstein¹, Thierry Martiré¹, François Forest¹, André Chrysochoos², Olivier Arnould²

¹ IES, Montpellier University, CNRS UMR5214, France

² LMGC, Montpellier University, CNRS UMR5508, France

Corresponding author: Guillaume Pellecuer, guillaume.pellecuer@umontpellier.fr

Abstract

The paper presents the impact of thermal cycling frequency on the lifetime of IGBT power module. The first part will be devoted to a quick presentation of the test bench. Then, the test protocols will be detailed as well as the measurement protocol to characterise the ageing of the power module wirebonds. An important part will be devoted to the results of ageing. Before concluding, mechanical tensile tests on bondwires will complete the ageing tests.

1 Introduction to the power module reliability

Semiconductor power modules are active components widely used in electrical power conversion. Their use in many fields such as electric vehicles, networks interconnection for example, makes the reliability of this component an important issue.

In normal operation, these devices are subject to variations in electrical loadings which, through the Joule effect, create cyclic thermal stresses within the assembly. As the module consists of a stack of different materials, cyclic thermal variations lead to mechanical strains which are limited by the mechanical cohesion of the assembly. These strains then lead to the development of mechanical stresses within the module, particularly in the upper part (bonding, metallization, die, solder). The appearance of these mechanical stresses then leads to the appearance of ageing mechanisms.

In many applications, the cycling thermal frequencies are low, a few tenths of a Hz for temperature ranges of around 50 °C. These thermal cycling lead to very long lifetime (a few months or years). The study of ageing by means of experimental tests therefore involves long test times. These test times justify the need for accelerated ageing tests. This is possible if the lifetime of the

modules is not dependent on the cycling frequency. Then, the main objective of this study is to analyse the possibility of accelerated testing.

2 IGBT module and experimental test bench

This study focuses on IGBT modules (MICROSEMI APTGT200A60T3AG 600V-200A), representative of the current technology. This module is an inverter leg and is made of two elementary switches (2 IGBT chips associated with 2 diodes). Fig. 1 shows the module being studied.

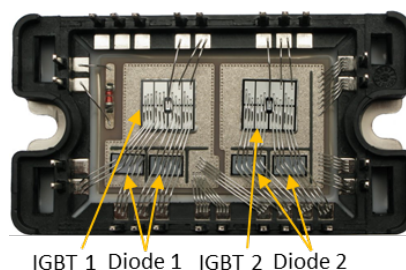

Fig. 1: IGBT Power module

The test benches (Fig. 2) used to provide the results presented below have been described in previous papers [1][2]. The tested IGBT modules are assembled in pairs to form a pulse width modulated inverter (full bridge) feeding an inductive load allowing to use the opposition method in order to provide only the losses of the converters. The

digital control of the inverter by an FPGA allows the bench to be used in a wide range of electrical stresses and therefore to study a wide range of thermal cycle profiles.

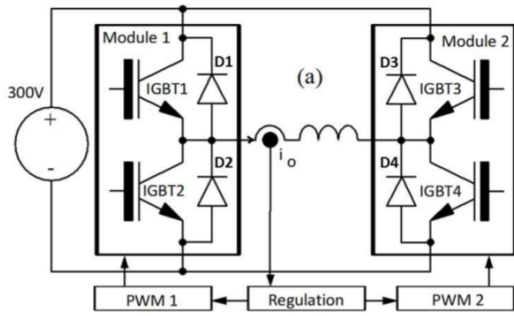

Fig. 2: IES power test bench schema

To generate the thermal power cycling, the current in the load inductor can be modulated in amplitude and frequency. The switching frequency can be varied to adjust the power profile. The current shapes are configurable for to maximize the junction temperature while respecting the maximum current allowed in each module. Figure 3 shows an example of a current shape.

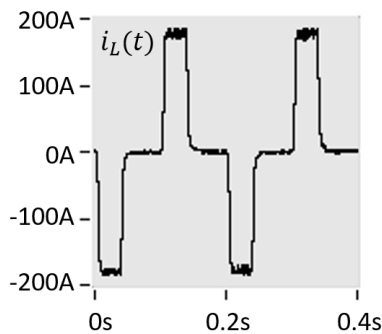

Fig. 3: Current in inductive load

3 Accelerated ageing protocol

To check whether there is a frequency dependence of the lifetime, three different cycling frequencies were applied: 0.1 Hz, 1 Hz and 5 Hz. The range of the junctions temperature variation was set at 50 °C for all cycling tests with a minimum temperature of 80 °C. This value is close to the maximal values typically encountered in embedded applications and is therefore realistic. The temperature variation of the junctions is achieved by modulating the conductive and switching losses of the components. The minimum cycle temperature is set by the air cooling system.

In addition, it induces reasonable test durations and

previous tests have shown that aging modes are similar for lower temperatures, at a given frequency [2]. Before each measurement campaign, a thermal study is carried out on each module to determine the necessary electrical parameters to obtain the desired thermal profile at a given frequency. To do this, the modules are prepared for analysis by infrared thermography [3] (silicone gel removed, black paint applied to improve emissivity). The Tab. 1 shows the electrical parameters used for the different test frequencies.

Power cycling frequency	0.1Hz	1Hz	5Hz
Mode	Sinus current	Sinus current	Trapeze current
Amplitude	110A	80A	170A
Switching frequency	15.26kHz	37.23kHz	24.41kHz
Duty cycle	0.5	0.5	0.5
Temperature base plate	71°C	65°C	52°C

Tab. 1: Power cycling electrical parameters

The trapezoidal current mode corresponds to operation with a trapezoidal current shape (Fig. 3). This mode maximises the thermal cycle amplitude while respecting the maximal current allowed in the IGBT chips [4].



Fig. 4: Infrared thermography measurement

The temperature variation measurement is the result of the average of eight temperature measurements on defined areas near the bonding foot (Fig. 4). Each of the eight zones is also the result of the integration of each pixel defined in the zone. Fig. 5 shows the different thermal profiles measured with an infrared thermal camera directly on the IGBT chip.

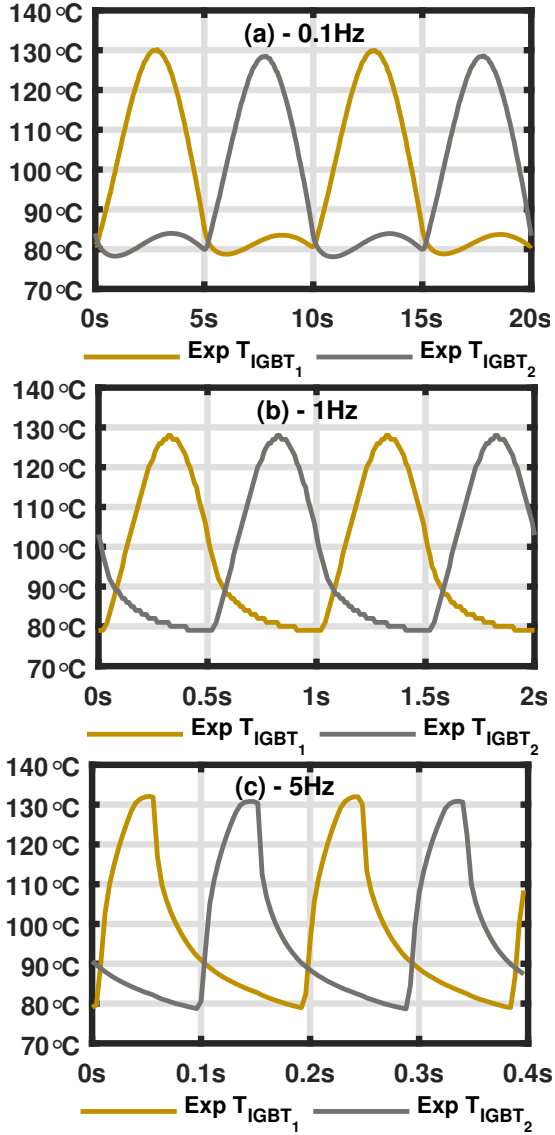

Fig. 5: Junction temperature profiles for 0.1 Hz, 1 Hz and 5 Hz

4 V_{CE} monitoring

The ageing indicator chosen in the monitoring of the samples is the collector emitter voltage drop V_{CEsat} in the on state of the IGBT [5]. By injecting a high current into the IGBT to be analysed, we can detect an increase in the voltage drop V_{CEsat} which would reflect the degradation of the bonding wires (lift off)[6]. The on-state voltage drop of IGBT depends on the injected current I_c , the control voltage V_{GE} and the junction temperature T_j (Fig. 6). To be valid, this measurement must be performed under constant parametric conditions (same V_{GE} , I_c , T_j).

In this test campaign, the junction tempera-

ture was not measured, contrary to what had been done in previous work [7]. The choice of the injected current makes it possible to circumvent this difficulty by choosing an operating point where the temperature dependence of V_{CEsat} is low. The characteristic in Fig. 6 shows that for a current I_c of 75A, this voltage V_{CE} varies little with temperature.

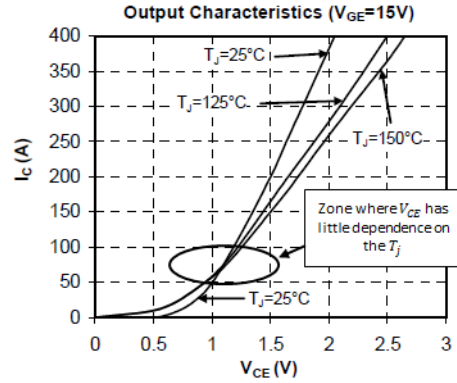

Fig. 6: $V_{CE}(I_c, T_j)$ pour $V_{GE} = 15V$

An assessment of the temperature impact on the increase in V_{CE} voltage was carried out beforehand. The 75A current is imposed using a current-limited power supply. The V_{GE} voltage is maintained at 15V. The temperature control of the bench allows the reference temperature to be set at 60°C. With these constraints, the losses in an IGBT are 90W resulting in a junction temperature T_j of 85°C. Assuming a test stop for a 10% increase in V_{CEsat} (9W of added losses), the increase in junction temperature would be about 2.5°C for the same current.

$$- T_{ref} = 60^\circ C, V_{CE_{T1}} = 1.2440V \text{ and } V_{CE_{T2}} = 1.2258V$$

$$- T_{ref} = 70^\circ C, V_{CE_{T1}} = 1.2497V \text{ and } V_{CE_{T2}} = 1.2314V$$

The difference of about 6mV obtained for two reference temperatures, separated by 10°C, corresponds to a variation of 0.5% in the V_{CEsat} measurement. It can therefore be seen that the impact of a temperature uncertainty on the detection of an increase between 5 and 10% is not significant.

A measurement of V_{CE} , the on-state voltage drop, is performed every 50 000 cycles to estimate the ageing of the connections. The estimated end-of-life time of the IGBT modules is the number of cycles for which an increase in the V_{CE} voltage of 3 to 5% is detected [7].

5 Ageing results

About ten samples were studied according to the protocols described above. The on-state voltage drop of the IGBTs is monitored to detect an increase in the order of 3-10%, indicating component failure [8]. After each test the module is prepared (dissolving the silicone gel) for analysis under a SEM (Scanning Electron Microscopy) to observe the state of the wirebond. The Fig. 7 shows the state of the bonding wires and a metallization before power cycling.

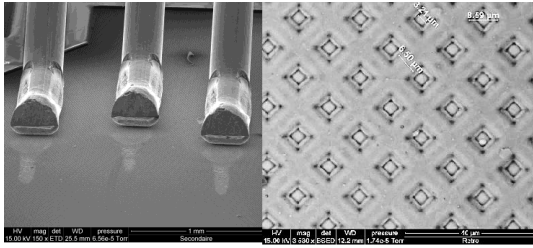

Fig. 7: SEM view of an IGBT chip before power cycling.

The frequency of 0.1Hz is representative of the cycling frequency experienced by the modules in traction applications for example. It can then be considered as a reference for cycling tests. For a ΔT_j of 50°C the lifetime is around 400 000 cycles. The disadvantage of testing at 0.1Hz is that the tests can take up to 2 months. Tests at 1Hz and 5Hz were then carried out to drastically reduce the test time.

The Fig. 8 shows the evolution of the on-state voltage drops of the IGBT ΔV_{CE} during cycling for the three selected frequencies.

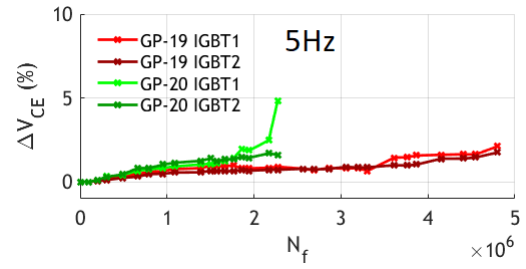
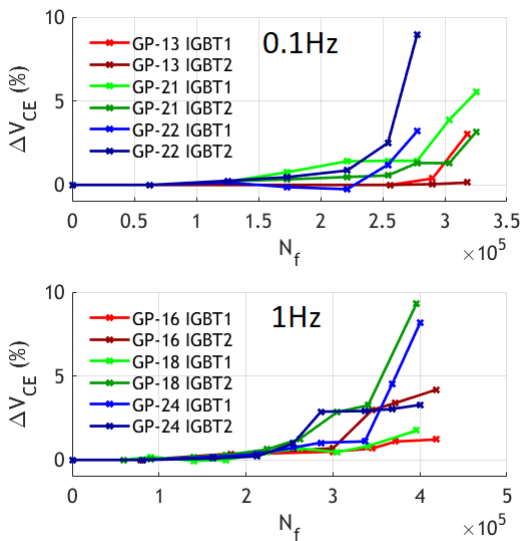

Fig. 8: V_{CEsat} evolution for 0.1 Hz, 1 Hz and 5Hz

For 0.1Hz and 1Hz, the evolution of ΔV_{CE} suggests degradation of the connections in the upper part of the module reflecting a wirebond lift-off. SEM analyses confirm this hypothesis (Fig. 9). For 5Hz, the lifetime is much higher. We can then observe degradations by wirebond lift-off but also reconstructions of the transmitter metallization.

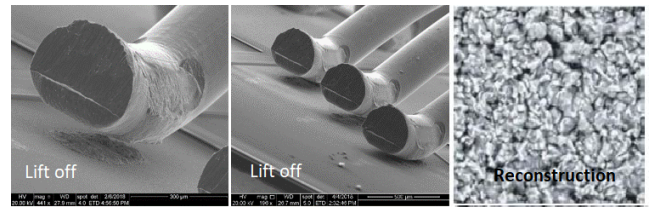

Fig. 9: Wirebond lift-off and metallization reconstruction

Fig. 10 shows the lifetime values measured on 4 to 6 samples for the different frequency values (each bar is a sample). Results obtained under similar conditions in a previous study, for a cycling frequency of 2Hz [2], have been added to complete this data.

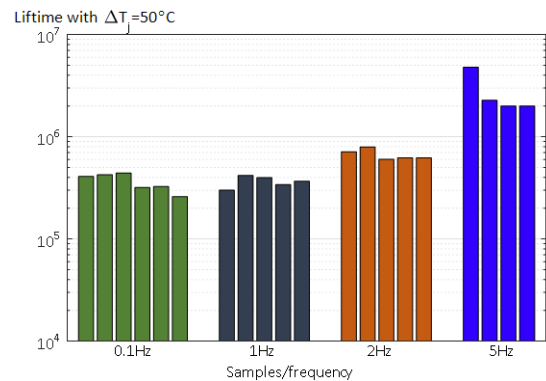

Fig. 10: Lifetime vs power cycling frequency

The results are similar for 0.1Hz and 1 Hz, considering the unavoidable disparities in device manufacturing and the difficulty in setting strictly the same thermal cycle for all samples. For 2Hz, lifetime increases significantly (about 50%). For 5 Hz, it increases drastically (ratio of 5 to 10,

the two latests 5Hz bars in Fig. 10 correspond to samples for which the test was stopped at 2 000 kcycles without any measured V_{CE} increase).

This test campaign highlights the impossibility of using time-temperature dependence to study the lifetime of power modules. The observed lifetime can increase by one decade with increasing frequency for the same temperature amplitude [9][10]. The duration of the thermal pulse is an important issue to consider. This may be due to the visco-thermo-elasto-plastic behaviour of the junction zone, which may no longer be excited when the cycling frequency becomes too high. Another possible explanation is related to the temperature propagation time. Indeed, for high frequencies (>1 Hz), the temperature gradient cannot propagate on the surface of the chip, thus reducing the thermal amplitude under the bonding wire, which would lead to an increase in the lifetime [9].

6 Tensile tests on aluminium wires

To analyse the influence of cycling speed and temperature on the mechanical characteristics, ten different tensile tests were performed using a TA Electroforce® 3230 mechanical test instrument equipped with a hot-cold chamber and controlled by dedicated software.

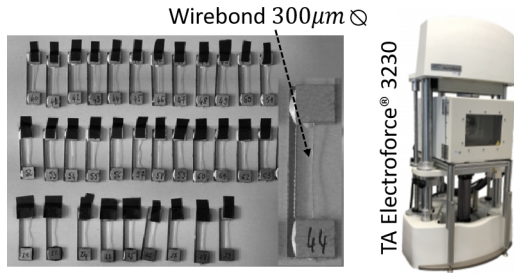

Fig. 11: Experimental setup for tensile tests

For these tests, test specimens were specially manufactured with $300\mu\text{m}$ diameter bonding wire made of aluminium. The grips for the two machine attachments (jaws) were made with a U-shaped FR4 support frame. This shape prevents damage and plastic deformation when handling the specimen and mounting it in the test fixture, it ensures correct alignment of the specimen and finally, it prevents slippage in the jaws during the test. The aluminium wire is bonded into the frame using a high thermal performance epoxy adhesive.

The choice of thermal conditions is based on previous experimental tests. Indeed, for the temperature, we have chosen five values (25°C , 50°C , 80°C , 100°C , 130°C) which are function of the amplitudes of the thermal cycles. For the displacement speeds, previous numerical tests with a elasto-plastic mechanical curves shows a displacement speeds in order to 0.001s^{-1} and 0.01s^{-1} for 0.1 Hz and 1Hz cycling frequencies.

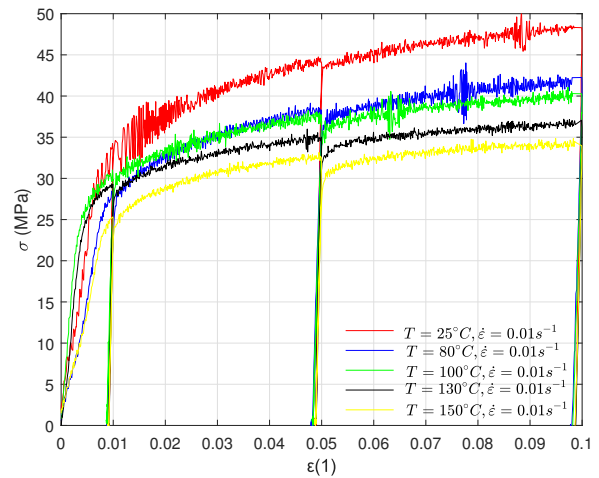
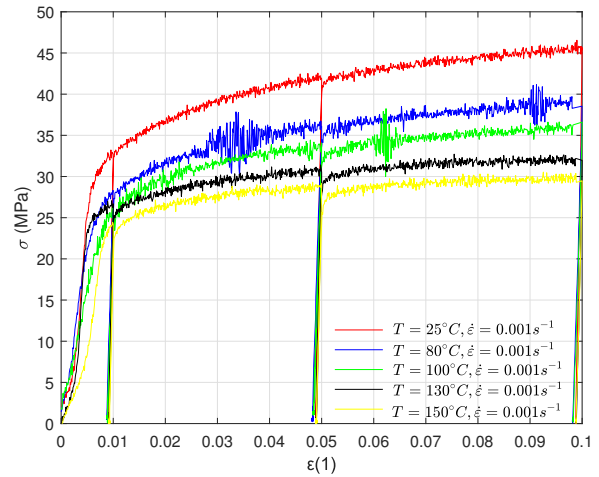

Fig. 12: Uniaxial stress-strain curves

The results of stress-strains curves are shown in Fig. 12. It should be noted that in these tests there is an initial stiffening due to the realignment of the sample in the machine. The Young's modulus measured in this way is not representative of the sample. In order to measure the Young's modulus, several elastic discharges during the cycle were carried out. For each test parameter, several samples were used and provided the same mechanical response to validate the repeatability of the tests.

The curves obtained shows an impact of the deformation rate reflecting a viscous behaviour of the material. In fact, during an imposed strain (thermal expansion in the context of ageing of adhesives), the stress increases when the speed increases. Consequently, the higher the stress rate, the greater the energy required to deform a material. However, this effect remains relatively small. It can also be seen that for a given strain, the stress decreases as the temperature increases. The material is more ductile.

These tests show that the time-temperature equivalence cannot be verified. However, due to the small influence of the strain rate, accelerated ageing tests can be performed under one condition. It is necessary that the thermal cycle, whatever the frequency, is identical in shape to have identical lifetimes and equivalent ageing modes. This aspect explains why our results at 5Hz are so different. Given the power requirements and thermal module inertia, we cannot have the same thermal profiles at 1Hz as at 5Hz.

7 Conclusion

This paper presents the development of a test methodology focused on bonding aging, one of the weak points in power modules subject to active thermal cycling modes. The main objective is to define all the necessary conditions for defining accelerated tests whose results are representative of the reality of industrial applications.

In the paper, results of numerous aging tests carried out over different campaigns were presented, highlighting the possibility of applying cycling frequencies much higher than real frequencies while preserving degradation modes. Conversely, they also show a change in behavior if those frequencies become too high, indicating the likely existence of viscoplastic behavior but also the impact of the shape of the thermal cycle. However, they also show the possibility of accelerated testing but with a limit on the frequency of cycles.

References

- [1] F. Forest, J.-J. Huselstein, S. Faucher, M. Elghazouani, P. Ladoux, *et al.*, "Use of opposition method in the test of high-power electronic converters," *IEEE Transactions on Industrial Electronics*, vol. 53, no. 2, pp. 530–541, 2006. DOI: 10.1109/TIE.2006.870711.
- [2] F. Forest, A. Rashed, J.-J. Huselstein, T. Martiré, and P. Enrici, "Fast power cycling protocols implemented in an automated test bench dedicated to IGBT module ageing," *Microelectronics Reliability*, vol. 55, no. 1, pp. 81–92, 2015. DOI: <https://doi.org/10.1016/j.microrel.2014.09.008>.
- [3] A. Chrysochoos, "Infrared thermography applied to the analysis of material behavior: a brief overview," *Quantitative InfraRed Thermography Journal*, vol. 9, no. 2, pp. 193–208, 2012. DOI: 10.1080/17686733.2012.746069.
- [4] F. Forest, J.-J. Huselstein, G. Pellecuer, and S. Bontemps, "A power cycling test bench dedicated to the test of power modules in a large range of cycling frequency," in *PCIM Europe 2017; International Exhibition and Conference for Power Electronics, Intelligent Motion, Renewable Energy and Energy Management*, 2017, pp. 1–7.
- [5] C. Durand, M. Klingler, D. Coutellier, and H. Naceur, "Power cycling reliability of power module: A survey," *IEEE Transactions on Device and Materials Reliability*, vol. 16, no. 1, pp. 80–97, 2016. DOI: 10.1109/TDMR.2016.2516044.
- [6] A. Hamidi, N. Beck, K. Thomas, and E. Herr, "Reliability and lifetime evaluation of different wire bonding technologies for high power igt modules," *Microelectronics Reliability*, vol. 39, no. 6, pp. 1153–1158, 1999, European Symposium on Reliability of Electron Devices, Failure Physics and Analysis. DOI: [https://doi.org/10.1016/S0026-2714\(99\)00164-X](https://doi.org/10.1016/S0026-2714(99)00164-X).
- [7] V. Smet, F. Forest, J.-J. Huselstein, A. Rashed, and F. Richardeau, "Evaluation of Vce Monitoring as a Real-Time Method to Estimate Aging of Bond Wire-IGBT Modules Stressed by Power Cycling," *IEEE Transactions on Industrial Electronics*, vol. 60, no. 7, pp. 2760–2770, 2013. DOI: 10.1109/TIE.2012.2196894.
- [8] G. Coquery and R. Lallemand, "Failure criteria for long term accelerated power cycling test linked to electrical turn off soa on igt module. a 4000 hours test on 1200a–3300v module with alsic base plate," *Microelectron-*

ics Reliability, vol. 40, no. 8, pp. 1665–1670, 2000, Reliability of Electron Devices, Failure Physics and Analysis. DOI: [https://doi.org/10.1016/S0026-2714\(00\)00191-8](https://doi.org/10.1016/S0026-2714(00)00191-8).

[9] R. Bayerer, T. Herrmann, T. Licht, J. Lutz, and M. Feller, “Model for Power Cycling lifetime of IGBT Modules - various factors influencing

lifetime,” in *5th International Conference on Integrated Power Electronics Systems*, 2008, pp. 1–6.

[10] U. Scheuermann and R. Schmidt, “A New Lifetime Model for Advanced Power Modules with Sintered Chips and Optimized Al Wire Bonds,” May 2013.