



HAL
open science

A multi-physics approach to condition monitoring of SiC power module

Malorie Hologne-Carpentier, Jean-François Mogniotte, Minh-Quyen Le, Bruno Allard, Guy Clerc, Pierre-Jean Cottinet

► **To cite this version:**

Malorie Hologne-Carpentier, Jean-François Mogniotte, Minh-Quyen Le, Bruno Allard, Guy Clerc, et al.. A multi-physics approach to condition monitoring of SiC power module. *Microelectronic Engineering*, 2021, 250, pp.111633. <10.1016/j.mee.2021.111633>. <hal-03662540>

HAL Id: hal-03662540

<https://hal.science/hal-03662540v1>

Submitted on 16 Oct 2023

HAL is a multi-disciplinary open access archive for the deposit and dissemination of scientific research documents, whether they are published or not. The documents may come from teaching and research institutions in France or abroad, or from public or private research centers.

L'archive ouverte pluridisciplinaire **HAL**, est destinée au dépôt et à la diffusion de documents scientifiques de niveau recherche, publiés ou non, émanant des établissements d'enseignement et de recherche français ou étrangers, des laboratoires publics ou privés.



Distributed under a Creative Commons CC BY-NC 4.0 - Attribution - Non-commercial use - International License

A multi-physics approach to condition monitoring of SiC power module

*Malorie Hologne-Carpentier*¹, *Jean-François Mognotte*^{2,3}, *Minh-Quyen Le*³, *Bruno Allard*⁴,
*Guy Clerc*⁴, *Pierre-Jean Cottinet*^{3*}.

¹ Univ. Lyon, ECAM Lyon, LabECAM, 69005 Lyon, France

² HYBRIA Institute of Business and Technologies, Écully Campus, 69130 Écully, France

³ Univ. Lyon, INSA Lyon, LGEF, F-69100 Villeurbanne, France

⁴ Univ. Lyon, Université Lyon 1, AMPERE, F-69100 Villeurbanne, France

*Corresponding author : pierre-jean.cottinet@insa-lyon.fr

Abstract— Power electronics addresses an ever-growing market with challenges in many fields as in transportation and aerospace. Power electronic conversion is one of the most appropriate way to reduce weight and volume in systems, especially in severe environment like in aeronautics. Power converters are modular and basically constituted of power semiconductor modules. It is well-known that the reliability of the whole system is strongly affected by the power module performances. In the perspective of achieving high reliability power converters, the online condition monitoring (CM) is a promising approach to detect aging and failure issues in power modules. This article proposes to investigate the role of a passive sensor, i.e. a strain gauge, to be considered in the design of planar power module (without bonding) based on Silicon Carbide (SiC) MOSFETs. The sensor is combining electrical, thermal and mechanical health indicators. After an analysis of failure modes expected in a lab-scale power module, an experimental test bench for measuring such indicators is introduced. Signatures of failures are analyzed in accordance with failure occurrences. Particularly, initial results using a strain gauge are discussed and compared to other sensor responses (especially based on V_{dsON} , voltage between the drain and the source of the transistor when conducting). Promising results are established as well as limitations and future work.

Keywords—Health monitoring, strain sensor, power microelectronic system, Remaining Useful Lifetime.

I. INTRODUCTION

Power electronic systems are more and more present in the field of electrical transportation. The suppression of hydraulic and pneumatic systems in aeronautics for the benefit of power electronic systems is one way to reduce weight and volume, leading to an expected increase in reliability as well as simple maintenance. Power electronic converters encompass a lot of devices of different varieties but with one central component, the power semiconductor module. The power module technologies are various and allow a real modularity of converter functions and performances. Module technologies target better power module performances (efficiency, better usage of semiconductor area) as well as a certain level of reliability. For instance, to improve the size and volume of passive power components, SiC MOSFETs have been exploited thanks to a higher power density and switching speed compared to silicon counterparts [1]. However, the SiC MOSFET is still affected by a weakness at the gate interface, limiting a widely industrial usage so far [2]. At power module level, standard wires or ribbon bonds introduce parasitic effects as well as a reliability weakness that could be overcome by innovative planar power modules [3]. A double-side interconnection of the SiC MOSFETs has been investigated and demonstrated at lab-scale level [4,5]. Advanced thermal approaches are also considered for a better performance-to-weight ratio. The analysis of

the performances of the module technology includes accelerated tests with respect to aging and possible failure modes. When a module technology is not mature, it can provoke module failures due to electro-thermal aging in a limited period of time and in a large variety.

To improve the reliability of power components, several studies have recently identified some degradation mechanisms that can lead to clear definitions of aging indicators [6–8]. Usually, the tested component is subjected to thermal and/or electrical stress cycles (in either short circuit or avalanche mode) to monitor its failure behavior via electrical indicators [9,10]. After long-term aging tests, the power module, to some extent, may be exposed to strong thermomechanical and/or electrical stresses. In such severe conditions, aging is accelerated, inducing degradations in the circuit [11]. This paper suggested an alternative indicator of mechanical type using a commercial strain gauge, which has been, for the first time, implemented into the converters for online condition monitoring (CM). The proposed technique, by considering the multi-physics couplings of the component (i.e., electrical-thermal-mechanical conversion), allows in situ failure monitoring of SiC MOSFET transistor. Furthermore, an internal quantification of the strain values produced during aging process is reported. The developed sensing methodology is revealed to be an effective tool to design future power components, with a particular focus on their safety.

Another aspect of this work is to demonstrate the practical implementation of a condition monitoring (CM) strategy, giving a simple way to qualify the health state of the power module during its lifespan so as to organize a predictive maintenance. Adding improvements to the module technology as well as exploiting predictive remaining useful life (RUL) evaluation are supposed to accelerate innovative module technologies at similar cost of operation (before failure) with benefit on efficiency. The CM will be empirically built based on a multi-physics coupling approach, together with implementation of several health indicators in terms of electrical, thermal and mechanical aspects. The integration of such indicator measurements shows a high potential for CM, particularly demanding applications of power electronic converters.

II. CONDITION MONITORING FOR DETECTION OF FAILURE MODES

A potential application for condition monitoring (CM) concerns integration of sensor inside the power electronic module [12,13]. Indeed, CM has the objective of improving production reliability, increasing safety and gaining more knowledge with respect to a given application. Production reliability provides shorter and fewer planned production stops and fewer unplanned stops, meaning higher fabrication efficiency and a predictable manufacturing. Enhancing safety means early warnings to avoid breakdowns and hazardous situations. Increased application-related knowledge enables the analysis of root causes of failures that facilitate process and reduce maintenance cost. Wileman *et al.* proposed an approach of CM by using physics of failure methodology to infer fast and accurate lifetime predictions for power electronics at the printed-circuit-board level in early design stages. However, this method only relied on the model prediction, which makes online monitoring impossible. With increasingly complex processes, real-time monitoring is becoming more and more important in the industrial world [14].

Conventional monitoring of machines and processes has often resulted in external instrumentation and sensors being installed around the application. This approach has a number of inherent disadvantages, such as susceptibility to vibration and the need for additional protection or shielding in order to operate effectively [15]. Particularly for some applications in aerospace, this approach is not effective. Integration of sensors is always a challenge, especially when the surface is not flat. For instance, a direct deposition method, without the need of gluing an interface, could overcome this technological barrier in the development of smart component. Establishing the foundations for this future in electronics and instrumentation represents an emerging direction for research. For instance, D'ambrogio *et al.* [16] developed a piezoelectric sensor directly attached on the surface of a ball bearing. Such a device delivered

a real-time electric signal perfectly correlated to the vibration signature of bearing, making failure detection possible.

Recently, CM is considered as an efficient method for detection of different failure modes. Power modules are complex systems involving several material types. Failure modes are numerous and have been reported in literature [3]. A review allows to identify the most expected failure modes in the considered power module technology such as planar SiC MOSFET, Aluminum top metallization, and copper top interconnection [17,18]. The prototype used in this study is given in Figure 1, where the power MOSFET is a CREE bare die (C2M0025120D). The details of the planar technology are not important here as the paper focuses on the CM strategy [19]. The non-mature technology will provide modules with various failures, which can be supported via experimental implementation of the health monitoring approach.

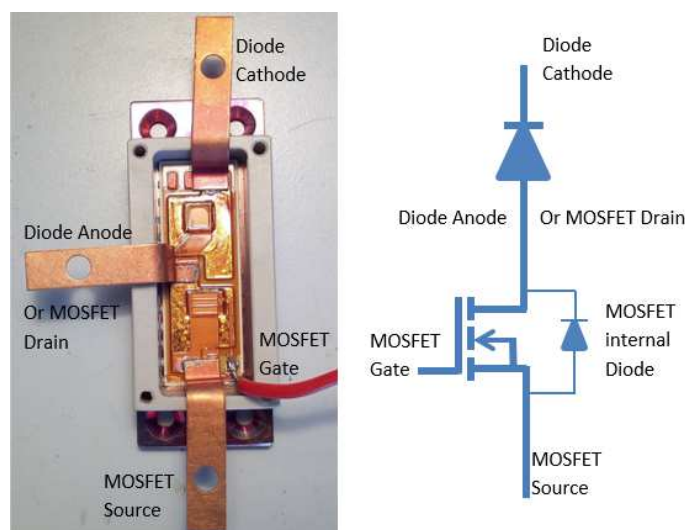

Figure 1: Power module prototype with bare die SiC MOSFET and SiC diode.

The first issue concerns the SiC MOSFET gate interface. It has been shown in [9,20] how the gate-oxide is vulnerable to electric field effects generated from the gate driver, which can lead to serious thermal issues. The first issue is related to failure mechanism that engenders a progressive perforation of the oxide until a complete breakdown. The second issue is related to the die environment. The drain side of the die is connected to a bus bar thanks to a solder layer through which the heat is drained off. The source side of the die is connected to a bus bar thanks to a top planar metallization. This layer is very thin and exposed to heat variation and can present failure mechanisms as electro migration, voids creation, cracks establishment or layers lift-off [21]. As it is well-known, the common point about failure mechanism establishment is the thermal constraint. Accelerated lifetime experiments support the investigation based on thermal cycling to trigger failure modes. A large quantity of parameters is recorded in real time during the tests so as to obtain information on the failure mechanisms.

III. MULTI-PHYSICS TEST BENCH

Prognostics activity deals with the estimation of the remaining useful life (RUL) of a physical system based on its current health state and its future operating conditions. RUL estimation can be achieved by using two main approaches, namely model-based and data-driven approaches [22]. The first approach is based on the utilization of physics of failure models of the degradation, while the second approach is based on the data provided by the sensors that represent the behavior or consequence of the degradation. This paper deals

with a data-driven prognostics method, where the RUL of the physical system is assessed depending on its critical component. Once the critical component is identified, and the appropriate sensors installed, the data provided by these sensors are exploited to analyze the aging behavior of the components. Power semiconductor devices are one of the major causes of the power converter failures, among the components that are susceptible to failure [23]. Figure 2 summarizes the RUL methodology relying on composition of failure signatures [24].

In order to identify failure signatures relative to expected failure modes, power cycling (PC) tests have been considered [25]. It exists two ways for applying a thermal constrains on a power electronic system: a passive and an active cycling. The passive cycling consists in a succession of heating and cooling phase thanks to a dedicated thermal environment. This methodology of test is expensive and not representative for failure mode appearance during a normal operation of the device. Alternatively, in active cycling, the PC tests are composed of heating and cooling phases, but the heating is obtained by turning ON the device under given conditions (self-heating phenomenon) and the cooling is obtained thanks to a normal use of convective cooling. By the way, the obtained failure modes are closer to the ones triggered under normal operation.

In our experimental tests, 50 electrical and thermal parameters have been recorded in primary power cycling tests. A correlation analysis against the level of stress has been carried out to select the 10 most sensitive parameters (listed in Figure 2). At this step, we have to face a data analysis issue. If we keep a 10-dimension signature plane, the methodology of classification will be quite complex, and if we reduce the number of parameters in the signature plane, we may lose details on the failure modes. It has been decided to keep the 10 parameters but to reduce the dimension of the signature set using a principal component analysis reduction. Once the reduced signature is obtained, we have performed a supervised classification extracting the signature at time-stamp periods of lifetime in the learning phase. Several classes are then identified against which we have compared different methodologies of classification using the identified signatures. The most significant results were obtained using a neural network-based approach which is available to evaluate the RUL for other modules.

Figure 3(a) illustrates the wiring diagram of the power electronic circuit. The electrical parameters are recorded online through specific sensors and an oscilloscope (Tektronix DPO) coupled with a LabVIEW interface, as displayed in Figure 3(b). The drain current is measured differently in the two types of online characterizations of PC tests: with a LEM sensor during the “Double pulse” characterization and through an accurate shunt during the characterization of Temperature Sensitive Electrical Parameters (TSEP). The gate-to-source and drain-to-source voltages are recorded with large bandwidth voltage probes (Tektronix TPP). The gate current is captured with a Tektronix CT6 current probe. The so-called junction temperature evaluation is obtained via TSEPs with an adequate calibration method [26]. Alternatively, a real-time analysis of thermo-mechanical strain on the component has been carried out, thanks to the experimental setup performed in Figure 3(c). As illustrated in Figure 3(d), a strain gauge (commercialized by HBM) has been affixed on the module top metallization using X60 adhesive. The tested module is bonded thanks to copper connectors pressed over the chip and covered by an insulating resin. The source connector is equipped with the strain gauge stucked on the conduction path to the module terminal. As a matter of fact, it tends to limit the influence of the sensor on the chip. The strain gauge is attached to the copper connector, equidistant between the chip and the module terminal: it occupies the half of the connector width. As shown in Figure 3(d), the covered surface exhibited by the sensor is quite small compared to the source pad footprint.

The strain gauge used in this study is a passive transducer that enables to convert a mechanical displacement into a change of resistance. It is a thin, wafer-like device that can be easily mounted onto the electronic component by a suitable adhesive to measure the applied strain. As the structure is stressed, the resulting strain deforms the strain gauge attached to the structure. It causes an increase in the resistivity of the gauge which produces an electrical signal proportional to the deformation [27]. Since the change of resistance is

very small, the strain gauge is operated via a Wheatstone full-bridge circuit. When selecting a strain gauge, one must consider not only the strain characteristics of the sensor (linearity, accuracy, sensitivity), but also its stability and temperature sensitivity. Unfortunately, the most desirable strain gauge materials are also sensitive to temperature variations and tend to change in nominal resistance under aging. For tests of short duration, this may not be a serious concern, but for continuous industrial measurement, the temperature drift compensation should be considered. In this study for aging tests, the temperature variation is actually compensated as the duration of the measurement is quite important (i.e., for several hours). Since the strain amplitude is larger than 10 μ -strain, high gauge factor do not seem necessary [28]. For that reason, a classical strain gauge with a factor of 2 made of copper-nickel alloys mounted on polyimide substrate has been selected.

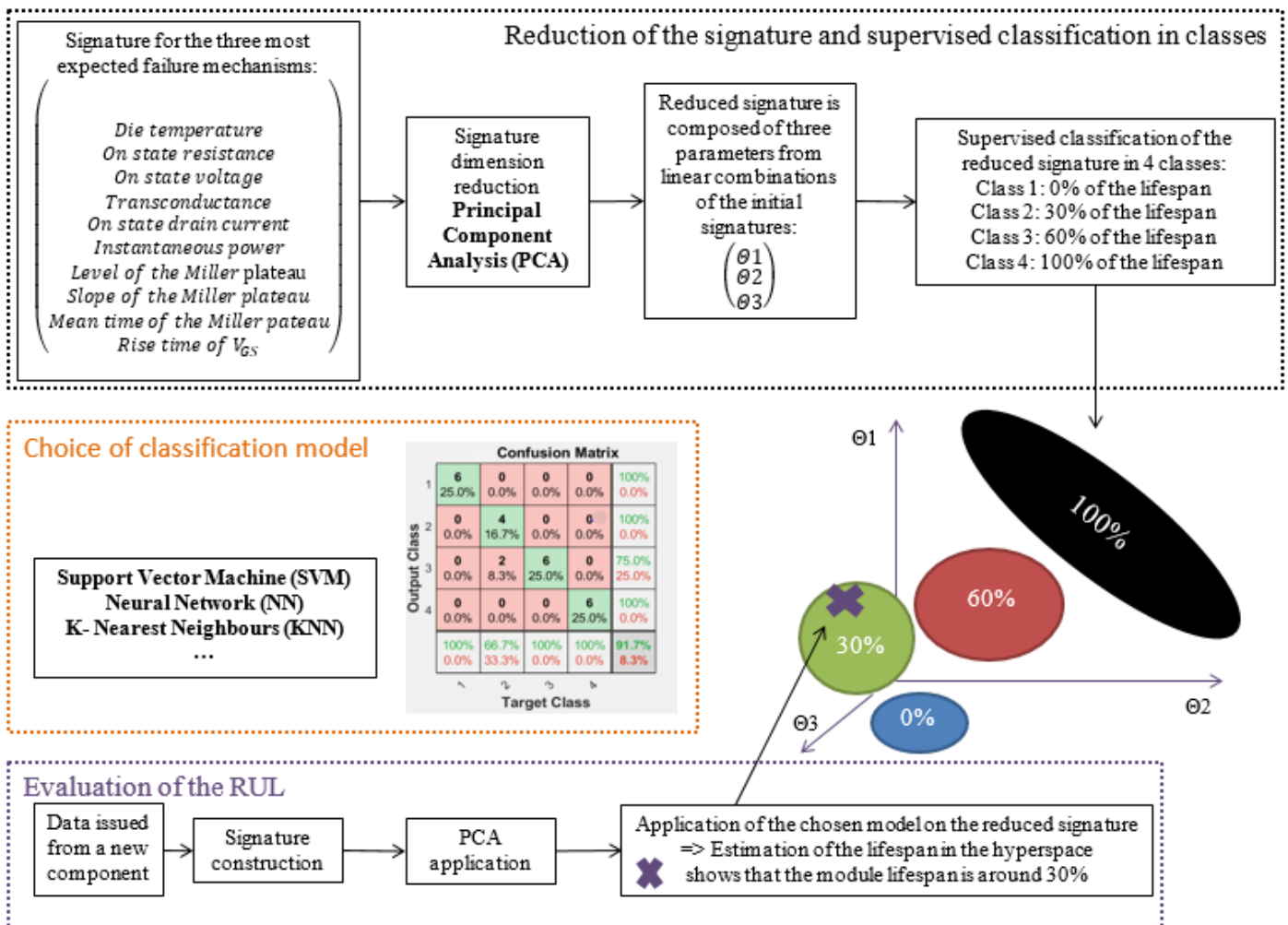

Figure 2: Methodology for the Remaining useful lifetime (RUL) estimation.

It is noteworthy that the strain gauge is quite easy to implement onto the module and it is very sensitive to module mechanical aging. Moreover, the sensor does not modify the system operation. There is no reliability impact otherwise the area penalty to install the sensor. The sensor signals are recorded during two PC tests for several hours in order to compare the strain gauge response to the classical failure signature. Real-time data are monitored via a commercial acquisition card (DEWE Sirus). Post-data treatment was performed using MATLAB@mathworks software. As a PC test is a thermal cycling, the signal recorded

by the gauges represents the plastic strains on the module top metallization. The strain response is considered to be an image of the thermo-mechanical behavior of the die that impacts its health state [29]. It is worth reminding that there is no load variation during a power cycling test. This assumption can be validated if the strain measurement shows good correlation with the known failure signature.

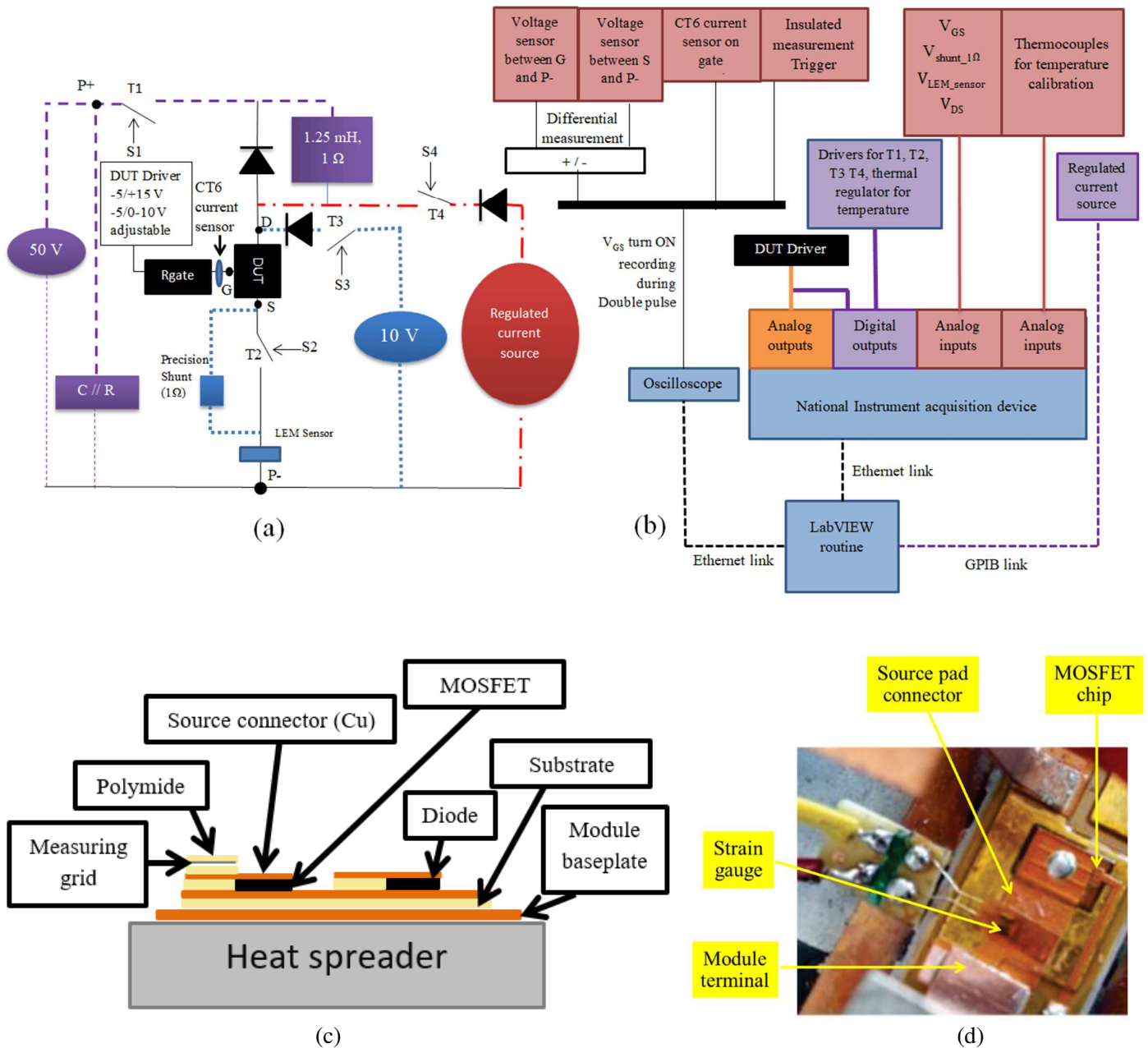

Figure 3. Experimental setup. (a) Electrical synopsis of the PC tested circuit; (b) Details on test bench measurement implementation; (c) Schematic cut view of the module equipped with the strain gauge; and (d) Strain gauge implemented on top metallization using X60 adhesive.

IV. RELEVANCE OF THE MULTI-PHYSICS APPROACH WITH RESPECT TO FAILURE SIGNATURE

Two module prototypes (namely #16 and module #19) have been instrumented with a strain gauge as pictured in Figure 3(c). The devices are module (#16) and module (#19). These two modules have shown different failure modes: a gate short-circuit for (#16) and a drain-to-source short-circuit for (#19). The failure analysis has been carried out with a postmortem static characterization. As shown in Figure 4, the MOSFET undergoes pulses of conduction to produce the self-heating under a voltage of 50V during 1s (300 W as an order of magnitude), the diode undergoes the complementary pulse with a duration of 4s (except for a short time of the MOSFET conduction necessary to realize the TSEP-oriented measurement and the Double Pulse characterization). The current level is imposed by the on-state resistance of the MOSFET (25m Ω) and will change with time according to the deviation of the on-state resistance. As long as the device is switched ON, there is an increase in temperature and a cooling phase when the current is OFF. Under such a temperature change, the MOSFET and the diode periodically expand and contract. Knowing the dilatation coefficient of copper (material used in the MOSFET and diode as top metallization), it is possible to estimate their temperature variation based on the strain measurement. The purpose here is also to demonstrate the correlation between the strain response and aging until failure.

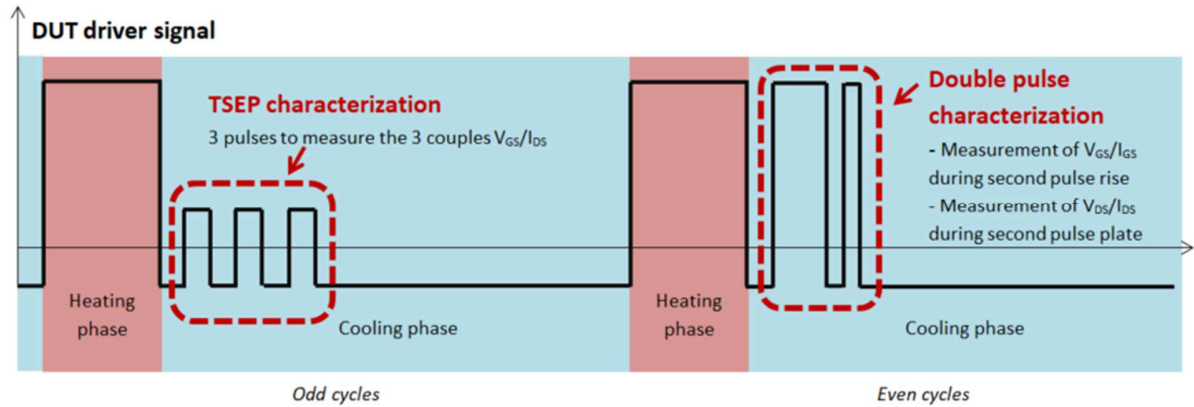

Figure 4: MOSFET gate driving signals of a PC test

The results in Figure 5 clearly reveal three phases of strain measurement, which agree with the typical lifespan of the power module (using the lab-scale technology). At the beginning (i.e., “Youth”), the strain is almost constant, reflecting good health state of the component. On the other hand, higher variation of the strain occurs during the second phase (i.e., “Maturity”), which is probably linked to a material fatigue. Lastly, an excessive increase in the strain amplitude is observed in the third phase (i.e., “End of life”), confirming signs of failure caused by an important mechanical sollicitation.

Figure 6 (a) highlights that during both three phases, the MOSFET top metallization suffer a strain amplitude up to 4-times higher than the one on the diode. This can be explained by the fact that the current rating of the MOSFET is lower than the one of the diode, giving rise to a higher current density hence a higher temperature elevation and thus a higher mechanical dilatation. The diode was voluntarily oversized because the subject of this study was mainly the SiC MOSFET. Furthermore, the results successfully demonstrate a correlation between the strain amplitude and the health state of the device, confirming a good confidence in the proposed approach for prognostics and condition monitoring of power modules. Figure 6 (b) clearly illustrates the strain response of the circuit during two states (ON – OFF) through the PC test. During the heating phase, both components exhibit a first order behavior but not with the same dynamics. Because a lower current rating results in superior heating effect for a given current, the time constant in the strain signal of the MOSFET is smaller than the one of the diode. Actually, the strain evolution of the diode almost linearly increases during the ON state. With a moderate dilatation (i.e., less than 150 μm), this behavior corresponds to the “elastic phase” of the metallization material, which deforms elastically and will

return to its original shape when the device has cooled down. In contrary, the dilatation of the MOSFET top metallization is drastically more significant i.e., from 300 μm (Youth) to 550 μm (End of life). Due to a higher applied current, the strain response quickly reaches a saturation regime. Considering the Young modulus (Y) of Copper is approximately 120 GPa [30], it is possible to determine a corresponding strength (T) generated by the material's dilatation during the "end of life":

$$T = Y \times S \quad (1)$$

where S is the strain in the "end of life" phase (i.e. 550 μm).

The resulting strength is therefore estimated as 66 MPa in average. This value is far from the ultimate tensile strength of Copper (170 MPa – 220 MPa), which characterizes the limit stress at which the material actually breaks, with a sudden release of the stored elastic energy. However, 66 MPa is close to the Yield strength of Copper (around 60 – 70 MPa) [31], i.e., related to the elastic limit above which some fraction of the deformation will be permanent and non-reversible. This result explains why under a deformation close to 550 μm , the component deteriorates quickly. One of the MOSFETs attains its "end of life" after 16 hours of solicitation since the strain signal becomes constant. The two components (MOSFET and diode) are used in a chopper configuration, if one of them fails, the other one cannot conduct the current. A static analysis has been required to determinate that the MOSFET is well responsible of the circuit failure.

In the cooling phase of the PC test, the strain responses of the diode and the MOSFET rapidly drop to the initial state, which is probably related to the fast-cooling mechanism in copper as a result of its high thermal conductivity ($\sim 385 \text{ W/mK}$).

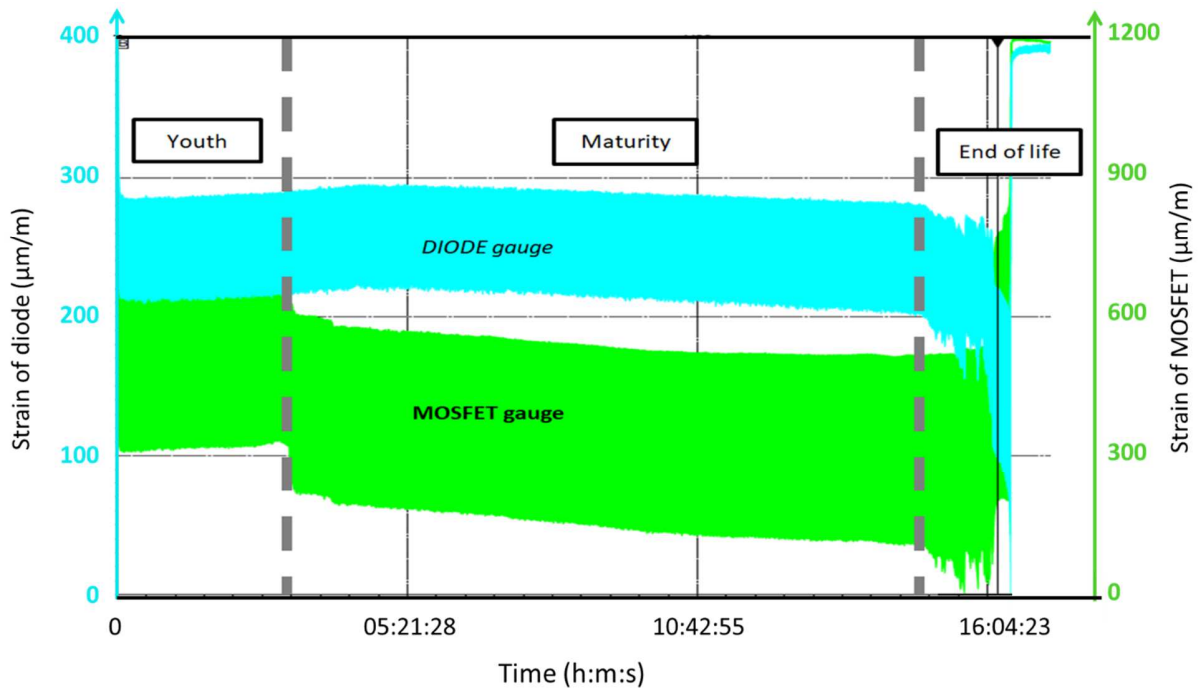

Figure 5. Strain measurement on diode and MOSFET top metallization during module (#16) lifespan under PC

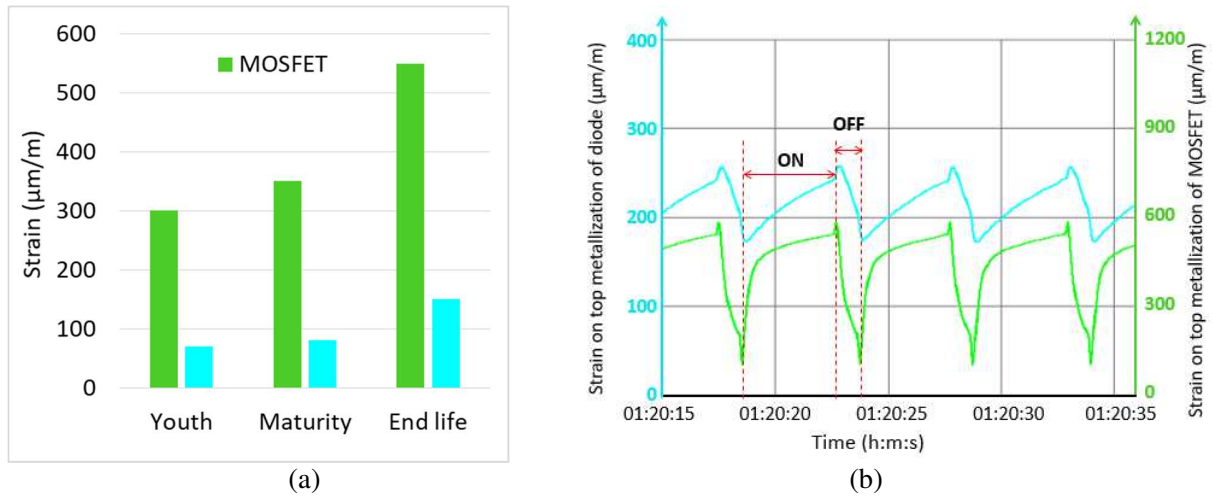

Figure 6. Failure analysis of diode and MOSFET (module #16) based on strain measurement in Figure 2: (a) Strain amplitude typical in the three phases of life, and (b) Time evolution of the strain response (zoom in).

Figure 7 shows the long-term evolution of the strain amplitude during module (#16) lifespan under PC test. Two electrical parameters (On-state current I_{dsON} and voltage V_{dsON}) have been also plotted to compare the failure detection occurrence. All signal amplitudes are normalized for the sake of easier comparison. The choice of these parameters is justified by their accessibility (measurements presented in Figure 3(b)) and their good sensitivity to the different failure modes of a MOSFET. In [25], the correlation between these parameter's drift and aging has been demonstrated using correlation tools: the Spearman coefficient and the Shannon entropy [32]. The current and voltage responses are almost stable after 12 hours of excitation. Subsequently, some oscillations occur over the last 3 hours but there is no significant evolution. These oscillations certainly come from the variation of the internal resistance of the MOSFET under aging. After 16 hours of stress, the module develops a sudden failure as the drain current and the drain voltage drop of nearly 80% and 30% from their initial values, respectively. Similarly, the strain response is nearly constant during the first 15 hours and small fluctuations appear in the last hour. After 16 hours of PC test when the module attains its "end of life", a significant increase of more than 2-times in the strain amplitude has been recorded. The result confirms a satisfying coherence between the strain monitoring and the other indicators based on current and voltage measurements. Accordingly, the strain sensing efficiently manifests the failure mechanisms without the burden of electrical circuit.

Figure 8 depicts the relative variation of different aging indicators including the strain amplitude and V_{dsON} , one of the electrical parameters recorded during the TSEP characterization phase of the PC test. The amplitudes of both parameters have been reported in the bar chart for the two modules studied here, i.e. (#16) and (#19). These two modules are apparently the same (design, components...) but have shown a different failure mode during their post-mortem analysis. That is why it is interesting to represent the variation of the strain and the TSEP parameter amplitudes for both modules and see if the strain response is more sensitive or not to a specific failure mode. Actually, a partial perforation of the gate has been observed in module (#16) and a drain-to-source short-circuit has been observed after failure for module (#19). The strain amplitude has a non-monotonous evolution for module (#16) with a sudden increase in the last part of the life (98%). The MOSFET gate oxide perforation is an abrupt event that is reflected in the waveforms in Figure 7. Indeed, as the perforation is partial, the component is still a controllable switch but once the perforation phenomenon has reached a certain level, the switch function is deteriorated and the response in terms of strain shows it very clearly. The evolution of the electrical parameter is not better than the strain one to detect a gate oxide failure mode. Concerning the module (#19), the observed physical

phenomenon is more gradual as it corresponds to the material degradation in the current path. As a consequence, the electrical parameter and the strain show both a gradual evolution.

These results illustrate the fact that the choice of parameters depends on the most-probable failure modes to be detected. This is where additional PC tests are required to correlate further the strain response to the main failure modes at hand. The analysis of amplitude and time-stamp of changes could be precious indicators of failure modes as well.

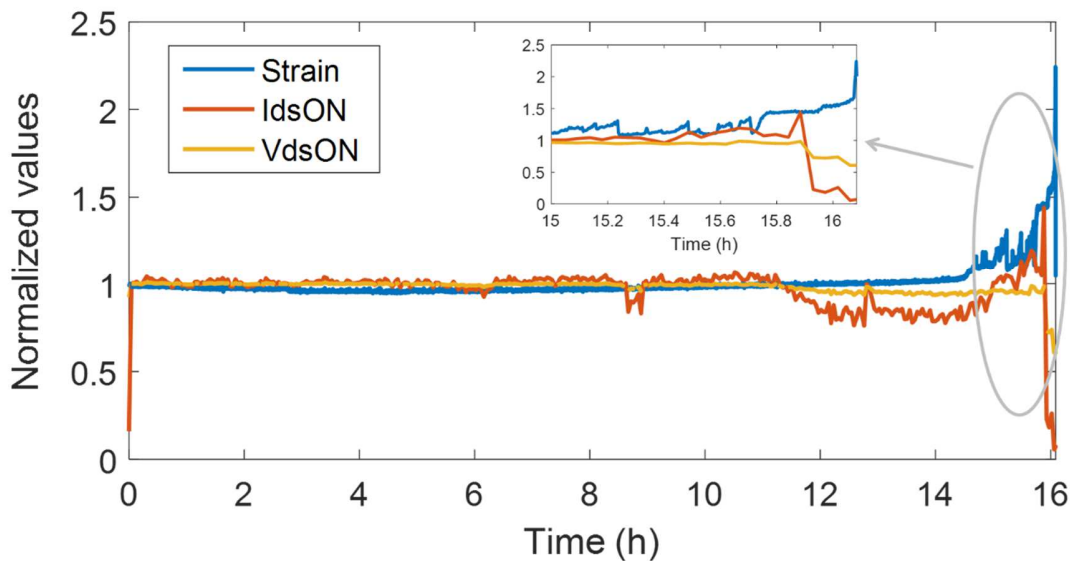

Figure 7. Strain amplitude signal superposed to two electrical parameters (I_{dsON} , and the TSEP V_{dsON}) during module (#16) lifespan. The inset is a zoom-in at the end of lifespan to detect the parameter changes.

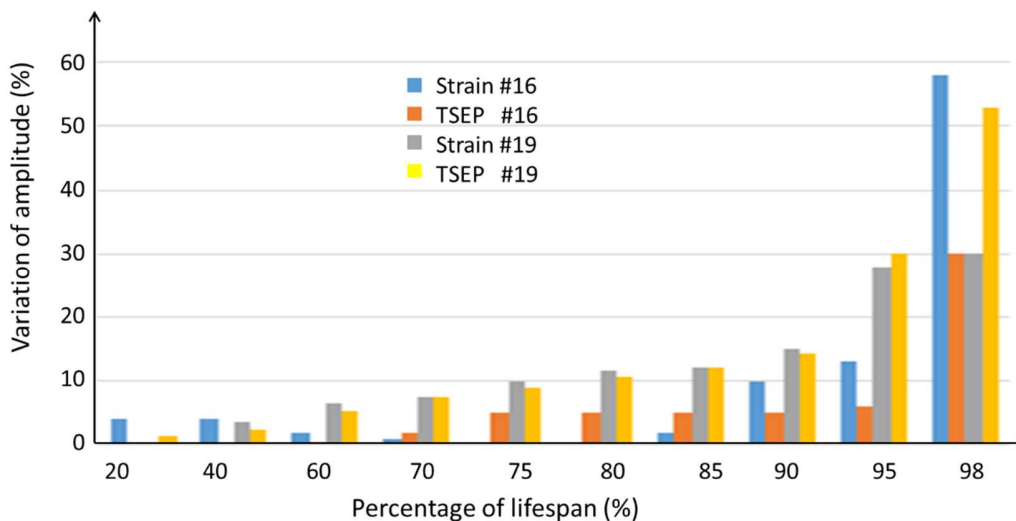

Figure 8. Amplitude variation of the strain and V_{dsON} (TSEP) during lifespan of module (#16) and (#19)

In our study, mechanical strain/stress is a dynamic quantity that evolves in electronic modules through the competing effects of temperature variation, load change, and aging effect. Differentiating the influence of each factor is a true challenge and that should be considered as one of the most priorities in our future research direction. The characterization method would consist in varying one parameter while fixing the others so that to thoroughly understand the effect of each of them. A transformation from experimental data collection to analytical model might be necessary to find the Figure of Merit of the mechanical strain. Based on the strain variation, it is therefore possible to differentiate the impact of each parameter. Another alternative involves analyses correlation between the power consumption and temperature change under different load applications. Long-term observation would be investigated to assess the aging effect. Finally, operating conditions in which the tuning of all system parameters significantly affect the lifetime of power electronic module. It is thus of importance to real-time monitor the device so as to achieve accurate predictions of the RUL under various operating conditions. This is an essential stage for the power management system to ensure reliable operation and timely maintenance.

V. CONCLUSION

This work presents the implementation of a standard strain gauge to record electro-thermal fatigue on a representative layer inside the planar power module. The strain response has been correlated to electrical parameter recordings in the case of two modules with different failure modes at the end of lifespan. The online measurement of strain amplitude does not impact the reliability of the module and would offer an alternative or at least a significant complement to a TSEP-based approach for condition monitoring as an aging indicator.

This work has been carried out using a lab-scale power module. The approach was experimental and have been based on the implementation of many sensors (thermal, mechanical and electrical ones). The paper wishes to detail a methodology of selection of indicative parameters to follow the module aging, then a classification strategy to feed RUL estimator. Among the parameters, the experimental results show that the strain of device top metallization is able to show a relevant variation according to different failure modes. The robustness of this parameter seems to be a good track. Future work focus on the co-fabrication of strain gauges with the module substrate [33]. Another aspect involves integration of multifunctional materials-based printing electronic methods [34–37].

ACKNOWLEDGMENT

This work was based on module prototypes issued from European Horizon 2020 project I²MPECT, grant n°636170.

REFERENCES

- [1] O. Yade, C. Martin, C. Vollaire, A. Bréard, M. Ali, R. Meuret, H. Morel, Improved Layout of Inverter for EMC Analysis, in: Undefined, Bordeaux, France, 2017. <https://www.semanticscholar.org/paper/Improved-Layout-of-Inverter-for-EMC-Analysis-Yade-Martin/2ed23259f9beb0561d67e64d6bf8af86476dfc07> (accessed August 23, 2021).
- [2] O. Avino-Salvado, C. Cheng, C. Buttay, H. Morel, D. Labrousse, S. Lefebvre, M. Ali, SiC MOSFETs robustness for diode-less applications, *EPE Journal*. 28 (2018) 128–135. <https://doi.org/10.1080/09398368.2018.1456836>.
- [3] S. Yang, D. Xiang, A. Bryant, P. Mawby, L. Ran, P. Tavner, Condition Monitoring for Device Reliability in Power Electronic Converters: A Review, *IEEE Transactions on Power Electronics*. 25 (2010) 2734–2752. <https://doi.org/10.1109/TPEL.2010.2049377>.
- [4] L. Chang, W. Zhang, S. Xu, K. Spence, Review on distributed energy storage systems for utility applications, *CPSS Transactions on Power Electronics and Applications*. 2 (2017) 267–276. <https://doi.org/10.24295/CPSSTPEA.2017.00025>.
- [5] O. Raab, M. Guacci, A. Griffio, K. Kriegel, M. Heller, J. Wang, D. Bortis, M. Schulz, J.W. Kolar, Full-SiC Integrated Power Module based on Planar Packaging Technology for High Efficiency Power Converters in Aircraft Applications, in: CIPS 2020; 11th International Conference on Integrated Power Electronics Systems, Berlin, Germany, 2020: pp. 1–6.
- [6] T. Santini, M. Sebastien, M. Florent, L.-V. Phung, B. Allard, Gate oxide reliability assessment of a SiC MOSFET for high temperature aeronautic applications, in: 2013 IEEE ECCE Asia Downunder, 2013: pp. 385–391. <https://doi.org/10.1109/ECCE-Asia.2013.6579125>.
- [7] D. Othman, S. Lefebvre, M. Berkani, Z. Khatir, A. Ibrahim, A. Bouzourene, Robustness of 1.2kV SiC MOSFET devices, *Microelectronics Reliability*. 53 (2013) 1735–1738. <https://doi.org/10.1016/j.microrel.2013.07.072>.
- [8] T.A. Nguyen, S. Lefebvre, S. Azzopardi, Effect of short circuit aging on safe operating area of SiC MOSFET, *Microelectronics Reliability*. 88–90 (2018) 645–651. <https://doi.org/10.1016/j.microrel.2018.06.040>.
- [9] R. Ouaida, M. Berthou, J. León, X. Perpiñà, S. Oge, P. Brosselard, C. Joubert, Gate Oxide Degradation of SiC MOSFET in Switching Conditions, *IEEE Electron Device Letters*. 35 (2014) 1284–1286. <https://doi.org/10.1109/LED.2014.2361674>.
- [10] S. Dusmez, B. Akin, Remaining useful lifetime estimation for degraded power MOSFETs under cyclic thermal stress, in: 2015 IEEE Energy Conversion Congress and Exposition (ECCE), 2015: pp. 3846–3851. <https://doi.org/10.1109/ECCE.2015.7310203>.
- [11] M.G. Ancona, S.C. Binari, D.J. Meyer, Fully coupled thermoelectromechanical analysis of GaN high electron mobility transistor degradation, *Journal of Applied Physics*. 111 (2012) 074504. <https://doi.org/10.1063/1.3698492>.
- [12] S. Yang, D. Xiang, A. Bryant, P. Mawby, L. Ran, P. Tavner, Condition Monitoring for Device Reliability in Power Electronic Converters: A Review, *IEEE Transactions on Power Electronics*. 25 (2010) 2734–2752. <https://doi.org/10.1109/TPEL.2010.2049377>.
- [13] M. Mueller, J. Franke, Feasibility study of piezo jet printed silver ink structures for interconnection and condition monitoring of power electronics components, in: 2017 IEEE 19th Electronics Packaging Technology Conference (EPTC), 2017: pp. 1–5. <https://doi.org/10.1109/EPTC.2017.8277552>.
- [14] S. Kaboli, H. Oraee, *Reliability in Power Electronics and Electrical Machines: Industrial Applications and Performance Models*, Idea Group, U. S, 2016.
- [15] M.Q. Le, J.-F. Capsal, M. Lallart, Y. Hebrard, A. Van Der Ham, N. Reffe, L. Geynet, P.-J. Cottinet, Review on energy harvesting for structural health monitoring in aeronautical applications, *Progress in Aerospace Sciences*. 79 (2015) 147–157. <https://doi.org/10.1016/j.paerosci.2015.10.001>.

- [16] G. D'Ambrogio, O. Zahhaf, Y. Hebrard, M.Q. Le, P.-J. Cottinet, J.-F. Capsal, Micro-Structuration of Piezoelectric Composites Using Dielectrophoresis: Toward Application in Condition Monitoring of Bearings, *Advanced Engineering Materials*. 23 (2021) 2000773. <https://doi.org/10.1002/adem.202000773>.
- [17] H. Ye, M. Lin, C. Basaran, Failure modes and FEM analysis of power electronic packaging, *Finite Elements in Analysis and Design*. 38 (2002) 601–612. [https://doi.org/10.1016/S0168-874X\(01\)00094-4](https://doi.org/10.1016/S0168-874X(01)00094-4).
- [18] M. Musallam, C.M. Johnson, C. Yin, H. Lu, C. Bailey, Real-time comparison of power module failure modes under in-service conditions, in: *2009 13th European Conference on Power Electronics and Applications*, 2009: pp. 1–10.
- [19] O. Raab, K. Kriegel, P. Ghesquiere, Two-layered planar SiC power module for industrial applications, in: *CIPS 2020; 11th International Conference on Integrated Power Electronics Systems*, Berlin, Germany, 2020: pp. 1–4.
- [20] T.-T. Nguyen, A. Ahmed, T.V. Thang, J.-H. Park, Gate Oxide Reliability Issues of SiC MOSFETs Under Short-Circuit Operation, *IEEE Transactions on Power Electronics*. 30 (2015) 2445–2455. <https://doi.org/10.1109/TPEL.2014.2353417>.
- [21] C. Durand, M. Klingler, D. Coutellier, H. Naceur, Confrontation of failure mechanisms observed during Active Power Cycling tests with finite element analyze performed on a MOSFET power module, in: *2013 14th International Conference on Thermal, Mechanical and Multi-Physics Simulation and Experiments in Microelectronics and Microsystems (EuroSimE)*, Cardiff, UK, 2013: pp. 1–4. <https://doi.org/10.1109/EuroSimE.2013.6529900>.
- [22] S. Dusmez, M. Heydarzadeh, M. Nourani, B. Akin, Remaining Useful Lifetime Estimation for Power MOSFETs Under Thermal Stress With RANSAC Outlier Removal, *IEEE Transactions on Industrial Informatics*. 13 (2017) 1271–1279. <https://doi.org/10.1109/TII.2017.2665668>.
- [23] E. Sutrisno, H. Oh, A.S.S. Vasan, M. Pecht, Estimation of remaining useful life of ball bearings using data driven methodologies, in: *2012 IEEE Conference on Prognostics and Health Management*, 2012: pp. 1–7. <https://doi.org/10.1109/ICPHM.2012.6299548>.
- [24] C. Okoh, R. Roy, J. Mehnen, L. Redding, Overview of Remaining Useful Life Prediction Techniques in Through-life Engineering Services, *Procedia CIRP*. 16 (2014) 158–163. <https://doi.org/10.1016/j.procir.2014.02.006>.
- [25] M. Hologne, Contribution to condition monitoring of Silicon Carbide MOSFET based Power Module, phd thesis, Université de Lyon, 2018. <https://tel.archives-ouvertes.fr/tel-02061648> (accessed August 23, 2021).
- [26] A. Griffo, J. Wang, K. Colombage, T. Kamel, Real-Time Measurement of Temperature Sensitive Electrical Parameters in SiC Power MOSFETs, *IEEE Transactions on Industrial Electronics*. 65 (2018) 2663–2671. <https://doi.org/10.1109/TIE.2017.2739687>.
- [27] M.Q. Le, F. Ganet, D. Audigier, J.-F. Capsal, P.-J. Cottinet, Printing of microstructure strain sensor for structural health monitoring, *Appl. Phys. A*. 123 (2017) 354. <https://doi.org/10.1007/s00339-017-0970-x>.
- [28] W. Kester, SECTION 4-3 - Strain, Force, Pressure and Flow Measurements, in: W. Jung (Ed.), *Op Amp Applications Handbook*, Newnes, Burlington, 2005: pp. 247–256. <https://doi.org/10.1016/B978-075067844-5/50131-4>.
- [29] J. Gu, D. Barker, M. Pecht, Health Monitoring and Prognostics of Electronics Subject to Vibration Load Conditions, *IEEE Sensors Journal*. 9 (2009) 1479–1485. <https://doi.org/10.1109/JSEN.2009.2026988>.
- [30] L.M. Xu, X.M. Xie, H. Fan, Polycrystalline aggregates in the thin-wire configuration, *Journal of Applied Physics*. 110 (2011) 084909. <https://doi.org/10.1063/1.3653254>.
- [31] I. Altenberger, H.A. Kuhn, H.R. Müller, M. Mhaede, M.G. Kermanshahi, L. Wagner, Material properties of high-strength beryllium-free copper alloys, *IJMPT*. 50 (2015) 124–146. <https://doi.org/10.1504/IJMPT.2015.067820>.
- [32] C.E. Shannon, A Mathematical Theory of Communication, *Bell System Technical Journal*. 27 (1948) 379–423. <https://doi.org/10.1002/j.1538-7305.1948.tb01338.x>.
- [33] L.E. Aygun, V. Kumar, C. Weaver, M. Gerber, S. Wagner, N. Verma, B. Glisic, J.C. Sturm, Large-Area Resistive Strain Sensing Sheet for Structural Health Monitoring, *Sensors*. 20 (2020) 1386. <https://doi.org/10.3390/s20051386>.

- [34] Z.X. Khoo, J.E.M. Teoh, Y. Liu, C.K. Chua, S. Yang, J. An, K.F. Leong, W.Y. Yeong, 3D printing of smart materials: A review on recent progresses in 4D printing, *Virtual and Physical Prototyping*. 10 (2015) 103–122. <https://doi.org/10.1080/17452759.2015.1097054>.
- [35] Q. Liu, M.Q. Le, C. Richard, R. Liang, P.-J. Cottinet, J.-F. Capsal, Enhanced pseudo-piezoelectric dynamic force sensors based on inkjet-printed electrostrictive terpolymer, *Organic Electronics*. 67 (2019) 259–271. <https://doi.org/10.1016/j.orgel.2019.01.028>.
- [36] J. DeGraff, R. Liang, M.Q. Le, J.-F. Capsal, F. Ganet, P.-J. Cottinet, Printable low-cost and flexible carbon nanotube buckypaper motion sensors, *Materials & Design*. 133 (2017) 47–53. <https://doi.org/10.1016/j.matdes.2017.07.048>.
- [37] D. Grinberg, S. Siddique, M.-Q. Le, R. Liang, J.-F. Capsal, P.-J. Cottinet, 4D Printing based piezoelectric composite for medical applications, *Journal of Polymer Science Part B: Polymer Physics*. 57 (2019) 109–115. <https://doi.org/10.1002/polb.24763>.

Smarter Power Electronic Components – Condition Monitoring

Evolution of power electronic modules

Current state

Future



Mostly TSEP-based sensing



Implementation of strain gauge is an efficient method for improving online condition monitoring of power modules.

Packaging with a defect!

My temperature is XX °C

My residual life is XX cycles

I am not balanced compared to others

