



HAL
open science

Dendrimer nanoplatfoms for veterinary medicine applications: A concise overview

Serge Mignani, Xiangyang Shi, João Rodrigues, Helena Tomás, Jean-Pierre Majoral

► **To cite this version:**

Serge Mignani, Xiangyang Shi, João Rodrigues, Helena Tomás, Jean-Pierre Majoral. Dendrimer nanoplatfoms for veterinary medicine applications: A concise overview. *Drug Discovery Today*, 2022, 27 (5), pp.1251-1260. 10.1016/j.drudis.2022.01.001 . hal-03659120

HAL Id: hal-03659120

<https://hal.science/hal-03659120v1>

Submitted on 22 Jul 2024

HAL is a multi-disciplinary open access archive for the deposit and dissemination of scientific research documents, whether they are published or not. The documents may come from teaching and research institutions in France or abroad, or from public or private research centers.

L'archive ouverte pluridisciplinaire **HAL**, est destinée au dépôt et à la diffusion de documents scientifiques de niveau recherche, publiés ou non, émanant des établissements d'enseignement et de recherche français ou étrangers, des laboratoires publics ou privés.



Distributed under a Creative Commons Attribution - NonCommercial 4.0 International License

Dendrimer nanoplatforms for veterinary medicine applications: a concise overview

Serge Mignani^{1,2}, Xiangyang Shi^{2,3}, João Rodrigues^{2,4}, Helena Tomás², and Jean-Pierre Majoral^{5,6}

¹Université Paris Descartes, PRES Sorbonne Paris Cité, CNRS UMR 860, Laboratoire de Chimie et de Biochimie Pharmacologiques et Toxicologique, 45, Rue des Saints Peres, 75006 Paris, France

²CQM - Centro de Química da Madeira, MMRG, Universidade da Madeira, Campus da Penteada, 9020-105 Funchal, Portugal

³College of Chemistry, Chemical Engineering and Biotechnology, Donghua University, Shanghai 201620, PR China

⁴School of Materials Science and Engineering, Center for Nano Energy Materials, Northwestern Polytechnical University, Xi'an 710072, China

⁵Laboratoire de Chimie de Coordination du CNRS, 205 route de Narbonne, 31077, Toulouse Cedex 4, France

⁶Université Toulouse, 118 Route de Narbonne, 31077 Toulouse Cedex 4, France

Corresponding authors: Mignani, S. (serge.mignani@staff.uma.pt); Shi, X. (xshi@dhu.edu.cn); Majoral, J-P. (majoral@lcc-toulouse.fr); Rodrigues, J. (joaoc@staff.uma.pt)

Keywords: nanomedicine; dendrimers; veterinary medicine; foot and mouth disease; swine fever; hypothermic circulatory arrest; H9N2 avian influenza

Teaser. We discuss opportunities to develop dendrimer nanoplatforms for veterinary medicine applications.

Within the nanoparticle (NP) space, dendrimers are becoming increasingly important in the field of nanomedicine, not only to treat human diseases, but also in veterinary medicine, which represents a new therapeutic approach. Major applications include using dendrimers to tackle highly contagious foot-and-mouth disease virus (FMDV) and swine fever virus (SFV) in pigs, FMDV in cattle, hypothermic circulatory arrest (HCA) in dogs, rabies, and H9N2 avian influenza virus in chickens. As we review here, intramuscular (im) subcutaneous (sc), intravenous (iv), and intraperitoneal (ip) routes of administration can be used for the successful application of dendrimers in animals.

Introduction

Until recently, veterinary drugs were developed simultaneously with human drugs, with no clear distinction between the two, regardless of the physical differences between the species. However, the trend now is for a clear distinction between drugs intended for humans and those intended for animals. Nevertheless, some biologically active molecules are used in both branches of medicine. As for human health, the efficacy and safety of biologically active molecules are also paramount for veterinary drugs. To be approved, these molecules must go through a validation process involving high-quality scientific research and extensive testing.

To ensure animal health and well-being, the development of new and specific veterinary pharmaceuticals is becoming increasingly important. A significant current focus of the pharmaceutical industry is the development of nanomedicines, involving nanotechnology. Nanotechnology involves a range of technologies and materials in the design, production, and application of nanodevices and system, and we are now surrounded by many applications of nanotechnology.¹ Indeed, during the past decade, nanotechnology has significantly impacted the precise delivery of therapeutic agents, diagnostics, and molecular imaging agents.² Approved nanoformulations have been developed, such as liposomal formulations (e.g., Abelect, AmBisome, and Amphoytec), pegylated liposomes (e.g., Doxil, and DaunoXome), nanocrystal formulations (e.g., Megace EM, Triplide, and Tricor), NP formulations (e.g., Abraxane and Estrasorb), and dendrimer formulations (e.g., VivaGel® and Viraleze). Recently, the successful of nanomedicine was demonstrated by the development of vaccines against severe acute respiratory syndrome coronavirus 2 (SARS-CoV-2), such as liposomes encapsulating strands of mRNA encoding the 'spike' docking S protein of the virus. The BioNTech/Pfizer (BNT162b2) and Moderna mRNA-based vaccines^{3,4} are proving to be highly effective against the current coronavirus 2019 (COVID-19) pandemic.

A major aim of drug delivery is to improve efficiency by increasing the drug concentration at the site of action, improving the selectivity of the encapsulated or conjugated biologically active ingredients, and reducing their limiting toxic effects via dose reduction, consequently maximizing their therapeutic efficiency index and their preferential accumulation at target and tissue sites versus healthy tissues. This efficient drug reformulation strategy has been used for low water-soluble hydrophobic drugs and unstable drugs, as well as soluble toxic drugs, in aqueous solutions, increasing their dosage for parental administration and decreasing their systemic toxicity. Another advantage of NPs is the reduced clearance over parent drugs. In veterinary applications, numerous nanocarriers have been developed for the delivery of antibacterials, antifungals, antivirals, anesthetics, antiparasitics, and antineoplastic drugs, as well as vaccines. The simultaneous incorporation of hydrophobic and hydrophilic molecules has also been reported.

Based on the rapid emergence of nanotechnology, many promising domains are being introduced into medicine (so-called 'nanomedicine'). Nanotechnology represents an effective strategy for the cell-specific delivery and sustained release of drugs,⁵ as well as the co-delivery of antigens in vaccine development.^{6,7}

Within the numerous polymers, such as linear polymers and dendritic polymers,^{8,9} with polydispersity obtained by polymerization reactions or monodispersity frameworks obtained by step reactions (Figure 1), dendrimers are carefully assembled NPs of synthetic monomers with low polydispersity. There are over 100 families of dendrimers, the most well known being polyamidoamine (PAMAM), polylysine (PL), phosphorus dendrimers (PD), and polysilane dendrimers forming branch-like structures and repetitive geometrical units under radial layers, in so-called 'generations' (e.g., G0-Gn). The nanostructure of these materials has a significant impact on their physicochemical landscape.

Here, we review the most relevant milestones in the research and development of dendrimers as nanoplatforms for veterinary medicine. We discuss the general aspects of dendrimers in nanomedicine and the use of dendrimers in veterinary medicine. A search of the literature shows that the major veterinary applications of dendrimers are to tackle FMDV and SFV in pigs, FMDV in cattle, HCA in dogs, as well as rabies, and H9N2 avian influenza virus (AIV) in chickens. Intramuscular, subcutaneous, intravenous, and intraperitoneal routes of administrations are used.

Dendrimers in nanomedicine: general aspects

Cascade molecules were first synthesized by Vögtle *et al.* and described in 1978.¹⁰ Subsequently, these cascade structures have provided crucial low-molecular-weight, branched precursors to higher-molecular-weight, monodispersed, symmetrical nanoscale structures, now recognized as dendrimers. The first examples of these nanostructures were synthesized in 1979 [11] and given the name 'dendrimer' by Tomalia *et al.*^{11,12} The globular architecture of dendrimers enables hollow cavities within the branching structures to harbor synthetic drugs, biomacromolecules, natural bioactive compounds, and imaging agents, among others, as exemplified by PAMAM dendrimers (Figure 2). Numerous examples have been described, many in the oncology domain, including the delivery of small interfering (si)RNAs, complexed on the surface of dendrimers, forming dendriplexes, and of conjugated drugs on the surface of dendrimers. Importantly, dendrimers can be used as drugs themselves as anticancer, antibacterial, antiviral, anti-inflammatory, microbicide, antitubercular, and anti-Alzheimer agents.¹³ Modified PAMAM dendrimers have been successfully demonstrated to deliver self-amplifying mRNA to produce vaccines against H1N1 influenza and Ebola virus, among others.^{14,15} Tomalia *et al.* reported how emerging concepts in dendrimer-based nanomedicine provide fascinating opportunities in clinical translation, nanotoxicology, and theranostic nanodevices.¹⁶ Recently, the same authors emphasized the key influence of the cell symmetry of the dendrimer branches on the interior packing properties and, consequently, on their solubility and efficiency for drug delivery and nanomedical applications.¹² Altering five parameters (flexibility/rigidity, size, shape, surface chemistry, and elemental composition) offers the possibility to optimize the physicochemical profiles of dendrimers for their development in a variety of therapeutic applications.¹⁷

The nature of the terminal chemical groups (e.g., polycationic, polyanionic, and neutral functional groups) of dendrimers has a central role in both their *in vitro* and *in vivo* therapeutic applications, and delineates new 'druggable' spaces within this huge chemical space. The size of the dendrimers can be tightly regulated, and their surface can be highly functionalized with many attached group types for therapeutic agent delivery and active targeting (vectorization) purposes, and bioavailability improvements. Examples of the use of this approach include phosphorus dendrimers as nanoplatforms in therapeutic areas such as Alzheimer's and prion diseases,^{18,19} inflammatory diseases,^{20,21} cancers,²²⁻²⁴ and TB²⁵. Some dendrimers have also entered clinic trials. For example, Starpharma Holdings developed and marketed the first-in-class VivaGel (SPL7013), which is a G3 3 L-lysine dendrimer for antiviral and antibacterial applications in the treatment and prevention of bacterial vaginosis.²⁶⁻²⁸ VivaGel has 32 sodium 1-(carboxymethoxy)naphthalene-3,6-disulfonate on its surface. Recently, Starpharma Holdings announced the development of VivaGel as a potent antiviral agent against respiratory syncytial virus (RSV) using nasal spray technology named VIRALEZE™.

Dendrimers in veterinary medicine

The number of papers reporting the development of NPs in veterinary medicine have increased significantly over the past ten years or so, from ~100 in 2010 to ~800 in 2020 (based on a search of Scopus). The number of papers related to liposomes (57 versus 278), dendrimers (5 versus 38), polymeric NPs (3 versus 129), and metallic NPs (1 versus 37) showed a similar pattern of increase evolution from 2004 to 2020.

Most NP systems used in the veterinary medicine domain involve mainly liposomes (in a variety of animals, including dogs, cats, pigs, birds, sheep, horses and cattle), emulsions, magnetic NPs, dendrimers, water-based NP adjuvants, polystyrene nano-beads, and chitosan NPs.²⁹⁻³² Liposomes can carry drugs, such as doxorubicin and cisplatin (various tumors), muramyl tripeptide (adenocarcinoma melanoma, osteosarcoma, and hemangiosarcoma), photosensitizers (carcinoma), 99m-technetium (imaging of sarcomas), IL-2 DNA (chronic rhinitis and pulmonary neoplasia), ribavirin (infections), hydromorphone (analgesia), trifluralin, amphotericin B, and meglumine antimoniate (leishmaniasis), clodronate (hemolytic anemia), amphotericin B (blastomycosis), α -tocopherol (vitamin E supplementation), streptomycin (brucellosis), gentamicin and staphylococcal antigens (*Staphylococcus aureus* mastitis treatment and vaccine), adriamycin (leukemia), diclofenac (analgesia and anti-inflammatory), diamidine (babesiosis), *Toxoplasma gondii* antigen (*T. gondii* vaccine), , avian colibacillosis vaccine, DNA vaccine (infectious

disease), *Mycoplasma gallisepticum* vaccine (mycoplasmosis), butorphanol (arthritis), and bupivacaine (antineoplastic and anesthesia). Most dendrimers are administered via iv, but other routes include im, ip, intratumoral, oral, intramammary, intranasal, transdermal, intraocular, and nebulization. These examples highlight the development of NPs in veterinary medicine, also detailed in Table 1.

Dendrimers to tackle HCA in dogs

Classically, during complex open-heart surgery, blood must continue to flow throughout the body, except in the surgical area, where the major blood vessels are clamped to prevent blood flow.⁴⁴ For instance, in aortic surgery, it is necessary to perform technical procedures to avoid clamping the aorta and to keep the surgical field free of blood. The technique known as deep HCA was developed to provide neuroprotection, but entails an ischemic period inducing excitotoxicity,⁴⁵ neuroinflammation,⁴⁶ and subsequent neurological injury as neurological sequelae. Consequently, neurocognitive dysfunction and injury remain problematic during HCA, although strokes, flawed neurocognitive function, neurological problems, and congenital malformations were observed in only 1–3% of patients after cardiac surgery.^{44,47} Unfortunately, several potential treatments to mitigate the neurological impact of HCA have been performed in the clinic but have been largely unsuccessful.⁴⁸ Consequently, no viable therapeutic options are available. This is mainly because of the limited blood–brain barrier (BBB) penetration, as well the systemic toxicity of therapeutic drugs. In addition, circulatory arrest increases toxicity of drugs at doses that are normally well tolerated, because of changes in their clearance and therapeutic effects.^{49,50}

Clinically relevant large animal models of HCA, such as the canine model, have been developed to induce brain injury, neuroinflammation, and excitotoxicity.⁵¹ Significant differences exist between large and small animal models, such as cardiac characteristics, including heart rate, oxygen consumption, adrenergic receptor ratios, and contractile protein expression. Canine models are closer to the human model in terms of physiology, anatomy, and function, and consequently represent adequate translations from bench to bedside.

Notably, in early studies, Mishra *et al.* developed non-cytotoxic conjugated bifunctional G4 hydroxy-PAMAM dendrimers encapsulating two clinically approved drugs, valproic acid (VPA) and *N*-acetyl cysteine (NAC), which attenuate excitotoxicity (epilepsy/bipolar disorder) and neuroinflammation, respectively.³⁸ Importantly, NAC exhibited poor BBB penetration, as well as defective localization, demanding large doses of drugs to gain neuroprotection.⁵² In addition to the neuroprotective effects, a large dose of VPA and NAC induced adverse effects, including perioperative hypotension involving fluid resuscitation and inotropic effect, and pulmonary edema/hemorrhage. To increase the therapeutic effects and decrease adverse effects, a strategy to tackle both excitotoxicity and neuroinflammation was developed using combination therapy strategies. This study is based on previous work by the same team showing that the G4 hydroxyl-PAMAM dendrimers without any encapsulated drugs were selectively localized in the injured brain and retina at the microglia level.⁵³ Two different bifunctional dendrimer types (D-VPA and D-NAC) were designed (Figure 3). These dendrimers have a disulfide-based glutathione sensitive linker enabling fast intracellular release of VPA and NAC. A polyethylene glycol (PEG)-valproic acid derivative (PEG-VPA) was prepared in a one-step synthesis by the esterification of VPA with PEG-SH (DCC/DMAP). In a brain injury canine model following circulatory arrest, the systemic administration of D-VPA and D-NAC was selectively assumed in injured neurons and microglia in the brain. In addition, combination therapy based on the association of D-VPA and D-NAC using 10 mg/kg of VPA in 70 mg/kg of dendrimer, and 10 mg/kg of NAC in 50 mg/kg of dendrimer, respectively, decreased systemic hemodynamic adverse effects and increased neurological outcomes based on a 24-h neurological deficit score compared with free drugs at the higher doses of tenfold (VPA) and 30-fold (NAC) or in combination therapy with 100 mg/kg of VPA and 300 mg/kg of NAC. D-VPA and D-NAC showed comparable improvements in neurological outcomes at one tenth of the dose used with reduced drug adverse effects over free VPA at the dose of 100 mg/kg.

Then, in 2016, Grimm and colleagues highlighted G6 hydroxyl-PAMAM dendrimers conjugated with the near-IR imaging agent Cy5 in a canine HCA-induced brain injury model.³⁹ Interestingly, by itself, this dendrimer interrupted the cascade process inducing neurocognitive dysfunction. The G6 hydroxyl-PAMAM dendrimer (Figure 3) was systematically administered, initially by an intravenous bolus dose (10% of the total 200 mg dose) and then, after peripheral aortic cannulation for 90 min, by the infusion administration of 70% of the total dose during a period of 6 h. The final bolus dose of 20% of the overall dose was given 24 h post-HCA. Analysis of G6 hydroxyl-Cy5 PAMAM dendrimer biodistribution showed that this dendrimer was specifically localized to the local macrophages of the nervous system microglia within the dorsal hippocampus, which is strongly connected with HCA. Microglia are the major effectors of inflammation and propagators of injury. The G6 hydroxyl-Cy5 PAMAM dendrimer crossed the BBB and targeted injured neurons and microglia after systemic administration.

The same team then investigated the hydroxyl-PAMAM dendrimer size effect of G4 versus G6 PAMAM dendrimers on brain uptake and kinetics in a canine model of HCA.⁴⁰ It is well accepted that both the size and the plasma-binding profile of compounds are major factors influencing their *in vivo* clearance and secretion pathways.

During systemic circulation, the strongest plasma protein interactions with NPs in general, and dendrimers in particular, occurred with hydrophobic or charged surfaces inducing high reticuloendothelial system (RES) clearance and strong liver uptake through the opsonization process.⁵⁴ G6 and G4 dendrimers are ~6.7 nm and ~4.3 nm in size, respectively. Using the same experimental procedure as the G6 hydroxyl-PAMAM dendrimer in the canine model of post-HCA dog brain injury, the G6 hydroxyl-PAMAM dendrimer displayed both high blood circulation times and strong accumulation in the cerebrospinal fluid (CSF) in injured animal brain versus the G4

hydroxyl-PAMAM dendrimers, which were undetectable in the brain after 48 h. Interestingly, the area under the curve (AUC) analysis showed that the CSF/serum ratio was ~20% at its peak and strongly correlated with the severity of neuroinflammation event. This ratio is higher compared with well-known clinical neurological drugs, such as penicillin, cloxacillin, amoxicillin, piperacillin, clavulanate, and cephalosporins. Based on confocal microscopy, G6 hydroxyl-PAMAM dendrimers displayed a decrease in renal clearance rate and a slightly increased uptake in the liver and spleen compared with G4 hydroxyl-PAMAM dendrimers.

Interestingly, as presented by Wang *et al.*, the topical cervical application of noncytotoxic G4 hydroxyl-PAMAM dendrimers (G4-PAMAM-OH) showed efficiency against *Escherichia coli* uterine infection in a guinea pig model of chorioamnionitis.⁴² The authors showed that cytokine release (TNF α and IL-6) was comparable between the treatment group over the negative control, clearly showing the efficiency of this approach for the treatment of *E. coli* infections. Based on an outer and inner membrane permeability assay, G4-PAMAM-OH dendrimers induced important structural changes to the outer membrane.

Dendrimers to tackle viral infections in pigs, dogs, and chickens

Another direction for the use of dendrimers in veterinary applications is to treat viral infections. Viral infections and immunization processes with vaccines usually induce high levels of circulating immunoglobulin G (IgG) as neutralizing antibodies, which correlates with protection against related viruses.⁵⁵ Thus, peptide vaccines represent an attractive strategy to treat viral infections. Peptide vaccines have short peptide fragments that induce highly targeted immune responses.⁵⁶ Generally, biodegradable NPs protect antigens from degradation, promote cellular absorption, and enhance immune responses, for instance as oral nanocarriers.⁵⁷

An interesting example is the development of vaccines to prevent endemic SFV (CSFV), one of the most important diseases for the pig industry worldwide.⁵⁸ Despite oral vaccination of the wild boar population to control this destructive disease, the development of vaccines is still required to allow the differentiation between vaccinated and infected animals (named DIVA).⁵⁹ Neutralizing antibodies specifically recognize the structural E1 and E2 envelope glycoproteins, and their presence has been associated with a protective effect.^{60,61} The E2 glycoprotein is the primary target for neutralizing antibodies during natural CSFV infection.⁶²

Tarradas and colleagues reported the immunogenic effect of three synthetic PEGylated dendrimeric peptide vaccines against CSFV in pigs (Figure 4). The peptide vaccine had four copies of a B cell epitope from the CSFV E2 glycoprotein linked to a T cell epitope from the NS3 protein of the virus (residues 1446–1460). The pigs were challenged with a lethal dose of CSFV. The four copies of the B cell epitope from the E2 envelope glycoprotein were E2 (694–712) (Construct 1); 2: E2 (712–727) (Construct 2); and E2 (829–842) (Construct 3) (Figure 4).³⁵

Dendrimers have desirable features for the multimeric presentation of epitopes in candidate vaccines.^{63,64} In addition, the combination of B and T cell epitopes in dendrimers has been shown to confer significant protection against FMDV in domestic pigs.⁶⁵ This strategy aims to facilitate interactions between B and T epitopes, and to increase the immune response. Two doses [1.4 mg, im route of administration] of the corresponding construct were mixed with Montanide v206 adjuvant and were administered at days 1 and 21 post infection (p.i.). Challenge with virus was performed 15 days after the second dose. Im injection in the neck region was used for all inoculations. To evaluate the immunogenicity of the different constructions, the detection of specific antibodies was performed using ELISA. Partial protection and antibody responses were observed in the three groups of peptide-immunized animals, although construct 1 showed the highest levels of antibody response against the dendrimeric peptide. Thus, compared with control pigs developing important clinical signs of the disease, including anorexia, conjunctivitis, diarrhea, constipation, abdominal petechiae, and prostration, all pigs vaccinated with the construct 1 developed a strong antibody response recognizing the original dendrimeric immunogen as well as the E2 epitope. This protection (only for one-third of the pigs) was related to the induction of IFN- γ -producing cells as well as neutralizing antibodies.

Based on the previous work, the same team developed four dendritic constructions to immunize pigs.³⁶ These constructions were prepared bearing either the NS3 T cell epitope alone or two different B cell epitopes without this T cell epitope (Figure 4). Construct 1', containing the NS3 T cell epitope and four copies of the B cell epitope, significantly reduced the clinical scores as well the RNA viral loads. Thus, partial protection was observed with half of the pigs, and the protection was associated with the action of IFN- γ -producing cells and neutralizing antibodies. Construct 2', bearing four copies of the B epitope of construct 1 but without the T cell motif, induced more severe clinical signs. Constructs 3' and 4', which included four copies of a B epitope and differed from Constructs 1' and 2' with or without the NS3 T cell epitope (Figure 4), showed low levels of cellular responses, an absence of neutralizing antibodies, and a lack of protection. Even so, the clinical score during the first week after challenge was less severe for animals vaccinated with Construct 3' than for those given Construct 4'. Collectively, these results strongly confirm the protection of Constructs 1' and 2' against CSFV, based on the important role of the B cell epitope in residues 694–712 of the glycoprotein E2.

Interestingly, Asgary and colleagues advocated PEGylated G2 citric-acid based dendrimers as adjuvants of veterinary vaccines against rabies virus in NMRI mice. Rabies is a viral disease that attacks the central nervous system and is common in both humans and animals, with wild animals considered to be the source of infection.⁴¹ The main strategy for control of human rabies is vaccination.⁶⁶ Adjuvants are usually added to the vaccine formulation to increase the immunogenicity of the vaccines as well the strength of the immune response.⁶⁷ Currently, aluminum salts, such as aluminum hydroxide ('alum'), are used as an adjuvant, for instance, in

veterinary rabies vaccines. Although alum enhances the immune response, the aluminum adjuvant-containing vaccines can cause effects on local tissues, prolong inflammation at the injection site, and cause post-immunization headache, arthralgia, and myalgia.⁶⁸ These globular dendrimers are citric acid-polyethylene glycol-citric acid (CPEGC) triblock dendrimers (generation 2) (Figure 5).⁶⁹

In this study, to determine the best formulation for the survival of mice after viral challenge, different concentrations of G2 citric-acid based dendrimers were used. The increase in neutralizing antibodies was also checked by a fluorescent technique. Importantly, the *in vitro* toxicity of the G2 dendrimer was investigated using the MTT assay on J774A.1 macrophage-like cells and showed no significant toxic effects. An *in vivo* assay in mice, intraperitoneally injected on days 0 and 7, showed relevant adjuvanticity of the G2 dendrimer. The mortality assay of mice at different dendrimer concentrations showed that the highest viability percentage was observed at 12.5 mg/kg compared with the PBS group, which was confirmed by the fluorescent technique. However, there was no significant difference in the numbers of live and dead mice at higher concentrations compared with the PBS group. Finally, specific rabies-neutralizing antibodies against the rabies virus were confirmed by a neutralizing antibody titration assay.

Interestingly, Cubillos and colleagues designed and developed a synthetic dendrimeric peptide, named B₄T, to protect pigs against FMDV.³³ FMDV is a picornavirus producing a highly transmissible and devastating disease in farm animals, such as cattle and swine, and is one of the most devastating animal diseases worldwide.^{70,71} B₄T contains one copy of a FMDC- T cell epitope and branches bearing four copies of a B cell epitope (Figure 6). Interestingly, the immunized domestic pigs did not develop significant clinical signs, such as fever and viremia, based on RT-PCR viral RNA amplification in respiratory tract samples. B₄T specifically induced high titers of FMDV-neutralizing antibodies of T cells and a potent anti-FMDV IgA systemic and mucosal response. B₄T also inhibited airborne excretion of the virus. Interestingly, no contact transmission was observed from naive animals housed with peptide-vaccinated pigs, inducing no development of clinical signs of disease. Consequently, synthetic peptides mimicking protective B and T cell epitopes are good candidates for safer, more effective FMDV vaccines.

Recently, the same team developed dendrimer peptides for the protection of cattle against FMDV.³⁴ Several studies showed effective protection using peptide-based vaccines,⁷² synthetic peptides, or recombinant protein vaccines against FMDV in pigs but limited efficiency in cattle.⁷³ The dendrimeric peptides used had two or four copies of a peptide corresponding to the B cell epitope linked through thioether bonds to a single copy of the T cell epitope (Figure 6). The dendrimeric peptides B₂T⁺ and B₄T⁺ induced antipeptide and FMDV-specific antibodies (IgG1/2 responses) in cattle after subcutaneous injection. Overall, B₄T⁺ and B₂T⁺ elicited humoral and cellular immune responses in cattle, inducing partial protection against a heterogenous virus challenge, which was associated with both T cell and antibody responses.

Recently, Zhao *et al.* designed and developed a DNA vaccine based on dendrigraft poly-L-lysines against H9N2 AIV infection in chickens.³⁷ DNA vaccines are considered to be third-generation vaccines and are relatively safe over classical vaccines, and lack serious adverse effects.⁷⁴ DNA vaccines have been developed to treat many diseases caused by pathogens, including Zydus' ZyCoV-D, which recently received emergency use authorization (EUA) in India against COVID-19.⁷⁵ DNA vaccines increase DNA insertion and translation in the cell, activate CD4⁺ T cells, and enhance cytotoxic T lymphocyte induction and specific antibody production.⁷⁶ This study involved the construction of a specific plasmid by insertion of an HA gene fragment of H9N2 AIV into a vector that was packaged with G3 dendrigraft poly-L-lysines, which contain 123 primary amino groups. This construct allowed high stability of the system and high *in vitro* and *in vivo* transfection efficiency. Strong cellular immune responses were observed in immunized chickens. T lymphocytes were activated and proliferated, and CD3⁺/CD4⁺ and CD4⁺/CD8⁺ were increased, allowing complete protection of chickens after intramuscular administration against H9N2 AIV virus infection.

Concluding remarks and perspectives

Veterinary medicine ensures the health and well-being of all animals and, therefore, contributes to the improvement of public health, particularly with regard to diseases transmissible from animals to humans and the health and safety of animal products. As for humans, the effectiveness and safety of care depend on the quality of the veterinary diagnosis, which forms the basis of treatment. The two main specific applications of nanotechnologies in veterinary medicine are for veterinary pharmacology and therapeutics and veterinary vaccinology using viral NPs, including dendrimers. The major applications of dendrimers include against FMDV and SFV in pigs, FMDV in cattle, HCA in dogs, rabies, and H9N2 AIV in chickens. Im, sc, iv, and ip routes of administration are used. The oral route has never been a focus, although it is the main route of drug administration used in veterinary medicine. Within the dendrimer space defined elsewhere,⁷⁷ dendrimers can be delivered via several routes of administration using enteral, parenteral, and topical routes, such as oral, transdermal, ocular, and transmucosal routes.⁷⁸ The main potential challenges to the development of NPs for veterinary medicine application in general, and of dendrimers in particular, are as important as in human medicine, and include: (i) targeted transport of nano-encapsulated drugs; (ii) therapeutic nanomaterials active by themselves; (iii) vectorization of vaccine antigens (viral NPs); (iv) *in vivo* imaging; and (v) *in vitro* and *in vivo* diagnosis. The increasing use of these nanomaterials also requires an assessment of their environmental risks as well as their large-scale production, including the high costs of the manufacturing process compared with conventional drugs. In addition, the development of analytical procedures for in-process quality control and

adequate final drug quality of the nanomedicine must be controlled. Consequently, the future is promising for veterinary medicine applications using dendrimer nanoplatfoms.

Acknowledgments

S.M., X.S., J.R., and H.T. acknowledge the support of FCT-Fundação para a Ciência e a Tecnologia (Base Fund UIDB/00674/2020 and Programmatic Fund UIDP/00674/2020, Portuguese Government Funds) and ARDITI- Agência Regional para o Desenvolvimento da Investigação Tecnologia e Inovação through the project M1420-01-0145-FEDER-000005-CQM+ (Madeira 14-20 Program). X.S., S.M., and J-P.M. acknowledge support from PRC NSFC-CNRS 2019 (21911530230 for X.S. and 199,675 for S.M. and J-P.M.). J.P.M. also thanks the CNRS for financial support.

Declaration of interests

The authors declare no conflict of interest.

References

- 1 Nasrollahzadeh M, Sajadi SM, Sajjadi M, Issaabadi Z. Applications of nanotechnology in daily life. *Interface Sci Technol.* 2019; 28: 113–143.
- 2 Kargozara S, Mozafari M. Nanotechnology, nanomedicine: start small, think big. *Mater Today Proc.* 2018; 5: 15492–15500.
- 3 Shyh PT. Review of COVID-19 mRNA vaccines: BNT162b2 and mRNA–1273. *J Pharm Pract.* 2021; 12: 8971900211009650.
- 4 Turner JS, O'Halloran JA, Kalaidina E, Kim W, Schmitz AJ, Zhou JQ, et al. SARS-CoV-2 mRNA vaccines induce persistent human germinal centre responses. *Nature.* 2021; 596: 109–113.
- 5 Patra JK, Das G, Fraceto LF, Campos EVR, Rodriguez-Torres MDP, Acosta-Torres LS, et al. Nano based drug delivery systems: recent developments and future prospects. *J Nanobiotechnol.* 2018; 16: 71.
- 6 Kim MG, Park JY, Shon Y, Kim G, Shim G, Oh YK. Nanotechnology and vaccine development. *Asian J Pharm Sci.* 2014; 9: 227–235.
- 7 Chen Y-C, Cheng H-F, Yang Y-C, Yeh M-K. Nanotechnologies applied in biomedical vaccines. In: Stanciu SG, ed. *Micro and Nanotechnologies for Biotechnology.* London; IntechOpen, 2016: 63453.
- 8 Malkoch M, García-Gallego S. Introduction to dendrimers and other dendritic polymers. In: Malkoch M, García-Gallego S., eds. *Dendrimer Chemistry: Synthetic Approaches Towards Complex Architectures.* London; RSC: 2020, 1–20.
- 9 Voit BI, Lederer A. Hyperbranched and highly branched polymer architectures—synthetic strategies and major characterization aspects. *Chem Rev.* 2009; 109: 5924–5973.
- 10 Buhleier E, Wehner W, Vogtle F. Cascade and non-skid-chain-like syntheses of molecular cavity topologies. *Synthesis* 1978; 2: 155e158.
- 11 Tomalia DA, Baker H, Dewald J, Hall M, Kallos G, Martin S, et al. A new class of polymers: starburst-dendritic macromolecules. *Polym J.* 1985; 17: 117e132.
- 12 Tomalia DA, Nixon LS, Hedstrand DM. The role of branch cell symmetry and other critical nanoscale design parameters in the determination of dendrimer encapsulation properties. *Biomolecules.* 2020; 10: 642.
- 13 Mignani S, Shi X, Rodrigues J, Tomas H, Karpus A, Majoral J-P. First-in-class and best-in-class dendrimer nanoplatfoms from concept to clinic: lessons learned moving forward. *Eur J Med Chem.* 2021; 219: 113456.
- 14 Chahal JS, Khan OF, Cooper CL, McPartlan JS, Tsosie JK, Tilley LD, et al. Dendrimer-RNA nanoparticles generate protective immunity against lethal Ebola, H1N1 influenza, and *Toxoplasma gondii* challenges with a single dose. *Proc Natl Acad Sci U S A.* 2016; 113: E4133–42.
- 15 Zhang C, Maruggi G, Shan H, Li J. Advances in mRNA vaccines for infectious diseases. *Front Immunol.* 2019; 10: 594.
- 16 Kannan RM, Nance E, Kannan S, Tomalia DA. Emerging concepts in dendrimer-based nanomedicine: from design principles to clinical applications. *J Intern Med.* 2014; 276: 579–617.
- 17 Tomalia DA. Functional dendrimers. *Molecules* 2016; 21: 1035.
- 18 Klajnert B, Cangiotti M, Calici S, Majoral JP, Caminade AM, Cladera J, et al. EPR study of the interaction between dendrimers and peptides involved in Alzheimer's and prion diseases. *Macromol Biosci.* 2007; 7: 1065–1074.
- 19 Wasiak T, Ionov M, Nieznanski K, Nieznanska H, Klementieva O, Granell M, et al. Phosphorus dendrimers affect Alzheimer's (Abeta1-28) peptide and MAP6TAU protein aggregation. *Mol Pharm* 2012; 9: 458–469.
- 20 Blattes E, Vercellone A, Eutamène H, Turrin CO, Théodorou V, Majoral JP, et al. Mannodendrimers prevent acute lung inflammation by inhibiting neutrophil recruitment. *Proc Natl Acad Sci USA.* 2013; 110: 8795–8800.
- 21 Bohr A, Tsapis N, Andreana I, Chamarat A, Foged C, Delomenie C, et al. Anti-inflammatory effect of anti-TNF- α siRNA cationic phosphorus dendrimer nanocomplexes administered intranasally in a murine acute lung injury model. *Biomacromolecules.* 2017; 18: 2379–2388.
- 22 El Brahmî N, El Kazzouli S, Mignani SM, Essassi el M, Aubert G, Laurent R, et al. Original multivalent copper(II)-conjugated phosphorus dendrimers and corresponding mononuclear copper(II) complexes with antitumoral activities. *Mol Pharmaceutics.* 2013; 10: 1459–1464.
- 23 Mignani S, El Brahmî N, Eloy L, Poupon J, Nicolas V, Steinmetz A, et al. Anticancer copper(II) phosphorus dendrimers are potent proapoptotic Bax activators. *Eur J Med Chem.* 2017; 132: 142e156.
- 24 Mignani S, Bryszewska M, Klajnert-Maculewicz B, Zablocka M, Majoral J-P. Advances in combination therapies based on nanoparticles for efficacious cancer treatment: an analytical report. *Biomacromolecules.* 2015; 16: 1–27.
- 25 Mignani S, Tripathi VD, Soam D, Tripathi RP, Das S, Singh S, et al. Safe polycationic dendrimers as potent oral *in vivo* inhibitors of *Mycobacterium tuberculosis*: a new therapy to take down tuberculosis. *Biomacromolecules.* 2021; 22(6):2659–2675.
- 26 Bernstein DI, Stanberry LR, Sacks S, Ayisi NK, Gong YH, Ireland J, et al. Evaluations of unformulated and formulated dendrimer-based microbicide candidates in mouse and guinea pig models of genital herpes. *Antimicrob Agents Chemother.* 2003; 47: 3784–3788.
- 27 Tyssen D, Henderson SA, Johnson A, Sterjovski J, Moore K, La J, et al. Structure activity relationship of dendrimer microbicides with dual action antiviral activity. *PLoS ONE.* 2010; 5: e12309.
- 28 StarPharma. <https://starpharma.com/news/328>. [Accessed January 4, 2022].
- 29 Carvalho SG, Araujo VHS, Dos Santos AM, Duarte JL, Silvestre ALP, Fonseca-Santos B, et al. Advances and challenges in nanocarriers and nanomedicines for veterinary application. *Int J Pharm.* 2020; 580: 119214.
- 30 Underwood C, Eps AW. Nanomedicine and veterinary science: the reality and the practicality. *Veterinary J.* 2012; 193: 12–23.
- 31 Fady SY, Hossny A, E-B, Hesham YE, Ahmed MG. Application of some nanoparticles in the field of veterinary medicine. *Int J Vet Sci Med* 2019; 7: 78–93.
- 32 Bai D-P, Lin X-Y, Huang Y-F, Zhang X-F. Theranostics aspects of various nanoparticles in veterinary medicine. *Int J Mol Sci* 2018; 19: 3299.
- 33 Cubillos C, de la Torre BG, Jakab A, Clementi G, Borrás E, Bárcena J, et al. Enhanced mucosal immunoglobulin A response and solid protection against foot-and-mouth disease virus challenge induced by a novel dendrimeric peptide. *J Virol.* 2008; 82: 7223–7230.
- 34 Soria I, Quattrocchi V, Langellotti C, Pérez-Filgueira M, Pega J, Gnazzo V, et al. Immune response and partial protection against heterologous foot-and-mouth disease virus induced by dendrimer peptides in cattle. *J Immunol Res.* 2018; 2018: 3497401.
- 35 Tarradas J, Monsó M, Muñoz M, Rosell R, Fraile L, Frías MT, et al. Partial protection against classical swine fever virus elicited by dendrimeric vaccine-candidate peptides in domestic pigs. *Vaccine* 2011; 29: 4422–4429.
- 36 Tarradas J, Monsó M, Fraile L, de la Torre BG, Muñoz M, Rosell R, et al. A T-cell epitope on NS3 non-structural protein enhances the B and T cell responses elicited by dendrimeric constructions against CSFV in domestic pigs. *Vet Immunol Immunopathol.* 2012; 150: 36–46.

- 37 Zhao K, Rong G, Teng Q, Li X, Lan H, Yu L, *et al.* Dendrigraft poly-L-lysines delivery of DNA vaccine effectively enhances the immunogenic responses against H9N2 avian influenza virus infection in chickens. *Nanomedicine* 2020; 27: 102209.
- 38 Mishra MK, Beaty CA, Lesniak WG, Kambhampati SP, Zhang F, Wilson MA, *et al.* Dendrimer brain uptake and targeted therapy for brain injury in a large animal model of hypothermic circulatory arrest. *AVS Nano*. 2014; 8: 2134–2147.
- 39 Grimm JC, Magruder JT, Wilson MA, Blue ME, Crawford TC, Troncoco JC, *et al.* Nanotechnology approaches to targeting inflammation and excitotoxicity in a canine model of hypothermic circulatory arrest-induced brain injury. *Ann Thorac Surg*. 2016; 102: 743–750.
- 40 Zhang F, Trent Magruder J, Lin YA, Crawford TC, Grimm JC, Sciortino CM, *et al.* Generation-6 hydroxyl PAMAM dendrimers improve CNS penetration from intravenous administration in a large animal brain injury model. *Control Release* 2017; 249: 173–182.
- 41 Asgary V, Shoari A, Afshar Moayad M, Shafiee Ardestani M, Bigdeli R, Ghazizadeh L, *et al.* Evaluation of G2 citric acid-based dendrimer as an adjuvant in veterinary rabies vaccine. *Viral Immunol*. 2018; 31: 47–54.
- 42 Wang B, Navath RS, Menjoge AR, Balakrishnan B, Bellair R, Dai H, *et al.* Inhibition of bacterial growth and intramniotic infection in a guinea pig model of chorioamnionitis using PAMAM dendrimers. *Int J Pharm*. 2010; 395: 298–308.
- 43 Souto DE, Fonseca AM, Barragan JT, Luz Rde C, Andrade HM, Damos FS, *et al.* SPR analysis of the interaction between a recombinant protein of unknown function in *Leishmania infantum* immobilised on dendrimers and antibodies of the visceral leishmaniasis: a potential use in immunodiagnosis. *Biosens Bioelectron* 2015; 70: 275–281.
- 44 Tarakji KG, Sabik JF, Bhudia SK, Batizy LH, Blackstone EH. Temporal onset, risk factors, and outcomes associated with stroke after coronary artery bypass grafting. *JAMA*. 2011; 305: 381–390.
- 45 Redmond JM, Gillinov AM, Zehr KJ, Blue ME, Troncoco JC, Reitz BA, *et al.* Glutamate excitotoxicity: a mechanism of neurologic injury associated with hypothermic circulatory arrest. *J Thorac Cardiovasc Surg*. 1994; 107: 776–786
- 46 van Harten AE, Scheeren TW, Absalom AR. A review of postoperative cognitive dysfunction and neuroinflammation associated with cardiac surgery and anaesthesia. *Anaesthesia*. 2012; 67: 280–293.
- 47 Augoustides JG, Floyd TF, McGarvey ML, Ochroch EA, Pochettino A, Fulford S, *et al.* Major clinical outcomes in adults undergoing thoracic aortic surgery requiring deep hypothermic circulatory arrest: quantification of organ-based perioperative outcome and detection of opportunities for perioperative intervention. *J Cardiothorac Vasc Anesth*. 2005; 19: 446–452.
- 48 He J, Peng J, Li W, Zheng D, Cai S, Xu W, *et al.* Aorta-clamp' technique for surgical repair of acute type A aortic dissection—5 min circulatory arrest at 30 °C. *J Thorac Dis*. 2019; 11: 4717–4724.
- 49 van den Broek MP, Groenendaal F, Egberts AC, Rademaker CM. Effects of hypothermia on pharmacokinetics and pharmacodynamics: a systematic review of preclinical and clinical studies. *Clin Pharmacokinet*. 2010; 49: 277–294.
- 50 Lytle BW, McCarthy PM, Meaney KM, Stewart RW, Cosgrove DM. Systemic hypothermia and circulatory arrest combined with arterial perfusion of the superior vena cava. effective intraoperative cerebral protection. *J Thorac Cardiovasc Surg*. 1995; 109: 738–743.
- 51 Barreiro CJ, Williams JA, Fitton TP, Lange MS. Noninvasive assessment of brain injury in a canine model of hypothermic circulatory arrest using magnetic resonance spectroscopy. *Ann Thorac Surg*. 2006; 81: 1593–1598.
- 52 Erickson MA, Hansen K, Banks WA. Inflammation-induced dysfunction of the low-density lipoprotein receptor-related protein-1 at the blood-brain barrier: protection by the antioxidant N-acetylcysteine. *Brain Behav Immunol Res*. 2012; 26: 1085–1094.
- 53 Kannan S, Dai H, Navath RS, Balakrishnan B, Jyoti A, Janisse J, *et al.* Dendrimer-based postnatal therapy for neuroinflammation and cerebral palsy in a rabbit model. *Sci Transl Med* 2012; 4: 130ra46.
- 54 Yu M, Zheng J. Clearance pathways and tumor targeting of imaging nanoparticles. *ACS Nano*. 2015; 9: 6655–6674.
- 55 Vaccines (vaccinology). www.ufrgs.br/immunovet/molecular_immunology/preventionprimaryimmunovaccine.html. [Accessed January 4, 2022].
- 56 Wang CY, Chang TY, Walfield AM, Ye J, Shen M, Chen SP, *et al.* Effective synthetic peptide vaccine for foot-and-mouth disease in swine. *Vaccines*. 2002; 20: 2603–2610.
- 57 Jazayeri SD, Lim HX, Shameli K, Yeap SK, Poh CL. Nano and microparticles as potential oral vaccine carriers and adjuvants against infectious diseases. *Front Pharmacol*. 2021; 12: 682286.
- 58 Dong XN, Chen YH. Marker vaccine strategies and candidate CSFV marker vaccines. *Vaccine* 2007; 25: 205–230.
- 59 Bee rM, Reimann I, Hoffmann B, Depner K. Novel marker vaccines against classical swine fever. *Vaccine*. 2007; 25: 5665–5670.
- 60 Weiland E, Ahl R, Stark R, Weiland F, Thiel HJ. A second envelope glycoprotein mediates neutralization of a pestivirus, hog cholera virus. *J Virol*. 1992; 66: 3677–3682.
- 61 Rumenapf T, Stark R, Meyers G, Thiel HJ. Structural proteins of hog cholera virus expressed by vaccinia virus: further characterization and induction of protective immunity. *J Virol*. 1991; 65: 589–589.
- 62 Konig M, Lengsfeld T, Pauly T, Stark R, Thiel HJ. Classical swine fever virus: independent induction of protective immunity by two structural glycoproteins. *J Virol*. 1995; 69: 6479–6486.
- 63 Heegaard PM, Boas U, Sorensen NS. Dendrimers for vaccine and immunostimulatory uses. A review. *Bioconjug Chem*. 2010; 21: 405–418.
- 64 Tam JP, Lu YA, Yang JL. Antimicrobial dendrimeric peptides. *Eur J Biochem*. 2002; 269: 923–932.
- 65 Cubillos C, de la Torre BG, Jakab A, Clementi G, Borrás E, Bárcena J, *et al.* Enhanced mucosal immunoglobulin A response and solid protection against foot-and-mouth disease virus challenge induced by a novel dendrimeric peptide. *J Virol*. 2008; 82: 7223–7230.
- 66 Ravish HS, Srikanth J, Narayana DHA, Annadani R, Vijayashankar V, Undi M. Pre-exposure prophylaxis against rabies in children. *Hum Vaccin Immunother* 2013; 9: 1910–1913.
- 67 Di Pasquale A, Preiss S, Da Silva FT, Garçon N. Vaccine adjuvants: from 1920 to 2015 and beyond. *Vaccines* 2015; 3: 320–343.
- 68 Petrovsky N. Comparative safety of vaccine adjuvants: a summary of current evidence and future needs. *Drug Saf*. 2015; 38: 1059–1074.
- 69 Namazi H, Adeli M. Dendrimers of citric acid and poly (ethylene glycol) as the new drug-delivery agents. *Biomaterials* 2005; 26: 1175–1183.
- 70 Prempeh H, Smith R, Müller B. Foot and mouth disease: the human consequences. *BMJ* 2001; 322: 565–566.
- 71 Waters RA, Wadsworth J, Mioulet V, Shaw AE, Knowles NJ, Abdollahi D., *et al.* Foot-and-mouth disease virus infection in the domestic dog (*Canis lupus familiaris*), Iran. *BMC Vet Res* 2021; 17(1):63.
- 72 Forner M, Cañas-Arranz R, Defaus S, de León P, Rodríguez-Pulido M, Ganges L, *et al.* Peptide-based vaccines: foot-and-mouth disease virus, a paradigm in animal health. *Vaccines*. 2021; 9: 477.
- 73 Zhang Z, Pan L, Ding Y, Zhou P, Lv J, Chen H, *et al.* Efficacy of synthetic peptide candidate vaccines against serotype-A foot-and-mouth disease virus in cattle. *Appl Microbiol Biotechnol*. 2015; 99: 1389–1398.
- 74 Ghaffarifar F. Plasmid DNA vaccines: where are we now? *Drugs Today*. 2018; 54: 315–333.
- 75 Begley A. Zycov-D becomes world's first plasmid DNA vaccine for COVID-19. www.europeanpharmaceuticalreview.com/news/160968/zycov-d-becomes-worlds-first-plasmid-dna-vaccine-for-covid-19/. [Accessed January 4, 2022].
- 76 Leifert JA, Whitton JL. Immune responses to DNA vaccines: induction of CD8 T cells. In: *Madame Curie Bioscience Database*. Austin: Landes Bioscience; 2000–2013.
- 77 Mignani S, El Kazzouli S, Bousmina MM, Majoral J-P. Dendrimer space concept for innovative nanomedicine: a futuristic vision for medicinal chemistry. *Prog Polym Sci*. 2013; 38: 993–1008.

Figure 1. Comparison of (a) linear polymers versus (b) dendritic polymers.

Figure 2. Chemical structure of 2D G4 polyamidoamine (PAMAM) dendrimers, their functional core, surface functions, internal cavities, and monomer elements.

Figure 3. Schematic of bifunctional (a) D-valproic acid (VPA), (b) D-N-acetyl cysteine (NAC), and (c) G6 hydroxyl-Cy5 polyamidoamine (PAMAM) dendrimers.

Figure 4. Schematic of constructs 1, 2, 3, 1', 2', and 3' based on dendrimer architecture developed against foot and mouth disease virus in pigs.

Figure 5. Chemical structure of citric acid-polyethylene glycol-citric acid (CPEGC) triblock dendrimers (generation 2) developed to treat rabies.

Figure 6. 2D chemical structure of (a) B₄T developed by Cubillos *et al.*,³³ and (b) B₄T¹ and B₂T¹, developed by Soria *et al.*³⁴ against foot and mouth disease virus in cattle.

Table 1. Studies of dendrimers in veterinary applications

Species	Agent	Disease	Administration route	Refs
Cattle	Dendrimer peptide vaccine	FMDV	sc	34
Chickens	Dendrigraft poly-L-lysines	H9N2 avian influenza virus	im	37
Dogs	VPA and NAC encapsulated in G4 hydroxy-PAMAM dendrimers	HAC	iv	38
	G6 hydroxyl-PAMAM dendrimers	HAC	iv	39,40
	PEGylated G2 citric-acid based dendrimers	Rabies	ip	41
	Construction (recombinant C1 antigen/G4 PAMAM dendrimer/CYS-SAM/gold surface) of SPR immunosensor to evaluate reaction kinetics between <i>Leishmania infantum</i> and specific antibodies (IgG anti-C1) for detection of visceral leishmaniasis	Visceral leishmaniasis		43
Guinea pigs	G4 hydroxyl-PAMAM dendrimer	<i>Escherichia coli</i>	Topical cervical application	42
Pigs	Dendrimer peptide vaccine	FMDV	im	33
	PEGylated dendrimeric peptide	SFV	im	35,36

Linear polymers



Dendritic polymers

Polydisperse frameworks

Monodisperse frameworks

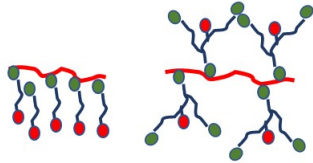

Comb polymers

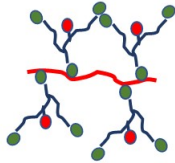

Hyperbranched polymers

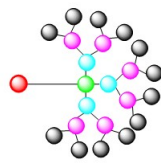

Dendrons



Star polymers

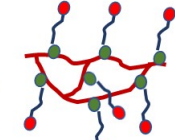

Reticulated polymers

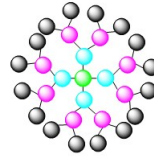

Dendrimers

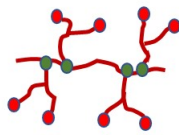

Dendrigrafts

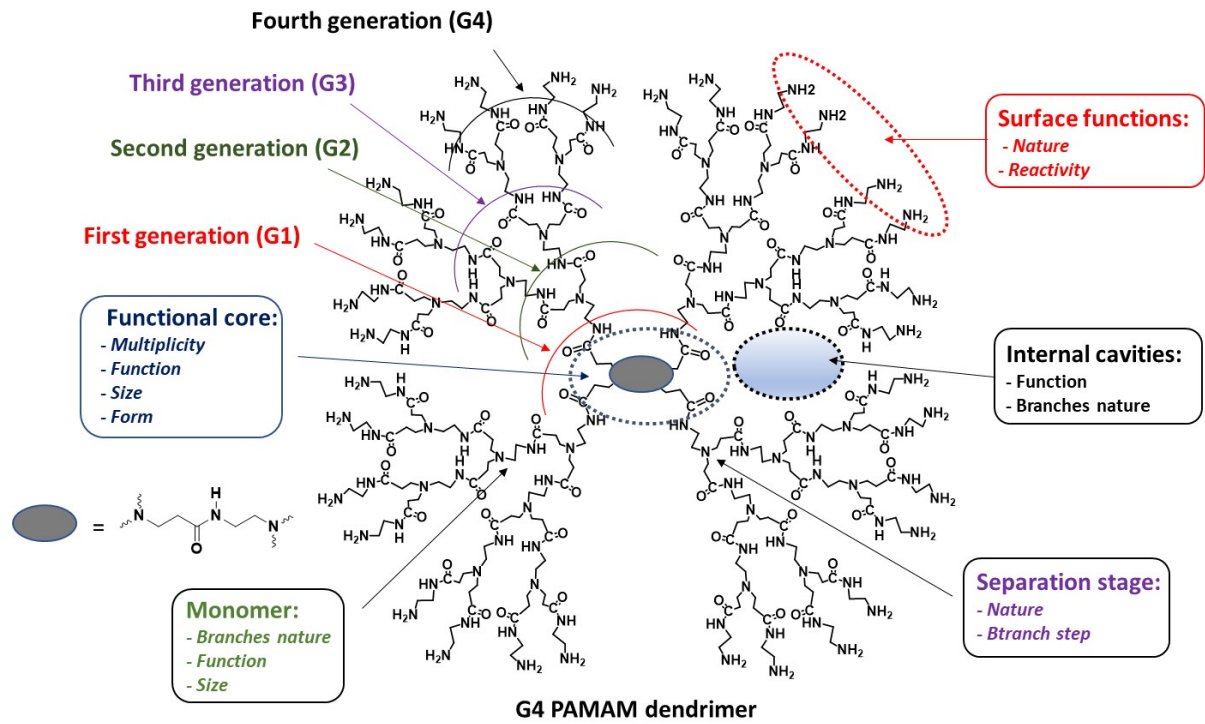

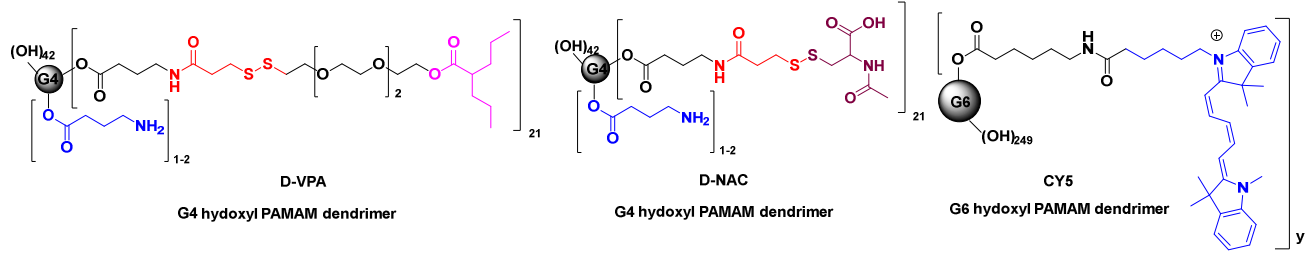

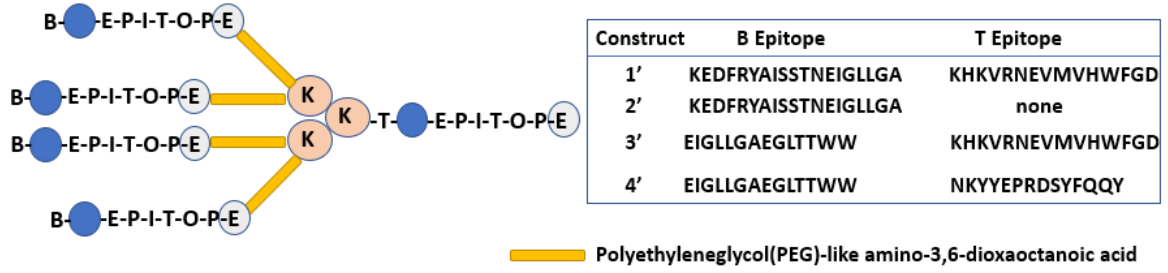
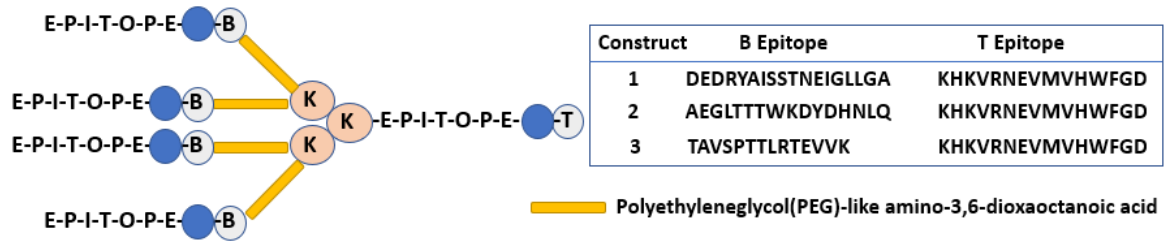

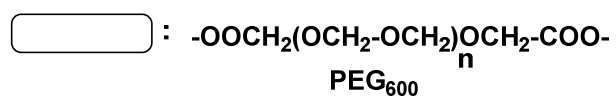
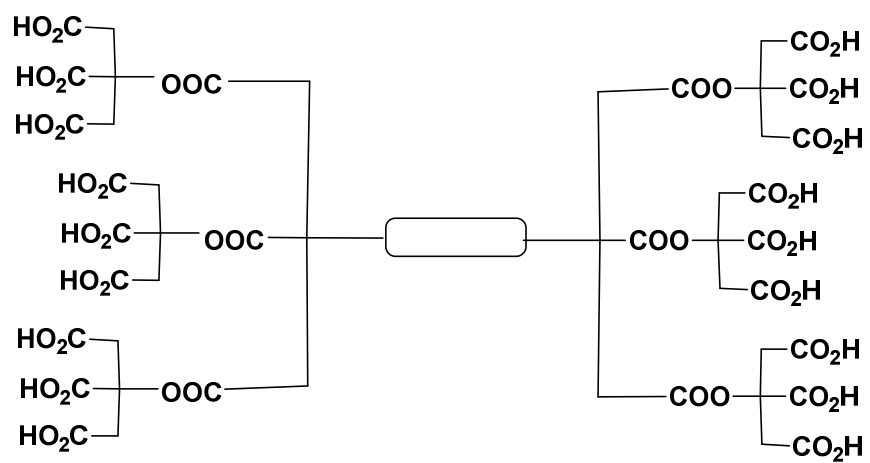

Ac-Y-T-A-S-A-R-G-D-L-A-H-L-T-T-H-A-R-H-C

B₄T (Cubillos, 2008)

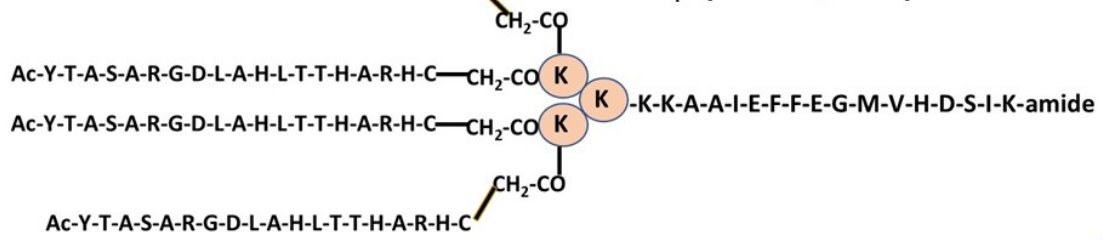

B epitope

B₄T' and B₂T' (Soria, 2018)

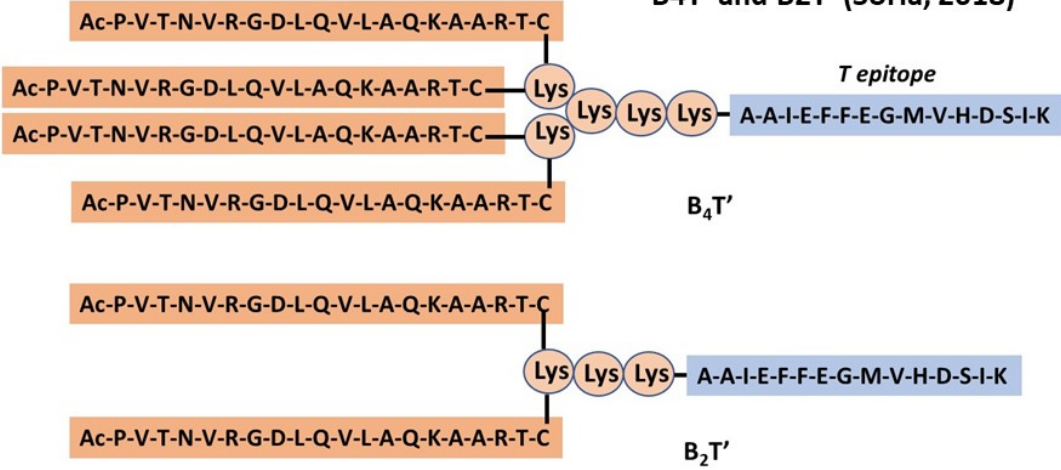

Veterinary medicine applications

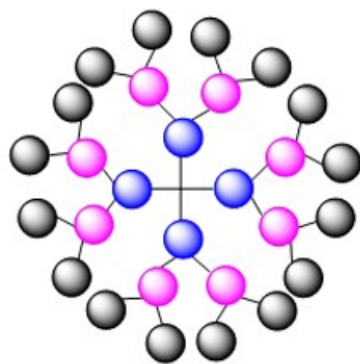
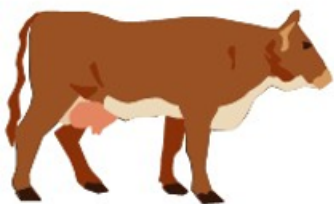

Dendrimer platforms