



HAL
open science

Neural processes underlying the foveation and tracking of a moving visual target

Laurent Goffart

► **To cite this version:**

Laurent Goffart. Neural processes underlying the foveation and tracking of a moving visual target. Bilateral symposium in Neuroscience (Aix-Marseille University & University of Tübingen), Oct 2019, Marseille, France. <hal-03654895>

HAL Id: hal-03654895

<https://hal.science/hal-03654895v1>



Submitted on 29 Apr 2022

HAL is a multi-disciplinary open access archive for the deposit and dissemination of scientific research documents, whether they are published or not. The documents may come from teaching and research institutions in France or abroad, or from public or private research centers.

L'archive ouverte pluridisciplinaire **HAL**, est destinée au dépôt et à la diffusion de documents scientifiques de niveau recherche, publiés ou non, émanant des établissements d'enseignement et de recherche français ou étrangers, des laboratoires publics ou privés.



HAL Authorization

Bilateral symposium in Neuroscience
 Aix-Marseille University & University of Tübingen
 Marseille, 2019 October 7th





Neural processes underlying the foveation and tracking of a moving visual target

Laurent Goffart, PhD



Questions at the root of Science

How assemblies of neurons distributed throughout the brain enable a subject with the ability to localize and pursue an object situated in the physical world ?

How to relate activities of *microscopic* elements (neurons) to *macroscopic* behavioral (kinematic) parameters ?
What does this relation tell us ?

How to relate events unfolding in mediums of different complexity order, mediums characterized by radically different constraints and temporalities ?

Questions at the root of Science

How assemblies of neurons distributed throughout the brain enable a subject with the ability to localize and pursue an object situated in the physical world ?

How to relate activities of *microscopic* elements (neurons) to *macroscopic* behavioral (kinematic) parameters ?
What does this relation tell us ?

How to relate events unfolding in mediums of different complexity order, mediums characterized by radically different constraints and temporalities ?

The cerebral and physical mediums are *not independent* from each other :

- neuronal dysfunction → behavioral consequences
- repeated exposure to an environment → behavioral changes → changes in sensorimotor transformations (e.g. Bourrelly, Quinet, Cavanagh & Goffart *Journal of Neurophysiology* 2016)

MOVIE

Two types of eye movement in response to the motion of a visual target

rapid : saccade
slow : pursuit

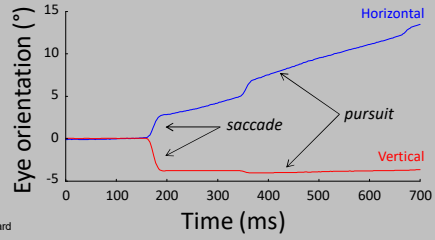

values > 0 : rightward / upward
value = 0 : straight ahead
values < 0 : leftward / downward

Two types of eye movement in response to the motion of a visual target

rapid : saccade
slow : pursuit

*same muscles and motor nuclei BUT largely distinct cerebral populations
two premotor input : PHASIC (burst) and TONIC*

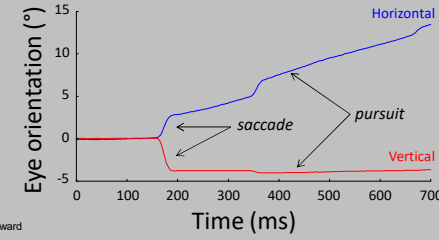

values > 0 : rightward / upward
value = 0 : straight ahead
values < 0 : leftward / downward

Two types of eye movement in response to the motion of a visual target

rapid : saccade

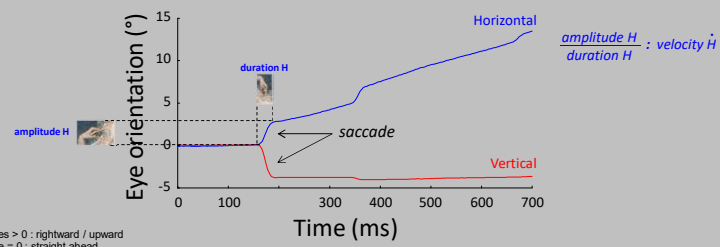

values > 0 : rightward / upward
value = 0 : straight ahead
values < 0 : leftward / downward

Two types of eye movement in response to the motion of a visual target

rapid : saccade
slow : pursuit

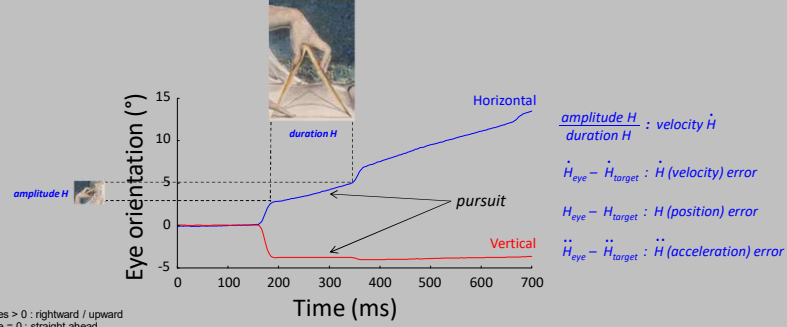

values > 0 : rightward / upward
value = 0 : straight ahead
values < 0 : leftward / downward

Dividers, physical quantities and mathematics in the brain ?



CIRCUIT FOR PURSUIT

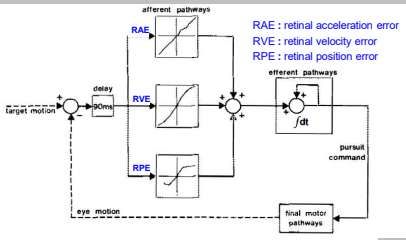

Lisberger, Morris & Tychsen *Annual Rev Neurosci* 1987

CIRCUIT FOR SACCADE

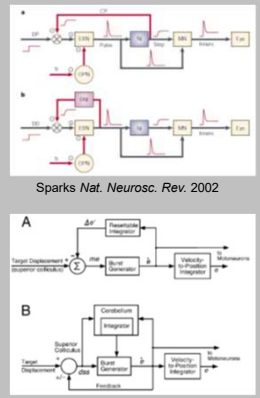

Sparks *Nat. Neurosci. Rev.* 2002

Scudder, Kaneko & Fuchs *Exp. Brain Res.* 2002

Motor Error = Desired - Current Positions (DP - CP)

Motor Error = Desired - Current Eye Displ. (DD - CD)

Motor Error = Target - Eye Displ. (TD - ED)

\dot{e} : eye velocity

Target Displacement Initial Motor Error



When a model is adopted, results are often interpreted within its framework. If the data do not fit with the model predictions, some tweaks or smart adjustments can be made in the model.

But we can also ask ourselves :
Is there anything in the brain activity that would correspond to amplitude, duration and velocity?

This is a crucial question because we can search for such signals in the brain activity for a very long time, an even longer time if these notions have no physiological substrate.

When evidence is found, we must also verify that the empirical data have not been distorted by statistical or analytical artefacts (e.g., coding of dynamic motor error in the SC, coding of eye velocity by premotor burst neurons, coding of saccade duration in the oculomotor vermis etc.).

Dividers, physical quantities and mathematics in the brain ?



QUESTIONING THE BRAIN-MODEL ISOMORPHISM :

Kinematic measurements (spatial / temporal)

↔

Position error
Velocity error
Accel. error

↔



brain

behavior model brain

The fact that we measure and model the movement of the eyeball (a rigid body) with kinematic notions does not imply an equivalence in the brain, and notably that the firing of neurons ought to "encode" (i.e., *emit signals related to*) amplitude, velocity or acceleration of the eye movement.

SPACE-TIME REPRESENTATION IN THE BRAIN. THE CEREBELLUM AS A PREDICTIVE SPACE-TIME METRIC TENSOR

A. PELLIONISZ and R. LLINÁS
Department of Physiology and Biophysics, New York University Medical Center, 550 First Avenue, New York, NY 10016, U.S.A.

Understanding of brain function is often limited by the tacit acceptance of concepts known to be basically inappropriate. An example is the tenet that the brain, in its internal workings, utilizes space-time reference frames similar to those used in classical mechanics.

However, the utilization of separate systems of coordinates for space and time hinges upon the concept of simultaneity. Since within the brain there is no 'instantaneous' simultaneity agent comparable to the light, the classical usage of separate space and time coordinates is inappropriate in the case of describing the inner workings of the CNS.



Dividers, physical quantities and mathematics in the brain ?

QUESTIONING
THE BRAIN-MODEL ISOMORPHISM :

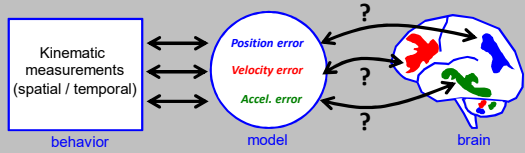

The fact that we measure and model the movement of the eyeball (a rigid body) with kinematic notions does not imply an equivalence in the brain, and notably that the firing of neurons ought to "encode" (i.e., *emit signals related to*) amplitude, velocity or acceleration of the eye movement.

Is it possible to study the neurophysiology of visually-guided eye movements without embedding kinematic notions within the brain functioning ?

Alternative viewpoint

No physical movement = equilibrium of commands
Movement onset = broken equilibrium
Saccade = restoration of equilibrium ; pursuit = sustained disequilibrium

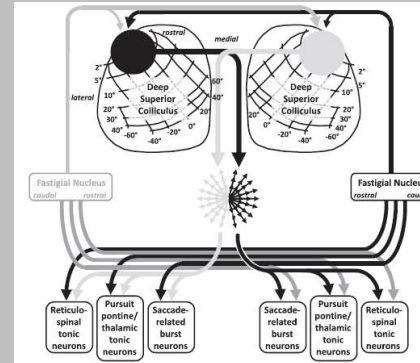

J. Neurophysiol. 103: 3234–3245, 2010. Free published October 11, 2010. doi:10.1152/jn.0082.2010.

REVIEW | The Role of Eye Movements in Perception, Cognition, and Action

Neurophysiology of visually guided eye movements: critical review and alternative viewpoint

© Laurent Goffart,^{1,2} Clara Boreilly,¹ and Jean-Charles Quintana³
¹Aix Marseille Université, Centre National de la Recherche Scientifique, Institut de Neurosciences de la Timone, Marseille, France; ²Aix Marseille Université, Centre National de la Recherche Scientifique, Centre Gilles Guéhen Cozanger, Aix-en-Provence, France; and ³Université Grenoble Alpes, Centre National de la Recherche Scientifique, Laboratoire Jean Kuntzmann, Grenoble, France

Journal of Neurophysiology vol. 120, pp 3234-3245, 2018

Kinematics and the neurophysiological study of visually-guided eye movements

Laurent Goffart^{1,2,3}
¹Aix Marseille Université, CNRS, IRT, Institut de Neurosciences de la Timone, Marseille, France
²Aix Marseille Université, CNRS, CIGCM, Centre Gilles Guéhen Cozanger, Aix-en-Provence, France
³Corresponding author: Tel.: +33 692248572, e-mail address: laurent.goffart@univ-amu.fr

Progress in Brain Research, vol. 248, pp 375-384, 2019

Looking at a visual target

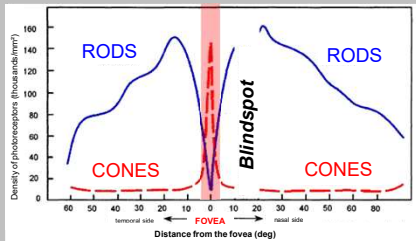

Non-homogeneous retina

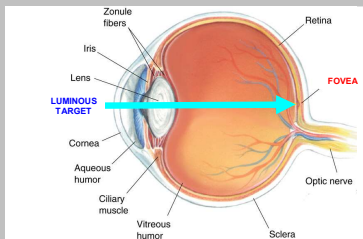

Foveal projection of target image requires tonic contraction of extraocular muscles
→ gaze direction

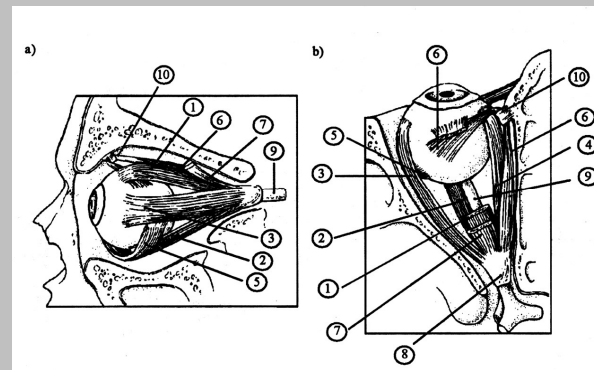

Foveal projection of target image requires tonic contraction of neck muscles
 → head direction

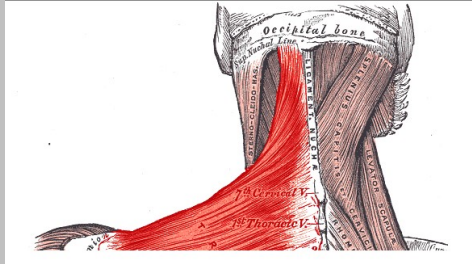

Looking at a visual target **IS** contracting multiple muscles

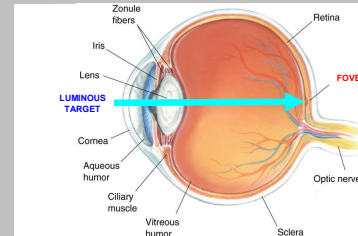

Reticulo-cerebellar interactions and the adjustment of eye and head orientations

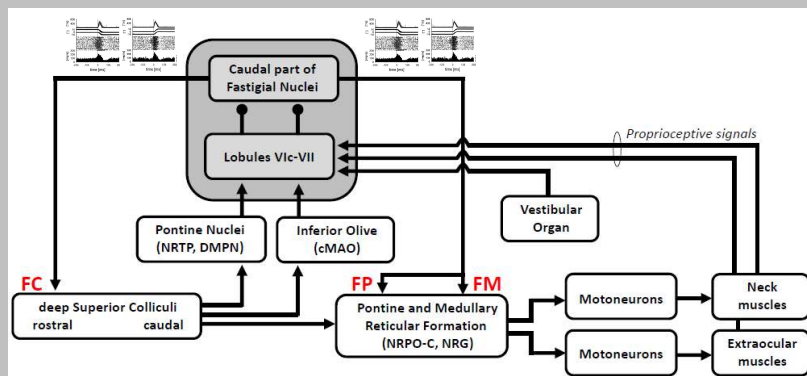

Head direction as equilibrium

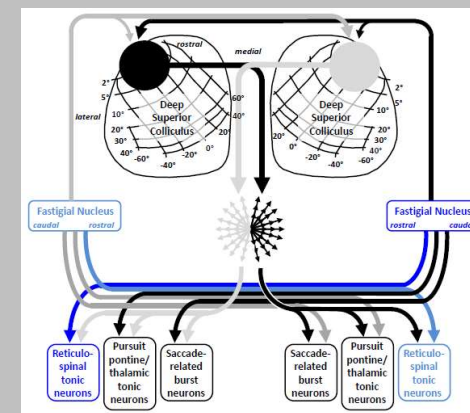

Fastigio-reticulo-spinal perturbation
 → cervical dystonia

Cervical dystonia

Muscimol (right cFN)



Goffart & Pélisson *J Neurophysiol* 1998 (head free cat)
 Quinet & Goffart *J Neurophysiol* 2005 (head free monkey)

Gaze direction as equilibrium

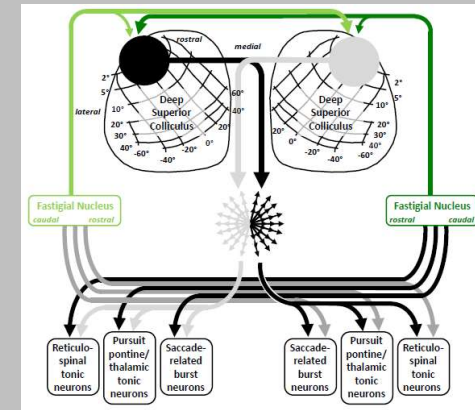

Fastigio-colicular perturbation
 → fixation offset

Progress in Brain Research 2019

Fixation offset in the monkey

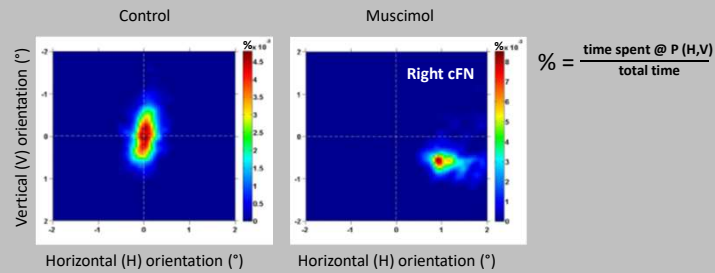

Direction of fixational saccades

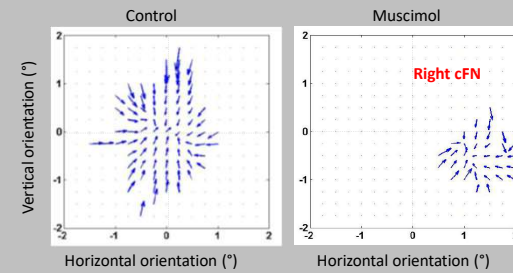

Gaze direction as **multi-equilibrium**

Multiple simultaneous equilibria

Two types of input drive the activity of motoneurons :

- * PHASIC (bursting) → saccade
- * TONIC (sustained) → glissade

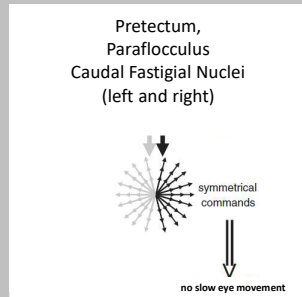
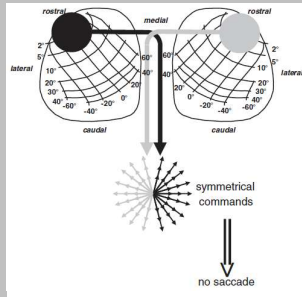

Saccade as restoration of equilibrium

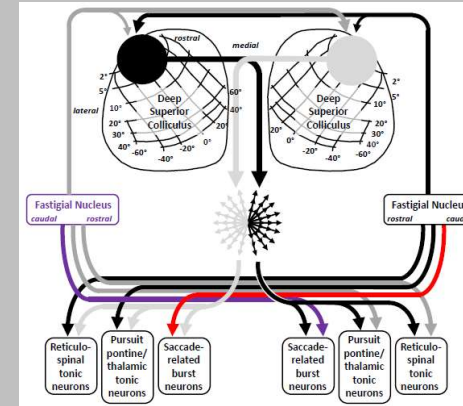

Fastigio-reticular perturbation
→ saccade dysmetria

Progress in Brain Research 2019

Saccade dysmetria during cFN inhibition

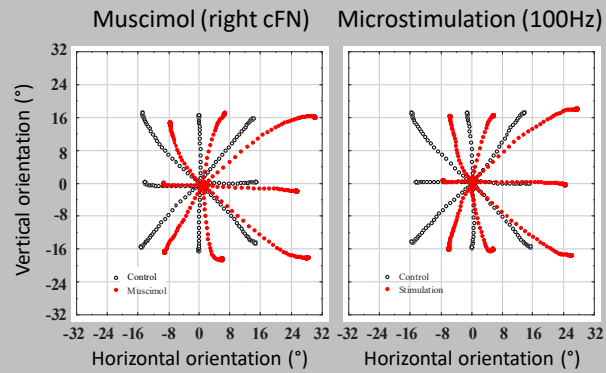

Dysmetria of **horizontal** component due to the suppression of intrasaccadic burst

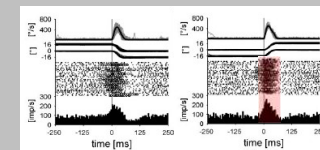
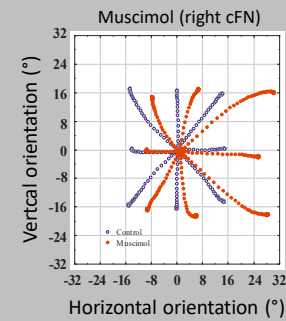

Modified from Kleine, Guan & Büttner J Neurophysiol 2003

Horizontal saccade as restoration of equilibrium under fastigial control

J Neurophysiol 92: 3351-3367, 2004.
 First published June 30, 2004; doi:10.1152/jn.01199.2003.

Deficits in Saccades and Fixation During Muscimol Inactivation of the Caudal Fastigial Nucleus in the Rhesus Monkey

For every saccade (horizontal, oblique or vertical), the left and right cFN regulate the balance of activity between excitatory input (EBNs) and inhibitory input (IBNs) to the motor and internuclear neurons in the abducens nucleus (Goffart, Chen & Sparks *J Neurophysiol* 2004).

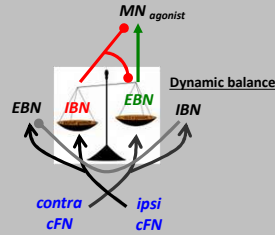

Extending the bilateral hypothesis to pursuit (pursuit as sustained imbalance)

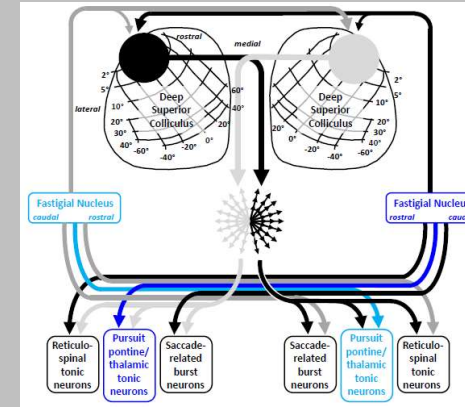

Progress in Brain Research 2019

Fastigio-pontine perturbation
 → impaired pursuit

MOVIE

Extending the bilateral hypothesis to pursuit (pursuit as sustained imbalance)



The caudal fastigial nucleus and the steering of saccades toward a moving visual target

Chen Bourreilly,^{1,2} Julie Quinet,¹ and Laurent Goffart¹
¹Unité de Neurosciences de la Vision, CNRS UMR 5206 Centre National de la Recherche Scientifique, Aix-Marseille Université, Marseille, France and ²Université Paris-Saclay, CNRS UMR 8551, Centre National de la Recherche Scientifique, Université Paris-Saclay, Paris, France

Journal of Neurophysiology 2018

Pursuit disorder and saccade dysmetria after caudal fastigial inactivation in the monkey

Chen Bourreilly,^{1,2} Julie Quinet,¹ and Laurent Goffart¹
¹Unité de Neurosciences de la Vision, CNRS UMR 5206 Centre National de la Recherche Scientifique, Aix-Marseille Université, Marseille, France and ²Université Paris-Saclay, CNRS UMR 8551, Centre National de la Recherche Scientifique, Université Paris-Saclay, Paris, France

Journal of Neurophysiology 2018

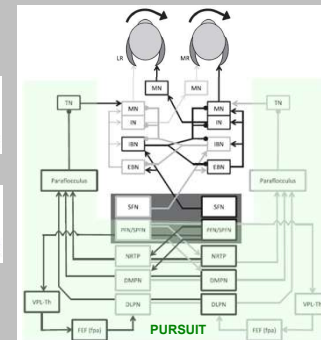

Bourreilly, Quinet & Goffart *Journal of Neurophysiology* 2018

Perturbation → slower pursuit
 No alteration of pursuit latency (pursuit onset due to asymmetry in bilateral NOT activity)

SUMMARY : Bilateral hypothesis

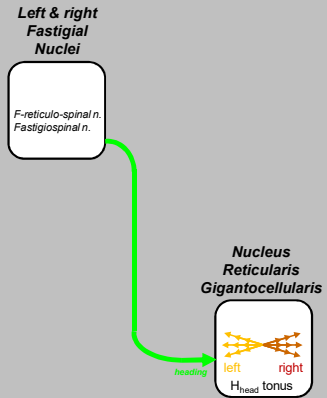

SUMMARY : Bilateral hypothesis

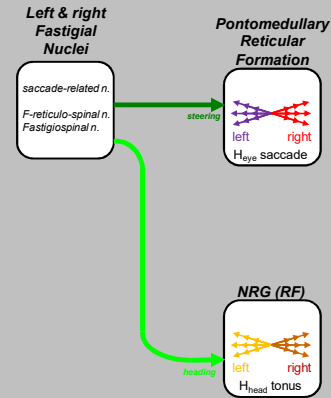

SUMMARY : Bilateral hypothesis

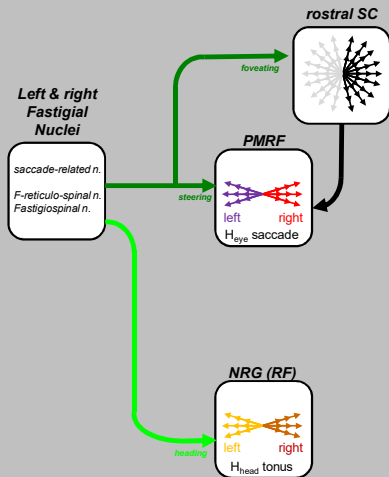

SUMMARY : Bilateral hypothesis

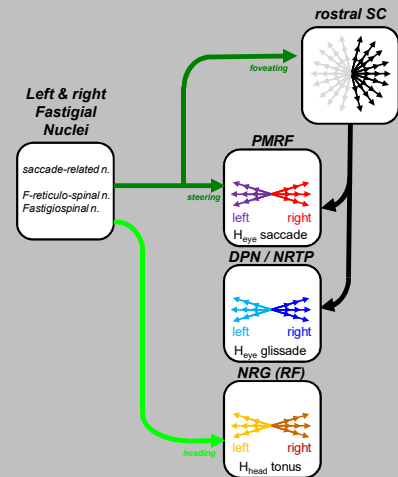

SUMMARY : Bilateral hypothesis

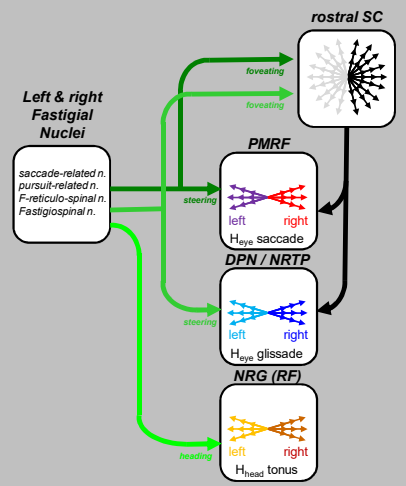

SUMMARY : Bilateral hypothesis

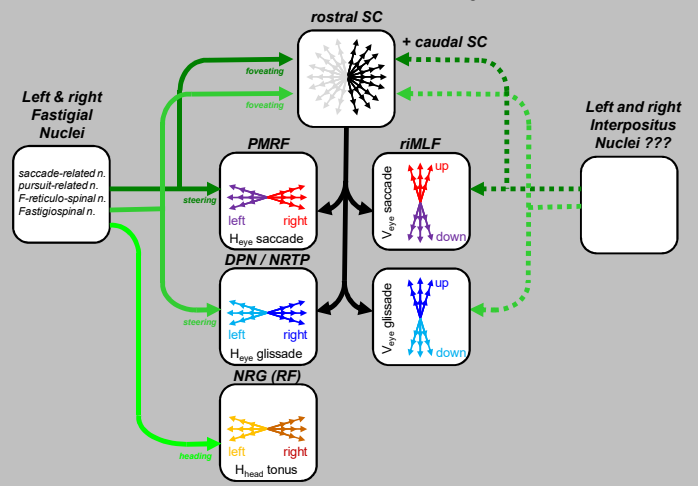

Dysmetria of vertical component

Microstimulation **outside the** Fastigial Oculomotor Region (Hor)

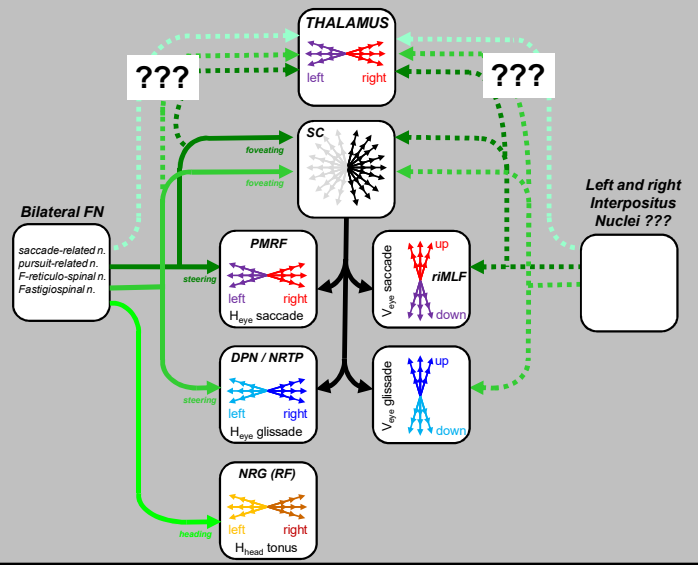
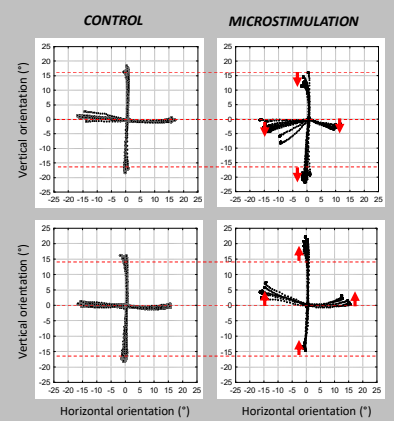

THANKS



Clara Bourrelly, PhD
Lorenzo Guerrasio, PhD
Julie Quinet, PhD

Ulrich Büttner, PhD
Patrick Cavanagh, PhD
Lewis Chen, PhD
Ziad Hafed, PhD
Richard Krauzlis, PhD
David Sparks, PhD

