



**HAL**  
open science

## Distributed optimal power flow and the multi-agent system for the realization in cyber-physical system

Tung-Lam Nguyen, Quoc-Tuan Tran, Raphaël Caire, Yu Wang, Yvon Bésanger, Ngoc-An Luu

► **To cite this version:**

Tung-Lam Nguyen, Quoc-Tuan Tran, Raphaël Caire, Yu Wang, Yvon Bésanger, et al.. Distributed optimal power flow and the multi-agent system for the realization in cyber-physical system. *Electric Power Systems Research*, 2021, 192, 10.1016/j.epsr.2020.107007. hal-03651464

**HAL Id: hal-03651464**

**<https://hal.science/hal-03651464>**

Submitted on 17 May 2022

**HAL** is a multi-disciplinary open access archive for the deposit and dissemination of scientific research documents, whether they are published or not. The documents may come from teaching and research institutions in France or abroad, or from public or private research centers.

L'archive ouverte pluridisciplinaire **HAL**, est destinée au dépôt et à la diffusion de documents scientifiques de niveau recherche, publiés ou non, émanant des établissements d'enseignement et de recherche français ou étrangers, des laboratoires publics ou privés.

# Distributed Optimal Power Flow and the Multi-agent System for the Realization in Cyber-physical System

Tung-Lam Nguyen<sup>a,\*</sup>, Quoc-Tuan Tran<sup>c</sup>, Raphael Caire<sup>b</sup>, Yu Wang<sup>d</sup>, Yvon Besanger<sup>b</sup>, Ngoc-An Luu<sup>a,\*</sup>

<sup>a</sup>*The University of Danang - University of Science and Technology, Danang, Vietnam*

<sup>b</sup>*Univ. Grenoble Alpes, CNRS, Grenoble INP, G2Elab, 38000 Grenoble, France*

<sup>c</sup>*Univ Grenoble Alpes, CEA, LITEN, DTS, LSEI, INES, F-73370, Le Bourget-du-Lac, France*

<sup>d</sup>*Nanyang Technological University, Singapore*

---

## Abstract

The requirement for coordination of distributed energy resources in the future power system provides an incentive to move from the current high level of centralized control to a more distributed control paradigm. In this paper, an agent-based distributed optimal power flow is proposed to optimize the operation of the power system. The optimal power flow problem is built in the general consensus optimization formulation in matrix based formulation. The agent is then designed to realize the operation of the multi-agent system in the cyber-physical system. Agents have ability of collecting local measurement data, communicating with neighbor agents and implementing alternating direction method of multiplier. Each agent accesses to limited information but can give decision to solve the global problem. The performance is evaluated on the IEEE 9 bus by using a cyber Hardware-in-the-Loop platform with a cluster of hardware agents, a real-time simulator OPAL-RT and a real communication network.

*Keywords:* optimal power flow, distributed optimization, ADMM, cyber hardware-in-the-loop, the multi-agent system

---

\*Corresponding authors

*Email addresses:* [ntlam@dut.udn.vn](mailto:ntlam@dut.udn.vn) (Tung-Lam Nguyen), [quoctuan.tran@cea.fr](mailto:quoctuan.tran@cea.fr) (Quoc-Tuan Tran), [raphael.caire@g2elab.grenoble-inp.fr](mailto:raphael.caire@g2elab.grenoble-inp.fr) (Raphael Caire), [wang\\_yu@ntu.edu.sg](mailto:wang_yu@ntu.edu.sg) (Yu Wang), [Yvon.Besanger@g2elab.grenoble-inp.fr](mailto:Yvon.Besanger@g2elab.grenoble-inp.fr) (Yvon Besanger), [lnan@dut.udn.vn](mailto:lnan@dut.udn.vn) (Ngoc-An Luu)

## 1. Introduction

The optimal power flow problem (OPF) in power systems is given to find out the amount of power generated at each generator that makes the systems operate in an optimal state [1, 2]. The OPF problem is solved to obtain a global operating objective while ensuring the power balance and the physics laws of the power network. In traditional approaches, a single operator collects all necessary parameters of the system, e.g., line impedance, network topology, cost function of generators, load demands, and then execute a central computation to solve optimization problems.

In the modern power system scheme, the number of distributed generations, intelligent and controllable components is expected to rise significantly. In this paper, we propose an approach to deal with the OPF in a distributed way. Rather than collecting data and assigning the computation for a single entity, in the distributed scheme, the entire workload will be decomposed into small subproblems which need less effort to compute. The multi-agent system (MAS) which have been applied in computer science studies for years, have characteristics that make it suitable for building modern distributed control systems. An important feature, that distinguishes MAS from traditional distributed control systems, is a local intelligence embedded in each agent [3, 4, 5]. The agents obtain certain problem parameters by local measurements and communicating with limited neighbors.

The advantages of the distributed approach for solving OPF problems are [6, 7]: (i) the agents need to share limited amounts of knowledge with their neighborhood agents. This can enhance overall robustness and save costs for communication infrastructure, (ii) the total computation effort in agents is reduced. Each agent only has to solve a sub-problem with a significantly smaller dimension of variables and constraints due to the sparse communication property of grid systems. Especially, the size of the subproblems is unchanged when the network is scaled up. Meanwhile, in traditional centralized schemes, the increase of the grid size lead to a combinatorial explosion of the complexity and time consume of the computation due to the fact that OPF problems are non-polynomial difficult, (iii) distributed algorithms have the potential to respect the privacy of sensitive data of loads (e.g., household, industrial and commercial loads) or DGs (of different owners). The MAS can achieve common goals with restricted exchanged information, (iv) the robustness of the system is improved because it is not sensitive to the common mode failure related to the central unit anymore. Moreover, com-

pared to the centralized method, the distributed optimization framework is more flexible and adaptive concerning the changes of systems, especially in view that topologies of the electricity grid and the communication infrastructure in the smart grid are likely more changable.

Recently there exists many studies presenting the distributed optimization techniques for OPF problems in AC grids. We refer to [6, 7, 8, 9] for the overviews. Specifically, the distributed OPF is mainly classified into two sets [6]: (i) one is based on augmented Lagrangian decomposition including Dual Decomposition[10, 11], Alternating Direction Method of Multipliers and Augmented Lagrangian Alternating Direction Inexact Newton method (ALADIN) [12]; and (ii) one is based on decentralized solution of the Karush-Kuhn-Tucker (KKT) condition including Optimality Condition Decomposition (OCD) [13, 14] and Consensus+Innovation algorithms (C+I) [15, 16].

Alternating Direction Method of Multipliers (ADMM) uses an augmented Lagrangian function with a two-norm term and also has minimization and dual variable update steps similar to dual decomposition method [17]. In the literature, ADMM is widely used to solve OPF problems [18, 19, 20, 21] because of its simplicity and the improvement of the convergence among distributed algorithms [9, 18]. The approach in [18] is used to solve distributed OPF as a region-based optimization procedure where limited information is exchanged between neighbour regions. The work in [19] proposes an adaptive method to improve the convergence of ADMM on the component-based dual decomposition of the OPF problem. In [20], the authors address the general non-convex OPF issue by providing a method based on ADMM combined with sequential convex approximations. Recently, a further development of ADMM, which is called ALADIN, is introduced to applied to OPF problem [22, 23]. The consensus results in ALADIN method are achieved in less number of iterations compared with ADMM. However, the effort of computation in each iteration is much higher and ALADIN still relies on a centralized update step. In general, these works mostly concentrate on mathematical formulations and show numerical results that focuses on the steady state analysis without dynamic change regarding disturbances of the system. In [21], an online algorithm is proposed to pursue solutions of AC OPF under the change of grid. Nevertheless, the process of ADMM in local agent under the interaction with system and neighbor agents is not clarified. The time consumed by the computation in agent and transferring delay are not taken into account. Moreover, the validation is processed in pure simulation

without hardware agents and real-time condition of the grid. The gap between theory and practical applications is therefore still large and need to be reduced for the real deployment for MAS with distributed OPF.

In this paper, the distributed OPF problem is investigated in a more practical approach when considering the operation of MAS that implement distributed optimization algorithm. The ADMM is chosen for the good performance of the distributed system without any centralized step. We do not only provide the way to formulate and decompose the OPF problem, but also realize the MAS with realistic conditions that can be used to apply in real-world applications. The MAS run as cyber system with real messages exchanged among hardware agents under real communication network. Furthermore, the MAS can also interact with the real-time grid physical system to track the change of the system and always minimize the total power losses. One agent manages one sub-system of the OPF problem to implement ADMM algorithm. The agents are independent entities and run asynchronously with abilities of gathering measurements, computation and interfacing with local devices.

The major contributions of this study are:

- The subsystem of the OPF consensus problem is presented in detail and written in matrix based formulation that is convenient to express in software program. The Jacobian matrices are also easily computed in this type of formulation that is necessary for optimization solver.
- The iterative process of implementing asynchronously ADMM in an agent is presented in detail and analyzed in time domain considering communication delay among agents.
- The agent is systematically designed to able to operate in the realistic environment. The agent has multiple functions: (i) run RPC server/client structure to exchange message in real communication network, (ii) interface with devices to transfer local data and adapt to the variation of the power grid, and (iii) process ADMM algorithm to solve the distributed OPF problem based on information collected.
- The implementation of MAS is verified by deploying on a cyber Hardware-in-the-loop (HIL) platform. The MAS is realized by using a cluster of microprocessors Raspberry PI and a switch for real communication network. The OPAL-RT is used to simulate the grid in real-time and

emulate the change of the physical system under the interaction of the running MAS. The convergence will be shown in practical implementations, and obtained results will be compared with those when solved in the centralized approach.

The paper is structured as follows. Section 2 presents the general optimization consensus problem and the ADMM algorithm for solving the general problem in distributed way. In Section 3, we provide the OPF problem in the general consensus problem. Then, the application of ADMM for the distributed OPF problem is given. Section 4 presents the structure of the agent designed for distributed OPF purpose by implementing ADMM. Section 5 investigates the transient behavior of the 9-bus test case system in the cyber HIL test bed with the hardware MAS. Finally, Section 6 draws conclusions.

## 2. Alternating Direction Method of Multipliers for General Distributed Problems

### 2.1. General Structures of Consensus Problems

We consider a system consisting of  $K$  subsystems. The global objective of the general form consensus problem is:

$$f = \sum_{k=1}^K f_k(x_k) \quad (1)$$

where

$f_k$  is the private function handled by subsystem  $k$ ,

$\mathbf{x}_k \in \mathbb{R}^{N_k}$  is the vector of local variables of subsystem  $k$ . These variables are coupled with variables in the neighbor subsystems. Each component of  $\mathbf{x}_k$  is a local copy of a global variable of the whole system.

Let  $\mathbf{z} \in \mathbb{R}^N$  be the vector of the global variables. It can be considered that component  $n$  of  $\mathbf{z}$  is distributed its copies to a set of subsystems which creates net  $n$ . Figure 1 shows the relation of variables in a distributed problem with  $K$  subsystems. In the figure, elements in one net are represented in a color. The constraint for ensuring the equality of the local copies of the same net is:

$$\mathbf{x}_k = \mathbf{E}_k \mathbf{z} \quad k = 1, 2, \dots, K \quad (2)$$

where

$$(E_k)_{n,m} = \begin{cases} 1 & \text{if } (x_k)_n \text{ is in net } m \\ 0 & \text{otherwise} \end{cases} \quad (3)$$

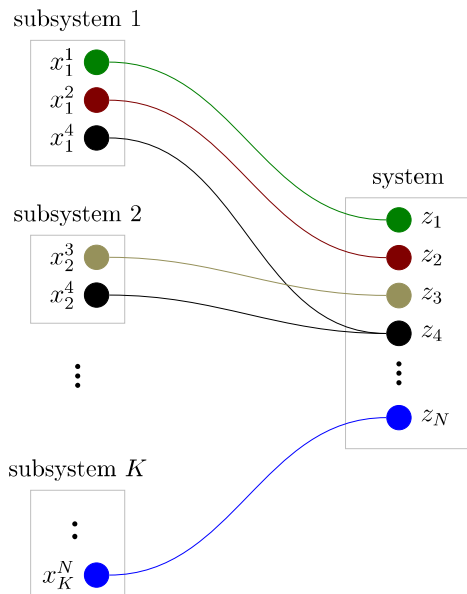

Figure 1: The relation of variables in a distributed problem. Coupling is represented by the global variable  $\mathbf{z}$ , together with the constraints  $\mathbf{x}_k = \mathbf{E}_k \mathbf{z}, k = 1, \dots, K$ , where  $\mathbf{E}_k$  projects global variables to the corresponding local variables.

## 2.2. Alternating Direction Method of Multipliers

This section introduces Alternating Direction Method of Multipliers algorithm for solving a distributed problem based on the material originally presented in [17]. The main advantage for using ADMM is that it inherits the benefits of dual decomposition and augmented Lagrangian methods for constrained optimizations with fast convergence properties. We now consider the problem in general decomposition structure. The objective and constraint terms are split into  $K$  parts:

$$\begin{aligned}
 & \text{minimize} && \sum_{k=1}^K f_k(x_k) \\
 & \text{subject to} && \mathbf{x}_k \in \mathcal{C}_k, \quad k = 1, \dots, K \\
 & && \mathbf{x}_k = \mathbf{E}_k \mathbf{z}, \quad k = 1, \dots, K
 \end{aligned} \tag{4}$$

where the variables are  $\mathbf{x}_k \in \mathbb{R}^{N_k}$  and  $\mathbf{z} \in \mathbb{R}^N$ .

The coupling constraint can be simplified as:

$$\mathbf{x}_k - \tilde{\mathbf{z}}_k = 0 \quad (5)$$

where  $\tilde{\mathbf{z}} \in \mathbb{R}^{N_k}$  is the fraction of the variable  $\mathbf{z}$  that local variable  $\mathbf{x}_k$  should be.

The augmented Lagrangian of Problem 4 related to the coupling constraint is given by:

$$L_\rho(\mathbf{x}, \mathbf{z}, \lambda) = \sum_{k=1}^K (f_k(\mathbf{x}_k) + \boldsymbol{\lambda}_k^T (\mathbf{x} - \tilde{\mathbf{z}}_k) + (\rho/2) \|\mathbf{x}_k - \tilde{\mathbf{z}}_k\|_2^2) \quad (6)$$

where  $\boldsymbol{\lambda}_k \in \mathbb{R}^{N_k}$  is the dual variables associated with the equality constraint,  $\rho \in \mathbb{R}$  is the Lagrangian step parameter.

The ADMM is summarized in Algorithm 1. The variables are updated in an iterative way.  $\mathbf{x}^n, \mathbf{z}^n$  and  $\boldsymbol{\lambda}^n$  are the variables  $\mathbf{x}, \mathbf{z}$  and  $\boldsymbol{\lambda}$  respectively after iteration  $n$ .

---

**Algorithm 1: ADMM.**

---

- 1  $n = 0$ : initial  $\mathbf{z}^0$  and  $\boldsymbol{\lambda}^0$  are given
  - 2 **repeat**
  - 3      $\mathbf{x}$  update:  $\mathbf{x}_k^{n+1} = \underset{\mathbf{x}_k}{\operatorname{argmin}} L_\rho(\mathbf{x}_k, \mathbf{z}^n, \boldsymbol{\lambda}_k^n) =$   
 $\underset{\mathbf{x}_k}{\operatorname{argmin}} (f_k(\mathbf{x}_k) + \boldsymbol{\lambda}_k^{nT} \mathbf{x}_k + (\rho/2) \|\mathbf{x}_k - \tilde{\mathbf{z}}_k^n\|_2^2)$
  - 4      $\mathbf{z}$  update:  $\mathbf{z}^{n+1} = \underset{\mathbf{z}}{\operatorname{argmin}} L_\rho(\mathbf{x}_k^n, \mathbf{z}, \boldsymbol{\lambda}_k^n) =$   
 $\underset{\mathbf{z}}{\operatorname{argmin}} \sum_{k=1}^m (-\boldsymbol{\lambda}_k^{nT} \tilde{\mathbf{z}}_k + (\rho/2) \|\mathbf{x}_k^{n+1} - \tilde{\mathbf{z}}_k^n\|_2^2)$
  - 5      $\boldsymbol{\lambda}$  update:  $\boldsymbol{\lambda}_k^{n+1} = \boldsymbol{\lambda}_k^n + \rho(\mathbf{x}_k^{n+1} - \tilde{\mathbf{z}}_k^{n+1})$
  - 6      $n = n + 1$
- 

In the distributed scheme, each agent manages a subproblem and has the responsibility of handling its own objective and constraints. The variables are updated each iteration and converge to a common value, which is the solution of the full problem of the whole original system. As presented in the algorithm, the local variable  $\mathbf{x}_k$  and the dual variable  $\boldsymbol{\lambda}_k$  can be updated independently in parallel. Only at step 4 when updating the global variable  $\mathbf{z}$ , agents need the information from neighbors. Although it is not shown directly in the mathematical formulation, each component of the global variable



in an agent can be found out by averaging all values of  $\beta = x_k^{n+1} + (1/\rho)\lambda_k^n$  that obtained via exchanging messages.

### 3. Formulation of an Optimal Power Flow Problem

#### 3.1. General Optimal Power Flow Formulation

We consider an electrical network composed of  $N$  buses and  $L$  lines with the set of buses  $\mathcal{N} = \{1, 2, \dots, N\}$  and set of lines  $\mathcal{L} = \mathcal{N} \times \mathcal{N}$ . Initially, some notations are introduced to express the formulation of the power flow equation. The set of generator buses is  $\mathcal{G} \subseteq \mathcal{N}$  and the power of generator at bus  $k \in \mathcal{G}$  is  $s_k^G = p_k^G + jq_k^G \in \mathbb{C}$ . The load power at bus  $k \in \mathcal{N}$  is  $s_k^L = p_k^L + jq_k^L \in \mathbb{C}$ . The injected power at bus  $k$ :

$$s_k = p_k + jq_k = \begin{cases} s_k^G - s_k^L & \text{if } k \in \mathcal{G} \\ -s_k^L & \text{otherwise} \end{cases} \quad (7)$$

The set of the injected power of all buses is denoted as the vector  $\mathbf{s} = \mathbf{p} + j\mathbf{q}$ .

The other two important parameters of the network are bus voltages and current injections. The current injection at bus  $k$  is defined as the total current injected into bus  $k$  and denoted as  $i_k = i_k^{re} + ji_k^{im}$ . In the vector form for the system, the collection of the current injection is vector  $\mathbf{i} = \mathbf{i}^{re} + j\mathbf{i}^{im}$ . The vector of bus voltages is written in rectangular form as  $\mathbf{v} = \mathbf{v}^{re} + j\mathbf{v}^{im}$ , where component  $k$  is  $v_k = v_k^{re} + jv_k^{im}$ .

The admittance value of line  $(m, n) \in \mathcal{L}$  is  $y_{mn} = g_{mn} + jb_{mn} \in \mathbb{C}$ , where  $g_{mn} \in \mathbb{R}$  is the real part and  $b_{mn} \in \mathbb{R}$  is the imaginary part of the flow line admittance. The admittance of the whole network is expressed by the vector  $\mathbf{Y} = \mathbf{G} + j\mathbf{B} \in \mathbb{C}^{N \times N}$ .

The relation between the bus voltages and the current injection is:

$$\mathbf{i} = \mathbf{Y} \cdot \mathbf{v} = (\mathbf{G} \cdot \mathbf{v}^{re} - \mathbf{B} \cdot \mathbf{v}^{im}) + j(\mathbf{B} \cdot \mathbf{v}^{re} + \mathbf{G} \cdot \mathbf{v}^{im}) \quad (8)$$

The injected power is expressed in the relation of voltages and current injection:

$$\mathbf{s} = \mathbf{v} \otimes \mathbf{i}^* = (\mathbf{v}^{re} \otimes \mathbf{i}^{re} + \mathbf{v}^{im} \otimes \mathbf{i}^{im}) + j(\mathbf{v}^{im} \otimes \mathbf{i}^{re} - \mathbf{v}^{re} \otimes \mathbf{i}^{im}) \quad (9)$$

From (8) and (9) we have:

$$\mathbf{s} = \mathbf{p} + j\mathbf{q} = \mathbf{v} \otimes (\mathbf{Y} \cdot \mathbf{v})^* \quad (10)$$

Therefore:

$$\mathbf{p} = \mathbf{v}^{re} \otimes (\mathbf{G} \cdot \mathbf{v}^{re} - \mathbf{B} \cdot \mathbf{v}^{im}) + \mathbf{v}^{im} \otimes (\mathbf{B} \cdot \mathbf{v}^{re} + \mathbf{G} \cdot \mathbf{v}^{im}) \quad (11)$$

$$\mathbf{q} = \mathbf{v}^{im} \otimes (\mathbf{G} \cdot \mathbf{v}^{re} - \mathbf{B} \cdot \mathbf{v}^{im}) - \mathbf{v}^{re} \otimes (\mathbf{B} \cdot \mathbf{v}^{re} + \mathbf{G} \cdot \mathbf{v}^{im}) \quad (12)$$

Now new notions are introduced:

$$\hat{\mathbf{v}} = \begin{bmatrix} \mathbf{v}^{re} \\ \mathbf{v}^{im} \end{bmatrix}, \mathbf{z}^p = \begin{bmatrix} \mathbf{G} & -\mathbf{B} \\ \mathbf{B} & \mathbf{G} \end{bmatrix}, \mathbf{z}^q = \begin{bmatrix} -\mathbf{B} & -\mathbf{G} \\ \mathbf{G} & -\mathbf{B} \end{bmatrix}$$

Then, the total of the injected power can be calculated as:

$$\sum_{k=1}^N p_k = \hat{\mathbf{v}}^T \cdot \mathbf{z}^p \cdot \hat{\mathbf{v}} \quad (13)$$

$$\sum_{k=1}^N q_k = \hat{\mathbf{v}}^T \cdot \mathbf{z}^q \cdot \hat{\mathbf{v}} \quad (14)$$

Equations (7) and (13) can imply that:

$$\hat{\mathbf{v}}^T \cdot \mathbf{z}^p \cdot \hat{\mathbf{v}} = \sum p^G - \sum p^L = \sum P_{loss} \quad (15)$$

Moreover, the active power balance at bus  $k$  can be written as follows:

$$p_k = \hat{\mathbf{v}}_k^T \cdot \mathbf{z}_k^p \cdot \hat{\mathbf{v}}_k \quad (16)$$

where  $\hat{\mathbf{v}}_k$  and  $\mathbf{z}_k^p$  are the vectors having same size with  $\hat{\mathbf{v}}$  and  $\mathbf{z}^p$  respectively and determined by replacing all elements not involved in bus  $k$  by zeros.

$$\mathbf{z}_k^p = \begin{bmatrix} \mathbf{0} \\ \mathbf{z}^p(k, :) \\ \mathbf{0} \\ \mathbf{z}^p(k + N, :) \\ \mathbf{0} \end{bmatrix}$$

$\mathbf{z}^p(k, :)$  and  $\mathbf{z}^p(k + N, :)$  are line  $k$  and line  $k + N$  of matrix  $\mathbf{z}^p$  respectively,  $\mathbf{0}$  is the zero matrix of the correct size. In order to create matrix  $\mathbf{z}_k^p$ , we only need parameters of lines connected to bus  $k$ .

Similarly, the reactive power balance at bus  $k$  can be expressed:

$$q_k = \hat{\mathbf{v}}_k^T \cdot \mathbf{z}_k^q \cdot \hat{\mathbf{v}}_k \quad (17)$$

where matrix  $\mathbf{z}_k^q$  is obtained in a similar fashion of matrix  $\mathbf{z}_k^q$ .

$$\mathbf{z}_k^q = \begin{bmatrix} \mathbf{0} \\ \mathbf{z}^q(k, :) \\ \mathbf{0} \\ \mathbf{z}^q(k + N, :) \\ \mathbf{0} \end{bmatrix} \quad (18)$$

The currents through the line are expressed by the vector  $\mathbf{I}_l = \mathbf{I}_l^{re} + \mathbf{I}_l^{im}$ . We have that  $i_{mn} = y_{mn}(v_m - v_n)$  with  $(m, n) \in \mathbb{C}$ . Then:

$$\begin{aligned} i_{mn}^{re} &= g_{mn}(v_m^{re} - v_n^{re}) + b_{mn}(v_m^{im} - v_n^{im}) \\ i_{mn}^{im} &= b_{mn}(v_m^{re} - v_n^{re}) - g_{mn}(v_m^{im} - v_n^{im}) \end{aligned} \quad (19)$$

So we get:

$$\begin{aligned} \mathbf{I}_l^{re} &= [\mathbf{C} \quad \mathbf{D}] \hat{\mathbf{v}} \\ \mathbf{I}_l^{im} &= [\mathbf{D} \quad -\mathbf{C}] \hat{\mathbf{v}} \end{aligned} \quad (20)$$

where  $\mathbf{C}, \mathbf{D} \in \mathbb{R}^{L \times N}$  and

$$\begin{aligned} c_{mn} &= \begin{cases} -g_{nm} & \text{if } m \text{ adjacent to } n \\ 0 & \text{otherwise} \end{cases} \\ d_{mn} &= \begin{cases} -b_{nm} & \text{if } m \text{ adjacent to } n \\ 0 & \text{otherwise} \end{cases} \end{aligned}$$

The optimal power problem with the objective of minimizing total active power losses can be formulated as:

$$\begin{aligned} &\underset{\hat{\mathbf{v}}}{\text{minimize}} \quad \hat{\mathbf{v}}^T \cdot \mathbf{z}^p \cdot \hat{\mathbf{v}} \\ &\text{subject to} \quad P_k^{min} \leq \hat{\mathbf{v}}_k^T \cdot \mathbf{z}_k^p \cdot \hat{\mathbf{v}}_k + p_k^L \leq P_k^{max}, \quad k \in \mathcal{G} \\ &\quad \text{at } k=1, \dots, N \\ &\quad Q_k^{min} \leq \hat{\mathbf{v}}_k^T \cdot \mathbf{z}_k^q \cdot \hat{\mathbf{v}}_k + q_k^L \leq Q_k^{max}, \quad k \in \mathcal{G} \\ &\quad \hat{\mathbf{v}}_k^T \cdot \mathbf{z}_k^p \cdot \hat{\mathbf{v}}_k + p_k^L = 0, \quad k \notin \mathcal{G} \\ &\quad \hat{\mathbf{v}}_k^T \cdot \mathbf{z}_k^q \cdot \hat{\mathbf{v}}_k + q_k^L = 0, \quad k \notin \mathcal{G} \\ &\quad ([\mathbf{C} \quad \mathbf{D}] \hat{\mathbf{v}})^2 + ([\mathbf{D} \quad -\mathbf{C}] \hat{\mathbf{v}})^2 \leq (\mathbf{I}^{max})^2 \\ &\quad (\mathbf{v}^{min})^2 \leq (\mathbf{v}^{re})^2 + (\mathbf{v}^{im})^2 \leq (\mathbf{v}^{max})^2 \end{aligned} \quad (21)$$

where  $P_{min}^k$ ,  $P_{max}^k$ ,  $Q_{min}^k$  and  $Q_{max}^k$  are the active and reactive power limitation of generator at bus  $k$ ;  $p_k^L$  and  $q_k^L$  are the active and reactive power of load at bus  $k$ ;  $\mathbf{v}^{min}$  and  $\mathbf{v}^{max}$  are the bus voltage limitation.

The variables of the OPF are bus voltages. The power the generators can be implied from the bus voltages.

The convergence of the ADMM algorithm is guaranteed for convex problem [17]. Typically, the distributed OPF process is implemented for transmission networks, and the DC power flow model is generally well suited with the convex problems expressed. However, in a general case as shown in (21), the formulation of the OPF problem is non-convex. In order to deal with the convergence guarantee issue for the ADMM process, in the literature, some works convexified the OPF by a convex approximation of the feasible set [6]. Semidefinite programming (SDP) [24] and second-order cone programming (SOCP) [25] are two main approaches for the convex relaxations. The convexation approaches, however, in some cases can not recover the original problem because of the violation of constraints. Moreover, the workflows are not simple and straightforward when the optimization problem needs to be rewritten in a relaxation form. In [17] (section 9), the authors indicate that the use of ADMM for many non-convex problems can be carried out exactly. Furthermore, many researches demonstrate that distributed optimization techniques can solve practical non-convex OPF problems with the ADMM method in [18, 20, 26, 27]. The use of a general non-linear solver can provides a good solution and the convergence can be achieved to optimal values. The solver in this approach can offers 0% constraint violation every time. In the light of practical implementation, in this paper, the OPF problem is solved directly in the original non-convex formulation and the convergence is shown in the experimental results.

*Remark 1.* Problem (21) is formulated in a quadratic form and its Jacobian matrices can be easily calculated as:

$$(\hat{\mathbf{v}}^T \cdot \mathbf{z}^p \cdot \hat{\mathbf{v}})' = \frac{1}{2}(\mathbf{z}^{pT} + \mathbf{z}^p)\hat{\mathbf{v}}$$

This point is crucial in programming to deploy realistic applications due to less effort in computation and enhanced accuracy.

*Remark 2.* In problem (21), all constraints are constructed by local parameters and local variables. Therefore, we only need to rewrite the objective function in order to fully decompose the problem and it will be solved in the following section.

### 3.2. Optimal Power Flow Problem in General Consensus Formulation

The OPF problem in (21) is rewritten in general structures of consensus problems by separating into  $N$  subsystems corresponding to  $N$  buses of the network.

The total active power losses in the network can be expressed by decomposing the function into  $N$  parts as follows:

$$\hat{\mathbf{v}}^T \cdot \mathbf{z}^p \cdot \hat{\mathbf{v}} = \sum_{k=1}^N \hat{\mathbf{v}}_k^T \cdot \mathbf{z}_k^p \cdot \hat{\mathbf{v}}_k \quad (22)$$

From (21) and (22), the subproblems can be expressed as follows.

- Subproblem at bus  $k$  if  $k \notin \mathcal{G}$ :

$$\begin{aligned} & \underset{\hat{\mathbf{v}}_k}{\text{minimize}} && \hat{\mathbf{v}}_k^T \cdot \mathbf{z}_k^p \cdot \hat{\mathbf{v}}_k \\ & \text{subject to} && \hat{\mathbf{v}}_k^T \cdot \mathbf{z}_k^p \cdot \hat{\mathbf{v}}_k + p_k^L = 0 \\ & && \hat{\mathbf{v}}_k^T \cdot \mathbf{z}_k^q \cdot \hat{\mathbf{v}}_k + q_k^L = 0 \\ & && ([\mathbf{C}_k \quad \mathbf{D}_k] \hat{\mathbf{v}}_k)^2 + ([\mathbf{D}_k \quad -\mathbf{C}_k] \hat{\mathbf{v}}_k)^2 \leq (\mathbf{I}_k^{max})^2 \\ & && (\mathbf{v}_k^{min})^2 \leq (\mathbf{v}_k^{re})^2 + (\mathbf{v}_k^{im})^2 \leq (\mathbf{v}_k^{max})^2 \end{aligned} \quad (23)$$

- Subproblem at bus  $k$  if  $k \in \mathcal{G}$ :

$$\begin{aligned} & \underset{\hat{\mathbf{v}}_k}{\text{minimize}} && \hat{\mathbf{v}}_k^T \cdot \mathbf{z}^p \cdot \hat{\mathbf{v}}_k \\ & \text{subject to} && P_k^{min} \leq \hat{\mathbf{v}}_k^T \cdot \mathbf{z}_k^p \cdot \hat{\mathbf{v}}_k + p_k^L \leq P_k^{max} \\ & && Q_k^{min} \leq \hat{\mathbf{v}}_k^T \cdot \mathbf{z}_k^q \cdot \hat{\mathbf{v}}_k + q_k^L \leq Q_k^{max} \\ & && ([\mathbf{C}_k \quad \mathbf{D}_k] \hat{\mathbf{v}}_k)^2 + ([\mathbf{D}_k \quad -\mathbf{C}_k] \hat{\mathbf{v}}_k)^2 \leq (\mathbf{I}_k^{max})^2 \\ & && (\mathbf{v}_k^{min})^2 \leq (\mathbf{v}_k^{re})^2 + (\mathbf{v}_k^{im})^2 \leq (\mathbf{v}_k^{max})^2 \\ & && \text{if voltage at } k \text{ is kept at a reference value } v_k^{ref} \\ & && (v_k^{re})^2 + (v_k^{im})^2 = (v_k^{ref})^2 \end{aligned} \quad (24)$$

where  $\hat{\mathbf{v}}_k \in \mathbb{R}^{2N_k}$  is the local variable,  $\mathbf{C}_k$  and  $\mathbf{D}_k$  are determined by eliminating rows having elements not involved in bus  $k$ .

The OPF problem is therefore formulated in the general consensus problem as presented in (4). The coupling constraint is:

$$\hat{\mathbf{v}}_k - \tilde{\mathbf{v}}_k = 0 \quad (25)$$

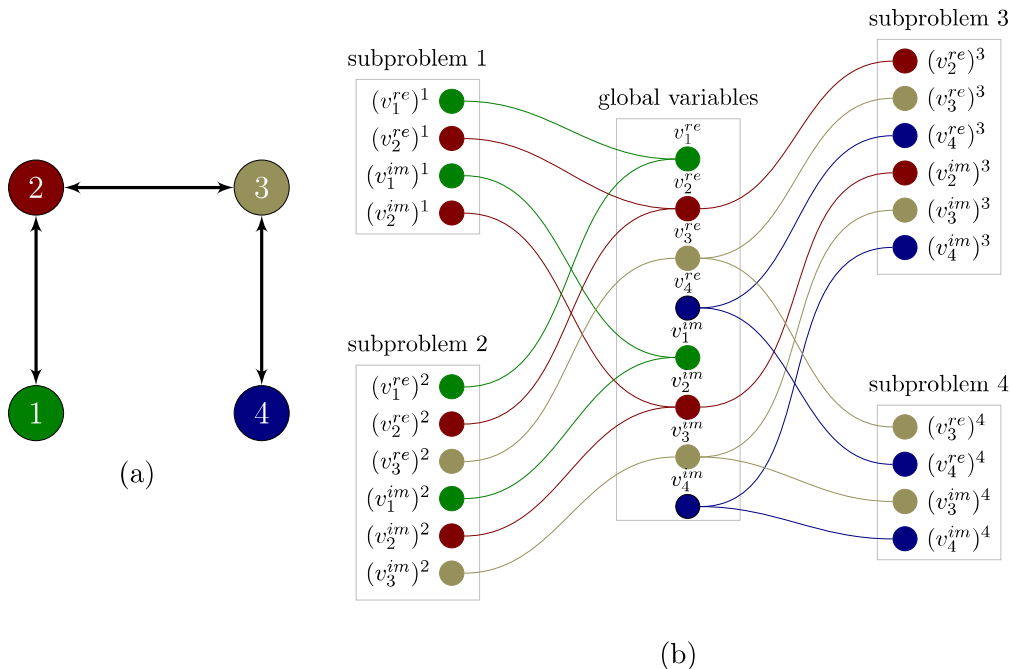

Figure 2: The relation of global and local variables in an example network.

where  $\tilde{\mathbf{v}}_k \in \mathbb{R}^{2N_k}$  is the global variable representing the collection of the related components of  $\hat{\mathbf{v}} \in \mathbb{R}^{2N}$  that map into subsystem  $k$ .

In order to illustrate clearly the relationship between global variables and local variables, we consider the example network shown in Figure 2a. Figure 2b presents how to form the vectors of local and global variables. For instance, since bus 1 connects to the neighbor 2, subproblem at bus 1 has the vector of local variables  $[(v_1^{re})^1, (v_2^{re})^1, (v_1^{im})^1, (v_2^{im})^1]^T$  created from the rectangular form of  $v_1$  and  $v_2$ . The corresponding global variables of subproblem at bus 1 are  $[v_1^{re}, v_2^{re}, v_1^{im}, v_2^{im}]^T$  which are copied from a part of variables of the whole system network. A variable therefore only appears in a set of subproblems sharing a same net.

### 3.3. Distributed Optimal Power Flow using ADMM

The OPF problem is decomposed into subsystems and formulated as a general consensus form. Each subsystem is handled by an agent located at a bus. The agent deals with the subproblem with restrictive information about the whole network. Specifically, the agent has knowledge of the local bus and

---

**Algorithm 2:** ADMM for distributed OPF implementation at agent  $k$ .

---

```

1  $I = 0$ :  $\tilde{\mathbf{v}}_k \leftarrow \tilde{\mathbf{v}}_0, \boldsymbol{\lambda}_k \leftarrow \boldsymbol{\lambda}_0$  // at initial iteration, give initial
   guest values of global variables and Lagrangian multipliers
2 while  $I < I_0$  do
3   At each iteration, the agent solves the local problem to find the
   local voltage variable  $\mathbf{v}_k(I + 1)$ .
   • if bus  $k$  is connected to load:
       minimize  $\hat{\mathbf{v}}_k^T \cdot \mathbf{z}^p \cdot \hat{\mathbf{v}}_k + \boldsymbol{\lambda}_k^T(I) \hat{\mathbf{v}}_k + (\rho/2) \|\hat{\mathbf{v}}_k - \tilde{\mathbf{v}}_k(I)\|_2^2$ 
       subject to (23)
   • if bus  $k$  is connected to generator:
       minimize  $\hat{\mathbf{v}}_k^T \cdot \mathbf{z}^p \cdot \hat{\mathbf{v}}_k + \boldsymbol{\lambda}_k^T(I) \hat{\mathbf{v}}_k + (\rho/2) \|\hat{\mathbf{v}}_k - \tilde{\mathbf{v}}_k(I)\|_2^2$ 
       subject to (24)
4    $\mathbf{B}_k(I + 1) = \hat{\mathbf{v}}_k(I + 1) + \frac{1}{\rho} \boldsymbol{\lambda}_k(I)$ 
5   Distribute  $\mathbf{B}$  to all neighbors
6   Collect  $\mathbf{B}$  from all neighbors
7   Update global variable  $\tilde{\mathbf{v}}_k(I + 1)$  // agent exchanges  $\mathbf{B}_k$  with
   neighbors then averages all component  $\mathbf{B}$  collected.
8   Update Lagrangian multiplier:
    $\boldsymbol{\lambda}_k(I + 1) = \boldsymbol{\lambda}_k(I) + \rho(\hat{\mathbf{v}}_k(I + 1) - \tilde{\mathbf{v}}_k(I + 1))$ 
9   Go to next iteration  $I \leftarrow I + 1$ 

```

---

its connected electrical neighbors through the communication network. The graph of the agent system is therefore equivalent to electrical connections, i.e., if  $(i, j) \in \mathcal{L}$  then agent  $i$  can exchange messages with agent  $j$ . Each agent solves its own problem to obtain local objective, and concurrently ensure the coupling constraints with its neighbors due to the same voltage variables they share. Algorithm 2 presents how agents implement the ADMM method in an iterative way to solve the distributed consensus problem. In each iteration, the processes of updating local variables and Lagrangian multiplier are carried out in a decentralized scheme by using only local knowledge.

Messages are exchanged between agents only at Step 5 and Step 6, where the global variables are updated. The number of iterations  $I_0$  is determined by analyzing the system with different values of the parameter  $\rho$ . There is a trade-off between consistency and objective value. Thus, for a specific case, we need to do some tests to analyze the performance of convergence and obtain a reasonable value of  $\rho$ .

#### 4. MAS for Realizing Operation of Distributed OPF in Cyber-physical System

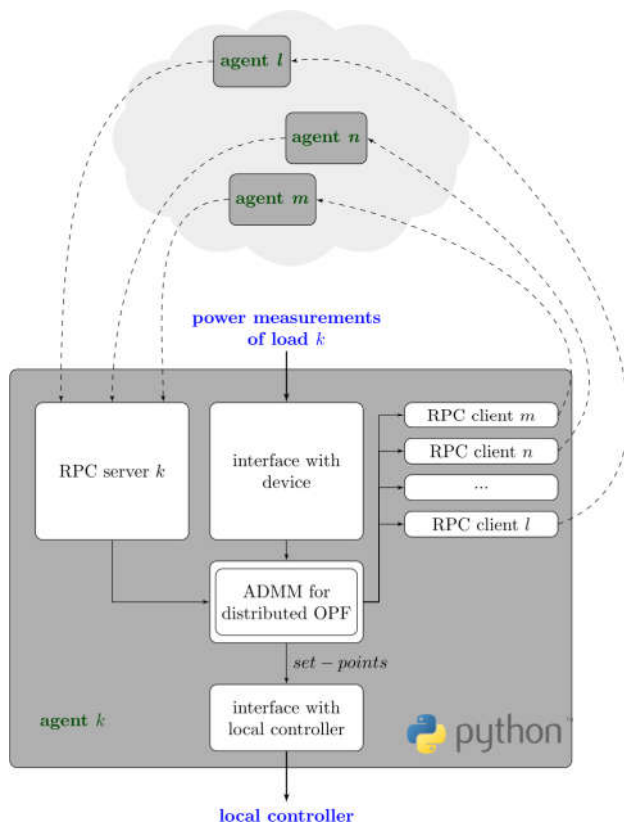

Figure 3: The structure of an agent implementing ADMM method for distributed OPF problem.

The MAS is deployed to solve the OPF problem in a distributed manner. In order to approach practical implementation of MAS, the agent is developed as a Python program with the structure illustrated in Figure 3. An agent has



following fundamental functions: (i) interface with physical system to collect local measurements and with local controller to send power set-points for the corresponding generator, (ii) RPC server/client for exchanging messages with neighbor agents, and (iii) computation of ADMM algorithm. Each agent is a server that can receive incoming messages and dispatch them after a call and, at the same time, is a client of the server in neighbor agents.

Figure 4 presents the iterative process of an agent in the time-domain. A loop is defined as the duration from the moment that the agent receives measurements at iteration  $l$  to the moment that the ADMM process reach consensus and the agent sends the control signals at iteration  $l_0$ . Intuitively, in a loop, each agent updates the state of the power network, processes the calculation and then returns the decision of the optimal state. Agents execute the loops consecutively to always seek the optimal set-points for generator outputs. Agents run in parallel, but they are synchronized to ensure always exchanging data in the same iteration step.

## 5. Cyber Hardware-in-the-Loop Experiment

The test case grid based on the IEEE 9 bus system [28] is used to validate the proposed distributed OPF in Section 3.3 and the agent presented in Section 4. The grid diagram is presented in Figure 5 which includes two generators at bus {2, 3} supplying power to three loads at bus {5, 7, 9} while bus 1 connects to the bulk system as the slack bus. The outputs of the generators will be adjusted by the designed agents to minimize the total active power losses. The aim of the experiment is to show the secure operation of the dynamic system under the control of MAS in the distributed manner. The agents have ability of adapting to the disturbances when the loads change in the time domain. Figure 6 shows the load profile during 1440s with a decreasing step change and an increasing step change at 480s and 960s respectively.

The laboratory test-bed is set up as shown in Figure 7 for Cyber Hardware-in-the-Loop experiment. The dynamic model of the test case grid is simulated in Matlab<sup>®</sup>/Simulink and run in real-time in a OPAL-RT simulator. The cyber system consists of hardware agents and a real communication network. The system at bus 1 is represented by a voltage source in the simulation, while the generators at bus 2 and bus 2 are current sources. A cluster of 9 Raspberry PI (RPI 3, model 3, 1GB RAM, 1.2 GHz processor) connects each other via a network switch that represents the MAS. Each RPI is used to

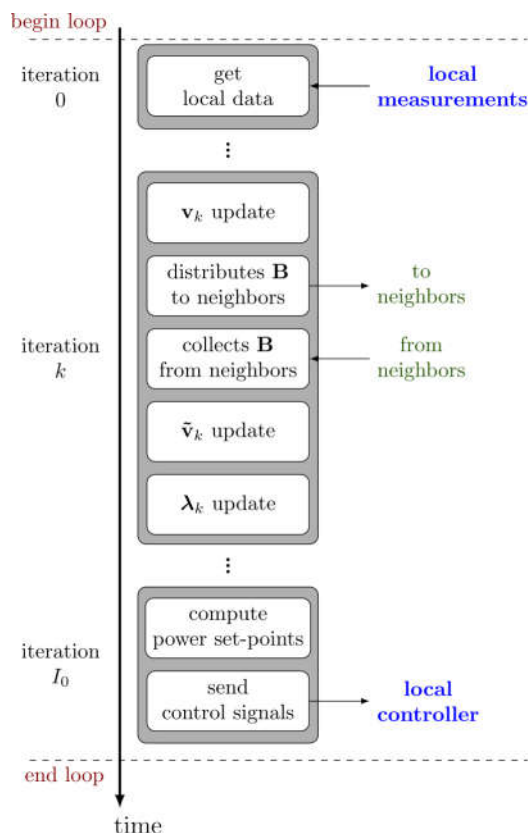

Figure 4: The ADMM iterative process in an agent

run an agent which is a Python program. The data exchange between agents is in server/client manner and uses the gRPC protocol. The communication topology is configured to coincide the electrical connection. The data from the grid simulation in OPAL-RT is exchanged with the cyber system through the external switch using user data protocol (UDP). Each agent can transfer data with the corresponding bus to get the load power or send the generator set-points. The communication time between agents is depicted in Figure 8. The latency time is varied in a range with the median is lower than 0.05s. Regarding the ADMM process in agents, the execution for solving the local problem consumes the most time. The boxplots in Figure 9 show the difference in calculating in different agents.

Based on the measurements collected from the grid, the agent system implement ADMM algorithm to optimize the operation of the system with

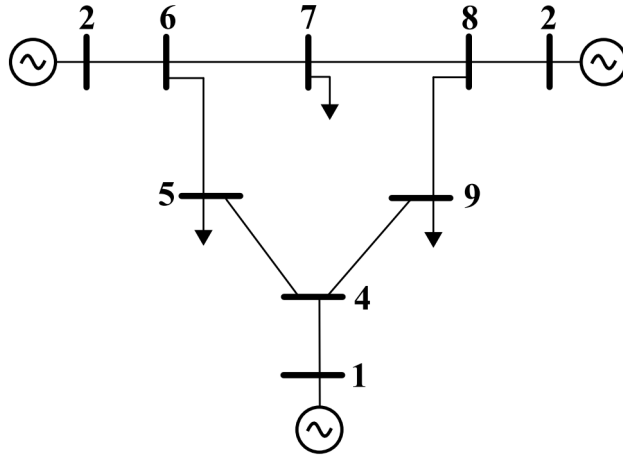

Figure 5: The 9 bus test case .

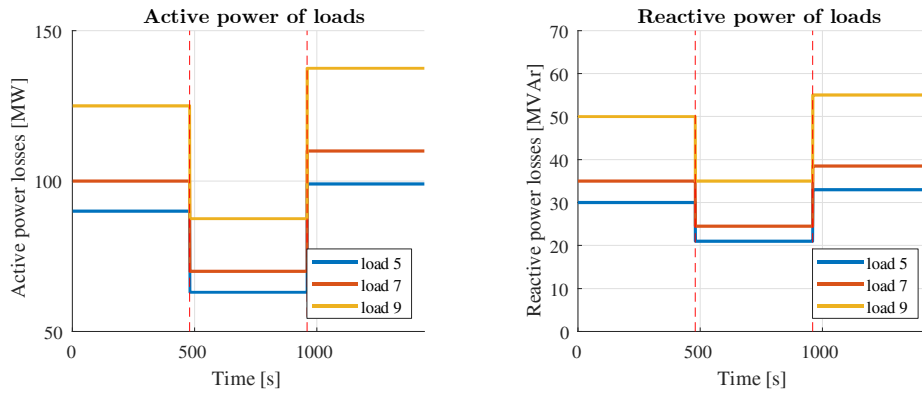

Figure 6: The active and reactive power of loads in time domain.

respect to the alteration of loads. Intuitively, what happens in agents could be separated into three phases as follows:

- *Phase 1*: agent receives initial states which are local measurement of load active and reactive power from OPAL-RT through the interface.
- *Phase 2*: from local information from OPAL-RT and exchanged information from neighborhood RPIs, agent iteratively run the ADMM process. We choose  $\rho = 25$  for good convergent performance and the number of iteration in an ADMM process loop is 1000 to guarantee the consensus.

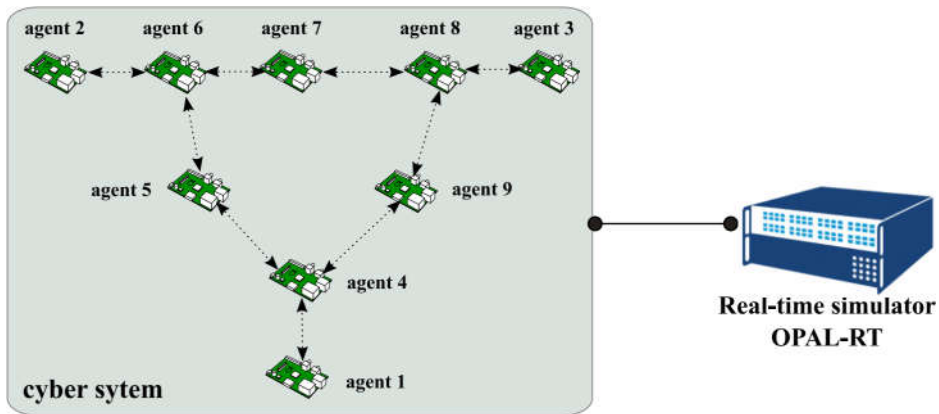

Figure 7: The laboratory set up for Cyber Hardware-in-the-Loop experiment.

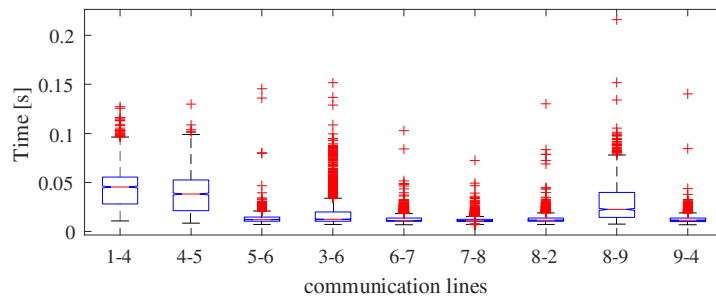

Figure 8: Communication time between agents.

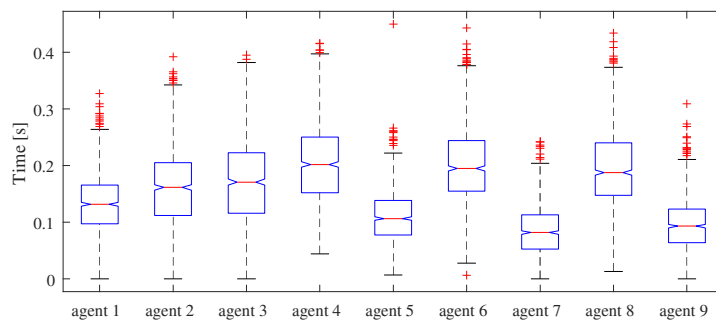

Figure 9: The time for solving local problem in each agent.

- *Phase 3*: at iteration 1000<sup>th</sup>, all agents complete an ADMM process loop. Agent 2 and agent 3 send the optimal set points of active and reactive powers to set new operational outputs of corresponding DGs. Then ADMM processes in the agents are restarted again from *Phase 1*.

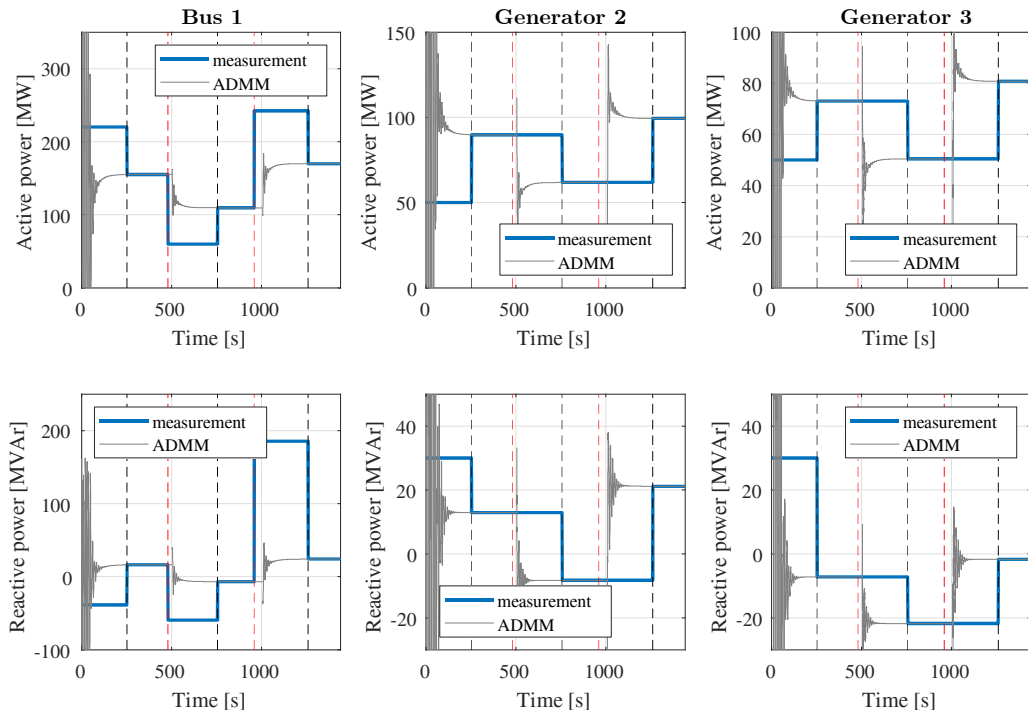

Figure 10: Active and reactive power at the slack bus 1 and generator buses 2, 3.

The results of the system are presented in Figure 10. At initial, the active and reactive power of the generators are set to 50 MW and 30 MVar respectively. The important milestones are marked by vertical lines as follows:

- the dashed red lines represent the instants when the loads change at 480s and 960s,
- the dashed black lines represents the instants when the generators receive the optimal set points from the corresponding agents at 251s, 756s and 1261s.

The data in the figure is collected from two sources: one is the measurements of active and reactive power from OPAL-RT (as the solid blue lines), and one is the computation in each iteration from the logging files of the agents (as the solid grey lines). Although operating independently and asynchronously and having different solving time and communication time (as depicted in Figure 8 and Figure 9), the agents reach the ADMM convergence at the same time to send the signals to the physical system simultaneously.

When the agents perform the ADMM process, any change of the system is perceived and considered for controlling the system to the optimal operation state. Figure 11 shows the total active power losses of the grid. The losses are always declined when the generators receive new set-point values from the MAS which achieving the objective of the global problem. It is noted that the power values measured from slack bus 1 coincide with the results calculated in agent 1 as demonstrated in Figure 10. The unification between the measurements from OPAL-RT simulation and the results from agent calculation affirms the accuracy of the method and the implementation process.

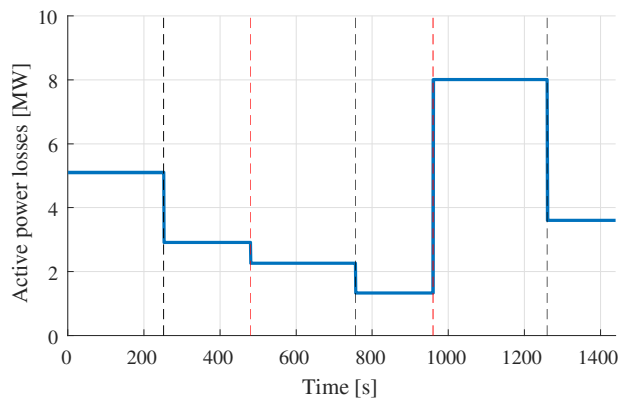

Figure 11: The total active power losses.

Figure 12 shows the computation of active and reactive power in the agents with respect to iterations equivalent to one ADMM loop. This loop corresponds to the duration from 0s to 251s in Figure 10. It can be seen that the convergent values computed in the agents are as the same as the values solved in centralized method with the formulation presented in Section 3.1.

## 6. Conclusions

The paper presents a practical approach to optimize the operation of the power system in the distributed strategy. The OPF problem formulation is developed to be separated into bus-based subsystems. The agent located at a bus in the network is designed to manage the subsystem. The agent is constructed with multiple functions for interfacing with physical devices, communicating with other agents and implementing ADMM to solve the

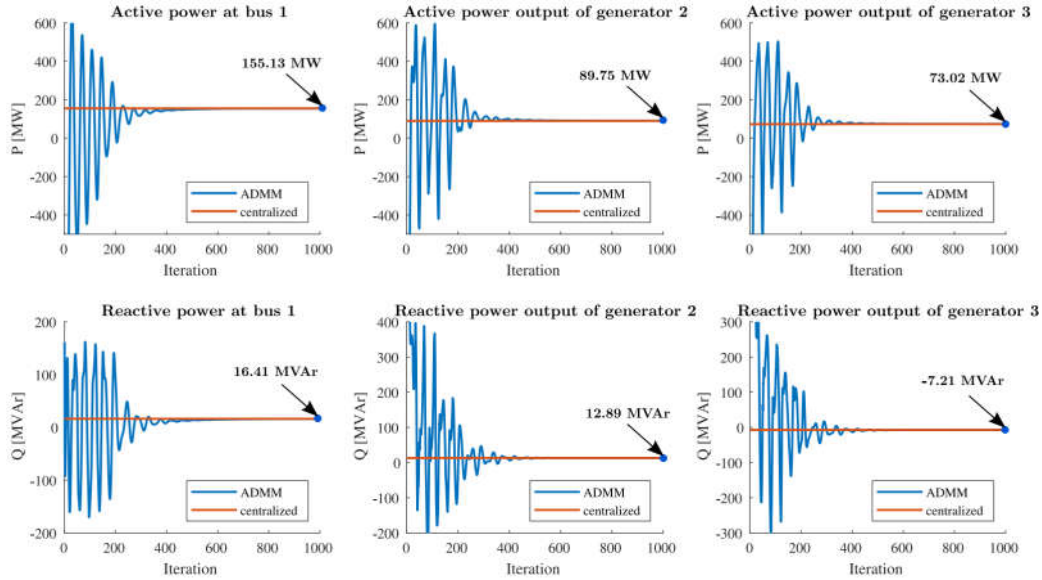

Figure 12: The ADMM calculation of active and reactive power in the agents.

OPF problem and adjust optimally generator outputs. The agents provide stable behaviours and react appropriately to the system demand changes. Although processing the local problems in different execution times and exchanging information in different latencies, the agent system still can reach the consensus and achieve the global results concurrently as the centralized approach. A HIL experiment platform is also provided to validate the operation the hardware agents on the 9 bus test case. The dynamic performance of the system shows the ability of the designed agent in a practical environment. **In the future works, we will investigate the applications of ADMM based OPF on network microgrids and AC/DC hybrid systems. Large scale system will also be considered demonstrate the scalability and effectiveness of the proposed method.**

## Acknowledgements

This research is funded by Funds for Science and Technology Development of the University of Danang under project number B2019-DN02-50.

## References

- [1] S. Frank, I. Steponavice, S. Rebennack, Optimal power flow: A bibliographic survey I Formulations and deterministic methods, *Energy Systems* (2012). doi:10.1007/s12667-012-0056-y.
- [2] A. Wood, B. Wollenberg, G. Sheble, *Power Generation, Operation and Control*, John Wiley & Sons, Inc., Hoboken, New Jersey, 2014. doi:10.1017/CBO9781107415324.004.
- [3] M. W. Khan, J. Wang, The research on multi-agent system for microgrid control and optimization, *Renewable and Sustainable Energy Reviews* 80 (2017) 1399–1411. doi:10.1016/j.rser.2017.05.279.
- [4] Y. Wang, T. L. Nguyen, Y. Xu, D. Shi, Distributed control of heterogeneous energy storage systems in islanded microgrids: Finite-time approach and cyber-physical implementation, *International Journal of Electrical Power & Energy Systems* 119 (2020) 105898. doi:https://doi.org/10.1016/j.ijepes.2020.105898.
- [5] Y. Wang, T. L. Nguyen, Y. Xu, Z. Li, Q. Tran, R. Caire, Cyber-physical design and implementation of distributed event-triggered secondary control in islanded microgrids, *IEEE Transactions on Industry Applications* 55 (6) (2019) 5631–5642.
- [6] D. K. Molzahn, F. Dörfler, H. Sandberg, S. H. Low, S. Chakrabarti, R. Baldick, J. Lavaei, A Survey of Distributed Optimization and Control Algorithms for Electric Power Systems, *IEEE Transactions on Smart Grid* (2017). doi:10.1109/TSG.2017.2720471.
- [7] T. Faulwasser, A. Engelmann, T. Mühlpfordt, V. Hagenmeyer, Optimal power flow: An introduction to predictive, distributed and stochastic control challenges, *At-Automatisierungstechnik* (2018). arXiv:1811.01163, doi:10.1515/auto-2018-0040.
- [8] F. Capitanescu, Critical review of recent advances and further developments needed in AC optimal power flow, *Electric Power Systems Research* 136 (2016) 57–68. doi:10.1016/j.epsr.2016.02.008.
- [9] Y. Wang, S. Wang, L. Wu, Distributed optimization approaches for emerging power systems operation: A review, *Electric Power Systems Research* 144 (2017) 127–135. doi:10.1016/j.epsr.2016.11.025.



- [10] N. Gatsis, G. B. Giannakis, Decomposition algorithms for market clearing with large-scale demand response, *IEEE Transactions on Smart Grid* (2013). doi:10.1109/TSG.2013.2258179.
- [11] Z. Wang, B. Chen, J. Wang, J. Kim, Decentralized Energy Management System for Networked Microgrids in Grid-Connected and Islanded Modes, *IEEE Transactions on Smart Grid* (2016). doi:10.1109/TSG.2015.2427371.
- [12] A. Engelmann, Y. Jiang, T. Muhlfordt, B. Houska, T. Faulwasser, Towards Distributed OPF using ALADIN, *IEEE Transactions on Power Systems* (2018). doi:10.1109/TPWRS.2018.2867682.
- [13] G. Hug-Glanzmann, G. Andersson, Decentralized optimal power flow control for overlapping areas in power systems, *IEEE Transactions on Power Systems* (2009). doi:10.1109/TPWRS.2008.2006998.
- [14] F. J. Nogales, F. J. Prieto, A. J. Conejo, A Decomposition Methodology Applied to the Multi-Area Optimal Power Flow Problem, *Annals of Operations Research* (2003). doi:10.1023/A:1023374312364.
- [15] S. Kar, G. Hug, J. Mohammadi, J. M. Moura, Distributed state estimation and energy management in smart grids: A Consensus+ Innovations Approach, *IEEE Journal on Selected Topics in Signal Processing* (2014). doi:10.1109/JSTSP.2014.2364545.
- [16] J. Mohammadi, S. Kar, G. Hug, Distributed Approach for DC Optimal Power Flow Calculations (2014) 1–11.
- [17] J. E. S. Boyd, N. Parikh, E. Chu, B. Peleato, Distributed Optimization and Statistical Learning via the Alternating Direction Method of Multipliers, *Foundations and Trends in Machine Learning* (2011). doi:10.1561/22000000016.
- [18] T. Erseghe, Distributed optimal power flow using ADMM, *IEEE Transactions on Power Systems* (2014). doi:10.1109/TPWRS.2014.2306495.
- [19] S. Mhanna, G. Verbic, A. C. Chapman, Adaptive admm for distributed ac optimal power flow, *IEEE Transactions on Power Systems* (2019). doi:10.1109/TPWRS.2018.2886344.

- [20] S. Magnusson, P. C. Weeraddana, C. Fischione, A Distributed Approach for the Optimal Power-Flow Problem Based on ADMM and Sequential Convex Approximations, *IEEE Transactions on Control of Network Systems* (2015). arXiv:1401.4621, doi:10.1109/TCNS.2015.2399192.
- [21] Y. Zhang, M. Hong, E. Dall’Anese, S. V. Dhople, Z. Xu, Distributed controllers seeking AC optimal power flow solutions using ADMM, *IEEE Transactions on Smart Grid* (2018). doi:10.1109/TSG.2017.2662639.
- [22] N. Meyer-Huebner, M. Suriyah, T. Leibfried, Distributed optimal power flow in hybrid acdc grids, *IEEE Transactions on Power Systems* 34 (4) (2019) 2937–2946.
- [23] G. Sun, G. Li, S. Xia, M. Shahidehpour, X. Lu, K. W. Chan, Aladin-based coordinated operation of power distribution and traffic networks with electric vehicles, *IEEE Transactions on Industry Applications* (2020) 1–1.
- [24] E. Dall’Anese, S. V. Dhople, B. B. Johnson, G. B. Giannakis, Decentralized optimal dispatch of photovoltaic inverters in residential distribution systems, *IEEE Transactions on Energy Conversion* (2014). arXiv:1403.1341, doi:10.1109/TEC.2014.2357997.
- [25] Q. Peng, S. H. Low, Distributed optimal power flow algorithm for radial networks, I: Balanced single phase case, *IEEE Transactions on Smart Grid* (2018). arXiv:1404.0700, doi:10.1109/TSG.2016.2546305.
- [26] A. X. Sun, D. T. Phan, S. Ghosh, Fully decentralized AC optimal power flow algorithms, in: *IEEE Power and Energy Society General Meeting*, 2013. doi:10.1109/PESMG.2013.6672864.
- [27] S. Mhanna, A. C. Chapman, G. Verbič, Component-based dual decomposition methods for the OPF problem, *Sustainable Energy, Grids and Networks* (2018). doi:10.1016/j.segan.2018.04.003.
- [28] P. M. Anderson, A. A. Fouad, *Power System Control and Stability*, Wiley-IEEE Press, 2003.