



HAL
open science

Brain Adaptation to Acute Stress: Effect of Time, Social Buffering, and Nicotinic Cholinergic System

Anne Nosjean, Sylvie Granon

► **To cite this version:**

Anne Nosjean, Sylvie Granon. Brain Adaptation to Acute Stress: Effect of Time, Social Buffering, and Nicotinic Cholinergic System. *Cerebral Cortex*, 2022, 32 (18), pp.3990-4011. 10.1093/cercor/bhab461 . hal-03643502

HAL Id: hal-03643502

<https://hal.science/hal-03643502>

Submitted on 9 Nov 2022

HAL is a multi-disciplinary open access archive for the deposit and dissemination of scientific research documents, whether they are published or not. The documents may come from teaching and research institutions in France or abroad, or from public or private research centers.

L'archive ouverte pluridisciplinaire **HAL**, est destinée au dépôt et à la diffusion de documents scientifiques de niveau recherche, publiés ou non, émanant des établissements d'enseignement et de recherche français ou étrangers, des laboratoires publics ou privés.



Distributed under a Creative Commons Attribution 4.0 International License

Brain adaptation to acute stress : effect of time, social buffering and nicotinic cholinergic system

Journal:	<i>Cerebral Cortex</i>
Manuscript ID	Draft
Manuscript Type:	Original Article
Date Submitted by the Author:	n/a
Complete List of Authors:	Nosjean, Anne; Institut des Neurosciences Paris-Saclay, Cognitive & Network Neuroscience (CNN)
Keywords:	

1
2
3
4
5
6
7
8
9
10
11
12
13
14
15
16
17
18
19
20
21
22
23
24
25
26
27
28
29
30
31
32
33
34
35
36
37
38
39
40
41
42
43
44
45
46
47
48
49
50
51
52
53
54
55
56
57
58
59
60

Brain adaptation to acute stress : effect of time, social buffering and nicotinic cholinergic system

Anne Nosjean^{a*} and Sylvie Granon^a

^aUniversité Paris-Saclay, CNRS, Institut des Neurosciences Paris-Saclay (NeuroPSI),
UMR9197, Campus CEA Saclay, 151 route de la Rotonde, Bâtiment 151, 91400 Saclay, France
01 69 82 63 84

*Corresponding author: anne.nosjean@universite-paris-saclay.fr

Running title: prefrontal cortex plasticity after stress and social interaction

Abstract

Social behavior and stress responses both rely on activity of the prefrontal cortex (PFC) and the basolateral nucleus of the amygdala (BLA), and on cholinergic transmission. We previously showed in adult C57BL/6J (B6) that social interaction has a buffering effect on stress-related prefrontal activity, depending on the $\beta 2^{-/-}$ cholinergic nicotinic receptors (nAChRs, $\beta 2^{-/-}$ mice). The latency for this buffer to emerge being short, we question here whether the associated brain plasticity, reflected by regional c-fos protein quantification and PFC-BLA functional connectivity, is modulated by time. Overall, we show that time normalized the stress-induced PFC hyper-activation in B6 mice and PFC hypo-activation in $\beta 2^{-/-}$ mice, with no effect on BLA. It also triggered a multitude of functional links between PFC subareas, and between PFC and BLA in B6 mice but not $\beta 2^{-/-}$ mice, showing a central role of nAChRs in this plasticity. Coupled to social interaction and time stress led to novel and drastic diminution of functional connectivity within the PFC in both genotypes. Thus, time, emotional state, and social behavior induced dissociated effects on PFC and BLA activity, and important cortico-cortical reorganizations. Both activity and plasticity were under the control of the $\beta 2$ -nAChRs.

Keywords: Acute stress, amygdala, c-fos protein, prefrontal cortex, time

1
2
3 Social interactions involve high adaptive flexible behaviors that require the integration of
4 internal and external cues to make coherent decisions in specific environmental contexts. Social
5 interactions, altered in numerous psychiatric disorders, imply emotional and motivational
6 processes and widely engage the prefrontal cortex (PFC) and the amygdala, in particular the
7 basolateral nucleus of the amygdala (BLA) (see Showers and Cantor 1985; Adolphs 2001,
8 2009; Dalgleish 2004; Insel and Fernald 2004; Bachevalier et Loveland 2006; Lupien et al.
9 2009; Pessoa 2010; Stanley and Adolphs 2013; Adolphs and Anderson 2013; Bickart et al.
10 2014; Bicks et al. 2015; Janak and Tye 2015; Demolliens et al. 2017; for reviews). Besides the
11 classical involvement of the autonomic nervous system, the hypothalamic-pituitary-adrenal
12 axis and the hippocampus in stress responses, the PFC and the amygdala are also stress-related
13 brain areas (Buijs et Van Eden 2000; McEwen 2007; Cerqueira et al. 2008; Holmes et Wellman
14 2009; Lupien et al. 2009; Mora et al. 2012; McEwen et al. 2016; Negrón-Oyarzo et al. 2016;
15 Atrooz et al. 2019; for reviews). Among brain neuromodulators, acetylcholine plays a major
16 role in social interactions. Brain cholinergic transmission mediated by nAChRs is also mainly
17 involved in healthy and pathological cognition (Graef et al. 2011; Picciotto et al. 2012; Hurst
18 et al. 2013; Levin 2013; Mineur et al. 2016; Prado et al. 2017; Muramatsu et al. 2018; Záborszky
19 et al. 2018) and in stress regulation (Mark et al. 1996; Mora et al. 2012; Paul et al. 2015;
20 Picciotto et al. 2015). Notably, the β_2 , β_4 , and α_7 subunits of the neuronal nicotinic cholinergic
21 receptors (nAChRs) are broadly involved in social behavior (Avale et al. 2011, Salas et al. 2013;
22 Potasiewicz et al. 2017, Nosjean et al. 2018).

23
24
25
26
27
28
29
30
31
32
33
34
35
36
37
38
39
40
41
42
43
44
45
46
47
48
49
50 We previously performed exhaustive analyses of social behavior and brain activity in
51 C57BL/6J mice (B6 mice) and in mice lacking the β_2 subunit of nicotinic receptors ($\beta_2^{-/-}$ mice)
52 using a social task that includes an exploratory phase followed by a social interaction phase to
53 promote both novelty exploration and social investigations (Granon et al. 2003; Avale et al.
54 2011; De Chaumont et al. 2012; Nosjean et al. 2015, 2018). We showed that acute stress
55
56
57
58
59
60

1
2
3 deteriorated social flexibility (Nosjean et al. 2015) and that social interaction modulated by the
4 presence of β 2-nAChRs, played a buffering role on stress-induced brain activation (Nosjean et
5 al. 2018).
6
7
8
9

10
11 In the latter study, we quantified the regional expression of the protein c-fos to reflect
12 brain activation. C-fos protein expression not only depends on the intensity and the duration of
13 the stimulus, but also on the time-course of the protein translation (Honkaniemi et al. 1992;
14 Chowdury et al. 2000; Viau and Sawchenko 2002; Muigg et al. 2009; see also Senba and
15 Ueyama 1997; Kovács 1998, 2008; as reviews). In our previous experiments, the protein
16 expression was measured 90 min after the beginning of stress exposure, i.e., immediately at the
17 end of the social interaction, a delay which falls within the period of peak production of the
18 protein (see Morgan and Curran 1989, Hoffman et al. 1993; Hughes and Dragunow 1995;
19 Kovacs 1998, 2008; Bisler et al. 2002; Guzowski et al. 2005). It was therefore surprising that
20 only an 8-minute social interaction induced significant and specific brain activation, as a very
21 limited time was left for c-fos protein expression. Thus, in the present study, we question
22 whether PFC and amygdala activity evolve with time by adding a 90 min delay after the social
23 task to allow maximal expression of the protein. To this end, B6 and β 2^{-/-} mice were sacrificed
24 90 min after either stress alone or after stress followed by the social task. Non-stressed mice
25 were also sacrificed 90 min after the social task.
26
27
28
29
30
31
32
33
34
35
36
37
38
39
40
41
42
43
44
45
46
47
48

49 **Materials and Methods**

50
51 Part of the data used here (all data referring to “short delay”) were previously published
52 (Nosjean et al. 2018) as they assess the immediate effect of stress combined or not with a social
53 task on brain activity. As the purpose of the current paper was to compare the effect of a long
54 delay after stress with or without social interactions, to that of a short delay, we included this
55
56
57
58
59
60

1
2
3 set of data in our statistical comparisons, in addition to corresponding control data (Fig. 1). This
4
5 was made possible by the fact that our experiments were conducted in the very same
6
7 environment and in order to reduce the total number of animals.
8
9

10 11 12 **Animals**

13
14
15 Experiments were conducted with male B6 mice (n = 124) and mice lacking the $\beta 2$ subunit of
16
17 the nAChRs ($\beta 2^{-/-}$, n = 50). At their arrival to animal facilities, 10-11 weeks old mice were
18
19 group-housed (four mice/cage; food and water ad libitum, room temperature 20-22°C) under a
20
21 12/12h light/dark cycle (light on at 7.30 am). Animals were purchased from Charles Rivers
22
23 Laboratories (L'Arbresle Cedex, France). $\beta 2^{-/-}$ mice were generated from a 129/Sv embryonic
24
25 stem cell line as previously described (Picciotto et al. 1995) and backcrossed onto the B6 strain
26
27 for 20 generations. All experiments were carried out to reduce the discomfort of mice in
28
29 accordance with the EU Directive 2010/63/EU, Decree N 2013-118 of February 1st, 2013, and
30
31 the French National Committee (87/848).
32
33
34
35
36
37

38 **Experimental procedures (Figure 1)**

39
40
41 All experiments were performed from 9.00 a.m. to 2.00 p.m. with 14-25 weeks old mice and
42
43 conducted for both B6 and $\beta 2^{-/-}$ mice.
44
45

46
47 After acclimatization to the experimental room, animals were either immediately
48
49 sacrificed (Control mice, Cnt, n = 9 B6, n = 6 $\beta 2^{-/-}$ mice), submitted to an acute stress (S mice),
50
51 or submitted to acute stress or not and a social task (SESI-mice and ESI-mice). Stress was
52
53 realized by placing the mouse for 45 minutes in a Falcon® tube opened at the end to permit
54
55 breathing. Social task was realized by placing an Isolated Host mouse (IH, either stressed or
56
57 not) and a Social Visitor mouse (SV, never stressed) together for the first time in a novel
58
59
60

1
2
3 environment. The IH mouse, previously isolated for 3-4 weeks, was allowed to explore the
4 novel environment for 30 min (E) before gently introducing an unfamiliar SV mouse in the box
5 (always a B6 socially housed mouse). SV mouse was approximately of same weight and age
6 than IH mouse. Social interactions (SI) between mice lasted 8 min. They were recorded for
7 further analysis using Mice Profiler software (de Chaumont et al. 2012).
8
9

10
11
12 Mice submitted to stress alone were sacrificed 90 min after the beginning of stress (short
13 delay protocol, S-Short, n = 6 B6, n = 7 $\beta 2^{-/-}$ mice, published data, Nosjean et al. 2018) or 90
14 min after its end (long delay protocol, S-Long, n = 7 B6, n = 7 $\beta 2^{-/-}$ mice, current data). Stressed
15 mice subjected to exploration and social interaction were sacrificed 90 min after the beginning
16 of stress (short delay protocol, SESI-Short, n = 8 B6, n = 8 $\beta 2^{-/-}$ mice, published data, Nosjean
17 et al. 2018) or 90 min after the end of the social interaction (long delay protocol, SESI-Long, n
18 = 10 B6, n = 7 $\beta 2^{-/-}$ mice, current data). Non-stressed mice were also sacrificed 90 min after the
19 end of the social interaction (long delay protocol, ESI-Long, n = 8 B6 and n = 8 $\beta 2^{-/-}$ mice,
20 current data).
21
22
23
24
25
26
27
28
29
30
31
32
33
34
35
36
37

38 **Immunohistochemical procedures and quantification**

39
40
41
42 General immunohistochemical procedures and quantification were previously described in
43 details (Nosjean et al. 2018). Briefly, after deep anesthesia (Dolethal 2ml / 3ml Nacl, i.p. 0.1ml
44 / 10g) and intracardiac perfusion of fresh ice cold 4% paraformaldehyde in phosphate buffer
45 saline (PBS), cryoprotected IH brains (20% sucrose in PBS overnight, 4°C°) were cut as serial
46 free-floating coronal sections (40 μ m) using a freezing microtome. Rabbit polyclonal anti-c-fos
47 (c-fos (ab-5), 1:8000 dilution, Calbiochem #PC38), biotinylated goat anti-rabbit IgGs
48 secondary antibody (1:200, Vector BA-1000), avidin-biotin complex (1:200 dilution,
49
50
51
52
53
54
55
56
57
58
59
60

1
2
3 Vectastain Elite PK 6100) and diaminobenzidine tetrahydrochloride were sequentially used to
4
5 reveal c-fos protein.
6
7

8
9 Brain images were acquired at x10 with a Sony DFW-X700 digital camera (Sony Co.,
10 Tokyo, Japan) coupled to Olympus BX60 light microscope (Olympus Optical Co., Hamburg,
11 Germany). C-fos positive cells per square micrometer were quantified using
12
13 *icy.bioimageanalysis.org* after delineating each region of interest (ROI) on the picture. C-fos
14
15 positive cells were mapped in all brain structures in front of the corpus callosum from the frontal
16
17 cortex (defined here for simplicity reasons as the prefrontal cortex, PFC, from bregma +3.08 to
18
19 +1.54, Paxinos and Franklin 2001), and in the basolateral nucleus of the amygdala (BLA, from
20
21 bregma -0.58 to -1.58 mm).
22
23
24
25
26
27

28 In the PFC, for structures extending over more than one rostro-caudal level (i.e., PrL,
29 Cg1, M2, M1, LO, VO and MO, 7 areas), we pooled quantifications obtained from its rostral
30
31 to its caudal extent (Global PFC). We also analyzed c-fos protein expression by level in the
32
33 PFC, i.e., in the rostral (from bregma 3.08 to 2.58 mm), median (from bregma 2.46 to 2.10
34
35 mm), and caudal parts (from bregma 1.98 to 1.54 mm) of the PFC. For each mouse and each
36
37 selected brain level, at least 2-3 sections were bilaterally analyzed (i.e., about more than 100
38
39 ROIs par mouse) and then averaged for each animal.
40
41
42
43
44
45

46 **Statistical analysis**

47
48
49

50 C-fos protein expression was quantified in the global PFC and in its 24 sub-areas as well as in
51
52 the BLA of the amygdala. Results were expressed as means \pm SEM. Values were considered
53
54 statistically significant for $p \leq 0.05$. Experiments were analyzed in 2 sets. In the first one,
55
56 comparisons were performed on 10 independent groups, i.e., for both genotypes, in control mice
57
58 (no stress and no behavioral procedure), in stressed mice (S mice) and in stressed mice
59
60

submitted to the social task (SESI mice) in which c-fos protein was detected either 90 min after the beginning of the experiment, i.e., after the beginning of the stress (S-Short and SESI-Short mice), or 90 min after the end of the experiment, i.e., after the end of the stress or the social interaction (S-Long and SESI-Long mice). In the second set of experiments, comparisons were performed on 4 independent groups, i.e., for both genotypes, in non-stress (ESI-Long) and stressed (SESI-Long) animals. Multiple comparisons between groups were performed with Kruskal-Wallis one-way ANOVA on Ranks using Sigmaplot 12.0. When normality passed, data were subsequently analyzed with the Holm-Sidak method test and when it did not, with Mann-Whitney U-tests. Correlations between the 25 studied brain areas were performed using Spearman test and a Bonferroni correction was applied for multiple comparisons. Statistically threshold was thus set at $p \leq 0.002$.

Results

Effect of time, stress and social interaction on brain activity

In a first series of experiments, we dissected the time effect on brain c-fos protein expression in B6 and $\beta 2^{-/-}$ mice subjected to acute stress alone or to acute stress followed by social interaction task (Fig. 1).

Effect of time on stress alone (Figure 2A-C, Supplementary Table 1a-b)

Acute stress in B6 mice (**S-Short vs Cnt**) induced a significant increase of c-fos protein expression in the **PrL** due to specific activation of the **rPrL**, in the **Cg1 (mCg1 and cCg1)**, in the **M2 (mM2 and cM2)**, in **cM1** and in the **BLA**. Thus, at short time, acute stress induced brain activation all along the PFC, in particular in the median wall (**PrL, Cg1**), in the associative and motor areas (**FrA, M1, M2**) as well as in the **BLA**. In $\beta 2^{-/-}$ mice, acute stress followed by a

1
2
3 short delay (**S-Short vs Cnt**, Nosjean et al. 2018) decreased c-fos protein expression only in
4 **LO (rLO), rVO, mPrL** and in the **BLA**. Thus, acute stress triggered opposite effects in B6 and
5 $\beta 2^{-/-}$ mice compared to their respective controls. Limbic structures such as **PrL, Cg1** and the
6
7 caudal motor cortices (primary and secondary) and **BLA** were hyper-activated by stress in B6
8 mice but not in $\beta 2^{-/-}$ mice while other PFC areas (i.e., **mPrL** and orbital **rLO** and **rVO** areas)
9
10 and **BLA** were hypo-activated by stress in $\beta 2^{-/-}$ mice.
11
12
13
14
15
16
17

18 Long delay protocol showed no change in PFC c-fos protein levels, both in stressed B6
19 and $\beta 2^{-/-}$ mice compared to their respective controls (**S-Long vs Cnt**), when considering the
20 entire PFC or its different levels. In contrast, an increase and a decrease of c-fos protein
21 expression remained detected in the **BLA** respectively in B6 and $\beta 2^{-/-}$ mice (for both genotypes,
22 $H = 36.143, df = 9, p < 0.001$; MW: $p = 0.001$). Thus, time normalized the stress-induced c-fos
23 protein expression in the PFC in both genotypes, but was not sufficient to restore that of the
24
25
26
27
28
29
30
31
32
33
34
35
36
37
38
39
40
41
42
43
44
45
46
47
48
49
50
51
52
53
54
55
56
57
58
59
60

Finally, comparisons between short and long delay protocols (**S-Long vs S-Short**)
showed marginal hypo-activations taking place only at some levels of the rostral axis: a
diminution of c-fos protein expression was observed in B6 **mCg1** area ($H = 48.526, df = 9, p <$
 0.001 ; MW: $p = 0.022$) and in $\beta 2^{-/-}$ **rFrA** ($H = 57.449, df = 9, p < 0.001$; MW: $p = 0.026$). No
change was detected in B6 **BLA** ($H = 36.143, df = 9, p < 0.001$; MW: $p = 1.000$) while a
decrease in $\beta 2^{-/-}$ **BLA** was evidenced ($H = 36.143, df = 9, p < 0.001$; MW: $p = 0.007$). Such
results suggest that time has little if any effect on stress-induced c-fos expression in the PFC,
while it influenced the BLA activity, only in $\beta 2^{-/-}$ mice. This genotype difference discards a
simple and non-specific delay effect of c-fos protein detection with time.

1
2
3 **Effect of time on stress followed by social task (Figure 2A-E, Supplementary Table 2a and**
4
5 **b)**
6
7

8 The influence of time was also assessed on social interaction in stressed animals (**SESI-Short**
9 **vs Cnt, SESI-Long vs Cnt, SESI-Long vs SESI-Short**).
10
11

12
13 We observed that B6 mice submitted to acute stress followed by the social task (**SESI-**
14 **Short vs Cnt**) showed increased c-fos protein expression in all prefrontal areas ($0.03 \leq ps <$
15 0.001) except in the **mVO**, the **mMO** and the **cLO** (Nosjean et al. 2018). Likewise, $\beta 2^{-/-}$ animals
16 displayed increased activity compared to their controls ($0.011 \leq ps < 0.001$), except in the **MO**
17 when considering the PFC areas in all their extent and in the **rMO**, **rDLO**, **mAI**, **mMO**, **cAID**,
18 **cAIV** and **cLO** along the PFC rostro-caudal axis (Nosjean et al. 2018). For both genotypes,
19 hyperactivity was observed in the **BLA** ($H = 36.143$, $df = 9$, $ps < 0.001$; MW: $ps < 0.001$). Thus,
20 even if social interaction occurs shortly before sacrifice, i.e., with little time for c-fos expression
21 to change, it produced massive brain activation in stressed mice of both genotypes.
22
23
24
25
26
27
28
29
30
31
32
33

34
35 Long delay protocol induced no change in c-fos protein levels when looking at the entire
36 PFC in stressed B6 mice submitted to the social task compared to their own controls (**SESI-**
37 **Long vs Cnt**). Along the rostro-caudal axis, it provoked hypo-activity in **rFrA** ($H = 57.449$, df
38 $= 9$, $p < 0.001$; MW: $p = 0.002$) and over-activity in **mPrL** ($H = 43.911$, $df = 9$, $p < 0.001$; MW:
39 $p = 0.037$), **mCg1** ($H = 48.526$, $df = 9$, $p < 0.001$; MW: $p = 0.045$) and **BLA** ($H = 36.143$, $df =$
40 9 , $p < 0.001$; MW: $p = 0.030$). In contrast, in $\beta 2^{-/-}$ mice (**SESI-Long vs Cnt**), long delay
41 triggered a drop of c-fos protein expression only in **LO** considering the PFC as a whole ($H =$
42 52.467 , $df = 9$, $p < 0.001$; MW: $p = 0.035$) likely due to decreases in the **rLO** ($H = 53.706$, df
43 $= 9$, $p < 0.001$; MW: $p = 0.005$) and **mLO** ($H = 53.706$, $df = 9$, $p < 0.001$; MW: $p = 0.014$).
44 Other PFC areas also showed hypo-activity: **rFrA** ($H = 57.499$, $df = 9$, $p < 0.001$; MW: $p =$
45 0.002), **rVO** ($H = 46.088$, $df = 9$, $p < 0.001$; MW: $p = 0.005$), **mPrL** ($H = 43.911$, $df = 9$, $p <$
46 0.001), **mCg1** ($H = 48.526$, $df = 9$, $p < 0.001$; MW: $p = 0.045$), **BLA** ($H = 36.143$, $df =$
47 9 , $p < 0.001$; MW: $p = 0.030$).
48
49
50
51
52
53
54
55
56
57
58
59
60

0.001; MW: $p = 0.005$) and in **BLA** ($H = 36.143$, $df = 9$, $p < 0.001$; MW: $p = 0.001$). Thereby, adding a delay between the social interaction and the mice sacrifice drastically changed its impact on brain c-fos protein expression: it diminished the extent of the PFC activation in B6 mice and reversed its impact in $\beta 2^{-/-}$ mice in which only hypo-activations were detected. Thus, time buffered the stress-social interaction induced c-fos protein activation.

In line with previous work (Nosjean et al. 2018) after a short delay (**SESI-Short vs S-Short**), social task in stressed mice compared to stress alone triggered over-activations in all rostral areas and only in part in medial and caudal PFC areas (**mM1**, **cM1**, **rMO**, **mPrL**, **cSI** and **cDI**) in B6 mice while in $\beta 2^{-/-}$ mice only over-activations were detected in the PFC (except in the **cLO**) and in the **BLA**. Thus, social task in stressed mice induced hyper-activation at short term, in particular in $\beta 2^{-/-}$ mice.

After long delay (**SESI-Long vs S-Long**), social behavior in stressed mice induced no statistical effect for any analyzed PFC area in B6 and $\beta 2^{-/-}$ mice apart from a hypo-activation in **rFrA** for both genotypes ($H = 57.449$, $df = 9$, $p < 0.001$; MW: $p = 0.002$ in B6 mice, $p = 0.038$ in $\beta 2^{-/-}$ mice). In the **BLA**, c-fos protein level dropped in B6 ($H = 36.143$, $df = 9$, $p < 0.001$; MW: $p = 0.002$) but remained unchanged in $\beta 2^{-/-}$ mice ($H = 36.143$, $df = 9$, $p < 0.001$; MW: $p = 0.535$). Thus, the long delay that allowed a maximal expression of c-fos protein revealed a strong buffering role of social interactions on stress-induced prefrontal activation.

Finally, the long delay protocol (**SESI-Long vs SESI-Short**) provoked hypo-activations in all brain studied areas in both in B6 and $\beta 2^{-/-}$ mice, except for B6 mice in **mVO** ($F_{(9,65)} = 8.243$, $p < 0.001$; HS: $p = 0.614$), **mMO** ($F_{(9,65)} = 6.193$, $p < 0.001$; HS: $p = 0.294$) and **cLO** ($F_{(9,65)} = 3.414$, $p < 0.001$; HS: $p = 0.874$). Hence, despite some exceptions, the delay before sacrifice induced hypo-activations in the PFC and in the BLA in both genotypes.

Genotype and time effects (Figure 3A-B, Supplementary Table 4a-b)

Comparisons between B6 and $\beta 2^{-/-}$ mice (**$\beta 2^{-/-}$ vs B6 mice**) were done for control mice (**Cnt**), stress alone with a short (**S-Short**) or a long (**S-Long**) delay of c-fos protein expression, and stress followed by the social task with a short (**SESI-Short**) or long delay (**SESI-Long**).

No statistical differences for any analyzed area were detected between B6 and $\beta 2^{-/-}$ control mice when considering the PFC or the BLA.

With the short delay following stress alone significant decreases of the protein expression were observed in all PFC areas taken in all their extent in $\beta 2^{-/-}$ mice compared to B6 mice except in **MO (S-Short, $0.029 \leq ps < 0.001$)**. Hypo-activations were specifically due to diminutions of the protein expression at different levels of the rostro-caudal axis, i.e., in the **rLO, rVO, mPrL cPrL mCg1, cCg1, mM2, cM2** and in the **BLA** which is in concordance with previous data (Nosjean et al. 2018). Hence, in $\beta 2^{-/-}$ mice, a short delay mostly reduced the protein expression in the orbital structures of the rostral PFC as well as in the medio-caudal wall of the PFC, and in the amygdala, suggesting an important role of $\beta 2$ -nAChRs in these areas.

Stress followed by a long delay in $\beta 2^{-/-}$ mice compared to B6 mice (**S-Long**) significantly decreased the activity of **PrL** ($F_{(9,65)} = 16.553, p < 0.001$; HS: $p = 0.049$) and **Cg1** ($F_{(9,65)} = 15.582, p < 0.001$; HS: $p = 0.048$), likely because of effect on the **rPrL** ($F_{(9,65)} = 15.010, p < 0.001$; HS: $p = 0.006$) and on the **cCg1** ($F_{(9,65)} = 14.671, p < 0.001$; HS: $p = 0.041$) as other regions remained unaffected. Diminutions in the rostral PFC were also detected, specifically in the **rFrA** ($H = 57.449, df = 9, p < 0.001$; MW: $p = 0.038$) and in the **rLO** ($H = 53.706, df = 9, p < 0.001$; MW: $p = 0.038$). In addition, **BLA** was hypo-activated ($H = 36.143, df = 9, p < 0.001$; MW: $p < 0.001$). Thus, long delay significantly extended hypo-activation in the rostral PFC and in the BLA of $\beta 2^{-/-}$ mice.

1
2
3 Short delay protocol in stressed $\beta 2^{-/-}$ mice interacting socially compared to their
4 corresponding B6 mice (**SESI-Short**) didn't show any **BLA** ($H = 36.143$, $df = 9$, $p < 0.001$;
5
6 $MW: p = 0.574$) nor **PFC** alterations except in **rFrA** ($H = 57.449$, $df = 9$, $p < 0.001$; $MW: p <$
7
8 0.001). Thereby, the major genotype effect in stressed $\beta 2^{-/-}$ mice submitted to social task is a
9
10 restoration of c-fos protein expression in the PFC and in the BLA.
11
12
13
14

15
16 In contrast, at long delay after stress and social task (**SESI-Long**) there was significant
17
18 hypo-activations in $\beta 2^{-/-}$ mice compared to B6 mice in the **PrL** ($F_{(9,65)} = 16.553$, $p < 0.001$; $HS:$
19
20 $p = 0.013$), **Cg1** ($F_{(9,65)} = 15.582$, $p < 0.001$; $HS: p = 0.001$), **LO** ($H = 52.467$, $df = 9$, $p < 0.001$;
21
22 $MW: p < 0.001$) and **BLA** ($H = 36.143$, $df = 9$, $p < 0.001$; $MW: p < 0.001$). Looking at the
23
24 different levels of the PFC, decreases of the protein expression were significant in the **rFrA** (H
25
26 $= 57.449$, $df = 9$, $p < 0.001$; $MW: p = 0.017$), **rLO** ($H = 53.706$, $df = 9$, $p < 0.001$; $MW: p =$
27
28 0.003), **rVO** ($F_{(9,65)} = 46.088$, $p < 0.001$; $HS: p < 0.001$), in the **mPrL** ($H = 43.911$, $df = 9$, $p <$
29
30 0.001 ; $MW: p = 0.002$), **mCg1** ($H = 48.526$, $df = 9$, $p < 0.001$; $MW: p = 0.002$), **mM2** ($H =$
31
32 45.939 , $df = 9$, $p < 0.001$; $MW: p = 0.028$), **mLO** ($H = 40.675$, $df = 9$, $p < 0.001$; $MW: p =$
33
34 0.001) and the **cIL** ($F_{(9,65)} = 10.503$, $p < 0.001$; $HS: p = 0.002$), **cPrL** ($F_{(9,65)} = 11.498$, $p < 0.001$;
35
36 $HS: p = 0.016$) and in the **cCg1** ($F_{(9,65)} = 14.671$, $p < 0.001$; $HS: p = 0.001$). Hence, long delay
37
38 amplified hypo-activation all along the PFC and in the BLA in $\beta 2^{-/-}$ mice. As this was not the
39
40 case in B6 mice, we can rule out a general timing effect of c-fos protein detection. Notably, the
41
42 genotype effect triggered by any behavioral manipulation (stress, social behavior, at short or
43
44 long delay) was mainly reflected by hypo-activation of the PFC and of the BLA, but never by
45
46 hyper-activations.
47
48
49
50
51
52
53
54
55
56
57
58
59
60

Brain functional connectivity (Figure 4A-B)

Statistical correlations were calculated to identify putative functional relationships between the different PFC areas and the BLA, i.e., between 25 areas.

In B6 control mice, 17 positive correlations were detected between PFC sub-areas ($0.00199 \leq ps \leq 0.0000002$), mainly between lateral and medial areas all along the rostro-caudal axis. Stress alone totally disconnected PFC sub-areas activity in B6 mice at short delay (**S-Short**) but triggered numerous PFC relationships at long delay (41 correlations, **S-Long**, $ps = 0.0000002$). These functional connections were evidenced within each level of the PFC as well as between the lateral, medial and latero-medial areas. Only two PFC sub-areas (**mVO** and **cCg1**) established functional connectivity with the BLA. B6 mice having a social interaction after stress showed additional correlations at short delay (**SESI-Short**, 8 correlations; $ps = 0.0000002$) but drastically disconnected PFC sub-areas at long delay (**SESI-Long**, 6 correlations; $ps = 0.0000002$). Only **cPrL** and **cIL** remained steadily correlated whatever the delay, when social interaction followed stress.

No significant correlations were found in $\beta 2^{-/-}$ control animals while stress alone triggered some correlations between PFC areas after short delay, mostly between medial PFC areas (**S-Short**, 11 positive and 1 negative (bold arrow, $ps = 0.0000002$). After long delay, stress massively extended functional connectivity within the PFC of $\beta 2^{-/-}$ mice (**S-Long**, 82 significant correlations, $ps = 0.0000002$). Compared to stress alone, correlations following social interaction in stressed $\beta 2^{-/-}$ animals increased after short delay (**SESI-Short**, 21 correlations, $0.00178 \leq ps \leq 0.0000002$), and drastically diminished after long delay (**SESI-Long**, 17 correlations, $ps = 0.0000002$). Only **cCg1** and **cPrL** remained steadily correlated whatever the delay, when social interaction followed stress in $\beta 2^{-/-}$ mice. With time, a very limited number

1
2
3 of correlations were similar in B6 and $\beta 2^{-/-}$ mice after stress (**S-Long**, 11 correlations) and after
4 stress coupled to social task (**SESI-Long**, 2 correlations, Fig. 4A and B, dotted arrows).
5
6
7

8
9 Overall, whatever the experimental procedure, major correlations within PFC sub-areas
10 markedly differed between B6 and $\beta 2^{-/-}$ mice, while the BLA activity remained mostly
11 independent of the PFC activity. With the long delay stress alone drastically triggered plethora
12 of functional interconnections between PFC sub-areas, while having a social interaction
13 drastically disconnected them in both genotypes. Thus, major changes in the functional
14 connectivity and organization of cortical networks were detected after extended delay.
15
16
17
18
19
20
21
22
23
24
25

26 **Does stress affect brain activity after a long delay (Figures 1, 5A-B, 6,** 27 **Supplementary Tables 5a-b)?** 28 29 30

31
32 In a second series of experiments, we also evaluated the impact of time in stressed and non-
33 stressed mice (**SESI-Long and ESI-Long**, respectively).
34
35
36

37 With time, stress triggered hypo-activations in all **PFC** areas when considering the entire
38 PFC or its different levels both in B6 and in $\beta 2^{-/-}$ mice interacting socially ($0.022 \leq ps < 0.001$
39 for B6 mice and $ps \leq 0.001$ for $\beta 2^{-/-}$ mice) and in **BLA**, specifically in $\beta 2^{-/-}$ mice ($F_{(3,32)} = 31.413$,
40 $p < 0.001$; HS: $p = 0.002$). Indeed, stress had no effect on BLA in B6 mice, suggesting a
41 different emotional value of stress in the two genotypes.
42
43
44
45
46
47
48

49 We also assessed the genotype effect in stressed and non-stressed mice interacting
50 socially for a long delay (**$\beta 2^{-/-}$ vs B6 mice**). In non-stress condition, when looking at the entire
51 PFC, brain activation didn't differ between the two genotypes except for significant increased
52 activity in **M1** ($F_{(3,32)} = 34.044$, $p < 0.001$; HS: $p = 0.006$) and decreased activity in the **BLA**
53 ($F_{(3,32)} = 31.413$, $p < 0.001$; HS: $p < 0.001$) in $\beta 2^{-/-}$ mice. Looking at the different levels of the
54
55
56
57
58
59
60

PFC, increases of the protein were detected in the median and caudal PFC in $\beta 2^{-/-}$ mice. Such hyper-activations concerned **mCg1** ($H = 26.937$, $df = 3$, $p < 0.001$; MW: $p = 0.028$), **mM1** ($H = 24.451$, $df = 3$, $p < 0.001$; MW: $p = 0.010$), **mAI** ($F_{(3,32)} = 39.367$, $p < 0.001$; HS: $p = 0.028$), **cM2** ($H = 26.504$, $df = 3$, $p < 0.001$; MW: $p = 0.050$), **cM1** ($F_{(3,32)} = 37.173$, $p < 0.001$; HS: $p = 0.012$), **cS1** ($F_{(3,32)} = 20.380$, $p < 0.001$; HS: $p = 0.007$), **cAIV** ($H = 24.764$, $df = 3$, $p < 0.001$; MW: $p = 0.015$) and **cLO** ($H = 27.992$, $df = 3$, $p < 0.001$; MW: $p = 0.015$). Hence, in the non-stress condition the absence of functional $\beta 2$ -nAChRs increased activity in the PFC and decreased it in the BLA. Such over-expressions were especially seen in the median and caudal PFC, mostly laterally.

In the stress condition only decreases in activity were detected in $\beta 2^{-/-}$ mice compared to B6 mice. They manifested in all PFC areas of interest, except in **M1** ($F_{(3,32)} = 34.044$, $p < 0.001$; HS: $p = 0.182$), as well as in the **BLA** ($F_{(3,32)} = 31.413$, $p < 0.001$; HS: $p < 0.001$). Significant hypo-activity in the global orbital areas were associated to decreases at each level of the **LO** (**rLO**: $H = 25.706$, $df = 3$, $p < 0.001$; MW: $p = 0.003$; **mLO**: $F_{(3,32)} = 66.234$, $p < 0.001$; HS: $p < 0.001$), **cLO**: $H = 27.992$, $df = 3$, $p < 0.001$; MW: $p = 0.005$), **VO** (**rVO**: $H = 26.960$, $df = 3$, $p < 0.001$; MW: $p < 0.001$; **mVO**: $H = 26.864$, $df = 3$, $p < 0.001$; MW: $p = 0.002$) and **MO** (**rMO**: $F_{(3,32)} = 36.986$, $p < 0.001$; HS: $p = 0.015$; **mMO**: $F_{(3,32)} = 47.799$, $p < 0.001$; HS: $p < 0.001$). Likewise, hypo-activity in **Prl**, **Cg1** and in the motor cortices **M2** was due to diminutions in their medial and caudal parts (**mPrL**: $H = 26.487$, $df = 3$, $p < 0.001$; MW: $p = 0.002$; **mCg1**: $H = 26.937$, $df = 3$, $p < 0.001$; MW: $p = 0.002$; **cPrL**: $F_{(3,32)} = 38.701$, $p < 0.001$; HS: $p < 0.001$; **cCg1**: $H = 26.937$, $df = 3$, $p < 0.001$; MW: $p = 0.002$; **mM2**: $F_{(3,32)} = 31.219$, $p < 0.001$; HS: $p = 0.013$; **cM2**: $H = 26.504$, $df = 3$, $p < 0.001$; MW: $p = 0.004$). Decreased activity in the insular cortices also extended along the rostro-caudal axis (**mAI**: $F_{(3,32)} = 39.367$, $p < 0.001$; HS: $p = 0.004$; **cAID**: $F_{(3,32)} = 22.630$, $p < 0.001$; HS: $p = 0.012$ and **cAIV**: HS = 24.764 , $df = 3$, $p < 0.001$; MW: $p = 0.013$). Finally, decreases in c-fos protein expression were

1
2
3 significant only in **cM1** ($F_{(3,32)} = 37.173$, $p < 0.001$; HS: $p = 0.018$). Therefore, as compared to
4
5 baseline levels, the coupling of stress and social interaction relies on functional $\beta 2$ -nAChRs,
6
7 specifically regarding the medial wall of the PFC and the BLA, in which significant hypo-
8
9 activations emerged.
10
11

12
13 We also identified statistical correlations between the different PFC areas taken by levels
14
15 and the BLA.
16
17

18 In non-stress B6 mice (**ESI-Long**), 14 positive correlations were detected between PFC
19
20 sub-areas, mainly between lateral ones along the rostro-caudal axis ($0.00178 \leq ps \leq 0.0000002$).
21
22 Stress drastically reduced such functional relationships (**SESI-Long**, 6 correlations, 0.0000002
23
24 $\leq ps \leq 0.00178$). In non-stress $\beta 2^{-/-}$ mice (**ESI-Long**), significant correlations were mainly
25
26 reported in the latero-medial areas at each level of the rostro-caudal axis (19 correlations,
27
28 $0.00178 \leq ps \leq 0.0000002$). Correlations were totally different from those identified in B6 mice,
29
30 except relationships between mM1-cS1 and cCg1-cPrL areas. After stress (**SESI-Long**, 17
31
32 correlations, $ps = 0.0000002$), correlations between lateral and latero-medial areas were
33
34 reduced, while those between medial areas appeared.
35
36
37
38
39

40 Overall, at long term the coupling of stress and social interaction drastically changed
41
42 functional connectivity within the PFC. Although abundant in all brain areas, $\beta 2$ -nAChRs
43
44 appear particularly important for functional connectivity within prefrontal sub-areas, and for its
45
46 plasticity and reorganization after stress.
47
48
49
50
51

52 **Discussion**

53
54
55 The effects of stress exposure depend on many factors such as nature, intensity, duration of the
56
57 stressor, age, sex and history of the individual. Behavioral and physiological adjustments to
58
59 stress engage different systems as the neuroendocrine, autonomic, immune, cardiovascular and
60

1
2
3 metabolic systems as well as brain release of different neurotransmitters, neuromodulators and
4
5 neuropeptides (see Westerink 1995; McEwen 2006; Radley et al. 2008; Arnsten 2009; Lupien
6
7 et al. 2009; Ossewaarde et al. 2011; McEwen et al. 2016), and many brain structures such as
8
9 the hypothalamus, the hippocampus, the ventral tegmental area, the nucleus accumbens, the
10
11 PFC and the amygdala, among others (see Cacioppo 1994; Herman and Cullinan 1997; Buijs
12
13 and Van Eden 2000; Pacák and Palkovits 2001; de Kloet et al. 2005; Arnsten 2009; Lupien et
14
15 al. 2009; Mora et al. 2012; Beery and Kaufer 2015; McKlveen et al. 2015; Paul et al. 2015; Mc
16
17 Ewen et al. 2016; Zhang et al. 2018). Brain c-fos protein expression depends on the intensity
18
19 and the duration of the stimulus and on its acute or chronic character. In the literature acute
20
21 restraint stress duration has been reported to be either of 30 min (Yokoyama and Sasaki 1999;
22
23 Chowdhury et al. 2000; Viau and Sawchenko 2002; Patel et al. 2005; Radley et al. 2008; Goebel
24
25 et al. 2009; Zavala et al. 2011), 60 min (Stone et al. 1993; Yokoyama and Sasaki 1999;
26
27 Chowdhury et al. 2000), two hours (Honkaniemi et al. 1992; Chowdhury et al. 2000; O'Mahony
28
29 et al. 2010) or more (2 at 8 hours; Honkaniemi et al. 1992; Chowdhury et al. 2000; Roske et al.
30
31 2002). The period between the end of the stimulus and the sacrifice of animals for c-fos protein
32
33 detection also differs: for various stress durations, the delay before sacrifice can be just after
34
35 stress exposure (Yokohama et al. 1999; Chowdhury et al. 2000; Viau and Sawchenko 2002;
36
37 Patel et al. 2005; Reznikov et al. 2008; Ito et al. 2009), of 30 min (Yokohama et al. 1999; Viau
38
39 and Sawchenko 2002; Patel et al. 2005), of 1 hour (Yokohama et al. 1999; Viau and Sawchenko
40
41 2002), of 2 hours (Stone et al. 1993; Radley et al. 2006, 2008; O'Mahony et al. 2010; Zavala et
42
43 al. 2011), or of several hours (Chowdhury et al. 2000; Viau and Sawchenko 2002). Here, with
44
45 an acute and fix stress duration of 45 min, we addressed the question of impact on brain activity
46
47 of 1) a time laps between stress coupled or not with a social task, and sacrifice 2) a long delay
48
49 between social interaction and sacrifice, in stress and no stress conditions, in order to address
50
51 the plasticity of PFC-BLA networks.
52
53
54
55
56
57
58
59
60

Effect of time on brain plasticity versus time-course of c-fos protein expression.

We could wonder whether using c-fos is a suitable method to capture the effect of time and its buffering role, as c-fos protein expression varies with time and, as described above, decreases with time. If our results were only due to the time-course of the c-fos expression, we could expect brain activation and brain connectivity to reach control levels after a certain time. However, our results demonstrate that between short and long delays, we observed either no effect, hyper-activation or hypo-activation, depending on the behavior and of the lack of $\beta 2$ nAChRs. Similarly, when considering functional connectivity, there was no linear modification with time, thus discarding a simple effect of time-course of the protein expression.

Effect of time, stress, social interaction on brain activity.

First, we analyzed PFC and BLA c-fos protein expression at two time points, i.e., 90 min after the beginning or the end of stress exposure, coupled or not to a social task. Such timing was chosen in accordance with works showing a peak production of the protein between 60-120 minutes (Morgan et al. 1987; Morgan and Curran 1989; Hoffman et al. 1993; Kovacs 1998, 2008; Zangenehpour and Chaudhuri 2002; Guzowski et al. 2005). We chose to focus on the PFC and on the amygdala because of their key role in mediating the emotional responses to stress and social behavior outcomes (Heidbreder and Groenewegen 2003; McEwen et al. 2006, 2008; Lupien et al. 2009; Arnsten 2009; Avale et al. 2011; Mora et al. 2012; Nosjean et al. 2018). Furthermore, we questioned the role of the cholinergic system using mice lacking nicotinic $\beta 2$ -receptor subunit ($\beta 2$ -nAChRs), since brain cholinergic transmission was shown to play a major role in stress induced affective and behavioral responses (Robbins and Roberts 2007; Ofek and Soreq 2013; Mineur and Picciotto 2019; Neves and Grace 2019). The $\beta 2$ -

1
2
3 nAChRs are ubiquitously expressed in the brain, notably in the PFC and the BLA (Hogg et al.
4
5 2003; Fowler et al. 2008; Hurst et al. 2013; Mineur et al. 2016; Zhang et al. 2018; Mineur and
6
7 Picciotto 2019) and we previously showed that their viral re-expression specifically in the
8
9 prelimbic area of the PFC was necessary and sufficient to restore social interaction in $\beta 2^{-/-}$ mice
10
11 (Avale et al. 2011).
12
13
14
15
16

17 **Effect of time on stress alone**

18
19
20 At short-term, stress impacted differentially the PFC and the BLA in both genotypes compared
21
22 to their own control: it activated the BLA and some PFC areas all along the rostro-caudal axis
23
24 in B6 mice, and hypo-activated the BLA and some other PFC sub-regions in $\beta 2^{-/-}$ mice. Thus,
25
26 the BLA and the PFC reacted in opposite way depending on the presence of the $\beta 2$ nAChRs
27
28 that play a buffer role in such stress processes. At long term, stress also impacted distinctly each
29
30 genotype's PFC and BLA reactivity. Indeed, compared to controls, time fully buffers the stress-
31
32 induced PFC hyper-activation in B6 mice but not the PFC hypo-activation in $\beta 2^{-/-}$ mice. It had
33
34 no effect on BLA activity in B6 mice and reinforced the BLA hypoactivation in $\beta 2^{-/-}$ mice,
35
36 suggesting that the cholinergic system plays a role on PFC and promotes BLA reactivity.
37
38 Interestingly, comparison between short and long delay after stress showed little or no effects
39
40 in the PFC and the BLA. Thus, the stress impacts fade with time in all PFC areas but was
41
42 maintained in the BLA. Both stress and time differentially modulate the PFC and BLA activities
43
44 depending on the presence of $\beta 2$ nAChRs (Fig. 7).
45
46
47
48
49
50

51
52 Despite strong reciprocal anatomical connections between PFC sub-regions (Van Eden
53
54 and Buijs 2000; Gabbott et al. 2003; Heidbreder and Groenewegen 2003; Dalgleish 2004;
55
56 Vertes 2004, 2006; Rogers-Carter et al. 2018), stress in B6 mice completely deconstructs all
57
58 functional links between PFC sub-areas at short time and triggers multiple PFC relationships at
59
60

1
2
3 long term suggesting that functional connectivity is an important marker of stress adaptation
4
5 that should be taken into account in brain imaging studies. By contrast, in $\beta 2^{-/-}$ mice stress
6
7 triggers some functional connectivity at short term and plethora at long term. These data
8
9 evidence that both stress and time participate in network reconfiguration, likely involving $\beta 2$
10
11 nAChRs modulation in the PFC. Analyzing correlation of activity between brain regions using
12
13 c-fos expression provides an index of functional connectivity (Lesburguères et al. 2011 ; Cohen
14
15 et al. 2017; Rogers-Carter et al. 2018), particularly as we quantified here c-fos expression in
16
17 numerous prefrontal regions of interest shown to be part of an important social network
18
19 (Rogers-Carter et al. 2018).
20
21
22
23
24
25

26
27 Frontal areas established dense reciprocal connections with the BLA (McDonald 1991,
28
29 1998; Bacon et al. 1996; Gray 1999; Vertes 2004; Gabbott et al. 2005; Hoover and Vertes
30
31 2007). However, like observed by others in social conditions (Rogers-Carter et al. 2018), we
32
33 didn't observe functional relationships between the BLA and the PFC sub-regions. Such
34
35 functional connection significantly emerged only when stress was followed by a long delay,
36
37 and only in B6 mice, suggesting a role of $\beta 2$ nAChRs in this PFC-BLA plasticity. Other authors
38
39 reported that despite anatomical connections some areas (OFC, PrL, hippocampus) may not be
40
41 activated together, depending on the behavioral contexts (Lesburguères et al. 2011; Rogers-
42
43 Carter et al. 2018; Liu et al. 2020). Therefore, we can hypothesize that BLA and PFC may
44
45 predominantly not act in synergy, except in stress condition after long delay. This synergy could
46
47 be supported by the fact that stress promotes the release of monoamines, glutamate and GABA
48
49 both in the PFC and in the amygdala (Imperato et al. 1991; Tanaka et al. 1991; Arnsten 1997;
50
51 Finlay and Zigmond 1997; Feenstra 2000; Morilak et al. 2005; Moghaddam and Homayoun
52
53 2008; see also Arnsten and Li 2005; Mora et al. 2012). Acetylcholine, however, plays a distinct
54
55 role in stress effect. Indeed, stress promotes the release of Ach in the PFC (Mark et al. 1996;
56
57
58
59
60

1
2
3 Pepeu and Blandina 1998; Mora et al. 2012; Ofek and Soreq 2013) but not in the amygdala
4
5 (Mark et al. 1996). We previously showed that $\beta 2^{-/-}$ mice exhibit higher levels of monoamines
6
7 and of Ach than B6 mice in the prelimbic area (Coura et al. 2013), and show altered PFC
8
9 excitatory/inhibitory balance (Pittaras et al. 2016). The differential impact in both strains on
10
11 stress-induced brain activity/plasticity could be linked to differences in levels of various
12
13 neurotransmitters, leading to distinct PFC-BLA reactivity to stress.
14
15
16
17
18

19 **Effect of time on stress followed by social task**

20
21
22 The strong brain c-fos over-expression associated to social interaction occurring in our case 30
23
24 minutes after stress in our short-term condition is independent of the time necessary for the
25
26 maximal protein translation. Brain activation was also seen by others when protein expression
27
28 was measured just after the end of a stressful experiment (Chowdhury et al. 2000; Viau and
29
30 Sawchenko 2002; Patel et al. 2005; Reznikov et al. 2008; Ito et al. 2009). Moreover, such effects
31
32 on PFC and BLA activity are specifically due to the social interaction since novelty exploration
33
34 without social behavior after stress induced only marginal activation of the PFC in B6 mice and
35
36 no activation in $\beta 2^{-/-}$ mice (Nosjean et al. 2018). When increasing the delay after social
37
38 interaction the extent of the PFC hyper-activation was nearly abolished, thus reaching normal
39
40 levels in B6 mice. PFC activation was, by contrast, completely reversed in $\beta 2^{-/-}$ mice, in which
41
42 only hypo-activations were detected. Likewise, only hypo-activations were detected in the
43
44 entire PFC and in the BLA in both genotypes when comparisons were performed between short
45
46 and long delays, or in mice submitted to the social task without stress (see Fig. 7). Our data
47
48 therefore indicates that time alone is not sufficient to restore normal brain activity and that the
49
50 opportunity to have a social contact after stress promotes brain plasticity.
51
52
53
54
55
56
57

58 Stress followed by social task after a long delay differentially engaged PFC and BLA
59
60 activity in all mice. This is in accordance with the literature assigning a major role of the PFC

1
2
3 in cognitive and executive processes and the one of amygdala in affective and avoidance
4 behaviors (see Mc Ewen 2007; del Arco and Mora 2009; Higley and Picciotto 2014; Neves and
5 Grace 2019). We previously showed that acute stress triggers aggressiveness in B6 and $\beta 2^{-/-}$
6 mice, even if not all individuals were affected (Nosjean et al. 2015). After a short delay, social
7 interaction restores a few functional links between PFC areas in stressed B6 mice and increases
8 functional connectivity in stressed $\beta 2^{-/-}$ mice. Increasing the delay after stress coupled to social
9 task drastically reduced the number of functional relationships in both genotypes. Taking
10 together, our data show that functional PFC-BLA connectivity is not only modulated by
11 behavior but also by time and $\beta 2$ nAChRs activity. Social interaction, known to involve the
12 cholinergic system, and time may together synergistically down-regulate the impact of acute
13 stress and participate in resilience modulation, thus extending the works reviewed by Beery and
14 Kaufer (2015).
15
16
17
18
19
20
21
22
23
24
25
26
27
28
29
30
31
32
33

34 **Does stress affect brain activity after a long delay?**

35
36
37
38 With time, stress coupled with social task hypo-activated all PFC areas in both genotypes while
39 in non-stress condition, restoration to basal level requires $\beta 2$ -nAChRs. Likewise, $\beta 2$ -nAChRs
40 appeared very important for the BLA activity, whatever the emotional state (Fig. 7). Moreover,
41 at long term, coupling acute stress and social task drastically changed the functional
42 connectivity within the PFC but had no effect on the BLA. Thus, $\beta 2$ -nAChRs appear
43 particularly important for functional connectivity within prefrontal sub-areas, and for its
44 plasticity and reorganization after stress.
45
46
47
48
49
50
51
52
53
54
55
56
57
58
59
60

Conclusions

Our main results reveal that time fully buffers the stress-induced PFC and BLA hyperactivation in B6 mice. The lack of $\beta 2$ -nAChRs provoked massive PFC and BLA hypoactivations and modifies the functional connectome within the PFC and the functional PFC-BLA connectivity. Part of the PFC areas studied as the dorsomedial PFC, the rostral anterior cingulate cortex, the anterior and ventral median PFC, the rostral insula and the sensory motor areas are largely involved in the default mode network (DMN) characterized by a deactivation of functional brain activity during various tasks and an activation at rest (see Raichle et al. 2001; Pallesen et al. 2009; Raichle 2015; Mooneyham et al. 2016; Clemens et al. 2017; Finc et al. 2017). As illustrated in Fig. 6, our social task following stress abolished such functional connectivity in the PFC-BLA network. If further works are needed to fully understand the relationship between brain activity and functional connectivity our results clearly show a time dependent brain plasticity.

Funding

This work was supported by the Centre National de la Recherche Scientifique (CNRS, UMR 9197) by the ANR-FLEXNEURIM grant.

Acknowledgements

We thank Jonathan Chabout, Claire Dechoux and Julie Brissez for help with some immunohistochemical experiments.

Notes

Conflict of Interest: None declared.

References

- Adolphs R. 2001. The neurobiology of social cognition. *Curr. Opin. Neurobiol.* 11:231-239.
- Adolphs R. 2009. The social brain: Neural basis of social knowledge. *Annu. Rev. Psychol.* 60:693-716.
- Adolphs R, Anderson D. 2013. Social and emotional neuroscience. *Curr. Opin. Neurobiol.* 23:291-293.
- Arnsten AFT. 1997. Catecholamine regulation of the prefrontal cortex. *J. Psychopharmacol.* 11:151-162.
- Arnsten AF. 2009. Stress signalling pathways that impair prefrontal cortex structure and function. *Nat. Rev. Neurosci.* 10:410-422.
- Arnsten AF, Li BM. 2005. Neurobiology of executive functions: catecholamine influences on prefrontal cortical functions. *Biol. Psychiatry.* 57:1377-1384.
- Atrooz F, Liu H, Salim S. 2019. Stress, psychiatric disorders, molecular targets, and more. *Prog. Mol. Biol. Transl. Sci.* 167:77-105.
- Avale ME, Chabout J, Pons S, Serreau P, de Chaumont F, Olivo-Marin J-C, Bourgeois J-P, Maskos U, Changeux J-P, Granon S. 2011. Prefrontal nicotinic receptors control novel social interaction between mice. *FASEB J.* 25:2145-2155.
- Bachevalier J, Loveland KA. 2006. The orbitofrontal-amygdala circuit and self-regulation of social-emotional behavior in autism. *Neurosci. Biobehav. Reviews.* 30:97-117.
- Bacon SJ, Headlam AJ, Gabbott PL, Smith AD. 1996. Amygdala input to medial prefrontal cortex (mPFC) in the rat: a light and electron microscope study. *Brain Res.* 720:211-219.
- Beery AK, Kaufer D. 2015. Stress, social behavior, and resilience: insights from rodents. *Neurobiol. Stress.* 1:116-127.
- Bickart KC, Dickerson BC, Barrett LF. 2014. The amygdala as a hub in brain networks that support social life. *Neuropsychologia.* 63 :235-248.

- 1
2
3 Bicks LK, Koike H, Akbarian S, Morishita H. 2015. Prefrontal Cortex and Social Cognition in
4
5 Mouse and Man. *Front. Psychol.* 6:1805.
6
7
8 Bisler S, Schleicher A, Gass P, Stehle JH, Zilles K, Staiger JF. 2002. Expression of c-Fos,
9
10 ICER, Krox-24 and JunB in the whisker-to barrel pathway of rats: time course of induction
11
12 upon whisker stimulation by tactile exploration of an enriched environment. *J. Chem.*
13
14 *Neuroanat.* 23:187-198.
15
16
17 Buijs RM, Van Eden CG. 2000. The integration of stress by the hypothalamus, amygdala and
18
19 prefrontal cortex: balance between the autonomic nervous system and the neuroendocrine
20
21 system. *Prog. Brain Res.* 126:117-132.
22
23
24 Cacioppo JT. 1994. Social neuroscience: autonomic, neuroendocrine, and immune responses
25
26 to stress. *Psychophysiology.* 31:113-128.
27
28
29 Cerqueira JJ, Almeida OF, Sousa N. 2008. The stressed prefrontal cortex. Left? Right! *Brain*
30
31 *Behav. Immun.* 22:630-638.
32
33
34 Chowdhury GM, Fujioka T, Nakamura S. 2000. Induction and adaptation of Fos expression in
35
36 the rat brain by two types of acute restraint stress. *Brain Res. Bull.* 52:171-182.
37
38
39 Clemens B, Wagels L, Bauchmüller M, Bergs R, Habel U, Kohn N. 2017. Alerted default mode:
40
41 functional connectivity changes in the aftermath of social stress. *Sci. Rep.* 7:40180.
42
43
44 Cohen JL, Ata AE, Jackson NL, Rahn EJ, Ramaker RC, Cooper S, Kerman IA, Clinton SM.
45
46 2017. Differential stress induced c-Fos expression and identification of region-specific
47
48 miRNA-mRNA networks in the dorsal raphe and amygdala of high-responder/low-
49
50 responder rats. *Behav Brain Res.* 319:110-123.
51
52
53 Coura RS, Cressant A, Xia J, de Chaumont F, Olivo-Marin J-C, Pelloux Y, Dalley JW, Granon
54
55 S. 2013. Nonaggressive and adapted social cognition is controlled by the interplay between
56
57 noradrenergic and nicotinic receptor mechanisms in the prefrontal cortex. *FASEB J.*
58
59 27:4343-4354.
60

- 1
2
3 Dagleish T. 2004. The emotional brain. *Nat. Rev. Neurosci.* 5:583-589.
4
5 de Chaumont F, Coura RD, Serreau P, Cressant A, Chabout J, Granon S, Olivo-Marin J-C.
6
7 2012. Computerized video analysis of social interactions in mice. *Nat. Methods* 9:410-417.
8
9 de Kloet ER, Joëls M, Holsboer F. 2005. Stress and the brain: from adaptation to disease. *Nat.*
10
11 *Rev. Neurosci.* 6:463-475.
12
13 Del Arco A, Mora F. 2009. Neurotransmitters and prefrontal cortex-limbic system interactions
14
15 implications for plasticity and psychiatric disorders. *J. Neural. Transm.* 116:941-952.
16
17 Demolliens M, Isbaine F, Takerkart S, Huguet P, Boussaoud D. 2017. Social and asocial
18
19 prefrontal cortex neurons: a new look at social facilitation and the social brain. *Soc. Cogn.*
20
21 *Affect. Neurosci.* 12:1241-1248.
22
23
24
25 Feenstra MG. 2000. Dopamine and noradrenaline release in the prefrontal cortex in relation to
26
27 unconditioned and conditioned stress and reward. *Prog. Brain Res.* 126:133-163.
28
29
30 Finc K, Bonna K, Lewandowska M, Wolak T, Nikadon J, Dreszer J, Duch W, Kühn S. 2017.
31
32 Transition of the functional brain network related to increasing cognitive demands. *Hum.*
33
34 *Brain Mapp.* 38:3659-3674.
35
36
37
38 Finlay JM, Zigmond MJ. 1997. The effects of stress on central dopaminergic neurons: possible
39
40 clinical implications. *Neurochem. Res.* 22:1387-1394.
41
42
43 Fowler CD, Arends MA, Kenny PJ. 2008. Subtypes of nicotinic acetylcholine receptors in
44
45 nicotine reward, dependence, and withdrawal: Evidence from genetically modified mice.
46
47 *Behav. Pharmacol.* 19:461-484.
48
49
50 Gabbott PL, Warner TA, Jays PR, Bacon SJ. 2003. Areal and synaptic interconnectivity of
51
52 prelimbic (area 32), infralimbic (area 25) and insular cortices in the rat. *Brain Res.* 993:59-
53
54 71.
55
56
57
58
59
60

- 1
2
3 Gabbott PL, Warner TA, Jays PR, Salway P, Busby SJ. 2005. Prefrontal cortex in the rat:
4 projections to subcortical autonomic, motor, and limbic centers. *J. Comp. Neurol.* 492:145-
5 177.
6
7
8
9
10 Goebel M, Stengel A, Wang L, Taché Y. 2009. Restraint stress activates nesfatin-1-
11 immunoreactive brain nuclei in rats. *Brain Res.* 1300:114-124.
12
13
14 Graef S, Schönknecht P, Sabri O, Hegerl U. 2011. Cholinergic receptor subtypes and their role
15 in cognition, emotion, and vigilance control: an overview of preclinical and clinical
16 findings. *Psychopharmacology.* 215:205-229.
17
18
19
20
21 Granon S, Faure P, Changeux J-P. 2003. Executive and social behaviors under nicotinic
22 receptor regulation. *Proc. Natl. Acad. Sci. U.S.A.* 100:9596-9601.
23
24
25
26 Gray TS. 1999. Functional and anatomical relationships among the amygdala, basal forebrain,
27 ventral striatum, and cortex. An integrative discussion. *Ann. N. Y. Acad. Sci.* 877:439-444.
28
29
30
31 Guzowski JF, Timlin JA, Roysam B, McNaughton BL, Worley PF, Barnes CA. 2005. Mapping
32 behaviorally relevant neural circuits with immediate-early gene expression. *Curr. Opin.*
33 *Neurobiol.* 15:599-606.
34
35
36
37
38 Heidbreder CA, Groenewegen HJ. 2003. The medial prefrontal cortex in the rat: evidence for a
39 dorso-ventral distinction based upon functional and anatomical characteristics. *Neurosci.*
40 *Biobehav. Rev.* 27:555-579.
41
42
43
44
45 Herman JP, Cullinan WE. 1997. Neurocircuitry of stress: central control of the hypothalamo-
46 pituitary-adrenocortical axis. *Trends Neurosci.* 20:78-84.
47
48
49 Higley MJ, Picciotto MR, 2014. Neuromodulation by acetylcholine: examples from
50 schizophrenia and depression. *Curr. Opin. Neurobiol.* 29:88-95.
51
52
53
54 Hoffman GE, Smith MS, Verbalis JG. 1993. c-Fos and related immediate early gene products
55 as markers of activity in neuroendocrine systems. *Front. Neuroendocrinol.* 14:173-213.
56
57
58
59
60

- 1
2
3 Hogg RC, Raggenbass M, Bertrand D. 2003. Nicotinic acetylcholine receptors: from structure
4 to brain function. *Rev. Physiol. Biochem. Pharmacol.* 147:1-46.
5
6
7
8 Holmes A, Wellman CL. 2009. Stress-induced prefrontal reorganization and executive
9 dysfunction in rodents. *Neurosci. Biobehav. Rev.* 33:773-783.
10
11
12 Honkaniemi J, Fuxe K, Rechar L, Koistinaho J, Isola J, Gustafsson JÅ, Okret S, Pelto-Huikko.
13 M. 1992. Colocalization of fos- and glucocorticoid receptor-like immunoreactivities in the
14 rat amygdaloid complex after immobilization stress. *J. Neuroendocrinol.* 4:547-555.
15
16
17 Hoover WB, Vertes RP. 2007. Anatomical analysis of afferent projections to the medial
18 prefrontal cortex in the rat. *Brain Struct. Funct.* 212:149-179.
19
20
21
22
23
24 Hughes P, Dragunow M. 1995. Induction of immediate-early genes and the control of
25 neurotransmitter-regulated gene expression within the nervous system. *Pharmacol. Rev.*
26 47:133-178.
27
28
29
30
31 Hurst R, Rollema H, Bertrand D. 2013. Nicotinic acetylcholine receptors: From basic science
32 to therapeutics. *Pharmacol. Ther.* 137:22-54.
33
34
35
36 Imperato A, Puglisi-Allegra S, Casolini P, Angelucci L. 1991. Changes in brain dopamine and
37 acetylcholine release during and following stress are independent of the pituitary-
38 adrenocortical axis. *Brain Res.* 538:111-117.
39
40
41
42
43 Insel TR, Fernald RD. 2004. How the brain processes social information: searching for the
44 social brain. *Annu. Rev. Neurosci.* 27:697-722.
45
46
47
48 Ito A, Miyoshi M, Ueki S, Fukada M, Komaki R, Watanabe T. 2009. "Green odor" inhalation
49 by rats down-regulates stress-induced increases in Fos expression in stress-related
50 forebrain regions. *Neurosci. Res.* 65:166-174.
51
52
53
54 Janak PH, Tye KM. 2015. From circuits to behaviour in the amygdala. *Nature.* 517:284-292.
55
56
57 Kovács KJ. 1998. c-Fos as a transcription factor: a stressful (re)view from a functional map.
58 *Neurochem. Int.* 33:287-297.
59
60

- 1
2
3 Kovács KJ. 2008. Measurement of immediate-early gene activation- c-fos and beyond. J.
4
5 *Neuroendocrinol.* 20:665-672.
6
7
8 Levin ED. 2013. Complex relationships of nicotinic receptor actions and cognitive functions.
9
10 *Biochem. Pharmacol.* 86:1145-1152.
11
12 Lesburguères E, Gobbo OL, Alaux-Cantin S, Hambucken A, Trifilieff P, Bontempi B. 2011.
13
14 Early tagging of cortical networks is required for the formation of enduring associative
15
16 memory *Science*, 331:924-928.
17
18
19 Liu T, Ke J, Qi R, Zhang L, Zhang Z, Xu Q, Zhong Y, Lu G, Chen F. 2020. Altered functional
20
21 connectivity of the amygdala and its subregions in typhoon-related post-traumatic stress
22
23 disorder. *Brain Behav.* 11:e01952.
24
25
26 Lupien SJ, McEwen BS, Gunnar MR, Heim C. 2009. Effects of stress throughout the lifespan
27
28 on the brain, behaviour and cognition. *Nat. Rev. Neurosci.* 10:434-445.
29
30
31 Mark GP, Rada PV, Shors TJ. 1996. Inescapable stress enhances extracellular acetylcholine in
32
33 the rat hippocampus and prefrontal cortex but not the nucleus accumbens or amygdala.
34
35 *Neuroscience.* 74:767-774.
36
37
38 McDonald AJ. 1991. Organization of amygdaloid projections to the prefrontal cortex and
39
40 associated striatum in the rat. *Neuroscience.* 44:1-14.
41
42
43 McDonald AJ. 1998. Cortical pathways to the mammalian amygdala. *Prog. Neurobiol.* 55:257-
44
45 332.
46
47
48 McEwen BS. 2006. Protective and damaging effects of stress mediators central role of the brain.
49
50 *Dialogues Clin. Neurosci.* 8:367-381.
51
52
53 McEwen BS. 2007. Physiology and neurobiology of stress and adaptation: central role of the
54
55 brain. *Physiol. Rev.* 87:873-904.
56
57
58
59
60

- 1
2
3 McEwen BS. 2008. Central effects of stress hormones in health and disease: Understanding the
4 protective and damaging effects of stress and stress mediators. *Eur. J. Pharmacol.* 583:174-
5 185.
6
7
8
9
10 McEwen BS, Nasca C, Gray JD. 2016. Stress effects on neuronal structure: hippocampus,
11 amygdala, and prefrontal cortex. *Neuropsychopharmacology.* 41:3-23.
12
13
14 McKlveen JM, Myers B, Herman JP. 2015. The medial prefrontal cortex: coordinator of
15 autonomic, neuroendocrine and behavioural responses to stress. *J. Neuroendocrinol.*
16 27:446-456.
17
18
19
20
21 Mineur YS, Fote GM, Blakeman S, Cahuzac EL, Newbold SA, Picciotto MR. 2016. Multiple
22 nicotinic acetylcholine receptor subtypes in the mouse amygdala regulate affective
23 behaviors and response to social stress. *Neuropsychopharmacology.* 41:1579-1587.
24
25
26
27
28 Mineur YS, Picciotto MR. 2019. The role of acetylcholine in negative encoding bias: Too much
29 of a good thing? *Eur. J. Neurosci.* 00:1-12.
30
31
32
33 Moghaddam B, Homayoun H. 2008. Divergent plasticity of prefrontal cortex networks.
34 *Neuropsychopharmacology.* 33:42-55.
35
36
37
38 Mooneyham BW, Mrazek MD, Mrazek AJ, Schooler JW. 2016. Signal or noise: brain network
39 interactions underlying the experience and training of mindfulness. *Ann. N. Y. Acad. Sci.*
40 1369:240-256.
41
42
43
44 Mora F, Segovia G, Del Arco A, de Blas M, Garrido P. 2012. Stress, neurotransmitters,
45 corticosterone and body-brain integration. *Brain Res.* 1476:71-85.
46
47
48
49 Morilak DA, Barrera G, Echevarria DJ, Garcia AS, Hernandez A, Ma S, Petre CO. 2005. Role
50 of brain norepinephrine in the behavioral response to stress. *Prog. Neuropsychopharmacol.*
51 *Biol. Psychiatry.* 29:1214-1224.
52
53
54
55
56 Morgan JI, Cohen DR, Hempstead JL, Curran T. 1987. Mapping patterns of c-fos expression
57 in the central nervous system after seizure. *Science.* 237:192-197.
58
59
60

- 1
2
3 Morgan JI, Curran T. 1989. Stimulus-transcription coupling in neurons: role of cellular
4
5 immediate-early genes. *Trends Neurosci.* 12:459-462.
6
7
8 Muigg P, Scheiber S, Salchner P, Bunck M, Landgraf R, Singewald N. 2009. Differential stress-
9
10 induced neuronal activation patterns in mouse lines selectively bred for high, normal or
11
12 low anxiety. *PLoS One.* 4:e5346.
13
14
15 Muramatsu I, Masuoka T, Uwada J, Yoshiki H, Yazama T, Lee KS, Sada K, Nishio M, Ishibashi
16
17 T, Taniguchi T. 2018. A new aspect of cholinergic transmission in the central nervous
18
19 system. In: Akaike A, Shimohama S, Misu Y, editors. *Nicotinic Acetylcholine Receptor*
20
21 *Signaling in Neuroprotection* [Internet]. Singapore: Springer; Chapter 3.
22
23
24 Negrón-Oyarzo I, Aboitiz F, Fuentealba P. 2016. Impaired functional connectivity in the
25
26 prefrontal cortex: A mechanism for chronic stress-induced neuropsychiatric disorders.
27
28 *Neural. Plast.* 7539065.
29
30
31 Neves GA, Grace AA. 2019. $\alpha 7$ nicotinic receptor full agonist reverse basolateral amygdala
32
33 hyperactivity and attenuation of dopaminergic neuron activity in rats exposed to chronic
34
35 mild stress. *Eur. Neuropsychopharmacol.* 29 :1343-1353.
36
37
38 Nosjean A, Cressant A, de Chaumont F, Olivo-Marin J-C, Chauveau F, Granon S. 2015. Acute
39
40 stress in adulthood impoverishes social choices and triggers aggressiveness in preclinical
41
42 models. *Front. Behav. Neurosci.* 8:447.
43
44
45 Nosjean A, de Chaumont F, Olivo-Marin J-C, Granon S. 2018. Stress-induced brain activation:
46
47 buffering role of social behavior and neuronal nicotinic receptors. *Brain Struct. Funct.*
48
49 223:4259-4274.
50
51
52 Ofek K, Soreq H. 2013. Cholinergic involvement and manipulation approaches in multiple
53
54 system disorders. *Chem. Biol. Interact.* 203:113-199.
55
56
57
58
59
60

- 1
2
3 O'Mahony CM, Sweeney FF, Daly E, Dinan TG, Cryan JF. 2010. Restraint stress-induced brain
4
5 activation patterns in two strains of mice differing in their anxiety behaviour. *Behav. Brain.*
6
7 *Res.* 213:148-154.
8
9
10 Ossewaarde L, Qin S, Van Marle HJ, van Wingen GA, Fernández G, Hermans EJ. 2011. Stress-
11
12 induced reduction in reward-related prefrontal cortex function. *Neuroimage.* 55:345-352.
13
14 Pacák K, Palkovits M. 2001. Stressor specificity of central neuroendocrine responses:
15
16 implications for stress-related disorders. *Endocr. Rev.* 22:502-548.
17
18
19 Pallesen KJ, Brattico E, Bailey CJ, Korvenoja A, Gjedde A. 2009. Cognitive and emotional
20
21 modulation of brain default operation. *J. Cogn. Neurosci.* 21:1065-1080.
22
23
24 Patel S, Roelke CT, Rademacher DJ, Hillard CJ. 2005. Inhibition of restraint stress-induced
25
26 neural and behavioural activation by endogenous cannabinoid signaling. *Eur. J. Neurosci.*
27
28 21:1057-1069.
29
30
31 Paul S, Jeon WK, Bizon JL, Han JS. 2015. Interaction of basal forebrain cholinergic neurons
32
33 with the glucocorticoid system in stress regulation and cognitive impairment. *Front. Aging*
34
35 *Neurosci.* 7:43.
36
37
38 Paxinos G, Franklin KBJ. 2001. The mouse brain in stereotaxic coordinates. 2nd ed. New York:
39
40 N.Y. Elsevier Academic Press.
41
42
43 Pepeu G, Blandina P. 1998. The acetylcholine, GABA, glutamate triangle in the rat forebrain.
44
45 *J. Physiol. Paris.* 92:351-355.
46
47
48 Pessoa L. 2010. Emergent processes in cognitive-emotional interactions. *Dialogues Clin.*
49
50 *Neurosci.* 12:433-448.
51
52
53 Picciotto MR, Higley MJ, Mineur YS. 2012. Acetylcholine as a neuromodulator: cholinergic
54
55 signaling shapes nervous system function and behavior. *Neuron.* 76:116-129.
56
57
58
59
60

- 1
2
3 Picciotto MR, Lewis AS, van Schalkwyk GI, Mineur YS. 2015. Mood and anxiety regulation
4 by nicotinic acetylcholine receptors: A potential pathway to modulate aggression and
5 related behavioral states. *Neuropharmacology*. 96:235-243.
6
7
8
9
10 Picciotto MR, Zoli M, Lena C, Bessis A, Lallemand Y, Le Novere N, Vincent P, Pich EM,
11 Brulet P, Changeux J-P. 1995. Abnormal avoidance learning in mice lacking functional
12 high-affinity nicotine receptor in the brain. *Nature*. 374:65-67.
13
14
15
16
17 Pittaras EC, Faure A, Leray X, Moraitopoulou E, Cressant A, Rabat AA, Meunier C, Fossier P,
18 Granon S. 2016. Neuronal nicotinic receptors are crucial for tuning of E/I balance in
19 prefrontal cortex and for decision-making processes. *Front. Psychiatry*. 7:171.
20
21
22
23
24 Potasiewicz A, Hołuj M, Kos T, Popik P, Arias HR, Nikiforuk A. 2017. 3-Furan-2-yl-N-p-tolyl-
25 acrylamide, a positive allosteric modulator of the $\alpha 7$ nicotinic receptor, reverses
26 schizophrenia-like cognitive and social deficits in rats. *Neuropharmacology*. 113:188-197.
27
28
29
30 Prado VF, Janickova H, Al-Onaizi MA, Prado MA. 2017. Cholinergic circuits in cognitive
31 flexibility. *Neuroscience*. 345:130-141.
32
33
34
35
36 Radley JJ, Arias CM, Sawchenko PE. 2006. Regional differentiation of the medial prefrontal
37 cortex in regulating adaptive responses to acute emotional stress. *J. Neurosci*. 26:12967-
38 12976.
39
40
41
42
43 Radley JJ, Williams B, Sawchenko PE. 2008. Noradrenergic innervation of the dorsal medial
44 prefrontal cortex modulates hypothalamo-pituitary-adrenal responses to acute emotional
45 stress. *J. Neurosci*. 28:5806-5816.
46
47
48
49 Raichle ME, MacLeod AM, Snyder AZ, Powers WJ, Gusnard DA, Shulman GL. 2001. A
50 default mode of brain function. *Proc. Natl. Acad. Sci. U.S.A.* 98:676-682.
51
52
53
54 Raichle ME. 2015. The brain's default mode network. *Annu. Rev. Neurosci*. 38:433-447.
55
56
57
58
59
60

- 1
2
3 Reznikov LR, Reagan LP, Fadel JR. 2008. Activation of phenotypically distinct neuronal
4 subpopulations in the anterior subdivision of the rat basolateral amygdala following acute
5 and repeated stress. *J. Comp. Neurol.* 508:458-472.
6
7
8
9
10 Robbins TW, Roberts AC. 2007. Differential regulation of fronto-executive function by the
11 monoamines and acetylcholine. *Cereb. Cortex.* 17:i151-i160.
12
13
14 Rogers-Carter MM, Varela JA, Gribbons KB, Pierce AF, McGoey MT, Ritchey M,
15 Christianson JP. 2018, Insular cortex mediates approach and avoidance responses to social
16 affective stimuli. *Nat Neurosci.* 21:404-414.
17
18
19
20
21
22 Roske I, Hughes ME, Newson P, Oehme P, Chahl LA. 2002. Effect of chronic intermittent
23 immobilization stress on Fos-like immunoreactivity in rat brain and adrenal medulla.
24
25
26
27
28
29 Salas R, Fung B, Sturm R, De Biasi M. 2013. Abnormal social behavior in nicotinic
30 acetylcholine receptor $\beta 4$ subunit-null mice. *Nicotine Tob. Res.* 15:983-986.
31
32
33
34 Sciolino NR, Holmes PV. 2012. Exercise offers anxiolytic potential: a role for stress and brain
35 noradrenergic-galaninergic mechanisms. *Neurosci. Biobehav. Rev.* 36:1965-1984.
36
37
38
39 Senba E, Ueyama T. 1997. Stress-induced expression of immediate early genes in the brain and
40 peripheral organs of the rat. *Neurosci. Res.* 29:183-207.
41
42
43
44 Showers C, Cantor N. 1985. Social cognition: a look at motivated strategies. *Ann. Rev. Psychol.*
45 36:275-305.
46
47
48 Stanley DA, Adolphs R. 2013. Toward a Neural Basis for Social Behavior. *Neuron.* 80:816-
49 826.
50
51
52 Stone EA, Zhang Y, John S, Filer D, Bing G. 1993. Effect of locus coeruleus lesion on c-fos
53 expression in the cerebral cortex caused by yohimbine injection or stress. *Brain Res.*
54 603:181-185.
55
56
57
58
59
60

- 1
2
3 Tanaka T, Yokoo H, Mizoguchi K, Yoshida M, Tsuda A, Tanaka M. 1991. Noradrenaline
4 release in the rat amygdala is increased by stress: studies with intracerebral microdialysis.
5
6 *Brain Res.* 544:174-176.
7
8
9
10 Van Eden CG, Buijs RM. 2000. Functional neuroanatomy of the prefrontal cortex: autonomic
11 interactions. *Prog. Brain Res.* 126:49-62.
12
13
14 Vertes RP. 2004. Differential projections of the infralimbic and prelimbic cortex in the rat.
15
16 *Synapse.* 51:32-58.
17
18
19 Vertes RP. 2006. Interactions among the medial prefrontal cortex, hippocampus and midline
20 thalamus in emotional and cognitive processing in the rat. *Neuroscience.* 142:1-20.
21
22
23
24 Viau V, Sawchenko PE. 2002. Hypophysiotropic neurons of the paraventricular nucleus
25 respond in spatially, temporally, and phenotypically differentiated manners to acute vs.
26 repeated restraint stress: rapid publication. *J. Comp. Neurol.* 445:293-307.
27
28
29
30 Westerink BHC. 1995. Brain microdialysis and its application for the study of animal
31 behaviour. *Behav. Brain Res.* 70:103-124.
32
33
34
35 Yokoyama C, Sasaki K. 1999. Regional expressions of Fos-like immunoreactivity in rat
36 cerebral cortex after stress; restraint and intraperitoneal lipopolysaccharide. *Brain Res.*
37
38 816:267-275.
39
40
41
42 Záborszky L, Gombkoto P, Varsanyi P, Gielow MR, Poe G, Role LW, Ananth M, Rajebhosale
43 P, Talmage DA, Hasselmo ME, Dannenberg H, Mincses VH, Chiba AA. 2018. Specific
44 basal forebrain-cortical cholinergic circuits coordinate cognitive operations. *J. Neurosci.*
45
46 38:9446-9458.
47
48
49
50
51 Zangenehpour S, Chaudhuri A. 2002. Differential induction and decay curves of c-fos and
52 zif268 revealed through dual activity maps. *Brain Res. Mol. Brain Res.* 109:221-225.
53
54
55
56 Zavala JK, Fernandez AA, Gosselink KL. 2011. Female responses to acute and repeated
57 restraint stress differ from those in males. *Physiol. Behav.* 104:215-221.
58
59
60

Zhang C, Liu X, Zhou P, Zhang J, He W, Yuan TF. 2018. Cholinergic tone in ventral tegmental area: Functional organization and behavioral implications. *Neurochem. Int.* 114:127-133.

For Peer Review

Captions to figures

Fig. 1. Experimental procedures. Isolated host B6 or $\beta 2^{-/-}$ mice (IH) and B6 social visitor mice (SV) were kept in experimental room for 1 hour after their transfer from animal facility. Then, not stressed mice were immediately sacrificed for brain c-fos protein detection (control mice, **Cnt**). Mice submitted to stress alone (**S**) or stress and social task (**SESI**, i.e., stress (**S**) followed by exploration (**E**) and social interaction (**SI**)) were sacrificed either 90 min after the beginning of the stress procedure (Short delay, solid lines) or 90 min after the end of the stress or of the social interaction (Long delay, dotted lines) to allow an identical induction time of c-fos protein between **S** and **SESI** groups. **ESI** mice, i.e., not stress mice submitted to exploration and social interaction were sacrificed 90 min after the end of the social interaction (Long delay, dotted lines). IH mouse submitted to the social task was placed in the experimental box for a 30 min novelty exploration period (**E**) before to introduce a SV mouse in the box during 8 min to study mice social interactions (**SI**).

Fig. 2. Stress, social task and time effects on c-fos protein expression. A-B: Quantification of c-fos protein in the PFC and in the BLA in B6 (**A**) and $\beta 2^{-/-}$ (**B**) mice subjected to no stress and no behavior (**Cnt**), to acute stress alone (**S mice**) and to acute stress followed by social task (**SESI mice**). Mice were sacrificed either 90 min after the beginning of the stress (**S-Short** and **SESI-Short**) or 90 min after the end of the stress or of the social interaction (**S-Long** and **SESI-Long**). Histograms are means \pm SEM. Significant differences between groups are reported between bars ($0.043 \leq ps < 0.001$ for B6 mice, $0.038 \leq ps < 0.001$ for $\beta 2^{-/-}$ mice). PFC and amygdalar sub-areas were distinguished using the atlas of Paxinos and Franklin (2001). Cortical areas were considered either in their extent (from bregma +3.08 to +1.54 mm, Global PFC) or in relation to their rostral (from bregma 3.08 to 2.58 mm, Rostral PFC), median (from bregma 2.46 to 2.10 mm, Median PFC) and caudal (from bregma 1.98 to 1.54 mm, Caudal PFC) location. Letters (r, m, c) preceding the structure's name indicate respectively their rostral,

1
2
3 median or caudal level. The BLA was considered as extending from bregma -0.58 to -1.58 mm.
4
5 AI: agranular insular cortex; AID: agranular insular cortex, dorsal part; AIV: agranular insular
6
7 cortex, ventral part; BLA: basolateral amygdaloid nucleus, anterior part; Cg1: cingulate cortex,
8
9 area 1; DI: dysgranular insular cortex; DLO: dorsolateral orbital cortex; FrA: frontal association
10
11 cortex; IL: infralimbic cortex; LO: lateral orbital cortex; M1: primary motor cortex; M2:
12
13 secondary motor cortex; MO: medial orbital cortex; PrL: prelimbic cortex; S1: primary
14
15 somatosensory cortex; VO: ventral orbital cortex. **C-E:** Schematic illustrations of c-fos protein
16
17 immunoreactivity in representative coronal sections of the rostral, median and caudal PFC in
18
19 B6 and $\beta 2^{-/-}$ mice. Significant increases or decreases of protein expression are indicated by
20
21 respectively dark and light gray areas (see supplementary Tables 1a and b, 2a and b, 3a and b,
22
23 for significance of the results). Distance to bregma is pointed on the right of the coronal
24
25 sections. B6: Cnt, n = 9; S-Short, n = 6; S-Long, n = 7; SESI-Short, n = 8; SESI-Long, n = 10.
26
27 $\beta 2^{-/-}$: Cnt, n = 6; S-Short, n = 7; S-Long, n = 7; SESI-Short, n = 8; SESI-Long, n = 7.
28
29
30
31
32
33

34 **Fig. 3. Genotype effects.** $\beta 2^{-/-}$ mice were compared to B6 mice for each experimental
35
36 procedure, i.e., in control mice (**Cnt**), after a short and a long delay of c-fos protein expression
37
38 in mice subjected to stress alone (**S-Short** and **S-Long**) and to stress followed by social task
39
40 (**SESI-Short** and **SESI-Long**). Quantification (**A**) and schematic summary (**B**) of c-fos protein
41
42 expression in the PFC and in the BLA. Significant differences are indicated ($0.029 \leq ps \leq 0.001$,
43
44 see supplementary Tables 4a and b for significance of the results). In the representative coronal
45
46 sections of the rostral, median and caudal PFC and of the amygdala, light gray areas indicate
47
48 significant decreases of protein expression. Distance to bregma is reported on the right of the
49
50 coronal sections (Paxinos and Franklin, 2001). See Fig. 2 for detailed information on brain
51
52 subdivisions and brain structures abbreviations, and the number of mice used for each group.
53
54
55

56
57 **Fig. 4. Correlations between PFC sub-areas and the BLA in B6 (A) and $\beta 2^{-/-}$ mice (B)**
58
59 submitted to different experimental procedures, i.e., in control mice (**Cnt**), after short and long
60

1
2
3 delay of c-fos protein expression in mice submitted to stress alone (**S-Short** and **S-Long**) and
4 to stress and social task (**SESI-Short** and **SESI-Long**). Solid arrows indicate positive
5 correlations, bold arrow negative ones. Significant differences following Bonferroni correction
6 are indicated ($0.0000002 \leq ps \leq 0.00178$ for B6 mice, $ps = 0.0000002$ for $\beta 2^{-/-}$ mice). Dotted
7 arrows indicate correlations common to both genotypes for S-Long and SESI-Long protocols.
8 See Fig. 2 for detailed information on brain subdivisions and brain structures abbreviations, and
9 the number of mice used for each group.

10
11
12
13
14
15
16
17
18
19
20 **Fig. 5. Stress and social task effects on long term c-fos protein expression in B6 and $\beta 2^{-/-}$**
21 **mice.** Quantification (**A**) and schematic illustration (**B**) of protein expression in the PFC and in
22 the amygdala in stressed and not stressed B6 and $\beta 2^{-/-}$ mice submitted to the social task and
23 sacrificed 90 min after the end of the social interaction (**SESI-Long** and **ESI-Long**,
24 respectively). Histograms are means \pm SEM. Significant differences are indicated for each
25 genotype between stressed and not stressed mice ($0.002 \leq ps < 0.001$ for B6 mice, $ps \leq 0.001$
26 for $\beta 2^{-/-}$ mice), and between genotype for not stressed ($0.028 \leq ps < 0.006$ for ESI-Long mice)
27 and stressed mice ($0.012 \leq ps < 0.001$ for SESI-Long, see supplementary Table 5a and b for
28 significance of the results). In the representative coronal sections of the rostral, median and
29 caudal PFC and of the BLA, light gray areas indicate significant decreases of protein expression
30 and dark gray areas indicate significant increases. Distances to bregma are indicated on the right
31 of the coronal sections (Paxinos and Franklin, 2001). See Fig. 2 for detailed information on
32 brain subdivisions and brain structures abbreviations. ESI-Long mice: $n = 8$ for both genotypes,
33 SESI-Long mice: $n = 10$ B6 and $n = 7$ $\beta 2^{-/-}$ mice.

34
35
36
37
38
39
40
41
42
43
44
45
46
47
48
49
50
51
52
53
54 **Fig. 6. Correlations between PFC sub-areas and the amygdala in B6 (A) and $\beta 2^{-/-}$ mice (B)**
55 **submitted or not to acute stress and to the social task.** Mice were sacrificed 90 min after the
56 end of social interaction (**SESI-Long** and **ESI-Long**, respectively). All correlations (arrows)
57
58
59
60

1
2
3 are positive (statistical thresholds after Bonferroni correction: $0.0000002 \leq ps \leq 0.00178$ for B6
4 mice, $ps = 0.0000002$ for $\beta 2^{-/-}$ mice). Dotted arrows indicate correlations common to both
5 genotypes for S-Long and SESI-Long protocols. See Fig. 2 for detailed information on brain
6 subdivisions and brain structures abbreviations. B6: ESI-Long, n = 8; SESI-Long, n = 10. $\beta 2^{-/-}$:
7 ESI-Long, n = 8; SESI-Long, n = 7.

8
9
10
11
12
13
14
15 **Fig. 7. Schematic representation of the temporal evolution of c-fos protein expression**
16 **depending on time, behavior and emotional status (stress or not) in the PFC (left) and in**
17 **the BLA (right) in B6 and $\beta 2^{-/-}$ mice (solid and dotted lines, respectively).** C-fos protein was
18 detected 90 (short) and 180 min (Long) after stress alone and after stress coupled with the social
19 task, and 180 min after the social task without stress. Note that in the PFC, both genotypes
20 exhibited similar profiles with a peak of activity when mice were submitted to stress coupled
21 with the social task and sacrificed 90 min after the beginning of stress or when mice, submitted
22 to the social task without stress were sacrificed 180 min after the end of the social interaction.
23 By contrast, temporal profile of protein expression in the BLA totally differs between
24 genotypes.
25
26
27
28
29
30
31
32
33
34
35
36
37
38
39
40
41
42
43
44
45
46
47
48
49
50
51
52
53
54
55
56
57
58
59
60

Figure 1

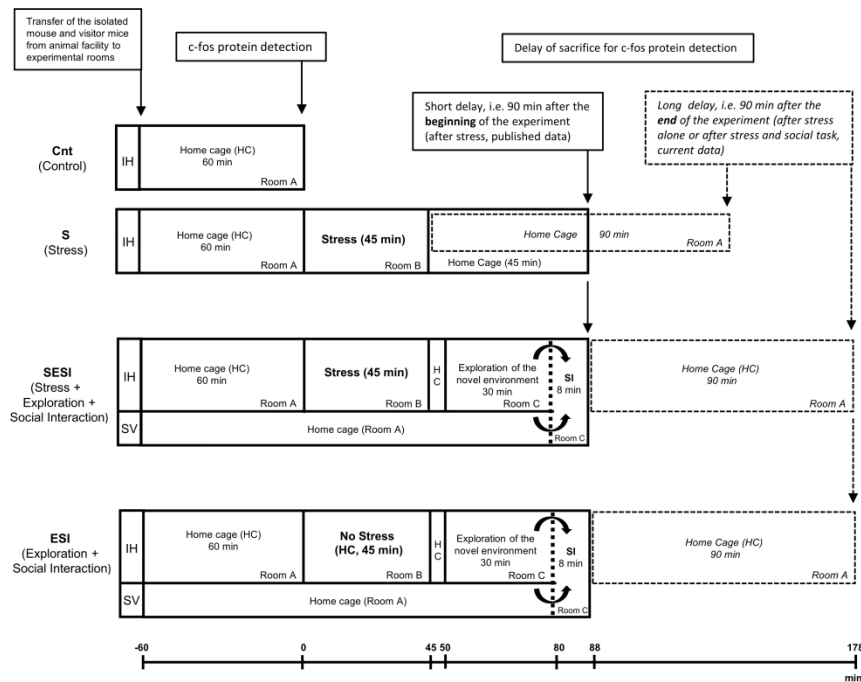

Fig. 1. Experimental procedures. Isolated host B6 or $\beta 2^{-/-}$ mice (IH) and B6 social visitor mice (SV) were kept in experimental room for 1 hour after their transfer from animal facility. Then, not stressed mice were immediately sacrificed for brain c-fos protein detection (control mice, Cnt). Mice submitted to stress alone (S) or stress and social task (SESI, i.e., stress (S) followed by exploration (E) and social interaction (SI)) were sacrificed either 90 min after the beginning of the stress procedure (Short delay, solid lines) or 90 min after the end of the stress or of the social interaction (Long delay, dotted lines) to allow an identical induction time of c-fos protein between S and SESI groups. ESI mice, i.e., not stress mice submitted to exploration and social interaction were sacrificed 90 min after the end of the social interaction (Long delay, dotted lines). IH mouse submitted to the social task was placed in the experimental box for a 30 min novelty exploration period (E) before to introduce a SV mouse in the box during 8 min to study mice social interactions (SI).

190x253mm (600 x 600 DPI)

1
2
3
4
5
6
7
8
9
10
11
12
13
14
15
16
17
18
19
20
21
22
23
24
25
26
27
28
29
30
31
32
33
34
35
36
37
38
39
40
41
42
43
44
45
46
47
48
49
50
51
52
53
54
55
56
57
58
59
60

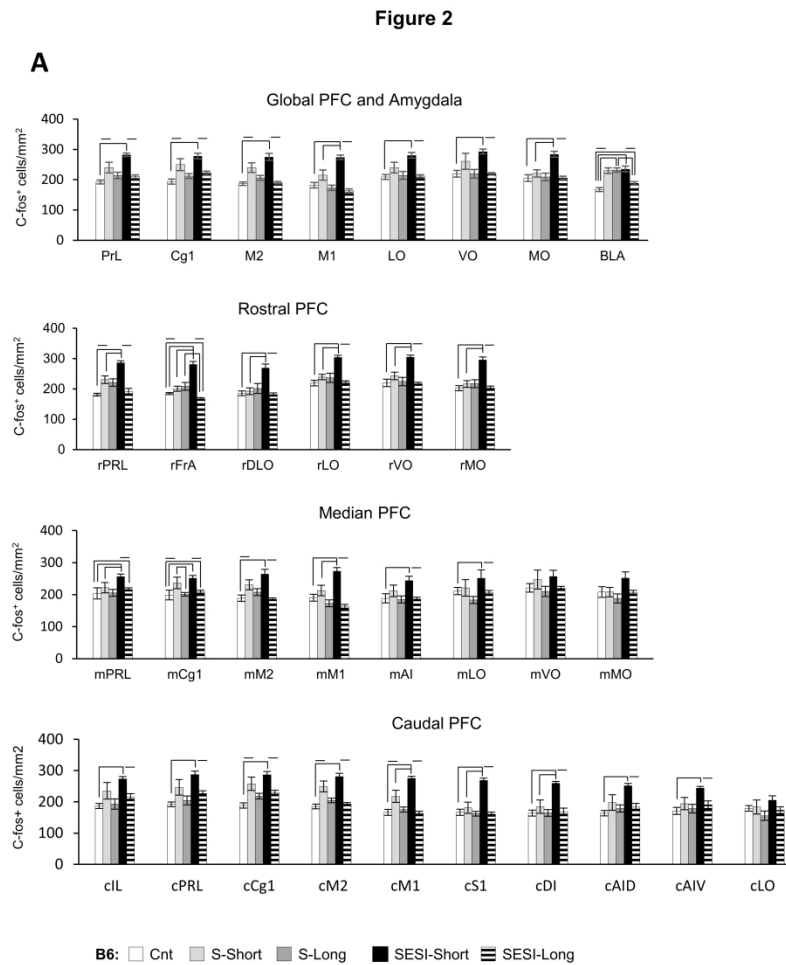

Fig. 2. Stress, social task and time effects on c-fos protein expression. A-B: Quantification of c-fos protein in the PFC and in the BLA in B6 (A) and $\beta 2^{-/-}$ (B) mice subjected to no stress and no behavior (Cnt), to acute stress alone (S mice) and to acute stress followed by social task (SESI mice). Mice were sacrificed either 90 min after the beginning of the stress (S-Short and SESI-Short) or 90 min after the end of the stress or of the social interaction (S-Long and SESI-Long). Histograms are means \pm SEM. Significant differences between groups are reported between bars ($0.043 \leq p < 0.001$ for B6 mice, $0.038 \leq p < 0.001$ for $\beta 2^{-/-}$ mice). PFC and amygdalar sub-areas were distinguished using the atlas of Paxinos and Franklin (2001). Cortical areas were considered either in their extent (from bregma +3.08 to +1.54 mm, Global PFC) or in relation to their rostral (from bregma 3.08 to 2.58 mm, Rostral PFC), median (from bregma 2.46 to 2.10 mm, Median PFC) and caudal (from bregma 1.98 to 1.54 mm, Caudal PFC) location. Letters (r, m, c) preceding the structure's name indicate respectively their rostral, median or caudal level. The BLA was considered as extending from bregma -0.58 to -1.58 mm. AI: agranular insular cortex; AID: agranular insular cortex, dorsal part; AIV: agranular insular cortex, ventral part; BLA: basolateral amygdaloid nucleus, anterior part; Cg1: cingulate cortex, area 1; DI: dysgranular insular cortex; DLO: dorsolateral orbital cortex;

1
2
3 FrA: frontal association cortex; IL: infralimbic cortex; LO: lateral orbital cortex; M1: primary motor cortex;
4 M2: secondary motor cortex; MO: medial orbital cortex; PrL: prelimbic cortex; S1: primary somatosensory
5 cortex; VO: ventral orbital cortex. C-E: Schematic illustrations of c-fos protein immunoreactivity in
6 representative coronal sections of the rostral, median and caudal PFC in B6 and $\beta 2^{-/-}$ mice. Significant
7 increases or decreases of protein expression are indicated by respectively dark and light gray areas (see
8 supplementary Tables 1a and b, 2a and b, 3a and b, for significance of the results). Distance to bregma is
9 pointed on the right of the coronal sections. B6: Cnt, n = 9; S-Short, n = 6; S-Long, n = 7; SESI-Short, n =
10 8; SESI-Long, n = 10. $\beta 2^{-/-}$: Cnt, n = 6; S-Short, n = 7; S-Long, n = 7; SESI-Short, n = 8; SESI-Long, n =
11 7.

12 190x253mm (600 x 600 DPI)

13
14
15
16
17
18
19
20
21
22
23
24
25
26
27
28
29
30
31
32
33
34
35
36
37
38
39
40
41
42
43
44
45
46
47
48
49
50
51
52
53
54
55
56
57
58
59
60

Figure 2

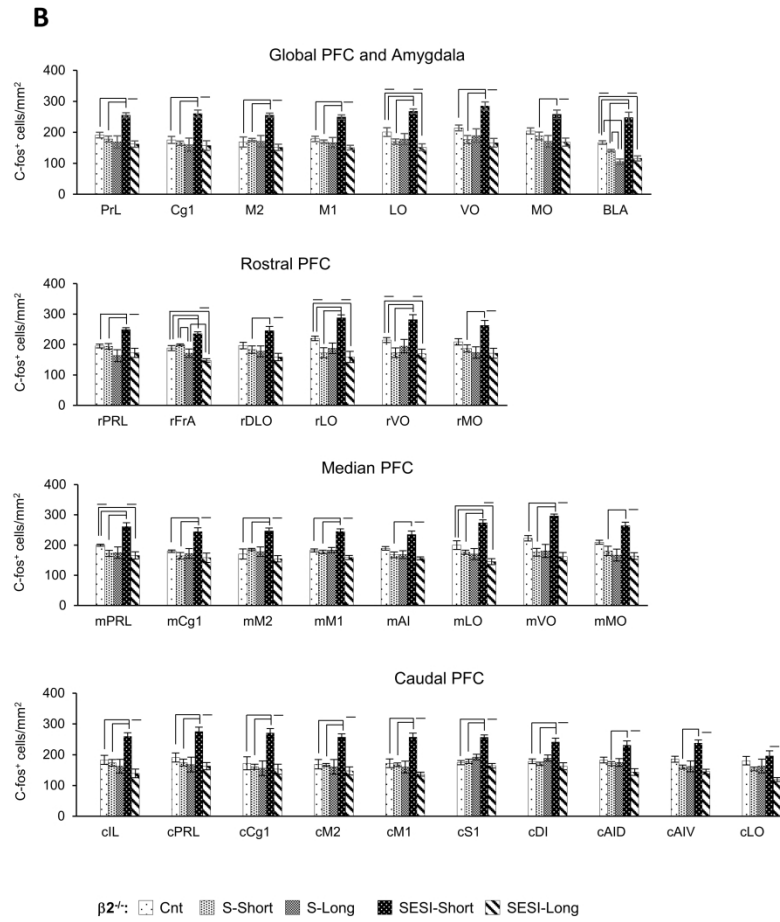

190x253mm (600 x 600 DPI)

1
2
3
4
5
6
7
8
9
10
11
12
13
14
15
16
17
18
19
20
21
22
23
24
25
26
27
28
29
30
31
32
33
34
35
36
37
38
39
40
41
42
43
44
45
46
47
48
49
50
51
52
53
54
55
56
57
58
59
60

Figure 2

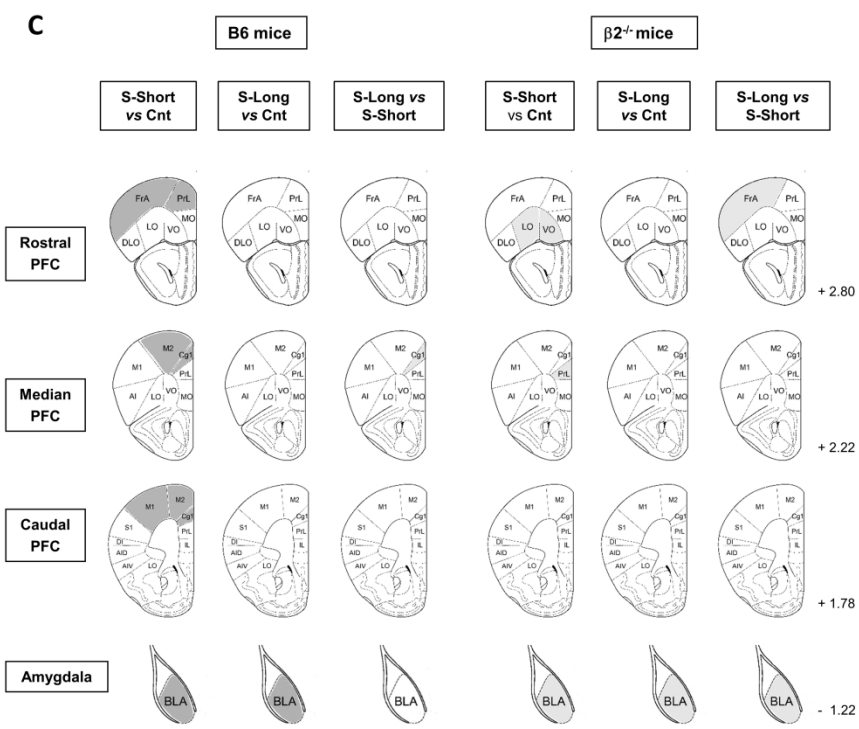

190x253mm (600 x 600 DPI)

Figure 2

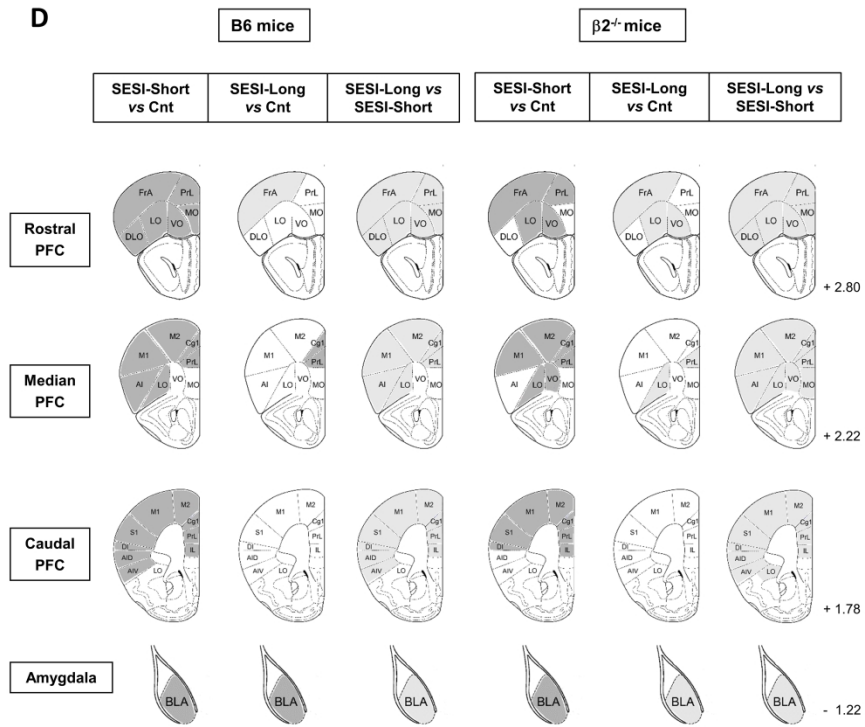

190x253mm (600 x 600 DPI)

1
2
3
4
5
6
7
8
9
10
11
12
13
14
15
16
17
18
19
20
21
22
23
24
25
26
27
28
29
30
31
32
33
34
35
36
37
38
39
40
41
42
43
44
45
46
47
48
49
50
51
52
53
54
55
56
57
58
59
60

1
2
3
4
5
6
7
8
9
10
11
12
13
14
15
16
17
18
19
20
21
22
23
24
25
26
27
28
29
30
31
32
33
34
35
36
37
38
39
40
41
42
43
44
45
46
47
48
49
50
51
52
53
54
55
56
57
58
59
60

Figure 2

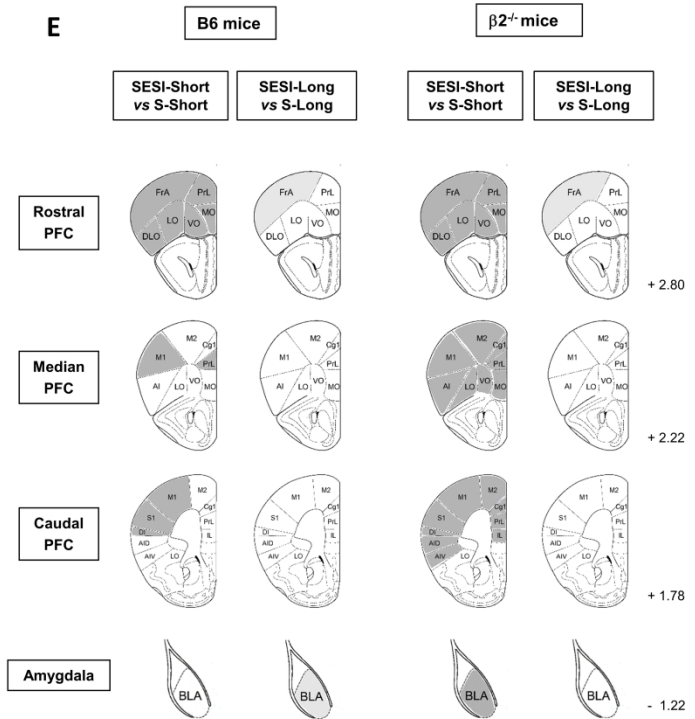

190x253mm (600 x 600 DPI)

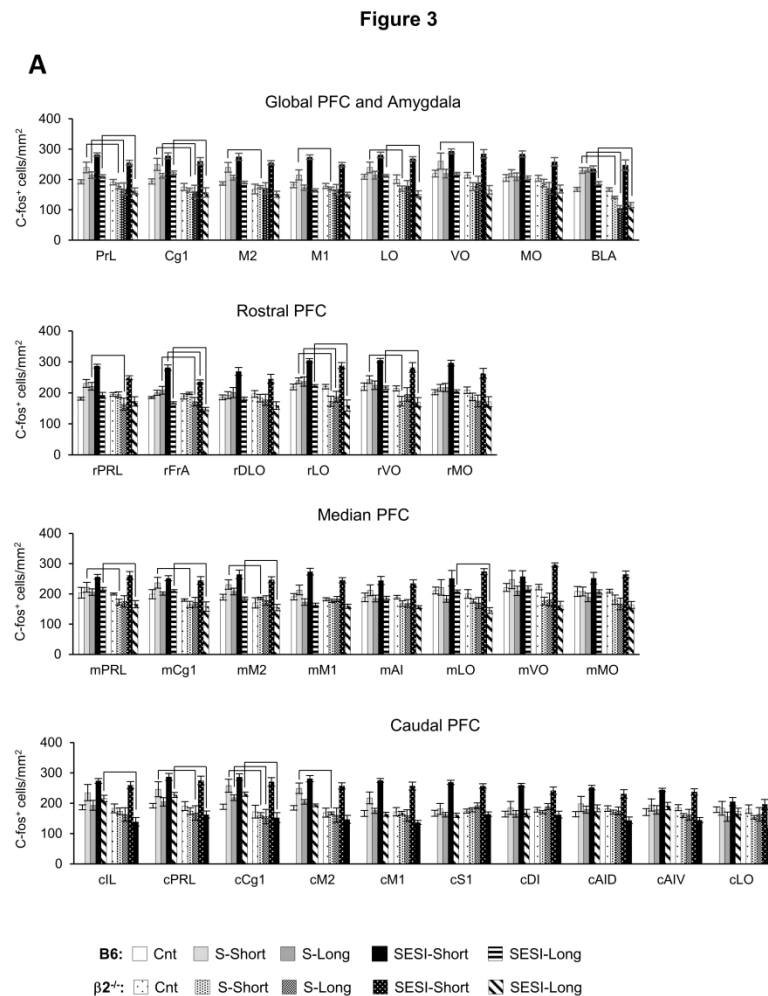
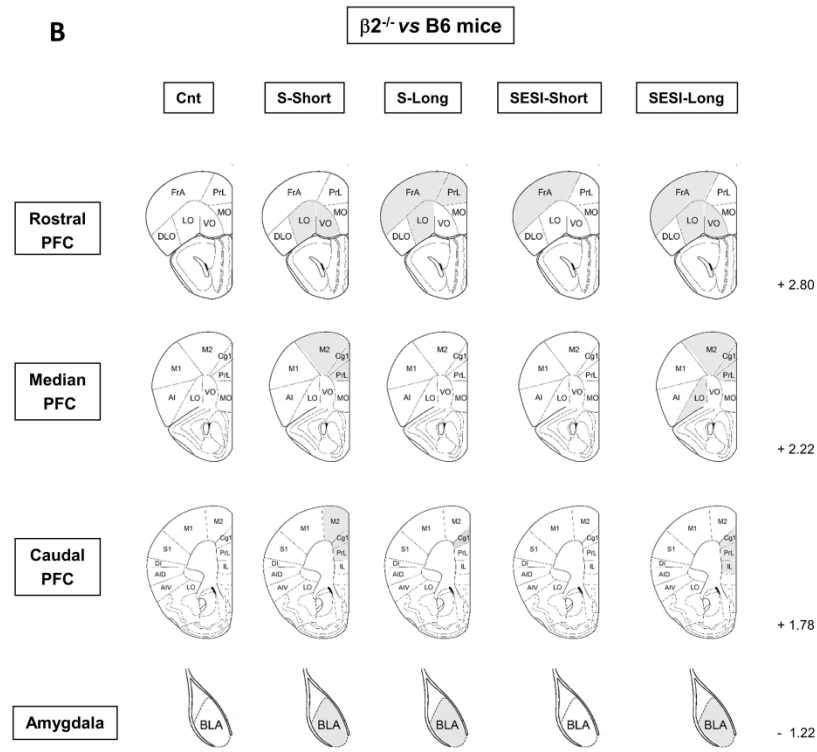

Fig. 3. Genotype effects. $\beta 2^{-/-}$ mice were compared to B6 mice for each experimental procedure, i.e., in control mice (Cnt), after a short and a long delay of c-fos protein expression in mice subjected to stress alone (S-Short and S-Long) and to stress followed by social task (SESI-Short and SESI-Long). Quantification (A) and schematic summary (B) of c-fos protein expression in the PFC and in the BLA. Significant differences are indicated ($0.029 \leq p \leq 0.001$, see supplementary Tables 4a and b for significance of the results). In the representative coronal sections of the rostral, median and caudal PFC and of the amygdala, light gray areas indicate significant decreases of protein expression. Distance to bregma is reported on the right of the coronal sections (Paxinos and Franklin, 2001). See Fig. 2 for detailed information on brain subdivisions and brain structures abbreviations, and the number of mice used for each group.

190x253mm (600 x 600 DPI)

1
2
3
4
5
6
7
8
9
10
11
12
13
14
15
16
17
18
19
20
21
22
23
24
25
26
27
28
29
30
31
32
33
34
35
36
37
38
39
40
41
42
43
44
45
46
47
48
49
50
51
52
53
54
55
56
57
58
59
60

Figure 3



190x253mm (600 x 600 DPI)

Figure 4

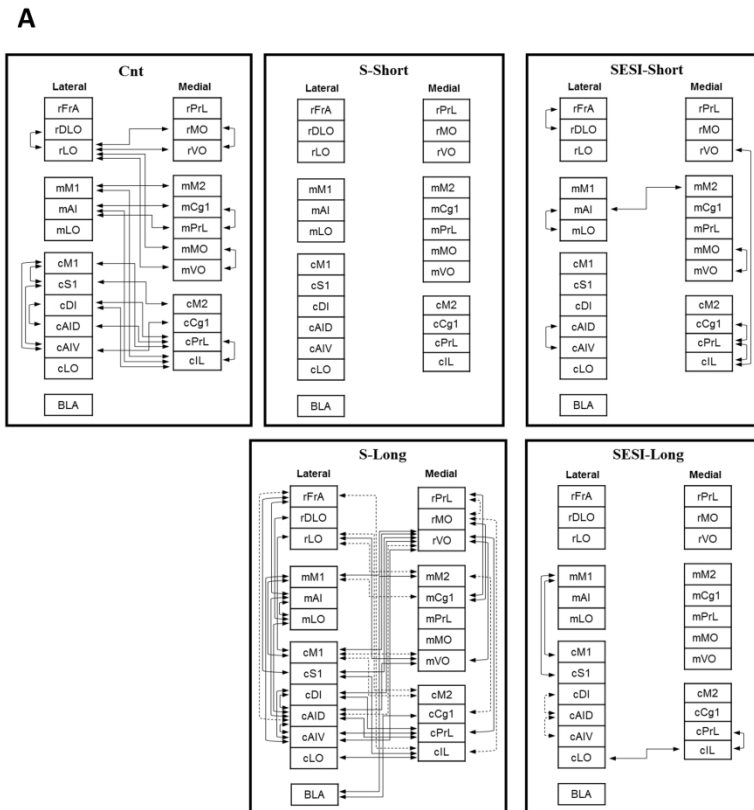
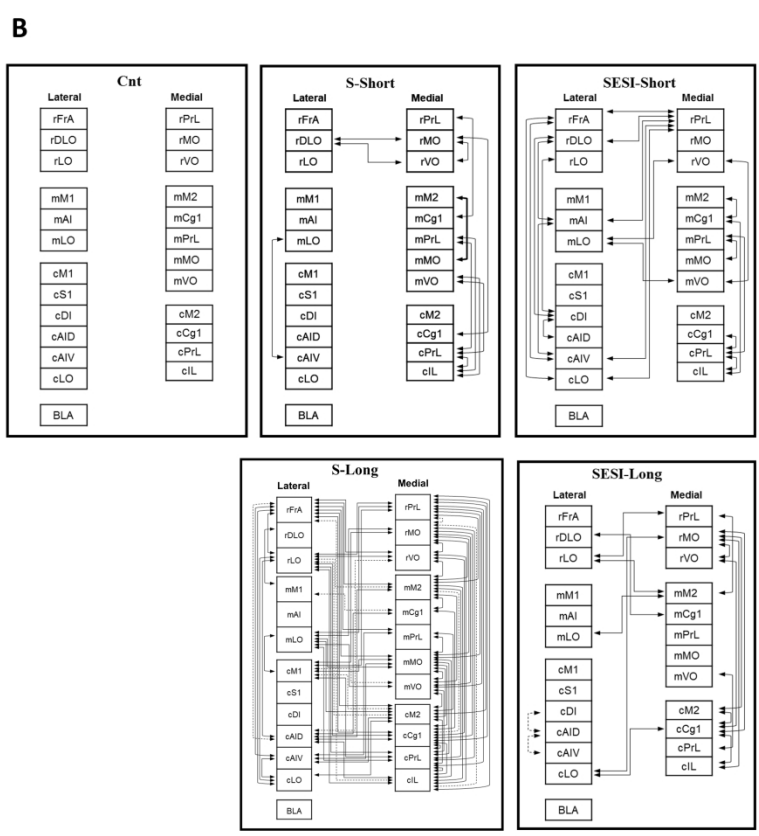

Fig. 4. Correlations between PFC sub-areas and the BLA in B6 (A) and $\beta 2^{-/-}$ mice (B) submitted to different experimental procedures, i.e., in control mice (Cnt), after short and long delay of *c-fos* protein expression in mice submitted to stress alone (S-Short and S-Long) and to stress and social task (SESI-Short and SESI-Long). Solid arrows indicate positive correlations, bold arrow negative ones. Significant differences following Bonferroni correction are indicated ($0.0000002 \leq p_s \leq 0.00178$ for B6 mice, $p_s = 0.0000002$ for $\beta 2^{-/-}$ mice). Dotted arrows indicate correlations common to both genotypes for S-Long and SESI-Long protocols. See Fig. 2 for detailed information on brain subdivisions and brain structures abbreviations, and the number of mice used for each group.

190x253mm (600 x 600 DPI)

1
2
3
4
5
6
7
8
9
10
11
12
13
14
15
16
17
18
19
20
21
22
23
24
25
26
27
28
29
30
31
32
33
34
35
36
37
38
39
40
41
42
43
44
45
46
47
48
49
50
51
52
53
54
55
56
57
58
59
60

Figure 4



190x253mm (600 x 600 DPI)

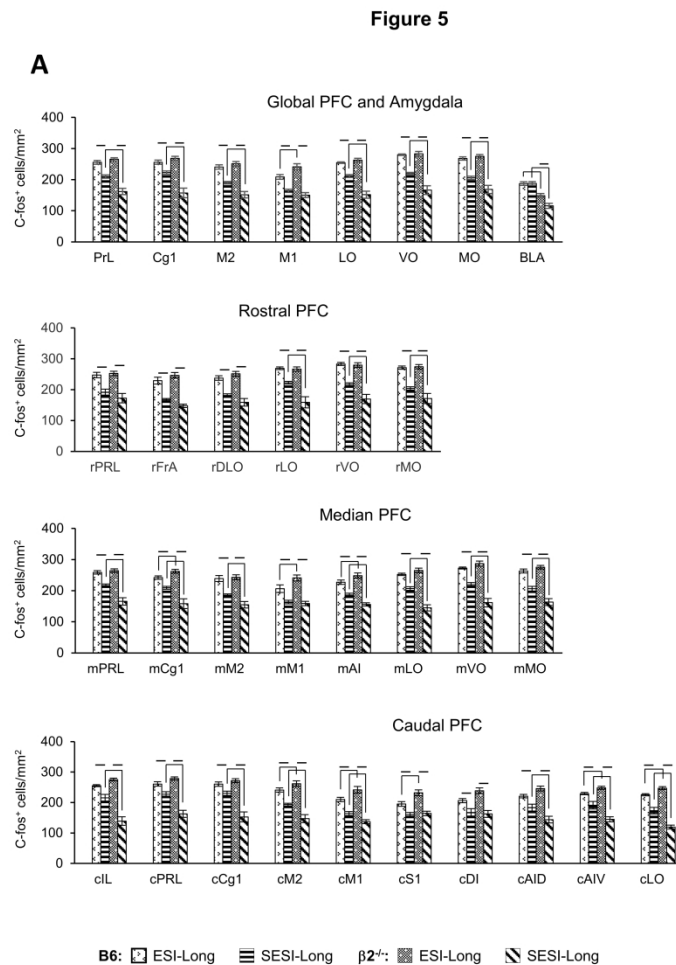
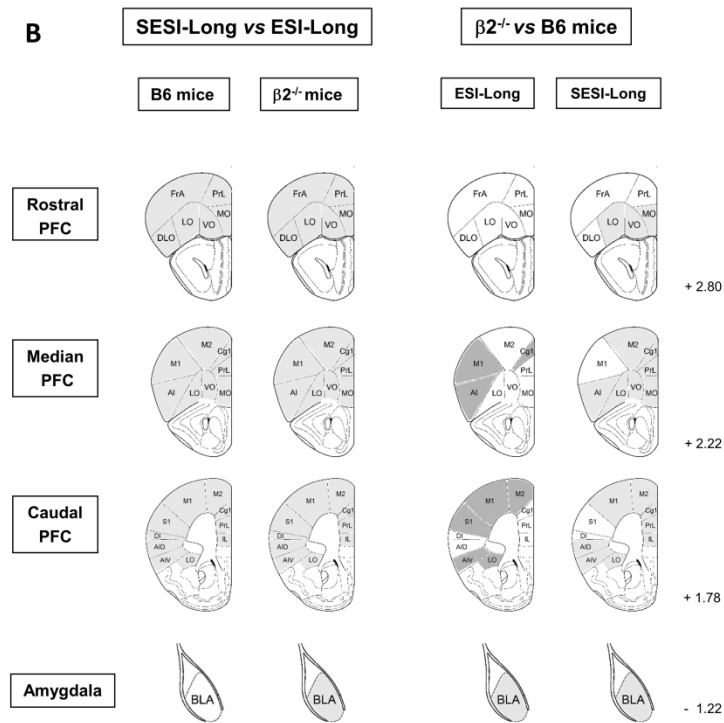

Fig. 5. Stress and social task effects on long term c-fos protein expression in B6 and $\beta 2^{-/-}$ mice. Quantification (A) and schematic illustration (B) of protein expression in the PFC and in the amygdala in stressed and not stressed B6 and $\beta 2^{-/-}$ mice submitted to the social task and sacrificed 90 min after the end of the social interaction (SESI-Long and ESI-Long, respectively). Histograms are means \pm SEM. Significant differences are indicated for each genotype between stressed and not stressed mice ($0.002 \leq p < 0.001$ for B6 mice, $p \leq 0.001$ for $\beta 2^{-/-}$ mice), and between genotype for not stressed ($0.028 \leq p < 0.006$ for ESI-Long mice) and stressed mice ($0.012 \leq p < 0.001$ for SESI-Long, see supplementary Table 5a and b for significance of the results). In the representative coronal sections of the rostral, median and caudal PFC and of the BLA, light gray areas indicate significant decreases of protein expression and dark gray areas indicate significant increases. Distances to bregma are indicated on the right of the coronal sections (Paxinos and Franklin, 2001). See Fig. 2 for detailed information on brain subdivisions and brain structures abbreviations. ESI-Long mice: $n = 8$ for both genotypes, SESI-Long mice: $n = 10$ B6 and $n = 7$ $\beta 2^{-/-}$ mice.

- 1
- 2
- 3
- 4
- 5
- 6
- 7
- 8
- 9
- 10
- 11
- 12
- 13
- 14
- 15
- 16
- 17
- 18
- 19
- 20
- 21
- 22
- 23
- 24
- 25
- 26
- 27
- 28
- 29
- 30
- 31
- 32
- 33
- 34
- 35
- 36
- 37
- 38
- 39
- 40
- 41
- 42
- 43
- 44
- 45
- 46
- 47
- 48
- 49
- 50
- 51
- 52
- 53
- 54
- 55
- 56
- 57
- 58
- 59
- 60

190x253mm (600 x 600 DPI)

Figure 5



190x253mm (600 x 600 DPI)

Figure 6.

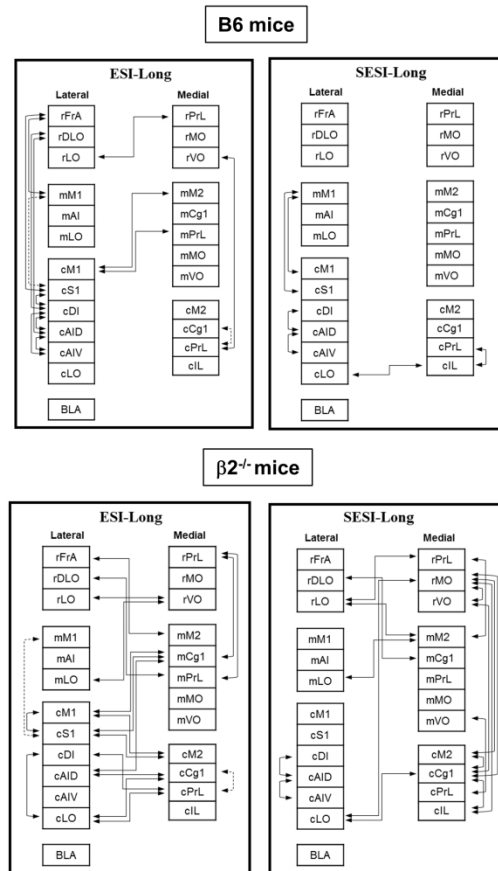

Fig. 6. Correlations between PFC sub-areas and the amygdala in B6 (A) and $\beta 2^{-/-}$ mice (B) submitted or not to acute stress and to the social task. Mice were sacrificed 90 min after the end of social interaction (SESI-Long and ESI-Long, respectively). All correlations (arrows) are positive (statistical thresholds after Bonferroni correction: $0.0000002 \leq p \leq 0.00178$ for B6 mice, $p \leq 0.0000002$ for $\beta 2^{-/-}$ mice). Dotted arrows indicate correlations common to both genotypes for S-Long and SESI-Long protocols. See Fig. 2 for detailed information on brain subdivisions and brain structures abbreviations. B6: ESI-Long, $n = 8$; SESI-Long, $n = 10$. $\beta 2^{-/-}$: ESI-Long, $n = 8$; SESI-Long, $n = 7$.

190x253mm (600 x 600 DPI)

Figure 7

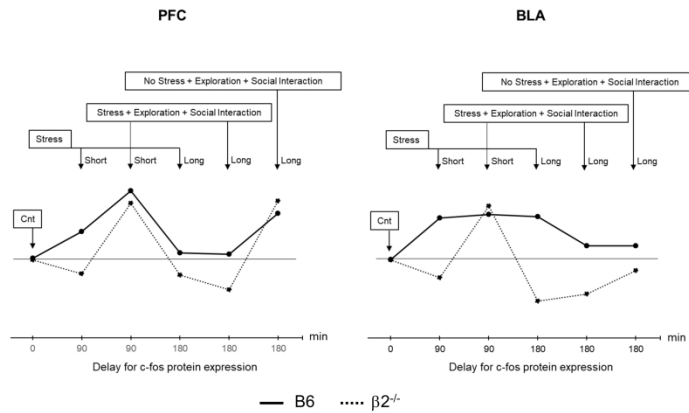

Fig. 7. Schematic representation of the temporal evolution of c-fos protein expression depending on time, behavior and emotional status (stress or not) in the PFC (left) and in the BLA (right) in B6 and $\beta 2^{-/-}$ mice (solid and dotted lines, respectively). C-fos protein was detected 90 (short) and 180 min (Long) after stress alone and after stress coupled with the social task, and 180 min after the social task without stress. Note that in the PFC, both genotypes exhibited similar profiles with a peak of activity when mice were submitted to stress coupled with the social task and sacrificed 90 min after the beginning of stress or when mice, submitted to the social task without stress were sacrificed 180 min after the end of the social interaction. By contrast, temporal profile of protein expression in the BLA totally differs between genotypes.

190x253mm (600 x 600 DPI)

Supplementary Table 1a

	Statistical analysis between 10 groups			S-Short vs Cnt		S-Long vs Cnt		S-Long vs S-Short	
				B6	$\beta 2^{-/-}$	B6	$\beta 2^{-/-}$	B6	$\beta 2^{-/-}$
	F or H	<i>p</i>	Subsequent test	<i>p</i>	<i>p</i>	<i>p</i>	<i>p</i>	<i>p</i>	<i>p</i>
Global PFC									
PrL	F(9,65) = 16.553	< 0.001	HS	0.030	0.917	0.763	0.796	0.718	0.937
Cg1	F(9,65) = 15.582	< 0.001	HS	0.021	0.951	0.946	0.954	0.407	0.940
M2	F(9,65) = 18.383	< 0.001	HS	0.007	0.988	0.889	0.878	0.339	0.989
M1	F(9,65) = 22.532	< 0.001	HS	0.219	0.996	0.997	0.995	0.059	0.822
LO	H = 52.467, df = 9	< 0.001	MW	0.112	0.035	0.832	0.234	0.138	0.710
VO	F(9,65) = 11.497	< 0.001	HS	0.404	0.625	0.997	0.937	0.482	0.998
MO	F(9,65) = 10.622	< 0.001	HS	0.993	0.992	1.000	0.675	0.996	0.988
Amygdala									
BLA	H = 36.143, df = 9	< 0.001	MW	0.002	0.008	0.001	0.001	1.000	0.007

Supplementary Table 1b

Statistical analysis between 10 groups				S-Short vs Cnt		S-Long vs Cnt		S-Long vs S-Short	
				B6	$\beta 2^{-/-}$	B6	$\beta 2^{-/-}$	B6	$\beta 2^{-/-}$
	F or H	<i>p</i>	Subsequent test	<i>p</i>	<i>p</i>	<i>p</i>	<i>p</i>	<i>p</i>	<i>p</i>
Rostral PFC									
rPrL	$F_{(9,65)} = 15.010$	< 0.001	HS	0.030	0.949	0.120	0.540	0.959	0.544
rFrA	$H = 57.449, df = 9$	< 0.001	MW	0.022	0.295	0.072	0.101	1.000	0.026
rDLO	$F_{(9,65)} = 9.010$	< 0.001	HS	1.000	1.000	0.998	0.998	1.000	1.000
rLO	$H = 53.706, df = 9$	< 0.001	MW	0.316	0.005	0.751	0.138	0.534	0.456
rVO	$H = 46.088, df = 9$	< 0.001	MW	0.216	0.035	0.832	0.445	0.366	0.318
rMO	$F_{(9,65)} = 11.936$	< 0.001	HS	0.995	0.980	0.997	0.666	0.960	0.994
Median PFC									
mPrL	$H = 43.911, df = 9$	< 0.001	MW	0.087	0.022	0.397	0.234	0.534	0.902
mCg1	$H = 48.526, df = 9$	< 0.001	MW	0.029	0.295	0.244	0.534	0.022	1.000
mM2	$H = 45.939, df = 9$	< 0.001	MW	0.022	0.731	0.169	1.000	0.181	0.620
mM1	$F_{(9,65)} = 19.382$	< 0.001	HS	0.788	0.977	0.901	0.933	0.092	0.994
mAI	$F_{(9,65)} = 7.448$	< 0.001	HS	0.942	0.966	1.000	0.965	0.894	0.997
mLO	$H = 40.675, df = 9$	< 0.001	MW	0.953	0.051	0.138	0.101	0.181	0.805
mVO	$F_{(9,65)} = 8.243$	< 0.001	HS	0.939	0.575	0.997	0.666	0.795	0.999
mMO	$F_{(9,65)} = 6.193$	< 0.001	HS	0.998	0.968	0.993	0.619	0.992	0.999
Caudal PFC									
cIL	$F_{(9,65)} = 10.503$	< 0.001	HS	0.278	0.954	0.927	0.967	0.562	0.986
cPrL	$F_{(9,65)} = 11.498$	< 0.001	HS	0.135	0.986	0.983	0.963	0.559	0.983
cCg1	$F_{(9,65)} = 14.671$	< 0.001	HS	0.012	0.962	0.778	0.978	0.575	0.967
cM2	$F_{(9,65)} = 14.671$	< 0.001	HS	0.003	0.877	0.915	0.977	0.173	0.918
cM1	$F_{(9,65)} = 19.667$	< 0.001	HS	0.029	1.000	1.000	1.000	0.202	1.000
cS1	$F_{(9,65)} = 24.159$	< 0.001	HS	0.994	1.000	1.000	0.976	0.967	0.992
cDI	$F_{(9,65)} = 11.341$	< 0.001	HS	0.993	1.000	0.969	1.000	0.996	0.995
cAID	$F_{(9,65)} = 8.254$	< 0.001	HS	0.657	0.999	0.998	0.999	0.657	0.994
cAIV	$F_{(9,65)} = 8.319$	< 0.001	HS	0.960	0.954	0.998	0.967	0.996	0.890
cLO	$F_{(9,65)} = 3.414$	< 0.001	HS	0.999	0.993	0.994	0.999	0.992	0.999

Supplementary Table 2a

Statistical analysis between 10 groups				SESI-Short vs Cnt		SESI-Long vs Cnt		SESI-Long vs SESI-Short	
				B6	$\beta 2^{-/-}$	B6	$\beta 2^{-/-}$	B6	$\beta 2^{-/-}$
F or H	<i>p</i>	Subsequent test	<i>p</i>	<i>p</i>	<i>p</i>	<i>p</i>	<i>p</i>	<i>p</i>	
Global PFC									
PrL	$F_{(9,65)} = 16.553$	< 0.001	HS	<0.001	<0.001	0.807	0.573	<0.001	<0.001
Cg1	$F_{(9,65)} = 15.582$	< 0.001	HS	<0.001	<0.001	0.458	0.931	0.008	<0.001
M2	$F_{(9,65)} = 18.383$	< 0.001	HS	<0.001	<0.001	0.951	0.916	<0.001	<0.001
M1	$F_{(9,65)} = 22.532$	< 0.001	HS	<0.001	<0.001	0.876	0.545	<0.001	<0.001
LO	$H = 52.467, df = 9$	< 0.001	MW	<0.001	<0.001	0.967	0.035	<0.001	<0.001
VO	$F_{(9,65)} = 11.497$	< 0.001	HS	0.002	0.011	1.000	0.312	0.001	<0.001
MO	$F_{(9,65)} = 10.622$	< 0.001	HS	<0.001	0.052	0.997	0.576	<0.001	<0.001
Amygdala									
BLA	$H = 36.143, df = 9$	< 0.001	MW	<0.001	<0.001	0.030	0.001	<0.001	<0.001

Supplementary Table 2b

Statistical analysis between 10 groups				SESI-Short vs Cnt		SESI -Long vs Cnt		SESI-Long vs SESI-Short	
				B6	$\beta 2^{-/-}$	B6	$\beta 2^{-/-}$	B6	$\beta 2^{-/-}$
	F or H	<i>p</i>	Subsequent test	<i>p</i>	<i>p</i>	<i>p</i>	<i>p</i>	<i>p</i>	<i>p</i>
Rostral PFC									
rPrL	$F_{(9,65)} = 15.010$	< 0.001	HS	<0.001	0.015	0.967	0.888	<0.001	<0.001
rFrA	$H = 57.449, df = 9$	< 0.001	MW	<0.001	0.001	0.002	0.002	<0.001	<0.001
rDLO	$F_{(9,65)} = 9.010$	< 0.001	HS	<0.001	0.142	1.000	0.597	<0.001	<0.001
rLO	$H = 53.706, df = 9$	< 0.001	MW	<0.001	<0.001	0.775	0.005	<0.001	<0.001
rVO	$H = 46.088, df = 9$	< 0.001	MW	<0.001	0.008	0.307	0.005	<0.001	<0.001
rMO	$F_{(9,65)} = 11.936$	< 0.001	HS	<0.001	0.063	0.988	0.584	<0.001	<0.001
Median PFC									
mPrL	$H = 43.911, df = 9$	< 0.001	MW	0.008	<0.001	0.037	0.005	0.001	<0.001
mCg1	$H = 48.526, df = 9$	< 0.001	MW	0.008	0.001	0.045	0.234	<0.001	<0.001
mM2	$H = 45.939, df = 9$	< 0.001	MW	0.002	0.001	0.838	0.295	<0.001	<0.001
mM1	$F_{(9,65)} = 19.382$	< 0.001	HS	<0.001	<0.001	0.309	0.781	<0.001	<0.001
mAI	$F_{(9,65)} = 7.448$	< 0.001	HS	0.007	0.142	1.000	0.687	0.003	<0.001
mLO	$H = 40.675, df = 9$	< 0.001	MW	0.030	0.001	0.775	0.014	0.011	<0.001
mVO	$F_{(9,65)} = 8.243$	< 0.001	HS	0.659	0.027	0.994	0.173	0.614	<0.001
mMO	$F_{(9,65)} = 6.193$	< 0.001	HS	0.397	0.208	1.000	0.565	0.294	<0.001
Caudal PFC									
cIL	$F_{(9,65)} = 10.503$	< 0.001	HS	<0.001	0.008	0.785	0.506	0.038	<0.001
cPrL	$F_{(9,65)} = 11.498$	< 0.001	HS	<0.001	0.002	0.559	0.921	0.023	<0.001
cCg1	$F_{(9,65)} = 14.671$	< 0.001	HS	<0.001	<0.001	0.232	0.983	0.036	<0.001
cM2	$F_{(9,65)} = 14.671$	< 0.001	HS	<0.001	<0.001	0.982	0.917	<0.001	<0.001
cM1	$F_{(9,65)} = 19.667$	< 0.001	HS	<0.001	<0.001	0.995	0.480	<0.001	<0.001
cS1	$F_{(9,65)} = 24.159$	< 0.001	HS	<0.001	<0.001	1.000	0.998	<0.001	<0.001
cDI	$F_{(9,65)} = 11.341$	< 0.001	HS	<0.001	0.004	1.000	0.999	<0.001	<0.001
cAID	$F_{(9,65)} = 8.254$	< 0.001	HS	<0.001	0.145	0.539	0.539	<0.001	<0.001
cAIV	$F_{(9,65)} = 8.319$	< 0.001	HS	<0.001	0.081	0.961	0.439	0.021	<0.001
cLO	$F_{(9,65)} = 3.414$	< 0.001	HS	0.985	0.999	0.998	0.117	0.874	0.004

Supplementary Table 3a

	Statistical analysis between 10 groups			SESI-Short vs S-Short		SESI-Long vs S-Long	
				B6	$\beta 2^{-/-}$	B6	$\beta 2^{-/-}$
	F or H	<i>p</i>	Subsequent test	<i>p</i>	<i>p</i>	<i>p</i>	<i>p</i>
Global PFC							
PrL	$F_{(9,65)} = 16.553$	< 0.001	HS	0.085	<0.001	0.934	0.949
Cg1	$F_{(9,65)} = 15.582$	< 0.001	HS	0.700	<0.001	0.978	0.877
M2	$F_{(9,65)} = 18.383$	< 0.001	HS	0.281	<0.001	0.929	0.891
M1	$F_{(9,65)} = 22.532$	< 0.001	HS	<0.001	<0.001	0.997	0.972
LO	$H = 52.467, df = 9$	< 0.001	MW	0.081	<0.001	0.591	0.456
VO	$F_{(9,65)} = 11.497$	< 0.001	HS	0.755	<0.001	1.000	0.908
MO	$F_{(9,65)} = 10.622$	< 0.001	HS	0.010	0.001	1.000	1.000
Amygdala							
BLA	$H = 36.143, df = 9$	< 0.001	MW	1.000	<0.001	0.002	0.535

Supplementary Table 3b

	Statistical analysis between 10 groups			SESI-Short vs S-Short		SESI-Long vs S-Long	
				B6	$\beta 2^{-/-}$	B6	$\beta 2^{-/-}$
	F or H	<i>p</i>	Subsequent test	<i>p</i>	<i>p</i>	<i>p</i>	<i>p</i>
Rostral PFC							
rPrL	$F_{(9,65)} = 15.010$	< 0.001	HS	0.010	0.008	0.515	0.979
rFrA	$H = 57.449, df = 9$	< 0.001	MW	<0.001	<0.001	0.002	0.038
rDLO	$F_{(9,65)} = 9.010$	< 0.001	HS	<0.001	0.008	0.991	0.998
rLO	$H = 53.706, df = 9$	< 0.001	MW	<0.001	<0.001	0.526	0.456
rVO	$H = 46.088, df = 9$	< 0.001	MW	<0.001	0.002	0.884	0.456
rMO	$F_{(9,65)} = 11.936$	< 0.001	HS	<0.001	<0.001	0.993	0.998
Median PFC							
mPrL	$H = 43.911, df = 9$	< 0.001	MW	0.043	<0.001	0.464	0.902
mCg1	$H = 48.526, df = 9$	< 0.001	MW	0.142	<0.001	0.188	0.710
mM2	$H = 45.939, df = 9$	< 0.001	MW	0.081	<0.001	0.130	0.318
mM1	$F_{(9,65)} = 19.382$	< 0.001	HS	<0.001	<0.001	0.993	0.694
mAI	$F_{(9,65)} = 7.448$	< 0.001	HS	0.690	0.001	0.999	0.996
mLO	$H = 40.675, df = 9$	< 0.001	MW	0.228	<0.001	0.107	0.318
mVO	$F_{(9,65)} = 8.243$	< 0.001	HS	0.992	<0.001	0.997	0.989
mMO	$F_{(9,65)} = 6.193$	< 0.001	HS	0.551	0.002	0.992	1.000
Caudal PFC							
cIL	$F_{(9,65)} = 10.503$	< 0.001	HS	0.658	<0.001	0.953	0.942
cPrL	$F_{(9,65)} = 11.498$	< 0.001	HS	0.567	<0.001	0.934	0.954
cCg1	$F_{(9,65)} = 14.671$	< 0.001	HS	0.819	<0.001	0.984	0.867
cM2	$F_{(9,65)} = 14.671$	< 0.001	HS	0.611	<0.001	0.972	0.970
cM1	$F_{(9,65)} = 19.667$	< 0.001	HS	0.012	<0.001	0.999	0.920
cS1	$F_{(9,65)} = 24.159$	< 0.001	HS	<0.001	<0.001	0.875	0.477
cDI	$F_{(9,65)} = 11.341$	< 0.001	HS	<0.001	<0.001	1.000	0.931
cAID	$F_{(9,65)} = 8.254$	< 0.001	HS	0.062	0.014	0.999	0.803
cAIV	$F_{(9,65)} = 8.319$	< 0.001	HS	0.122	<0.001	0.995	0.995
cLO	$F_{(9,65)} = 3.414$	< 0.001	HS	0.998	0.599	0.999	0.604

Supplementary Table 4a

	Statistical analysis between 10 groups			$\beta 2^{-/-}$ vs B6				
				Cnt	S-Short	S-Long	SESI-Short	SESI-Long
	F or H	<i>p</i>	Subsequent test	<i>p</i>	<i>p</i>	<i>p</i>	<i>p</i>	<i>p</i>
Global PFC								
PrL	$F_{(9,65)} = 16.553$	< 0.001	HS	0.916	0.003	0.049	0.527	0.013
Cg1	$F_{(9,65)} = 15.582$	< 0.001	HS	0.937	<0.001	0.048	0.937	0.001
M2	$F_{(9,65)} = 18.383$	< 0.001	HS	0.915	<0.001	0.291	0.893	0.093
M1	$F_{(9,65)} = 22.532$	< 0.001	HS	0.992	0.029	0.997	0.602	0.976
LO	$H = 52.467, df = 9$	< 0.001	MW	0.953	0.001	0.097	0.382	<0.001
VO	$F_{(9,65)} = 11.497$	< 0.001	HS	1.000	0.002	0.779	0.999	0.075
MO	$F_{(9,65)} = 10.622$	< 0.001	HS	0.949	0.702	0.430	0.838	0.348
Amygdala								
BLA	$H = 36.143, df = 9$	< 0.001	MW	0.680	0.001	<0.001	0.574	<0.001

Supplementary Table 4b

Statistical analysis between 10 groups				$\beta 2^{-/-}$ vs B6				
				Cnt	S-Short	S-Long	SESI-Short	SESI-Long
	F or H	<i>p</i>	Subsequent test	<i>p</i>	<i>p</i>	<i>p</i>	<i>p</i>	<i>p</i>
Rostral PFC								
rPrL	$F_{(9,65)} = 15.010$	< 0.001	HS	0.976	0.364	0.006	0.179	0.860
rFrA	$H = 57.449, df = 9$	< 0.001	MW	0.517	0.731	0.038	<0.001	0.017
rDLO	$F_{(9,65)} = 9.010$	< 0.001	HS	1.000	1.000	0.978	0.969	0.977
rLO	$H = 53.706, df = 9$	< 0.001	MW	0.768	0.001	0.038	0.105	0.003
rVO	$H = 46.088, df = 9$	< 0.001	MW	0.517	0.008	0.318	0.195	<0.001
rMO	$F_{(9,65)} = 11.936$	< 0.001	HS	0.997	0.819	0.272	0.584	0.587
Median PFC								
mPrL	$H = 43.911, df = 9$	< 0.001	MW	0.377	0.008	0.165	1.000	0.002
mCg1	$H = 48.526, df = 9$	< 0.001	MW	0.377	0.002	0.097	0.878	0.002
mM2	$H = 45.939, df = 9$	< 0.001	MW	0.596	0.001	0.165	0.382	0.028
mM1	$F_{(9,65)} = 19.382$	< 0.001	HS	0.992	0.211	0.996	0.360	0.990
mAI	$F_{(9,65)} = 7.448$	< 0.001	HS	0.973	0.204	0.980	0.997	0.646
mLO	$H = 40.675, df = 9$	< 0.001	MW	0.517	0.138	0.535	0.645	0.001
mVO	$F_{(9,65)} = 8.243$	< 0.001	HS	0.954	0.051	0.911	0.643	0.102
mMO	$F_{(9,65)} = 6.193$	< 0.001	HS	1.000	0.973	0.995	0.998	0.456
Caudal PFC								
cIL	$F_{(9,65)} = 10.503$	< 0.001	HS	0.854	0.092	0.861	0.983	0.002
cPrL	$F_{(9,65)} = 11.498$	< 0.001	HS	0.941	0.018	0.678	0.971	0.016
cCg1	$F_{(9,65)} = 14.671$	< 0.001	HS	0.981	<0.001	0.041	0.987	0.001
cM2	$F_{(9,65)} = 14.671$	< 0.001	HS	0.952	<0.001	0.164	0.820	0.058
cM1	$F_{(9,65)} = 19.667$	< 0.001	HS	1.000	0.059	0.997	0.977	0.688
cS1	$F_{(9,65)} = 24.159$	< 0.001	HS	0.999	0.995	0.358	0.993	0.999
cDI	$F_{(9,65)} = 11.341$	< 0.001	HS	1.000	1.000	0.966	0.996	1.000
cAID	$F_{(9,65)} = 8.254$	< 0.001	HS	0.993	0.941	0.999	0.978	0.276
cAIV	$F_{(9,65)} = 8.319$	< 0.001	HS	0.995	0.696	0.996	0.990	0.101
cLO	$F_{(9,65)} = 3.414$	< 0.001	HS	0.926	0.985	0.999	1.000	0.124

Supplementary Table 5a

Statistical analysis between 4 groups				SESI-Long vs ESI-Long		$\beta 2^{-/-}$ vs B6	
				B6	$\beta 2^{-/-}$	ESI-Long	SESI-Long
F or H	<i>p</i>	Subsequent test	<i>p</i>	<i>p</i>	<i>p</i>	<i>p</i>	
Global PFC							
PrL	H = 26.864, df = 3	< 0.001	MW	< 0.001	< 0.001	0.195	0.002
Cg1	H = 26.051, df = 3	< 0.001	MW	0.005	< 0.001	0.083	0.001
M2	$F_{(3,32)} = 48.002$	< 0.001	HS	< 0.001	< 0.001	0.284	< 0.001
M1	$F_{(3,32)} = 34.044$	< 0.001	HS	< 0.001	< 0.001	0.006	0.182
LO	H = 27.706, df = 3	< 0.001	MW	< 0.001	0.001	0.161	< 0.001
VO	H = 27.225, df = 3	< 0.001	MW	< 0.001	< 0.001	0.721	< 0.001
MO	$F_{(3,32)} = 49.270$	< 0.001	HS	< 0.001	< 0.001	0.510	0.001
Amygdala							
BLA	$F_{(3,32)} = 31.413$	< 0.001	HS	0.952	0.002	< 0.001	< 0.001

Supplementary Table 5b

Statistical analysis between 4 groups				SESI-Long vs ESI-Long		$\beta 2^{-/-}$ vs B6	
				B6	$\beta 2^{-/-}$	ESI-Long	SESI-Long
F or H	<i>p</i>	Subsequent test	<i>p</i>	<i>p</i>	<i>p</i>	<i>p</i>	
Rostral PFC							
rPrL	$F_{(3,32)} = 16.412$	< 0.001	HS	<0.001	<0.001	0.703	0.297
rFrA	$F_{(3,32)} = 43.838$	< 0.001	HS	<0.001	<0.001	0.094	0.102
rDLO	$F_{(3,32)} = 34.723$	< 0.001	HS	<0.001	<0.001	0.204	0.075
rLO	$H = 25.706, df = 3$	< 0.001	MW	<0.001	<0.001	0.798	0.003
rVO	$H = 26.960, df = 3$	< 0.001	MW	<0.001	<0.001	0.721	<0.001
rMO	$F_{(3,32)} = 36.986$	< 0.001	HS	<0.001	<0.001	0.809	0.015
Median PFC							
mPrL	$H = 26.487, df = 3$	< 0.001	MW	<0.001	<0.001	0.442	0.002
mCg1	$H = 26.937, df = 3$	< 0.001	MW	0.002	<0.001	0.028	0.002
mM2	$F_{(3,32)} = 31.219$	< 0.001	HS	<0.001	<0.001	0.718	0.013
mM1	$H = 24.451, df = 3$	< 0.001	MW	0.001	<0.001	0.010	0.807
mAI	$F_{(3,32)} = 39.367$	< 0.001	HS	<0.001	<0.001	0.028	0.004
mLO	$F_{(3,32)} = 66.234$	< 0.001	HS	<0.001	<0.001	0.176	<0.001
mVO	$H = 26.864, df = 3$	< 0.001	MW	<0.001	<0.001	0.161	0.002
mMO	$F_{(3,32)} = 47.799$	< 0.001	HS	<0.001	<0.001	0.257	<0.001
Caudal PFC							
cIL	$F_{(3,32)} = 43.271$	< 0.001	HS	0.004	<0.001	0.114	<0.001
cPrL	$F_{(3,32)} = 38.701$	< 0.001	HS	0.007	<0.001	0.115	<0.001
cCg1	$H = 24.215, df = 3$	< 0.001	MW	0.004	<0.001	0.195	0.002
cM2	$H = 26.504, df = 3$	< 0.001	MW	<0.001	<0.001	0.050	0.004
cM1	$F_{(3,32)} = 37.173$	< 0.001	HS	<0.001	<0.001	0.012	0.018
cS1	$F_{(3,32)} = 20.380$	< 0.001	HS	0.005	<0.001	0.007	0.722
cDI	$F_{(3,32)} = 12.906$	< 0.001	HS	0.022	<0.001	0.059	0.716
cAID	$F_{(3,32)} = 22.630$	< 0.001	HS	0.009	<0.001	0.063	0.012
cAIV	$H = 24.764, df = 3$	< 0.001	MW	0.005	<0.001	0.015	0.013
cLO	$H = 27.992, df = 3$	< 0.001	MW	<0.001	<0.001	0.015	0.005

Supplementary Captions to Tables.

Supplementary Table 1. Statistical analyses in B6 and $\beta 2^{-/-}$ mice submitted to acute stress (**S**) when c-fos protein was detected 90 min after the beginning (short delay, **S-Short**) or the end of the stress procedure (long delay, **S-Long**; see Fig. 1). For each genotype, comparisons were done with their respective controls (**Cnt**) and between S-Long and S-Short protocols. Comparisons were performed on 10 independent groups with Kruskal-Wallis one-way ANOVA on Ranks (*p*) in the Global PFC and in the amygdala (**a**), and in the rostral, median and caudal PFC (**b**). When normality passed, data were subsequently analyzed with the Holm-Sidak method test (F) and when data did not follow a Gaussian distribution we performed Mann-Whitney U-tests (H). *p* of post-hoc comparisons are indicated (post-hoc). Gray areas indicated significant differences.

Supplementary Table 2. Statistical analyses in B6 and $\beta 2^{-/-}$ mice submitted to stress followed by exploration and social interaction (**SESI**) when c-fos protein was detected 90 min after the beginning of stress procedure (short delay, **SESI-Short**) or 90 min after the end of social interaction (long delay, **SESI-Long**; see Fig. 1). For each genotype, comparisons were done with their respective controls (**Cnt**) and between SESI-Long and SESI-Short protocols. Comparisons were performed on 10 independent groups using Kruskal-Wallis one way ANOVA on Ranks (*p*) in the Global PFC and in the amygdala (**a**) and in the rostral, median and caudal PFC (**b**). See supplementary Table 1 for statistical comparisons. Gray areas indicated significant differences.

Supplementary Table 3. Statistical analyses in B6 and $\beta 2^{-/-}$ mice submitted to stress alone (**S**) and to stress followed by exploration and social interaction (**SESI**). For each genotype, comparisons were done when c-fos protein was detected 90 min after the beginning of stress (short delay, **SESI-Short** vs **S-Short**) and 90 min after the end of stress or social interaction (long delay, **SESI-Long** vs **S-Long**; see Fig. 1). Statistical analyses were performed on 10 independent groups using Kruskal-Wallis one-way ANOVA on Ranks (*p*) in the Global PFC and in the amygdala (**a**) and in the rostral, median and caudal PFC (**b**). See supplementary Table 1 for statistical comparisons. Gray areas indicated significant differences.

Supplementary Table 4. Statistical comparisons between B6 and $\beta 2^{-/-}$ mice submitted to no stress and no behavior (Control mice, **Cnt**), to stress alone (**S**) with c-fos protein detected 90 min after the beginning of stress (short delay, **S-Short**), 90 min after the end of stress (long delay, **S-Long**), 90min after the beginning

1 of stress followed by exploration and social interaction (**SESI short**), and 90min after the end of social
2 interaction (**SESI-Long**) (see Fig. 1). Statistical analyses were performed on 10 independent groups using
3 Kruskal-Wallis one way ANOVA on Ranks (*p*) in the Global PFC and in the amygdala (**a**) and in the rostral,
4 median and caudal PFC (**b**). See supplementary Table 1 for statistical comparisons. Gray areas indicated
5 significant differences.
6
7
8
9
10

11
12 **Supplementary Table 5.** Statistical analyses in B6 and $\beta 2^{-/-}$ mice submitted to exploration and social
13 interaction following or not acute stress (**SESI** and **ESI** mice, respectively) when c-fos protein was detected
14 90 min after the end of the social interaction (long delay, see Fig. 1B). Comparisons were done between **SESI-**
15 **Long** and **ESI-Long** mice for each genotype (middle columns) and between B6 and $\beta 2^{-/-}$ for each experimental
16 condition ($\beta 2^{-/-}$ versus B6 mice, ESI-Long and SESI-Long, right columns). Comparisons were performed on
17 4 independent groups with Kruskal-Wallis one-way ANOVA on Ranks (*p*) in the Global PFC and in the
18 amygdala (**a**), and in the rostral, median and caudal PFC (**b**). See supplementary Table 1 for statistical
19 comparisons. Gray areas indicated significant differences.
20
21
22
23
24
25
26
27
28
29
30
31
32
33
34
35
36
37
38
39
40
41
42
43
44
45
46
47
48
49
50
51
52
53
54
55
56
57
58
59
60