



**HAL**  
open science

# Understanding Microgrid Sustainability: A Systemic and Comprehensive Review

Antoine Boche, Clément Foucher, Luiz Fernando Lavado Villa

► **To cite this version:**

Antoine Boche, Clément Foucher, Luiz Fernando Lavado Villa. Understanding Microgrid Sustainability: A Systemic and Comprehensive Review. *Energies*, 2022, 15 (8), pp.2906. 10.3390/en15082906 . hal-03642707

**HAL Id: hal-03642707**

**<https://hal.science/hal-03642707v1>**

Submitted on 20 Jun 2023

**HAL** is a multi-disciplinary open access archive for the deposit and dissemination of scientific research documents, whether they are published or not. The documents may come from teaching and research institutions in France or abroad, or from public or private research centers.

L'archive ouverte pluridisciplinaire **HAL**, est destinée au dépôt et à la diffusion de documents scientifiques de niveau recherche, publiés ou non, émanant des établissements d'enseignement et de recherche français ou étrangers, des laboratoires publics ou privés.



Distributed under a Creative Commons Attribution 4.0 International License

Review

# Understanding Microgrid Sustainability: A Systemic and Comprehensive Review

Antoine Boche <sup>\*,†</sup> , Clément Foucher  and Luiz Fernando Lavado Villa

LAAS-CNRS, Université de Toulouse, CNRS, UPS, 31000 Toulouse, France; clement.foucher@laas.fr (C.F.); lflavado@laas.fr (L.F.L.V.)

\* Correspondence: antoine.boche@laas.fr

† Current address: LAAS-CNRS, 7 Av. du Colonel Roche, 31400 Toulouse, France.

**Abstract:** There is a growing research interest in studying microgrids as a way to overcome the lack of access to energy. These microgrids could be the key to global energy access because of their many advantages related to flexibility, efficiency, and reliability. Despite all these qualities, microgrids remain challenging to implement in a sustainable and resilient way without a clear consensus on what causes these failures. To this end, this work proposes a new paradigm to make a multidisciplinary and comprehensive review of the operation of microgrids. By reconciling the different fields inherent to microgrids, this review enables the study of microgrids within a unified framework. Microgrids will be presented through energy, information, financial, and social fields to provide the necessary elements for their systemic understanding. Each field will be presented with its internal elements, architecture, and significant issues. By elaborating on this new vision of microgrids, this article hopes to open the way to a deeper understanding of their systemic operation and diagnose their long-term sustainability.

**Keywords:** microgrid; community microgrid; microgrid architecture; information system; business model; social acceptance; rural electrification; systemic approach; sustainability; resilience



**Citation:** Boche, A.; Foucher, C.; Villa, L.F.L. Understanding Microgrid Sustainability: A Systemic and Comprehensive Review. *Energies* **2022**, *15*, 2906. <https://doi.org/10.3390/en15082906>

Academic Editors: Laia Ferrer-Martí, Bruno Domenech and Alberto García-Villoria

Received: 23 March 2022

Accepted: 12 April 2022

Published: 15 April 2022

**Publisher's Note:** MDPI stays neutral with regard to jurisdictional claims in published maps and institutional affiliations.



**Copyright:** © 2022 by the authors. Licensee MDPI, Basel, Switzerland. This article is an open access article distributed under the terms and conditions of the Creative Commons Attribution (CC BY) license (<https://creativecommons.org/licenses/by/4.0/>).

## 1. Introduction

According to the United Nations, 789 million people are living with no access to electricity [1], and without a more engaged action, 650 million people will remain without energy access in 2030 [2]. The investment required for universal energy access by 2030 is estimated to cost more than \$48 billion each year. In contrast, the renewable-energy-based technologies that can provide safe and clean electricity are now cheaper and more accessible than ever to the population [3]. Despite these encouraging developments, sustainable and affordable rural electrification remains a complex and risky endeavor [4].

There are essentially two solutions to provide electricity to a new location: extending the main grid or creating a local installation. Depending on the context, one solution will be preferable to the other [5]. However, a large part of the population that does not yet have access to energy does not have a reliable central electricity grid to connect to [6].

The decentralized approach seems to be more reliable and efficient for rural electrification because of its high versatility and lower cost [7]. Experts seem to be in consensus that decentralized electricity networks will have the capacity to power entire cities or medium-sized regions by 2040 [8]. However, despite all the qualities of microgrids, the uptake of this type of system in rural communities remains extremely low. The lack of economic and business consideration [9], the gap in strategic planning approach [10], the neglect of social issues [11], and the deficiency of an apparent global consideration on overall microgrid sustainability [4] make the implementation of microgrids even more difficult. The social development of a population is strongly linked to its access to energy which increases, at the same time, the quality of life of the community [12]. As the population grows, its

needs will change, and so will the way it consumes energy, often creating the need for more energy [13]. The microgrid must therefore be able to evolve with its community.

In this article, we conduct a review seeking to lay the foundations of bringing more understanding on microgrid sustainability and how to reach it. We use a systemic approach to understand the literature linking microgrids and their evolution over time to adapt to the development of the population to which it provides power. Because microgrids are such a vast and complex topic, this systemic review will cover various topics, from technical to social.

Microgrids and their sustainability have been studied extensively in the literature, with a growing interest in the past ten years, as shown in Figure 1. This figure shows the annual publications related to sustainability or resilience for microgrids since 2007. The data were extracted from the search engine web of science for the publishers IEEE, Elsevier, and MDPI. As a result, 837 publications were identified as relevant because they include the notions of sustainability and resilience in their study. We can see that the interest in these notions in microgrids has dramatically increased, showing the interest in finding solutions for the weaknesses of microgrids systems. The concept of sustainable energy development has evolved to become central in energy and microgrid creation and operation and is now a key factor for its study [14].

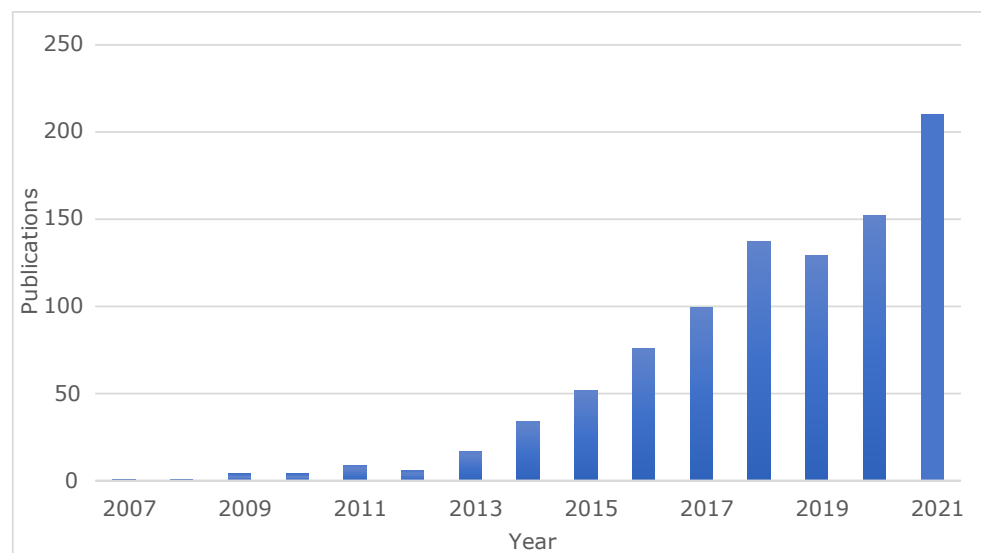

**Figure 1.** Evolution of sustainability and resilient microgrids in the literature.

The literature tends to focus on identifying limiting actions or promising practices to be followed to optimize the microgrid [15], often using case studies to flesh out the recommendations [16]. However, the literature tends to overlook non-technical actions, which are also crucial to guaranteeing the long-term sustainability of the microgrid. A disproportionate focus on the technical or economic aspect of the microgrid overlooking other characteristics tends to increase the probability of failure [17]. The notion of the virtuous circle [18] illustrates the impact of non-technical elements on microgrid sustainability. It includes fair tariffs, proper maintenance, and the availability of well-trained human resources among the essential factors that trigger a virtuous cycle of growth of the microgrid [19]. For rural areas, microgrid sustainability is paramount because these populations cannot afford a grid failure [20].

This review aims to provide a framework for understanding the vast literature surrounding sustainability in microgrids, both in technical and social fields. The framework proposed in this work will be based on four different fields, namely: energy, information, finance, and social. The fields will be introduced in Section 2. Each field will be described in detail in Sections 3–6. An overall discussion of the main findings from this literature review will be given in Section 7.

## 2. Overview of Existing Microgrid Literature

There is still no consensus on the concept of microgrids in the literature. All existing definitions can be broadly regrouped in two categories: “energy microgrid” and “community microgrid”. These two categories and their relations to the fields proposed in this work are shown in Figure 2.

Energy microgrids, shown in red in Figure 2, gather the energy and information field. An example of a definition falling into this category is the one given by the European Microgrids project [21]. It states that microgrids are “*Low Voltage distribution networks comprising various distributed generators, storage devices and controllable loads that can operate either interconnected or isolated from the main distribution grid as a controlled entity*”.

Community microgrids, shown in blue in Figure 2, gather the social and financial fields. An example of a definition is given by Gui [22]. It states that “*A community microgrid is connected with its community through physical placement and can be partially or fully owned by said community. [...] Considering the social dimension, a ‘community microgrid’ can be viewed as a microgrid with the key objectives of achieving economic, social and environmental benefits in community electricity supply and distribution*”.

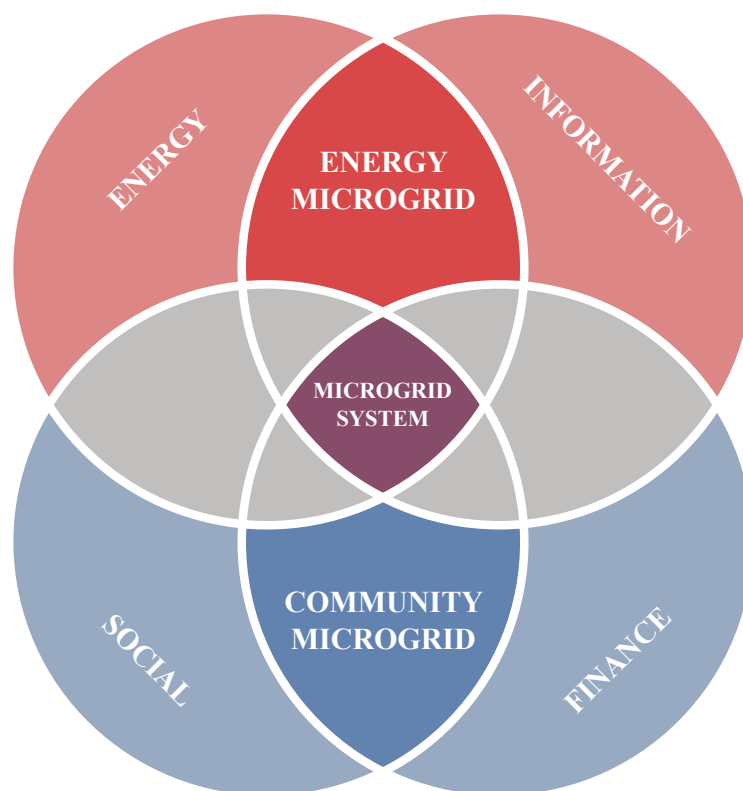

**Figure 2.** The two definitions of microgrids and their fields.

This review seeks to reconcile these two definitions of microgrids as a basis for analysis of their sustainability. Figure 2 depicts this approach as the gray and purple areas at the intersection of these definitions. The gray areas show microgrid models and visions that partially integrate these definitions. The purple zone represents the objective of this review. While there are many highly detailed recent reviews on microgrids’ operations and different architectures, there is still a gap in the global view. These tend to focus on either energy microgrid [23–26] or community microgrid [27–29], but rarely both, or only in brief.

The reconciliation of the energy and community microgrids views is not straightforward. Many articles in the literature addressing microgrid sustainability through systemic analysis tend to rely on qualitative approaches based on study cases or common sense inference [30]. These systemic analyses tend not to get into the technical details of the

microgrid and its operation, given its multidisciplinary nature. In contrast, analytic articles addressing microgrids then deduce laws from mathematical models, which naturally require assumptions for simplification [31]. As with all multidisciplinary scientific work, inference and deduction combined with systemic and analytic approaches lead to conflicting views of the same problem.

As our approach tries to reconcile a systemic inference while keeping the precision of the analytical deduction, we will tie the concept of microgrid sustainability to the issues it faces. The issues of microgrids will be described based on its four fields, as shown in Table 1.

**Table 1.** List of the issues of microgrid sustainability.

Component	Issues	Description	Reference
Energy	Sizing	Proper sizing of the electrical infrastructure	[32–34]
	Quality	High quality and efficiency of the electrical infrastructure	[35–37]
	Protection	High safety for the infrastructure and the users	[38–41]
Information	Control	High quality of energy control	[24,42,43]
	Data	High transcription of the data for the other components	[44–48]
	Communication	Fast and reliable communication	[49,50]
Finance	Design	Right economic design of the microgrid	[51–56]
	Management	Good management of capital and employees	[57–62]
	Planning	Good long-term vision for the evolution of the microgrid	[7,63–67]
Social	Knowledge	Good knowledge of microgrid operation and usage	[68–70]
	Rules	Rules adapted to the community and the microgrid	[71–73]
	Perception	High confidence in the community and the microgrid operator	[74–76]

In this work, the definition of a sustainable microgrid is capable of addressing all the issues of its fields in a satisfactory manner at the time of analysis. The purpose of what is sufficient for each field depends on each case, leaving the possibility of qualitative analysis. However, it must be translated in thresholds, compatible with analytic tools such as classification.

Other reviews of microgrids take into account a maximum of parameters for a trans-disciplinary study of microgrids. These microgrid reviews make a clear and complete state of the art of the microgrid operation [77], provide a functional layer-based review of microgrids [78], describe sustainable business model solutions for the development of a microgrid [79], show all the difficulties which can appear in various fields of microgrid development [30], provide global performance indicators for the proper functioning of a microgrid [80,81], make a systemic diagnosis of the microgrid state of health [82], or make a complete criticism of the limits of the microgrids [71].

A bibliographical study of the various reviews on the subject of microgrids is presented in Table 2. This table shows the different themes addressed in each review, as well as the type of study that has been conducted. In our view, no publication on microgrids has addressed all of the topics listed in the table. This is the added value of this review.

Figure 3 shows the distribution from the 900 publications according to the field(s) they study, highlighting how they are positioned in terms of the intersection shown in Figure 2. Most of these articles focus on analytical work and technical descriptions but often lack the systemic vision. Purely financial and social articles are less common. Most financial and social analyses are conducted in parallel with energy and information studies. As we can see, multidisciplinary studies of the four components simultaneously are considerably less present in the literature.

The added value of this work proposes a single framework to review all four fields used to reconcile the energy and community visions of microgrids. All of them are considered to have associated elements, architectures, and issues. Their different aspects will be presented in a systemic approach while allowing for the setting of thresholds compatible

with analytical approaches. Each field has a single “unit”, meaning energy is expressed in Watts, information in Bits, financial in Currency, and social in Acceptance. Regarding this structure of the review, Figure 4 comprehensively illustrates all the topics that will be discussed in the following sections, in the order in which they are presented.

**Table 2.** Recent literature review on microgrids relating to the topics addressed in this review.

References	Energy			Financial					Information					Social				Type									
	Quality	Sizing	Protection	AC	DC	Hybrid	Sizing	Planing	Management	Gathered	Federated	Networked	Control	Data	Communication	Centralized	Decentralized	Distributed	Hierarchical	Knowledge	Perception	Rules	Micro	Meso	Macro	Analytic	Systemic
[78]	x			x	x	x		x		x	x	x	x	x	x	x	x								x	x	
[83]	x		x	x	x							x														x	x
[71]	x	x					x	x	x											x	x		x	x	x		x
[45]														x												x	
[84]							x	x	x	x	x											x	x		x	x	
[30]	x	x					x	x	x				x	x							x	x	x				x
[85]				x	x	x						x			x	x	x	x	x								
[86]												x	x	x	x	x	x	x									
[87]	x			x	x	x			x			x		x	x	x	x	x									x
[22]	x								x	x	x										x	x	x		x	x	x
[88]	x	x	x						x		x		x	x						x	x	x	x	x	x		x
[89]	x	x	x				x	x	x			x	x	x						x	x	x		x	x		x
[90]	x		x					x	x			x	x	x												x	x
[11]	x	x	x	x	x	x	x	x	x			x		x							x					x	x
[79]	x	x					x	x	x			x	x	x						x	x	x	x	x	x		x
[24]	x			x	x	x						x		x	x	x	x	x								x	
[91]	x	x										x															x
[92]	x								x	x	x	x		x	x										x	x	
[93]												x	x	x	x	x										x	
[18]	x	x	x				x	x	x			x	x							x	x	x			x	x	x
[77]	x			x	x	x	x	x	x		x			x	x	x	x	x				x				x	x
[94]	x		x	x	x	x		x	x			x			x	x											x
[95]	x		x	x	x	x						x		x	x	x											x
[72]							x	x	x													x				x	x
[96]	x	x	x	x	x	x		x				x							x								x
[70]	x	x					x	x	x				x							x	x	x	x				x
[42]	x			x	x	x						x				x	x	x	x								x

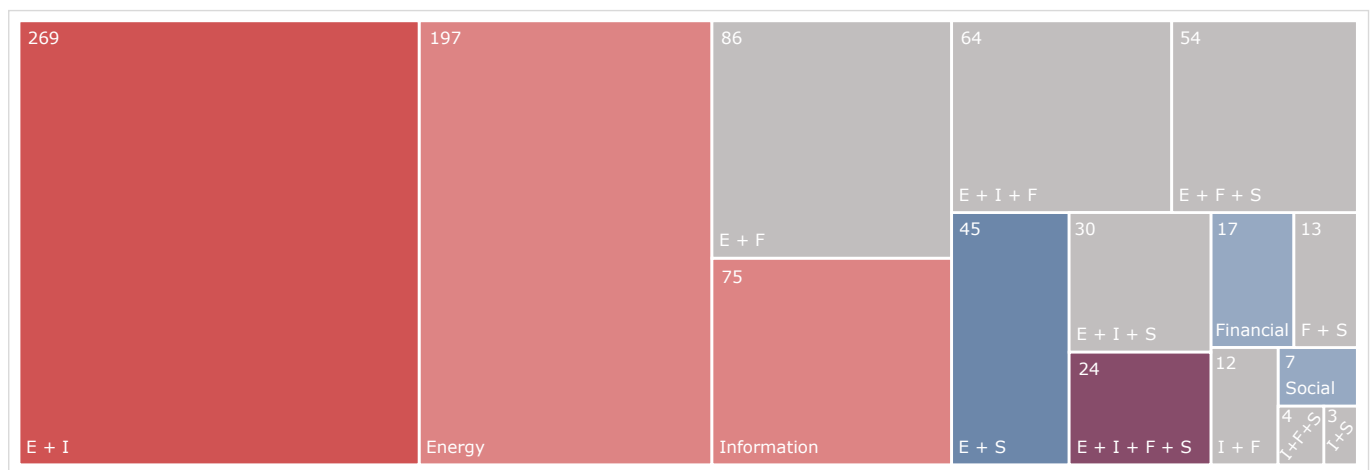

**Figure 3.** Sustainability and resilience microgrid publications related to the field they study.

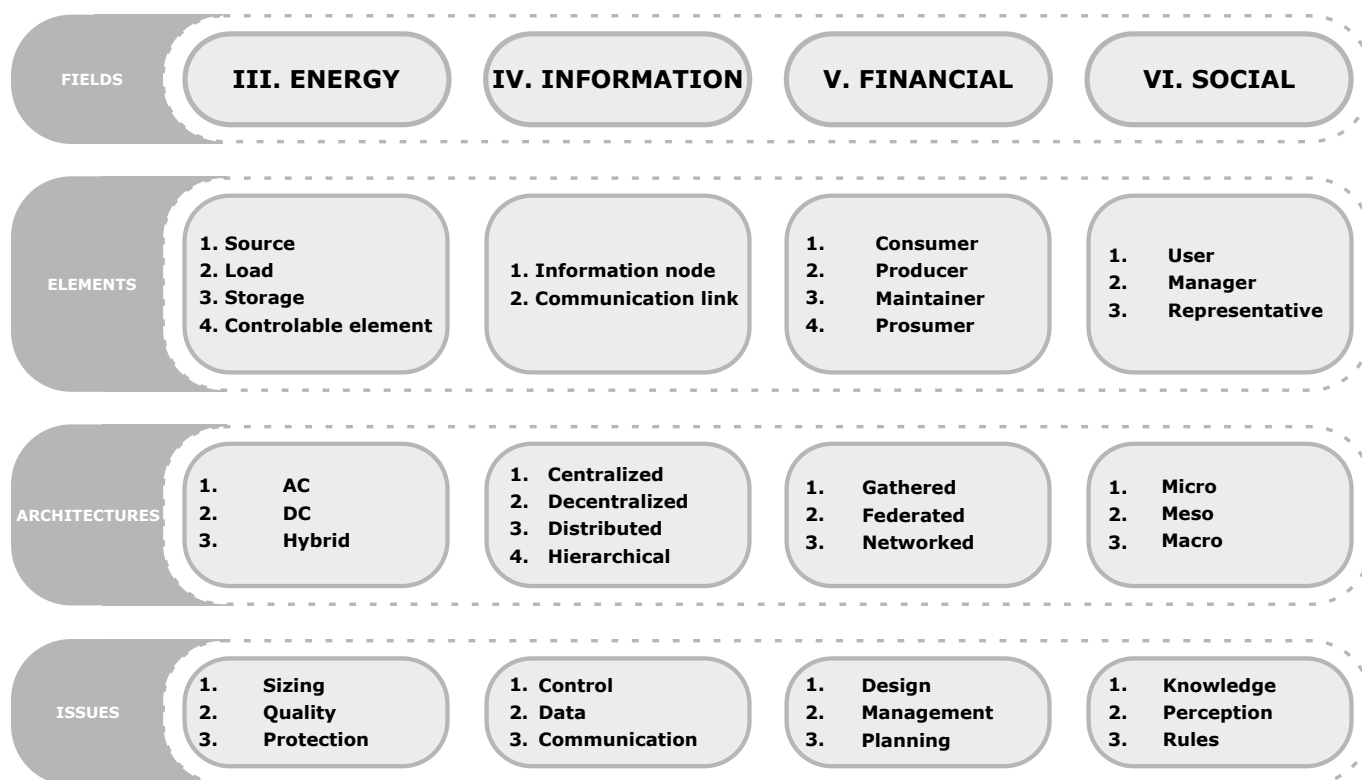

Figure 4. Structure of the review.

It is important to note that rural electrification is a specific case of microgrids [97]. This work will refer to rural microgrids as base examples in each field and the discussion section. What is of particular interest in rural microgrids is the enormous technical and social challenges they face. Challenges in rural electrification are focused on low electricity demand, poor payment rate, overrated community needs and the choice of the business model [6]. Rural microgrids are a stand-alone application of microgrids where both the energy and community visions are very close to one another. This reduced scale makes them a perfect study case for a single-framework field-based sustainability analysis proposed in this work [98].

### 3. Energy Field

The energy field represents all the electrical and energy aspects of microgrids and their interconnections. In other words, it represents all the energy fluxes of the microgrid. The energy field is expressed by assembling energy elements through energy architectures to answer energy issues. In energy terms, microgrids are mainly seen as the assembly of electrical blocks that can be operated in island mode, grid-connected mode, or both [94].

#### 3.1. Energy Elements

In this work, the energy component is composed of four types of elements: sources, storage, loads, and power electronics converters [99].

There is a wide variety of sources that can be connected to microgrids [100], which are mainly separated into two main types: conventional generators (diesel generator, gas turbine) and non-conventional generators (fuel cells, photovoltaic, hydro turbine biomass, wind, geothermal, and solar thermal) [101]. Most microgrids work with renewable energy-based sources such as photovoltaics and wind turbines usually associated with diesel generators. Diesel generators are top-rated in microgrid applications due to their flexibility, low-cost and ease of implementation, despite their known stability and low inertia issues [102].

Storage systems provide stability, allowing them to face energy production intermittency and downtime, both typical of distributed generation [103]. Storage systems can be divided into electrical storage (magnetic storage, supercapacitor), mechanical storage (flywheel, potential storage), electrochemical batteries, and fuel cells [104].

All of the energy produced and stored is to be consumed by the users through loads that are commonly categorized into two types: fixed and variable loads [105]. A fixed load requires a constant flow of energy, while a variable load turns on and off according to a random control signal. Taken together, these types of loads make up a load profile used to design and manage modern microgrids [106].

Power electronics converters are used as an interface between sources, storage, and loads [107]. Power converters have two main functions: a power flow management function that controls the current and/or the voltage ratings between two elements and a passive filter function that eliminates harmonic contents created by the active fields whose switching is responsible for the power flow management [108].

### 3.2. Energy Architectures

Energy architectures assemble energy elements in ways that suit the specific need of the microgrid. There are three main architectures available in the literature represented in Figure 5 and summarized in Table 3: the AC architecture, the DC architecture, and the hybrid architecture [83,109].

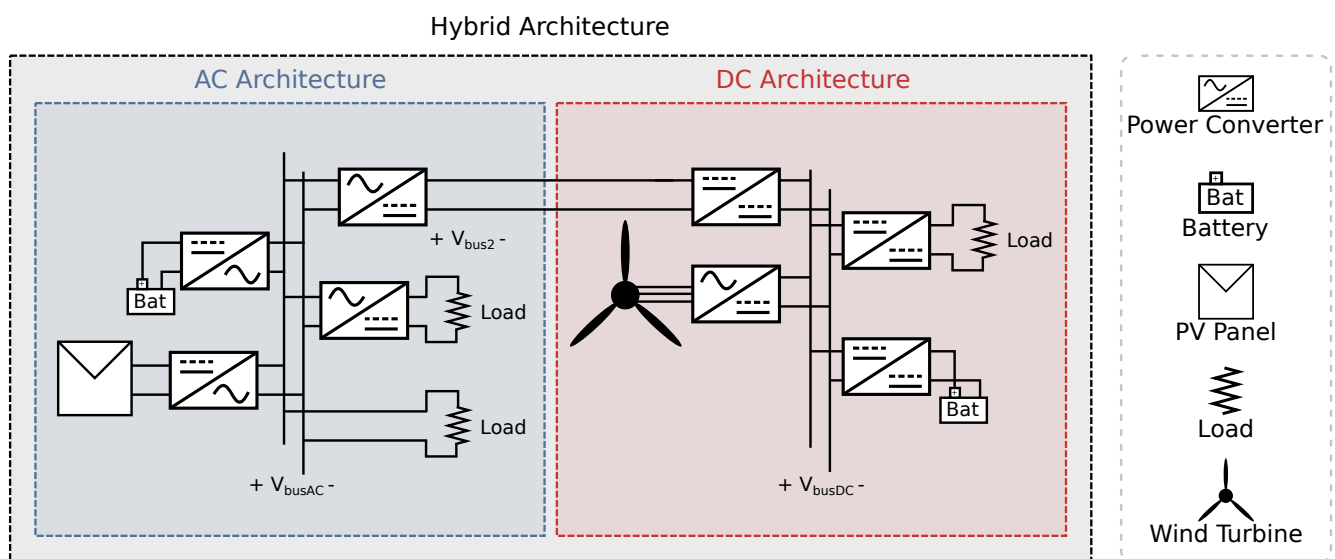

**Figure 5.** Representation of the different energy architectures.

The AC architecture has been the most common choice for energy distribution through utilities due to its ease of transformation in different voltages and reduced loss in transport [110].

The DC architecture is the most used in microgrids because of its high concentration of DC sources and loads, resulting in easier management of the microgrid energy [111].

The hybrid architecture can be seen in many different microgrids and has more variety than classic AC or DC architectures. The classical way to build this architecture is to connect DC sources and load to DC busses, and AC sources and load to AC busses [112]. However, the architecture can be a bit more optimized and, for example, connect all the sources and loads to an AC bus and all the storage to a DC bus to simplify their management [113]. The DC zonal architecture connects all the loads to DC buses and uses AC buses to connect all the DC buses together [114]. The solid state transformer based microgrid centralizes all the buses in this high-frequency transformer that can manage AC and DC feeders as well as power flow between the main grid and the microgrid [115,116].



In between these three main types of architectures, many different solutions are more subtle to solve a specific need with a mix of their benefits and downsides [117].

In the literature, classic microgrids are mainly seen as assembling electrical blocks that can be operated in island mode, grid-connected mode, or both [94]. A clustered microgrid can also be seen as an assembly of smaller grids that are interconnected to form a much bigger entity [118]. Swarm microgrids are another concept where the microgrid evolves in an “organic” way resulting in a swarm architecture capable of stability due to energy production decentralization [119].

In the rural electrification context, DC architectures are the most used since energy sources are easy to implement (solar PV and batteries), and basic loads such as light or electronic device recharge can easily accommodate DC [120].

**Table 3.** Classification of microgrid power architecture.

Architecture	Type	Advantages and Drawbacks	Articles
AC	AC microgrid	AC microgrid is really easy to implement and reconfigure but requires a complex power electronic interface and a generally poor quality energy	[40,110]
DC	DC microgrid	DC microgrids are relatively simple to control with a relatively good quality of energy but tend to be limited in terms of expansion and their lack of reliability with a distribution grid connection	[39,111]
Hybrid	AC-DC microgrid	Combines the advantages of AC and DC architecture but cannot be suited for all applications	[112]
	AC microgrid with DC storage	More reliable storage devices and has similar performance to the hybrid AC-DC, but the energy storage must be centralized	[113]
	DC-zonal microgrid	Allows different busses voltage and management technique but increases the complexity of the control	[114]
	Solid state transformer based microgrid	Very high quality of energy and high compatibility with AC or DC devices, but the entire grid is dependent on the solid state transformer	[115,116]
	Swarm architecture	Easy development and high overall reliability and flexibility, but requires a complex power electronic interface	[119]

### 3.3. Energy Issues

Based on the literature, this work considers the energy field to have three main issues: appropriate system sizing, quality of the components, and protection [121–124].

Appropriate system sizing refers to the correct balance of the different electrical elements [32] and the conformity of the microgrid to the needs [33] and earnings of its final users [34]. The microgrid sizing must balance being large enough to avoid any outages and small enough to remain as affordable as possible for final users [125,126]. This sizing problem can be broken down into a multitude of critical factors ranging from the optimization of the sizing of storage systems [127] to the understanding of local energy needs [128] or the balance of different energy sources [129], but also by addressing more specific issues such as the optimization of the integration of hydrogen fuel cells [130].

The quality of components describes the microgrid equipment in terms of robustness and maintainability [35]. The current literature points out that higher quality of the electrical grid components as a whole avoids blackouts and dysfunctions [36], which is a crucial element, especially in rural areas [37]. For this, important knowledge of the technologies available for the implementation of microgrids is required [96,100,131]. However, it is essential to keep in mind that these systems change and evolve rapidly, and the quality of the grid also requires regular upgrades and maintenance [97,123] which have been summarized in terms of robustness, resourcefulness against disasters, rapid recovery, and adaptability [132].

Protection of the microgrid refers to the equipment and techniques used to protect the elements of the energy system from any malfunction, whether internal or external to the element [38]. An extensive review has been conducted to present all the protection possibilities in AC [39] and DC [40] grids and different standards [41].

In the energy field, sustainability translates as defining clear thresholds for the issues of sizing, quality, and protection. Sizing should provide a compromise between power production capacity and foreseeable load. Quality is the cost-benefit analysis of the equipment used to build the microgrid. Protection is the number of protection elements for different faults and the overall cost linked to their presence or absence from the microgrid. These thresholds will then be used to monitor the evolution of the microgrid over time to detect any issues in the energy field.

#### 4. Information Field

The information field is built on two aspects of a microgrid: data and control. Control is used to regulate the power flow within the microgrid, handling voltage stability, power quality, and other issues to keep the electricity flowing. Data are related to the generation, transport, and aggregation of data from sensors and other sources spread throughout the microgrid [90,133,134].

Modern microgrids deploy a complex link between control and data [50]. Ultimately, separate scientific communities crystallize these with the concept of a smart grid, linking them together [135]. In this work, the complex link between data and control is the cornerstone for analyzing the information field.

##### 4.1. Information Elements

The information layer has two elements: the information node and communication links. An information node is composed of a control part and a data part. These parts vary significantly depending on the microgrid, its information architecture, and how the information issues are handled. Communication links connect the different information nodes of the architecture together [136]. The literature on communication links divides them into different types of networks, namely Wide-Area Network (WAN), Field Area Network (FAN), Neighborhood Area Network (NAN), Building Area Network (BAN), Industrial Area Network (IAN), and Home Area Network (HAN) [78,137].

##### 4.2. Information Architecture

The information field architecture comprises information nodes connected through communication links forming layers. These layers define the relationship between control and data on given information architecture. In this work, all microgrids are considered to have three layers [24,49,86]. Figure 6 shows the relationship between information layers, control, and data.

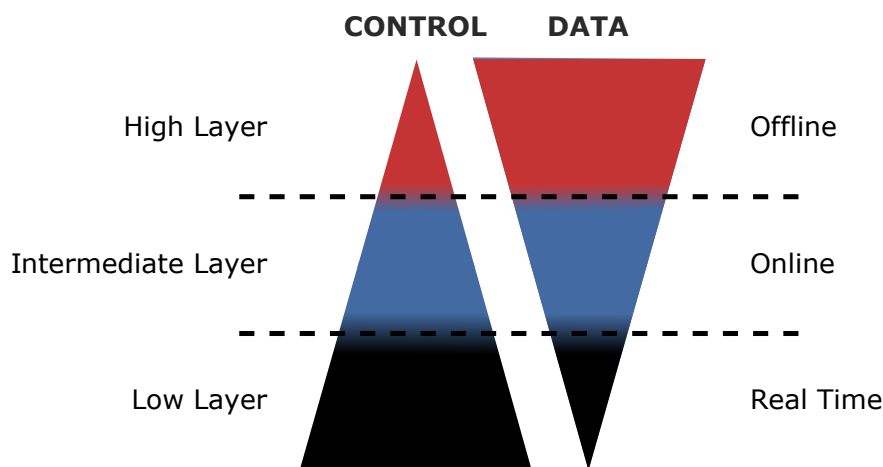
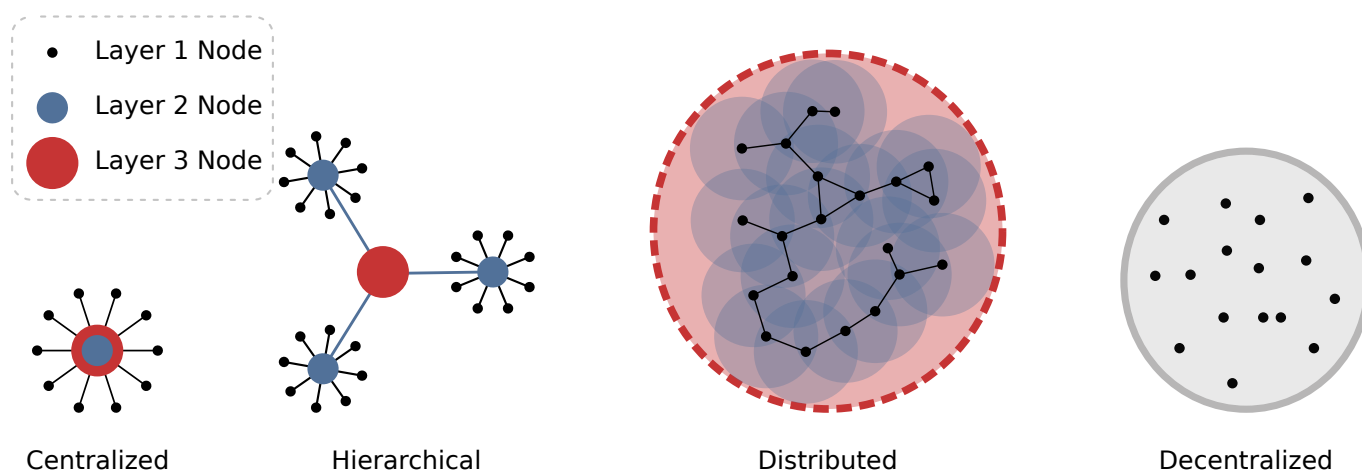

**Figure 6.** Relationship between data and control for different layers.

Lower layers are very control intensive, usually operating in real time or with stringent timing constraints. Their data intensity is low, requiring small volumes of data to operate. Their communication links tend to be very fast and embedded into devices. Intermediary layers are less control intensive, usually setting the reference points or tracking reference to the lower layers. They are more data-intensive, requiring averaged and more robust data to calculate these operating points. Their communication links are slower with more communication overhead and use means such as wires or the air to exchange information. Higher layers have very little control intensity, usually calculating parameters in asynchronous or very slow frequency. Their data intensity is very high, aggregating averaged values and many different data sources together. Their communication links are even slower and have significant overheads for redundancy reasons; they tend to use existing networks [24].

The architecture of the information field connects nodes through communication links organized in layers depending on the type of power control, data management, and communication links needed by the microgrid. A review of the literature shows that control, data, and communication have the same types of architecture, namely centralized, hierarchical, distributed, and decentralized [32,86,138].

Depending on the architecture, the power control, data management, and communication approaches change, and so does the layer deployment, as shown in Table 4. Figure 7 shows how the nodes connect together to form the different architectures.



**Figure 7.** Representation of the different information architectures.

#### 4.3. Information Issues

To be sustainable, the information field must address simultaneously the issues from control, data, and communication. This section explains these issues in detail and analyzes them within the framework of the elements and architectures explained above.

##### 4.3.1. Control Issues

A review of the literature on microgrid control has highlighted six issues that must be addressed for a sustainable, reliable, and stable microgrid operation. These are voltage and frequency regulation, power quality, transition between two modes of operation, microgrid protection, power flow management, and optimization [24,42,43]. These issues are related to the layers and architectures presented previously, as shown in Table 5.

**Table 4.** Information component architectures and their layers, adapted from [24].

		Centralized [21]	Hierarchical [49,139]	Distributed [140,141]	Decentralized [142]
<b>Layer</b>	<b>Node part</b>	All nodes connected to a central node	Nodes are connected in a pyramid	Nodes are connected peer-to-peer	Nodes are not connected to one another
<b>Low Layer</b>	<b>Control</b>	Source/Load controller	Source/Load controller	Source/Load controller	Source/Load controller
	<b>Data</b>	Source/Load measurement	Source/Load measurement	Source/Load measurement	Source/Load measurement
	<b>Communication</b>	HAN IAN	HAN IAN	HAN IAN	HAN IAN
<b>Intermediate Layer</b>	<b>Control</b>	Source/Load balancing	Local source/Load balancing	Source/Load droop control	Source/Load droop control
	<b>Data</b>	All lower layer measurements	Area-wide measurements	Only connected lower layer nodes measurements	No data from other nodes
	<b>Communication</b>	FAN NAN BAN WAN	FAN NAN BAN	FAN NAN BAN	HAN, IAN
<b>High Layer</b>	<b>Control</b>	Long-term dispatch for all sources	Long-term dipatch for area-wide sources	Long-term dispatch for local source	Long-term disptach for local source
	<b>Data</b>	All lower layer measurements and outside measurements	All intermediary layer measurements and outside measurements	All lower layer connected nodes measurements and outside measurements	Only the local data available
	<b>Communication</b>	FAN NAN BAN WAN	WAN	FAN NAN BAN	-
	<b>Advantages</b>	Easy to implement	Compromise between implementation and expansion	Easy to expand	Easy to expand
	<b>Drawbacks</b>	Hard to expand	Complex communication system	Communication overhead	No communication

**Table 5.** The information architectures and their relationship with control issues.

Control Architectures		V/I Regulation	Power Quality	Transitions	Protection	Power Flow	Optimization
<b>Centralized</b>	<b>Low</b>	X	X		X		
	<b>Intermediate</b>		X	X	X	X	
	<b>High</b>			X	X	X	X
<b>Hierarchical</b>	<b>Low</b>	X	X	X	X		
	<b>Intermediate</b>			X	X	X	
	<b>High</b>				X	X	X
<b>Decentralized</b>	<b>Low</b>	X	X	X	X		
	<b>Intermediate</b>				X	X	
	<b>High</b>					X	X
<b>Distributed</b>	<b>Low</b>	X	X	X	X		
	<b>Intermediate</b>			X	X	X	
	<b>High</b>					X	X

**Table 6.** Description and implementation of the different architectures.

Control Architectures	V/I Regulation	Power Quality	Transitions	Protection	Power Flow	Optimization
Description	Regulation on a small time frame and a specific location [143]	Secondary loop regulation of the voltage and frequency [144]	Operation of the microgrid through disturbances [42]	Operation of the microgrid through failure, notably short circuits [41]	Coordination and improvement of the energy fluxes [145]	Entire microgrid improvement [146]
Implementation	Droop, PID, model predictive, fuzzy, neuro-fuzzy, learning, virtual generator [147]	P/Q control, parallel BIC operation and harmonic mitigation [148]	Islanding detection, grid sync, and the BIC management [149,150]	Over/under I/V, fault detection, ground leakage, black start [40], cybersecurity, and other [103,151]	Storage coordination, V/f improvement, and demand response [152]	Economic dispatch, optimal load dispatch or prediction, and forecasting algorithms [153–156]

Table 6 shows system dynamics (fast vs. slow) and geographic range (near vs. far) tendencies in the literature [43].

Voltage and frequency regulation and power quality are focused on electric regulation through a limited time frame and location linked to the electric command, being near and fast. Transition operations and protection are focused on the process and protection through varying time frames and can operate in various geographic ranges. They can fit the not so fast and not so near middle range. Power flow management and optimization focus on energy management at a larger scale and time frame, with the purpose of correction, anticipation, and improvement of the quick command. They fit the far and slow category.

These issues and their time frames must be thoroughly taken into account in designing and maintaining the microgrid. By deciding on satisfactory thresholds for their operation, it is possible to reach the sustainability of the information field from a control perspective.

#### 4.3.2. Data Issues

A review of the literature on microgrid data has yielded two main issues, namely collecting and processing data [44,45]. Data collection is broken down into more minor issues, namely acquisition, managing and storing, and analyzing and disclosing the data [46,47]. Data processing seeks to aggregate value to the collected data and is composed of six more minor issues, namely volume, variety, velocity, validity, veracity, and volatility. [48]. Table 7 summarizes the cross-analysis between these more minor issues treated in the literature.

Data issues are key to the sustainability of the microgrid as data can be used to guarantee the payment of the consumed energy [157], to better understand the microgrid community [158], to make the legislation and rules internal to the microgrid [159], to improve the power conversion within the microgrid [160], and many other applications [44].

These minor issues must be considered when designing and operating a microgrid. Providing objective thresholds for their performance is paramount for achieving information sustainability within the microgrid from a data perspective.

**Table 7.** 7Vs management in the different data layers.

Collection\Processing Issues	Volume	Variety	Validity	Volatility	Veracity	Velocity	Value
Description	All the Data	Diversity of Sources	Accuracy of the Raw Data	Data Storage	Quality of the Data	Acquisition Speed	Final Aggregation
Acquisition [161] Management and Storage [107,162] Analysis [163] Disclosing [164,165] Protection [166,167]	X	X	X	X	X	X	X

#### 4.3.3. Communication Issues

The literature on communication link protocols highlights three issues: data rate, geographic coverage area, and latency [49,50]. The data rate is the capacity of a protocol to

send out data quickly. The coverage area is the area that can be covered using a specific protocol with an acceptable cost. Latency is the time necessary for the protocol to transmit all the required data.

Figure 8 shows the communication protocols according to these issues. Numerous reviews on the subject have made it possible to represent a maximum of the protocols used with their own characteristics [168–171]. It can be seen that communication link protocols provide the lowest latency on the lowest layers, typically at the information node scale [172]. As more nodes are connected, the coverage area becomes more significant, thus sacrificing latency. Notable exceptions are optical fiber and the 5G and NB-PLC, which are all expensive and difficult to deploy.

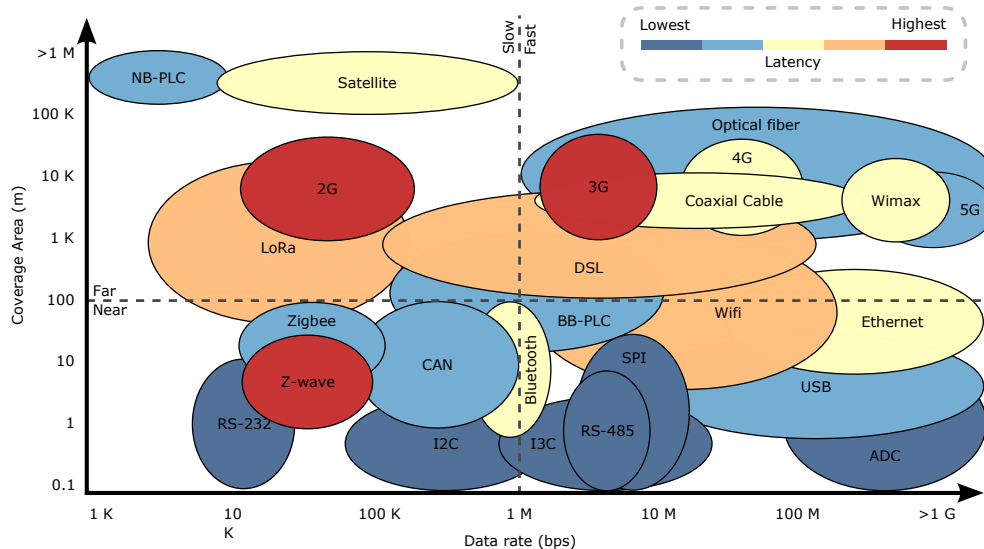

**Figure 8.** Classification of communication technology for microgrid, inspired by [93].

A microgrid will invariably deploy a mix of different communication links. These links must be chosen wisely, and objective thresholds must be set for their operation to track the sustainability of the information field from the communication perspective.

## 5. Financial Field

The financial field of a microgrid is built on two aspects: governance and ownership [22]. Put together, they provide the business model of the microgrid [173] and materialize the strategic objectives [174]. This business model can incur in a more or less centralized ownership [175], and the strategy can be implemented via a more or less centralized governance [176]. Elements, architectures, and issues, by consequence, will also be proposed around these two aspects throughout this section.

### 5.1. Financial Elements

Microgrids are complex economic systems that integrate multiple classes of assets. These assets can have one or several owners, including the community, utilities, private stakeholders or public companies. All these owners have different roles in the microgrid, various sorts of economic interactions with each other and somehow fund the operation and maintenance of the microgrid in the long term [177].

The elements of the financial field regroup the different owners of the microgrid into four groups: consumers, producers, maintainers, and prosumers. Consumers use the microgrid, producers own energy assets, maintainers operate the microgrid, and prosumers own energy assets and use and maintain a part of the microgrid.

Each has a different ownership and governance role according to the business model of the microgrid.

### 5.2. Financial Architecture

In this work, the business model of a microgrid is the equivalent of its financial architecture. It is the tool through which the choices in ownership and governance are made and the strategic objectives of the microgrid are set. From the literature, three main microgrid business models or financial architectures can be pointed out: gathered business model, federated business model, and networked business model [84,178]. These architectures are illustrated in Figure 9 and detailed in Table 8.

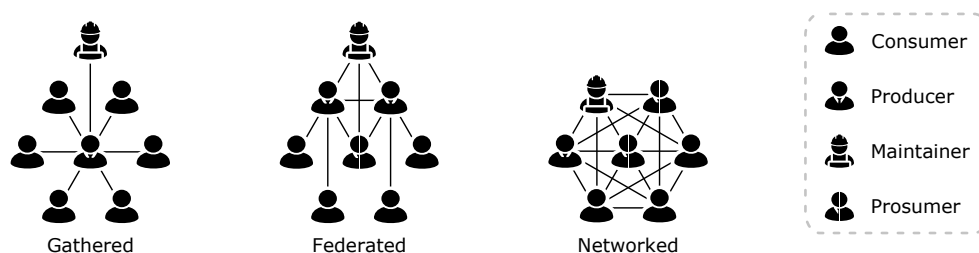

Figure 9. Representation of the different financial architectures.

Table 8. Classification of microgrid business model architecture.

Architecture	Type	Description	Articles
<b>Gathered</b> —One main owner and maintainer of the microgrid [22]	Government utility ownership	The microgrid is owned by a public entity which takes care of its entire operation	[179]
	Third-party ownership	The microgrid is owned by a private entity which takes care of its operation	[58]
	Anchor customer business model	The owner cooperates with a large infrastructure to ensure a minimum energy consumption	[180]
	Productive use of energy	The microgrid is linked with small businesses to ensure minimum revenues	[181]
	Pay as you go	The community has more flexibility with its consumption of energy, paying just what they consume	[182]
<b>Federated</b> —Multiple owners and maintainers of the microgrid [175]	Mixed ownership	Customers own a part of the microgrid	[183]
	Community-owned microgrid	The community owns the microgrid and takes care of its operation	[184]
	Distributed model	A centralized entity owns the microgrid but shares the governance with the community	[185]
	Energy as a service	The business model focuses on the best energy quality possible to develop the community	[186–188]
	ICES	Integrated community energy system where the community participates in optimizing production	[189]
<b>Networked</b> —Community owns and operates the microgrid [192]	Virtual power plant	Prosumers can be assembled in a bigger entity that facilitates the operation of the microgrid	[190,191]
	Standalone systems	The combination of a distributed energy resource and a storage system allowing anybody to create their own microgrid	[129,193]
	Decentralized prosumers	Prosumers are connected together in a decentralized way, and each actor takes care of its own sources, exchanging energy with a peer-to-peer market	[118,194,195]
	Blockchain-based energy market	A decentralized peer-to-peer market where the price of energy fluctuates depending on the demand with some blockchains applications	[118,196–198]
	Energy internet model	The community is connected through a decentralized online tool for a network organization	[199]

It is essential to notice some similarities between the financial and the information architectures. The level of centralization of the control, the data, and the communication of the microgrid information nodes will be impacted or driven by the level of centralization of governance and ownership built into the financial architecture. An example from the literature is that a microgrid with a hierarchical information architecture will have a federated business model with different owners in different parts of the information pyramid [194,195].

### 5.3. Financial Issues

The literature points to three critical financial issues that must be addressed to ensure the economic sustainability of a microgrid: techno-economic design, management, and long-term planning [10,18,179,200].

Techno-economic design is based on the calculation of the Levelized Cost of Energy (LCOE) of the microgrid based on the sum of its costs (Capital Expenditure (CAPEX), Maintenance and Operational Expenditure (OPEX)) and the forecast of produced energy [51]. The challenge of techno-economic design is that there are assumptions regarding inflation, discount rates, downtime, and consumer payment default among others, which can alter the analysis of the feasibility of a microgrid. Many studies address the problem of rightly estimating the LCOE of a microgrid by highlighting the importance of a preliminary feasibility study of the microgrid [52,53], providing a rigorous framework [54], estimating the correct business model [56], and evaluating the different constraints [55] to better understand the local context and user needs. The same goes for taking into account good practices that have been identified in different case studies to make better assumptions when estimating the chances of success of new microgrid projects [69,201]. Finally, some studies go a little deeper by providing complete models for microgrid deployment [202], systemic methods for microgrid design [51,203], or techno-economic optimization frameworks [204,205].

Management handles the day-to-day cash flow of the microgrid [57–60], and it can be summarized as maintenance and collection of payments [61,62]. Maintenance costs money but is imperative for the operation of the microgrid. It requires trained and qualified personnel together with the proper equipment [10,62]. The collection of payments provides money to the microgrid but requires a particular organization and staff to ensure its correct execution [19,206,207]. More intelligent microgrids have automated and optimized payments, which greatly facilitate collection [208,209].

Long-term planning is at the same time forward-looking and backwards-looking in nature [63].

Forward-looking planning tries to anticipate and smooth transitions, especially if the acquisition of new equipment and expansion is involved [64,65]. Backwards-looking planning inventories are recurring problems that must be addressed when new investments become necessary [7,66,67]. The literature has proposed several methodologies to guarantee the integrity and the execution of the planning process [210,211].

The financial issues change over time and can be seen through a before, during, and after deployment framework. Before deployment, a techno-economic study must address the most relevant aspects of ownership and governance to minimize the LCOE of the microgrid and maximize its likelihood of success. During deployment, management must strike a balance between minimizing maintenance costs, providing good service, and maximizing payment collection. Post-deployment refers to long-term planning that anticipates investments to replace equipment and expand services while keeping the LCOE low.

## 6. Social Field

The social field of a microgrid relates to the complex socio-cultural aspects around its implementation [212]. The literature points to the notion of social acceptance as a simple way to express the shaping of a community to a new technology [213] despite a lack of consensus on its definition [214,215]. In this work, social acceptance will be defined as “not



simply a set of static attitudes of individuals; instead it refers more broadly to social relationships and organizations, and it is dynamic as it is shaped in learning processes" [216], and it will be used to determine the sustainability of the microgrid in the social field [217].

### 6.1. Social Elements

The most basic social element used in this work is social groups which are composed of individuals who share common interests [218]. The group containing all individuals who relate directly or indirectly to a microgrid will be called, in this work, the community of the microgrid. The literature highlights three major social groups within the community of the microgrid [29,88,219–221]: individuals that use the microgrid, individuals that own and/or maintain the microgrid, and policymakers and/or representatives.

As described in Figure 10, some individuals will simultaneously belong to several of these groups and will see their acceptance influenced by a multi-group perception.

These actors will have a more complex acceptance description because they have varied interests. We can take the example of prosumers who are both users of the microgrid but also producers and managers of energy; a village mayor who uses the microgrid would be part of the user and socio-political group at the same time; or a public entity that installs a microgrid would be integrated into the manager and socio-political groups.

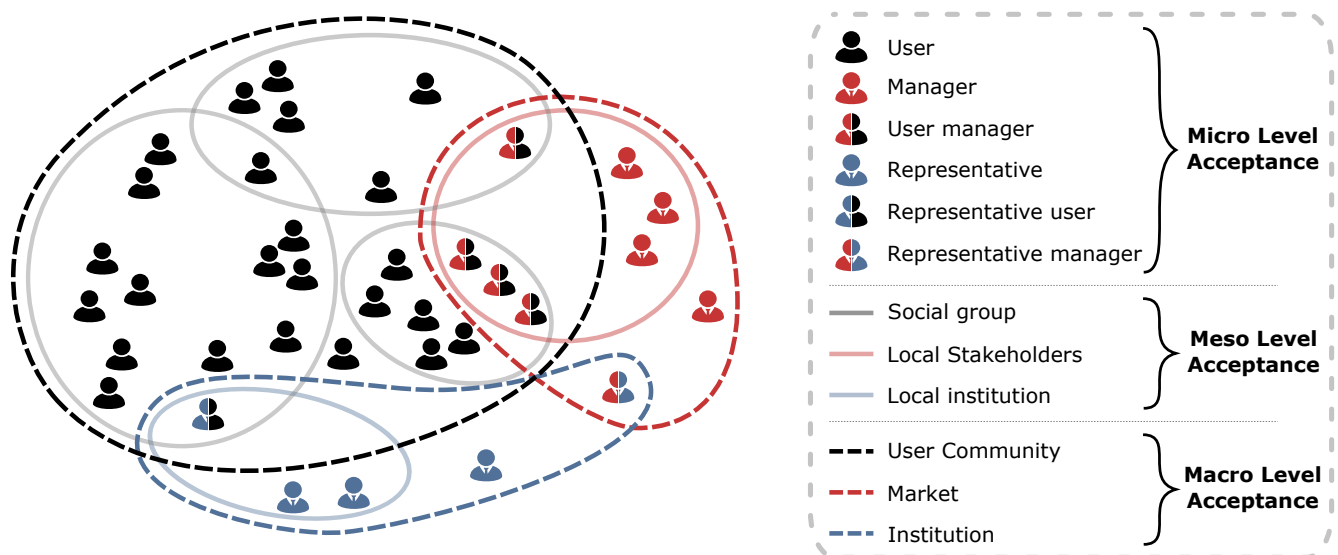

Figure 10. Representation of the different social architectures.

### 6.2. Social Architecture

In order to better understand the acceptance of the community of the microgrid, it is necessary to establish an architecture linking in a simple but realistic way the acceptance of all the groups that compose it. From the literature, this social architecture can be represented by three layers [222–224] which are the macro level, the meso level, and the micro level. Figure 10 shows this architecture.

The macro level refers to the entire community of the microgrid and represents its global acceptance. The meso level represents the different social groups described by the three social elements. The micro level represents the individuals themselves.

The social acceptance of the microgrid will be different depending on the type of group and its layer [224]. The social acceptance of the microgrid of the groups these individuals belong to will influence social acceptance of the microgrid at an individual level. In turn, these different groups will shape their social acceptance of the microgrid based on the overall community of the microgrid [225]. These interactions are bi-directional, meaning that they can go from a lower to a higher layer and vice-versa [226]. Table 9 describes the acceptance at each layer and for each social group.

**Table 9.** Cross-analysis between social elements, social architecture, and their acceptance [224].

		Social Architecture Layers		
		Macro Layer	Meso Layer	Micro Layer
Social elements	User	<b>Public acceptance:</b> all the groups containing end-users [227]	<b>Local public acceptance:</b> groups and organizations of end-users [228]	<b>End-user acceptance:</b> households and individual end-users [229]
	Owner/Manager	<b>Market acceptance:</b> all the groups containing owners/managers [230,231]	<b>Local stakeholder acceptance:</b> groups and organizations of owners/managers [232]	<b>Owner/Manager acceptance:</b> local companies and/or individual owners/managers [222]
	Policy/Decision-maker	<b>Socio-political acceptance:</b> all the groups containing policy/decision-makers [233,234]	<b>Local political acceptance:</b> groups and organizations of policy/decision-makers [235]	<b>Policy/Decision-maker acceptance:</b> local government bodies and/or individual policy/decision-makers

### 6.3. Social Issues

The core social issue is the communication and the social interactions necessary to shape its social acceptance. The literature points to three defining factors in shaping social acceptance of microgrids: the knowledge about the microgrid, the rules that govern the microgrid, and the perception of the microgrid [76,224,236,237].

The knowledge of the community is about the level of social awareness of the technology of microgrids and the level of education of the individuals relating to the use or production of energy [68]. Communication shaped around the comprehension of the technology is critical for its social acceptance because it allows the community to understand and correctly use the technology. Microgrids are an excellent tool to contribute to the development of remote communities by unlocking and teaching new skills to local people [69]. The quantification and propagation of this knowledge are highly beneficial for the development and operation of microgrids [70].

The perception of the microgrid relates to how the technology changes the narrative of the individuals and the groups [74,75]. This community perception will be strongly related to how well the microgrid improves or does not improve the local quality of life [76] but also by the general confidence of the community in the entire microgrid system [216]. Communication about the benefits of the microgrid [238] and transparency on its nuisances requires a highly qualified management team that takes into account the vision of the community [239].

The rules that govern the microgrid should contain good planning for a clear vision of the project, transparent and sustainable ownership, and appropriate pricing and respect for community territoriality and culture in its governance [71]. The local or national policy is often a barrier to microgrid development, and policy regulations must address social needs and feedback [72]. Communicating about these rules allows the community to integrate the technology more easily into their daily habits, raising their acceptance [73].

It must be stressed that this communication effort is permanent. The management team of the microgrid must integrate into their work the effort of addressing the knowledge, the rules, and the perception of the different groups within the microgrid at their different layers. This requires different strategies, some of which are summarized in Table 10.

**Table 10.** Different strategies for social acceptance based on the elements' acceptance.

	Social Acceptance Issues		
	Knowledge	Rules	Perception
Social acceptance elements	User community	Educational events, door-to-door campaigns, usage tutorials, community maintenance engagement [240,241]	Preliminary community survey, community feedback framework on rules acceptance [242]
	Market	Training sessions, microgrid knowledge sharing locally or on the web [240,241]	Detailed business model documentation, microgrid design co-construction with the user community [246,247]
	Institution	Microgrid policy training, energy educational programs, practical experience report [30]	Impact workshop design, detailed ownership and governance definition [250]

## 7. Discussion

The objective of this literature review on microgrid sustainability was to reconcile different views of “energy” and “community” microgrid into a single, systemic, and comprehensive approach through the four fields detailed above. This section will take a step further and propose an integrated analysis of these fields and essential aspects currently missing in the literature.

### 7.1. On the Lack of Studies on the Interdependence of Issues

While all the proposed fields were analyzed through the same methodology, their issues are very different. However, despite their differences, the issues seem to be interdependent. The technical choices of the microgrid energy hardware will have repercussions on the control, data, and communication design choices. Information issues, in turn, are influenced by (or influence) business model choices. All of this will impact the communication strategy to promote system acceptance. There is an evident lack, in the literature, of studies on this interdependence of issues.

### 7.2. On the Lack of a Sustainability Diagnosis Tool

At any given moment of the lifetime of a microgrid, its sustainability can be impacted by changes in any of the issues of its fields. Given the multitude of factors, it is essential to derive a diagnosis tool capable of giving clear feedback to microgrid owners/managers about its sustainability in the short, medium, and long term. Studies that couple different sustainability dynamics in the four fields are currently lacking in the literature. These studies could also use digital twins to monitor the evolution of microgrid sustainability in real time.

### 7.3. On the Lack of an Integrated Microgrid Design Methodology

Microgrid design emerged as an explicit issue for energy and finance and as an implicit issue for the communication and social domains. Different aspects of the domains require different design considerations and methodologies, which will impact the design of the other domains. The technical designs of microgrids are already highly mature and can make highly efficient and flexible microgrids. However, the sizing of the energy market that will surround the microgrid is much more complex to adapt to the local situation. It was also seen that social aspects are central to the long-term sustainability of microgrids and that without participation, acceptance, and positive impact, the microgrid is likely to struggle to survive. The design of microgrids must therefore be able to take all these factors

into account at an early stage, and the impacts on design differences must also be better understood in the literature. Studies on different integrated design methodologies are also lacking in the literature.

#### *7.4. On the Lack of a Systemic Model for Microgrid Study and Simulation*

Microgrid modeling usually focuses on mathematical equations of its energy field and some decision making of the control part of the information field [31]. A few models handle the economic dynamics of microgrids [54], usually focusing on calculating its LCOE [51]. Complex systems are increasingly modeled in a multidisciplinary way to represent the system as closely as possible to reality, as in transport [251], energy in the broad sense [252], and other socio-technical systems [253]. There is currently no model in the literature capable of simulating and studying a microgrid from a systemic perspective that covers all of its fields. A new microgrid modeling approach should deeply consider representing every element of the microgrid system as well as its interconnections.

#### *7.5. On the Lack of Studies on the Expansion of a Microgrid System*

Expansion of microgrids is a long-term issue related to its planning and, indirectly, to its sustainability. As an example, stand-alone systems are prevalent and successful examples of microgrids that are designed for expansion [129,193]. The expansion impacts all the fields, creating a system that changes over time. Multiple Micro Grid [254,255] is also an emerging topic in microgrid systems. It relates to their expansion and inter-operation and can benefit from the analysis proposed in this work to better choose the necessary interconnection algorithms [256,257], which vary with the microgrid architecture. Future studies in expansion should consider its multi-field dimension and evaluate how an expansion can impact the sustainability of the microgrid.

## **8. Conclusions**

Microgrids are a promising technology for energy access, but their recurrent failures are still not fully understood by the scientific community. Energy microgrids and community microgrids have too often been studied separately, but for the understanding of these failures, the study of the system as a whole seems more relevant to detecting the problems. This article addresses this issue by proposing a new systemic overview of microgrids which unifies the representation of energy, information, financial, and social fields. Every field was described by elements, architectures, and issues. This novel unified field structure allows the study of the sustainability of microgrids through cross-comparison of issues.

For the energy field, the main issue is its appropriate sizing with suitable quality components and appropriate system protection. This field has been extensively studied and appears to be relatively mature in its implementation within microgrids. Likely, advances in this area will mainly improve the technologies' overall efficiency or help reduce their economic and environmental costs.

For the information field, the issues are driven by data, control, and communication considerations. This field poses many challenges for the future sustainability of microgrids. Energy management algorithms must be able to adapt to ever more complex microgrid architectures and ever higher efficiency demands. Furthermore, the issue of microgrid interoperability remains central, even if significant steps forward have been made to find generalized and effective solutions for connecting several grids.

The financial field has the issue of appropriate technico-economic design, financial management, and long-term planning for expansion and investment. This field should not be limited to a balanced cost/revenue balance; the financial field within microgrids is in charge of the connection between users and managers. For the long-term sustainability of the local electricity market, the business model must involve both the consumers and the energy market and find the balance between governance and overownership. Many new business models are emerging that consider the current local situation to provide the most appropriate solution from the most gathered to the most networked.

The social field issues focus on acceptance, which is based on knowledge of the technology, understanding its usage rules, and building a positive perception of its usage. This area must remain central to the study of microgrids as it is the center of production, the end goal being to produce a quantity of energy that provides some work to a user. Acceptance of a microgrid is therefore major for its sustainability, allowing for ease of operation, utility support, and market participation. Real long-term studies should be encouraged to measure and better understand the impacts of this acceptance and to provide solutions that best improve the quality of life of users.

Few articles in the literature attempt to link these different fields simultaneously. While this work presents an isolated, albeit unified, description of the fields, their causal links, events, and dependencies have yet to be precisely determined. These links should lead to systemic modeling of the microgrid along with its short, medium, and long-term dynamics. Based on this systemic vision, other future work should study microgrid sustainability, viability, scalability, and expansion.

**Author Contributions:** Conceptualization, A.B.; methodology, A.B.; validation, A.B., L.F.L.V. and C.F.; writing—original draft preparation, A.B.; writing—review and editing, A.B., L.F.L.V. and C.F.; visualization, A.B.; supervision, L.F.L.V. and C.F.; project administration, A.B., L.F.L.V. and C.F. All authors have read and agreed to the published version of the manuscript.

**Funding:** This research received no external funding.

**Institutional Review Board Statement:** Not applicable.

**Informed Consent Statement:** Not applicable.

**Data Availability Statement:** Not applicable.

**Conflicts of Interest:** The authors declare no conflict of interest.

## References

1. Nations, U. Sustainable UN. *Dev. Goal* **2019**, *7*. Available online: <https://sdgs.un.org/goals/goal7> (accessed on 6 April 2019).
2. World Bank. *More People Have Access to Electricity Than Ever Before, but World Is Falling Short of Sustainable Energy Goals*; Available online: <https://www.worldbank.org/en/news/press-release/2019/05/22/tracking-sdg7-the-energy-progress-report-2019> (accessed on 6 April 2019).
3. The Evolution of Distributed Energy Resources. *Microgrid Knowl.* **2020**. Available online: <https://microgridknowledge.com/white-paper/evolution-distributed-energy-resources/> (accessed on 6 April 2020).
4. Chatterjee, A.; Burmester, D.; Brent, A.; Rayudu, R. Research Insights and Knowledge Headways for Developing Remote, Off-Grid Microgrids in Developing Countries. *Energies* **2019**, *12*, 2008. [[CrossRef](#)]
5. Narayan, N.; Vega-Garita, V.; Qin, Z.; Popovic-Gerber, J.; Bauer, P.; Zeman, M. The Long Road to Universal Electrification: A Critical Look at Present Pathways and Challenges. *Energies* **2020**, *13*, 508. [[CrossRef](#)]
6. Tenenbaum, B.; Greacen, C.; Siyambalapitiya, T.; Knuckles, J. *From the Bottom Up: How Small Power Producers and Mini-Grids Can Deliver Electrification and Renewable Energy in Africa*; Directions in Development—Energy and Mining; The World Bank: Washington, DC, USA, 2014. [[CrossRef](#)]
7. Hanna, R.; Ghonima, M.; Kleissl, J.; Tynan, G.; Victor, D.G. Evaluating business models for microgrids: Interactions of technology and policy. *Energy Policy* **2017**, *103*, 47–61. [[CrossRef](#)]
8. Schwieters, N. *Delphi Energy Future 2040*. **2016**. Available online: <https://www.pwc.com/gx/en/energy-utilities-mining/pdf/delphi-energy-future.pdf> (accessed on 6 April 2016).
9. Ubilla, K.; Jiménez-Estévez, G.A.; Hernández, R.; Reyes-Chamorro, L.; Hernández Irigoyen, C.; Severino, B.; Palma-Behnke, R. Smart Microgrids as a Solution for Rural Electrification: Ensuring Long-Term Sustainability Through Cadastre and Business Models. *IEEE Trans. Sustain. Energy* **2014**, *5*, 1310–1318. [[CrossRef](#)]
10. Khodayar, M.E. Rural electrification and expansion planning of off-grid microgrids. *Electr. J.* **2017**, *30*, 68–74. [[CrossRef](#)]
11. Santos, A.Q.; Ma, Z.; Olsen, C.G.; Jørgensen, B.N. Framework for Microgrid Design Using Social, Economic, and Technical Analysis. *Energies* **2018**, *11*, 2832. [[CrossRef](#)]
12. Kanagawa, M.; Nakata, T. Assessment of access to electricity and the socio-economic impacts in rural areas of developing countries. *Energy Policy* **2008**, *36*, 2016–2029. [[CrossRef](#)]
13. Suk, H.; Yadav, A.; Hall, J. Scalability Considerations in the Design of Microgrids to Support Socioeconomic Development in Rural Communities. In Proceedings of the ASME International Mechanical Engineering Congress and Exposition, American Society of Mechanical Engineers, Pittsburgh, PA, USA, 9–15 November 2018; Volume 52187, p. V013T05A068.

14. Gunnarsdottir, I.; Davidsdottir, B.; Worrell, E.; Sigurgeirsdottir, S. Sustainable energy development: History of the concept and emerging themes. *Renew. Sustain. Energy Rev.* **2021**, *141*, 110770. [[CrossRef](#)]
15. Shah Danish, M.S.; Senjyu, T.; Funabashia, T.; Ahmadi, M.; Ibrahimi, A.M.; Ohta, R.; Rashid Howlader, H.O.; Zaheb, H.; Sabory, N.R.; Sediqi, M.M. A sustainable microgrid: A sustainability and management-oriented approach. *Energy Procedia* **2019**, *159*, 160–167. [[CrossRef](#)]
16. Gaona, E.E.; Trujillo, C.L.; Guacaneme, J.A. Rural microgrids and its potential application in Colombia. *Renew. Sustain. Energy Rev.* **2015**, *51*, 125–137. [[CrossRef](#)]
17. Cust, J.; Singh, A.; Neuhooff, K. *Rural Electrification in India: Economic and Institutional Aspects of Renewables*; Technical Report ID 2760810; SSRN: Rochester, NY, USA, 2007. [[CrossRef](#)]
18. Schnitzer, D.; Lounsbury, D.S.; Carvallo, J.P.; Deshmukh, R.; Apt, J.; Kammen, D.M. *Microgrids for Rural Electrification: A Critical Review of Best Practices Based on Seven Case Studies*; United Nations Foundation: New York, NY, USA, 2014.
19. Almeshqab, F.; Ustun, T.S. Lessons learned from rural electrification initiatives in developing countries: Insights for technical, social, financial and public policy aspects. *Renew. Sustain. Energy Rev.* **2019**, *102*, 35–53. [[CrossRef](#)]
20. Hartvigsson, E. *To Be or Not to Be: On System Dynamics and the Viability of Mini-Grids in Rural Electrification*; Chalmers Tekniska Hogskola: Göteborg, Sweden, 2018.
21. Tsikalakis, A.G.; Hatziargyriou, N.D. Centralized control for optimizing microgrids operation. In Proceedings of the 2011 IEEE Power and Energy Society General Meeting, Detroit, MI, USA, 24–28 July 2011; pp. 1–8. [[CrossRef](#)]
22. Gui, E.M.; Diesendorf, M.; MacGill, I. Distributed energy infrastructure paradigm: Community microgrids in a new institutional economics context. *Renew. Sustain. Energy Rev.* **2017**, *72*, 1355–1365. [[CrossRef](#)]
23. Hossain, M.A.; Pota, H.R.; Hossain, M.J.; Blaabjerg, F. Evolution of microgrids with converter-interfaced generations: Challenges and opportunities. *Int. J. Electr. Power Energy Syst.* **2019**, *109*, 160–186. [[CrossRef](#)]
24. Sen, S.; Kumar, V. Microgrid control: A comprehensive survey. *Annu. Rev. Control* **2018**, *45*, 118–151. [[CrossRef](#)]
25. Hossain, M.A.; Pota, H.R.; Issa, W.; Hossain, M.J. Overview of AC Microgrid Controls with Inverter-Interfaced Generations. *Energies* **2017**, *10*, 1300. [[CrossRef](#)]
26. Shahgholian, G. A brief review on microgrids: Operation, applications, modeling, and control. *Int. Trans. Electr. Energy Syst.* **2021**, *31*, e12885. [[CrossRef](#)]
27. Giotitsas, C.; Nardelli, P.H.J.; Kostakis, V.; Narayanan, A. From private to public governance: The case for reconfiguring energy systems as a commons. *Energy Res. Soc. Sci.* **2020**, *70*, 101737. [[CrossRef](#)]
28. Syed, M.M.; Morrison, G.M. A Rapid Review on Community Connected Microgrids. *Sustainability* **2021**, *13*, 6753. [[CrossRef](#)]
29. Gjorgievski, V.Z.; Cundeve, S.; Georghiou, G.E. Social arrangements, technical designs and impacts of energy communities: A review. *Renew. Energy* **2021**, *169*, 1138–1156. [[CrossRef](#)]
30. Akinyele, D.; Belikov, J.; Levron, Y. Challenges of Microgrids in Remote Communities: A STEEP Model Application. *Energies* **2018**, *11*, 432. [[CrossRef](#)]
31. Sen, S.; Kumar, V. Microgrid modelling: A comprehensive survey. *Annu. Rev. Control* **2018**, *46*, 216–250. [[CrossRef](#)]
32. Al-Ismail, F.S. DC Microgrid Planning, Operation, and Control: A Comprehensive Review. *IEEE Access* **2021**, *9*, 36154–36172. [[CrossRef](#)]
33. Sandelic, M.; Peyghami, S.; Sangwongwanich, A.; Blaabjerg, F. Reliability aspects in microgrid design and planning: Status and power electronics-induced challenges. *Renew. Sustain. Energy Rev.* **2022**, *159*, 112127. [[CrossRef](#)]
34. Chandak, S.; Rout, P.K. The implementation framework of a microgrid: A review. *Int. J. Energy Res.* **2021**, *45*, 3523–3547. [[CrossRef](#)]
35. Gacitua, L.; Gallegos, P.; Henriquez-Auba, R.; Lorca, Á.; Negrete-Pincetic, M.; Olivares, D.; Valenzuela, A.; Wenzel, G. A comprehensive review on expansion planning: Models and tools for energy policy analysis. *Renew. Sustain. Energy Rev.* **2018**, *98*, 346–360. [[CrossRef](#)]
36. Ardeshiri, A.; Lotfi, A.; Behkam, R.; Moradzadeh, A.; Barzkar, A. *Introduction and Literature Review of Power System Challenges and Issues*; Springer International Publishing: Cham, Switzerland, 2021; pp. 19–43. [[CrossRef](#)]
37. Suri, D.; Shekhar, J.; Mukherjee, A.; Singh Bajaj, A. Designing Microgrids for Rural Communities: A Practitioner Focused Mini-Review. In Proceedings of the 2020 IEEE International Conference on Environment and Electrical Engineering and 2020 IEEE Industrial and Commercial Power Systems Europe (EEEIC/I CPS Europe), Madrid, Spain, 9–12 June 2020; pp. 1–6. [[CrossRef](#)]
38. Hooshyar, A.; Iravani, R. Microgrid Protection. *Proc. IEEE* **2017**, *105*, 1332–1353. [[CrossRef](#)]
39. Sarangi, S.; Sahu, B.K.; Rout, P.K. A comprehensive review of distribution generation integrated DC microgrid protection: Issues, strategies, and future direction. *Int. J. Energy Res.* **2021**, *45*, 5006–5031. [[CrossRef](#)]
40. Sarangi, S.; Sahu, B.K.; Rout, P.K. Review of distributed generator integrated AC microgrid protection: Issues, strategies, and future trends. *Int. J. Energy Res.* **2021**, *45*, 14117–14144. [[CrossRef](#)]
41. Dagar, A.; Gupta, P.; Niranjana, V. Microgrid protection: A comprehensive review. *Renew. Sustain. Energy Rev.* **2021**, *149*, 111401. [[CrossRef](#)]
42. Najafzadeh, M.; Ahmadiyahangar, R.; Husev, O.; Roasto, I.; Jalakas, T.; Blinov, A. Recent Contributions, Future Prospects and Limitations of Interlinking Converter Control in Hybrid AC/DC Microgrids. *IEEE Access* **2021**, *9*, 7960–7984. [[CrossRef](#)]
43. Cheng, Z.; Duan, J.; Chow, M.Y. To Centralize or to Distribute: That Is the Question: A Comparison of Advanced Microgrid Management Systems. *IEEE Ind. Electron. Mag.* **2018**, *12*, 6–24. [[CrossRef](#)]

44. Moharm, K. State of the art in big data applications in microgrid: A review. *Adv. Eng. Inform.* **2019**, *42*, 100945. [[CrossRef](#)]
45. Zhang, Y.; Huang, T.; Bompard, E.F. Big data analytics in smart grids: A review. *Energy Inform.* **2018**, *1*, 8. [[CrossRef](#)]
46. Huaiying, S.; Yan, L.; Angang, Z.; Songfeng, Q.; Yong, W.; Wulei, Z. Research on Technical Architecture and Application of Big Data Cloud Platform for Electric Power Measurement. *J. Phys. Conf. Ser.* **2019**, *1213*, 042040. [[CrossRef](#)]
47. Ruiguang, M.A.; Haiyan, W.; Quanming, Z.; Yuan, L. Technical Research on the Electric Power Big Data Platform of Smart Grid. *MATEC Web Conf.* **2017**, *139*, 00217. [[CrossRef](#)]
48. Khan, M.A.u.d.; Uddin, M.F.; Gupta, N. Seven V's of Big Data understanding Big Data to extract value. In Proceedings of the 2014 Zone 1 Conference of the American Society for Engineering Education, Bridgeport, CT, USA, 3–5 April 2014; pp. 1–5. [[CrossRef](#)]
49. Serban, I.; Céspedes, S.; Marinescu, C.; Azurdia-Meza, C.A.; Gómez, J.S.; Hueichapan, D.S. Communication Requirements in Microgrids: A Practical Survey. *IEEE Access* **2020**, *8*, 47694–47712. [[CrossRef](#)]
50. Faheem, M.; Shah, S.B.H.; Butt, R.A.; Raza, B.; Anwar, M.; Ashraf, M.W.; Ngadi, M.A.; Gungor, V.C. Smart grid communication and information technologies in the perspective of Industry 4.0: Opportunities and challenges. *Comput. Sci. Rev.* **2018**, *30*, 1–30. [[CrossRef](#)]
51. Veilleux, G.; Potisat, T.; Pezim, D.; Ribback, C.; Ling, J.; Krysztofinski, A.; Ahmed, A.; Papenheim, J.; Pineda, A.M.; Sembian, S.; et al. Techno-economic analysis of microgrid projects for rural electrification: A systematic approach to the redesign of Koh Jik off-grid case study. *Energy Sustain. Dev.* **2020**, *54*, 1–13. [[CrossRef](#)]
52. Murugaperumal, K.; Ajay D Vimal Raj, P. Feasibility design and techno-economic analysis of hybrid renewable energy system for rural electrification. *Solar Energy* **2019**, *188*, 1068–1083. [[CrossRef](#)]
53. Emmanouil, S.; Philhower, J.; Macdonald, S.; Khadim, F.K.; Yang, M.; Atsbeha, E.; Nagireddy, H.; Roach, N.; Holzer, E.; Anagnostou, E.N. A Comprehensive Approach to the Design of a Renewable Energy Microgrid for Rural Ethiopia: The Technical and Social Perspectives. *Sustainability* **2021**, *13*, 3974. [[CrossRef](#)]
54. Mandelli, S.; Barbieri, J.; Mereu, R.; Colombo, E. Off-grid systems for rural electrification in developing countries: Definitions, classification and a comprehensive literature review. *Renew. Sustain. Energy Rev.* **2016**, *58*, 1621–1646. [[CrossRef](#)]
55. Domenech, B.; Ferrer-Martí, L.; Lillo, P.; Pastor, R.; Chiroque, J. A community electrification project: Combination of microgrids and household systems fed by wind, PV or micro-hydro energies according to micro-scale resource evaluation and social constraints. *Energy Sustain. Dev.* **2014**, *23*, 275–285. [[CrossRef](#)]
56. Leary, J.; Czyrnek-Delêtre, M.; Alsop, A.; Eales, A.; Marandin, L.; Org, M.; Craig, M.; Ortiz, W.; Casillas, C.; Persson, J.; et al. Finding the niche: A review of market assessment methodologies for rural electrification with small scale wind power. *Renew. Sustain. Energy Rev.* **2020**, *133*, 110240. [[CrossRef](#)]
57. Eras-Almeida, A.A.; Fernández, M.; Eisman, J.; Martín, J.G.; Caamaño, E.; Egado-Aguilera, M.A. Lessons Learned from Rural Electrification Experiences with Third Generation Solar Home Systems in Latin America: Case Studies in Peru, Mexico, and Bolivia. *Sustainability* **2019**, *11*, 7139. [[CrossRef](#)]
58. Williams, N.J.; Jaramillo, P.; Taneja, J.; Ustun, T.S. Enabling private sector investment in microgrid-based rural electrification in developing countries: A review. *Renew. Sustain. Energy Rev.* **2015**, *52*, 1268–1281. [[CrossRef](#)]
59. Cornélusse, B.; Savelli, I.; Paoletti, S.; Giannitrapani, A.; Vicino, A. A community microgrid architecture with an internal local market. *Appl. Energy* **2019**, *242*, 547–560. [[CrossRef](#)]
60. Levin, T.; Thomas, V.M. Utility-maximizing financial contracts for distributed rural electrification. *Energy* **2014**, *69*, 613–621. [[CrossRef](#)]
61. Khandker, S.R.; Barnes, D.F.; Samad, H.A. Welfare Impacts of Rural Electrification: A Panel Data Analysis from Vietnam. *Econ. Dev. Cult. Chang.* **2013**, *61*, 659–692. [[CrossRef](#)]
62. Lillo, P.; Ferrer-Martí, L.; Boni, A.; Fernández-Baldor, Á. Assessing management models for off-grid renewable energy electrification projects using the Human Development approach: Case study in Peru. *Energy Sustain. Dev.* **2015**, *25*, 17–26. [[CrossRef](#)]
63. Gui, E.M.; MacGill, I.; Betz, R. Community Microgrid Investment Planning: A Conceptual Framework. In Proceedings of the 2018 IEEE International Smart Cities Conference (ISC2), Kansas City, MO, USA, 16–19 September 2018; pp. 1–5. [[CrossRef](#)]
64. Vahidinasab, V.; Tabarzadi, M.; Arasteh, H.; Alizadeh, M.I.; Mohammad Beigi, M.; Sheikhzadeh, H.R.; Mehran, K.; Sepasian, M.S. Overview of Electric Energy Distribution Networks Expansion Planning. *IEEE Access* **2020**, *8*, 34750–34769. [[CrossRef](#)]
65. Wyse, S.M.; Hoicka, C.E. “By and for local people”: Assessing the connection between local energy plans and community energy. *Local Environ.* **2019**, *24*, 883–900. [[CrossRef](#)]
66. Parag, Y.; Ainspan, M. Sustainable microgrids: Economic, environmental and social costs and benefits of microgrid deployment. *Energy Sustain. Dev.* **2019**, *52*, 72–81. [[CrossRef](#)]
67. Kumar, J.; Suryakiran, B.V.; Verma, A.; Bhatti, T.S. Analysis of techno-economic viability with demand response strategy of a grid-connected microgrid model for enhanced rural electrification in Uttar Pradesh state, India. *Energy* **2019**, *178*, 176–185. [[CrossRef](#)]
68. Rosenthal-Sabroux, C.; Grundstein, M. A Global Vision of Information Management. In Proceedings of the MoDISE-EUS, Montpellier, France, 16–17 June 2008; pp. 55–66.
69. Kirubi, C.; Jacobson, A.; Kammen, D.M.; Mills, A. Community-Based Electric Micro-Grids Can Contribute to Rural Development: Evidence from Kenya. *World Dev.* **2009**, *37*, 1208–1221. [[CrossRef](#)]

70. Zekaria, Y.; Chitchyan, R. Qualitative study of skills needs for community energy projects. In Proceedings of the Presentación en la Conferencia Sobre Comunidades Energéticas Organizada por Eco-SESA de la Universidad de Grenoble Alpes, Energy Communities for Collective Self-Consumption: Frameworks, Practices and Tools, Grenoble, France, 15 June 2020; Volume 16.
71. Hicks, J.; Ison, N. An exploration of the boundaries of ‘community’ in community renewable energy projects: Navigating between motivations and context. *Energy Policy* **2018**, *113*, 523–534. [[CrossRef](#)]
72. Ali, A.; Li, W.; Hussain, R.; He, X.; Williams, B.W.; Memon, A.H. Overview of Current Microgrid Policies, Incentives and Barriers in the European Union, United States and China. *Sustainability* **2017**, *9*, 1146. [[CrossRef](#)]
73. Derks, M.; Romijn, H. Sustainable performance challenges of rural microgrids: Analysis of incentives and policy framework in Indonesia. *Energy Sustain. Dev.* **2019**, *53*, 57–70. [[CrossRef](#)]
74. Girbau-Llistuella, F.; Sumper, A.; Gallart-Fernandez, R.; Martinez-Farrero, S. *Smart Rural Grid Pilot in Spain*; Woodhead Publishing: Cambridge, UK, 2019; Chapter 14, pp. 315–345. [[CrossRef](#)]
75. Torero, M. The Impact of Rural Electrification: Challenges and Ways Forward. *Rev. d'Econ. Dev.* **2015**, *23*, 49–75. [[CrossRef](#)]
76. Suk, H.; Hall, J. Integrating Quality of Life in Sociotechnical Design: A Review of Microgrid Design Tools and Social Indicators. In Proceedings of the American Society of Mechanical Engineers Digital Collection, Anaheim, CA, USA, 18–21 August 2019. [[CrossRef](#)]
77. Carpintero-Rentería, M.; Santos-Martín, D.; Guerrero, J.M. Microgrids Literature Review through a Layers Structure. *Energies* **2019**, *12*, 4381. [[CrossRef](#)]
78. Martín-Martínez, F.; Sánchez-Miralles, A.; Rivier, M. A literature review of Microgrids: A functional layer based classification. *Renew. Sustain. Energy Rev.* **2016**, *62*, 1133–1153. [[CrossRef](#)]
79. Sachs, T.; Gründler, A.; Rusic, M.; Fridgen, G. Framing Microgrid Design from a Business and Information Systems Engineering Perspective. *Bus. Inf. Syst. Eng.* **2019**, *61*, 729–744. [[CrossRef](#)]
80. Alrashed, S. Key performance indicators for Smart Campus and Microgrid. *Sustain. Cities Soc.* **2020**, *60*, 102264. [[CrossRef](#)]
81. Rahmann, C.; Núñez, O.; Valencia, F.; Arrechea, S.; Sager, J.; Kammen, D. Methodology for Monitoring Sustainable Development of Isolated Microgrids in Rural Communities. *Sustainability* **2016**, *8*, 1163. [[CrossRef](#)]
82. González-Jiménez, J.; Asencio-Yace, J.I.; Pérez-Lugo, M.; Irizarry-Rivera, A. *Compound Index: Reliability, Resilience, and Social Forces for the Sustainability of Isolated Community Microgrids (ICMGs) After Catastrophic Weather Events (CWE)*; INESI: London, UK, 2017.
83. Jadav, K.A.; Karkar, H.M.; Trivedi, I.N. A Review of Microgrid Architectures and Control Strategy. *J. Inst. Eng. (India) Ser.* **2017**, *98*, 591–598. [[CrossRef](#)]
84. Vanadzina, E.; Mendes, G.; Honkapuro, S.; Pinomaa, A.; Melkas, H. Business models for community microgrids. In Proceedings of the 2019 16th International Conference on the European Energy Market (EEM), Ljubljana, Slovenia, 18–20 September 2019; pp. 1–7.
85. Sahoo, S.K.; Sinha, A.K.; Kishore, N.K. Control Techniques in AC, DC, and Hybrid AC–DC Microgrid: A Review. *IEEE J. Emerg. Sel. Top. Power Electron.* **2018**, *6*, 738–759. [[CrossRef](#)]
86. Marzal, S.; Salas, R.; González-Medina, R.; Garcerá, G.; Figueres, E. Current challenges and future trends in the field of communication architectures for microgrids. *Renew. Sustain. Energy Rev.* **2018**, *82*, 3610–3622. [[CrossRef](#)]
87. Espina, E.; Llanos, J.; Burgos-Mellado, C.; Cárdenas-Dobson, R.; Martínez-Gómez, M.; Sáez, D. Distributed Control Strategies for Microgrids: An Overview. *IEEE Access* **2020**, *8*, 193412–193448. [[CrossRef](#)]
88. Wolsink, M. Distributed energy systems as common goods: Socio-political acceptance of renewables in intelligent microgrids. *Renew. Sustain. Energy Rev.* **2020**, *127*, 109841. [[CrossRef](#)]
89. Louie, H.; Dauenhauer, P.; Wilson, M.; Zomers, A.; Mutale, J. Eternal Light: Ingredients for Sustainable Off-Grid Energy Development. *IEEE Power Energy Mag.* **2014**, *12*, 70–78. [[CrossRef](#)]
90. Sirviö, K.H.; Laaksonen, H.; Kauhaniemi, K.; Hatzigiorgiou, N. Evolution of the Electricity Distribution Networks—Active Management Architecture Schemes and Microgrid Control Functionalities. *Appl. Sci.* **2021**, *11*, 2793. [[CrossRef](#)]
91. Danish, M.S.S.; Matayoshi, H.; Howlader, H.R.; Chakraborty, S.; Mandal, P.; Senjyu, T. Microgrid Planning and Design: Resilience to Sustainability. In Proceedings of the 2019 IEEE PES GTD Grand International Conference and Exposition Asia (GTD Asia), Bangkok, Thailand, 19–23 March 2019; pp. 253–258. [[CrossRef](#)]
92. Zia, M.F.; Benbouzid, M.; Elbouchikhi, E.; Muyeen, S.M.; Techato, K.; Guerrero, J.M. Microgrid Transactive Energy: Review, Architectures, Distributed Ledger Technologies, and Market Analysis. *IEEE Access* **2020**, *8*, 19410–19432. [[CrossRef](#)]
93. Zia, M.F.; Elbouchikhi, E.; Benbouzid, M. Microgrids energy management systems: A critical review on methods, solutions, and prospects. *Appl. Energy* **2018**, *222*, 1033–1055. [[CrossRef](#)]
94. Hirsch, A.; Parag, Y.; Guerrero, J. Microgrids: A review of technologies, key drivers, and outstanding issues. *Renew. Sustain. Energy Rev.* **2018**, *90*, 402–411. [[CrossRef](#)]
95. Cagnano, A.; De Tuglie, E.; Mancarella, P. Microgrids: Overview and guidelines for practical implementations and operation. *Appl. Energy* **2020**, *258*, 114039. [[CrossRef](#)]
96. Wei, X.; Xiangning, X.; Pengwei, C. Overview of key microgrid technologies. *Int. Trans. Electr. Energy Syst.* **2018**, *28*, e2566. [[CrossRef](#)]
97. Pinto, R.; Mariano, S.; Calado, M.D.R.; De Souza, J.F. Impact of Rural Grid-Connected Photovoltaic Generation Systems on Power Quality. *Energies* **2016**, *9*, 739. [[CrossRef](#)]



98. Peters, J.; Sievert, M.; Toman, M.A. Rural electrification through mini-grids: Challenges ahead. *Energy Policy* **2019**, *132*, 27–31. [[CrossRef](#)]
99. Mariam, L.; Basu, M.; Conlon, M.F. Microgrid: Architecture, policy and future trends. *Renew. Sustain. Energy Rev.* **2016**, *64*, 477–489. [[CrossRef](#)]
100. Bayindir, R.; Hossain, E.; Kabalci, E.; Perez, R. A Comprehensive Study on Microgrid Technology. *Int. J. Renew. Energy Res.* **2014**, *4*, 1094–1107.
101. Akorede, M.F.; Hizam, H.; Pouresmaeil, E. Distributed energy resources and benefits to the environment. *Renew. Sustain. Energy Rev.* **2010**, *14*, 724–734. [[CrossRef](#)]
102. Gunasekaran, M.; Mohamed Ismail, H.; Chokkalingam, B.; Mihet-Popa, L.; Padmanaban, S. Energy Management Strategy for Rural Communities' DC Micro Grid Power System Structure with Maximum Penetration of Renewable Energy Sources. *Appl. Sci.* **2018**, *8*, 585. [[CrossRef](#)]
103. Habib, H.F.; Lashway, C.R.; Mohammed, O.A. A Review of Communication Failure Impacts on Adaptive Microgrid Protection Schemes and the Use of Energy Storage as a Contingency. *IEEE Trans. Ind. Appl.* **2018**, *54*, 1194–1207. [[CrossRef](#)]
104. Hajiaghahi, S.; Salemnia, A.; Hamzeh, M. Hybrid energy storage system for microgrids applications: A review. *J. Energy Storage* **2019**, *21*, 543–570. [[CrossRef](#)]
105. Parhizi, S.; Lotfi, H.; Khodaei, A.; Bahramirad, S. State of the art in research on microgrids: A review. *IEEE Access* **2015**, *3*, 890–925. [[CrossRef](#)]
106. Takalani, R.; Bekker, B. Load and load growth models for rural microgrids, and how to future-proof designs. In Proceedings of the 2020 International SAUPEC/RobMech/PRASA Conference, Cape Town, South Africa, 29–31 January 2020; pp. 1–6. [[CrossRef](#)]
107. Wang, X.; Guerrero, J.M.; Blaabjerg, F.; Chen, Z. A Review of Power Electronics Based Microgrids. *Int. J. Power Electron.* **2012**, *12*, 181–192. [[CrossRef](#)]
108. Arfeen, Z.A.; Khairuddin, A.B.; Larik, R.M.; Saeed, M.S. Control of distributed generation systems for microgrid applications: A technological review. *Int. Trans. Electr. Energy Syst.* **2019**, *29*, e12072. [[CrossRef](#)]
109. Lede, A.M.R.; Molina, M.G.; Martinez, M.; Mercado, P.E. Microgrid architectures for distributed generation: A brief review. In Proceedings of the 2017 IEEE PES Innovative Smart Grid Technologies Conference—Latin America (ISGT Latin America), Quito, Ecuador, 20–22 September 2017; pp. 1–6. [[CrossRef](#)]
110. Justo, J.J.; Mwasilu, F.; Lee, J.; Jung, J.W. AC-microgrids versus DC-microgrids with distributed energy resources: A review. *Renew. Sustain. Energy Rev.* **2013**, *24*, 387–405. [[CrossRef](#)]
111. Dragicevic, T.; Lu, X.; Vasquez, J.C.; Guerrero, J.M. DC Microgrids—Part II: A Review of Power Architectures, Applications, and Standardization Issues. *IEEE Trans. Power Electron.* **2016**, *31*, 3528–3549. [[CrossRef](#)]
112. Gupta, A.; Doolla, S.; Chatterjee, K. Hybrid AC–DC Microgrid: Systematic Evaluation of Control Strategies. *IEEE Trans. Smart Grid* **2018**, *9*, 3830–3843. [[CrossRef](#)]
113. Petrucci, L.; Boccaletti, C.; Francois, B.; Di Felice, P. Hybrid trigeneration system management with a double DC-bus configuration on the electrical side. In Proceedings of the 2009 8th International Symposium on Advanced Electromechanical Motion Systems Electric Drives Joint Symposium, Lillie, France, 1–3 July 2009; pp. 1–6. [[CrossRef](#)]
114. She, X.; Lukic, S.; Alex, Q.H. DC zonal micro-grid architecture and control. In Proceedings of the IECON 2010—36th Annual Conference on IEEE Industrial Electronics Society, Glendale, AZ, USA, 7–10 November 2010; pp. 2988–2993. [[CrossRef](#)]
115. De Silva, H.; Jayamaha, D.; Lidula, N. Review on design and control of solid state transformer based microgrids. *AIMS Energy* **2019**, *7*, 901–923. [[CrossRef](#)]
116. Chalbi, M.; Boukettaya, G. Review on Solid State Transformer Based on Microgrids Architectures. In Proceedings of the 2021 18th International Multi-Conference on Systems, Signals Devices (SSD), Monastir, Tunisia, 22–25 March 2021; pp. 1120–1126. [[CrossRef](#)]
117. Patrao, I.; Figueres, E.; Garcerá, G.; González-Medina, R. Microgrid architectures for low voltage distributed generation. *Renew. Sustain. Energy Rev.* **2015**, *43*, 415–424. [[CrossRef](#)]
118. Bullich-Massagué, E.; Díaz-González, F.; Aragüés-Peñalba, M.; Girbau-Llistuella, F.; Olivella-Rosell, P.; Sumper, A. Microgrid clustering architectures. *Appl. Energy* **2018**, *212*, 340–361. [[CrossRef](#)]
119. Groh, S.; Philipp, D.; Lasch, B.E.; Kirchhoff, H. Swarm Electrification: Investigating a Paradigm Shift Through the Building of Microgrids Bottom-up. In *Proceedings of the Decentralized Solutions for Developing Economies*; Groh, S., van der Straeten, J., Edlefsen Lasch, B., Gershenson, D., Leal Filho, W., Kammen, D.M., Eds.; Springer International Publishing: Cham, Switzerland, 2015; pp. 3–22. [[CrossRef](#)]
120. Motjoadi, V.; Bokoro, P.N.; Onibonoje, M.O. A Review of Microgrid-Based Approach to Rural Electrification in South Africa: Architecture and Policy Framework. *Energies* **2020**, *13*, 2193. [[CrossRef](#)]
121. Moslehi, K.; Kumar, R. Smart grid—a reliability perspective. In Proceedings of the 2010 Innovative Smart Grid Technologies (ISGT), Gaithersburg, MD, USA, 19–21 January 2010; IEEE: Piscataway, NJ, USA, 2010; pp. 1–8.
122. Moslehi, K.; Kumar, R. A Reliability Perspective of the Smart Grid. *IEEE Trans. Smart Grid* **2010**, *1*, 57–64. [[CrossRef](#)]
123. Aguero, J.R.; Takayasu, E.; Novosel, D.; Masiello, R. Modernizing the Grid: Challenges and Opportunities for a Sustainable Future. *IEEE Power Energy Mag.* **2017**, *15*, 74–83. [[CrossRef](#)]

124. Marnay, C.; Chatzivasileiadis, S.; Abbey, C.; Iravani, R.; Joos, G.; Lombardi, P.; Mancarella, P.; von Appen, J. Microgrid Evolution Roadmap. In Proceedings of the 2015 International Symposium on Smart Electric Distribution Systems and Technologies (EDST), Vienna, Austria, 8–11 September 2015; pp. 139–144. [\[CrossRef\]](#)
125. Garba, M.; Tankari, M.A.; Lefebvre, G. Using of distributed energy resources for microgrid resilience achieving. In Proceedings of the 2017 IEEE 6th International Conference on Renewable Energy Research and Applications (ICRERA), San Diego, CA, USA, 5–8 November 2017; pp. 659–663. [\[CrossRef\]](#)
126. Hussain, A.; Bui, V.H.; Kim, H.M. Microgrids as a resilience resource and strategies used by microgrids for enhancing resilience. *Appl. Energy* **2019**, *240*, 56–72. [\[CrossRef\]](#)
127. Alsaidan, I.; Alanazi, A.; Gao, W.; Wu, H.; Khodaei, A. State-Of-The-Art in Microgrid-Integrated Distributed Energy Storage Sizing. *Energies* **2017**, *10*, 1421. [\[CrossRef\]](#)
128. Jhunjhunwala, A.; Kaur, P. Solar Energy, dc Distribution, and Microgrids: Ensuring Quality Power in Rural India. *IEEE Electr. Mag.* **2018**, *6*, 32–39. [\[CrossRef\]](#)
129. Akikur, R.K.; Saidur, R.; Ping, H.W.; Ullah, K.R. Comparative study of stand-alone and hybrid solar energy systems suitable for off-grid rural electrification: A review. *Renew. Sustain. Energy Rev.* **2013**, *27*, 738–752. [\[CrossRef\]](#)
130. Eriksson, E.L.V.; Gray, E.M. Optimization and integration of hybrid renewable energy hydrogen fuel cell energy systems—A critical review. *Appl. Energy* **2017**, *202*, 348–364. [\[CrossRef\]](#)
131. Sharma, S.; Sood, Y.R. Microgrids: A Review of Status, Technologies, Software Tools, and Issues in Indian Power Market. *IETE Tech. Rev.* **2020**, 1–22. [\[CrossRef\]](#)
132. Bajwa, A.A.; Mokhlis, H.; Mekhilef, S.; Mubin, M. Enhancing power system resilience leveraging microgrids: A review. *J. Renew. Sustain. Energy* **2019**, *11*, 035503. [\[CrossRef\]](#)
133. Olivares, D.E.; Mehrizi-Sani, A.; Etemadi, A.H.; Cañizares, C.A.; Iravani, R.; Kazerani, M.; Hajimiragha, A.H.; Gomis-Bellmunt, O.; Saeedifard, M.; Palma-Behnke, R.; et al. Trends in microgrid control. *IEEE Trans. Smart Grid* **2014**, *5*, 1905–1919. [\[CrossRef\]](#)
134. Farhangi, H. The path of the smart grid. *IEEE Power Energy Mag.* **2010**, *8*, 18–28. [\[CrossRef\]](#)
135. Fang, X.; Misra, S.; Xue, G.; Yang, D. Smart Grid — The New and Improved Power Grid: A Survey. *IEEE Commun. Surv. Tutor.* **2012**, *14*, 944–980. [\[CrossRef\]](#)
136. Ma, R.; Chen, H.H.; Huang, Y.R.; Meng, W. Smart Grid Communication: Its Challenges and Opportunities. *IEEE Trans. Smart Grid* **2013**, *4*, 36–46. [\[CrossRef\]](#)
137. Kuzlu, M.; Pipattanasomporn, M. Assessment of communication technologies and network requirements for different smart grid applications. In Proceedings of the 2013 IEEE PES Innovative Smart Grid Technologies Conference (ISGT), Washington, DC, USA, 24–27 February 2013; pp. 1–6. [\[CrossRef\]](#)
138. Saleh, M.; Esa, Y.; Hariri, M.E.; Mohamed, A. Impact of Information and Communication Technology Limitations on Microgrid Operation. *Energies* **2019**, *12*, 2926. [\[CrossRef\]](#)
139. Yamashita, D.Y.; Vechiu, I.; Gaubert, J.P. A review of hierarchical control for building microgrids. *Renew. Sustain. Energy Rev.* **2020**, *118*, 109523. [\[CrossRef\]](#)
140. Zhou, Q.; Shahidehpour, M.; Paaso, A.; Bahramirad, S.; Alabdulwahab, A.; Abusorrah, A. Distributed Control and Communication Strategies in Networked Microgrids. *IEEE Commun. Surv. Tutor.* **2020**, *22*, 2586–2633. [\[CrossRef\]](#)
141. Feng, X.; Shekhar, A.; Yang, F.; Hebner, R.E.; Bauer, P. Comparison of Hierarchical Control and Distributed Control for Microgrid. *Electr. Power Components Syst.* **2017**, *45*, 1043–1056. [\[CrossRef\]](#)
142. Bani-Ahmed, A.; Rashidi, M.; Nasiri, A.; Hosseini, H. Reliability Analysis of a Decentralized Microgrid Control Architecture. *IEEE Trans. Smart Grid* **2019**, *10*, 3910–3918. [\[CrossRef\]](#)
143. Shuai, Z.; Sun, Y.; Shen, Z.J.; Tian, W.; Tu, C.; Li, Y.; Yin, X. Microgrid stability: Classification and a review. *Renew. Sustain. Energy Rev.* **2016**, *58*, 167–179. [\[CrossRef\]](#)
144. Basak, P.; Chowdhury, S.; Halder nee Dey, S.; Chowdhury, S.P. A literature review on integration of distributed energy resources in the perspective of control, protection and stability of microgrid. *Renew. Sustain. Energy Rev.* **2012**, *16*, 5545–5556. [\[CrossRef\]](#)
145. Kakran, S.; Chanana, S. Smart operations of smart grids integrated with distributed generation: A review. *Renew. Sustain. Energy Rev.* **2018**, *81*, 524–535. [\[CrossRef\]](#)
146. Boqtob, O.; El Moussaoui, H.; El Markhi, H.; Lamhamdi, T. Microgrid energy management system: A state-of-the-art review. *J. Electr. Syst.* **2019**, *15*, 53–67.
147. Mahmoud, M.S.; Alyazidi, N.M.; Abouheaf, M.I. Adaptive intelligent techniques for microgrid control systems: A survey. *Int. J. Electr. Power Energy Syst.* **2017**, *90*, 292–305. [\[CrossRef\]](#)
148. Zeng, Z.; Yang, H.; Zhao, R.; Cheng, C. Topologies and control strategies of multi-functional grid-connected inverters for power quality enhancement: A comprehensive review. *Renew. Sustain. Energy Rev.* **2013**, *24*, 223–270. [\[CrossRef\]](#)
149. Kim, M.S.; Haider, R.; Cho, G.J.; Kim, C.H.; Won, C.Y.; Chai, J.S. Comprehensive Review of Islanding Detection Methods for Distributed Generation Systems. *Energies* **2019**, *12*, 837. [\[CrossRef\]](#)
150. Shen, X.; Tan, D.; Shuai, Z.; Luo, A. Control Techniques for Bidirectional Interlinking Converters in Hybrid Microgrids: Leveraging the advantages of both ac and dc. *IEEE Power Electron. Mag.* **2019**, *6*, 39–47. [\[CrossRef\]](#)
151. Wang, Y.; Rousis, A.O.; Strbac, G. On microgrids and resilience: A comprehensive review on modeling and operational strategies. *Renew. Sustain. Energy Rev.* **2020**, *134*, 110313. [\[CrossRef\]](#)

152. Roslan, M.F.; Hannan, M.A.; Ker, P.J.; Uddin, M.N. Microgrid control methods toward achieving sustainable energy management. *Appl. Energy* **2019**, *240*, 583–607. [[CrossRef](#)]
153. El-Hendawi, M.; Gabbar, H.A.; El-Saad, G.; Ibrahim, E.N.A. Control and EMS of a Grid-Connected Microgrid with Economical Analysis. *Energies* **2018**, *11*, 129. [[CrossRef](#)]
154. Wen, L.; Zhou, K.; Yang, S.; Lu, X. Optimal load dispatch of community microgrid with deep learning based solar power and load forecasting. *Energy* **2019**, *171*, 1053–1065. [[CrossRef](#)]
155. Yoder, E.; Williams, N.J. Load Profile Prediction Using Customer Characteristics. In Proceedings of the 2020 IEEE PES/IAS PowerAfrica, Nairobi, Kenya, 25–28 August 2020; pp. 1–5. [[CrossRef](#)]
156. Ma, J.; Ma, X. State-of-the-art forecasting algorithms for microgrids. In Proceedings of the 2017 23rd International Conference on Automation and Computing (ICAC), Huddersfield, UK, 7–8 September 2017; pp. 1–6. [[CrossRef](#)]
157. Reber, T.; Booth, S. Tariff Structures to Encourage Micro-Grid Deployment in Sub-Saharan Africa: Review and Recent Trends. *Curr. Sustain. Energy Rep.* **2018**, *5*, 199–204. [[CrossRef](#)]
158. Barrios-O'Neill, D.; Schuitema, G. Online engagement for sustainable energy projects: A systematic review and framework for integration. *Renew. Sustain. Energy Rev.* **2016**, *54*, 1611–1621. [[CrossRef](#)]
159. Wang, R.; Hsu, S.C.; Zheng, S.; Chen, J.H.; Li, X.I. Renewable energy microgrids: Economic evaluation and decision making for government policies to contribute to affordable and clean energy. *Appl. Energy* **2020**, *274*, 115287. [[CrossRef](#)]
160. Zhao, S.; Blaabjerg, F.; Wang, H. An Overview of Artificial Intelligence Applications for Power Electronics. *IEEE Trans. Power Electron.* **2021**, *36*, 4633–4658. [[CrossRef](#)]
161. Ye, K.; Cao, Y.; Xiao, F.; Bai, J.; Ma, F.; Hu, Y. Research on unified information model for big data analysis of power grid equipment monitoring. In Proceedings of the 2017 3rd IEEE International Conference on Computer and Communications (ICCC), Chengdu, China, 13–16 December 2017; pp. 2334–2337. [[CrossRef](#)]
162. Neto, J.T.C.; de Andrade, P.H.M.; Vilanueva, J.M.; Santos, F.A.O. Big Data Analytics of Smart Grids using Artificial Intelligence for the Outliers Correction at Demand Measurements. In Proceedings of the 2018 3rd International Symposium on Instrumentation Systems, Circuits and Transducers (INSCIT), Bento Goncalves, Brazil, 27–31 August 2018; pp. 1–6. [[CrossRef](#)]
163. Marino, C.A.; Marufuzzaman, M. A microgrid energy management system based on chance-constrained stochastic optimization and big data analytics. *Comput. Ind. Eng.* **2020**, *143*, 106392. [[CrossRef](#)]
164. Sun, Y.X.; Yan, Q.Y. The application mode of Energy Big Data and its enlightenment for power grid enterprises. In *Advanced Materials Research*; Trans Tech Publications Ltd.: Bâch, Switzerland, 2014; Volume 1008, pp. 1452–1455.
165. Liu, D.; Li, G.; Fan, R.; Guo, G. Research About Big Data Platform of Electrical Power System. In *Proceedings of the Industrial IoT Technologies and Applications*; Wan, J., Humar, I., Zhang, D., Eds.; Lecture Notes of the Institute for Computer Sciences, Social Informatics and Telecommunications Engineering; Springer International Publishing: Cham, Switzerland, 2016; pp. 36–43. [[CrossRef](#)]
166. Paramkusem, K.M.; Aygun, R.S. Classifying Categories of SCADA Attacks in a Big Data Framework. *Ann. Data Sci.* **2018**, *5*, 359–386. [[CrossRef](#)]
167. Chen, P.C.; Dokic, T.; Kezunovic, M. *The Use of Big Data for Outage Management in Distribution Systems*; International Conference on Electricity Distribution (CIRED) Workshop: Rome, Italy, 2014.
168. Saputro, N.; Akkaya, K.; Uludag, S. A survey of routing protocols for smart grid communications. *Comput. Netw.* **2012**, *56*, 2742–2771. [[CrossRef](#)]
169. Kabalci, Y. A survey on smart metering and smart grid communication. *Renew. Sustain. Energy Rev.* **2016**, *57*, 302–318. [[CrossRef](#)]
170. Jawad, H.M.; Nordin, R.; Gharghan, S.K.; Jawad, A.M.; Ismail, M. Energy-Efficient Wireless Sensor Networks for Precision Agriculture: A Review. *Sensors* **2017**, *17*, 1781. [[CrossRef](#)] [[PubMed](#)]
171. Fraga-Lamas, P.; Fernández-Caramés, T.M.; Castedo, L. Towards the Internet of Smart Trains: A Review on Industrial IoT-Connected Railways. *Sensors* **2017**, *17*, 1457. [[CrossRef](#)]
172. Ramathulasi, T.; Rajasekhara Babu, M. Comprehensive Survey of IoT Communication Technologies. In *Proceedings of the Emerging Research in Data Engineering Systems and Computer Communications*; Venkata Krishna, P., Obaidat, M.S., Eds.; Advances in Intelligent Systems and Computing; Springer: Singapore, 2020; pp. 303–311. [[CrossRef](#)]
173. Walker, G.; Devine-Wright, P. Community renewable energy: What should it mean? *Energy Policy* **2008**, *36*, 497–500. [[CrossRef](#)]
174. Andreini, D.; Bettinelli, C. *Business Model Definition and Boundaries*; International Series in Advanced Management Studies; Springer International Publishing: Cham, Switzerland, 2017; pp. 25–53. [[CrossRef](#)]
175. Piterou, A.; Coles, A.M. A review of business models for decentralised renewable energy projects. *Bus. Strategy Environ.* **2021**, *30*, 1468–1480. [[CrossRef](#)]
176. Asmus, P.; Lawrence, M. Emerging microgrid business models. *Navig. Res. Brief* **2016**, *23*, 72–82.
177. Dibaba, H.; Vanadzina, E.; Mendes, G.; Pinomaa, A.; Honkapuro, S. Business Model Design for Rural Off-the-Grid Electrification and Digitalization Concept. In Proceedings of the 2020 17th International Conference on the European Energy Market (EEM), Stockholm, Sweden, 16–18 September 2020; pp. 1–5. [[CrossRef](#)]
178. Söderholm, J. Powered by Actors and Business Models: Analysing the Potential for Energy Community Development in New Regions Using the Case of Kökar Island. Master's Thesis, Lunds University, Lund, Sweden, 2020.
179. Weston, P.; Kalhor, W.; Lockhart, E.; Reber, T.J.; Booth, S.S. *Financial and Operational Bundling Strategies for Sustainable Micro-Grid Business Models*; Technical Report; National Renewable Energy Lab.: Golden, CO, USA, 2018. [[CrossRef](#)]

180. Robert, F.C.; Sisodia, G.S.; Gopalan, S. The critical role of anchor customers in rural microgrids: Impact of load factor on energy cost. In Proceedings of the 2017 International Conference on Computation of Power, Energy Information and Commuincation (ICCPEIC), Melmaruvathur, India, 22–23 March 2017; pp. 398–403. [CrossRef]
181. Booth, S.; Li, X.; Baring-Gould, I.; Kollanyi, D.; Bharadwaj, A.; Weston, P. *Productive Use of Energy in African Micro-Grids: Technical and Business Considerations*; Technical Report; OSTI.GOV: Golden, CO, USA, 2018. [CrossRef]
182. Moreno, A.; Bareisaite, A. *Scaling Up Access to Electricity: Pay-as-You-Go Plans in Off-Grid Energy Services. Live Wire*; World Bank: Washington, DC, USA, 2015.
183. Trabish, H.K. Public Purpose Microgrids: Mixed-Ownership Models Spur Utility Investment in Growing Sector. 2016. Available online: <http://www.utilitydive.com/news/public-purpose-microgrids-mixedownership-models-spur-utility-investment-i/425296> (accessed on 6 April 2022).
184. Hawkey, D.; Webb, J.; Winksel, M. Organisation and governance of urban energy systems: District heating and cooling in the UK. *J. Clean. Prod.* **2013**, *50*, 22–31. [CrossRef]
185. Bird, S.; Hotaling, C.; Enayati, A.; Ortmeyer, T. *Resilient Community Microgrids: Governance and Operational Challenges*; Woodhead Publishing: Cambridge, UK, 2019; Chapter 4, pp. 65–95. [CrossRef]
186. Says, D.A.S. New Business Models for Microgrids: Energy-as-a-Services (EaaS) Leads in Popularity. In Proceedings of the 16th International Conference on the European Energy Market, Łódź, Poland, 1–7 June 2018.
187. Ingalalli, A.; Kamalasadán, S. Participation of Networked Microgrids in Energy-as-a-Service Model for Enhancing Grid Resiliency. In Proceedings of the 2021 IEEE Power Energy Society Innovative Smart Grid Technologies Conference (ISGT), Washington, DC, USA, 16–18 February 2021; pp. 1–5. [CrossRef]
188. Paukstadt, U.; Becker, J. From Energy as a Commodity to Energy as a Service—A Morphological Analysis of Smart Energy Services. *Schmalenbach J. Bus. Res.* **2021**, *73*, 207–242. [CrossRef]
189. Koirala, B.P.; Koliou, E.; Friege, J.; Hakvoort, R.A.; Herder, P.M. Energetic communities for community energy: A review of key issues and trends shaping integrated community energy systems. *Renew. Sustain. Energy Rev.* **2016**, *56*, 722–744. [CrossRef]
190. Yavuz, L.; Önen, A.; Muyeen, S.M.; Kamwa, I. Transformation of microgrid to virtual power plant – a comprehensive review. *Int. J. Grid Util. Comput.* **2019**, *13*, 1994–2005. [CrossRef]
191. Rathnayaka, A.D.; Potdar, V.M.; Dillon, T.S.; Kuruppu, S. Formation of virtual community groups to manage prosumers in smart grids. *Int. J. Grid Util. Comput.* **2014**, *6*, 47–56. [CrossRef]
192. Cui, S.; Wang, Y.W.; Xiao, J.W.; Liu, N. A Two-Stage Robust Energy Sharing Management for Prosumer Microgrid. *IEEE Trans. Ind. Inform.* **2019**, *15*, 2741–2752. [CrossRef]
193. Bowes, J.; Booth, C.; Strachan, S. System interconnection as a path to bottom up electrification. In Proceedings of the 2017 52nd International Universities Power Engineering Conference (UPEC), Heraklion, Greece, 28–31 August 2017; pp. 1–5. [CrossRef]
194. Zhang, C.; Wu, J.; Zhou, Y.; Cheng, M.; Long, C. Peer-to-Peer energy trading in a Microgrid. *Appl. Energy* **2018**, *220*, 1–12. [CrossRef]
195. Sousa, T.; Soares, T.; Pinson, P.; Moret, F.; Baroche, T.; Sorin, E. Peer-to-peer and community-based markets: A comprehensive review. *Renew. Sustain. Energy Rev.* **2019**, *104*, 367–378. [CrossRef]
196. Diaz-Valdivia, A.; Poblet, M. *Connecting the Grids: A Review of Blockchain Governance in Distributed Energy Transitions*; SSRN Scholarly Paper ID 3777293; Energy Research & Social Science: Rochester, NY, USA, 2020. [CrossRef]
197. Kulkarni, V.; Kulkarni, K. A Blockchain-based Smart Grid Model for Rural Electrification in India. In Proceedings of the 2020 8th International Conference on Smart Grid (icSmartGrid), Paris, France, 17–19 June 2020; pp. 133–139. [CrossRef]
198. Ahl, A.; Yarime, M.; Tanaka, K.; Sagawa, D. Review of blockchain-based distributed energy: Implications for institutional development. *Renew. Sustain. Energy Rev.* **2019**, *107*, 200–211. [CrossRef]
199. Chen, T.; Pourbabak, H.; Su, W. *Electricity Market Reform*; Woodhead Publishing: Cambridge, UK, 2019; Chapter 5, pp. 97–121. [CrossRef]
200. Diego Jiménez, J.; Vives, S.M.; Jiménez, E.G.; Mendoza, A.P. Development of a methodology for planning and design of microgrids for rural electrification. In Proceedings of the 2017 CHILEAN Conference on Electrical, Electronics Engineering, Information and Communication Technologies (CHILECON), Pucon, Chile, 18–20 October 2017; pp. 1–6. [CrossRef]
201. Loka, P.; Moola, S.; Polsani, K.; Reddy, S.; Fulton, S.; Skumanich, A. A case study for micro-grid PV: Lessons learned from a rural electrification project in India. *Prog. Photovolt. Res. Appl.* **2014**, *22*, 733–743. [CrossRef]
202. Ahmad, F.; Alam, M.S. Economic and ecological aspects for microgrids deployment in India. *Sustain. Cities Soc.* **2018**, *37*, 407–419. [CrossRef]
203. Juanpera, M.; Blechinger, P.; Ferrer-Martí, L.; Hoffmann, M.M.; Pastor, R. Multicriteria-based methodology for the design of rural electrification systems. A case study in Nigeria. *Renew. Sustain. Energy Rev.* **2020**, *133*, 110243. [CrossRef]
204. Bracco, S.; Delfino, F.; Pampararo, F.; Robba, M.; Rossi, M. A pilot facility for analysis and simulation of smart microgrids feeding smart buildings. *Renew. Sustain. Energy Rev.* **2016**, *58*, 1247–1255. [CrossRef]
205. Rodrigues, D.L.; Ye, X.; Xia, X.; Zhu, B. Battery energy storage sizing optimisation for different ownership structures in a peer-to-peer energy sharing community. *Appl. Energy* **2020**, *262*, 114498. [CrossRef]
206. Yadav, P.; Davies, P.J.; Palit, D. Distributed solar photovoltaics landscape in Uttar Pradesh, India: Lessons for transition to decentralised rural electrification. *Energy Strategy Rev.* **2019**, *26*, 100392. [CrossRef]

207. Gradl, C.; Knobloch, C. *Energize the BoP!: Energy Business Model Generator for Low-Income Markets: A Practitioners' Guide*; Endeavor: Berlin, Germany, 2011.
208. Daneshvar, M.; Pesaran, M.; Mohammadi-ivatloo, B. Transactive energy integration in future smart rural network electrification. *J. Clean. Prod.* **2018**, *190*, 645–654. [[CrossRef](#)]
209. Paudel, A.; Beng, G.H. A Hierarchical Peer-to-Peer Energy Trading in Community Microgrid Distribution Systems. In Proceedings of the 2018 IEEE Power Energy Society General Meeting (PESGM), Portland, OR, USA, 5–10 August 2018; pp. 1–5. [[CrossRef](#)]
210. Huang, Z.; Yu, H.; Peng, Z.; Zhao, M. Methods and tools for community energy planning: A review. *Renew. Sustain. Energy Rev.* **2015**, *42*, 1335–1348. [[CrossRef](#)]
211. Oueid, R.K. Microgrid finance, revenue, and regulation considerations. *Electr. J.* **2019**, *32*, 2–9. [[CrossRef](#)]
212. Sharma, A. 'We Do Not Want Fake Energy': The Social Shaping of a Solar Micro-grid in Rural India. *Sci. Technol. Soc.* **2020**, *25*, 308–324. [[CrossRef](#)]
213. Azarova, V.; Cohen, J.; Friedl, C.; Reichl, J. Designing local renewable energy communities to increase social acceptance: Evidence from a choice experiment in Austria, Germany, Italy, and Switzerland. *Energy Policy* **2019**, *132*, 1176–1183. [[CrossRef](#)]
214. Busse, M.; Siebert, R. Acceptance studies in the field of land use—A critical and systematic review to advance the conceptualization of acceptance and acceptability. *Land Use Policy* **2018**, *76*, 235–245. [[CrossRef](#)]
215. Gaede, J.; Rowlands, I.H. Visualizing social acceptance research: A bibliometric review of the social acceptance literature for energy technology and fuels. *Energy Res. Soc. Sci.* **2018**, *40*, 142–158. [[CrossRef](#)]
216. Wolsink, M. The research agenda on social acceptance of distributed generation in smart grids: Renewable as common pool resources. *Renew. Sustain. Energy Rev.* **2012**, *16*, 822–835. [[CrossRef](#)]
217. Wolsink, M. Social acceptance, lost objects, and obsession with the 'public'—The pressing need for enhanced conceptual and methodological rigor. *Energy Res. Soc. Sci.* **2019**, *48*, 269–276. [[CrossRef](#)]
218. Blau, P.M. A macrosociological theory of social structure. *Am. J. Sociol.* **1977**, *83*, 26–54. [[CrossRef](#)]
219. Creamer, E.; Eadson, W.; Veelen, B.v.; Pinker, A.; Tingey, M.; Brauholtz-Speight, T.; Markantoni, M.; Foden, M.; Lacey-Barnacle, M. Community energy: Entanglements of community, state, and private sector. *Geogr. Compass* **2018**, *12*, e12378. [[CrossRef](#)]
220. Wüstenhagen, R.; Wolsink, M.; Bürer, M.J. Social acceptance of renewable energy innovation: An introduction to the concept. *Energy Policy* **2007**, *35*, 2683–2691. [[CrossRef](#)]
221. Muza, O.; Debnath, R. Disruptive innovation for inclusive renewable policy in sub-Saharan Africa: A social shaping of technology analysis of appliance uptake in Rwanda. *Renew. Energy* **2021**, *168*, 896–912. [[CrossRef](#)]
222. Von Wirth, T.; Gislason, L.; Seidl, R. Distributed energy systems on a neighborhood scale: Reviewing drivers of and barriers to social acceptance. *Renew. Sustain. Energy Rev.* **2018**, *82*, 2618–2628. [[CrossRef](#)]
223. Moody, J.; White, D.R. Structural Cohesion and Embeddedness: A Hierarchical Concept of Social Groups. *Am. Sociol. Rev.* **2003**, *68*, 103–127. [[CrossRef](#)]
224. Upham, P.; Oltra, C.; Boso, A. Towards a cross-paradigmatic framework of the social acceptance of energy systems. *Energy Res. Soc. Sci.* **2015**, *8*, 100–112. [[CrossRef](#)]
225. Wolsink, M. Social acceptance revisited: Gaps, questionable trends, and an auspicious perspective. *Energy Res. Soc. Sci.* **2018**, *46*, 287–295. [[CrossRef](#)]
226. Stern, P.C. Individual and household interactions with energy systems: Toward integrated understanding. *Energy Res. Soc. Sci.* **2014**, *1*, 41–48. [[CrossRef](#)]
227. Cohen, J.J.; Reichl, J.; Schmidthaler, M. Re-focussing research efforts on the public acceptance of energy infrastructure: A critical review. *Energy* **2014**, *76*, 4–9. [[CrossRef](#)]
228. Friedl, C.; Reichl, J. Realizing energy infrastructure projects—A qualitative empirical analysis of local practices to address social acceptance. *Energy Policy* **2016**, *89*, 184–193. [[CrossRef](#)]
229. Ponce, P.; Polasko, K.; Molina, A. End user perceptions toward smart grid technology: Acceptance, adoption, risks, and trust. *Renew. Sustain. Energy Rev.* **2016**, *60*, 587–598. [[CrossRef](#)]
230. Karytsas, S.; Vardopoulos, I.; Theodoropoulou, E. Factors Affecting Sustainable Market Acceptance of Residential Microgeneration Technologies. A Two Time Period Comparative Analysis. *Energies* **2019**, *12*, 3298. [[CrossRef](#)]
231. Mengelkamp, E.; Staudt, P.; Gärtner, J.; Weinhardt, C.; Huber, J. Quantifying Factors for Participation in Local Electricity Markets. In Proceedings of the 2018 15th International Conference on the European Energy Market (EEM), Lodz, Poland, 27–29 June 2018; pp. 1–5. [[CrossRef](#)]
232. Li, N.; Hakvoort, R.; Lukszo, Z. Cost Allocation in Integrated Community Energy Systems—Social Acceptance. *Sustainability* **2021**, *13*, 9951. [[CrossRef](#)]
233. Peters, D.; Aksen, J.; Mallett, A. The role of environmental framing in socio-political acceptance of smart grid: The case of British Columbia, Canada. *Renew. Sustain. Energy Rev.* **2018**, *82*, 1939–1951. [[CrossRef](#)]
234. Dermont, C.; Ingold, K.; Kammermann, L.; Stadelmann-Steffen, I. Bringing the policy making perspective in: A political science approach to social acceptance. *Energy Policy* **2017**, *108*, 359–368. [[CrossRef](#)]
235. Rygg, B.J.; Ryghaug, M.; Yttri, G. Is local always best? Social acceptance of small hydropower projects in Norway. *Int. J. Sustain. Energy Plan. Manag.* **2021**, *31*, 161–174. [[CrossRef](#)]
236. Assefa, G.; Frostell, B. Social sustainability and social acceptance in technology assessment: A case study of energy technologies. *Technol. Soc.* **2007**, *29*, 63–78. [[CrossRef](#)]

237. Alvial-Palavicino, C.; Garrido-Echeverría, N.; Jiménez-Estévez, G.; Reyes, L.; Palma-Behnke, R. A methodology for community engagement in the introduction of renewable based smart microgrid. *Energy Sustain. Dev.* **2011**, *15*, 314–323. [[CrossRef](#)]
238. Hirmer, S.; Guthrie, P. The benefits of energy appliances in the off-grid energy sector based on seven off-grid initiatives in rural Uganda. *Renew. Sustain. Energy Rev.* **2017**, *79*, 924–934. [[CrossRef](#)]
239. Stigka, E.K.; Paravantis, J.A.; Mihalakakou, G.K. Social acceptance of renewable energy sources: A review of contingent valuation applications. *Renew. Sustain. Energy Rev.* **2014**, *32*, 100–106. [[CrossRef](#)]
240. Ellabban, O.; Abu-Rub, H. Smart grid customers' acceptance and engagement: An overview. *Renew. Sustain. Energy Rev.* **2016**, *65*, 1285–1298. [[CrossRef](#)]
241. Anderson, A.; Suryanarayanan, S. An Enterprise Systems Engineering Approach to Electrification: Looking at the Bigger Picture Through Life-Cycle Analysis of Community Microgrids: A Case Study in Papua New Guinea. *IEEE Electr. Mag.* **2018**, *6*, 18–31. [[CrossRef](#)]
242. Boon, F.P.; Dieperink, C. Local civil society based renewable energy organisations in the Netherlands: Exploring the factors that stimulate their emergence and development. *Energy Policy* **2014**, *69*, 297–307. [[CrossRef](#)]
243. Geelen, D.; Reinders, A.; Keyson, D. Empowering the end-user in smart grids: Recommendations for the design of products and services. *Energy Policy* **2013**, *61*, 151–161. [[CrossRef](#)]
244. Sauter, R.; Watson, J. Strategies for the deployment of micro-generation: Implications for social acceptance. *Energy Policy* **2007**, *35*, 2770–2779. [[CrossRef](#)]
245. Jager, W. Stimulating the diffusion of photovoltaic systems: A behavioural perspective. *Energy Policy* **2006**, *34*, 1935–1943. [[CrossRef](#)]
246. Adil, A.M.; Ko, Y. Socio-technical evolution of Decentralized Energy Systems: A critical review and implications for urban planning and policy. *Renew. Sustain. Energy Rev.* **2016**, *57*, 1025–1037. [[CrossRef](#)]
247. Müller, M.O.; Stämpfli, A.; Dold, U.; Hammer, T. Energy autarky: A conceptual framework for sustainable regional development. *Energy Policy* **2011**, *39*, 5800–5810. [[CrossRef](#)]
248. Chmutina, K.; Wiersma, B.; Goodier, C.I.; Devine-Wright, P. Concern or compliance? Drivers of urban decentralised energy initiatives. *Sustain. Cities Soc.* **2014**, *10*, 122–129. [[CrossRef](#)]
249. Raven, R.P.J.M.; Mourik, R.M.; Feenstra, C.F.J.; Heiskanen, E. Modulating societal acceptance in new energy projects: Towards a toolkit methodology for project managers. *Energy* **2009**, *34*, 564–574. [[CrossRef](#)]
250. Niez, A. *Comparative Study on Rural Electrification Policies in Emerging Economies: Keys to Successful Policies*; IEA Energy Papers, No. 2010/03; OECD Publishing: Paris, France, 2010.
251. Lopez-Arboleda, E.; Sarmiento, A.T.; Cardenas, L.M. Systematic Review of Integrated Sustainable Transportation Models for Electric Passenger Vehicle Diffusion. *Sustainability* **2019**, *11*, 2513. [[CrossRef](#)]
252. Hansen, P.; Liu, X.; Morrison, G.M. Agent-based modelling and socio-technical energy transitions: A systematic literature review. *Energy Res. Soc. Sci.* **2019**, *49*, 41–52. [[CrossRef](#)]
253. Salehi, V.; Veitch, B.; Smith, D. Modeling complex socio-technical systems using the FRAM: A literature review. *Hum. Factors Ergon. Manuf. Serv. Ind.* **2021**, *31*, 118–142. [[CrossRef](#)]
254. Villanueva-Rosario, J.A.; Santos-García, F.; Aybar-Mejía, M.E.; Mendoza-Araya, P.; Molina-García, A. Coordinated ancillary services, market participation and communication of multi-microgrids: A review. *Appl. Energy* **2022**, *308*, 118332. [[CrossRef](#)]
255. Xu, Z.; Yang, P.; Zheng, C.; Zhang, Y.; Peng, J.; Zeng, Z. Analysis on the organization and Development of multi-microgrids. *Renew. Sustain. Energy Rev.* **2018**, *81*, 2204–2216. [[CrossRef](#)]
256. Yoo, H.J.; Nguyen, T.T.; Kim, H.M. Multi-Frequency Control in a Stand-Alone Multi-Microgrid System Using a Back-To-Back Converter. *Energies* **2017**, *10*, 822. [[CrossRef](#)]
257. Chiu, W.Y.; Sun, H.; Vincent Poor, H. A Multiobjective Approach to Multimicrogrid System Design. *IEEE Trans. Smart Grid* **2015**, *6*, 2263–2272. [[CrossRef](#)]