



**HAL**  
open science

**PARAMount - imProved Accessibility: Reliability and safety of Alpine transport infrastructure related to mountainous hazards in a changing climate Decision Support Guidelines (WP7 report) -Version 1.0 -november 2012**

Jean-Marc Tacnet

► **To cite this version:**

Jean-Marc Tacnet. PARAMount - imProved Accessibility: Reliability and safety of Alpine transport infrastructure related to mountainous hazards in a changing climate Decision Support Guidelines (WP7 report) -Version 1.0 -november 2012. [Research Report] IRSTEA - Institut national de recherche en sciences et technologies pour l'environnement et l'agriculture, 2 Rue de la Papeterie, 38402 Saint-Martin-d'Hères. 2012. hal-03639896

**HAL Id: hal-03639896**

**<https://hal.science/hal-03639896>**

Submitted on 13 Apr 2022

**HAL** is a multi-disciplinary open access archive for the deposit and dissemination of scientific research documents, whether they are published or not. The documents may come from teaching and research institutions in France or abroad, or from public or private research centers.

L'archive ouverte pluridisciplinaire **HAL**, est destinée au dépôt et à la diffusion de documents scientifiques de niveau recherche, publiés ou non, émanant des établissements d'enseignement et de recherche français ou étrangers, des laboratoires publics ou privés.



Distributed under a Creative Commons Attribution - NonCommercial - NoDerivatives 4.0 International License



**imProved Accessibility: Reliability and safety  
of Alpine transport infrastructure  
related to mountainous hazards in a changing climate**

# **Decision Support Guidelines**

## **Methods, procedures and tools developed in PARAMount (WP 7)**

version: 1.0

November 2012

**Coordination and synthesis: Jean-Marc Tacnet\***

\* *Irstea, UR ETGR (Snow Avalanches Engineering and Torrent Control Research Unit), 2 rue de la papeterie BP 76, F-38402 SAINT-MARTIN D'HERES – France*

<http://www.paramount-project.eu/>



*PARAMount is supported with funding from the European Regional Development Fund (ERDF)*



## Table of contents

0	Summary .....	14
1	Context of roads and railways exposed to natural hazards and PARAMOUNT project objectives .....	16
2	Natural risk management process: needs and requirements for Decision Support Systems	22
2.1	Decision context in the risk management process : temporal and geographical scales .....	22
2.2	Decisions related to railway infrastructure management .....	26
2.3	Decision-making in the context of natural hazards .....	28
2.4	Multi-criteria decision analysis backgrounds.....	30
2.5	From information management to decision-making.....	37
2.6	Conclusion: specific developments and applications .....	38
3	Development of methodologies for decision context description .....	40
3.1	Strategic level: a simple communication and strategic decision support tool for natural hazard management (CDT) .....	40
3.2	Regional Risk Dialogue (RRD) in Austria (Stanzer Valley): framework, results and lessons learned .....	48
4	Development of methodologies for indirect vulnerability evaluation: network analysis for road accessibility and criticality assessment .....	57
4.1	Importance and criticality of roads exposed to natural hazards in mountains: an approach based on network structural properties analysis .....	57
4.2	Road vulnerability assessment based on network analysis.....	63
5	Development of advanced methodologies for decision support .....	80
5.1	Advanced Multi-criteria decision-making methods (MCDM) considering information imperfection .....	80
5.2	An innovative information fusion process to consider information quality and heterogeneous information sources .....	84
5.3	How far can we be confident in numerical modelling results? An innovative information imperfection propagation hybrid process .....	86
6	Decision spatial downscaling and upscaling: towards an integrated approach from regional to local scale .....	93
6.1	Debris flow susceptibility: a regional approach.....	94
6.2	Avalanches and rockfall regional analysis with a special focus on protective role of forest	100
6.3	Prototype of a regional hazard management system on the Austrian railway network....	143
6.4	An operational avalanche risk evaluation system on an Alpine railway section .....	156
7	Assessment of protection works' effectiveness .....	162

7.1 Effectiveness of protection works: an approach based on dependability (safety and reliability) analysis ..... 162

7.2 Comparison of the state of existing protection structures and the current risk situation as a way of setting risk mediation priorities ..... 172

7.3 Effectiveness of protection works based on the mechanical evaluation of rockfall barriers.... ..... 176

8 Decision support systems for natural risk management: synthesis and perspectives for further developments..... 196

9 References ..... 200

10 Appendix ..... 204

10.1 Discussion guidelines for DSS evaluation: a framework for decision context identification..... ..... 204

10.2 Numerical modelling in the decision process: examples of qualitative evaluation of model results ..... 213

## Table of figures

Figure 1 : Example of road and railway exposure to natural hazards in mountains.....	17
Figure 2: Endangered railway infrastructure. Bohinjska soteska, Slovenia (photo: Jošt Sodnik) .....	18
Figure 3: Even such a small rockfall event can cause serious damage – Višnja Gora, Slovenia (photo: Jože Papež) .....	19
Figure 4 : Structure of the PARAMount WP7 report .....	21
Figure 5 : Concept of risk and criticality in industrial and natural phenomena contexts - from [Tacnet, 2009] [Mortureux, 2001].....	22
Figure 6 : Expert assessments are required at every stage of the risk management process.....	23
Figure 7: Expert assessments are required to implement the risk reduction measures ([Tacnet et al., 2010e]).....	24
Figure 8 : Experts can have different roles during the multiple and complex decision framework of the natural risk management process (Tacnet, 2009) .....	24
Figure 9 : Methodology to move from regional to local decisions: first identify ‘hot spots’ and then proceed to detailed studies on a local scale (J.-M. Tacnet) .....	25
Figure 10 : Decisions related to railway protection and management strategies are expected (J.-M. Tacnet).....	26
Figure 11 : Diversion is sometimes used in case of tracks exposed to natural phenomena (J.-M. Tacnet, Irstea).....	26
Figure 12 : example of decision identification for road management in a context of prevention (J.-M. Tacnet, Irstea).....	27
Figure 13 : Risk assessment of roads exposed to natural hazards requires the analysis both of threats (hazard) and of consequences (vulnerability) .....	28
Figure 14 : Several complementary methods are available and useful to help decision-making in the context of natural risk assessment.....	29
Figure 15 : an overview of applied methodology (Irstea) in the case of a torrent catchment basin....	30
Figure 16 : The global multi-criteria decision analysis framework: essentials steps to design a new decision model .....	31
Figure 17 : The different decision problems addressed by multi-criteria decision-making methods [Schärlig, 1985].....	32
Figure 18 : Multi-criteria decision analysis principles: classical approach based on total aggregation principle.....	33
Figure 19 : From decision context to multi-criteria analysis and models: elicitation of preferences between criteria .....	34
Figure 20 : Decision problem analysis : principles of a hierarchic breakdown into criteria in the AHP [Saaty, 1980] context .....	34
Figure 21: Simplified decision-making problem related to a avalanche sensitivity index [Tacnet et al., 2010b] .....	35
Figure 22: Example of a hierarchical breakdown into sub-criteria of road vulnerability (J.-M. Tacnet)	36

Figure 23: example of the transformation of a preference matrix into a vector of weights (J.-M. Tacnet).....	36
Figure 24: Different kinds of information imperfection [Tacnet, 2009] .....	37
Figure 25: Expert assessment process and information imperfection propagation [Tacnet, 2009].....	38
Figure 26: Number of responses by rated processes – PARAMOUNT CDT online expert survey 2012. .	42
Figure 27: Selection of the highest weightings of influencing parameters for landslides, according to the online expert survey. The results can be used only conditionally, because of the high standard deviation resulting from the low number of responses (expert online survey). .....	43
Figure 28: Weighted parameters are merged with information on the status of hazards and the further development of relevant parameters to indicate potential ‘hot spots’ .....	43
Figure 29: Overview of Stanzer Valley test bed (Tyrol, Austria) .....	50
Figure 30: Central section of the Austrian Stanzer Valley test bed (left) (source: BFW); close-up view of the critical road and rail infrastructure in the test bed: Arlberg-railway (far left in the picture) expressway (left in the picture) and A-road (right in the picture) near the Flirsch Ost junction (right) (source: BFW). .....	50
Figure 31: Stakeholders in the Austrian Stanzer Valley test bed responsible for road (top) and rail (bottom) transport infrastructure listed by their level of governance, function and name.....	52
Figure 32 : Existing cross-relations between the vital networks [Tacnet et al., 2012c] .....	57
Figure 33 : Attractiveness (and importance) of nodes according to thematic domains.....	58
Figure 34 : Thematic indicators corresponding to economic, social, environmental, safety contexts are derived into constraints and attractiveness indexes. ....	59
Figure 35 : Principles of transformation of thematic features into structural properties indicators (betweenness centrality and average distance) on the main roads network in France using <i>GeographLab</i> .}.....	60
Figure 36 : Example of basic data used to define attractiveness indexes - main economic activities in Maurienne Valley, Savoie, France. ....	61
Figure 37 : Historical torrential events in relation with roads in Maurienne Valley, Savoie, France....	62
Figure 38 : Example of structural analysis with thematic data to assess importance of roads. ....	63
Figure 39 : Road network graph of the Autonomous Province of Bolzano.....	69
Figure 40 : Simulated flows .....	70
Figure 41 : Riskcut links (in red) versus non-cut links (green).....	72
Figure 42 : RiskVulnerability of the road network of Provincia Autonoma di Bolzano.....	72
Figure 43 : RiskCut links vulnerability.....	73
Figure 44 : RiskNon-cut links vulnerability .....	73
Figure 45 : RiskVulnerability of those links whose ADT is lower than the 50 <sup>th</sup> percentile.....	74
Figure 46 : RiskVulnerability of those links whose ADT is higher than the 50 <sup>th</sup> percentile.....	74
Figure 47 : RiskExposure of the road network of Provincia Autonoma di Bolzano .....	75
Figure 48 : Risk of the road network of Provincia Autonoma di Bolzano .....	75
Figure 49 : Network hazard maps (Serv. Geol. Bolzano).....	76

Figure 50 : Risk maps based on network analysis (Serv. Geol. Bolzano).....	76
Figure 51 : Exposure and vulnerability maps (Serv. Geol. Bolzano) .....	76
Figure 52: Schematic working process of VISO database .....	77
Figure 53: Hazard level referred to a road segment .....	79
Figure 54 : Different levels, steps and actors of risk management decisions on a local scale.....	80
Figure 55 : New methods for MCDM under uncertainty and information imperfection [Tacnet and Dezert, 2012] .....	81
Figure 56: Simplified decision-making problem.....	82
Figure 57: The source provides an imprecise evaluation that is mapped into the frame of discernment for making a decision. The steps are numbered from 1 to 4. ....	82
Figure 58 : Criteria are considered to be sources in the second step of fusion – adapted from (Tacnet et al.,2010a).....	83
Figure 59 : A sensitivity level can be chosen according a decision profile: adapted from (Tacnet et al.,2010a).....	84
Figure 60: Risk level results from fusion of imperfect information provided by heterogeneous and more or less reliable sources.....	85
Figure 61: Principles of the Spatial ER-MCDA methodology.....	86
Figure 62: Input and output data of lave2D: a numerical model to simulate muddy debris flows (Dupouy et al., 2012).....	87
Figure 63: Principle of uncertainty analysis applied to debris flows numerical modelling: functional failures are analysed through specific criteria of interest (Dupouy et al., 2012).....	87
Figure 64: Expert assessment is coded by a possibility distribution (Tacnet et al., 2010a) .....	88
Figure 65: Input data are represented either by probability or possibility distribution depending on the available knowledge - adapted from (Tacnet et al.,2010d).....	89
Figure 66: Input data are represented either by probability or possibility distribution depending on the available knowledge Figure 67: Principles of uncertainty analysis - different theories can be used to represent information imperfection.....	90
Figure 68: Sampling and propagation related to the Hybrid method.....	90
Figure 69: Case study: Torrent Saint-Antoine, Modane, France. ....	91
Figure 70: Criteria of interest related to debris flows height [Dupouy, 2010], [Dupouy et al., 2012]..	91
Figure 71: Application of the hybrid approach to the test bed case study: debris flows modelling based on imprecise knowledge of input parameters [Dupouy et al., 2012].....	92
Figure 72 : Integrated approach to decision on a local scale proposed in the PARAMOUNT project framework (Irstea) .....	93
Figure 73: Integrated approach to decision on a regional scale proposed in the PARAMOUNT project framework (Irstea) .....	94
Figure 74: An example of traffic interruption following a debris flow event in the Southern French Alps (Hautes-Alpes 2007, photo: Michel Bon ONF-RTM05).....	95
Figure 75: Fan slope vs. Melton index scatterplot proposed by Jackson et al. (1987) to discriminate debris flow and fluvial fans in the Canadian Rockies .....	96

Figure 76: Linear discriminant function obtained to separate debris flow and fluvial responses from a compiled database of 620 catchments .....	97
Figure 77: Transport infrastructure network and stream network used to characterise potential debris flow impact sites in the Southern French Alps (vectorial data from IGN BD Topo).....	97
Figure 78: Flow chart of the GIS procedure implemented for the automatic mapping of the transport infrastructures most exposed to debris flow impacts.....	98
Figure 79: Potential debris flow impact points along transport infrastructures in the Southern French Alps .....	98
Figure 80: (A) The density of potential debris flow impact sites per km of transport infrastructure for each municipality of the Southern Alps, derived from morphometric analysis. (B) Number of registered damaging flood events per km of transport network for each municipality of the French Alps, as recorded by the historical database from ONF-RTM. ....	99
Figure 81: The rockfall Energy Line Angle concept .....	100
Figure 82: The difference between the Energy Line geometric angle (in red) and the Energy Line travel angle (in blue).....	101
Figure 83: The difference between the Energy Line Angle ( $\beta$ ) and the shadow one ( $\gamma$ ).....	102
Figure 84: How to determine the maximal speed of a rock using the Energy line Angle .....	102
Figure 85: Table 1: The input data needed for the use of Rockfor <sup>LIN</sup> .....	104
Figure 86: The 25x25m resolution DTM (Digital Terrain Model) of the French Département des Hautes-Alpes case study (5549 km <sup>2</sup> ) .....	104
Figure 87: The map of the issues of the French Département des Hautes-Alpes case study .....	105
Figure 88: The forest map of the French Département des Hautes-Alpes case study .....	105
Figure 89: Threshold values for determining rockfall release areas for main DTM resolutions.....	106
Figure 90: Example of variation of release area configuration expressed with a slope threshold of 43° .....	107
Figure 91: The parameters influencing the potential release vertical height.....	107
Figure 92: Value of the potential Vertical Release Height for 1x1, 10x10 and 25x25m DTM resolutions with $\beta \leq \alpha$ and $\beta$ slope length = DTM resolution .....	107
Figure 93: Map of rockfalls release zones obtained with Rockfor <sup>LIN</sup> (French Département des Hautes-Alpes case study) .....	108
Figure 94: State of the Art for the Energy Line Angle values .....	110
Figure 95: Statistical distribution of the published minimal and maximal geometrical Energy Line Angle.....	110
Figure 96: Results of the statistical analysis of the geometrical ELA in the French Northern Alps rockfalls database.....	110
Figure 97: the geometrical ELA matrix of RockFor <sup>LIN</sup> .....	111
Figure 98: Rockfalls probable propagation zones map obtained with RockFor <sup>LIN</sup> , and using a 25x25m DTM, for the French Département des Hautes-Alpes case study. ....	111
Figure 99: a) Probable rockfall propagation zones (in orange, the release areas in red) determined with an ELA of 32° and using a 25x25m DTM for the Queyras area (zoom of the map on the scale of	

the Département des Hautes-Alpes case study - b) Probable rockfall propagation zones (in orange, the release areas in red) determined with an ELA of 38° and using a 25x25m DTM for the Queyras area (zoom of the map on the scale of the Département des Hautes-Alpes case study).....	112
Figure 100: Probable rockfalls propagation zones including the probable reaching frequency (in red the release areas) determined with an ELA of 32° and using a 1x1m LiDAR DTM for Forte buso case study (Italy).....	112
Figure 101: Probable rockfalls propagation zones including the probable reaching frequency (in red the release areas) determined with an ELA of 38° and using a 1x1m LiDAR DTM for Forte buso case study (Italy).....	113
Figure 102: Probable rockfalls propagation zones including the probable reaching frequency (in red the release areas) determined with an ELA of 38° and using a 20x20m DTM for Tognazza Cavallazza case study (Italy).....	113
Figure 103: Probable rockfalls propagation zones including the probable reaching frequency (in red the release areas) determined with an ELA of 32° for the Austrian case study. ....	114
Figure 104: Probable rockfalls propagation zones including the probable reaching frequency (in red the release areas) determined with an ELA of 32° for Baca case study (Slovenia).....	114
Figure 105: An example of validation of the results obtained with RockFor <sup>LIN</sup> based on the event of the 28/12/2008 in the district of saint Paul de Varcès in France.....	115
Figure 106: a) Probable rockfalls 32° ELA propagation zones (in orange) and human infrastructures localisation for the Queyras area (zoom of the map on the scale of the Département des Hautes-Alpes case study - (road networks in blue) b) Probable rockfalls' 38° ELA propagation zones (in orange) and human infrastructures localisation for the Queyras area (zoom of the map on the scale of the Département des Hautes-Alpes case study).....	116
Figure 107 :Illustration of the identification of endangered issues using the rockfalls propagation map provided by RockFor <sup>LIN</sup> for the case study Mittewald in Italy .....	117
Figure 108: Rockfalls potential protection forest map obtained with RockFor <sup>LIN</sup> , and using a 25x25m DTM, for the French Département des Hautes-Alpes case study .....	119
Figure 109: Rockfall potential protection forest (in green) map obtained with RockFor <sup>LIN</sup> (property of Irstea), and using a 25x25m DTM, for the French Queyras case study (zoom of the map on the scale of the Département des Hautes-Alpes case study).....	120
Figure 110: The main criteria for the determination of avalanche release areas using a DTM raster	122
Figure 111: Criteria thresholds, using a 20x20m or 25x25m raster DTM, for determining avalanche release areas within Avalfor <sup>LIN</sup> .....	122
Figure 112: 3D view (derived from a 1x1m LiDAR DTM) of the Italian case study "Passo Rolle" with the draping of the snow avalanches past events cadastre .....	123
Figure 113: Snow avalanches past events cadastre of the Italian case study "Passo Rolle" .....	123
Figure 114: Snow avalanches release areas (in pink) determined with Avalfor <sup>LIN</sup> for the Italian case study "Passo Rolle". The initial 1x1m Lidar DTM has been resampled to 20x20m.....	124
Figure 115: The DTM (expressed using the altitudinal range) of the Austrian case study of the Paramount project. ....	124
Figure 116: The localization, using Avalfor <sup>LIN</sup> , of potential snow avalanche release areas (in pink) in the Austrian case study of the Paramount project. ....	125



Figure 117: The localisation, using Avalfor<sup>LIN</sup>, of potential avalanche release areas (in yellow) in one of the French sites of the Paramount project. The envelopes in red correspond to the past event cadastre (called CLPA in French, Carte de Localisation de Phénomènes d’Avalanche [Localisation Map of Avalanche Phenomena]) ..... 125

Figure 118: The avalanche Energy Line Angle concept ..... 126

Figure 119: An extract of the geographical data used for the ( $\alpha,\beta$ ) model calibration for the French topographical conditions of the valley of Chamonix. The black lines represent the limits of the propagation envelopes of the past events and the coloured ones the travel path associated with each envelope. .... 127

Figure 120: The ( $\alpha,\beta$ ) model calibration using a 25x25m DTM for the French topographical conditions of the Valley of Chamonix ..... 128

Figure 121: The ( $\alpha,\beta$ ) model calibration using a 1x1m DTM for the French topographical conditions of the valley of Chamonix ..... 128

Figure 122: State of the art and associated statistics for the Energy Line Angle values, ( $\alpha,\beta$ ) model, for avalanches ..... 129

Figure 123: The different values and the differences of  $\alpha$  angle obtained with the French, Italian and Austrian models ..... 130

Figure 124: Snow avalanches past events data used for the calibration of the Italian model for the Italian case study “Passo Rolle”. The initial 1x1m Lidar DTM has been resampled to 20x20m..... 131

Figure 125 : Snow avalanches hazard mapping with Avalfor<sup>LIN</sup> for the Italian case study “Passo Rolle”. The initial 1x1m Lidar DTM has been resampled to 20x20m. In red the release areas, in grey the run-out zones and in blue the recorded past event data. .... 131

Figure 126: the result of the watershed analyses (in yellow, green and blue) including the determination of the travel paths, and of the buffer zones (in pink) calculation at the run-out point using Avalfor<sup>LIN</sup>, in the Austrian case study of the Paramount project. .... 132

Figure 127: the result of the travel paths, and of the buffer zones (in pink) calculation at the run-out point using Avalfor<sup>LIN</sup>, in the Austrian case study of the Paramount project. .... 132

Figure 128: extract of the snow avalanches hazard map for one of the Slovenian cases studies. In red the release areas, in blue and yellow simulated avalanche paths and run-out zones. .... 133

Figure 129: Avalanche hazard map obtained with Avalfor<sup>LIN</sup>, and using a 25x25m DTM, for the French Département des Hautes-Alpes case study ..... 134

Figure 130: Detail of avalanche hazard map obtained with Avalfor<sup>LIN</sup>, and using a 25x25m DTM, for the French Queyras case study (zoom of the map on the scale of the Département des Hautes-Alpes case study)..... 134

Figure 131: An example of validation of the results obtained with Avalfor<sup>LIN</sup> using the past event database of a different French site from the one used for the calibration of the French ( $\alpha,\beta$ ) model ..... 135

Figure 132: An example of validation of the results obtained with Avalfor<sup>LIN</sup> using a real event which had occurred in another region than the one used for the for the calibration of the French ( $\alpha,\beta$ ) model. In red the release are determined with Avalfor<sup>LIN</sup>, in blue the travel path determined with Avalfor<sup>LIN</sup>, in the circles the real zones (yellow = release area, green = stopping point). .... 136



Figure 133: Avalanche hazard and human infrastructures localisation obtained with Avalfor <sup>LIN</sup> and using a 25x25m DTM, for the French Queyras case study (zoom of the map on the scale of the Département des Hautes-Alpes case study ) .....	137
Figure 134: snow avalanches potential release areas under forest canopy map obtained with Avalfor <sup>LIN</sup> , for the Austrian case study.....	138
Figure 135: Snow avalanches run –out zones simulated from the potential release areas under forest canopy map obtained with Avalfor <sup>LIN</sup> , for the Austrian case study. ....	138
Figure 136: Avalanche potential protection forest map obtained with Avalfor <sup>LIN</sup> , and using a 25x25m DTM, for the French Département des Hautes-Alpes case study .....	140
Figure 137: Avalanche potential protection forest (in yellow) map obtained with Avalfor <sup>LIN</sup> (property of Irstea), and using a 25x25m DTM, for the French Queyras case study (zoom of the map on the scale of Département des Hautes-Alpes case study) .....	141
Figure 138: general map, AMap 3D, undefined scale .....	145
Figure 139: Example of the analysis along the S16 and the L68 near Pettneu .....	146
Figure 140: Relationship of slope and debris flow detachment areas (acc. Damm, 2008).....	149
Figure 141: Relationship between catchment area and debris flow (IRASMOS 2011).....	150
Figure 142: Indicated endangerment around Pettneu am Arlberg at IADL of 0.5 - 0.7 .....	152
Figure 143: Indicated endangerment around Pettneu am Arlberg at IADL of 0.71 - 0.8.....	153
Figure 144: Indicated endangerment around Pettneu am Arlberg at IADL of 0.81 - 0.9.....	153
Figure 145: Indicated endangerment around Pettneu am Arlberg at IADL above 0.9 .....	154
Figure 146: Hazard assessment procedure .....	158
Figure 147: Vulnerability assessment procedure.....	160
Figure 148: Risk assessment procedure .....	160
Figure 149: Rapid mass movements such as debris flows are very destructive phenomena in mountain areas (Tacnet et al., 2009) .....	162
Figure 150: Mitigation measures are based either on non-structural measures (such as land-use control) and structural measures (protection works) - adapted from (Tacnet et al., 2010b)(Tacnet et al., 2012).....	163
Figure 151: Definition of the concept of efficiency (or effectiveness) [Tacnet et al., 2012a].....	165
Figure 152: results of numerical modelling (including uncertainty assessment like the hybrid approach) [Dupouy et al., 2012] are used as inputs for functional failure scenarios. ....	165
Figure 153: Principle of qualitative assessment of functional failures based on expert assessment (Tacnet et al., 2011).....	166
Figure 154: Quantitative assessment of functional failures based on fuzzy indicators (Tacnet et al., 2011).....	167
Figure 155: Temporal steps and functional areas for risk assessment: analogy between the different rapid mass movements (J.-M. Tacnet) .....	167
Figure 156: Example of damage due to debris flows: protection works are built in order to reduce risk in the most vulnerable areas (buildings, roads, railways etc.) such as the alluvial fan [Dupouy et al., 2012].....	168

Figure 157: Different kinds of active (check dams) and passive (sedimentation dams, channels) structural protection measures – adapted from (Tacnet, 2007) .....	168
Figure 158: Examples of subsystem identification for MADS/MOSAR implementation in the context of torrent risk (Kaiber da Silva,2011).....	169
Figure 159: Example of a failure tree for a dike outflowing (Kaiber da Silva, 2011).....	170
Figure 160: Application of a hybrid approach for information imperfection assessment to the context of natural hazards (debris flows): case study of the Paramount project – GIS representation of Scenario 55 000 m3 – quantile 95% (Dupouy et al., 2012) (Kaiber da Silva,2011) .....	171
Figure 161: Protection structures survey form .....	172
Figure 162: State and suitability of existing protection structures .....	173
Figure 163: Typical protection structure in Baška grapa.....	174
Figure 164: Collapsed protection structure due to neglect .....	174
Figure 165: Avalanche risk map and state of the protection structures.....	175
Figure 166: Method of analysing the response of rockfall protection barriers to produce reliable parameters for rockfall hazard assessment .....	177
Figure 167: Main components of a typical rockfall protection barrier .....	177
Figure 168: Data collected on a semi-flexible barrier by in situ surveys.....	178
Figure 170: Main types of semi-flexible and rigid protection barriers within the PAB.....	179
Figure 169:: Main types of flexible protection barriers within the PAB.....	179
Figure 171: Main types semi-flexible and rigid barriers and damage (number 19 below) .....	180
Figure 172: Flexible barriers and damage types.....	180
Figure 173:: Main types of semi-flexible and rigid barriers and damage types.....	180
Figure 174: A steel, rigid barrier type in the Province of Bolzano.....	181
Figure 175: Main types of formation of plastic hinges (in red) at the impact points .....	181
Figure 176: The Tubre steel rigid barrier type.....	182
Figure 177: Main types – the three functional modules model of the Tubre barrier type.....	182
Figure 178: Response of the barrier during an impact at the maximum energy level.....	183
Figure 179: The Anas steel semi-flexible barrier type.....	183
Figure 181: Response of the barrier during an impact at the maximum energy level.....	184
Figure 182: The Stecher steel semi-flexible barrier type .....	184
Figure 180:: Main types of formation of plastic hinges (in red).....	184
Figure 184: Response of the barrier during an impact at the maximum energy level .....	185
Figure 185: Different types of rockfall barriers .....	185
Figure 183:: Main types Deformed shape during the analysis.....	185
Figure 186: Main types - the OM-CTR 30A flexible barrier type .....	186
Figure 187: The three functional modules of the OM-CTR 30A barrier type.....	186

Figure 188 : Experimental and numerical response of the barrier during an impact at the maximum energy level .....	186
Figure 189: Main types – the OM-CTR 30A flexible barrier type .....	187
Figure 190: The three functional modules model of the Safe 750 barrier type .....	187
Figure 191: Experimental and numerical response of the barrier during an impact at the maximum energy level .....	188
Figure 192: Deformed shape of the ANAS barrier type: a) 3.5 m post spacing and b) 6.5 m post spacing.....	189
Figure 193: Response of the barriers during an impact at the maximum energy level.....	189
Figure 194: Deformed shape of the ANAS barrier type: a) 2 m nominal height and b) 4 m nominal height.....	189
Figure 195 : Table: response of the barriers during an impact at the maximum energy level.....	190
Figure 196: Main types - deformed shape of the damaged barrier (corrosion, case a)) at the maximum nominal energy level (3000 kJ).....	191
Figure 197: Experimental and numerical nominal and actual (corrosion, case a)) response of the barrier during an impact at the maximum energy level. ....	192
Figure 198: Experimental and numerical nominal and actual (corrosion, case b)) response of the barrier during an impact at the maximum energy level .....	192
Figure 199: Deformed shape of the damaged barrier (failure case a) at the maximum nominal energy level (3000 kJ).....	193
Figure 200: Experimental and numerical nominal and actual (failure, case a)) response of the barrier during an impact at the maximum energy level .....	193
Figure 201 : Integration is necessary from decision support tools to information systems [Vidaud-Barral et al., 2010] .....	199
Figure 202 : Qualitative comparison table of rockfall propagation software (proposed by PP3 – Serv. Geol. Bolzano) .....	213
Figure 203 : Test of 2D rockfall simulation software (Serv. Geol. Bolzano) .....	214
Figure 204 : Test of 3D rockfall simulation software - examples of graphical results (Serv. Geol. Bolzano).....	214

## WARNING

This report is a collection of contributions of partners of the PARAMount project. The views in this report are those of the authors alone and not necessarily those of the supporting individuals or organisations. Each section has been written and verified under the responsibility of their respective author or group of authors as mentioned in the text.

The reader is invited to refer to publications for any further technical and scientific information about the methods that are used and their applications to the specific context of roads.

## Contributors to this report

This report gathers main findings developed in the framework of the PARAMount project. Contributions to the different sections are described below:

- Section 0 - Executive summary : Jean-Marc Tacnet<sup>1</sup> (General coordination and work package n°7 leading activities)
- Section 1 : Jean-Marc Tacnet<sup>1</sup> and Hubert Siegl<sup>3</sup>
- Section 2 : Jean-Marc Tacnet<sup>1</sup>
- Section 3 : 3.1) Marc S. Adams<sup>6</sup>, Antonia Zeidler<sup>6</sup> 3.2) Karl Hagen<sup>6</sup>, Peter Andrecs<sup>6</sup>, Marc S. Adams<sup>6</sup>, Karl Kleemayr<sup>6</sup>, Antonia Zeidler<sup>6</sup>
- Section 4: 4.1) Jean-Marc Tacnet<sup>1</sup>, Eric Mermet<sup>9</sup>, 4.2) Verena Larcher, Volkmar Mair and Claudia Stradia
- Section 5 : : 5.1) Jean-Marc Tacnet<sup>1</sup> 5.2) Jean-Marc Tacnet<sup>1</sup> 5.3) Jean-Marc Tacnet<sup>1</sup> , Guillaume Dupouy, Dominique Laigle<sup>1</sup>, Eric Chojnacki
- Section 6 : Introduction by Jean-Marc Tacnet<sup>1</sup> 6.1) Frédéric Liébault<sup>1</sup>, Mélanie Bertrand<sup>1</sup> 6.2) Frédéric Berger<sup>2</sup>, Nicolas Clouet<sup>2</sup> and David Toe<sup>2</sup> 6.3) Manfred Scheikl<sup>4</sup> , David Powell<sup>4</sup> and Christian Rachoy<sup>4</sup>
- Section 7 : 7.1) Jean-Marc Tacnet<sup>1</sup>, Corinne Curt, Juliana Kaiber da Silva 7.2) Gašper Rak, Gašper Zupančič, Daniel Kozelj, Jošt Sodnik, Jože Papež, Franci Steinman and Matjaž Mikoš<sup>8</sup> 7.3) Verena Larcher, Volkmar Mair and Claudia Stradia
- Section 8 : all partners
- Appendix : 1) : Jean-Marc Tacnet<sup>1</sup> and Irstea team 2) Gašper Rak, Gašper Zupančič, Daniel Kozelj, Jošt Sodnik, Jože Papež, Franci Steinman and Matjaž Mikoš<sup>8</sup> and Verena Larcher, Volkmar Mair and Claudia Stradia<sup>7</sup>

<sup>1</sup> Irstea , snow avalanches engineering and torrent control research unit, Grenoble, France

<sup>2</sup> Irstea , Moutains ecosystems research unit, Grenoble, France

<sup>3</sup> Lebensministerium, Austria

<sup>4</sup> OEBB, Austrian Railway company and Alpinfra, Austrian consulting company, Austria

<sup>6</sup> BFW, Bundesforschungszentrum für Wald (BFW), Institute for Natural Hazards, Innsbrück, Austria

<sup>7</sup> Geological Service of Bolzano Province, Bolzano, Italy

<sup>8</sup> University of Ljubjana, Slovenia

<sup>9</sup> IGN (National geographic institute), COGIT, France

## 0 Summary

### The need for decision support systems

Alpine Space is well endowed with high-level transportation infrastructures, but lacks alternatives in case of temporary or permanent disruption. Due to higher traffic frequency, damage potentials are increasing. In a globalised Alpine Space, a prospering economy depends more and more on permanent connectivity, accessibility and just-in-time transport relations. All Alpine European countries experiment damages caused by natural hazards especially in mountains areas exposed to avalanches, torrent debris flows and rockfalls. Their effects on infrastructures correspond either to direct damages to users (people, vehicles, materials goods), infrastructures (roads, railway tracks, bridges, safety equipment...) or indirect damages related to the linking functions of roads.

Risk management decision processes appear as quite complex. Risk managers are in charge of both hazard, vulnerability and risk assessments and also risk reduction measures including structural measures such as protection works or non-structural measures such as land-use control and regulation. In that context, adapted decision-facilitating methods are obliged to face some real-life issues such as lack of knowledge, imperfect available information and also reduced time and budgets for surveys, maintenance, investments etc.

### Main developments

A global framework is proposed before each partner presents his contribution and development. In the framework of the PARAMount project, the partners have proposed contributions to the different steps of the risk management circle corresponding either to early warning or mitigation measures including hazard, risk assessment and protection works efficiency analysis. Section 1 is a global presentation of the PARAMount project goals. Section 2 describes the decision context related to natural risks management. Section 3 describes some developments of the project related to methodologies used in order to identify needs and requirements for decision support systems developments. Section 4 proposes methods to assess indirect vulnerability related to transport function disruption which is a specific feature of risk assessment for roads and railways. The section 5 proposes some innovative tools to help decision-making in a context of imperfect knowledge. The Section 6 deals with a multi-scale approach for decision on a regional scale and section 7 deals with the question of assessment of protection works' effectiveness. The last section proposes a synthesis of results and some perspectives.

### Key results and remaining perspectives

In the framework of the PARAMount project (<http://www.paramount-project.eu/>), Work Package n°7 has tried to look at the problem of decision-making related to railway and roads management in a new light. While the risk management process remains indeed very complex, two kinds of tools have been proposed to improve methods and expertises.

On the one hand, approaches such as hazard and risk assessment, protection works effectiveness based on numerical modelling have been performed by the different partners. Those techniques and methods are obviously valuable tools to help decision-makers and technicians to take decisions related to risk management: they correspond to the application of existing methods to the different national test beds. Those applications have allowed the dissemination of technical and scientific knowledge all over the different countries: as an example, regional approaches for avalanches and

rockfalls have been widely applied and used by the different European partners. Through the calculation of the vulnerability and exposure level of roads, many partners have moved from previous sed approaches based only on hazard level to risk level analysis. In many cases, depending on their starting point and past-experience with risk management methods, several steps are still required. and some further developments are still expected after the PARAMount.

On the other hand, project partners have proposed some new and interesting developments that can be summarised as follows:

- Implementation of existing methods for hazard assessment of wide geographical zones (multi-scale decision-facilitating approaches, from local to regional scale);
- Global risk awareness and communication improvement tools (e.g. BFW);
- Design of specific decision support systems such as information systems for road networks (e.g. Autonomous Province of Bolzano, Univ. Ljubljana Slovenia) which have increased knowledge about the existing protection measures through specific surveys ;
- Regional use of models to assess hazards and risks for railways tracks (OEBB);
- Advanced analysis of network structural properties for road importance and criticality assessment ;
- Development of advanced decision support methods for multi-criteria decision-making including information imperfection management (Irstea);
- Innovative tools and methodologies to assess and consider information imperfection , including uncertainty, in the decision processes (Irstea).

All these methods are based on an integrated approach to risk management in mountains. Technical knowledge about phenomena is of course an essential step for effective risk management. At the same time, the experience of the PARAMount project has finally shown that building specific decision-facilitating methods requires both the use of existing ad hoc methods and also close collaboration with decision-makers. This risk dialogue, the capitalisation of knowledge from the stakeholders, the infrastructure managers during the PARAMount project led to an improvement of methods for risk management process in the context of railways and roads.

# 1 Context of roads and railways exposed to natural hazards and PARAMount project objectives

*This section has been written and verified by Jean-Marc Tacnet (Irstea, Snow Avalanche Engineering and Torrent Control Research Unit, Grenoble, France, WP7 leader) and Hubert Siegl (Austrian Lebensministerium, Lead partner of the PARAMount project).*

## PARAMount project background

Well-functioning passenger and freight links are vital for European undertakings and citizens. The efforts of the European Union and its member states are aimed at fostering clean, safe and efficient travel throughout Europe, underpinning the internal market of goods and the right of citizens to travel freely throughout the EU. In the light of the request of the Alpine Convention and its protocol on transport for the protection of communication routes against natural hazards, the partners of the PARAMount project have contributed towards the achievement of this challenging objective.

Due to its central geographical position, the transport system in the Alpine area has a vital role in the transit of passenger and freight from north to south and east to west. The transport system of the Alpine region covers thousands of kilometres and some of the most challenging terrain in the world. Furthermore, climate change may increase climate variability beyond the limits of past experience. Important communication routes may face more frequent natural hazards, including rockfalls, landslides and avalanches.

To support the providers of transport infrastructure, transport operators as well as regional/national authorities in their efforts to continue offering, under changing climate conditions, high standards of transport safety and accessibility, PARAMount has promoted a comprehensive, cross-sectoral risk analysis of natural hazards with a specific focus on their impacts on transport infrastructure as well as the improvement of risk management tools designed for the preparation of infrastructure related measures. The local and regional application of the knowledge, solutions and recommendations generated by the partners of the PARAMount project will contribute to the sustainable development of Alpine Space.

## Relevant issues addressed by the PARAMount project

The main challenges addressed by the project:

- Improved accessibility with reference to reliability as well as transport safety regarding natural hazards under climate change
- Consistency and completeness of decisions:
  - Support of decision-makers in selecting the adequate tools for specific situations
  - Optimisation of the decision-making process by using reliable procedures for risk assessment
- Effort optimisation for accessibility resp. safety in the transport sector
- Efficiency increase of temporary measures (increase of reliability of risk-prognosis)
- Optimisation of efforts regarding accessibility and safety in the transport sector



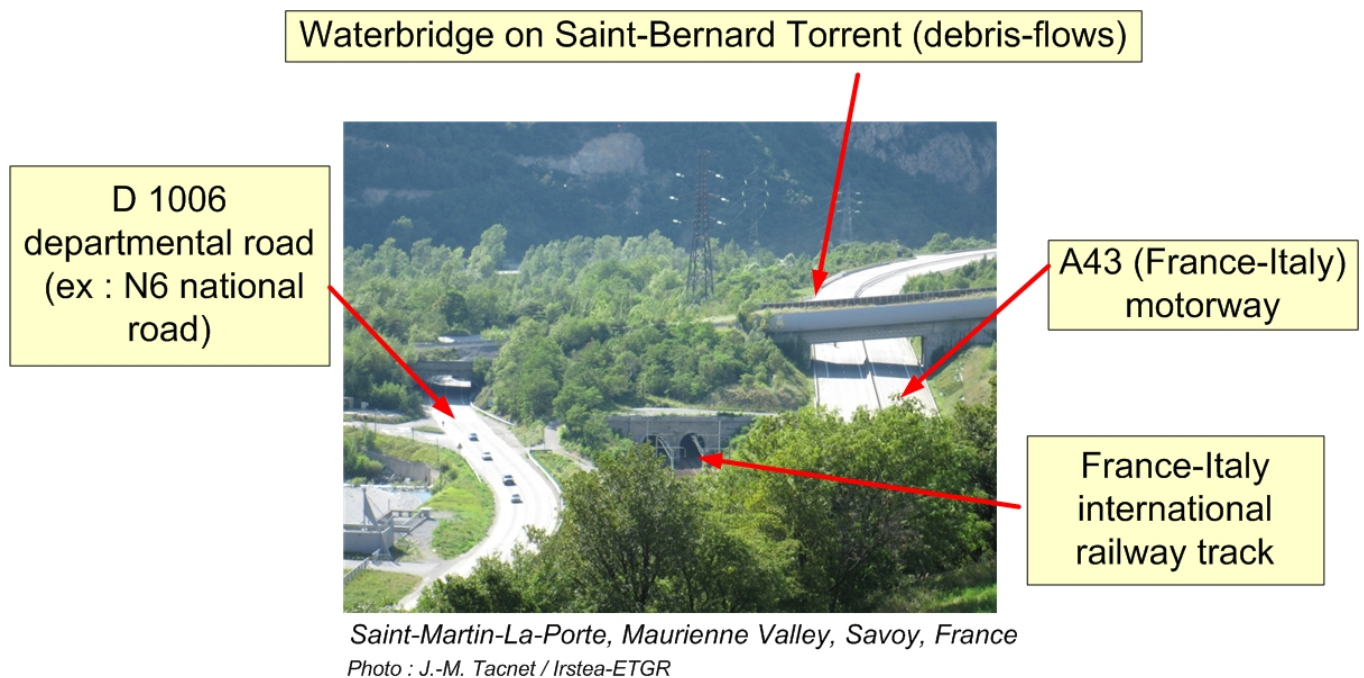
- increasing the effectiveness of temporary measures (improvement of the reliability of risk predictions)

## PARAMOUNT consortium structure

PARAMOUNT brought together 13 institutions from five different European countries, including authorities, public service providers, scientific experts and end-users mainly from the field of natural hazard management and protection. Main beneficiaries (transport operators and regional authorities) were integrated as observers (currently more than 20 participants). The project started in September 2009 and finished in November 2012.

## Needs and goals of the PARAMOUNT project

Alpine Space is well endowed with high-level transportation infrastructure, but lacks alternatives in case of temporary or permanent disruption. In a globalised Alpine Space, a prospering economy depends more and more on permanent connectivity and just-in-time transport relations. Owing to higher traffic frequency, damage potentials are increasing. For historic reasons, transport routes do not comply with today's safety considerations. Furthermore protective structures may appear as inadequate in terms of withstanding growing dangers resulting from climate change.



**Figure 1 : Example of road and railway exposure to natural hazards in mountains**

All Alpine European countries experience damages caused by natural hazards especially in mountain areas exposed to avalanches, torrent debris flows and rockfalls. Effects on infrastructures correspond



either to direct damages to users (people, vehicles, transported materials...), infrastructures (roads, railway tracks, bridges, safety equipment...) or indirect damages related to the linking functions of roads.

As a result, natural hazards permanently cause consequences for transport:

- Socioeconomic consequences: infrastructure providers are liable for transport-related damages and losses suffered by human beings;
- Direct infrastructure costs during and after events increase because of physical damages;
- Indirect socioeconomic costs: arising delays or detours affect local population, industries and corridors and therefore disrupt the value added chain.



**Figure 2: Endangered railway infrastructure. Bohinjska soteska, Slovenia (photo: Jošt Sodnik)**



**Figure 3: Even such a small rockfall event can cause serious damage – Višnja Gora, Slovenia (photo: Jože Papež)**

Infrastructure managers are responsible for providing safe and reliable conditions for use of their infrastructures. National and international passenger and freight traffic suppliers are committed to their customers for reliability and safety. Tools and methodologies for risk assessment including direct and indirect vulnerabilities and effectiveness of protection works are required.

In that context, the main goal of PARAMOUNT (Improved accessibility: Reliability and safety of Alpine transport infrastructure related to mountainous hazards in a changing climate) is to **improve hazard management strategies** for railway **infrastructures protection** by the adaptation of existing tools and practices to the special requirements mentioned above.

The knowledge of transport infrastructure providers, transport operators and regional or national authorities combined with the specialised knowledge of scientific experts on natural hazard management from all five partner countries (Austria, France, Italy, Slovenia and Switzerland).

The operational aims of PARAMOUNT includes:

- Increasing infrastructure relevance of hazard process analyses
- Improving knowledge about hazard-specific impacts on transport infrastructure
- Extending risk assessment to infrastructure lines outside of populated areas
- Improving coverage with hazard maps relevant for transport infrastructure
- Improving knowledge about regional damage potentials
- Improving knowledge transfer and risk awareness
- Establishment of a risk dialogue with relevant stakeholders, bringing together experts from the transportation sector and natural hazard management
- Creating a new sustainable network of actors to deal with natural hazard management in the transport sector

- Improving acceptance of risk reduction measures by providing arguments for discussion with individuals and institutions concerned
- Improving risk management tools for infrastructure-specific measures
- Supporting risk-related decision-making with reliable tools for risk assessment

## Main activities

The knowledge of transport infrastructure providers, transport operators and regional or national authorities responsible for infrastructure protection has been combined with knowledge of natural hazard management. This existing but scattered knowledge exists has been consolidated during PARAMount in order to gain added value. By joint work in an intensive risk dialogue, the knowledge was integrated and adjusted according to the requirements of project partners and stakeholders.

The thorough initial state-of-the-art analysis of natural hazard management and accessibility constraints and potentials has considered the risk perception and information requirements of decision-makers. Based on this cross-sectoral analysis, existing natural hazard management tools were adapted to the special requirements of transport infrastructure protection. Easy-to-use tools were tested and implemented in the selected regional test beds, taking into account regional risk situations, existing management systems and legal and institutional frame conditions. The results were evaluated and used to improve existing Decision Support Systems (DSS), serving as a basis for efficient decision-making in the pilot regions.

Building on the detailed analysis of the various risks existing in different test areas, the partners participating in the PARAMount project developed natural hazard management tools tailored to meet the specific requirements of the transport sector. The envisaged development of reliable decision support systems for risk management in the transport sector is therefore a contribution to the challenging tasks of local and regional decision-makers.

This report deals with developments related to Decision Support Systems (DSS) for railways and road infrastructures exposed to natural hazards in mountains in the framework of the 7<sup>th</sup> work package of PARAMount project. This document, which gathers contributions of different project partners is organized as described in Figure 4 :

Section 1 is a global presentation of the PARAMount project goals. Section 2 describes the decision context related to natural risks management. Section 3 describes some developments of the project related to the methodologies used in order to identify needs and requirements for decision support systems developments. Section 4 proposes methods to assess indirect vulnerability related to transport function disruption which is a specific feature of risk assessment for roads and railways. Section 5 proposes some innovative tools to help decision-making in a context of imperfect knowledge. Section 6 deals with a multi-scale approach for decision on a regional scale and section 7 deals with the question of assessment of protection works effectiveness.



## 0 Executive Summary

### 1 Context of roads and railways exposed to natural hazards

### 2 Methodological aspects for Decision Support Systems (DSS) design

### 3 Development of methodologies for decision context description

- Strategic level: a simple communication and strategic decision support tool for natural hazard management (CDT)
- Regional Risk Dialogue (RRD) in Austria (Stanzer Valley): framework, results and lessons learned

### 4 Development of methodologies for indirect vulnerability evaluation : network analysis for road accessibility and criticality assessment

- Importance and criticality of roads exposed to natural hazards in mountains: an approach based on network structural properties analysis
- Road vulnerability assessment based on network analysis

### 5 Development of advanced methodologies for decision support

- Advanced multi-criteria decision making methods (MCDM) considering information imperfection
- An innovative information fusion process to consider information quality and heterogeneous information sources
- How far can we be confident in numerical modelling results? An innovative information imperfection propagation hybrid process

### 6 Decision spatial down and up -scaling: towards an integrated approach from regional to local scale

- Debris-flows susceptibility: a regional approach
- Avalanches and rockfall regional analysis with a special focus on protection role of forest
- Prototype of a regional hazard management system on the austrian railway network
- An operational avalanche risk evaluation system on an alpine railroad section

### 7 Protection works effectiveness analysis

- An approach based on dependability (safety and reliability) analysis
- Comparison of the state of existing protection structures and the current risk situation as a way of setting risk mediation priorities
- Protection works effectiveness based on mechanical evaluation of rock-fall barriers

### 8 Synthesis and perspectives for further developments

#### 9 References

#### 10 Appendix

- Discussion guidelines for DSS evaluation: a framework for decision context identification
- Numerical modelling in the decision process: examples of qualitative evaluation of models results

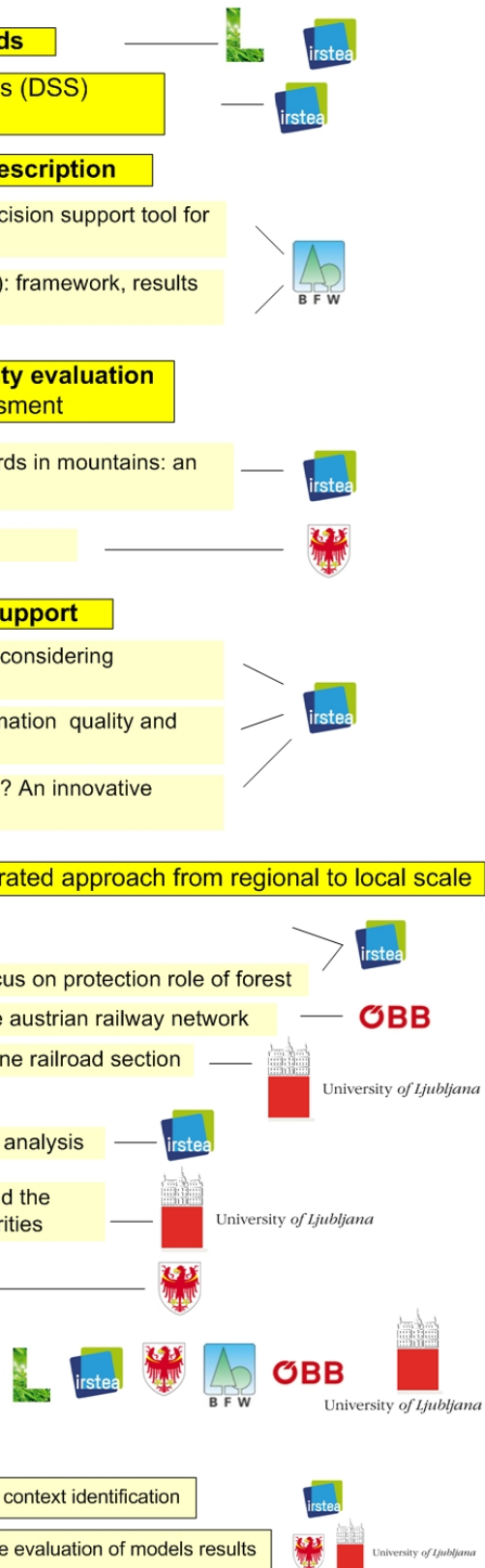


Figure 4 : Structure of the PARAMOUNT WP7 report

## 2 Natural risk management process: needs and requirements for Decision Support Systems

This section has been written and verified by Jean-Marc Tacnet (Irstea, Snow Avalanche Engineering and Torrent Control Research Unit, Grenoble, France).

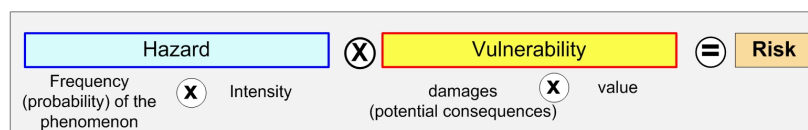
Risk management is a complex decision process related to several temporal steps and different geographical areas. This section briefly recalls the principles and concepts of risks and then illustrates the main features of decision in the specific context of road and railways.

### 2.1 Decision context in the risk management process : temporal and geographical scales

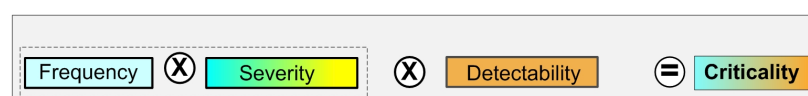
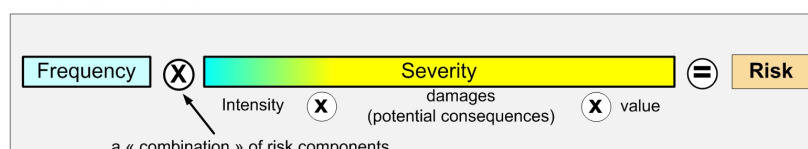
#### Concept of risk

Risk is classically assessed as a combination of hazard and vulnerability in the natural hazard context (or frequency and severity in an industrial context) (Figure 5). We can see here that the components of the equation remain the same in these two contexts. The last line comes from the context of dependability analysis related to industrial systems and introduces the concept of detectability: the criticality of a system failure is assessed according to its frequency, severity and also the possibility of early detection. This approach will be used in the context of road exposed to natural hazards.

##### Natural hazards context



##### Industrial context

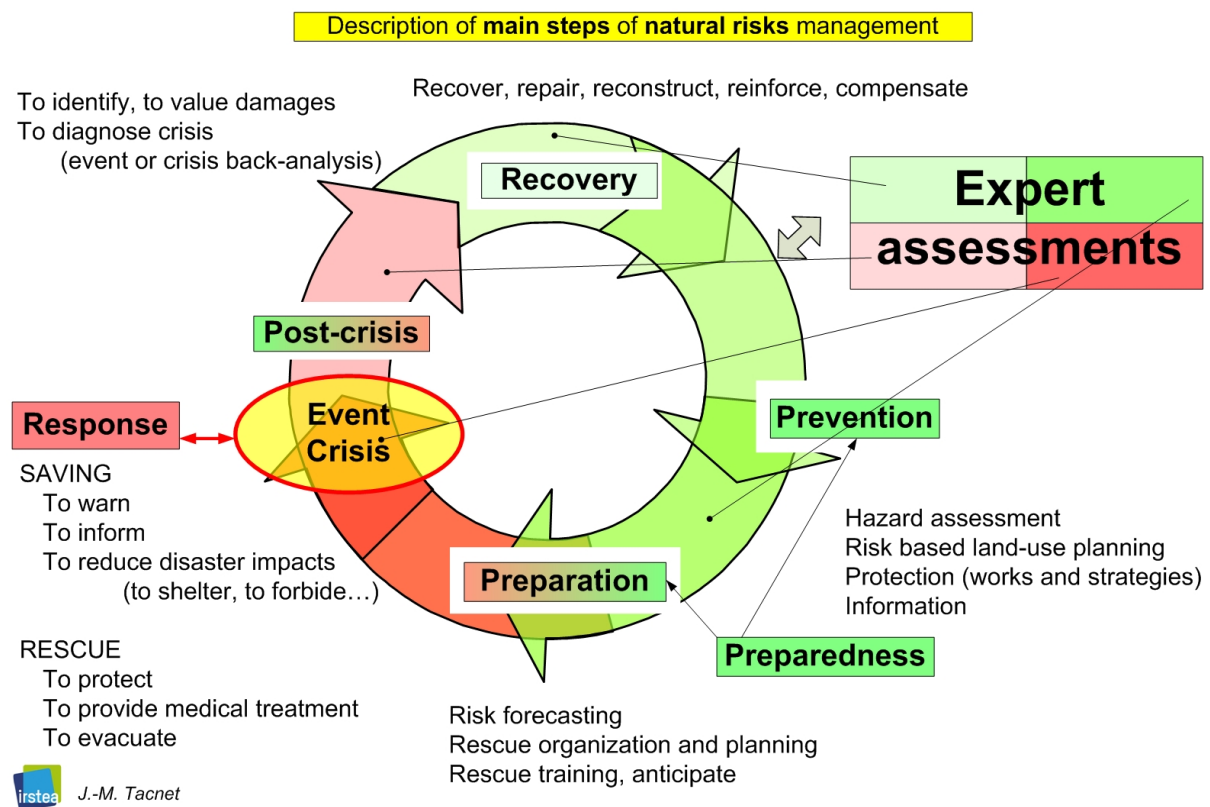


J.M. Tacnet/ Irstea-ETGR

Figure 5 : Concept of risk and criticality in industrial and natural phenomena contexts - from [Tacnet, 2009] [Mortureux, 2001]

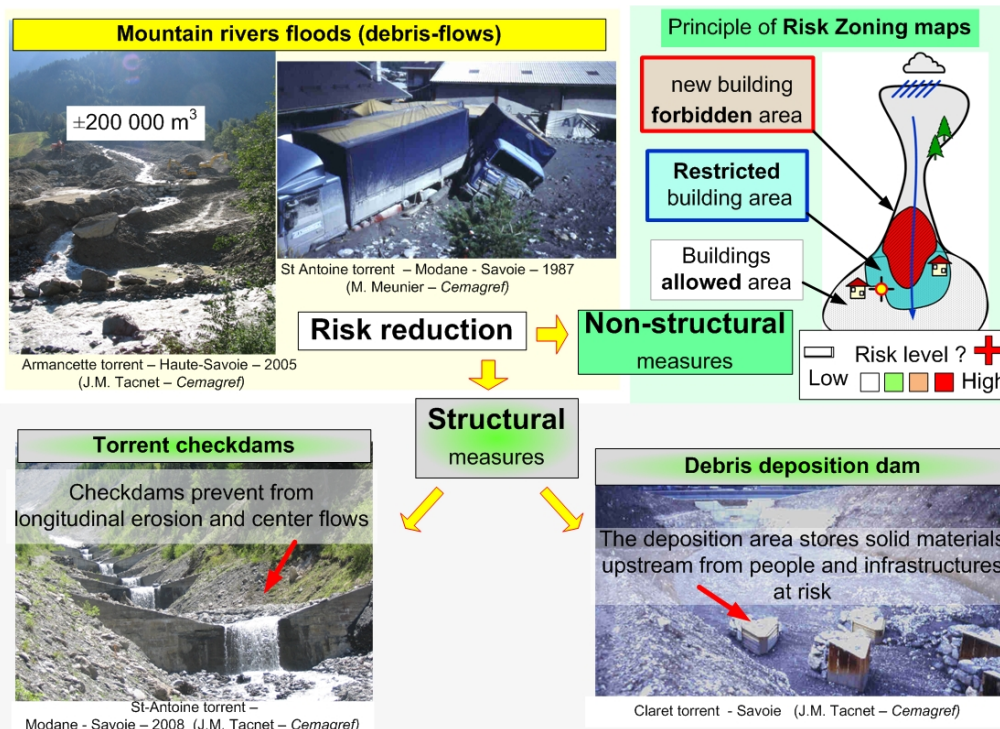
## Temporal steps of risk management

Risk management includes several temporal steps corresponding to crisis management, recovery, prevention and preparation. During all these periods, expert assessments are required to produce and/or help decisions (Figure 6). In the framework of the PARAMOUNT project, the partners have proposed contributions to these different steps.



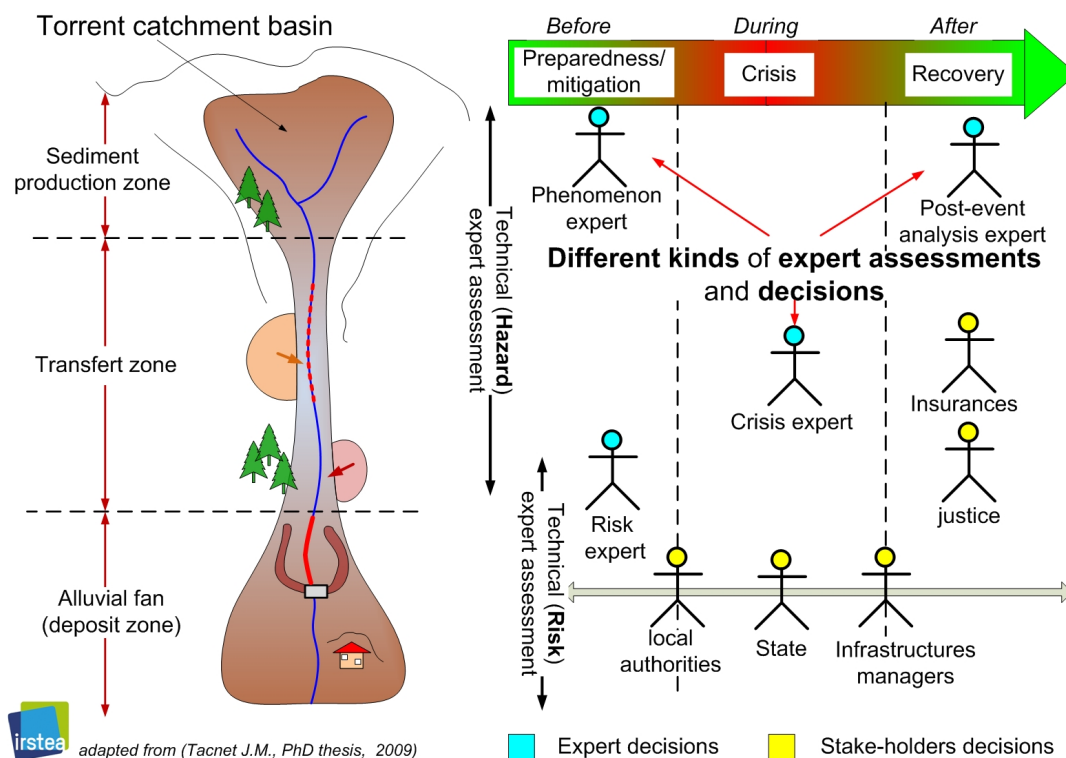
**Figure 6 : Expert assessments are required at every stage of the risk management process**

Experts are involved both for hazard, vulnerability and finally risk assessment. Their assessments are almost always required to take decisions related to the prevention, crisis and recovery measures of the risk management process. Risk managers, local authorities and infrastructure managers have, for example to choose to implement structural measures such as civil engineering protection works and/or non structural measures such as land-use and building controls (Figure 7).



**Figure 7: Expert assessments are required to implement the risk reduction measures ([Tacnet et al., 2010e])**

The same expert may very well contribute to several kinds of expert assessments depending both on the temporal step of the risk management process and the question that has been put to him about either a phenomenon description, a hazard or risk level assessment or the design of suitable protection works. The contribution may range from the design of prevention measures to involvement in legal procedures (Figure 8).



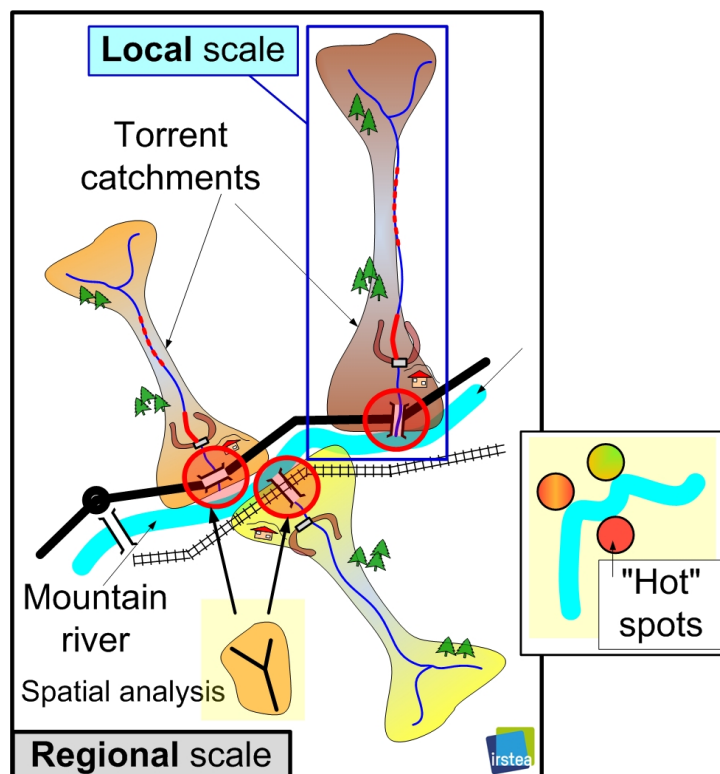
**Figure 8 : Experts can have different roles during the multiple and complex decision framework of the natural risk management process (Tacnet, 2009)**



## Spatial features of decisions: from local to regional scale

Decisions can be taken on different geographic scales ranging from local to regional. Specific decision support systems (DSS) are therefore expected to adapt the efforts involved to assess hazards, vulnerability, risk and also protection works efficiency to the extent of the geographical area studied: quick but inevitably simplified methods are required to identify and prioritise the most important zones to be studied with detailed methods such as local numerical modelling. In that context, one main issue is to analyse the information chain from information to decision based on different expert assessments. Several more or less sophisticated, easy-to-use, time consuming methods are available to assess hazard and risk. Obviously, detailed methods cannot be used systematically all over a territory: only a selected series of the most exposed and sensitive areas should be studied in detail. The key issue is on the one hand to find quick and effective methods to assess risk at a regional level and, on the other hand, to evaluate the influence of information imperfection on decisions.

In the framework of the PARAMOUNT project, the objective is to propose global and rapid methods to identify hot-spots on a very wide area and then analyse them in detail with specific dedicated methods (Figure 9). Different scales and methods are analysed with a special and innovative focus on the influence of information imperfection (uncertainty, imprecision...) on decision-facilitating methods such as multi-criteria decision methods, numerical modelling etc.



**Figure 9 : Methodology to move from regional to local decisions: first identify 'hot spots' and then proceed to detailed studies on a local scale (J.-M. Tacnet)**



## 2.2 Decisions related to railway infrastructure management

To deal with risks in the context of rail and/or road infrastructures, several strategies exist (Figure 10). They correspond either to active (building protection or defence works against natural hazards) or passive measures such as the development of rescue and alternative paths in case of rail or road closures [Cuny, 2012].

Hazard and risk assesment (e.g. for land-use and control applications)	Decisions for protection (and works) strategy and maintainance	Decisions for (railroad) infrastructures management
<p>St Etienne de Tinée – 2009 (L. Bernard/National Park of Mercantour)</p>	<p>Photo: Cemagref</p> <p>Photo: J.-M. Tacnet – Cemagref</p> <p>Photo: J.-M. Tacnet – Cemagref</p> <p>Which <b>protection</b> is needed ? is it <b>efficient</b> ?</p>	<p>Photo: J.F. Casanova –Dauphiné Libéré</p> <p>Photo: J.-M. Tacnet – Cemagref</p> <p>Le tunnel du Mont-Blanc fermé plusieurs jours</p> <p>Quatre Isérois indemnes par miracle</p> <p>Should we <b>close, re-open, monitor</b> this road ?</p>
<p>Torrent St Antoine – Modane - Savoie – 1987( M. Meunier – Cemagref)</p>		
<p>What are the <b>hazard, risk levels</b> ?</p> <p>J.M. Tacnet / Irstea - ETGR</p>		

Figure 10 : Decisions related to railway protection and management strategies are expected (J.-M. Tacnet)

In case of natural hazards, several decisions can be taken to reduce railway tracks and roads exposure to natural hazards. In some extreme cases, diversion is the only solution. In Figure 11, we can see an example of a railway alternative track designed and built because of the debris flow risk level in Pontamafrey, Savoie, France.

Aerial view of the railway diversion (photo D.R. \*)

Bridge over the torrent on the railway diversion (photo D.R. \*)

The railway diversion (photo L. Joulins \*)

Bridge on the main railway track (risk of closure due to debris flows)

(photo J.-C. Zancanaro, RTM Savoie)

\* in (Cuny, 2012)

The "Ravoire of Pontamafrey" torrent, Pontamafrey-Montpascal, Maurienne Valley, Savoy, France

Figure 11 : Diversion is sometimes used in case of tracks exposed to natural phenomena (J.-M. Tacnet, Irstea)

Therefore, it appears that the decision contexts have to be clearly described in order to be able to contribute to decision support systems: who are the decision-makers? what is the object of the decision?... (see appendix n°1<sup>1</sup>). Our experience in the PARAMOUNT project context has clearly shown that the answers are not obvious and require a deep dialogue with decision-makers. This approach, related to the different steps of the risk management circle, induce several decision problems that can be solved using the available decision-facilitating methods (

Figure 12) .

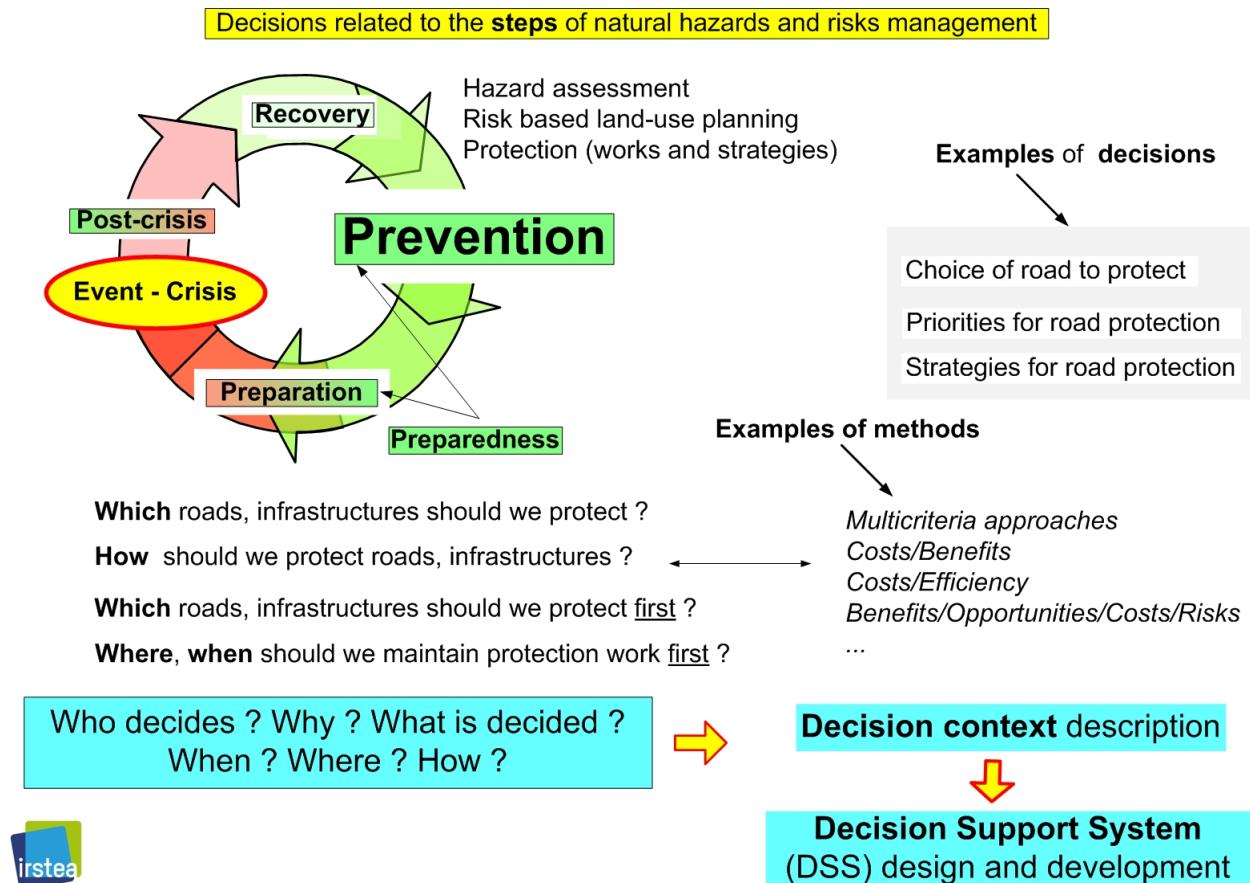


Figure 12 : example of decision identification for road management in a context of prevention (J.-M. Tacnet, Irstea).

In this context, the decision-facilitating process aims to identify the different components of risk in order to evaluate both threats to roads (related to hazard assessment) and consequences corresponding to direct and indirect vulnerability (Figure 13).

<sup>1</sup> see appendix n°1 for examples of questions to ask with a view to planning or optimisation.

Natural hazards-related constraints (threats) and consequences of a road (or railway) network

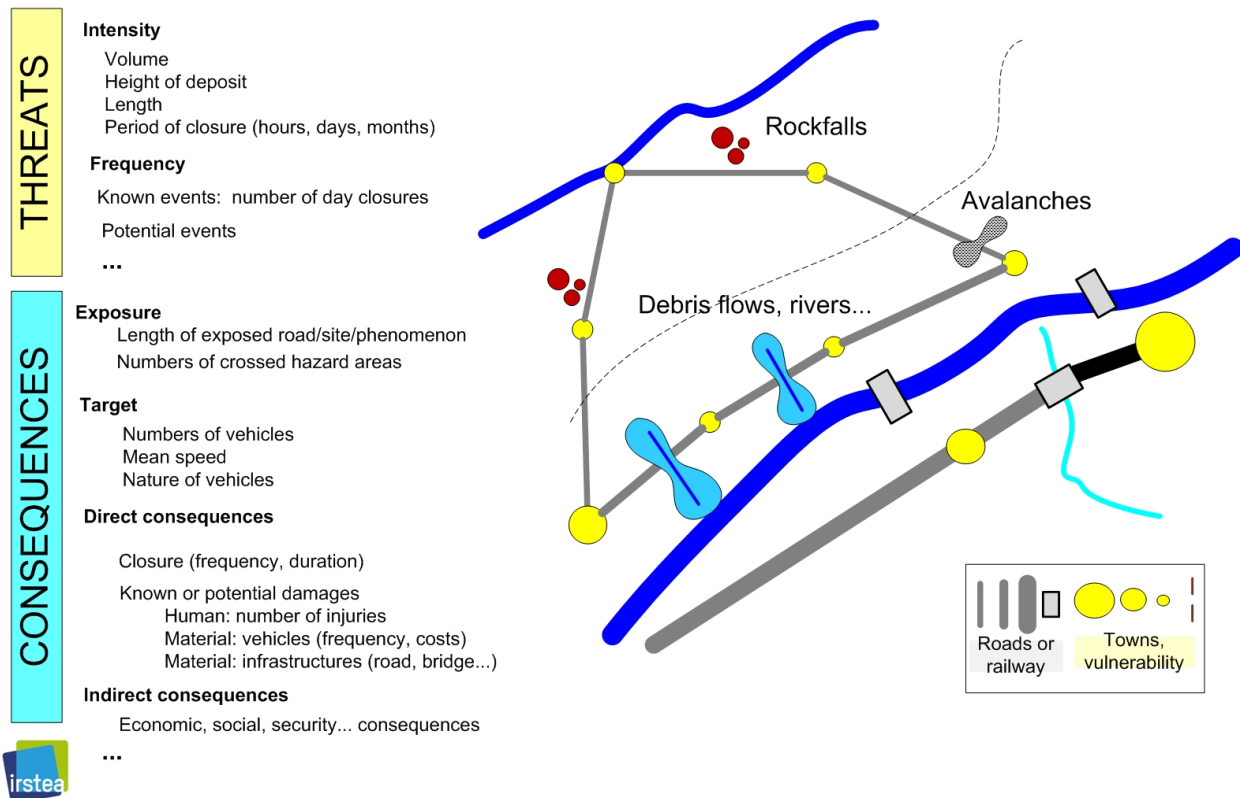


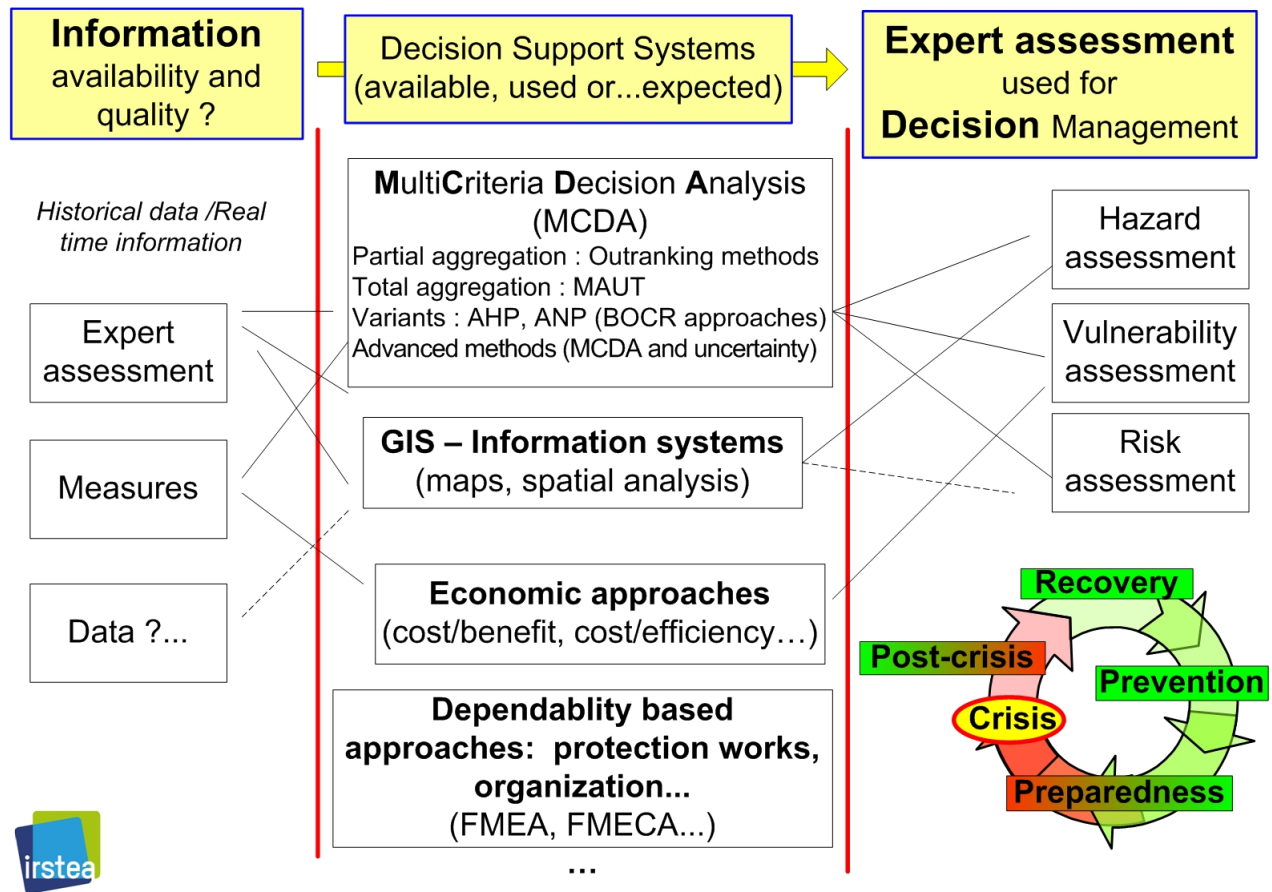
Figure 13 : Risk assessment of roads exposed to natural hazards requires the analysis both of threats (hazard) and of consequences (vulnerability)

### 2.3 Decision-making in the context of natural hazards

#### Available and existing techniques

Several methods are available including multi-criteria decision-making, dependability (reliability and safety analysis), numerical modelling, economic approaches including uncertainty analysis, geographical information systems....(Figure 14). These different methods are more or less effective in the context of roads and railways exposed to natural hazards. None of them systematically outperforms all the others since they all have their own advantages and disadvantages. Economic approaches such as cost-benefit approaches (CBA) are perfect but they rely on strong assumptions about probabilities and monetary estimation of losses which are known to be questionable when dealing with cost of human life, indirect and remote effects of road/railway closure.

At the same time, multi-criteria decision-making methods appear as a promising alternative but are also suffering from lacks and drawbacks: as an example, the elicitation of preferences between criteria is not obvious since no undeniable methodology exists.

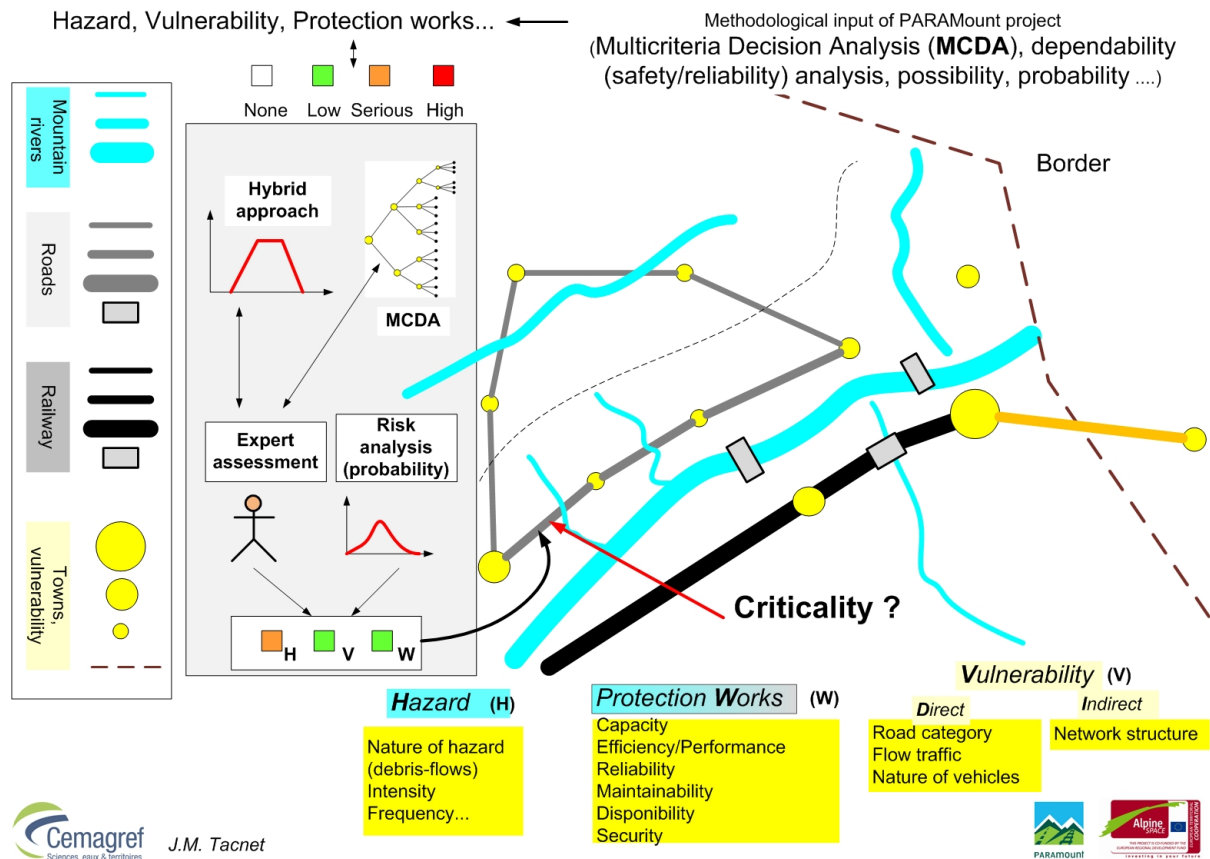


**Figure 14 : Several complementary methods are available and useful to help decision-making in the context of natural risk assessment**

Rather than promoting only one method, developments in the framework of the PARAMount project are based on a combination of several existing techniques related to hazard assessment, protection works effectiveness and also direct and indirect vulnerability assessment (Figure 15).

In the end, our goal is to propose some kind of integrated framework showing that both classical tools such as numerical modelling and new methods should be used in the natural hazards context because of lack of knowledge, information, heterogeneity of sources....





**Figure 15 : an overview of applied methodology (Irstea) in the case of a torrent catchment basin**

The contribution is focused on the development of decision-facilitating methods. The two following sections recall some backgrounds about multi-criteria decision-making methods and needs for information imperfection assessment in the context of natural risks expertise.

## 2.4 Multi-criteria decision analysis backgrounds

This section explains the basic principles of multi-criteria decision-making methods.

### Methodology for multi-criteria DSS building

The global methodology to design decision support systems is always the same. Some differences do exist between models and techniques but the key issues consist in correct modelling of the decision problem, information imperfection assessment and decision support systems validation.

Describing the decision context in close relation with decision-makers is essential but not so common. To model the decision problem, corresponding to strategic regional or local decisions, a

simple 5WH approach is proposed to describe decision context: **What, Why, Who, When, Where, How** is it decided? A generic framework<sup>2</sup> has been proposed in relations with observers of the project<sup>3</sup>.

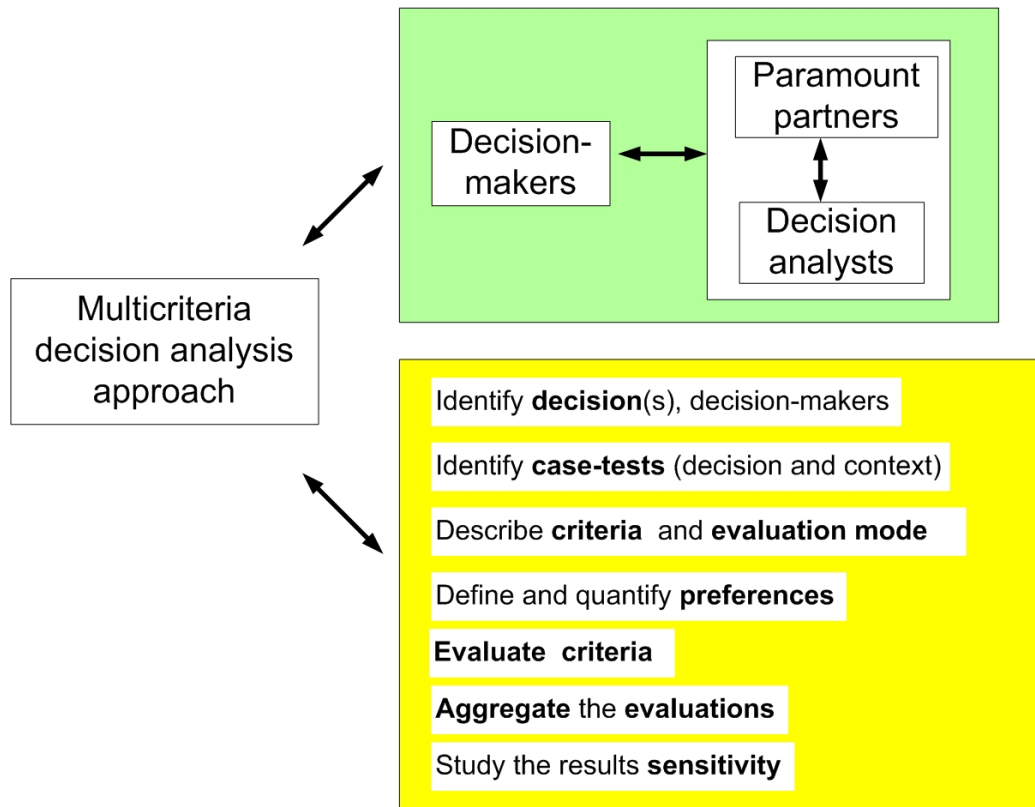


Figure 16 : The global multi-criteria decision analysis framework: essentials steps to design a new decision model

## Classical methods

The main contexts of decision consist in choosing, ranking or sorting (Figure 17) solutions or alternatives according to the decision-maker's preferences. Several methods based either on total (AHP, MAUT...) or partial aggregation (Electre, Promethee....) have been proposed to deal with these problematics (see [Schärlig, 1985], [Dyer, 2005], [Figueira et al., 2005], [Saaty, 1980]... for details). In our context, solutions can be for instance, hazard or risk level on a given section of road, sections of roads (ranked from the less to the most dangerous ones), protection works reliability levels and so on.

<sup>2</sup> Developed by Irstea in the framework of the WP4 of the PARAMOUNT project.

<sup>3</sup> see appendix: 7.1 Discussion guidelines for DSS evaluation: a framework for decision context identification.

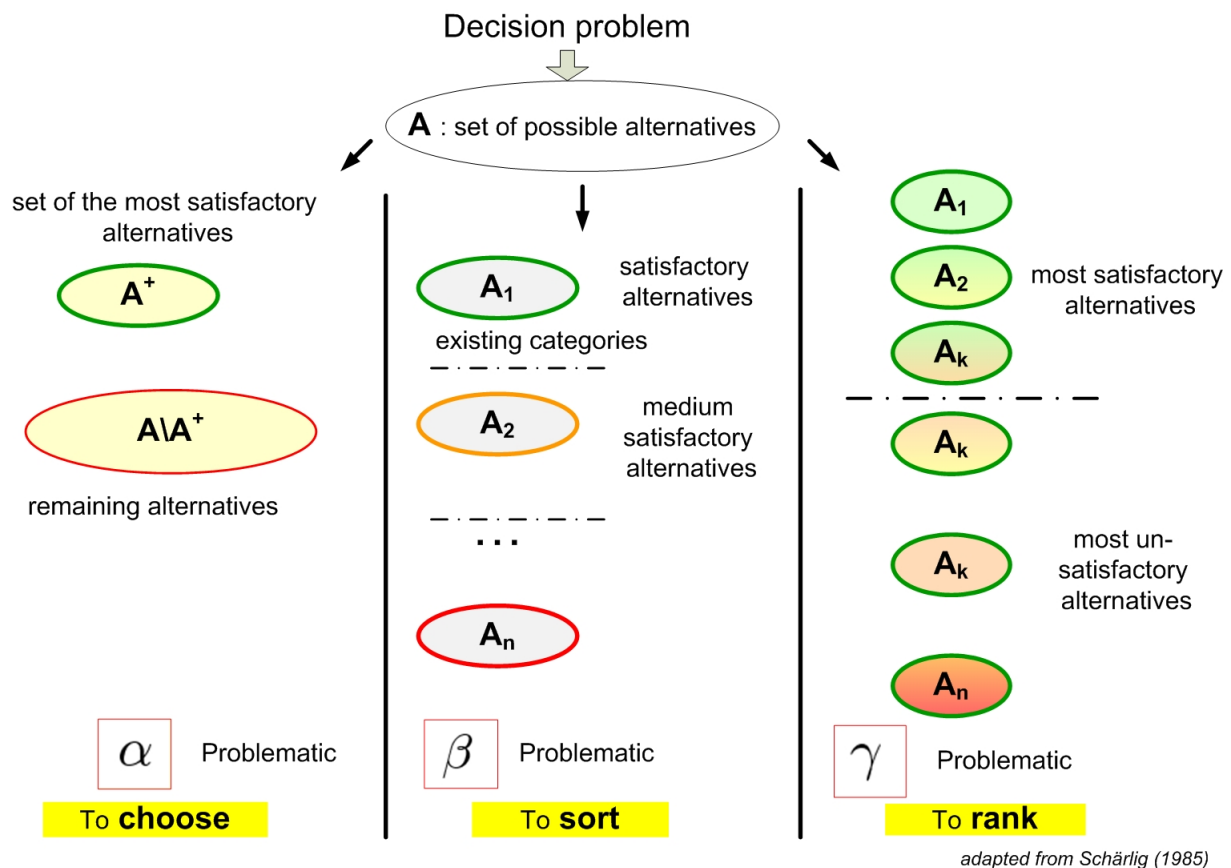


Figure 17 : The different decision problems addressed by multi-criteria decision-making methods [Schärli, 1985]

## Methodology for multi-criteria decision analysis implementation

This section presents the methodology to implement a multi-criteria decision model in practice. To keep it simple and understandable, we choose to illustrate the process with a simple method called AHP (Analytic Hierarchy Process) [Saaty, 1980]. This is of course an example: the method is widely used but has also some well known drawbacks (see [Tacnet, 2009] for details).

### Basics of the AHP method

Multi-criteria decision analysis (MCDA) aims to choose, sort, and rank alternatives and solutions according to predefined criteria in the decision-making process. MCDA consists in identifying decision purposes, defining criteria, determining preferences between criteria, evaluating alternatives and solutions and analysing sensitivity with regard to weights and thresholds (Figure 3).

Complete aggregation methods such as the multi-attribute utility theory (MAUT) [Keeney and Raiffa, 1976] [Dyer, 2005] synthesise in a single value the partial utility related to each criterion chosen by the decision-maker. Each partial utility function transforms any quantitative evaluation of a criterion into a utility value. The additive method is the simplest method to aggregate these utilities (Figure 18).

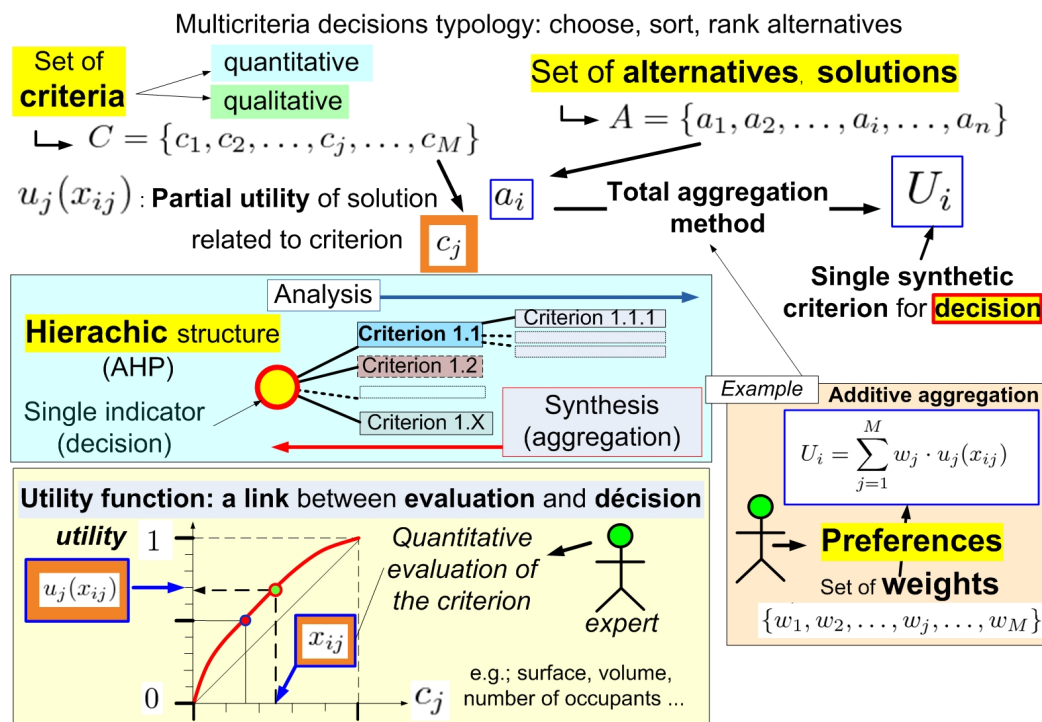


Figure 18 : Multi-criteria decision analysis principles: classical approach based on total aggregation principle

The Analytic Hierarchy Process (AHP) is an easy-to-use multi-criteria decision-making method. Its principle is to arrange the factors considered to be important for a decision in a hierarchic structure descending from an overall goal to criteria, sub-criteria, and finally alternatives at successive levels. It is based on three main steps:

- breaking the problem down into its components, comparative assessments and hierarchic structure or synthesis of priorities;
- evaluation of preferences through pair-wise comparisons using a verbal qualitative scale (Figure 19): weights are derived from a preferences matrix (calculated as the eigenvalues of this matrix);
- evaluation of solutions or alternatives through a simple aggregation process (weighted sum).

The original AHP method is based on a criterion-solution principle. Different alternatives (e.g.  $a_1, a_2, a_3$ ) are compared one to another according to terminal criteria ( $C_{111}$  with weight  $w_{111}$ ,  $C_{112}$  with weight  $w_{112}$ ...) in order to determine the final evaluation of alternatives  $a_1, a_2, a_3$  (Figure 20 -classic AHP). When the number of alternatives increases, it is impossible to compare all the alternatives one with another according to the classical AHP principles. In that case, we use a criterion-estimator-solution framework. The terminal criteria are completed by evaluation classes (e.g.  $C_{1111}$  with weight  $w_{1111}$ ,  $C_{1112}$  with weight  $w_{1112}$ ,  $C_{1113}$  with weight  $w_{1113}$ ). Each alternative  $a_i$  is evaluated according to its belonging to one or another of these evaluation classes (Criteria-Estimator-Solution variant - Figure 20).



### Building a hierarchic MCDA model : principles

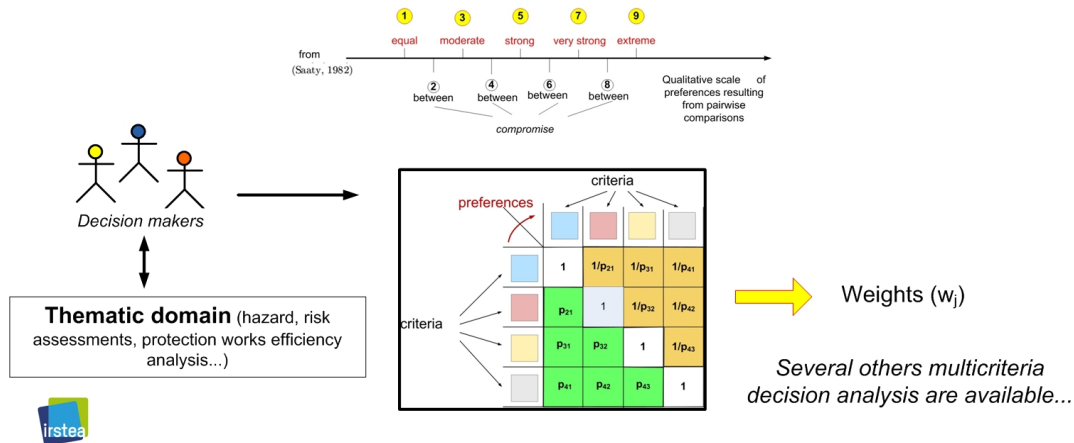


Figure 19 : From decision context to multi-criteria analysis and models: elicitation of preferences between criteria

### Building a hierarchic MCDA model : principles

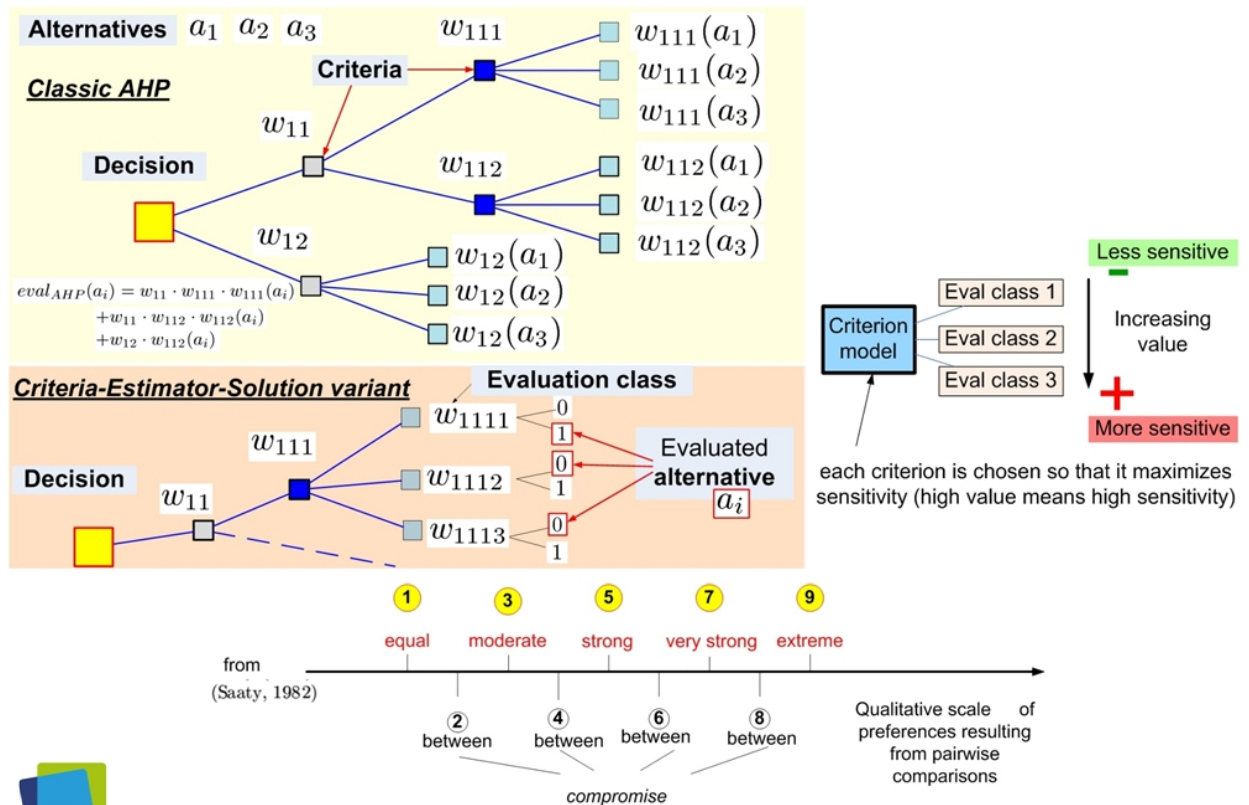


Figure 20 : Decision problem analysis : principles of a hierarchic breakdown into criteria in the AHP [Saaty, 1980] context

It must be noted that, as a single synthesising criterion-based approach, the analytic hierarchy process (AHP) [Saaty, 1980] is a special case of a complete aggregation method based on an additive preference aggregation. These methods cannot natively consider the imperfection of criteria evaluations or multiple and possibly conflicting evaluations: this is the reason why advanced methods have been developed to consider this information imperfection (see following sections).

## Examples of implementation

A simplified version of an existing method, developed to assess the sensitivity of a avalanche site [Rapin et al., 2006], is used to show how multi-criteria decision analysis principles and information fusion can be used to characterise and take information quality or imperfection into account for decision-making purposes (Figure 21). The principle is to evaluate the sensitivity of an avalanche site according to the main criteria denoted as hazard (morphology, history, and snow climatology) and vulnerability (permanent winter occupants, dwellings, and infrastructures).

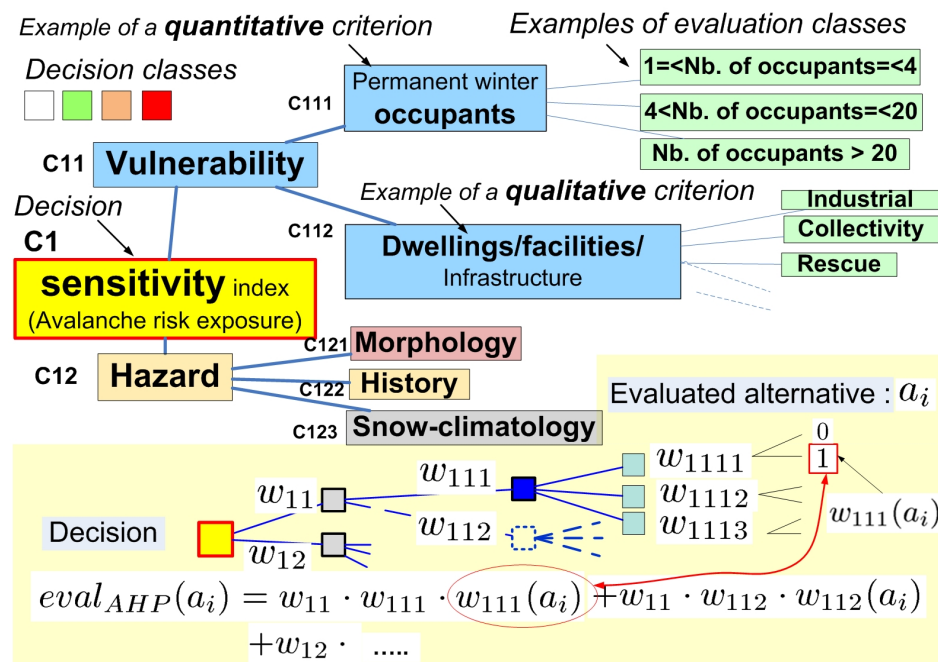


Figure 21: Simplified decision-making problem related to a avalanche sensitivity index [Tacnet et al., 2010b]

The first step consists in describing the decision-making problem including identifying qualitative and quantitative decision criteria and assessing the dimensions of the event. The decision hypotheses (e.g., a site's sensitivity levels) are used to define the common frame of discernment that will be used for information fusion: low, medium, and high sensitivity. This example will be used in further sections to illustrate the development of advanced multi-criteria methods.

In the context of roads, the vulnerability can be decomposed into direct vulnerability related to users and infrastructures and indirect vulnerability related to transport and connectivity function.

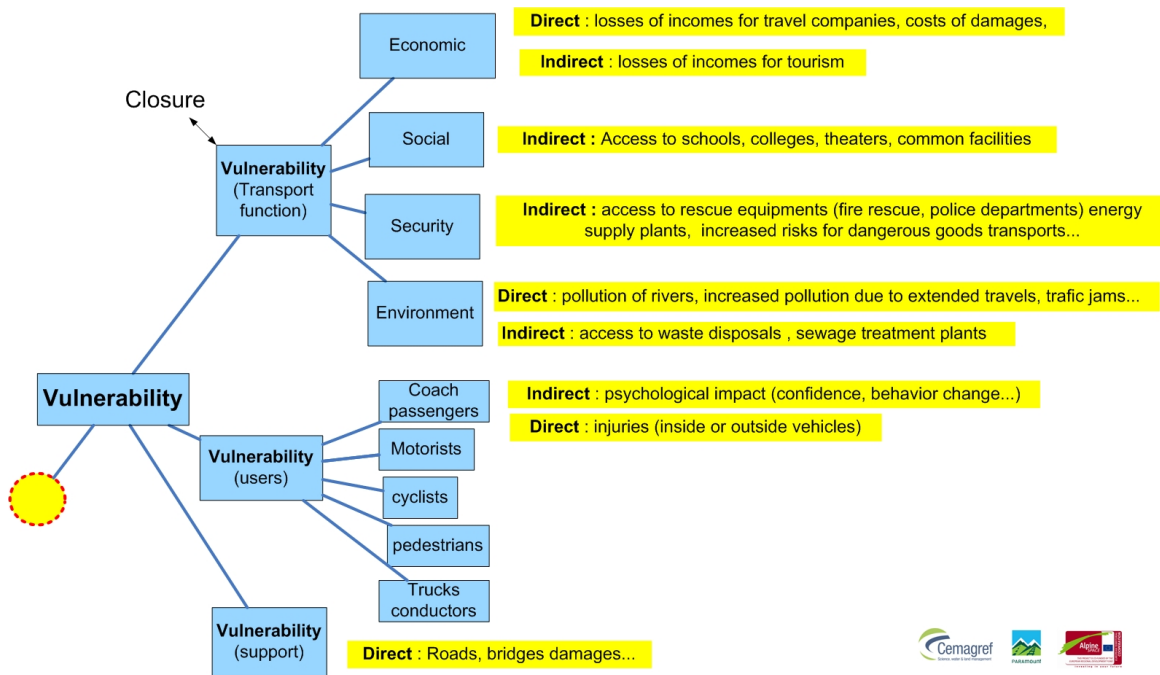


Figure 22: Example of a hierarchical breakdown into sub-criteria of road vulnerability (J.-M. Tacnet)

In practical terms, decision-makers are only asked to provide preferences (or levels of importance in the decision process) about criteria using the qualitative Saaty's scale (Figure 20). These preferences (e.g. different classes of length of exposed roads) are then transformed into a vector of weights (Figure 23) using automated software applications.

### Building a MCDM model: from preferences to weights

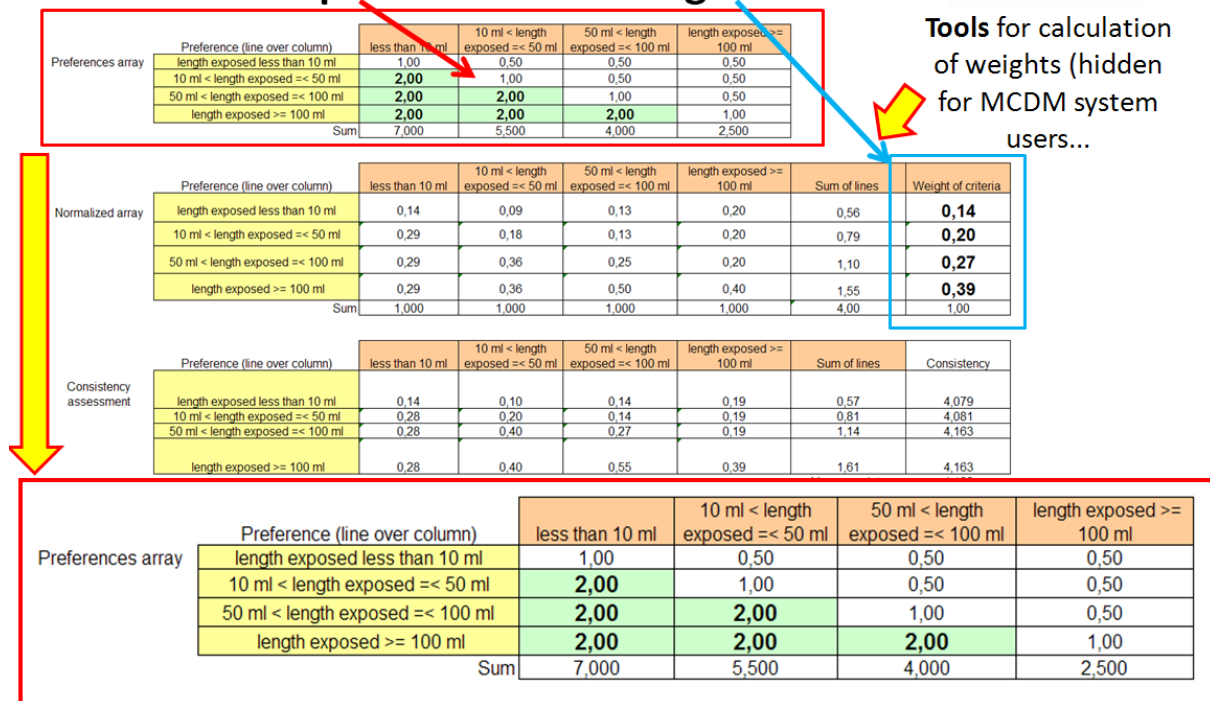
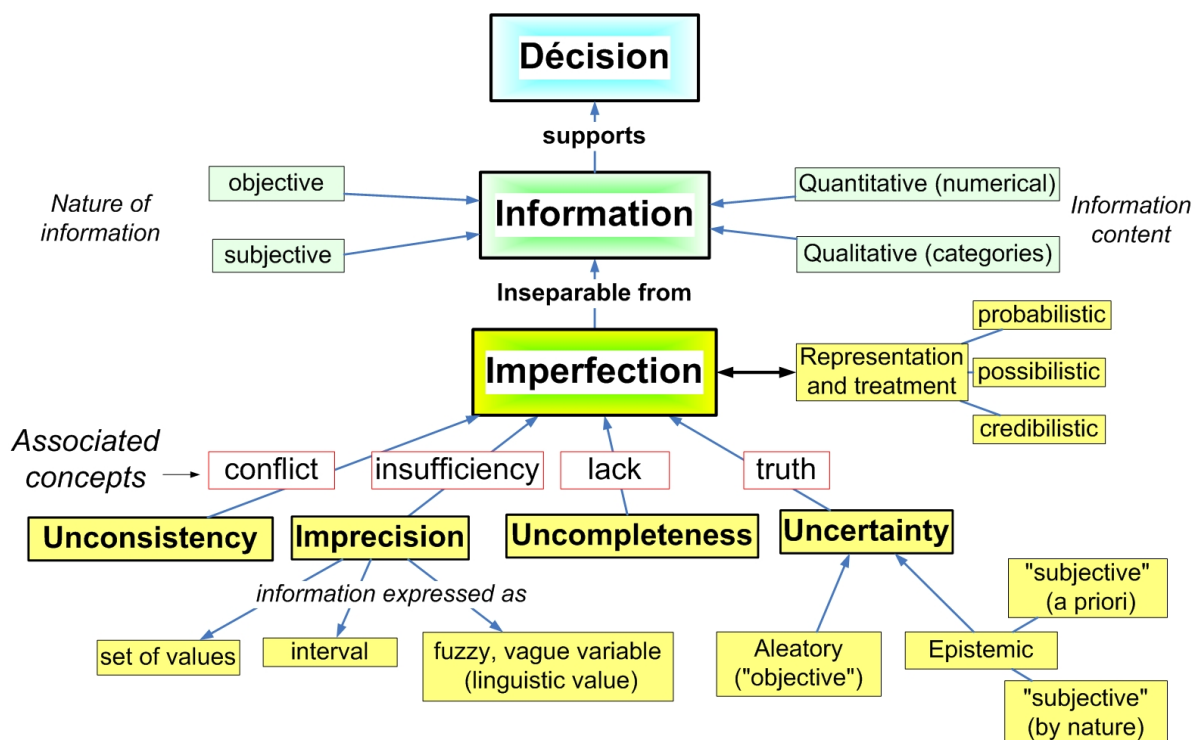


Figure 23: example of the transformation of a preference matrix into a vector of weights (J.-M. Tacnet)

## 2.5 From information management to decision-making

The analysis of relations existing between information quality and decision is an essential and innovative feature of new decision-facilitating methods. This principle is implemented both through development of multi-criteria decision systems and uncertainty analysis of numerical modelling tools. This section introduces the concepts related to information imperfection and their influence in the expert assessment processes.

Indeed, a decision is always closely related to information quality. Uncertainty, as often used in common language, is indeed only one of all the various types of information imperfection, along with inconsistency, imprecision, incompleteness and uncertainty (Figure 24). A key issue consists therefore in linking decision methods and the quality of available information: which method is adapted to which problem for which scale? This question motivates the multi-scale approach developed in the context of the PARAMOUNT project and also the development of specific databases and information systems.



Source (Tacnet, 2009) adapted from Smets, Dubois, Bosc, Bonissone, Tong...

Figure 24: Different kinds of information imperfection [Tacnet, 2009]

Owing to restricted data availability or imperfect survey conditions, the quality of the data used in decision-making is not always as complete, precise, and certain as expected in ideal conditions. In the end, risk management decisions depend on the primary data and information available as well as on the reliability of data sources, including experts (Figure 25).

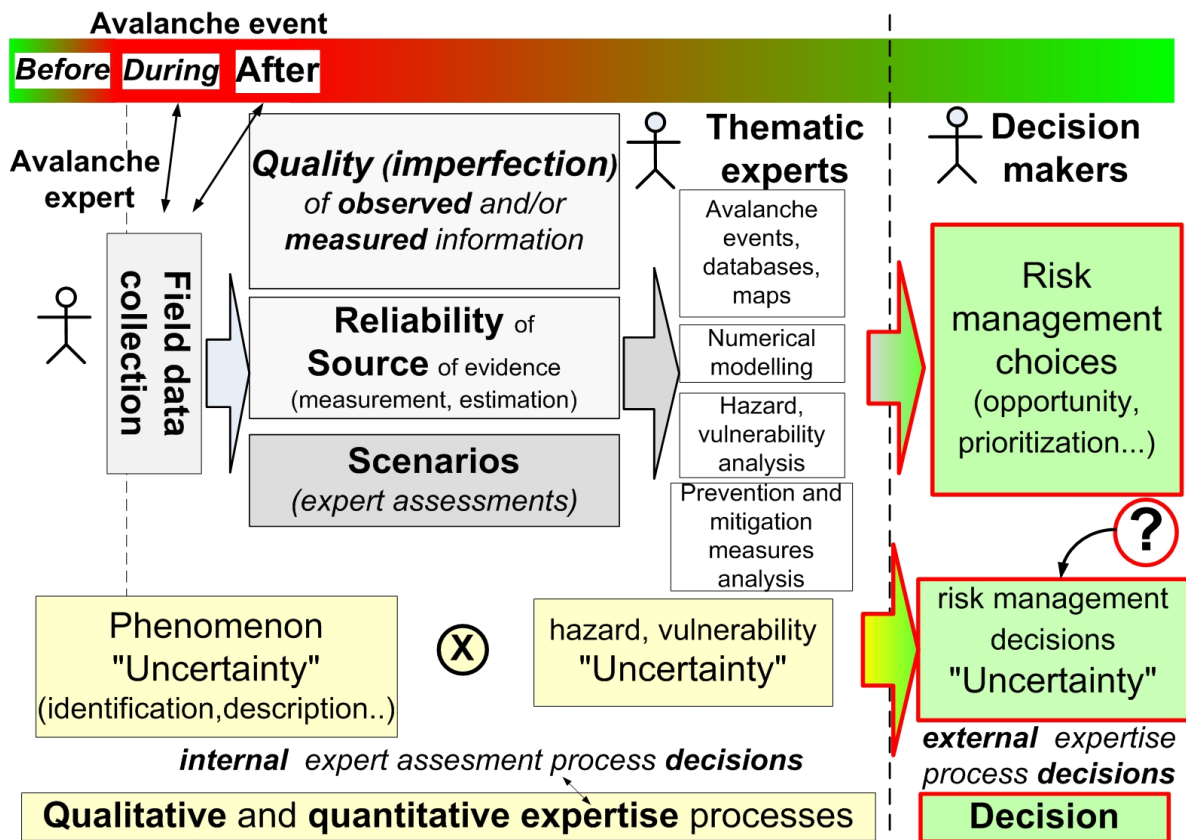


Figure 25: Expert assessment process and information imperfection propagation [Tacnet, 2009]

## 2.6 Conclusion: specific developments and applications

This report presents some key developments effected in the context of the Paramount project in relation to the development of decision support systems. The report describes the contribution from project partners who have provided tools and methods related to hazard assessment, direct and/or indirect vulnerability assessment, risk assessment and the assessment of protection works' effectiveness etc. Some of these contributions are quite classical and correspond to the implementation of existing methods and tools such as numerical the modelling of debris flows, rockfalls or avalanches. Others are more original and innovative.

These contributions are therefore about several key issues related to decision-making including:

- Description of decision context and risk dialogue improvement;



- Indirect vulnerability assessment based both on classical network analysis combined with a geographic information system (G.I.S) and/or innovative methodology including thematic attractiveness indexes assessment;
- Advanced methods for decision-facilitating:
  - Evaluation of indexes about sensitivity, importance, hazard and/or risk levels using advanced multicriteria methods in relation to information imperfection ;
  - Information fusion to gather different spatial imperfect information provided by more or less reliable sources;
  - Uncertainty assessment in numerical modelling of natural phenomena (such as debris flows);
- Regional decision-facilitating tools:
  - Regional debris flow susceptibility map;
  - Quick and easy-to-use tool for the assessment of regional avalanches, rockfalls, and the protective role of forest;
  - Regional use of numerical modelling for hazard assessment of railway tracks and roads.
- Assessment of protection works' effectiveness:
  - An approach based on dependability (safety and reliability);
  - Databases dedicated to protection works against rockfalls and the mechanical analysis of existing, poorly technically documented rockfalls barriers' behaviour.

## 3 Development of methodologies for decision context description

Description of decision contexts and dialogue with decision-makers is an essential part of the design of decision support systems. The following sections present 1) a communication tool developed to initiate discussions and exchanges between experts in relation to climate change and 2) the result of a risk dialogue process to identify deficiencies in risk management procedures in a local test bed.

The reader can also consult the appendix which presents a methodological framework to initiate decision process description in the context of railway infrastructures exposed to natural hazards.

### 3.1 Strategic level: a simple communication and strategic decision support tool for natural hazard management (CDT)

*This section has been written and verified by Karl Hagen, Peter Andrecs, Marc S. Adams, Karl Kleemayr (Department of Natural Hazards, Federal Research and Training Centre for Forests, Natural Hazards and Landscape (BFW), Innsbruck-Vienna, Austria).*

#### Introduction

Since the start of the public debate concerning climate change and its assumed effects, the interest of society in natural hazard management has increased. At the same time the demand for protection against these hazards, also in a changing climate, is evident. However, awareness and understanding of how to minimise risks resulting from natural hazards are increasingly lost with the urban life style (NBZ 2009, Moser 2004). Hence, the need of public support to detect hazards and to make existing knowledge available to decision-makers, as well as to the public, is high. Besides the legally authorised planners and natural hazard managers, people who are living, working or are performing recreational activities in areas affected by natural hazards, as well as those who represent the interests of affected institutions, nowadays ask to be involved in the hazard management process (e.g. compiling or adapting hazard maps). This may range from being informed to being actively involved in the decision processes. Usually not all groups involved in the decision process are familiar with natural hazard assessment or the assessment methods may be different across user groups. Hence, new and enhanced methods to ‘translate’ and harmonise the knowledge of experts is required to support the decision-making within the context of natural hazard management to improve the understanding and the acceptance of sometimes necessary but unpopular measures like restricted land use as indicated in hazard maps or required in-depth investigations, which may cause higher costs and delays.

#### Objectives and use of CDT

The overall aim of the CDT (Communication and Strategic Decision Support Tool) is to support the structured and factual discussion on climate change and its effects on natural hazards on a regional scale. In PARAMount the focus of interest lies on the infrastructure network, which is endangered by natural hazards, especially in the Alpine region. Natural hazard processes are complex and depend on multiple influencing factors in variable cause and effect systems. Therefore natural hazard assessments are difficult to understand and decisions are often not comprehensible for ‘non-experts’. In addition, experts from different research disciplines sometimes have problems understanding each other, because the technical terminology may vary between e.g. geologists and

meteorologists. The CDT developed offers a pragmatic, transparent, traceable and flexible assessment scheme, to display natural hazard processes in mountainous regions in a comprehensible way. It should facilitate understanding of the system of cause and effect in general terms, as well as in terms of climate change and its assumed effects. The application of the CDT has several objectives:

- Strategic decision support: addressing aspects of regional spatial planning, including the assessment of likely effects caused by changing frame-conditions (e.g. climatic conditions) to identify current and future potential 'hazard hot spots'.
- Communication support: addressing aspects of spatial planning on a national, regional or local scale, by establishing a communication platform as a basis and guide for structured discussions (communication) and information on management decisions, including protective measures for stakeholders and the public.

Educational support: providing decision-makers, stakeholders and experts from different backgrounds, involved in natural hazard management or working in endangered areas, relevant knowledge to mediate a basic understanding of cause and effect and the subsequent impacts on e.g. decision-making.

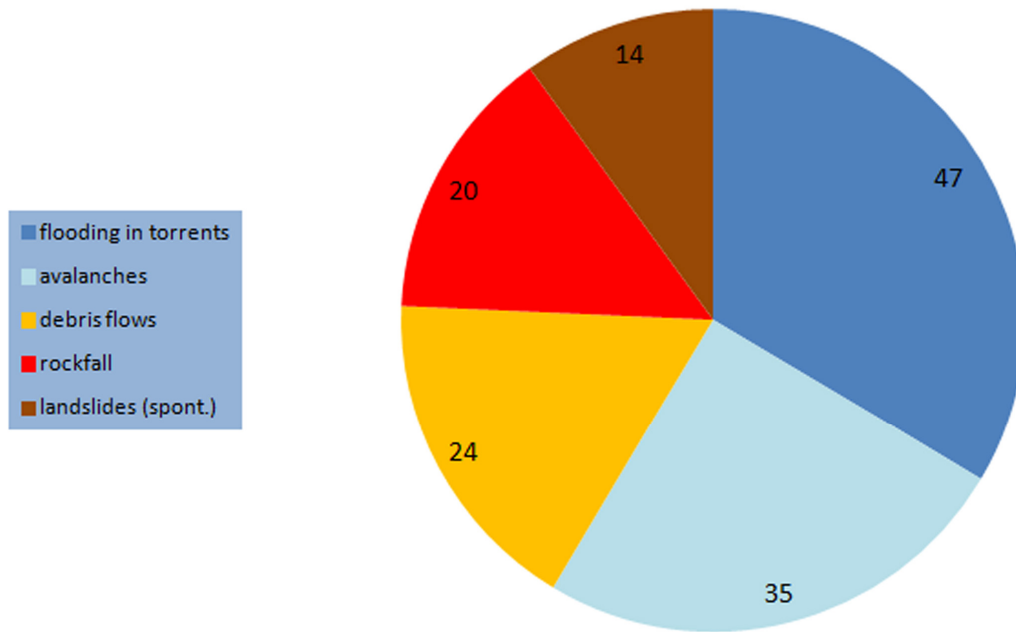
## **Methodology**

The CDT is based on the results of an expert assessment of the relevance of process parameters for each hazard process type. The idea behind this methodology is that the change of important process parameters will affect the process significantly, whereas changes of less important process parameters will most probably not show any significant effects. Thus the most important parameters have to be identified by being able to assess alerted hazard situations. This knowledge has great implications on long and short term decisions. The detailed description of the method of weighting the parameters and the results of the online survey, which was conducted in the scope of PARAMOUNT, are provided in Andrecs and Hagen (2011 a and b), Andrecs and Hagen (2012) and Hagen et al. (2012a and b).

The results of this online survey were weighted parameters on the basis of expert knowledge, for the following process types:

- Flooding in torrents
- Debris flows
- (Spontaneous) landslides in loose material
- Rockfall
- Avalanches

The significance of the results and therefore their reliability in practical decision processes depends on the number of answers (Figure 26) and the spread of the weightings.

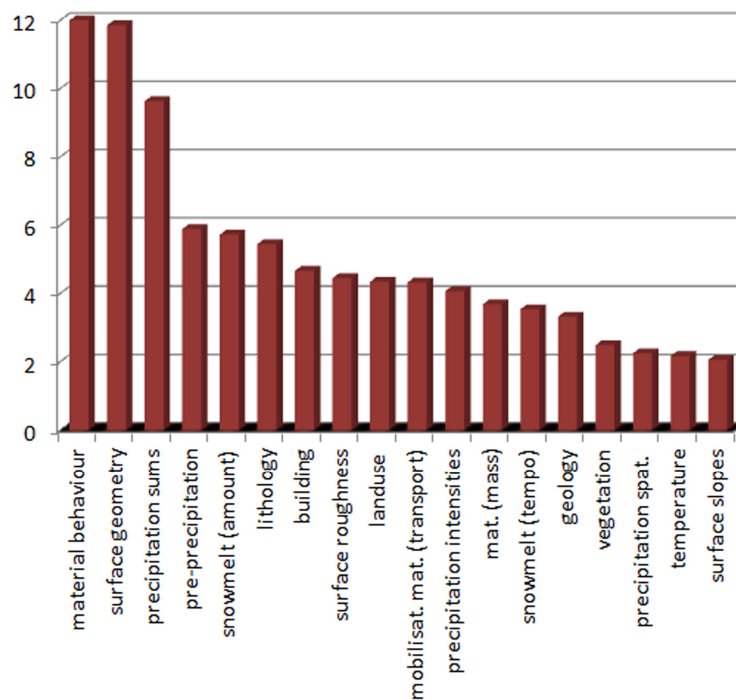


**Figure 26: Number of responses by rated processes – PARAMount CDT online expert survey 2012.**

Since the spread of the answers varies within the parameter ratings, this quality criterion can only be determined for the single ratings. However, the average of the standard deviation for each process type can give a good impression of the investigated process types (level of significance 10%):

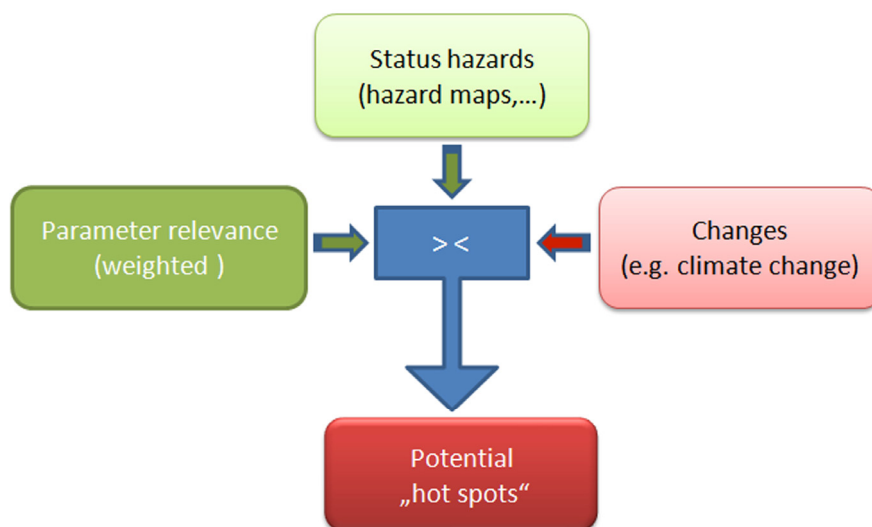
- flooding in torrents: 1.8
- avalanches: 1.8
- debris flow :2.6
- landslides, rockfall: >3.0

The values for the parameters of the listed natural hazard processes, including their standard deviation are provided in Hagen et al. (2012b). The ratings for flooding in torrents, avalanches and debris flows are reliable, while for the process types landslides and rockfall, the results can only be used conditionally (example in Figure 27 and Andrecs and Hagen 2011b), because of the high standard deviation. However, from a functional point of view, all results seem to be reasonable and therefore adequate to describe the situation in the Alpine region. The estimation of the parameter relevance is the starting point for further practical and structured discussions on climate change effects.



**Figure 27: Selection of the highest weightings of influencing parameters for landslides, according to the online expert survey. The results can be used only conditionally, because of the high standard deviation resulting from the low number of responses (expert online survey).**

For the regional strategic assessment of the effects of climate change on natural hazard processes, the weighted parameters need to be merged (Figure 28) with the information on the actual hazard situation (effective hazard maps, disposition analysis, etc.) and the expected future development of (relevant) process parameters (e.g. amount of precipitation). In the landslide example (increasing precipitation totals being assumed) landslide disposition maps (landslide susceptibility maps – hazard status), including the uncertainty of the estimation, are needed to determine spatially referenced hot spots. However, such regional analyses on a coarse database can only indicate potential hot spots and these need to be intensively verified for local use. In case of inadequate information on the hazard status, the information gained can only be of a general nature.



**Figure 28: Weighted parameters are merged with information on the status of hazards and the further development of relevant parameters to indicate potential 'hot spots'.**



## **Development**

The CDT was introduced, discussed and developed:

- within the Alpine Space project AdaptAlp (Andrecs et al., 2010),
- within the Alpine Space project CLISP (Zeidler et al., 2011) with a focus on spatial planning
- and in PARAMount, inter alia at the second regional risk dialogue group in the PARAMount Stanzer Valley test bed, here with a focus on the possibility of implementation in the region.

The CDT was applied in the communities of Gasen and Haslau (SE Austria) during a workshop on catastrophic landslide-events that caused considerable damages in 2005. The aim of the workshop was to ‘understand’ the 2005 event and to identify the need for further (spatial) planning measures to reduce the risk of landslides, considering also projected future climatic conditions. Further aims included an evaluation of the CDT, regarding its opportunities, benefits and limitations, thus leading to improvements in the further development of the CDT. The implementation in the test area is described in Hagen et al. (2012b) and Hagen et al. (2012c). Some exemplary conclusions, which scientists, decision-makers and representatives of the communities drew, using the CDT are:

- The projected temperature rise (due to climate change) will not affect the landslide processes in the region.
- A rise in the precipitation totals (due to climate change) will affect the landslide processes in the area; however, the effects will be rather moderate in comparison to flooding.
- The most challenging task for the future is not the ability to deal with climate change effects, but the need for more effective and efficient planning and realisation of constructions (e.g. roads).

Generally, the introduction and implementation of the CDT showed that the method itself was predominantly accepted by the participants. The communication possibilities in particular, were credited by the experts as being a practical support for their daily work. Considerable uncertainties arose concerning concrete implementation in the decision processes and on how to deal with the results of the CDT analysis, because handling changing conditions in spatial planning and natural hazard prevention is an unsolved problem per se.

## **Application steps of CDT**

One of the aims of the CDT was the application of the tool in other regions, thus gathering further feedback from the stakeholders regarding the tool itself and the practical usefulness of the results. To allow a successful application of the CDT tool, some basic considerations should be made.

### **Audience and aims**

Before using the CDT, some facts about the audience should be known:

- What are the functions of the participants in the decision process?
- What are their aims and interests?
- Which natural hazard-specific knowledge can be expected?

The aim of the application in a new community or region should also be defined clearly. There are three main-types of motivations for application of the tool, which may overlap in practice:

- Strategic decision-making (communication between experts and decision-makers)
- Local decision communication and participation (communicating decisions, by including the experts, decision-makers and stakeholders).

- Education (communication of expertise and showing the necessity of measures) for the public and political stakeholders.

The CDT can be applied by different user groups involved in natural-hazard-affected spatial decision processes. Users can be scientists and practitioners in the field of natural hazard management and spatial planning, as well as various decision-makers, including major ones, regional administration and infrastructure operators (road or rail management and operation).

## Implementation

First an explanation of the CDT should be given, highlighting how the approach works and what results can be expected. It is helpful to present specific case studies to demonstrate the benefit of the approach for the different user groups. For instance, concrete steps are explained using the example of the implementation of CDT in Gasen (SE Styria, Tilch et al 2011, Zeidler et al 2011, Andrecs et al 2007), with regard to landslides and spatial planning. *These text parts are in italics.*

- Identification of relevant processes: process types, which are relevant to the area and should be discussed, have to be determined beforehand. For strategic decisions, the spatial process and hazard situation have to be analysed. The available spatial information (e.g. hazard indicator maps, hazard maps) need to be validated with reference to their completeness and the inherent uncertainties. *Because of a new susceptibility map and a hazard (indicator) map for landslides, only this process type was discussed, although there are other relevant natural hazard processes in the area.*
- Parameter assessment and regionalisation: the results of the general parameter assessment for the process types need to be discussed and adapted to regional characteristics. Therefore relevant information in the area has to be collected and analysed beforehand. *In the test-region of Gasen/Haslau these were e. g.:*
  - *Documentation of events (2005 events and eye-witness reports indicated a strong influence of constructions (such as roads) on landslide activity, Andrecs et al. (2007))*
  - *Relevant studies on the natural hazard processes under consideration (e.g. for Gasen/Haslau the AdaptSlide report of the AdaptAlp project (Tilch et al., 2011) showed a strong influence of forests on landslide activity in the area)*

It turned out that the assessment of the process parameters and the determination of the relevance (regionalisation) should only be done by experts. The terminology is known to experts and the analysis of parameters is feasible. For non-expert groups describing complex natural hazards by relevant factors and parameters is difficult. It cannot be presumed that the terminology used will be clear (e.g. land use had to be explained). Furthermore lay persons are not able to assess and evaluate single process parameters.

However, the adaptation of the general parameter-rating to regional characteristics was defined and explained in a manageable way.

*Based on the experiences of the 2005 event, the parameter formation was rated by the experts as being approximately as important as the material behaviour or precipitation totals. The modification of the general weightings (Figure 27) was calculated by event analyses (Andrecs et al. 2007), which showed that about 2/3 of the andslides occurring were triggered in close vicinity to roads. This modification was comprehensible for all participants.*

- Decision and communication process: since the aims of the CDT vary from one user group to another, the way to apply the CDT also differs. As an example, while for municipalities the implementation of planning instruments is most important, strategic decision support is more relevant on higher administrative levels. CDT offers a starting point and structure for a

rational, ongoing discussion as well as a joint communication base. Merging selected future scenarios (climate change, land use etc.) with the parameter evaluation and spatial information (hazard maps, Figure 28) will lead to the identification of areas where the hazard situation is likely to change.

*In the example, beside the assessment of the effects of climate change in the region, the question was explored of how to deal with the information obtained, in particularly with regard to susceptibility maps. Thus, also information on the hazard status (hazard maps, susceptibility maps, Tilch et al. 2011) and the further development of climatic parameters was needed (Figure 28, e.g. study regarding the development of the regional climate conditions (climate change described by Schöner et al. 2011)). The study shows a very likely temperature rise in the region. Anyhow, as the temperature parameter only has a low relevance (Figure 27) for landslide processes, no direct effects are expected, therefore no measures are necessary. For a scenario considering increasing precipitation totals (the regional development of extensive precipitation could not be predicted so far) the effects on the process (increasing landslide activity) will be significant, which is indicated by the high relevance of this parameter. While this general result was commonly accepted, there was no general agreement on the influence of the hazard maps (are the changes within the frame of uncertainties of the maps or not) or on how to deal with this information on a local planning level.*

- As the example showed, the possibilities of the CDT to directly assess changes of the hazard situation as a direct consequence of climate change are limited due to the following facts:
  - Area-wide information on natural hazards is usually not available.
  - Uncertainties in existing maps are usually not estimated and displayed: probably they are higher than the effects of climate change (especially for debris flow, landslides and rockfall).
  - Future development of the relevant precipitation (extreme precipitation) parameter is not predictable, so that only scenarios can be discussed.
  - Simplified information regarding the relevance of the parameters.
  - The approach does not support decisions on how to deal with the results (measures).

It is not the aim to compile maps displaying increasing or decreasing hazards for the future on the basis of the CDT, but it may indicate the need for (strategic) actions in general. Regarding the **communication support**, it is important to prepare the assessment process in advance, so that the needs of the specific user groups can be addressed. The CDT can be effective on all administrative levels. The aim is not to discuss the weighting of parameters or the regional adaptation, but to make the assessments and the decision-process traceable for laypersons. Usually both, the method and the results, were well accepted. Disputes started on how to deal with the insights obtained. Handling changing conditions in spatial planning and natural hazard prevention is an unsolved problem, therefore administrable approaches and solutions need to be developed; however this lies beyond the scope of the CDT.

For **educational support** it seems to be appropriate to primarily focus on (interactive) examples to explain the cause-effect matrix in a traceable manner.

## **Conclusions**

With the support of the CDT it is possible to display existing knowledge of complex natural hazard processes in a simple and traceable way. The relevance of process parameters is based on an expert online survey. A first overview of the relevance of the single parameters is given in Hagen et al.

(2012b). This information is the starting point for the adaptation of the values to regional characteristics. It is suggested, that this step should be carried out by experts, because subject-specific knowledge in the field of natural hazard assessment is indispensable. However, this way to explain complex natural hazard processes in a relatively simple and traceable way is the main strength of the approach.

To estimate the impact of climate change on natural hazard processes or to get a preliminary idea of what may happen if selected parameters change (scenarios), climate change information can be merged with the parameter information. It is obvious that only changes of process-relevant parameters will affect the process and its inherent hazards. This gives support for a factual discussion of the highly emotional issue of climate change impact. Trends of increasing or decreasing hazards can be explained in a comprehensive and transparent way to non-experts using a common language shared by stakeholder, expert and decision-maker groups.

However, the regionalisation-approach requires basic expert knowledge of natural hazard processes. To keep things simple, the CDT approach does not consider the interactions between parameters. The target groups for the implementation of the tool are not clearly identifiable and may vary. Hence there are uncertainties during the implementation phase of the approach. Especially the goals and limits of the CDT need to be communicated clearly, since the results are not maps or action plans, which can be implemented by the administration.

## Publications and presentations in the frame of PARAMOUNT

Andrecs P. & Hagen K. (2011a). Experten bewerteten die Einflussgrößen von Naturgefahrenprozessen, <http://bfw.ac.at/rz/bfwcms.web?dok=8955>.

Andrecs P. & Hagen K. (2011b): Ergebnisse der Expertenbefragung des BFW im Rahmen des Alpinespace Projektes PARAMOUNT, [http://bfw.ac.at/050/pdf/paramount\\_expertenbefragung\\_111122\\_dt.pdf](http://bfw.ac.at/050/pdf/paramount_expertenbefragung_111122_dt.pdf).

Andrecs P., Hagen K. (2012). Methodik zur Bewertung von Naturgefahrenprozessen, in Wildbach- und Lawinenverbau, Heft 169, pp 102-112.

Hagen, K., Andrecs, P. & Adams, M.S. (2012a): Arbeitshilfe für Kommunikation und strategische Entscheidungen im Bereich von Naturgefahren (CDT), 12th Congress INTERPRAEVENT Grenoble, Conference proceedings Vol. p 945-958.

Hagen, K., Andrecs, P. & Adams M.S. (2012b): A simple communication and strategic decision support tool for natural hazard management (CDT). Deliverable in WP 7 (Act. 7.2) within the ASP project PARAMOUNT.

Hagen, K., Andrecs, P. & Schmid, F. (accepted, 2012c): Erste Erfahrungen mit dem CDT (Communication and Decision Support Tool), Zeitschrift für Wildbach-, und Lawinenverbau, probable Heft Nr. 170, 2012.

## References

Andrecs, P., Hagen, K., Lang, E., Stary, U., Gartner, K., Herzberger, E., Riedel, F. & Haiden, T. (2007): Dokumentation und Analyse der Schadensereignisse 2005 in den Gemeinden Gasen und Haslau (Steiermark). BFW-Dokumentation; Schriftenreihe des Bundesforschungs- und Ausbildungszentrums für Wald, Naturgefahren und Landschaft, Wien, Nr. 6.

Andrecs P., Hagen K., Fromm R., Gauer P., Höller P., Klebinder K., Kohl B., Lang E., Markart G., Perzl F., Stary U., Zeidler A. (2010). AdaptEvent. Analyse der Sicherheit und Genauigkeit von Bemessungswerten bei gravitativen alpinen Naturgefahren und Ableitung von Anpassungsstrategien an den Klimawandel, BFW, <http://bfw.ac.at/rz/bfwcms.web?dok=829>.

NBZ (2009): Österreichs Städte in Zahlen (2009). Neue Bewegung für die Zukunft [www.nbz-online.at/index.php?option=com\\_content&task=view&id=234&Itemid=67](http://www.nbz-online.at/index.php?option=com_content&task=view&id=234&Itemid=67) (accessed: 19. September 2012).

Moser, C. (2004): Skizzen einer geistigen Urbanisierung. Österreichisches Jahrbuch für Politik 2004, Oldenbourg, S 547-560.

Schöner, W., Böhm, R. & Haslinger, K. (2011): Klimaänderung in Österreich – hydrologisch relevante Klimaelemente. Österreichische Wasser- und Abfallwirtschaft 1-2/2011, p. 11-20, Springer-Verlag.

Tilch, N., Hagen, K., Proske, H. Pistotnik, G., Schwarz, L., Aust, G., Fromm, R., Herzberger E., Klebinder, K., Perzl, F., Bauer, C., Kronberger, B., Kleb, U., Granica, K. & Haiden, T. (2011): Modelling of Landslide Susceptibility and affected areas – process-specific validation of databases, methods and results for the communities of Gasen and Haslau, (AdaptSlide – Endreport), <http://bfw.ac.at/rz/bfwcms.web?dok=8935> (accessed: 19. September 2012).

Zeidler, A. (2011): CLISP - Climate Change Adaptation by Spatial Planning in the Alpine Space, WP 6 Risk Governance & Risk Communication - SYNTHESIS REPORT; [www.clisp.eu/content/sites/default/files/WP6%20Synthesis\\_Report\\_Final\\_0.pdf](http://www.clisp.eu/content/sites/default/files/WP6%20Synthesis_Report_Final_0.pdf) (accessed: 19. September 2012).

### **3.2 Regional Risk Dialogue (RRD) in Austria (Stanzer Valley): framework, results and lessons learned**

*This section has been written and verified by Marc S. Adams and Antonia Zeidler (Department of Natural Hazards, Federal Research and Training Centre for Forests, Natural Hazards and Landscape (BFW), Innsbruck-Vienna, Austria).*

#### **Introduction**

Risk communication is an integral part of risk assessment and the process of risk management. One central tool of effective risk communication, especially with regards to stakeholder participation, is the risk dialogue (Lundgren & McMakin, 2009). A risk dialogue is centred on actively involving different groups of stakeholders in a two-way exchange of related information or knowledge (Höppner et al., 2012).

In the frame of the PARAMOUNT project, a Regional Risk Dialogue (RRD) was initiated in the Austrian Stanzer Valley test bed in the Tyrol. The RRD brings the Austrian project partners (PPs) and a wide range of project-external beneficiaries together. These include key decision-makers, road and rail engineers and natural hazard experts from institutions dealing with the operation and maintenance of the critical infrastructure in the Stanzer Valley as well as relief units. Furthermore, stakeholders representing institutions heavily relying on the availability of critical infrastructure (e.g. tourism board, chamber of commerce) were invited to join. All levels of government (national, provincial, district and municipal) were represented in the RRD, setting the stage for an improvement of inter-sector and cross-sector risk communication.

In the risk management context, the RRD is situated in the prevention / preparation stage of the risk cycle (see [www.planat.ch](http://www.planat.ch)). As described by Höppner et al. (2012), risk communication and thus the



RRD form an intricate part of this stage of integral risk management, e.g. by raising awareness, building trust and involving stakeholders in decision-making.

The objectives, methodology and key results from the two RRD meetings held in the frame of PARAMount are described below.

## **Framework of the RRD**

### **The Austrian Stanzer Valley test bed**

The Stanzer Valley is the study site of the Austrian project partners: the Austrian Federal Ministry of Agriculture, Forestry, Environment and Water Management; the Forestry Section (BMLFUW), Austrian Federal Railways (ÖBB) and Federal Research and Training Centre for Forests, Natural Hazards and Landscape; the Department of Natural Hazards (BFW). It is located in western Austria in the province of Tyrol and covers an area of approximately 300 km<sup>2</sup> (Figure 29). The road and rail connections running through the Stanzer Valley are very important for transit on a regional, national and international level (main east-west connection in Austria; main connection Austria – Switzerland). Furthermore, as the main source of income in the Stanzer Valley is centred on (winter) tourism, accessibility plays a crucial role for the prosperity and future development of this region. This is reflected in the volume of traffic along these infrastructure lines: on average approximately 20,000 cars, 4,000 lorries and 74 trains pass through this valley daily. The test bed features a high susceptibility to a wide range of natural hazards, including avalanches, debris flows, rockfalls, landslides and floods. Only about 6% of the total test bed area can be used for permanent settlement. The bottom of the Stanzer Valley is very narrow in parts, therefore some sections of the critical infrastructure are located in very close proximity



Figure 30). Thus in these locations, several critical infrastructure lines may be interrupted by a single natural event, making an effective and efficient communication and cooperation between the infrastructure managing and operating institutions indispensable.

A detailed description of the test bed, including the institutional and legal framework is supplied in the PARAMount deliverables BFW (2010) and the Risk Management and Implementation Handbook.

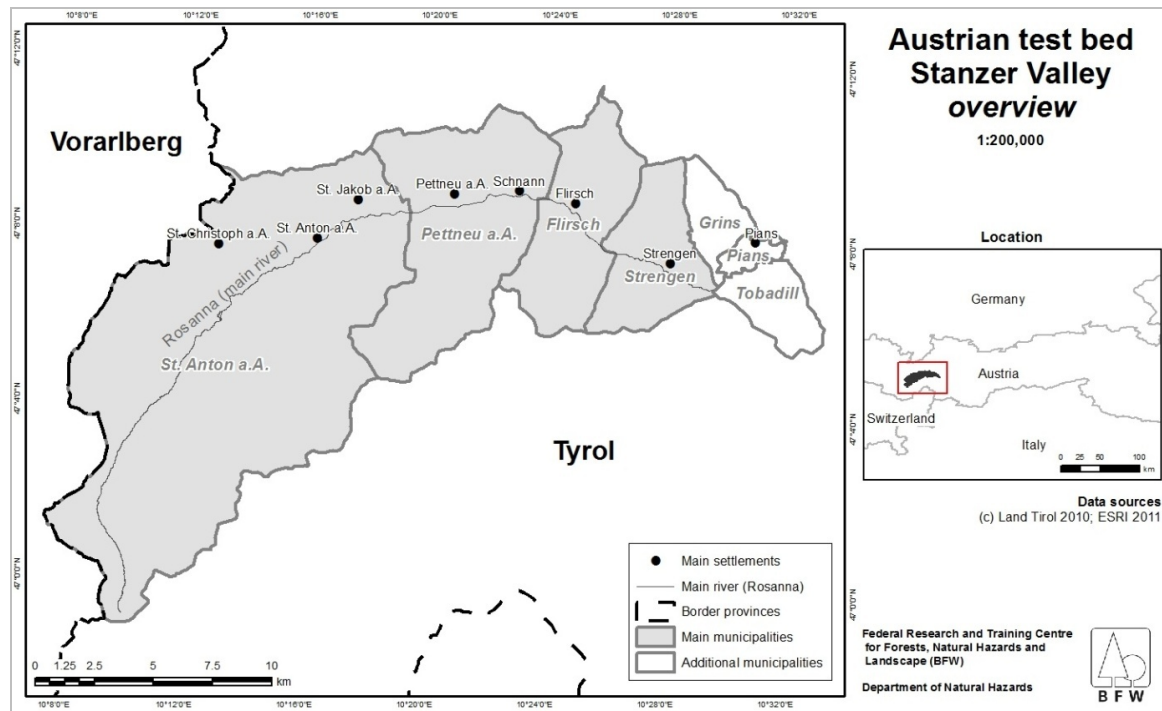


Figure 29: Overview of Stanzer Valley test bed (Tyrol, Austria)

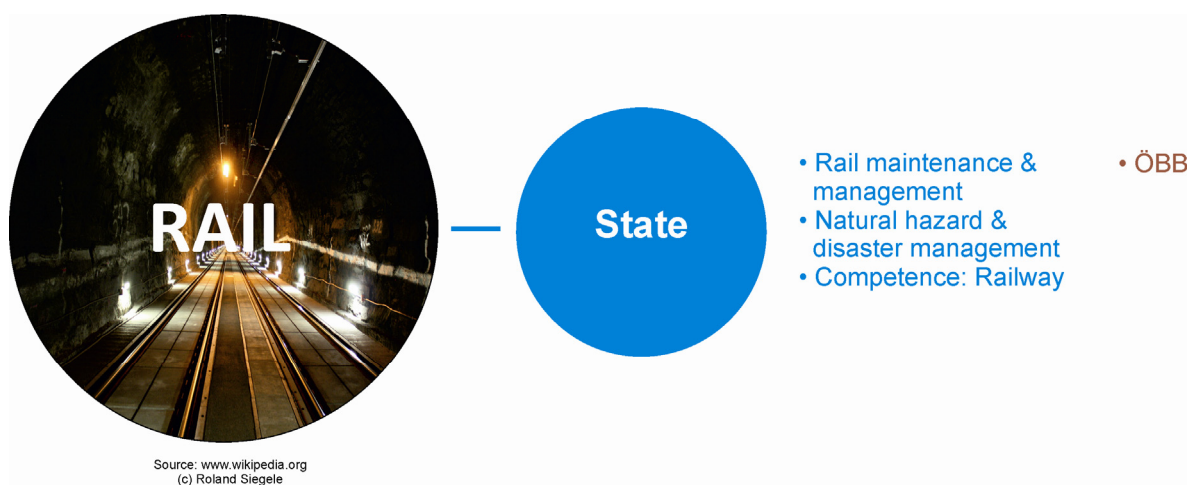
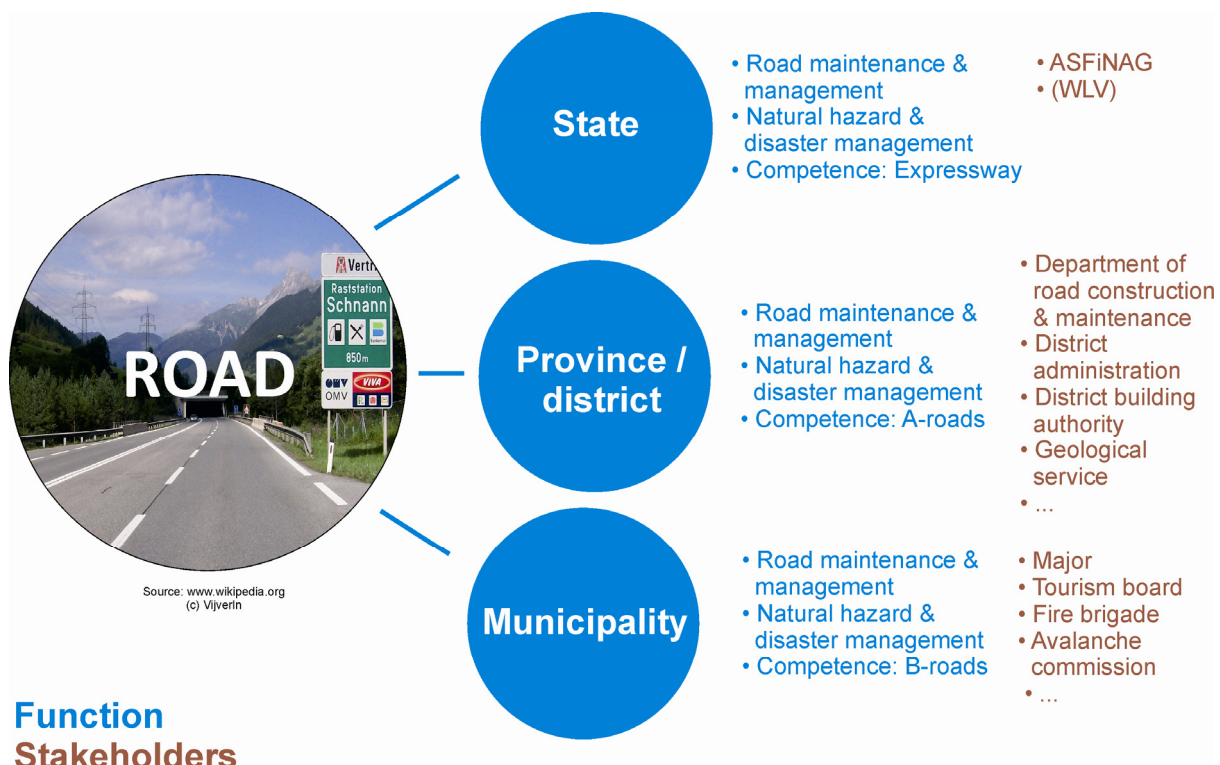


Figure 30: Central section of the Austrian Stanzer Valley test bed (left) (source: BFW); close-up view of the critical road and rail infrastructure in the test bed: Arlberg-railway (far left in the picture) expressway (left in the picture) and A-road (right in the picture) near the Flirsch Ost junction (right) (source: BFW).

## Participants in the RRD

The RRD was organised and hosted by the Austrian PPs (BFW, BMLFUW & ÖBB). The situation with regard to the involvement in the risk management context and the operation and maintenance of critical infrastructure in the test bed is quite diverse for the different Austrian PPs:

- The BFW (Department of Natural Hazards) supports infrastructure providers on a provincial and regional level with expert knowledge and assistance in the frame of natural hazard and risk management; however, the BFW does not have any direct responsibility regarding the operation or maintenance of transport infrastructure.
- The BMLFUW (Forestry Section) deals with natural hazard and risk management issues on a federal administrative level with no direct connection to infrastructure providers (notwithstanding e.g. the competences of the WLV, who are also part of the BMLFUW); therefore they do not have any direct responsibility either for the operation or maintenance of transport infrastructure.
- The ÖBB as railway operator are directly responsible for the operation and management of the rail network and natural hazard and risk management for this infrastructure type.





**Figure 31: Stakeholders in the Austrian Stanzer Valley test bed responsible for road (top) and rail (bottom) transport infrastructure listed by their level of governance, function and name**

Figure 31 gives an overview of the project-external participants in the RRD, split by infrastructure type and administrative level. All institutions listed on the right of the figure, took part in the RRD. The level of governance indicates on what federal scale the respective institutions are coordinated. In the case of the state institutions for example (ÖBB, WLV, ASFiNAG), the coordination is run on a federal level. However these institutions operate through regional and local representatives and offices, which are in contact with the provincial and municipal institutions.

## Objectives and expectations of the RRD

The main aim of the Stanzer Valley RRD was to bring together the key infrastructure-relevant stakeholders in the test bed. Currently hazard and risk communication in the test bed is mainly based on one-way information of a selection of stakeholders, rather than a dialogue. This makes a case for the process of hazard mapping by the WLV, risk management concepts separately developed and operated by the ASFiNAG and ÖBB or contingency plans on a municipal level.

On the one hand, from the point of view of the organisers of the RRD, the Austrian project partners, the following aims were envisaged:

- Integration / participation of infrastructure-relevant stakeholders in the Stanzer Valley
- Facilitation of the dissemination and evaluation of project results in this test bed, while ensuring that the findings of the project are relevant to the groups addressed and provides them with usable suggestions, concepts, tools and information
- Creation of a platform with an interdisciplinary and intersectoral approach, bringing together all levels and branches of risk management institutions
- Assessing the problems and requirements, specific to the regional and local stakeholders

On the other hand, the stakeholders had the following expectations from the RRD (as gathered from the feedback during the workshops):

- Means for exchange of infrastructure and natural hazard relevant topics in the district of Landeck; being able to establish direct contact between representatives from road and rail infrastructure providers and municipal, district and provincial authorities – improvement of cooperation and communication
- Obtaining new and relevant information from the PARAMOUNT project.

## Methodology

The RRD in PARAMOUNT and the Austrian test bed in particular was set up using a multi-scale approach:

**European level:** a common methodology was developed on a European level establishing a joint approach in all countries involved. By exchanging best practice examples between the PPs, the RRD can facilitate the inter-sectoral and cross-border cooperation in the study sites regarding risk communication and awareness in natural hazard management. Furthermore this approach allows a characterisation of the stakeholders in the study sites by conducting qualitative and quantitative interviews as well as workshops, providing a valuable input for the tools and methods developed in the scope of the project (Pechlaner et al., 2011). This makes a direct comparability of the results possible at European level.

- **Regional level:** by bringing together stakeholders from different communities within the study site, representatives of district, provincial and federal institutions, which include public service providers, local and district authorities, scientific experts and end-users mostly from the field of natural hazard protection and management, the RRD can support the establishment of direct communication and foster the improvement of hazard management strategies on a regional level.
- **Local level:** the problems highlighted by the stakeholders in the RRD are dealt with on a local level, by including the local decision-makers and stakeholders. The RRD can inter alia contribute towards enhancing risk communication between the key stakeholders, aiding them in their daily business of natural hazard and risk management, improving communication between different levels of governance and fostering cooperation.

In PARAMount the status quo of natural hazard management was elaborated in the frame of WP4 by conducting a set of standardised interviews on the European level, thus serving as the basis of the RRD. The RRD were organised on the regional and local level, thus addressing the specific issues raised in the test beds.

So far two RRD workshops were conducted in the Austrian test bed in the city of Landeck, organised by the BFW:

RRD I: 26<sup>th</sup> January 2011

RRD II: 16<sup>th</sup> February 2012

A third RRD workshop is planned for after the official project end of PARAMount at the beginning of 2013, where the final project results will be presented and the idea of continuing the RRD beyond the duration of PARAMount will be put into practise.

The RRDs were organised as a mixture between presentation of the current project results (1/3 of the entire workshop time) and discussions in small groups and the plenum (2/3 of the workshop time). Thus facilitating a two-way communication and maximising the potential feedback on both the project results and current local and regional issues, which the stakeholders suggest should be addressed in the frame of PARAMount.

For further details on the RRD workshops (e.g. meeting minutes, presentations, agendas and photos), see deliverable 7.1 (PP2).

## Results

The interviews conducted in the Stanzer Valley previous to the RRD (WP4), show a considerable diversity of requirements and perceptions of natural hazards in general and in particular regarding their management (Pechlaner et al. 2011). The results highlight the conflicts, challenges and ambiguities which the stakeholders face in this study site (see deliverable Act 4.1).

During the RRD the participants stated, that the cooperation between the district and municipal authorities, as well as the road management and operation authorities, was well developed. A high level of cooperation was testified, at the centre of which stands a common meeting before the beginning of every winter (winter service review), which involves all road transport operators and authorities.

One of the key issues raised by the participants of the RRD I in the Stanzer Valley was the need of increased cooperation on a regional level between the district authority, fire brigades / municipal avalanche commissions and road operators on the one hand and the ÖBB as rail operators on the other. The main issues raised by the participants included:



- Timing and justification of road / rail closures
- Contact persons at the ÖBB in crisis situations (due to company-internal restructuring, former lists of contacts were partially out-of-date)
- Exchange of meteorological data from weather stations in the area, thus improving the reliability of avalanche forecasts

As representatives from all involved parties were present at RRD II, first steps to resolve these issues could be undertaken. In general, the RRD brought to light the large interest of the stakeholders involved in a long-term fostering and intensification of risk communication and cooperation.

The main strategic results and benefits from the RRD workshops held in the Stanzer Valley test bed include:

- The RRD has proven to be an effective communication platform for natural hazard management and risk communication within the test bed
- The RRD reflects and strengthens the importance of a participatory approach (bridging the gap between science and practice)
- The RRD workshops were rated by the project-external stakeholders and project partners as one of the key benefits from the PARAMount project.

Specific results on an operational level include:

- Clear definition of the responsible contact persons at the ÖBB
- The head of the local council (*Bezirkshauptmann*) has invited the ÖBB to join the winter service review in the coming year, in order to define concrete steps for improving risk communication in the region
- Some of the major players in the test bed stated at RRD II that since the first RRD workshop, communication and cooperation between the municipal and ÖBB avalanche commissions has been significantly improved. This was particularly important, as a high degree of avalanche danger and a closure of both critical road and rail connections for several days occurred in the winter of 2011/2012 in the test bed
- Cooperation planned between the ASFiNAG (expressway operation and maintenance) and the ÖBB regarding the exchange of meteorological data

## **Outlook and lessons learned**

The RRD is intended as a means of building a cross-sector work group in the region, which will encourage and foster risk communication and awareness, ideally beyond the duration of the project. PARAMount may therefore provide a long-term benefit not only to the decision-makers, but also to the broader public in the Stanzer Valley test bed, providing an improved and extended knowledge base for the decision-makers involved in natural hazard and risk management. The RRD therefore serves as a starting point for a more sustainable, long-lasting interdisciplinary communication, cooperation and coordination platform in regional natural hazard management and risk communication.

The main lessons learned within the PARAMount project, by means of the RRD, include:

- Endorsement of the importance of cooperation on a regional level between road and rail decision-makers (encouraging the regional focus of the rail company)
- Enhancement of communication between avalanche commissions (road – rail) in order to improve effectiveness of hazard early warning and temporal measures

- Advances in disaster and natural hazard management with regard to establishing more direct lines of communication
- Envisaged data exchange via a common weather station network, bilateral meeting road-rail including district and municipal decision-makers
- Direct feedback from regional stakeholders and their participation essential
- Importance of participatory approach, to bridge the gap between science and practice
- Risk communication with local stakeholders important to improve acceptance of mitigation measures (permanent or temporary)
- Contribution to natural hazard management on a strategic level within PARAMount

The results of the RRD have additionally been presented in Adams (2012a, b, and c) and Adams et al. (2012).

## Publications and presentations in the frame of PARAMount

Adams, M.S. (2012a): Regional Risk Dialogue – an effective tool for natural hazard management and risk communication? A case study in the Stanzer Valley, Tyrol (extended abstract and poster). 12<sup>th</sup> Congress INTERPRAEVENT 2012, Grenoble, France.

Adams, M.S. (2012b): Lessons learned in PARAMount: Natural hazard management strategies for infrastructure protection in the Austrian test bed (Stanzer Valley). Keynote speech held in the frame of the final conference of the PARAMount project (incl. extended abstract), 23<sup>rd</sup> April 2012, Grenoble, France.

Adams, M.S. (2012c): „Regionaler Risikodialog im Stanzertal – Ziele und Ergebnisse’. Presentation in the context of the Austrian Post Graduate Course, 23<sup>rd</sup> – 25<sup>th</sup> October 2012, Innsbruck, Austria.

BFW (2010): Test bed description of Stanzer Valley. Deliverable in the ASP project PARAMount.

## References

Höppner, C., Whittle, R., Bründl, M. & Buchecker, M. (2012): Linking social capacities and risk communication in Europe: a gap between theory and practice? *Nat Hazards*, 64:1753–1778. DOI 10.1007/s11069-012-0356-5.

Lundgren, R.E. & McMakin, A.H. (2009): Risk communication: a handbook for communicating environmental, safety, and health risks. WILEY, New Jersey.

Pechlaner, H., Pichler, S. & Kofink, L. (2011): PARAMount – survey on risk awareness and perception on regional/local level. ETC Alpine Space project PARAMount No. 28-2-2-AT. European Academy Bozen – Bolzano, Institute for regional development and location management. Deliverable in PARAMount.

## Acknowledgements

The Austrians PPs would like to express their sincere gratitude to all stakeholders and observers, who actively participated in the RRD and provided valuable input data, information and feedback throughout the whole project.

These include:

- Forsttechnischer Dienst für Wildbach- und Lawinenverbauung (Gebietsbauleitung Oberes Inntal; Stabstelle für Geoinformation; Sektion Tirol)
- Amt der Tiroler Landesregierung (Abteilung Verkehr und Straße; Baubezirksamt Imst; Straßenmeisterei Landeck / Zams; TIRIS)
- ASFiNAG Alpenstraßen
- Gemeinden im Stanzertal: Tobadill, Grins, Pians, Strengen, Flirsch, Pettneu am Arlberg & St. Anton am Arlberg (insbesondere: Bürgermeister; Tourismusdirektor St. Anton; Lawinenkommissionen; Freiwillige Feuerwehr)
- Bezirkshauptmannschaft Landeck
- Wirtschaftskammer Tirol
- Zentralanstalt für Meteorologie und Geodynamik

## 4 Development of methodologies for indirect vulnerability evaluation: network analysis for road accessibility and criticality assessment

### 4.1 Importance and criticality of roads exposed to natural hazards in mountains: an approach based on network structural properties analysis

*This section has been written and verified by Jean-Marc Tacnet<sup>4</sup> (Irstea, Snow Avalanche Engineering and Torrent Control Research Unit, Grenoble, France) in collaboration with Eric Mermet (IGN/COGIT).*

In mountain areas, roads and transport infrastructures are exposed to natural hazards such as avalanches, torrent floods and rockfalls. Road networks are essential for economic, social, environmental and safety reasons and can therefore be considered as part of the critical networks that can be ranged according to the consequences of their being disrupted (Figure 32).

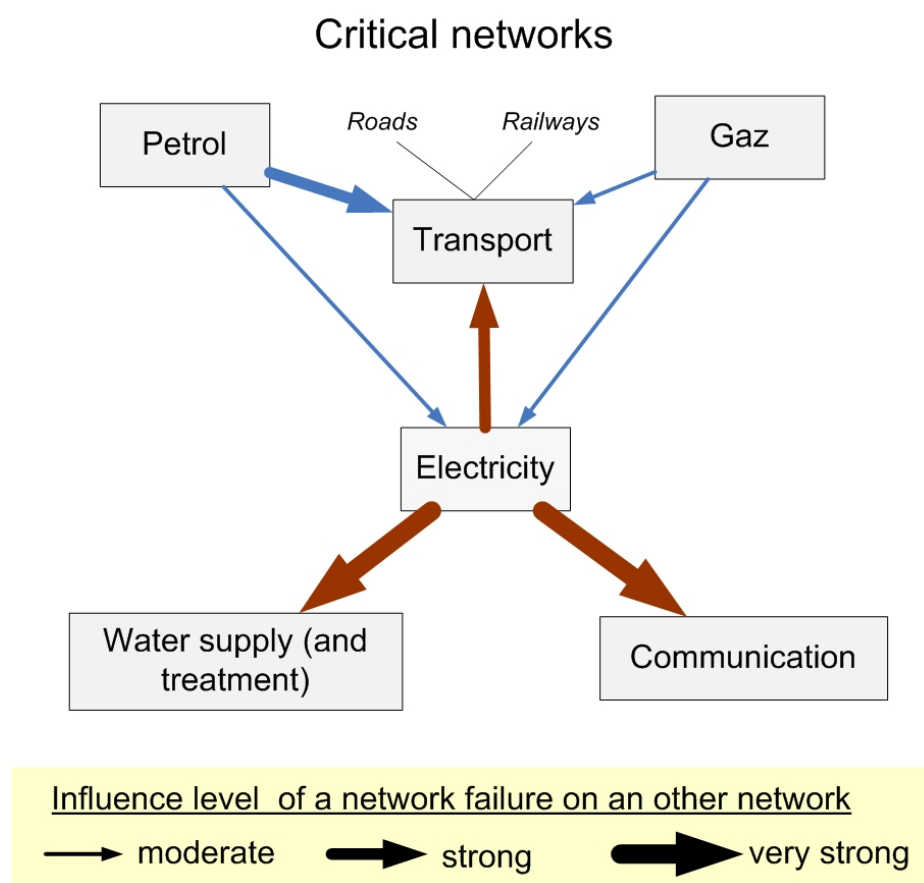
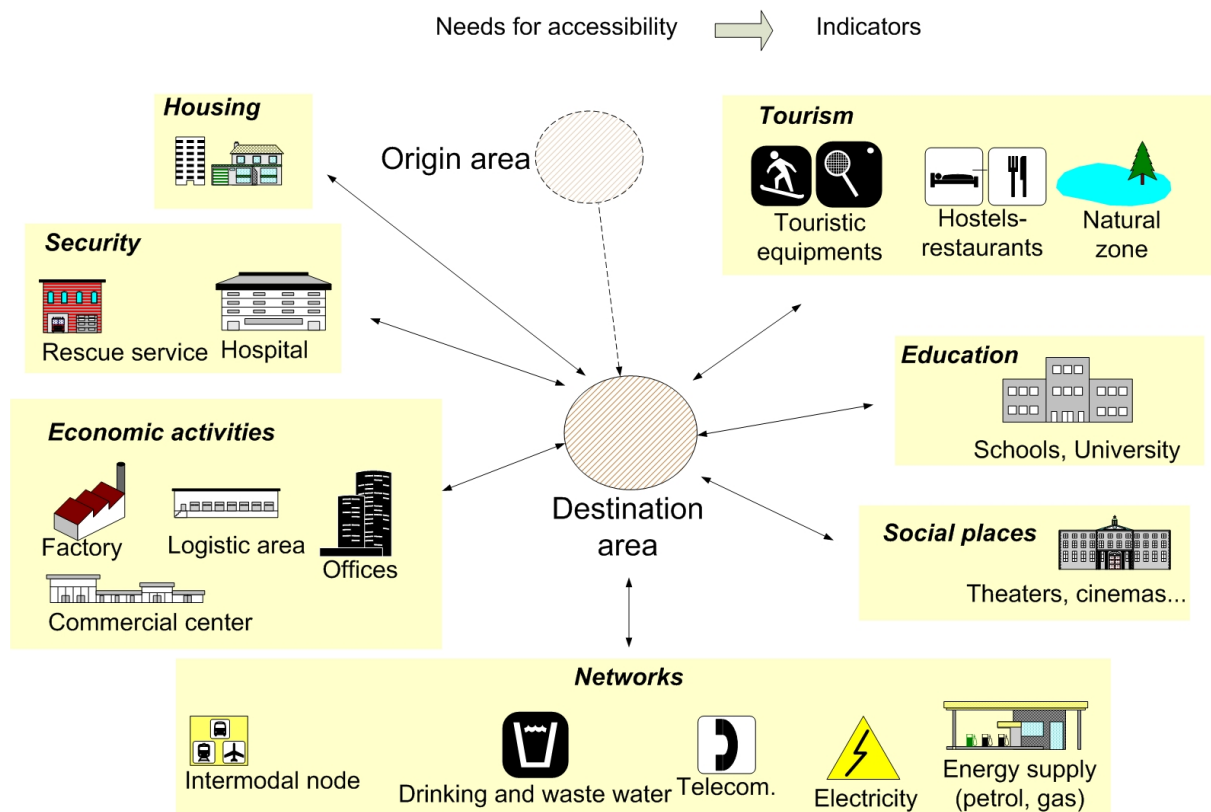


Figure 32 : Existing cross-relations between the vital networks [Tacnet et al., 2012c] .

<sup>4</sup> Done in collaboration with Eric Mermet, Somsakun Maneerat. See bibliography for references about this work.

Risk depends both on hazard and on direct and indirect vulnerability, which is also more difficult to assess. In the case of roads, indirect vulnerability relates to the consequences of road closures which is rarely assessed. The criticality of these closures depends on the importance of road sections which in turn is linked to the consequences of road closures and attractiveness factors of nodes (Figure 33). A new methodology is proposed to evaluate this importance in the context of natural risks management in mountains (see [Tacnet et al., 2012c] for a detailed description of this methodology).



**Figure 33 : Attractiveness (and importance) of nodes according to thematic domains**

Based on structural networks analysis, it aims to assess the accessibility level of mountain territories and to identify critical roads sections depending both on their exposure to phenomena and also on the importance of roads in an economic, social and environmental context. The structural network analysis allows for description of how far the network properties condition the accessibility from one point to another. The centrality indicator measures the level up to which a road is used to reach any point. The average distance is an indicator to show how easy or difficult it is to reach a point on the network. A new approach is combined with multi-criteria decision-making to assess importance according to economic, social or human factors, also having regard to fragility, resilience or risk sensitivity on specific road sections.

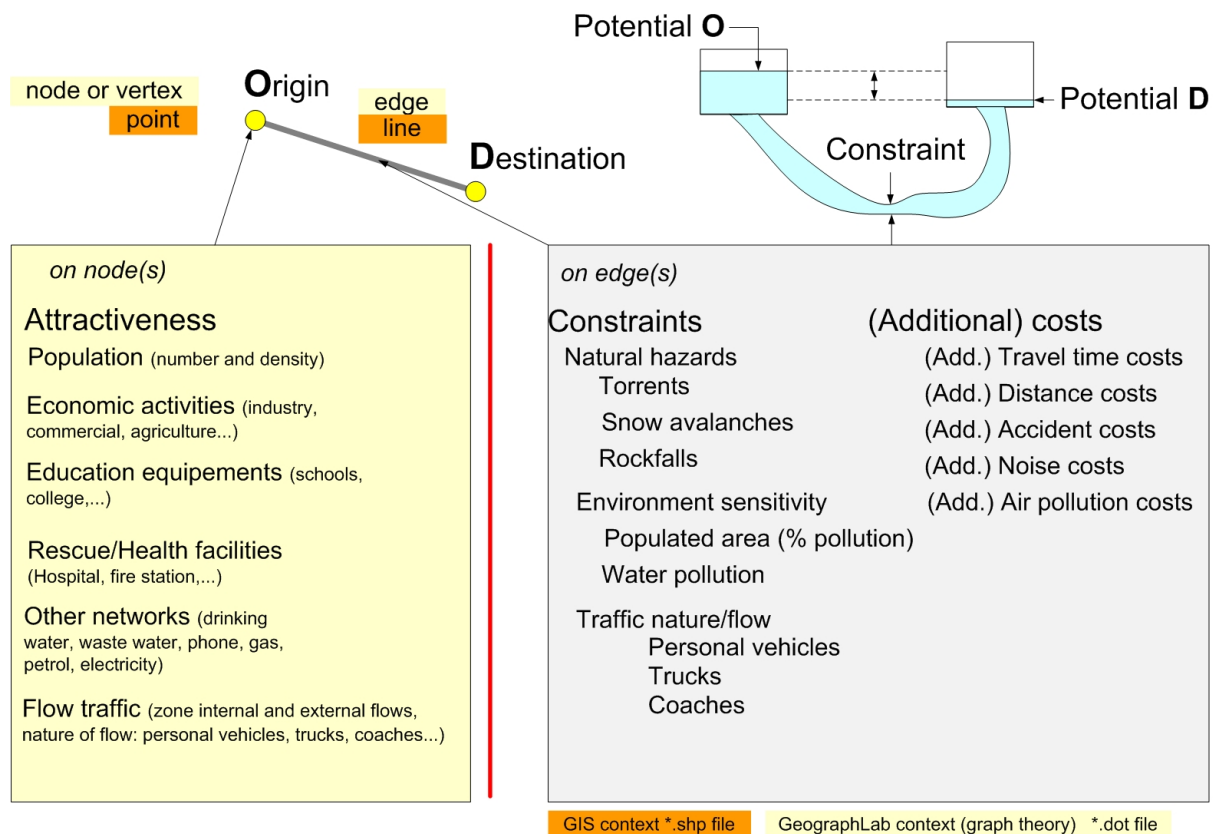


## Methodology

The methodology is based on two steps. The first step characterises the initial state of socioeconomic factors across the territories. The second one translates them into structural indicators (linked to importance) of each road section using both network structural properties and constraints derived from a multi-criteria analysis of natural hazards.

### Step 1: Evaluation of the initial state of economic factors

A first GIS analysis of the economic, social and environmental context is done in order to identify the location and importance of the main economic centers, the status of road networks, etc. [Maneerat, 2012] (figure ).



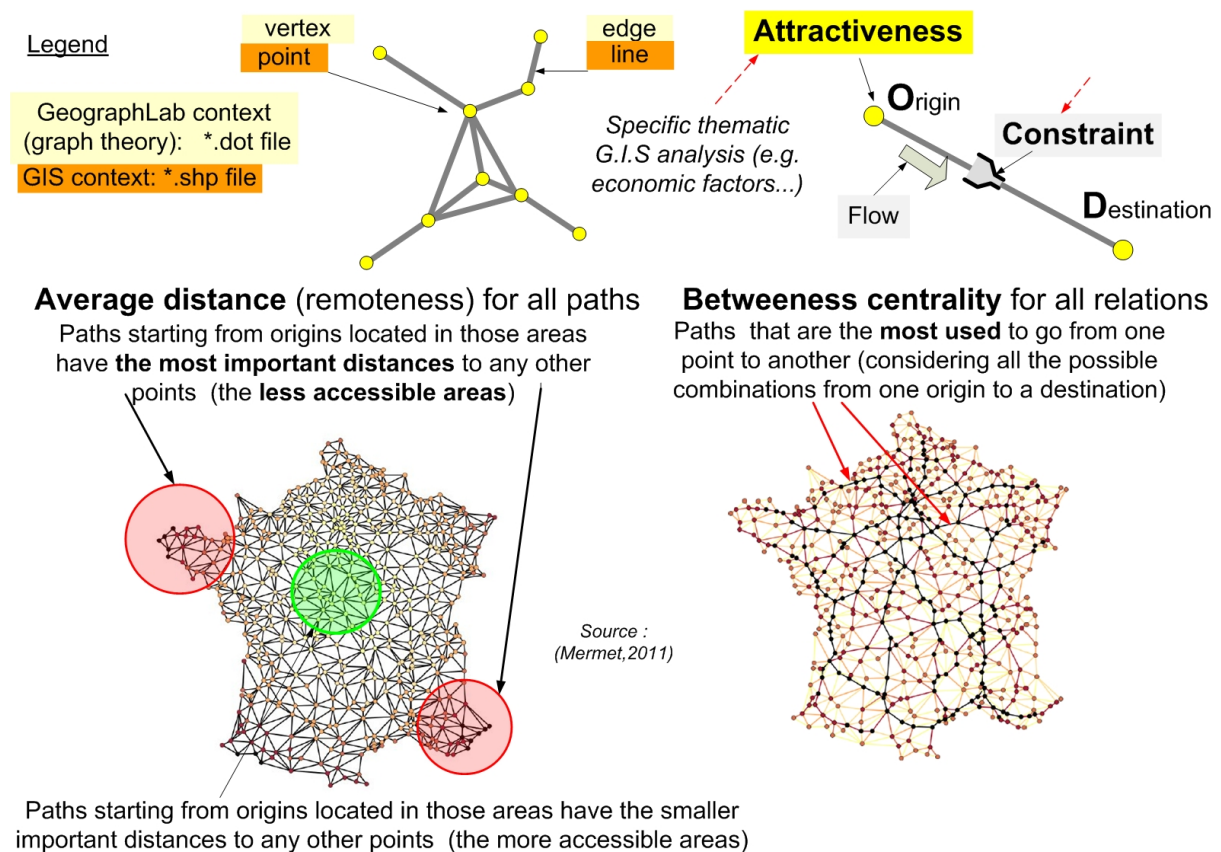
**Figure 34 : Thematic indicators corresponding to economic, social, environmental, safety contexts are derived into constraints and attractiveness indexes.**

### Step 2 : Evaluation of the structural properties

The parameters used for the evaluation of the structural properties come from the road layer on the BDTopo (vector database provided by IGN - Institut National Géographique, France) : euclidean length between two vertices, length or width of road section, slope, sinuosity, number of tracks or one-way tracks.

A new specific development has been done on *GeoGraphLab* software in order to allow to consider thematic layers into the structural analysis. So we can now add any incoming data such as city population, economic, number of beds in a ski resort, natural hazards features etc.. In this way, incoming data are seen as attributes on edges (road sections) and on intersections (vertices). That's all what *GeoGraphLab* needs to compute relational indicators like average distance and betweenness centrality. For each vertex ( $v_i$ ) and/or each edge ( $e_i$ ), computational principle for these two indicators consists in evaluating the path from any origin (O) to any other destination (D). (see equations in [Mermet and Ruas, 2010]).

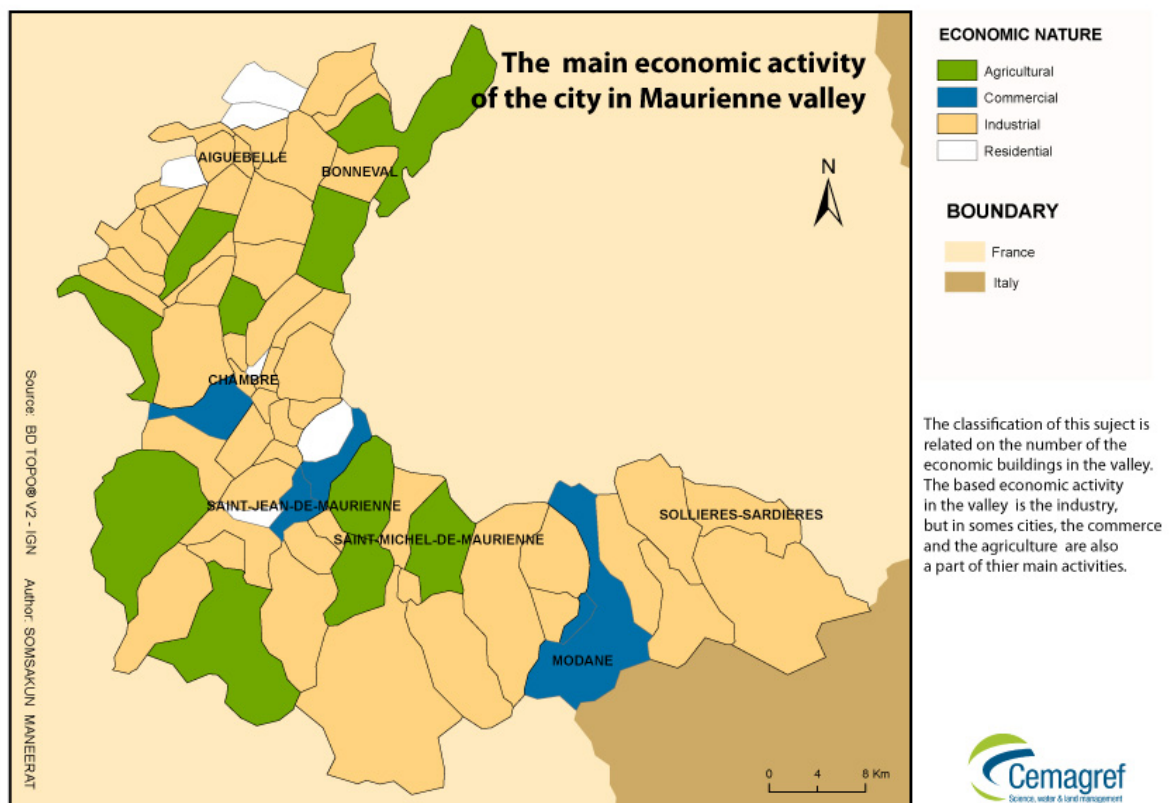
Paths are computed on any attributes of network component. This means that it is possible to get as result a betweenness centrality based on other paths than the shortest (time or distance). If we consider the safest path as an input the indicator (Dijkstra algorithm has to find a lower bound in utility function that can be based on hazard, vulnerability, frequency, severity or detectability of risk), the mapping result will show areas on the network where the risk is lower. If these maps are combined by crossing block-maps corresponding to the different indicators in the graphical user interface, new indicators are created on the basis of structural and functional aspects of the studied network. Various operators (basic mathematical functions or other functions) can be used in these crossing operations. Additional information like fragility, resilience or sensitivity of road sections (Figure 35 ) are thus revealed.



**Figure 35 : Principles of transformation of thematic features into structural properties indicators (betweenness centrality and average distance) on the main roads network in France using *GeoGraphLab*.}**

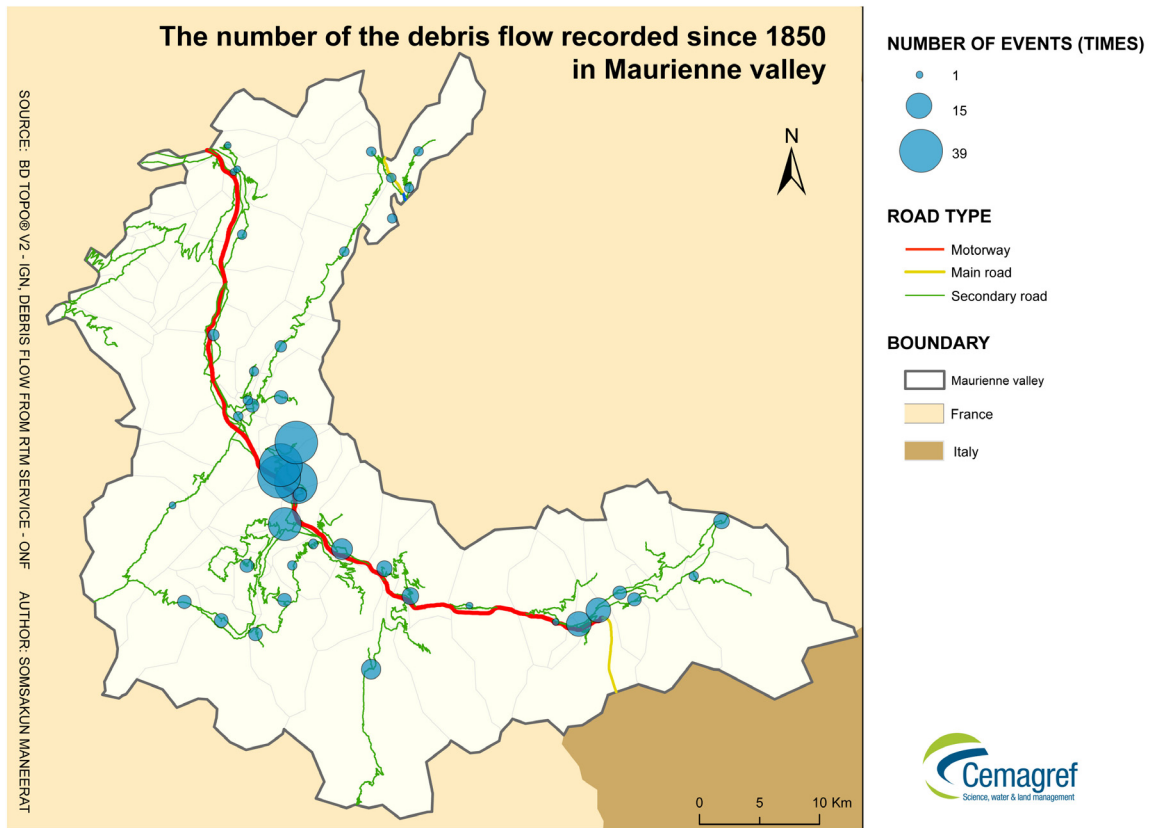
## Applications

An application of this methodology has been done in the Maurienne Valley (Savoie, France) [Maneerat, 2012]. Economic data coming from INSEE databases [INSEE, 2011] are analysed in order to identify and locate main activities (figure). These data are used afterwards in order to determine attractiveness indexes.



**Figure 36 : Example of basic data used to define attractiveness indexes - main economic activities in Maurienne Valley, Savoie, France.**

Data related to topographic, geometric and traffic features of roads [CG73, 2011] and natural hazards information resulting from existing ONF/RTM events database (figure) or specific multi-criteria decision model [Tacnet, 2009] [Tacnet et al., 2009] [Tacnet et al., 2010a] are used as constraints in the structural analysis.



**Figure 37 : Historical torrential events in relation with roads in Maurienne Valley, Savoie, France.**

The results are obtained for the road network for each domain of activity. They correspond to the two main indicators described below and denoted as betweenness centrality and average distance. As an example, the figure shows the importance of roads calculated by *GeographLab* and based both on features of road network and on economic attractiveness of vertices in the tertiary sector of economy (services).

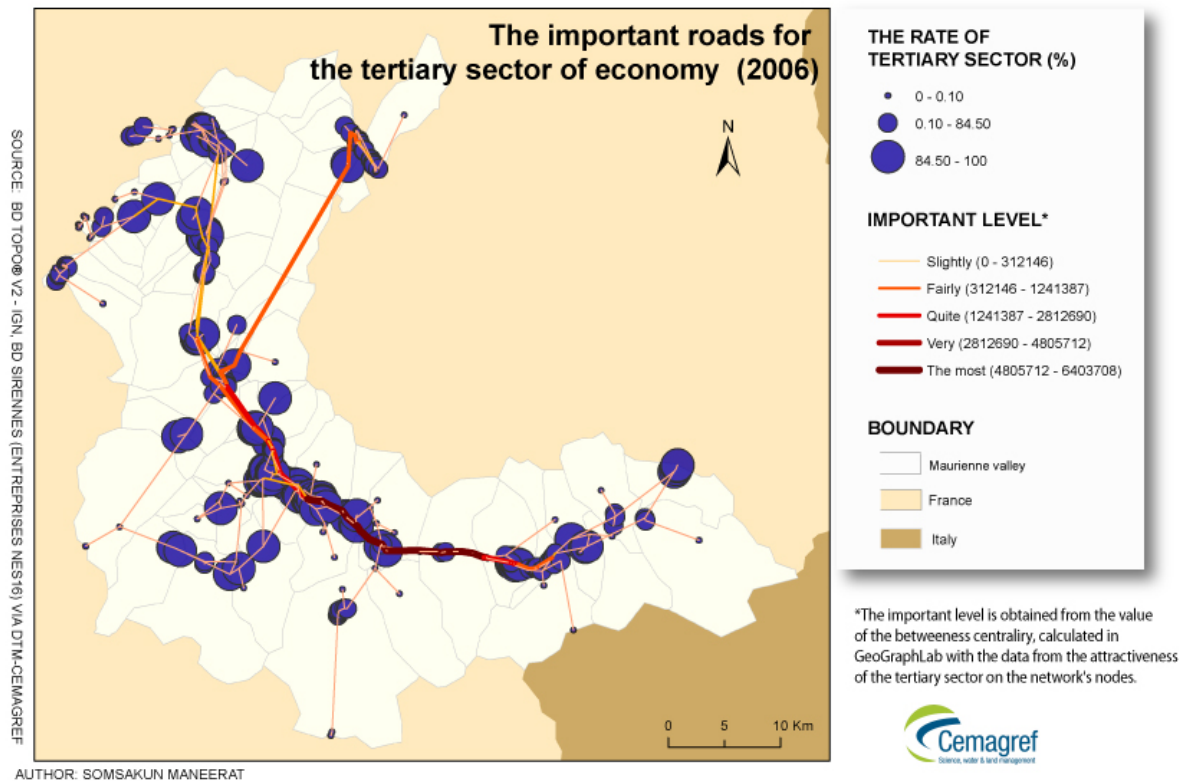


Figure 38 : Example of structural analysis with thematic data to assess importance of roads.

## 4.2 Road vulnerability assessment based on network analysis

*This section has been written and verified by Verena Larcher, Volkmar Mair and Claudia Stradia (Geological Service of Bolzano Province, Bolzano, Italy) and their subcontractors.*

### Introduction

The systematic study of the risks at which transport infrastructures can be exposed is an useful tool to identify the most suitable interventions to ensure an agreed level of service of a network. The definition of risk concerns the combination of two elements: the probability that an event occurs and the negative consequences (costs) it produces. The concept of risk is linked to the definition of reliability, which is, in case of a transport network, the capacity of maintaining a pre-assigned level of service for a given time period. The greater the risk to which the transport infrastructure is exposed, the lower the level of reliability that it is able to provide. That is why defining the risk concept is not enough, and it is important quantifying the risk too. The risk  $R$  can be defined as 'the severity of the expected damage caused by the occurrence of a particular hazardous event, in a given area during a certain time interval'. It is generally considered as the product of three distinct factors: hazard, exposure and vulnerability of the elements of the system. The United Nations Disaster Relief Coordination Office defines:



- the hazard as the probably that an event will occur during a certain time period in a given area, that can affect the investigated element;
- the exposure as the value represented by the investigated element such as, for example, the population, the propriety, public services, economical activities (this value can be expressed in monetary terms or by quantifying the exposed entities);
- the vulnerability as the functional loosening caused by the occurred event; it can be expressed in a scale from 0, which means non damage, to 1, which represents the complete loss of the element (component) or group of elements of the system;

Following the risk definition that has been given before, the risk can be expressed by the following relation:  $Risk = Hazard \times Vulnerability \times Exposure$

Based on these definitions, the risk on transport infrastructure can be evaluated step-by-step, estimating the vulnerability, the exposure and the hazard. Then, combining these variables, it is possible to evaluate the risk.

### **Risk analysis of a road network: proposed methodology**

In this study a methodology for the risk evaluation of links in a road network, due to the occurrence of a calamitous event, is developed. Risk can be determined through the well-know equation:

$$Risk = Hazard \times Vulnerability \times exposure$$

The proposed methodology is developed according to the following steps:

1. analysis of the road network;
2. vulnerability index computation for each link of the network;
3. computation of the exposure index for each link of the network;
4. ranking of the links based on the risk level, computed assuming the same hazard level for all links of the network.

The first step consists in the analysis of the investigated road network. The real network has been represented through a graph, thus requiring the functional classification of the network distinguishing main and secondary infrastructures. At each link of the network has been assigned a cost function that allows assigning the mobility demand to the network in order to compute links flows. Then, the vulnerability and exposure indexes have been computed for each link of the network in order to evaluate the risk for each investigated link and obtain a hierarchical rank of the links.

### **Network analysis under normal serviceability conditions (undamaged conditions)**

The analysis of the actual situation is the starting point of each planning process. The data regarding the transportation system as well as the socioeconomic system are gathered during this phase, whose aim is developing a mathematical model that, after being calibrated and corroborated with reference to the actual situation, allows simulating the effects and impacts due to the occurrence of calamitous event.

For each analysis the development of three models is necessary: the *supply model*, constituted by the transport network model, the *demand model*, that provides the information about the movements in the study area (internal-internal, internal external, external-internal, external-external) within a specific reference period, and the *assignment model*, that simulates the interaction between the previous models and allows determining links flows. Links flows are the output data of this phase and are needed to evaluate the impacts and performances of the transport system. The network

analysis in normal serviceability condition is usually performed to determine a reference index that can be used for subsequent evaluations, such as the total travel cost of the undamaged network

$$C^{undamaged} = \sum_i f_i \cdot c_i$$

where  $f_i$  is the simulated flow on the generic link  $i$  of the network;  $c_i$  is the

generalized cost of link  $i$  perceived by network users. This generalized cost is usually the result of several contributions such as the travel time, fuel cost, distance travelled, etc.; that is why we talk about 'generalized' cost, which thus provides a measure of the disutility experienced by users during their movements.

## Computation of the vulnerability index

The vulnerability index has been developed in order to provide a practical instrument that allows ranking the links of the network on the basis of their vulnerability. Therefore, the most vulnerable link of the network is also the most important one, that is the one whose closure produces the higher damages (costs) to the whole system.

To evaluate link vulnerability a new index has been defined. Such an index is given by the sum of two different functions. The first function estimates the importance of a link for the operation of the network as a whole (global importance). This function in turns depends on the increase of the total travel cost of the network (non-cut links) or on the unassigned demand (cut links). The second function takes into account the concept of local link importance and it depends on the average daily traffic (ADT) measured along the investigated links.

Vulnerability of link  $i$  thus corresponds to the importance  $I_i$ , obtained as a linear combination of the following two functions:

- $I_{\Delta C, i}$  (global importance function for link  $i$ )
- $I_{ADT, i}$  (local importance function for link  $i$ )

In order to compute  $I_{\Delta C, i}$  it is necessary to distinguish between cut links and non-cut links: for the latter ones we evaluate the increase in the total travel cost of the network produced by the closure of link  $i$ .  $\Delta C_i = C^{(i)} - C^{(0)}$

where:

- $i$  is the link whose vulnerability index has to be evaluated;
- $C^{(i)}$  is the total travel cost of the network in damaged conditions, that is in case link  $i$  is out of service (or in case a certain number of links that identifying a unique road segment, for which the ADT has been provided, is interrupted);
- $C^{(0)}$  is the total travel cost of the network in the undamaged condition.

In case a link is a cut link, not all the demand can be assigned to the network. This produces an infinite increase in the total travel cost of the network. In order to obtain a finite value, a different procedure has been adopted in case of cut links:  $\Delta C_i = \max_{j \in \text{noncutlinks}} \Delta C_j + D_i^*$  where  $D_i^*$  is the unassigned demand and  $\max_{j \in \text{noncutlinks}} \Delta C_j$  is the maximum increase in the total travel cost of the

network produced by the closure of a non-cut link. In this way, cut links will always have a  $\Delta C$  higher than the one of non-cut links. All the links (cut and non-cut ones) are then ranked using the computed values in a decreasing way. In particular, the link at the top of the rank is the cut link whose closure produces the higher value of unassigned demand. Then, the other cut links follow based on the value of unassigned demand and only after all the cut links we will found the non-cut

ones ranked decreasingly on the increase in total travel cost of the network produced by their closure. At each link  $i$  is then assigned a position using the following function:  $p(i) = \text{rank}(i)$

with  $\text{rank}(i)$  a function that associates at each link  $i$  the number describing its position in the rank.

On the base of its position, the link's global importance function can be computed as follows:

$$I_{\Delta C,i} = 1 - \frac{p(i) - 1}{n - 1} \quad \text{with } n \text{ the total number of links for which the importance is evaluated.}$$

By definition, the values assumed by this index ranges between 0 (last link in the rank) and 1 (top link in the rank). Regarding the link's local importance function  $I_{ADT,i}$ , it is assumed that the higher the measured ADT is, the higher its importance.  $I_{ADT,i}$  has been computed using the ADT values measured along the investigated links through fix and mobile stations. In particular, this index is firstly computed as the ratio between the ADT measured on link  $i$  and the maximum average daily traffic

( $ADT_{max}$ ) measured in the network:  $I_{ADT,i}^* = \frac{ADT_i}{ADT_{max}}$ . Once the ratio  $ADT_i/ADT_{max}$  has been

computed, in order to amplifying the local importance of highly congested links, which seems reasonable, the following formula has been introduced:

$$I_{ADT} = \min \left\{ 1; \max \left[ \frac{ADT_i}{ADT_{max}}; \frac{1}{ADT_{max}} \cdot \left( ADT_i + h \cdot [ADT_i - ADT_p] \right) \right] \right\} \quad \text{where } h \text{ is a parameter}$$

equal or higher than zero, and  $ADT_p$  is the threshold value above which the ratio will be amplified.

In particular, once the percentile  $p$  is defined, the threshold ADT value, above which the amplification will be used, is automatically determined. For example, assuming  $p = 90\%$ , then the ADT of the 10% most congested links will be amplified. In other words, if the investigated link presents a ADT value that is lower than the threshold value, then the simple ratio  $ADT_i/ADT_{max}$  will taken as value of  $I_{ADT,i}$  index. Conversely, if the ADT of the investigated link is higher than the threshold one, its local

importance index will be amplified adding the following quantity:  $\frac{h}{ADT_{max}} \cdot [ADT_i - ADT_p]$ . Since

some links can present a value of the index that is higher than 1 by using this procedure, in order to get an index value that rages between 0 and 1, a maximum score equal to 1 is enforced. The ratio  $ADT_p/ADT_{max}$  is then constant once the percentile has been defined. Finally it is possible defining the *importance index* of a generic link  $i$ , that will be used to create the vulnerability ranking, using the following relation:

$I(i) = k * I_{ADT,i} + (1 - k) * I_{\Delta C,i}$  where  $k$  is the calibration coefficient. It ranges between 0 and 1, according to which of the two functions (global and local) should prevail. If  $k = 1$ , the importance will coincide with the local importance index. Conversely, if  $k = 0$ , the link importance is equal to the global link importance. If  $k=0,5$  the two functions contributes equally in the definition of the importance index. The importance index values  $I(i)$  obtained using the above described procedure are then scaled in order to obtaining an index whose values range between 0 and 1:

$$I_{norm,i} = \frac{I_i - I_{min}}{I_{max} - I_{min}} \quad \text{where } I_{min} \text{ and } I_{max} \text{ are the minimum and maximum computed importance}$$

values, respectively. The adopted procedure can be the resumed as follows:

1. definition of the generalized cost matrix for each O/D couple of the network under normal serviceability conditions. The mobility demand is assigned to the network in the normal serviceability condition (undamaged state) using an assignment algorithm; the generic element  $ij$  of the generalized cost matrix represent the total cost (which is function of the travel time, distance

travelled and, eventually, toll) for the network users that move from the origin  $i$  to destination  $j$ : this value depends on the route characteristics as well as the traffic flows on these routes (and, therefore, on how the demand is distributed in the network);

2. links are interrupted one-by-one;
3. the assignment algorithm is performed again in order to determining the new generalized cost matrix (in the damaged condition);
4. the vulnerability index of the interrupted link is computed;
5. step 2, 3 and 4 are repeated for all the links of the network for which the ADT has been provided.

The result of this analysis is a road network where all the links are characterised by a finite value of the vulnerability index.

### Exposure index computation

The exposure index has been computed by considering for two contributions. The first contribution accounts for the links flows in a predetermined time period (day). Specifically, the average daily traffic has been used, since it provides information about the number of users that would experience inconveniences due to the interruption of a link. In particular, this contribution for a generic link  $i$  has

been defined as follows:  $E_{1,i} = \frac{ADT_i}{ADT_{\max}}$ . The second contribution is defined accounting for the

unassigned demand caused by the closure of a link. In particular, it is defined as the ratio between the unassigned demand on the considered link under consideration and the maximum unassigned

demand:  $E_{2,i} = \frac{\mu_i}{\mu_{\max}}$ . This contribution is then different from zero for cut links only. A first

exposure value,  $E_i^*$  is the computed as a linear combination of the two above described contributions :  $E_i^* = m \cdot E_{1,i} + (1 - m) \cdot E_{2,i}$  where  $m$  is the calibration coefficient, which ranges between 0 and 1. If  $m = 1$ , the computed exposure values depends on the ADT only; conversely, if  $m = 0$ , the computed exposure depends on the unassigned demand only. Using these values, the exposure ranking can be built. Again obtaining a score that ranges between 0 (last link in the rank, with the lower exposure value) and 1 (top link of the rank, with the higher exposure value).

### Definition of ranking

Once the vulnerability and exposure indexes have been computed for each link of the network, in case no information regarding the probability of occurring of a certain phenomenon has not been provided, risk can be computed assuming a constant hazard value for each link of the network. In this way, we have a first classification of the links of the network. Conversely, in case detailed information that allow evaluating the risk have been provided, a more accurate ranking in which other factors such as the socioeconomical aspects as well as the mobility demand distribution are accounted in the risk evaluation can be obtained. In any case, the final result we obtain through a risk analysis provides decision-makers an index that allows prioritizing the allocation of resources in maintaining/improving the infrastructure. In order to developing the above described procedure, we decided using a software to manage the huge amount of data. In particular, we have chosen the planning software Cube, provided by Citilabs, which allows handling the simulation problem for the network of Provincia Autonoma di Bolzano in an appropriate way, allowing also the automation of the iterative procedure for determining the values of the links' importance indexes.

### Indexes computation for the network of provincia di bolzano

The analysis has been performed using the ‘multi-modal traffic model of Provincia di Bolzano’ developed by Citilabs. Its usage has been authorised by Dr. Durante, owner of the simulation model. In particular, the network graph (road network model), the O/D matrixes for both vehicles and trucks, the assignment parameters of the private traffic model, and the files for the assignment process (turn penalties, freeway tolls, BPR curves) have been provided.

## Simulation models for the analysis of the road network of province of Bolzano (Italy)

The proposed procedure for the risk evaluation have been performed using the following models:

- the *supply model*, constituted by the network model, which consists of a graph of links and cost functions for each of these links. A graph is constituted by a couple of sets: the set of nodes, which represent the spatial-temporary positions of the traffic units of the system, and the link set that provides the spatial-temporary relations between the nodes. The cost functions are defined for each link of the network and provides the generalized cost experienced by users in travelling along a certain link.
- the *demand model*, which allows estimating the movements that affect the study area in a predefined time interval. The mobility demand is represented mathematically by using the so-called origin-destination (O-D) matrix, which provides the movements between the O-D couples of the network;
- the *assignment model*, that allows representing the interaction between demand and supply models, either statically or dynamically, using a deterministic or stochastic approach. The results of the assignment model are the links flows that allow evaluating information regarding the performances and impacts of the network itself.

The models we have calibrated also allow to update the O/D matrix and to estimate the network total cost under undamaged and damaged network conditions.

## Graph of the network of Province of Bolzano (Italy)

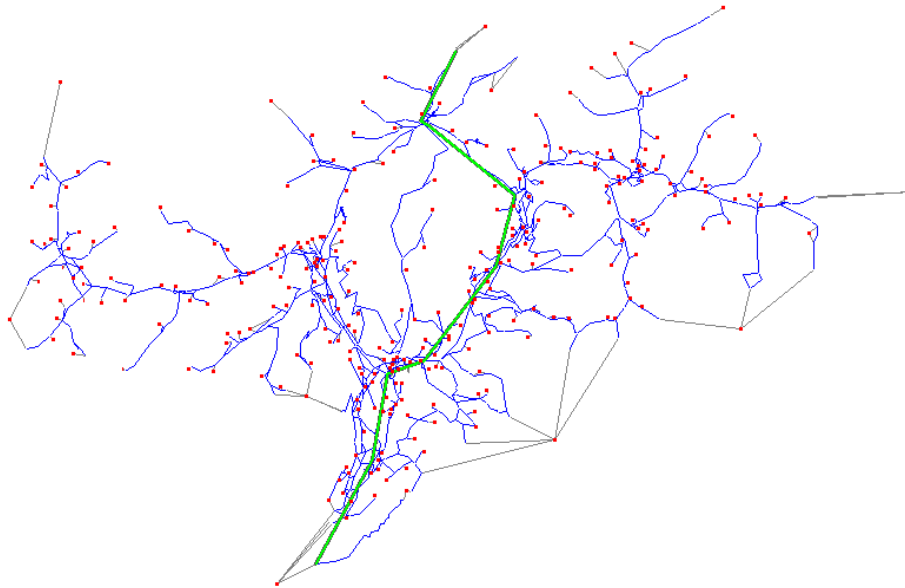
The network graph provided by Citilabs was constituted by 277 centroids, 1314 nodes (non centroids), 1581 nodes, 698 connectors, 3710 mono-directional links, 2852 road links (16 freeway links).

This graph has been updated in order to account for all the roads in the Provincia di Bolzano. Then, those links representing incoherent local connections with the aim of this study have been deleted. In particular, the following roads are represented in the graph: Freeway A22 (Autostrada del Brennero); Strade Statali n° 12, 38, 40, 41, 42, 44, 44bis, 48, 49, 51, 52, 238, 241, 242, 242dir, 243, 244, 508, 620, 621, 622; Strade Provinciali n° 8, 14, 21, 24, 25, 37, 39, 40, 52, 69, 72, 73, 77, 88, 93, 99, 101, 116, 120, 125, 165, 171, 172, 175, 176, 180.

Finally, all those links that represent other infrastructures other than roads were deleted too. The graph we have obtained is then constituted by 293 centroids, 1314 nodes (non centroids ones), 1607 nodes, 730 connectors, 3492 mono-directional links, 2762 road links (16 freeway links). The updated graph is the one represented in the following figure (freeways are highlighted in green, connectors in grey, and centroids in red). At each link of the graph information about its operational and geometrical characteristics such as the number of lanes per direction, the capacity, the free-flow speed have been associated. These information are necessary to use the corresponding cost functions. In particular, cost functions provided by Citilabs for both existing and new links were



adopted. The generalized link cost is given by the linear combination of three contributions reasonably weighted: travel time, links' length, and (just for freeways) links' toll. The investigated network is then assumed to be congested: this means that link's travel time depends on link flow.



**Figure 39 : Road network graph of the Autonomous Province of Bolzano**

At each link has been associated a separable cost function which allows evaluating the average travel time of the link as a function of its flow only:

$$t_r = t_0 \left[ 1 + \alpha \left( \frac{f}{C} \right)^\beta \right]$$

Where  $t_0$  is the travel time in free-flow conditions;  $f$  is the link flow;  $C$  is the link capacity;  $\alpha$  and  $\beta$  are calibration constants. The measured average daily traffic (ADT) was provided for 2158 links. These information were then used in determining the vulnerability and exposure indexes.

## Transport demand of Province of Bolzano (Italy)

The Provincia Autonoma di Bolzano provided us the O/D matrix regarding two hours of the average winter weekday. This matrix was referred to 277 centroids, thus counting 76729 elements. Since we performed the graph upgrading, it was necessary upgrading the O/D matrix too. Particularly, other 16 centroids were added in the matrix, thus increasing its total number of elements up to 85849. Since Provincia di Bolzano also measured flows on several links of the network, the O/D matrix has been updated through these traffic counts using the so called 'matrix estimation' procedure. In order to update the O/D matrix, it was necessary using the morning peak hour flows of the average weekday: therefore, we have used data collected during surveys.

## Assignment models

The assignment models simulates the interaction between demand and supply systems providing the links flows as output. For this study we decided using a deterministic assignment model, that is assuming the network users will perceive, for each route, the same disutility, which is equal to the average travel time. Thus, we have used the deterministic user equilibrium (DUE) model as assignment one. Adopting this model, we have assumed links costs depend on links flows and we assigned the demand  $d_{OD}$  accordingly to the first Wardrop principle, which states that 'the journey

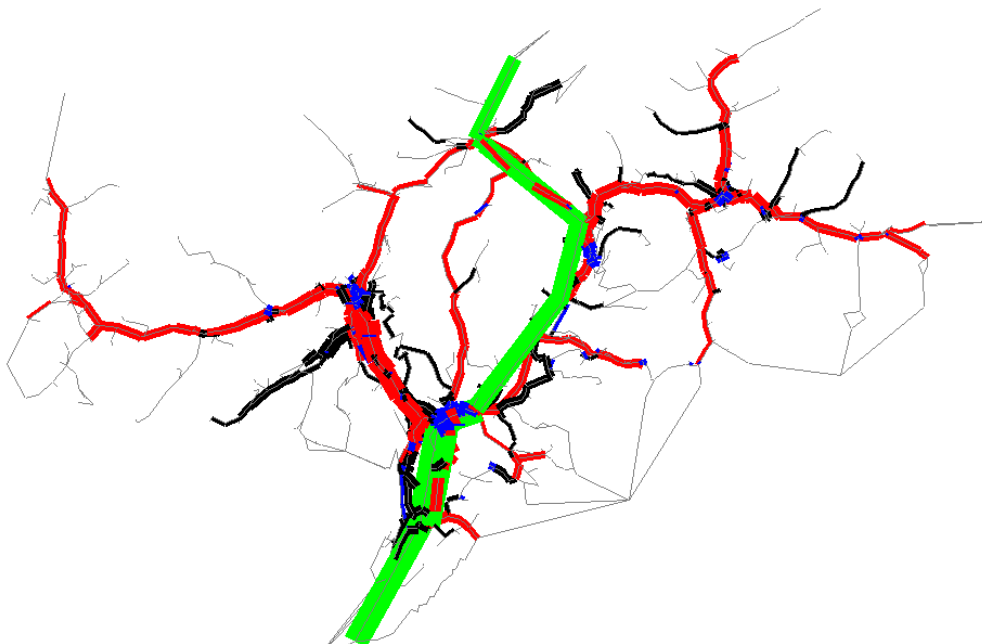
times in all routes actually used are equal and less than those which would be experienced by a single vehicle on any unused route.’ The output of the assignment model is the links flows vector. Starting from this output it is possible computing link and route travel times by using the cost functions. Therefore, we are able computing the total travel time all users of the network spent on the it performing their movements. This quantity can be used as a network indicator to compare alternative scenarios.

## Analysis methodology

The methodology we have used to evaluate the risk that regards hydro-geological instability can be resumed as follows:

1. the generalized cost matrix has been built for all the O/D centroids of the network assuming the undamaged network condition through an assignment algorithm that assign the demand to the network;
2. the roads (represented by a bidirectional link) are interrupted one-by-one;
3. the assignment algorithm is used to compute the generalized cost matrix in case link  $i$  is interrupted (damaged condition);
4. vulnerability, exposure and risk indexes of each link are computed;
5. steps 2, 3 and 4 are repeated for all the links of the network for which the ADT has been provided.

The final result is then a road network where each link is characterised by a risk value. The results we have obtained using this methodology accounts for both the accessibility as well as the effective usage level of network, estimated using the data provided by the O/D matrix. The link flows simulated in case of undamaged conditions are shown in Figure 39. As stated previously, links flows have been computed using a DUE procedure. On each link the bar width is proportional to the hourly flows. The colour of these bars identifies the road type: GREEN: freeways; RED: national roads; BLACK: road administrated by Provincia Autonoma di Bolzano (strade provinciali); BLUE and LIGHT BLUE: strade comunali principali.



**Figure 40 : Simulated flows**

Looking at the above figure, the highest flows can be found along the freeways and along those roads that run across the main valleys, whereas the rest of the network is poorly congested. This roads

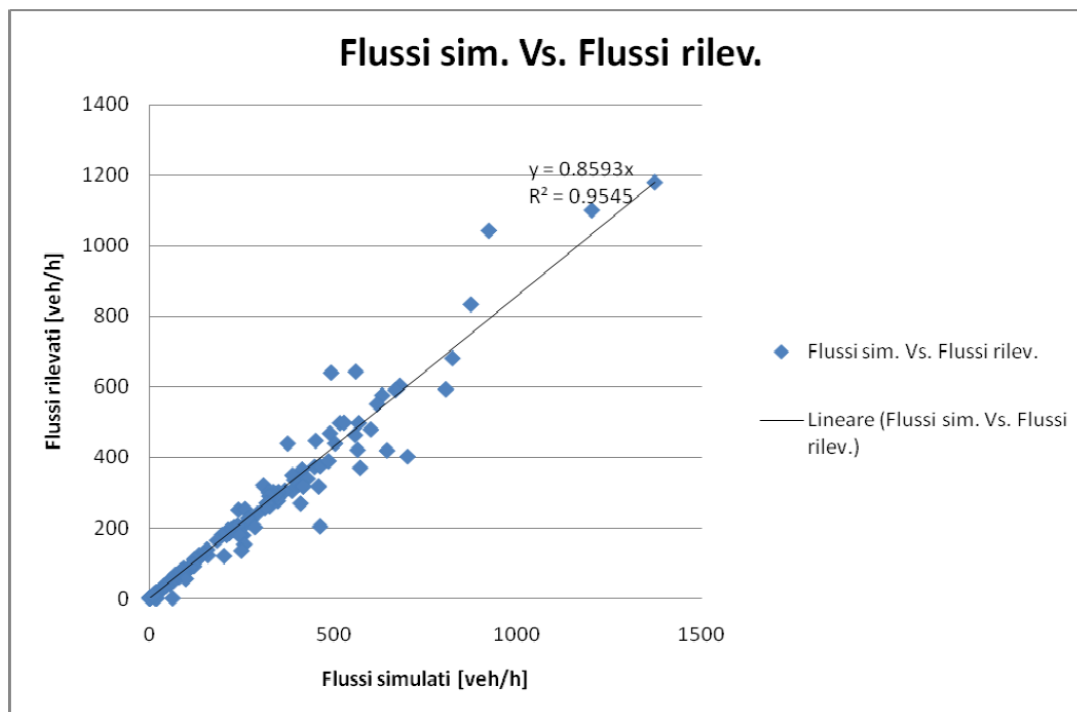
represent network's bottlenecks because of the mountainous shape of Provincia di Bolzano. In order to validate the model, that is verifying the accuracy in simulating links flows, we have computed the RMSE index comparing the simulated flows with the morning peak hour flows of a weekday in October 2010 on 163 links of the network. The measured flows have been collected from the viability portal of Provincia di Bolzano.

$RMSE = \frac{\sqrt{MSE}}{\sum_{i \in L^*} \left( \frac{f_i}{n_{L^*}} \right)}$  where  $L^*$  is the set of links where the links

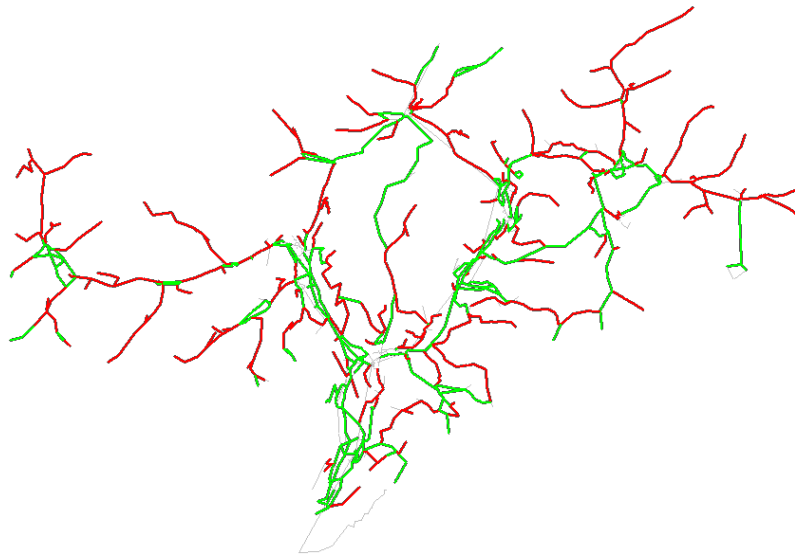
flows were measured;  $n_{L^*}$  is the number of links (164) on which the measurements were performed,

and  $MSE = \frac{\sum_{i \in L^*} (f_i^* - f_i)^2}{n_{L^*}}$  being  $f_i^*$  the simulated flow on link  $i$  and  $f_i$  the measured flow. We have

obtained an RMSE value of 22.6%. Finally, the  $R^2$  coefficient has been computed.

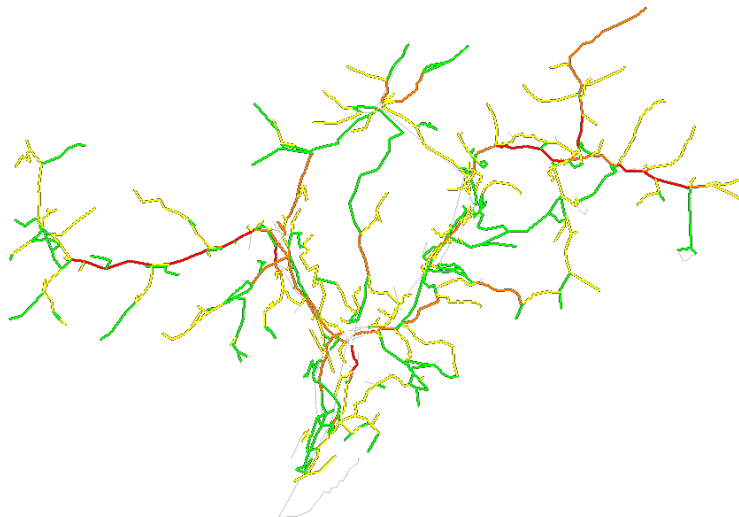


It is worth to notice that the  $R^2$  is 0,95, whereas the angular coefficient of the straight line is equal to 0,86. In conclusion, we can state that the model represents the real situation adequately. After being validated with reference to the actual situation, the models has been used to simulate the different scenarios in which the links of the network are closed one-by-one. In order to compute the vulnerability index, the Provincia Autronoma di Bolzano provided the average daily traffic (ADT) on 473 monitoring stations that involve 2158 links of the network model (since one station can refer to more than one link). In the following figures, cut links are highlighted being coloured in red whereas the non-cut ones are coloured in green. It is worth to notice that the number of cut links is equal to 1254 (58%). Referring to the monitoring stations only (473), their number reduces to 190 (40,2%).

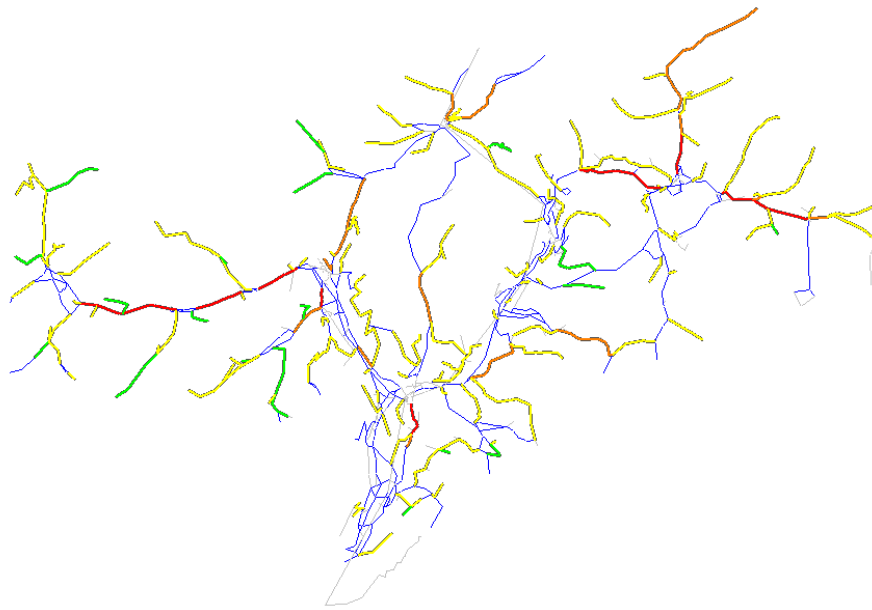


**Figure 41 : Riskcut links (in red) versus non-cut links (green)**

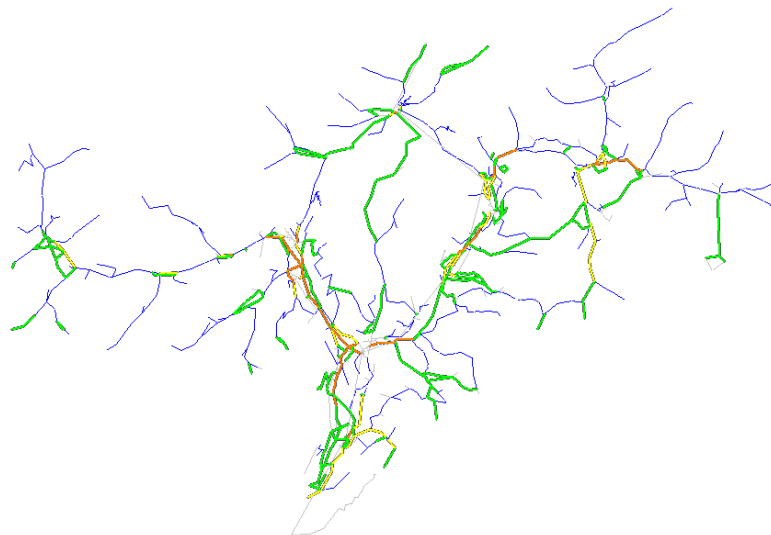
In the following figure (Figure 42), the links are coloured accordingly to the value of the vulnerability index that has been computed assuming the percentile  $p$  equal to 75%, the amplification coefficient  $h$  equal to 2, and  $k$  equal to 0,5. Four vulnerability classes has been identified: red: vulnerability  $> 0,75$ ; orange: vulnerability  $> 0,50$ ; yellow: vulnerability  $> 0,25$ ; green: vulnerability  $< 0,25$ . It is worth to notice that (see next figure) the more vulnerable roads are also cut links. They often represent the only path to go from a certain origin  $O$  to a destination  $D$ . This is why their vulnerability, that is the damage caused by their closure, is so high. Moreover, in the top 20 of the link vulnerability ranking the first 19 are cut links. This is due to the fact that their interruption does not ensure the assignment of the entire demand, thus producing unassigned demand.



**Figure 42 : RiskVulnerability of the road network of Provincia Autonoma di Bolzano**



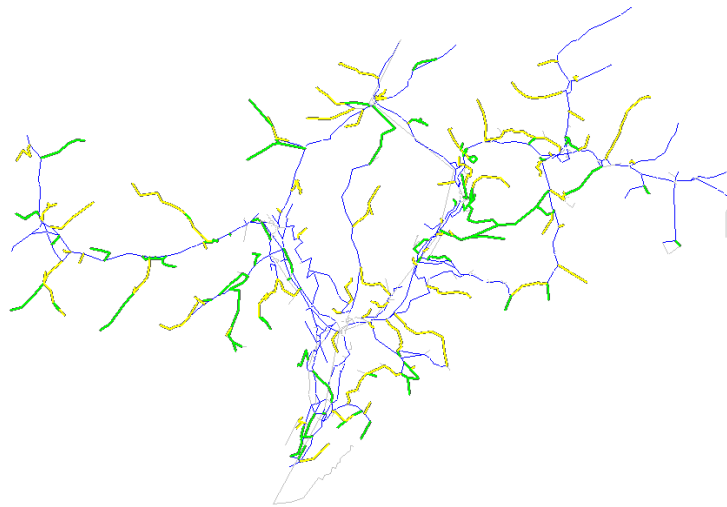
**Figure 43 : RiskCut links vulnerability**



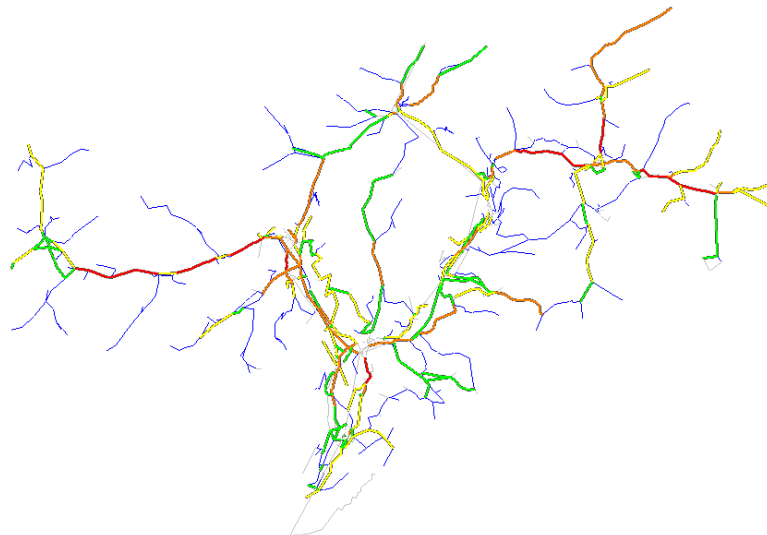
**Figure 44 : RiskNon-cut links vulnerability**

It is also interesting to analyse the distribution of the vulnerability index in relation to the 50<sup>th</sup> percentile of the measured ADT.



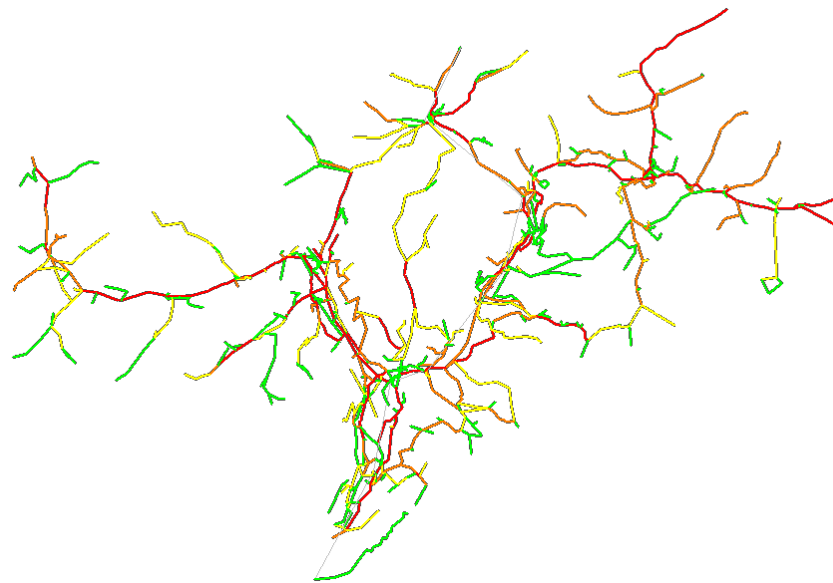


**Figure 45 : RiskVulnerability of those links whose ADT is lower than the 50<sup>th</sup> percentile**



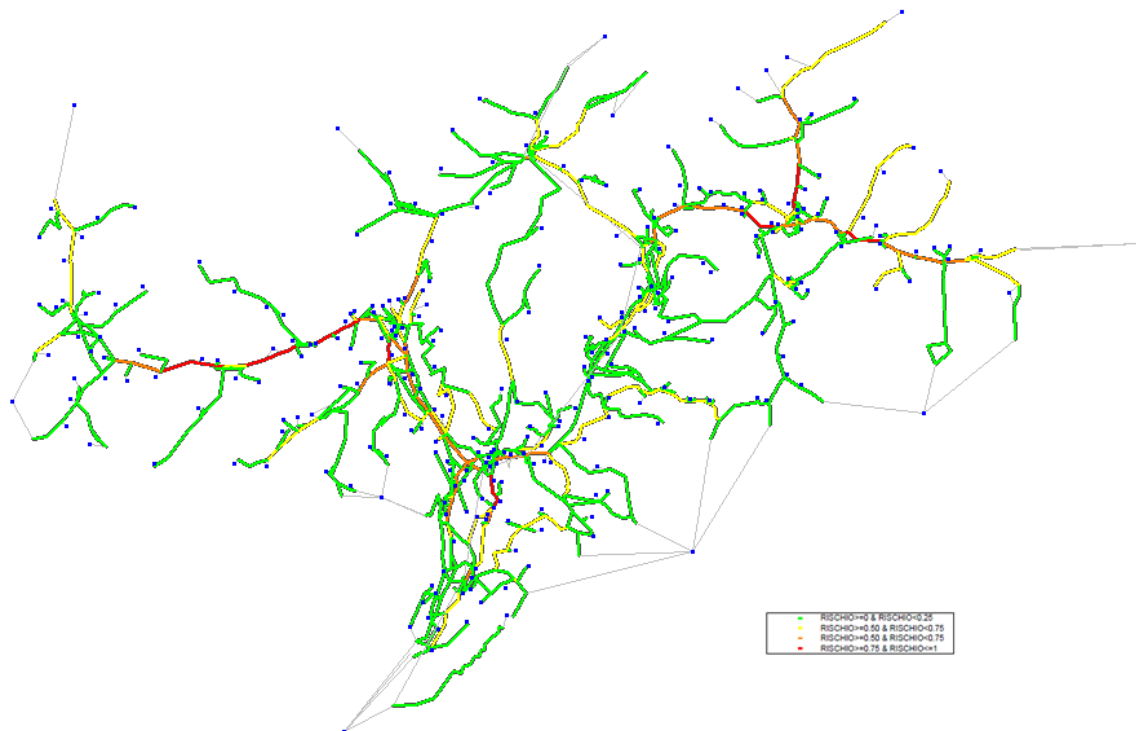
**Figure 46 : RiskVulnerability of those links whose ADT is higher than the 50<sup>th</sup> percentile**

It is worth to notice that the most vulnerable links (red and orange) are characterised by a measured ADT higher than the 50<sup>th</sup> percentile (1079 veh/day). In the next figure, links are coloured on the base of their exposure index value: red: exposure > 0,75; orange: exposure > 0,50; yellow: exposure > 0,25; green: exposure < 0,25.



**Figure 47 : RiskExposure of the road network of Provincia Autonoma di Bolzano**

In the last figure (Figure 48) is the represented the risk, computed assuming the hazard to be constant (and equal to 1 for each link of the network) of each element of the network. At each link has been associated a level of risk identified by a colour: GREEN: low risk, between 0 and 0,25; YELLOW: low-medium risk, between 0,25 and 0,5; ORANGE: medium-high risk, between 0,5 and 0,75; RED: high risk, between 0,75 and 1.



**Figure 48 : Risk of the road network of Provincia Autonoma di Bolzano**

Moreover, the definition of the risk we have introduced can be thought as ‘user’s risk’ since the infrastructure’s exposure, which is a measure of the value of the considered element of the infrastructure has been assumed equal to 1 for each link of the network. The computed risk thus

provides a measure of the losses (increase in travel time, accessibility decreasing, etc.) users experiences because of the closure of a link (or a group of links). These results are derived into exposure and vulnerability maps that are combined afterwards with hazard maps.

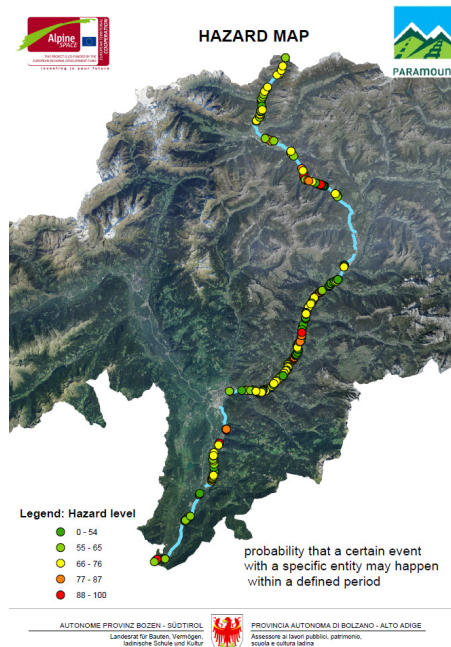


Figure 49 : Network hazard maps (Serv. Geol. Bolzano)

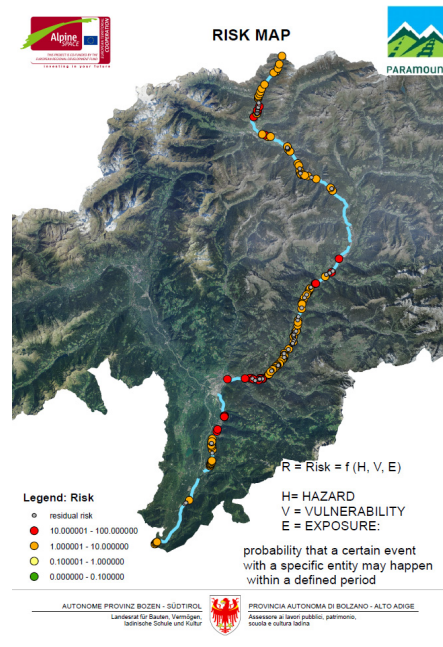


Figure 50 : Risk maps based on network analysis (Serv. Geol. Bolzano)

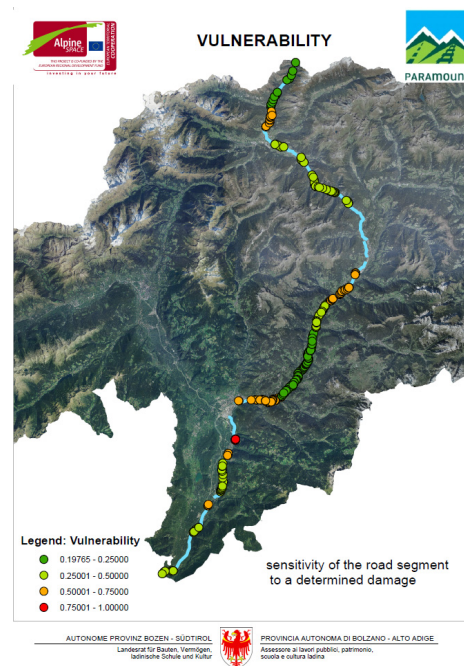
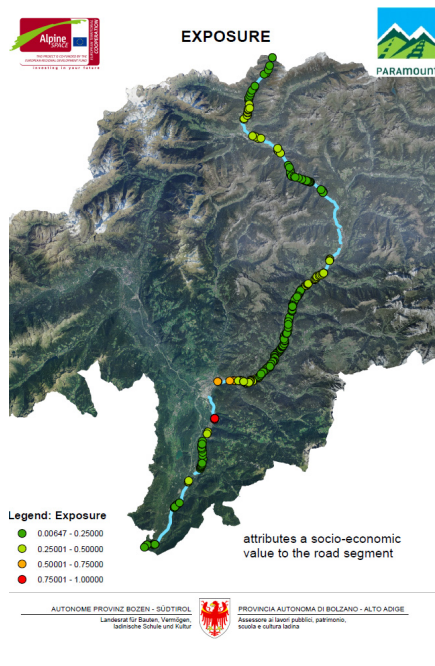


Figure 51 : Exposure and vulnerability maps (Serv. Geol. Bolzano)

## Development of specific information systems dedicated to natural hazards

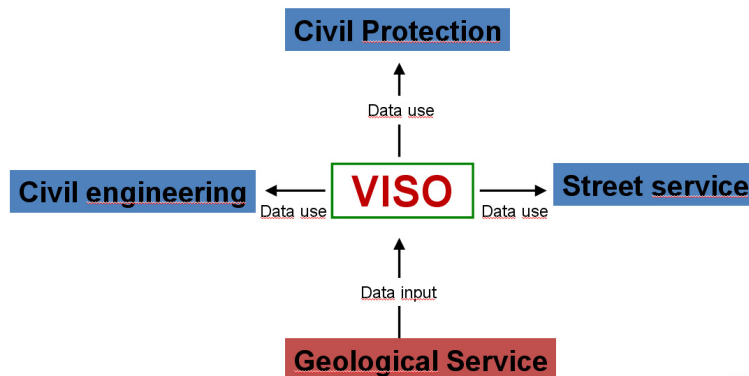
This section has been written and verified by Verena Larcher, Volkmar Mair and Claudia Stradia (Geological Service of Bolzano Province, Bolzano, Italy).

Aufüstung	N. Straße	Straßenname	ausgewählte Abschnitt
1	SS 241	Eggental und Karerpaß	1+200 - 7+500
2	SS 508	Samtalerstraße	3+000 - 7+800
	SS 508	Samtalerstraße	7+690 - 7+780
	SS 508	Samtalerstraße	8+700 - 8+790
	SS 508	Samtalerstraße	8+550 - 8+700
3	LS 24	Blumau - Waidbruck	0+815 - 1+130
	LS 24	Blumau - Waidbruck	1+220 - 1+250
	LS 24	Blumau - Waidbruck	2+000 - 2+190
	LS 24	Blumau - Waidbruck	3+340 - 3+690
	LS 24	Blumau - Waidbruck	4+525 - 4+620
4	LS 24	Blumau - Waidbruck	20+880 - 21+200
5	SS 42	Tonale und Mendelpass	223+100 - 224+200
6	LS 149	Meransen	3+070 - 3+200
	LS 149	Meransen	4+900 - 5+130
	LS 149	Meransen	5+160 - 5+300
	LS 149	Meransen	1+551 - 1+786
	LS 149	Meransen	2+321.2+380
	LS 149	Meransen	3+530 - 4+830

In the last years the Department of Public Work of the Autonomous Province of Bolzano moved his attention in natural hazard management, meaning rock all an other mass movements, from an intervention policy, which includes reparation at the moment of an occurred event, to a prevention policy in treating the planning procedure for interventions for risk mitigation through a priority list of intervention.

**Table 1 : Priority list of intervention**

In this way, risk is defined on three different levels: short-termed (urgency interventions), intermediate-termed (monitoring), and long-termed interventions (priority list of intervention). As an autonomous province, South Tyrol manages and maintains not only the provincial roads but also national roads, which often are heavily trafficked. The Office of Geology in the Province of Bolzano takes more the role of a consulting institution. In fact, by collecting technical data from rockfall events or rockfall affected areas we are able to give suggestions to the decision-makers, which is the provincial Road Service.



**Figure 52: Schematic working process of VISO database**

The need of prevention acts against rock fall on road infrastructures in the Province of Bolzano induced the Road Service together with the Geological Service and the Department of Informatics to develop a system in order to investigate and catalogue rock fall protection measures and to evaluate the hazard on a stretch of a road. So the so called V.I.S.O. project (Viability Information System) was developed. V.I.S.O. consists of two main parts: an alphanumeric (VISO application) and a geometric database (SDE strata). VISO offers a module with a standardized interface and provides at the same time not only a connection to the GIS-system but also to the databases Oracle and the Microsoft Access archives. The V.I.S.O. tool offers the surveyor a way to quickly detect the hazard due to landslide or toppling phenomena that characterizes a slope adjacent to the stretch of a road. It also allows creating a priority list of intervention (new investments) and maintenance based on fundamental parameters like the hazard (in future the risk) level of the slope. The development of a tool to link an index of vulnerability and exposition to every segment of the road network and finally to calculate the risk is still ongoing in collaboration with the University of Bologna DICAM (Department of infrastructure engineering).

#### SLOPE HAZARD LEVEL

The procedure to define the specific hazard level is based on the detection of 7 fundamental parameters: intensity of the landslide phenomenon, probability for the phenomenon to occur at the same point again, hazard level of the slope without protection systems, general situation of protection systems, hazard level of the slope supplied with protection systems, vulnerability of the road segment, specific risk of the road segment.

These parameters need field work to define three major points:

- Survey of the position (GPS or classical topographic methods) and of the characteristics of the protection system(s); this implies the identification of the type of protection measure and the determination of their geometrical features.
- Detection of the intensity of the rock fall events that may occur on the slope and by assessing specific damping factors. The intensity of the event (G.E.I. - geological event intensity) is given by the sum of the following parameters: single block volume, greatest volume to be mobilized, state of decompression of the slope and structural situation of the rock face (orientation and spacing of discontinuities). The damping factors (S.C. - Slope Coefficient) are assigned through the definition of the slope angle, the morphology and the rebound of the slope, as well as the type and density of vegetation.
- Survey of functional characteristics of the protection system; this includes its conservation state, its efficacy and its proper positioning related to the intensity and the geometry of the phenomena that may develop on the slope as defined in the previous step.

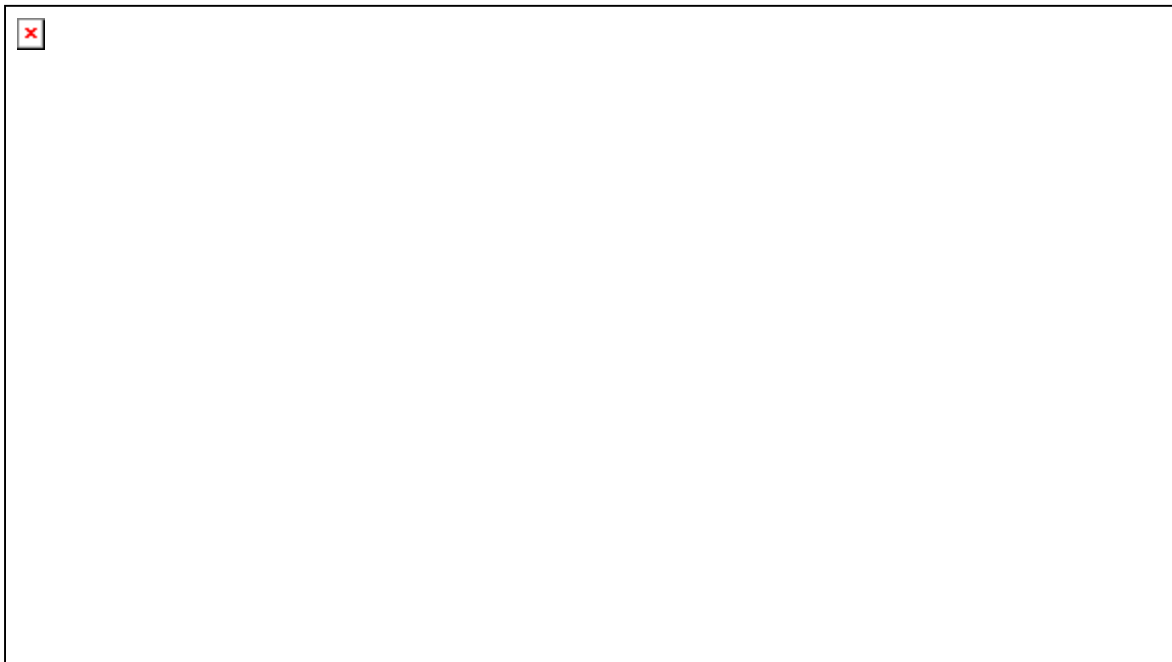
The assessment of the hazard level to a slope segment without protection systems is fundamentally based on the intensity of the phenomenon (S.E.I. slope event intensity), given by the sum of G.E.I. and S.C. parameters, and the probability of occurrence. The calculation of the probability of occurrence for the V.I.S.O. method is based on the counting of every rock fall event (records of surveys, and/or technical reports archived at the Office for Geology and building materials testing of the Autonomous Province of Bolzano/Bozen) within the maximum time span of monitoring available (from 1998 onwards). The error bars depend clearly on the quality of event detection and the period of monitoring. The assessment of the hazard level to a slope segment with protection systems is given by crossing the hazard value for the slope without protection systems and the evaluation of the examined protection system.

#### THE ATTRIBUTION OF A HAZARD LEVEL TO A ROAD SEGMENT

A road at the base of a slope is affected by the hazards above which depend on the slope event intensity and the state of the protection systems as shown above. To calculate the hazard for a



specific road sector, the arterial roads are subdivided into segments of homogeneous hazard level in this way: first the slope is divided into areas with the same slope event intensity (S.E.I.). In the next step these portions of slope are intersected with the present protection system. Where there are no protections, the slope hazard is attributed directly to the road segment. Where protections are present, the remaining hazard below all protection system lines is attributed to the road segment below.



**Figure 53: Hazard level referred to a road segment**

To simplify the different GIS operations and statistical calculations every road segment is represented by its median point which gets all information of the entire segment.

#### DRAFT OF INTERVENTION PRIORITY LIST

To attribute to every median point a priority of intervention, it is necessary to assign a numeric value at every point in the matrix slope event intensity (S.E.I.), vs. the probability of occurrence (Tr). This is made by the formula  $P = \alpha \cdot S.E.I. \cdot Tr$ , where  $\alpha$  is a value that defines the functional characteristics of the protection systems. It varies from -33.33 in the case, where the protection is best, to 0 where the structures are not present or have no effect to + 11.11, where the protection does even aggravate the situation.

After that every specific segment of an arterial road has an index of intervention priority. This index allows to elaborate a maintenance plan of the protections, to schedule extraordinary repairs of protection systems and to target new mitigation measures.

## 5 Development of advanced methodologies for decision support

### 5.1 Advanced Multi-criteria decision-making methods (MCDM) considering information imperfection

This section has been written and verified by Jean-Marc Tacnet (Irstea, Snow Avalanche Engineering and Torrent Control Research Unit, Grenoble, France).

#### Global methodology to describe the decision context

The risk management process is also a complex decision process involving several actors in the different temporal steps [Tacnet et al., 2010c] [Tacnet, 2009] (Figure 54).

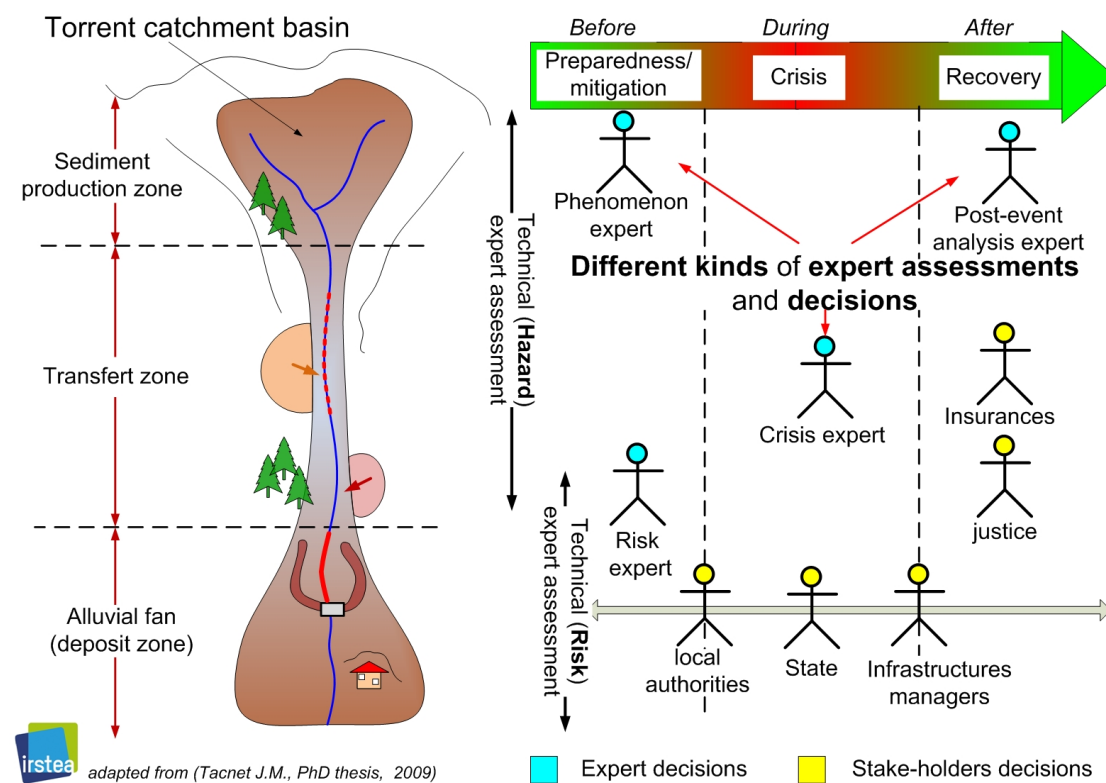
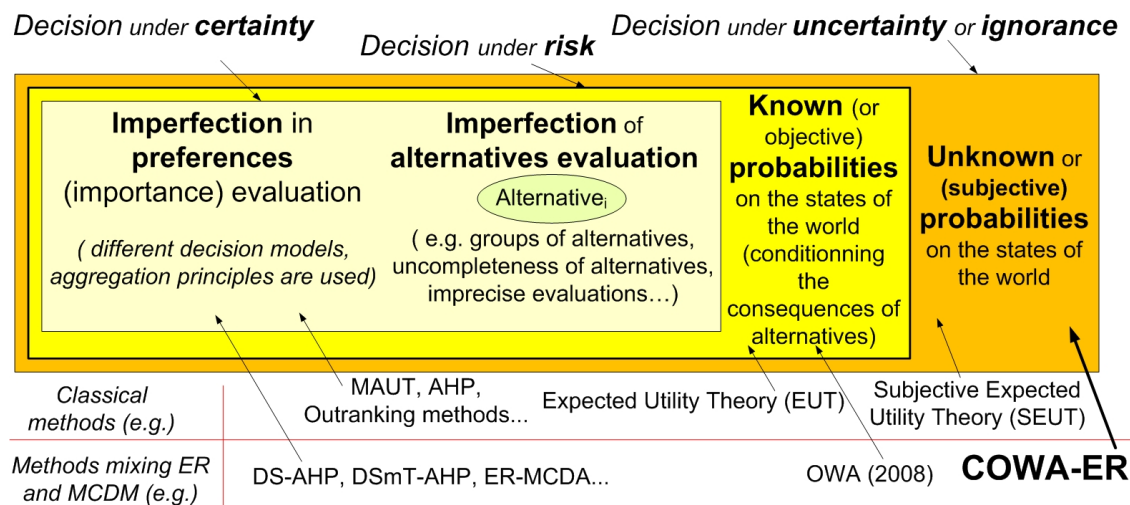


Figure 54 : Different levels, steps and actors of risk management decisions on a local scale

#### Advanced MCDM methods to consider information imperfection

Several methods have been implemented in order to consider information imperfection [Tacnet and Dezert, 2012] into either total aggregation methods such as AHP (ER-MCDA)[Tacnet et al., 2010a] [Tacnet et al., 2011b], partial aggregation method such as Electre outranking method (see Soft

Electre Tri in [Dezert and Tacnet, 2012]) for decisions in certain but also certain or uncertain contexts (see COWA-ER in [Tacnet and Dezert, 2011])(Figure 55).



**Figure 55 : New methods for MCDM under uncertainty and information imperfection [Tacnet and Dezert, 2012]**

We present here an example of an advanced multi-criteria decision-making method that handles information imperfection resulting from different sources. This approach is used to improve the expert assessment process.

Expert assessment is here considered a decision process based on imperfect information provided by more or less heterogeneous, reliable, and conflicting sources.

Evidential reasoning and multi-criteria decision analysis (ER-MCDA) is a new methodology mixing the analytic hierarchy process (AHP), a multi-criteria decision analysis (MCDA) method, fuzzy sets, possibility theory, and information fusion using the belief function [Tacnet, 2009][Tacnet et al., 2009] [Tacnet et al., 2010a].

First, a simplified application is described. Secondly, we describe the method’s overall principle and the four main steps.

**Step 1: Analytical Hierarchy Process used to describe the decision problem**

A simplified model is designed to assess the sensitivity of a avalanche site (Figure 56). It is used to show how multi-criteria decision analysis principles and information fusion can be used to characterise and take information quality or imperfection into account for decision-making purposes. The principle is to evaluate the sensitivity of an avalanche site according to the main criteria denoted as hazard (morphology, history, and snow climatology) and vulnerability (permanent winter occupants, dwellings, and infrastructures).

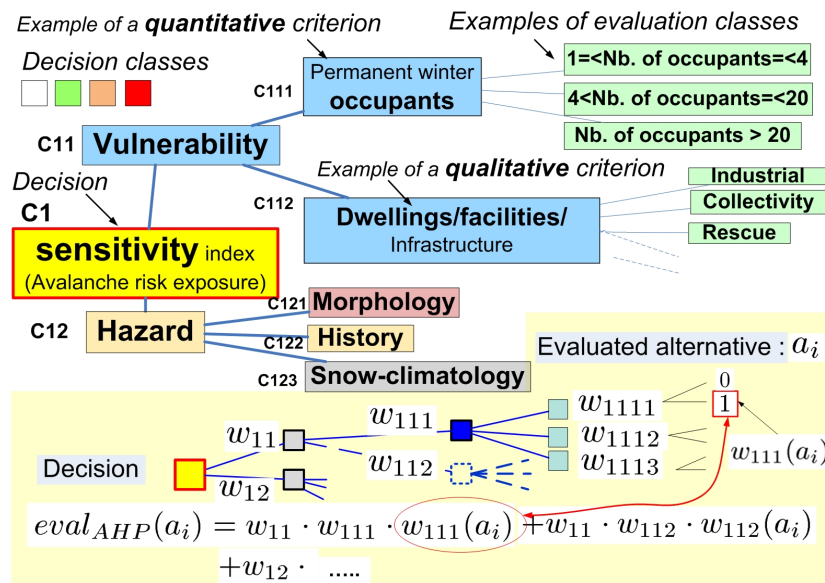


Figure 56: Simplified decision-making problem

The first step consists in describing the decision-making problem including identifying qualitative and quantitative decision criteria and assessing the dimensions of the event. The decision hypotheses (e.g., a site's sensitivity levels) are used to define the common frame of discernment (the set of possible categories of assignment of the different studied sites) that will be used for information fusion: low, medium, and high sensitivity (Figure 56).

## Step 2: Imprecise evaluation

Quantitative criteria are evaluated through possibility distributions representing both imprecision and uncertainty (Figure 57). The source (an expert) provides evaluations as intervals, e.g., criterion  $C_{111}$  corresponding to the number of permanent winter occupants: A represents the proposition 'x in [8,15]'.  $N(A)=0.75$  represents the certainty level (confidence) in the proposition 'x in [8,15]' (Figure 57).

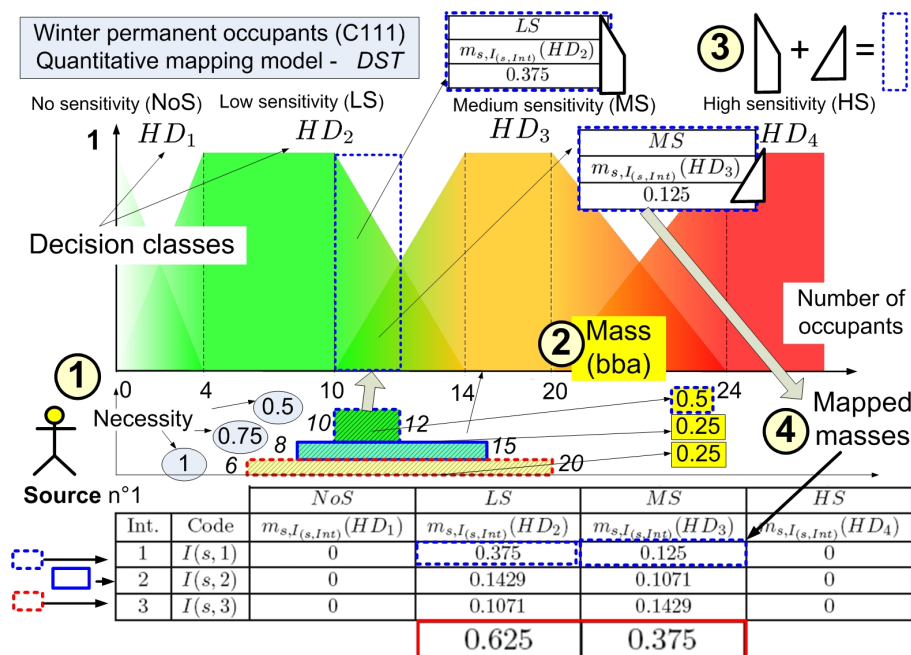


Figure 57: The source provides an imprecise evaluation that is mapped into the frame of discernment for making a decision. The steps are numbered from 1 to 4.

### Step 3: Mapping and fusion of expert assessment of criteria

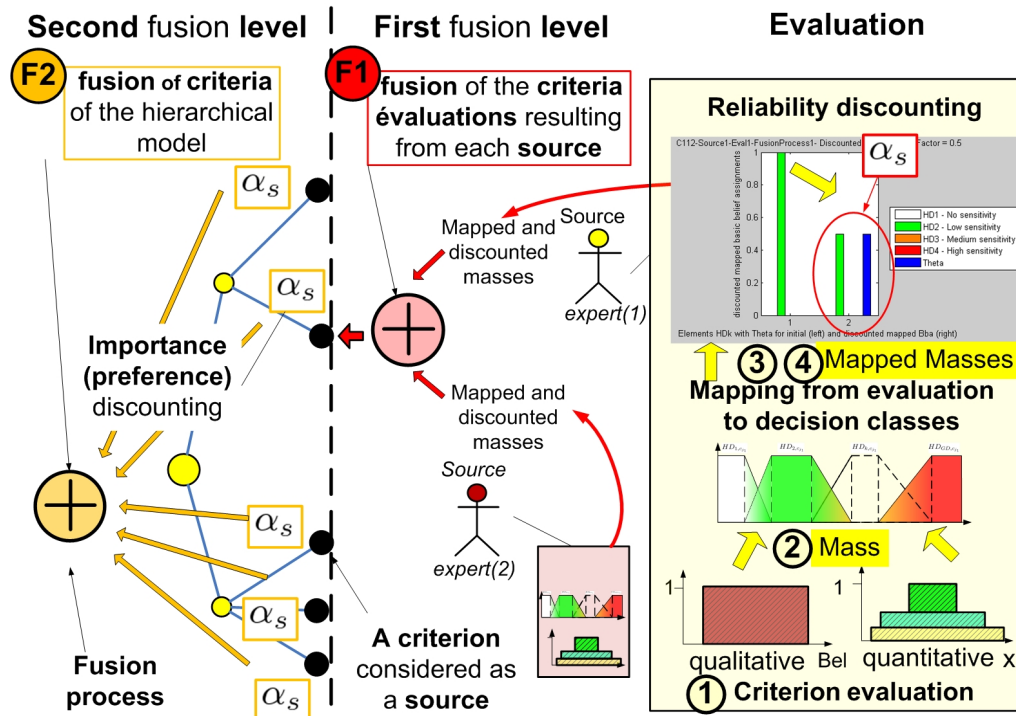


Figure 58 : Criteria are considered to be sources in the second step of fusion – adapted from (Tacnet et al.,2010a).

A mapping model based on fuzzy intervals L-R links a criterion evaluation and the decision classes (low, medium, high). For each evaluation of a criterion by one source, each interval of the possibility distribution is mapped onto the so-called common frame of discernment of the decision according to surface ratios (Figure 58). At the end of the mapping process, all the criterion evaluations provided by each source are transformed into BBAs according the common frame of discernment of decision: these BBAs are then fused into a two-step process.

### Step 4: Decision – interpretation

The results of fusion have to be interpreted to decide which sensitivity level will be chosen (no sensitivity, NoS; low sensitivity, LS; medium sensitivity, MS; high sensitivity; HS) according either to the maximum basic belief assignments, credibility (pessimistic decision), plausibility (optimistic decision), or pignistic probability (compromise). In comparison with classical decision-aid methods, the ER-MCDA methodology therefore produces a comparative decision profile in which decision classes (elements of the frame of discernment) can be compared to each other (Figure 59). The quality of information leading to the decision is related to the decision itself.



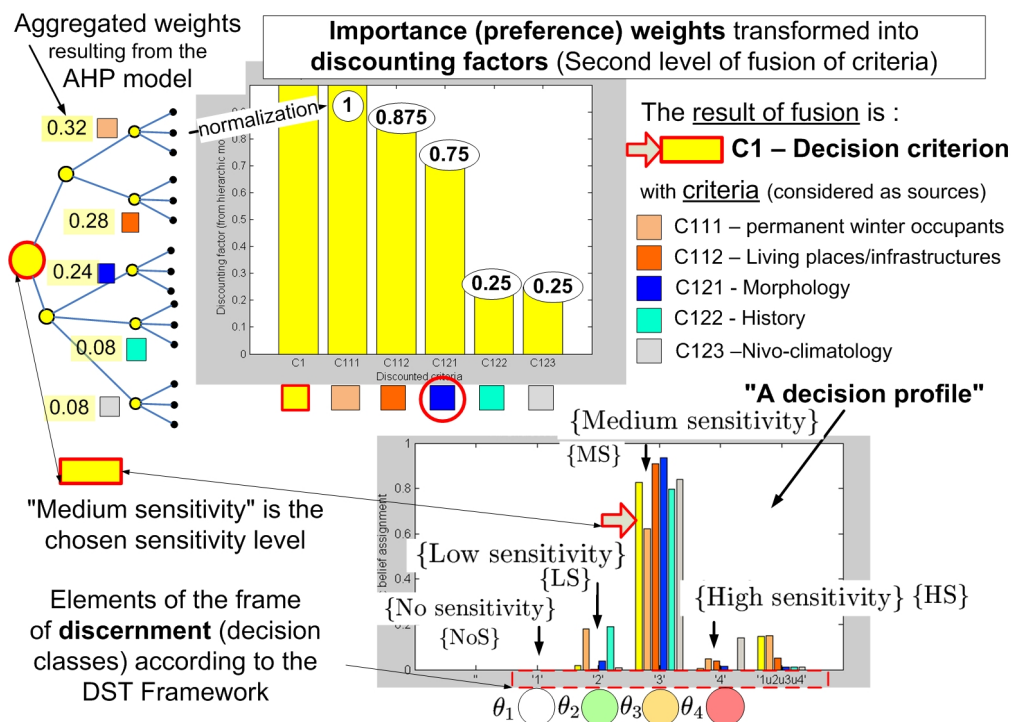


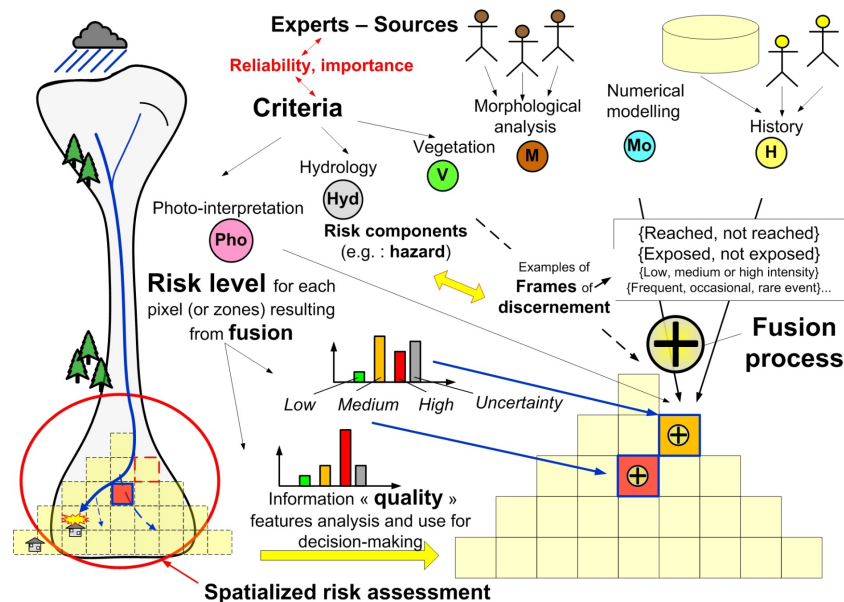
Figure 59 : A sensitivity level can be chosen according a decision profile: adapted from (Tacnet et al.,2010a)

## 5.2 An innovative information fusion process to consider information quality and heterogeneous information sources

Making the best decision in the event of a torrential floods encounters problems in the assessment and management process because of the lack of information and knowledge on natural phenomena and the heterogeneity and reliability of the information sources available (historical data, field measurements, and expert assessments). Many information sources such as historical data, expert assessments, numerical modelling results are used to take a decision about the hazard level. Decisions are therefore often based on imperfect information (uncertain, imprecise, incomplete, conflicting) provided by multiple and heterogeneous sources (numerical models, expert assessments, G.I.S). One major goal today is therefore to aid decision-making while considering quality, quantity, and reliability of the available information (Figure 60).

An important issue consists in determining risk limits in zoning maps applications: how far can we be confident in expertise results and take a decision when both spatial extents, intensity and consequences of the phenomena may be assessed imprecisely? Expert assessments are based on quantitative, qualitative but also spatial description of natural phenomena. Due to partial knowledge and variable reliability of the sources, available information about natural phenomena often remains imperfect. This can lead to many imperfect experts evaluations such as: 'we are certain that this avalanche or torrential flood has reached this point, area ...' or 'it is possible that the flood deposit was between 1.5 m and 2.5m ...'. An expert can also estimate that 'the debris flow volume is up to 15000 m<sup>3</sup>' but we know that he is not fully reliable (a beginner, expertise conditions)... Expert assessment process can be considered as a decision problem based on imperfect and heterogeneous information provided by more or less reliable and possibly conflicting sources. Ad-hoc and specific

decision support systems are therefore needed to help decisions in this context of imperfect information. To be efficient, they have to take into account and trace information quality, including attribute and spatial values, in the global risk assessment decision process. A specific methodology has been proposed to fuse together imperfect information received from more or less reliable sources in order to make a decision [Tacnet et al., 2010e].



**Figure 60: Risk level results from fusion of imperfect information provided by heterogeneous and more or less reliable sources**

Information fusion and uncertainty theories are used to gather information (Figure 32). Fuzzy Sets [Zadeh, 1965], Possibility [Zadeh, 1978] [Dubois and Prade, 1988] and Belief Function theories are able to consider altogether all kinds of information imperfections such as vagueness, imprecision, conflict and uncertainty. Our methodology extends the ER-MCDA approach (Evidential Reasoning and Multi-criteria Decision Analysis) [Tacnet et al., 2010a] to spatial information with an application to natural risks management problems as proposed in [Tacnet et al., 2009] [Tacnet, 2009]. The new methodology presented in this paper allows to consider in the same framework both uncertainty and imprecision of the spatial extent of information (e.g. debris flows, avalanche extent) but also its attribute values such as quantitative values (height, speed, volume,...) or qualitative indexes (reached, not reached ...). Imperfect information (spatial extent and/or attribute values) are first represented in a G.I.S (Geographic Information System). For example, we aim to determine an hazard level using the extent and intensity of a debris flows event. Information comes from sources such as an historical database (imprecise, not fully reliable), expert field analysis (based on an expert judgment) or numerical modelling results (whose uncertainty depend on input data quality). Information is represented through vector and raster approaches. Geographic information (spatial and attribute values) are processed to be introduced in fusion calculation routines using the Dempster-Shafer theory (DST) [Shafer, 1976] and the Dezert-Smarandache Theory (DSmT) [Dezert and Smarandache, 2009]. Advanced fusion rules (PCR rules, partial conflict redistribution rules) [Dezert and Smarandache, 2006] are used instead of the classic Dempster fusion rule to take decisions. At the end, we can spatially represent not only hazard (or risk) level but also a confidence level based on the information quality used to take decisions (Figure 61).

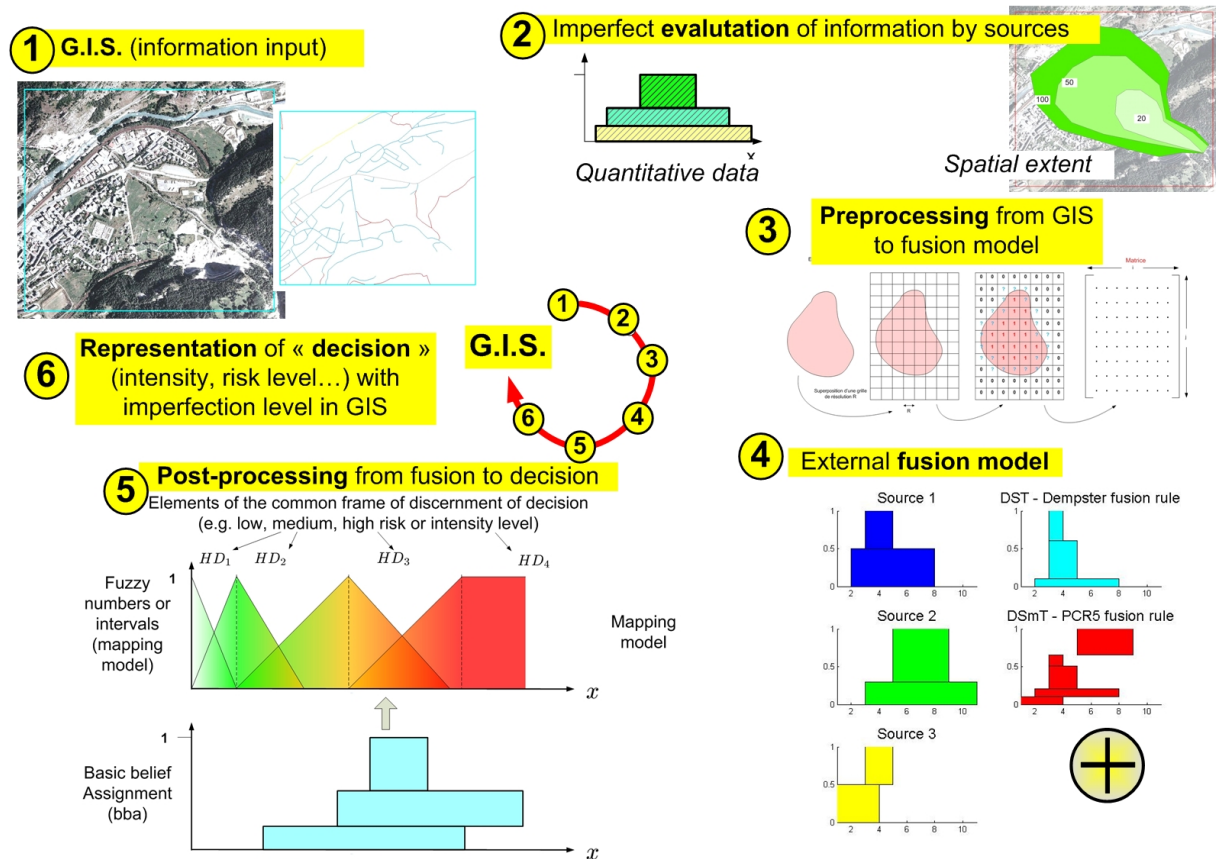


Figure 61: Principles of the Spatial ER-MCDA methodology

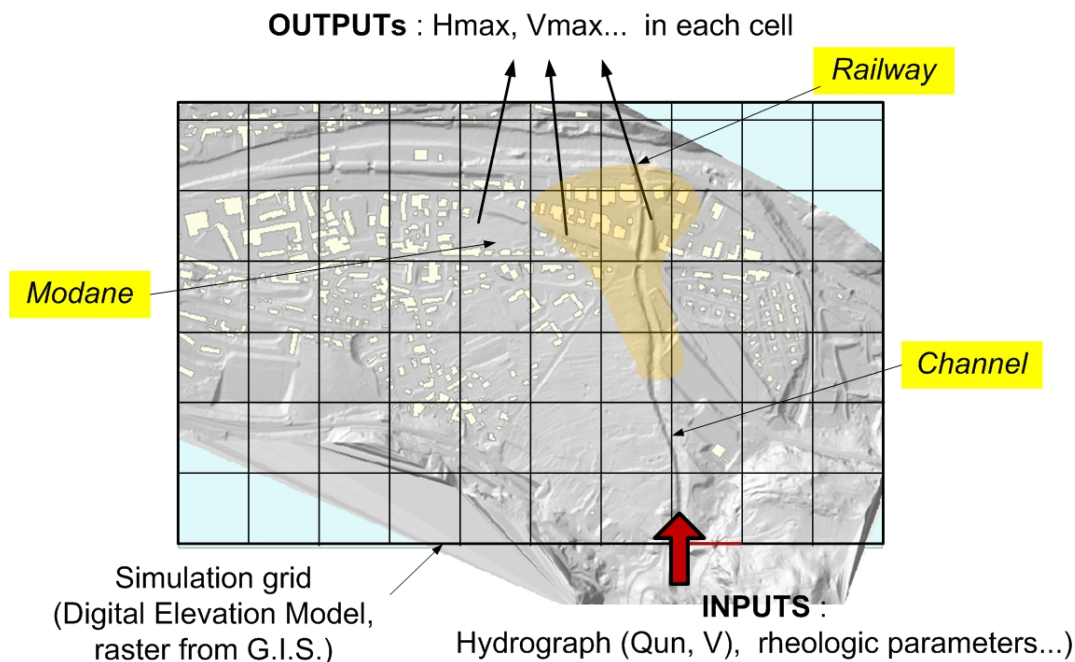
### 5.3 How far can we be confident in numerical modelling results? An innovative information imperfection propagation hybrid process

#### Objectives and principles of uncertainty analysis

Natural phenomena in mountains put people and assets at risk. Risk level is often described as a combination of hazard and vulnerability. Hazard relates to the intensity and frequency of phenomena while vulnerability concerns damages and values assessment. Numerical modelling results are essential data to assess hazard but also to evaluate the effectiveness of protection works such as dams, dykes... The problematic is here to take into account more faithfully the information quality in the global hazard assessment process. The main goal is to propagate the uncertainty resulting from input data through a numerical simulation model of debris flows based on a 'hybrid' approach using both probability, possibility and belief function theories to represent imprecision and imperfection.

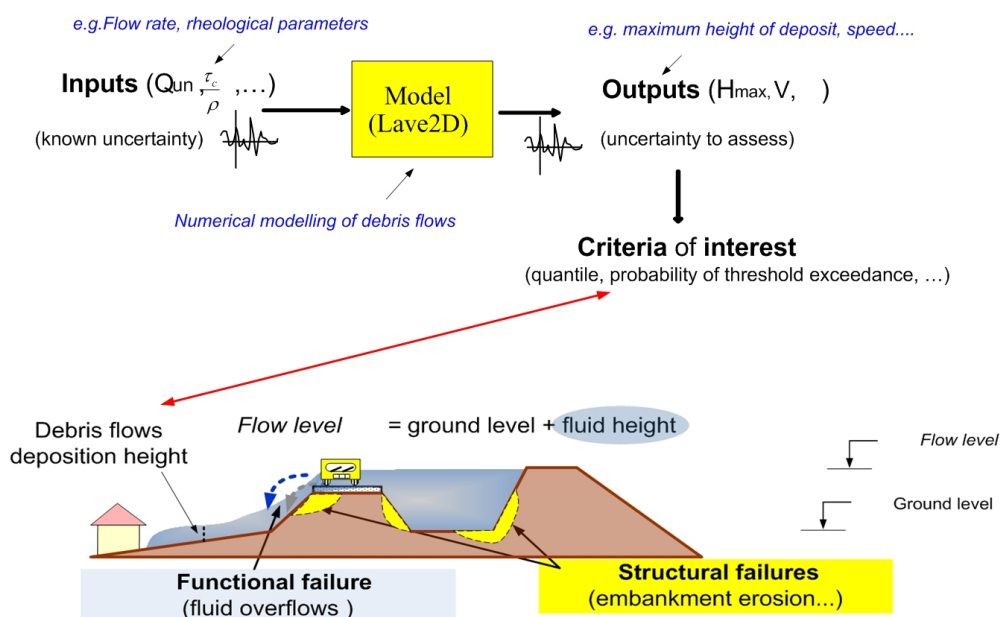
In the debris flows context, numerical models are used to assess height, speed and extent of flow. The lave2D model [Laigle et al., 2003] is able to model the extension of debris flows described by its rheological features, its input volume, the debris flows hydrograph and the local topography (Figure 62). One important issue is to consider the influence of input data imperfection on simulation

results: A new method has been developed [Dupouy et al., 2012] and used in the context of a torrent test bed . This new ‘Hybrid’ approach propagates the uncertainty through numerical simulation models and considers the different aspects of information imperfection, especially its imprecision (lack of information, inaccuracy of measure...). This method generalizes, under some restrictive conditions, the usual Monte Carlo method, by using probability, possibility and belief function theories, used as tools for coding sets of probability densities.



**Figure 62: Input and output data of lave2D: a numerical model to simulate muddy debris flows (Dupouy et al., 2012)**

One propagates the known uncertainty concerning the input variables through the model, assessing the uncertainty of the output variables (Figure 63).



**Figure 63: Principle of uncertainty analysis applied to debris flows numerical modelling: functional failures are analysed through specific criteria of interest (Dupouy et al., 2012)**



## Representation of imperfect information

Thus, the main issue is to assess at best, and as objectively as possible, the input uncertainty and its influence on results. In most usual uncertainty analysis approaches, probability Monte Carlo method is used through density function based on statistical samples. Unfortunately, due to partial knowledge and data, available information about input parameters remains imperfect and often comes from imprecise sources. This can correspond to assertions resulting from expert judgment such : ‘we are certain that this debris flows torrential flood has reached this point... ‘, ‘ it is possible that the volume will be between 20000 and 25000 m<sup>3</sup>... ‘. In that case, the choice of a probability density function presupposes, in case of imprecise variables, that one adds some information and makes a bet on the real distribution. To consider the different aspects of information imperfection, especially its imprecision, the ‘Hybrid’ method [Baudrit, 2005] [Baudrit et al., 2005] [Chojnacki et al., 2009] of uncertainty analysis has been proposed: this methodology generalizes, under some restrictive conditions, the usual Monte Carlo method, by using the theories previously described: probability theory, possibility theory and belief function theory, used as practical tools for coding some imprecise probabilities [Dubois et al., 2000].

Probability theory is the most usual and successfully completed framework to represent uncertainty. In uncertainty analysis, Monte Carlo method refers to this theory, by assessing for each input of the model, an unique density function based (ideally) on statistical samples. Unfortunately, due to partial knowledge and data, available information about input parameters remain imperfect and often come from imprecise sources (expert judgment, lack of knowledge ...). In this case, one usually chooses an unique density function among all those that don’t contradict the available information. Nevertheless, that presupposes, for most imprecise variables, that one adds some information and makes a bet on the real distribution. Different choices for the same variable’s uncertainty will lead to different outputs, and thus influence the decision without being clearly known by the decision-maker (Dupouy et al., 2012).

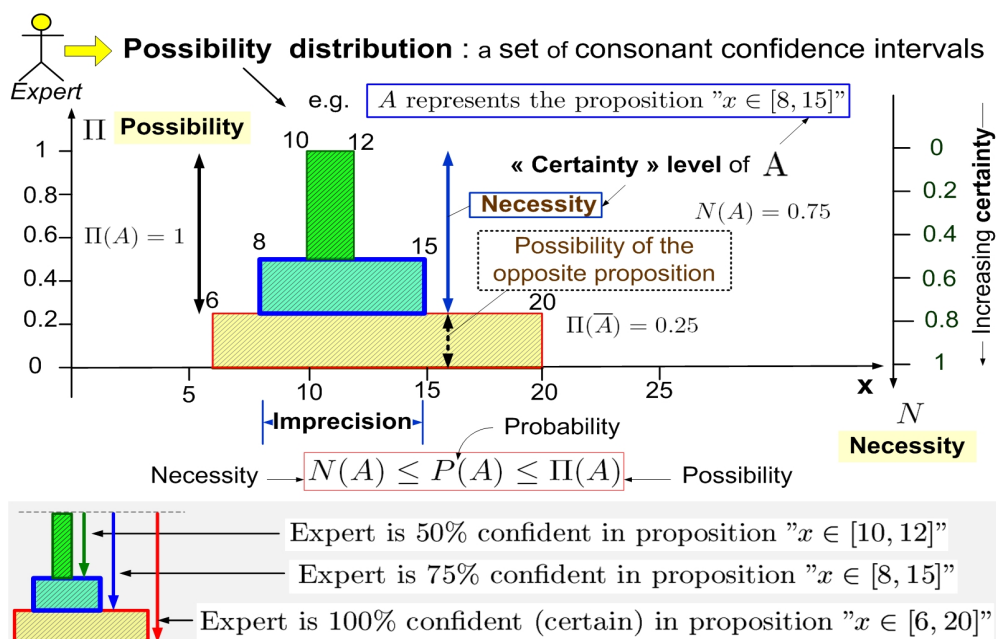
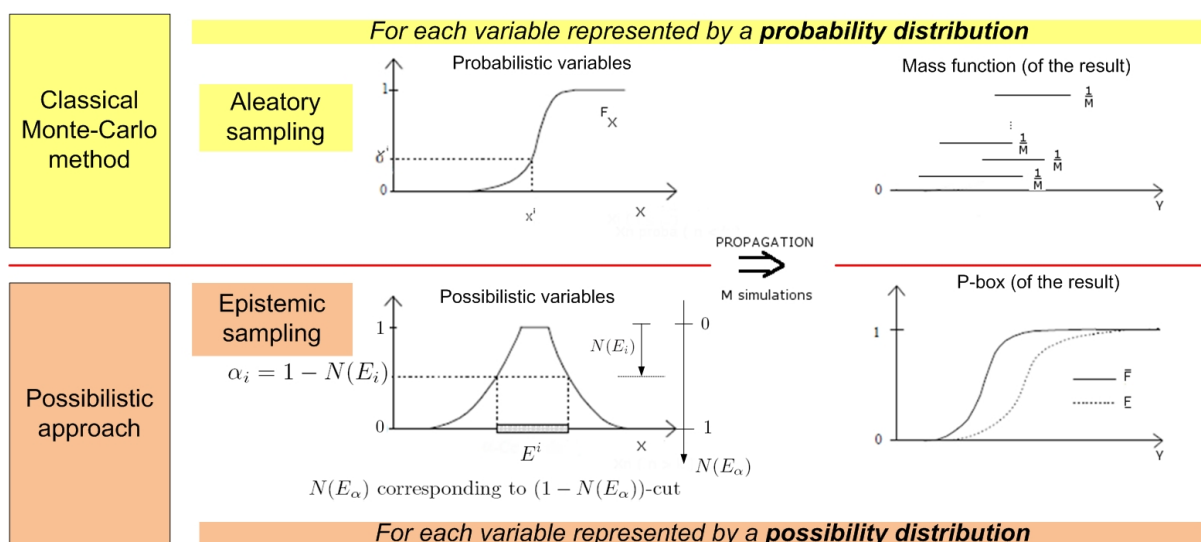


Figure 64: Expert assessment is coded by a possibility distribution (Tacet et al., 2010a)



The hybrid approach (Baudrit,2005; Baudrit et al., 2005; Chojnacki et al.,2009) is based on a combined use of probability, possibility distributions (adapted to imprecise and uncertain expert assessments) and belief theories to model input data imperfection. A possibility distribution that can be considered as a specific case of a basic belief assignment as proposed in the belief function theory framework (Shafer,1976 ; Smarandache et al. 2004-2009) : in practical, when no data sample are available to propose an objective probability distribution, experts propose an evaluation of inputs as a set of nested intervals with increasing level of confidence (Baudrit, 2005 ; Tacnet, 2009 ; Tacnet et al., 2009, 2010a).

The possibility theory (resp. belief function theory) introduces two measures the necessity (N) and possibility measures (resp. credibility and plausibility) that encode for an imprecise probability defined respectively by its lower and upper bounds (Figure 65). The SUNSET software environment developed by IRSN (Institut de Radioprotection et Sûreté Nucléaire) is then used to propagate these information in calculation (Figure 66).



**Figure 65: Input data are represented either by probability or possibility distribution depending on the available knowledge - adapted from (Tacnet et al.,2010d)**

In our context, possibility distributions (Zadeh,1978; Dubois et al., 2000) appear to be flexible tools for eliciting expert knowledge related to debris flows volume, rheological parameters...The results are helpful for a spatial hazard assessment, by quantifying the heights, speed and extension through a numerical model for muddy debris flow simulation. Instead of few results, we get a wide range of simulations showing the influence of input data imperfection on results: the uncertainty of outputs parameters of the model is assessed through specific criteria of interest such as quantile, threshold exceedance probability (Figure 70). The global framework can finally be represented as follows (Figure 66):

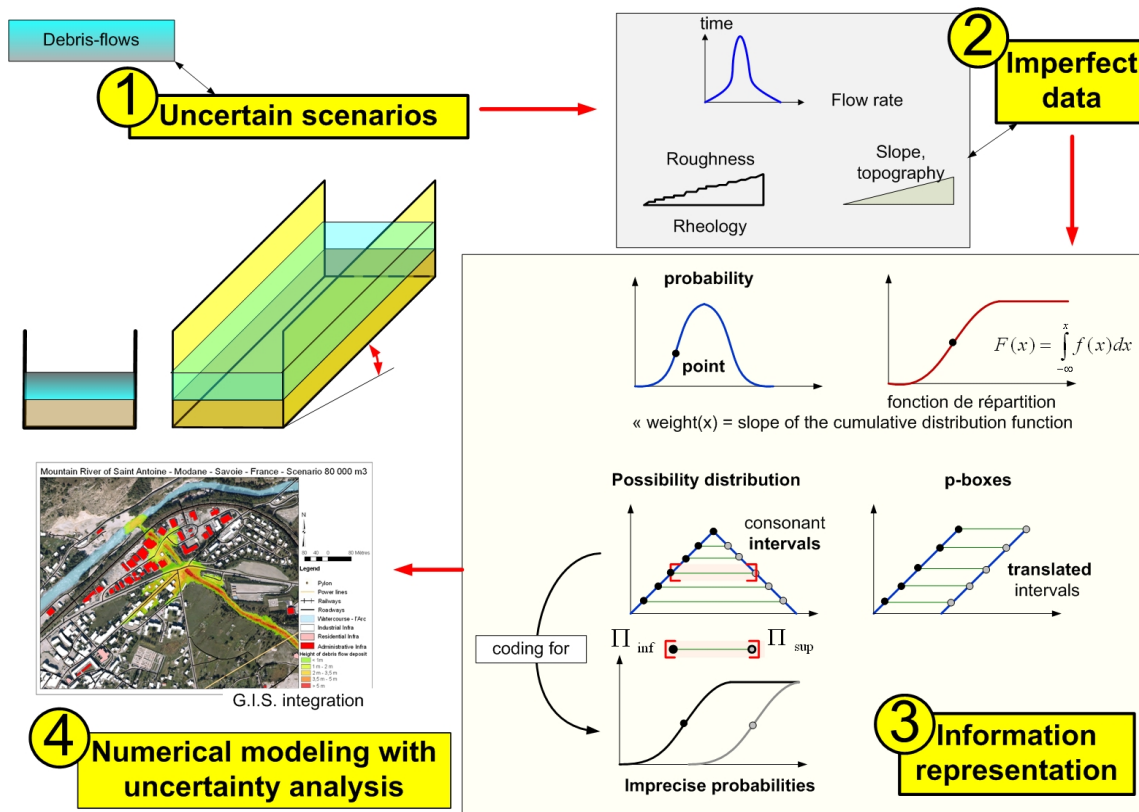


Figure 66: Input data are represented either by probability or possibility distribution depending on the available knowledge Figure 67: Principles of uncertainty analysis - different theories can be used to represent information imperfection.

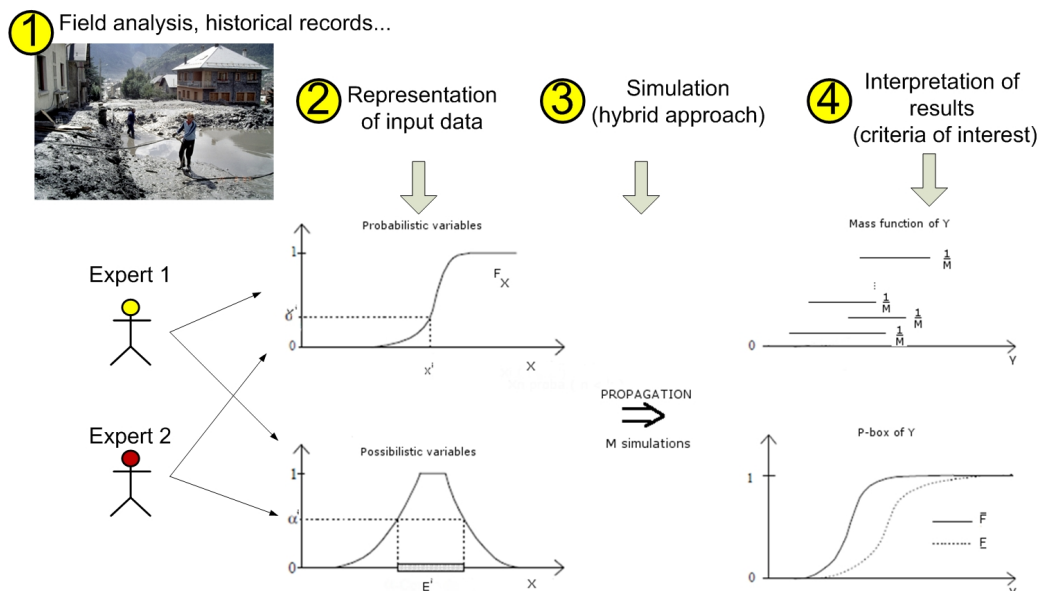
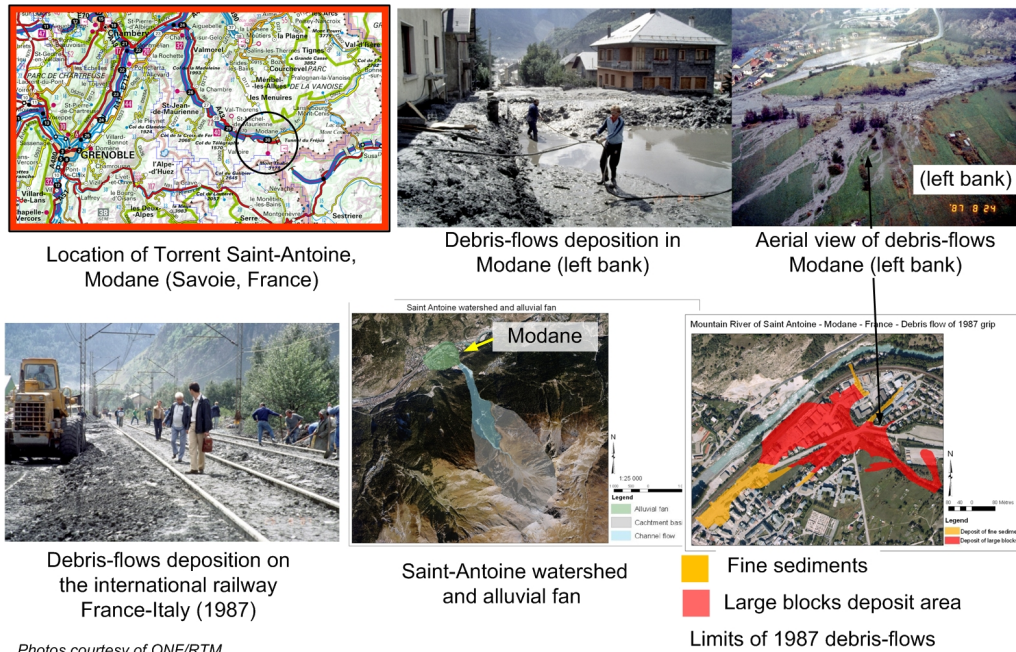


Figure 68: Sampling and propagation related to the Hybrid method.

### Application to the Torrent of Saint-Antoine (French Test Bed)

The St Antoine Torrent is a small steep land mountain stream located near Modane in the Maurienne Valley that drains a 5.2 km<sup>2</sup> catchment. It is a left side tributary stream of the Arc river. It is exposed to three main types of floods corresponding to storm floods during warm season, snowmelt floods and floods due to the ‘Lombarde’ regime coming from Mediterranean Sea. The catchment basin orientation is North/North-West – South/South-East and its maximum elevation is 3000 m, its minimum elevation is 1000 m. The last significant flood occurred in 1987 (55-80 000 m<sup>3</sup> deposit volume on national road n°6. The Saint-Antoine Torrent threatens both the national road n°6 leading to the Mont-Cenis path and the railway Frejus tunnel between France and Italy (Figure 69).



Photos courtesy of ONF/RTM

Figure 69: Case study: Torrent Saint-Antoine, Modane, France.

The results (quantile of deposition heights, threshold exceedance probabilities) of a numerical simulation of debris flows is proposed : they show in each pixel the influence of data imperfection including those resulting from expert assessments on the simulation results (Figure 70).

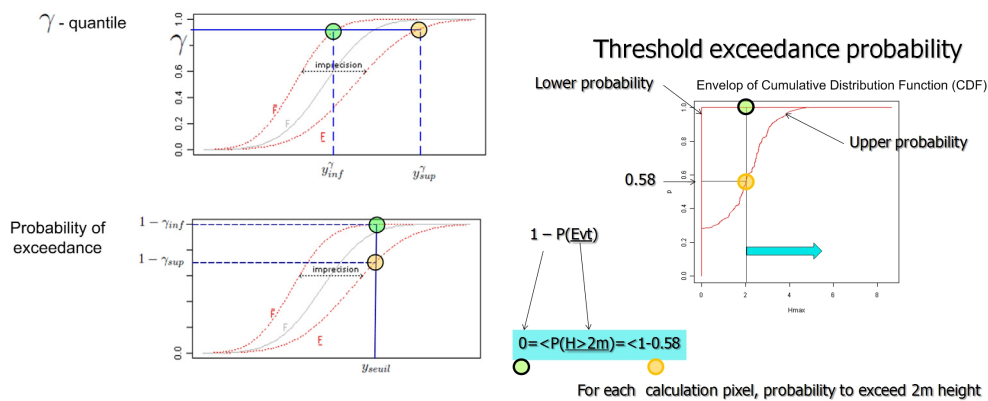
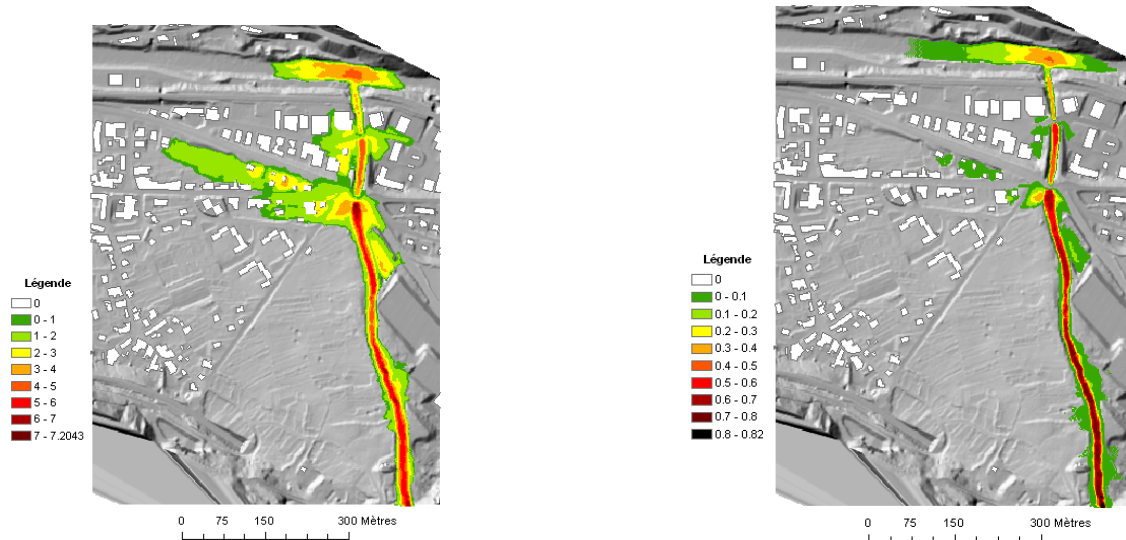


Figure 70: Criteria of interest related to debris flows height [Dupouy, 2010], [Dupouy et al., 2012].

They are finally represented in a GIS : the results are not precise values but intervals of exceedance probabilities (e.g. probability to get a debris flow height higher than 2 meters) or lower and upper bounds of a quantile (e.g. the height that is reached in 95% of cases) (Figure 71).

The important feature of this methodology is that results do take into account the real quality and availability of input data. Results may be less precise than with classical numerical approaches using single values for input parameters. At least, they are more realistic and they do not give the illusion that numerical modelling is the truth for hazard, risk assessment. Models are necessary but they should not be used over their real capacities. Development and generalization of such approaches remain important challenges for risk managers and also for decision-makers who will have to perhaps change their mind about the use and limit of models.



(a) Maximum height (in meters) reached in 95 % of cases (quantile 95)

(b) Threshold exceedance probability (a number in  $[0,1]$ ) of the proposition

*'Height of debris flows deposition >2m'*

**Figure 71: Application of the hybrid approach to the test bed case study: debris flows modelling based on imprecise knowledge of input parameters [Dupouy et al., 2012].**



## 6 Decision spatial downscaling and upscaling: towards an integrated approach from regional to local scale

Hazard, vulnerability and finally risk assessments often depend on a combination of tools and methods. In that sense, isolating the developments related to decision-facilitating methods may seem quite artificial since works related to hazard assessment and warning systems are part of the risk management and decision processes. All the work packages of the PARAMount project have, therefore, a logical link (Figure 72).

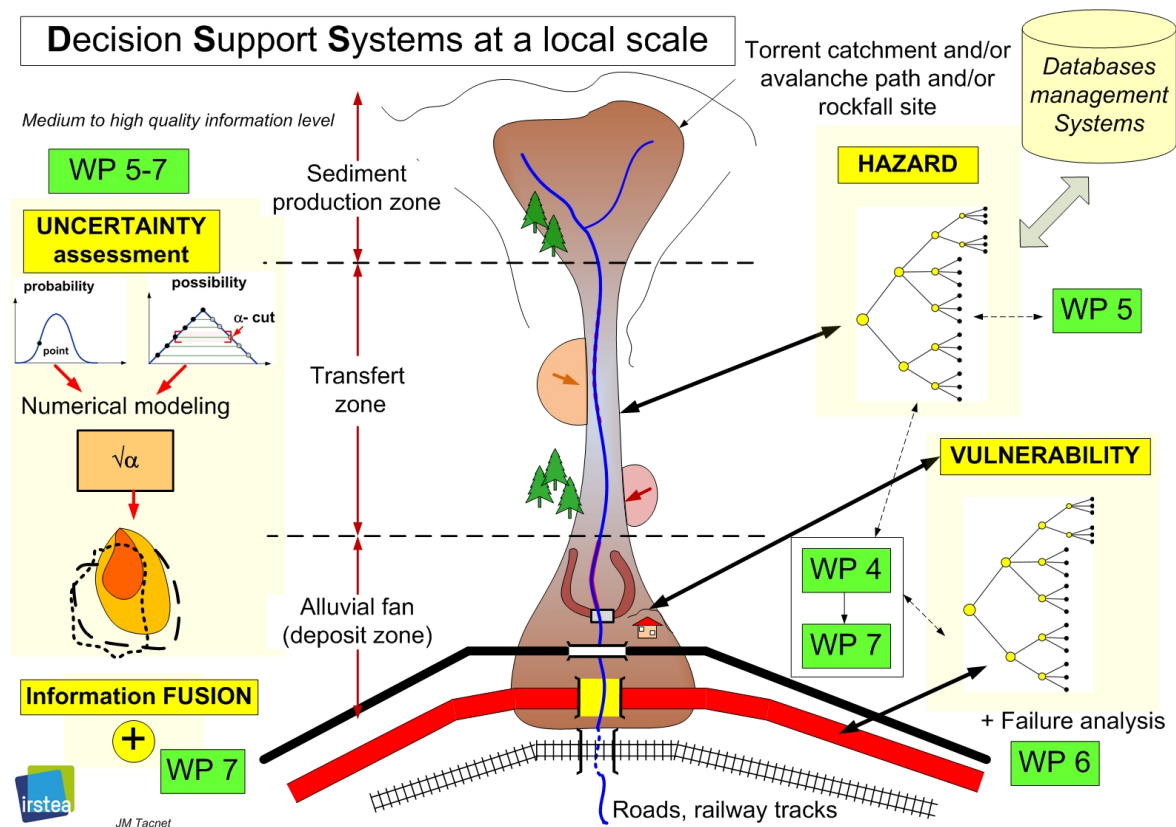
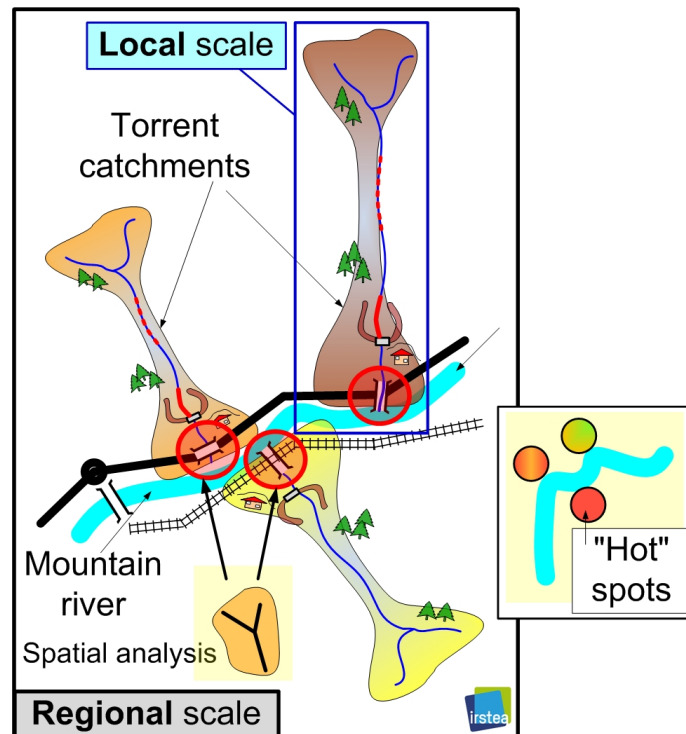


Figure 72 : Integrated approach to decision on a local scale proposed in the PARAMount project framework (Irstea)

The originality of the proposed approach consists in the development of a multi-scale decision-facilitating methodology (Figure 73). On the one hand, methods are proposed on a local scale to assess hazard, vulnerability and the effectiveness of protection works. They introduce innovative tools and make a special focus on the question of the evaluation, representation and influence of information imperfection on decisions. On the other hand, the goal is also to propose methodologies that are usable on a regional scale. The idea is to propose some tools to determine the most sensitive or important areas, denoted as hot spots (Figure 73), to be subsequently studied with a view to focusing on these points in a detailed way.



Of course, regional methods cannot provide the same precision as the previous methods dedicated to local approaches: information quality assessment is, once again, an important issue in order to inform the decision-makers about the validity and usability of the results. Simplified tools are necessary but characterisation of their relevance also remains essential.



**Figure 73: Integrated approach to decision on a regional scale proposed in the PARAMOUNT project framework (Irtsea)**

The following sections present some of these regional developments dedicated to debris flow susceptibility, avalanche and rockfall hazard and assessment of the protective role of forest.

## 6.1 Debris flow susceptibility: a regional approach

*This section has been written and verified by Frédéric Liebault and Mélanie Bertrand (Irtsea, Snow Avalanche Engineering and Torrent Control Research Unit, Grenoble, France).*

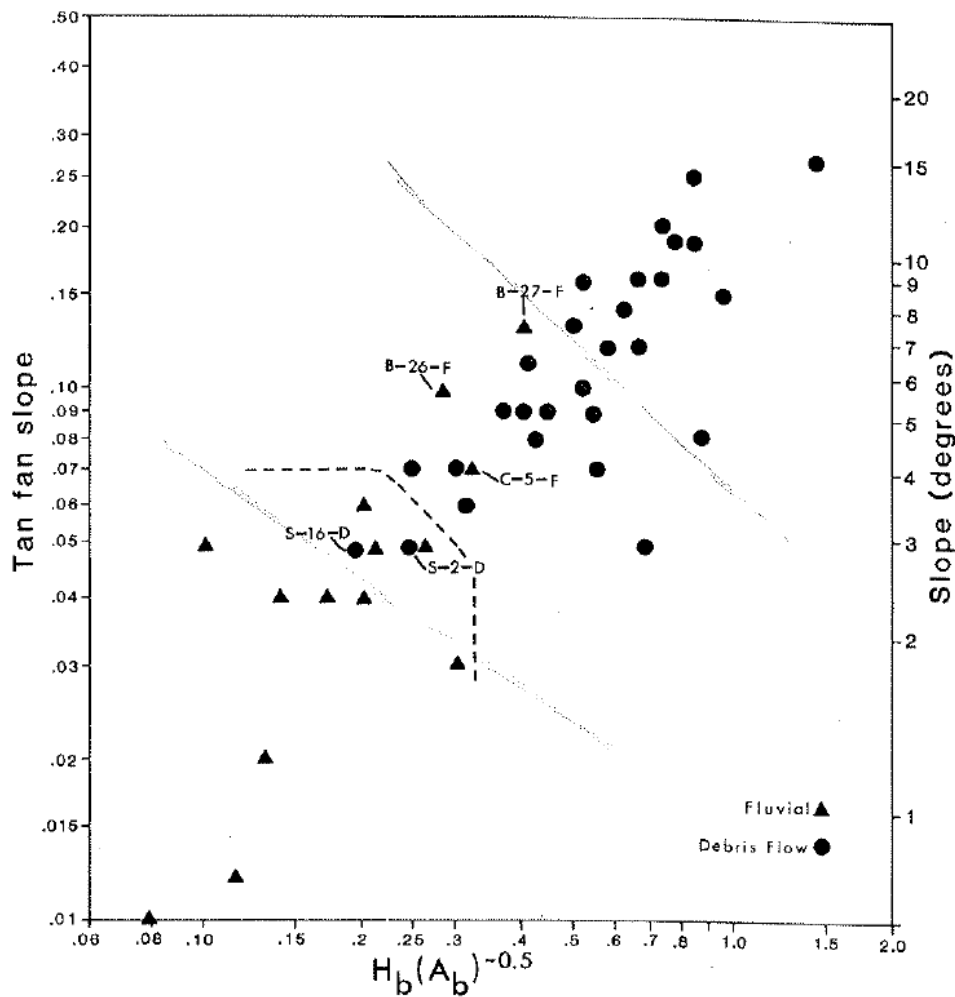
This works propose a regional assessment of debris flow impacts on transport infrastructures. Debris flows may have dramatic consequences for the safety of transport infrastructures in mountainous regions. Each year in the French Alps, some roads are impacted by debris flows (Figure 74). The prevention of debris flow hazards along transport infrastructures necessitates the development of tools dedicated to the large-scale prediction of the most exposed infrastructures. In the framework of the Paramount project, Irtsea Grenoble proposed to handle this objective by combining (i) database compilation and statistical analysis, and (ii) regional-scale methodological developments using GIS tools.



**Figure 74: An example of traffic interruption following a debris flow event in the Southern French Alps (Hautes-Alpes 2007, photo: Michel Bon ONF-RTM05)**

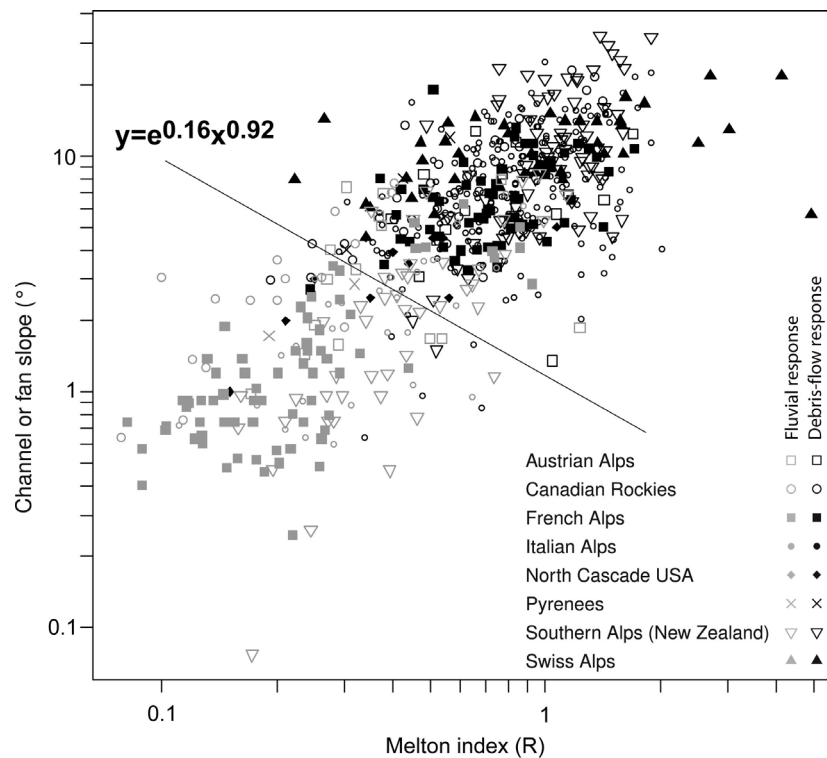
The key issue was to propose a reliable way of recognising debris-flow-prone areas for a large territory, where it is impossible to constraint all the physical determinant of debris flow processes (sediment supply, local relief, sediment size, pore-water pressure). In the literature, this kind of issue is generally apprehended by GIS-based statistical analysis that aimed to obtain empirical relations between spatial occurrences of the phenomena and potential controlling factors.

We know from pioneering regional studies made in the Canadian Rockies in the 1980s that debris flow fans can be recognised by some straightforward morphometrics, such as the Melton index and the fan slope (Kostaschuk et al., 1986; Jackson et al., 1987). The Melton index is the basin relief normalised by the square root of the drainage area, and it corresponds to the mean slope of the catchment above the fan. Early studies revealed that fans subject to debris flows are found above a Melton index of 0.25 and their slope is consistently above four degrees (Figure 75). Several other regional thresholds like this has been proposed in different mountain ranges of the world (New Zealand, Europe, North America), but all these studies present a limited population of catchments and the validity of the proposed thresholds may be questioned.



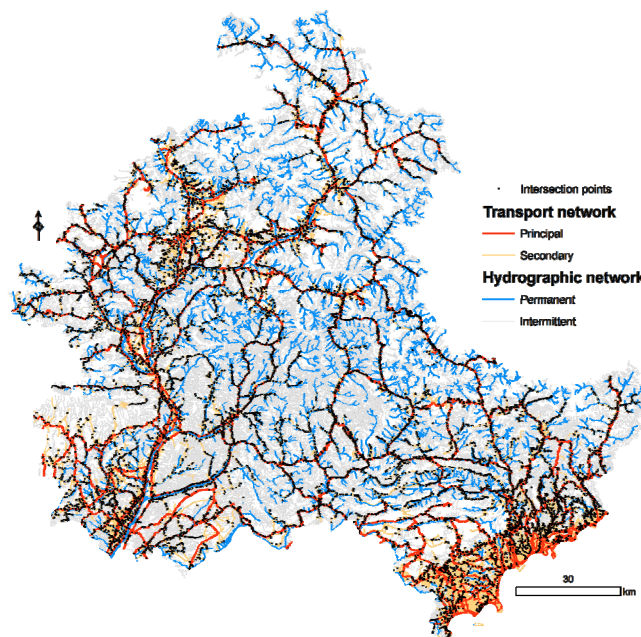
**Figure 75: Fan slope vs. Melton index scatterplot proposed by Jackson et al. (1987) to discriminate debris flow and fluvial fans in the Canadian Rockies**

In order to get a large sample of catchments, we compiled data from the literature and we obtained a database of 620 catchments with information about the dominant process at the exit (debris flow or fluvial). The two categories occupy very different zones on the Jackson diagram and they can be separated using a discriminant function associating the two morphometric parameters (Figure 76). The slope of the discriminant function revealed that we cannot consider a unique threshold for the slope or the Melton index, as generally proposed by previous studies, but that these two parameters must be combined to define a threshold. It also emerges that the threshold slope for debris flow decreases with the slope of the catchment. A logistic regression model was also derived from these data, giving the possibility of calculating the probability of a catchment's generating debris flow (Bertrand et al., in review). The two proposed models have been tested using the 'leave one out' procedure and we obtained high values for both the sensitivity and the specificity ratio, which gives the percentage of true positive and true negative cases respectively (these ratios are routinely used to characterise performance of models and they are not sensitive to the prevalence of the dataset). The linear discriminant model shows a sensitivity of 0.90 and a specificity of 0.89. The logistic regression model shows a sensitivity of 0.96 and a specificity of 0.75.



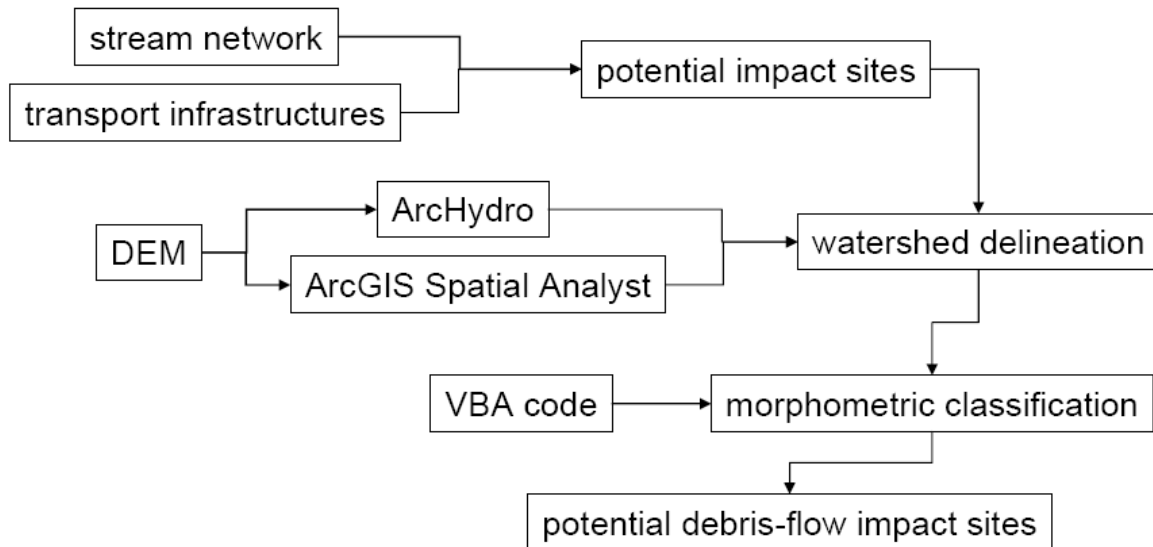
**Figure 76: Linear discriminant function obtained to separate debris flow and fluvial responses from a compiled database of 620 catchments**

The next step was to implement these statistical models on a GIS dedicated to the identification of the roads most exposed to debris flows. The transport network and stream network were obtained from the most accurate vectorial database available in France (BD Topo from IGN) (Figure 77). The flowchart of the GIS procedure implemented for the automatic extraction of potential debris flow impact sites is presented in Figure 78.



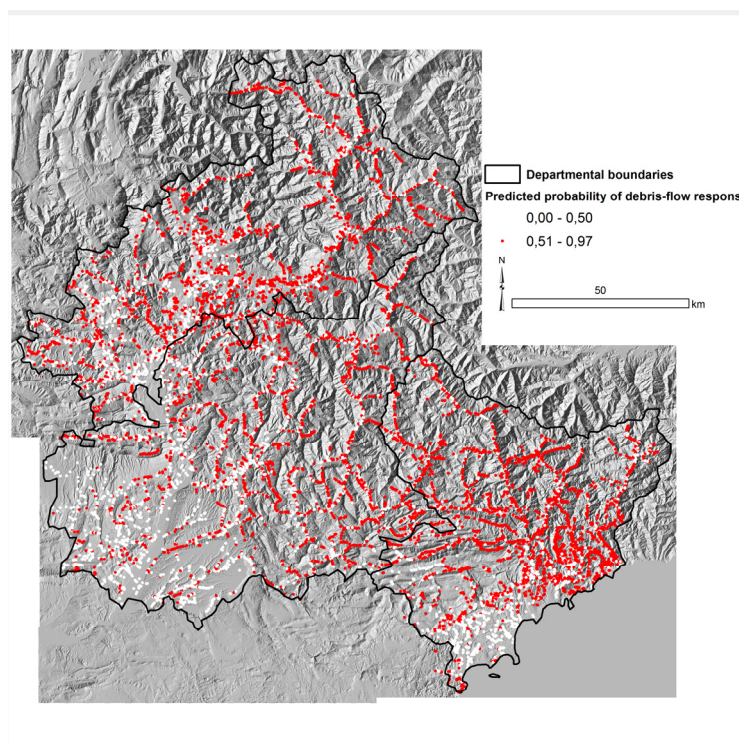
**Figure 77: Transport infrastructure network and stream network used to characterise potential debris flow impact sites in the Southern French Alps (vectorial data from IGN BD Topo)**





**Figure 78: Flow chart of the GIS procedure implemented for the automatic mapping of the transport infrastructures most exposed to debris flow impacts**

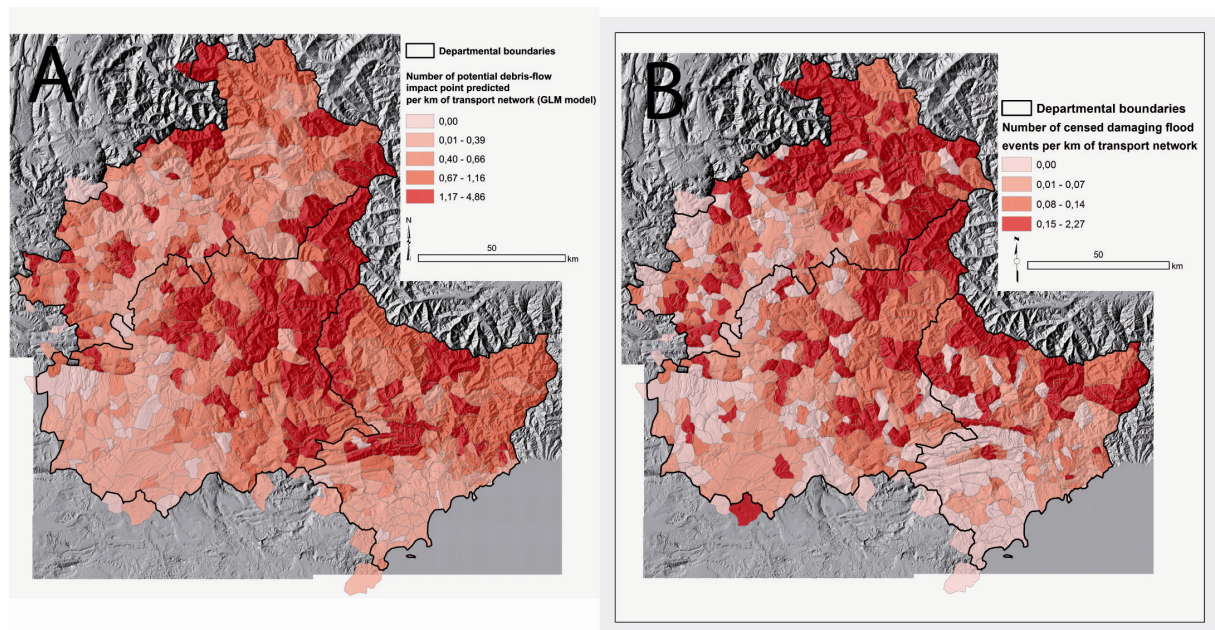
A regional map of exposed transport infrastructures is then proposed (Figure 79). The sum of all potential impact points gave a value of 13,700 points along a 19,700 km transport network. Sixty-five percent of these points have a debris flow probability of occurrence higher than 0.5 according to the logistic regression model. The model also gave a density of potential debris flow impact points of 4.5 pts/10km of transport infrastructures.



**Figure 79: Potential debris flow impact points along transport infrastructures in the Southern French Alps**



The regional map has been compared with historical data from the ONF-RTM services (BD événements – Event SGBD). The comparison is possible only when the information is integrated on the level of the municipality (the smallest administrative unit in France). Synthetic indicators can be produced on this scale. We calculated the number of potential debris flow impact sites per km of transport infrastructures for each unit. The historical database from RTM was used to calculate for the same units the number of registered flood events with a known impact on transport infrastructures. These two maps (Figure 80) show a quite similar big picture of regional hazards, even if some differences are observed locally. This finally confirms that our methodological approach produces relevant information on the regional scale



**Figure 80: (A) The density of potential debris flow impact sites per km of transport infrastructure for each municipality of the Southern Alps, derived from morphometric analysis. (B) Number of registered damaging flood events per km of transport network for each municipality of the French Alps, as recorded by the historical database from ONF-RTM.**

## References

Bertrand, M., Liébault, F., Piégay, H., in review. Debris flow susceptibility of small upland catchments. *Natural Hazards*.

Jackson LE, Kostaschuk RA, MacDonald GM. 1987. Identification of debris flow hazard on alluvial fans in the Canadian Rocky Mountains. In *Debris flows/Avalanches Process, Recognition, and Mitigation*, Costa JE, Wieczorek GF (eds). Geological Society of America; 115-124.

Kostaschuk RA, Macdonald GM, Putnam PE. 1986. Depositional process and alluvial fan - drainage basin morphometric relationships near Banff, Alberta, Canada. *Earth Surface Processes and Landforms* 11(5): 471-484.

## 6.2 Avalanches and rockfall regional analysis with a special focus on protective role of forest

*This section has been written and verified by Frédéric Berger, Nicolas Clouet and David Toe (Irstea, Mountain Ecosystems Research Unit, Grenoble, France).*

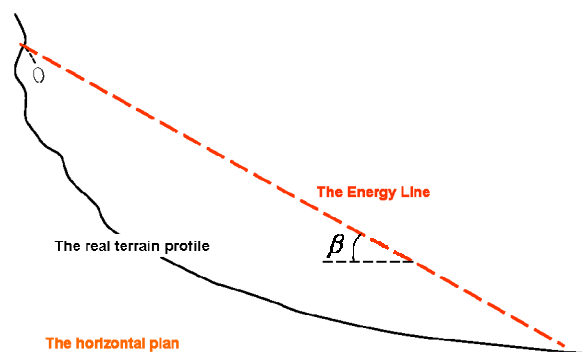
### The concept of the Energy Line Angle

The first step for elaborating an efficient risk prevention policy is to supply experts and decision-makers with a clear and global vision of what could potentially happen in the territory that they are managing. This territorial overview of geo hazards potentialities can only be done on a global scale, which is commonly the regional one. With such information risk managers and decision-makers are able to determine where local scale expertises are needed and to fix priorities in terms of technical interventions and the allocation of funding. The general principle of hazard mapping procedure is 1) to determine the localisation of the hazard's potential and active release areas, and 2) to estimate from these release areas what are the maximal possible run-out distances.

Working on a regional scale means that modelling tools, for which high resolution data and field surveys are needed, are not directly usable. Due to the resolution and the accuracy of the data available on a regional scale, the use of process-based 3D propagation models needs to aggregate and simplify the input parameters and so to deteriorate the domain of validity of the results obtained with such models. This kind of model is also time-consuming and needs high data storage and computing facilities. So in order to provide a robust and usable regional study, the experts have to use models needing the lowest amount of input data, data which should be easily available without specific field investigations. Probabilistic empirical models based on the analysis of the past events database clearly answer to these needs.

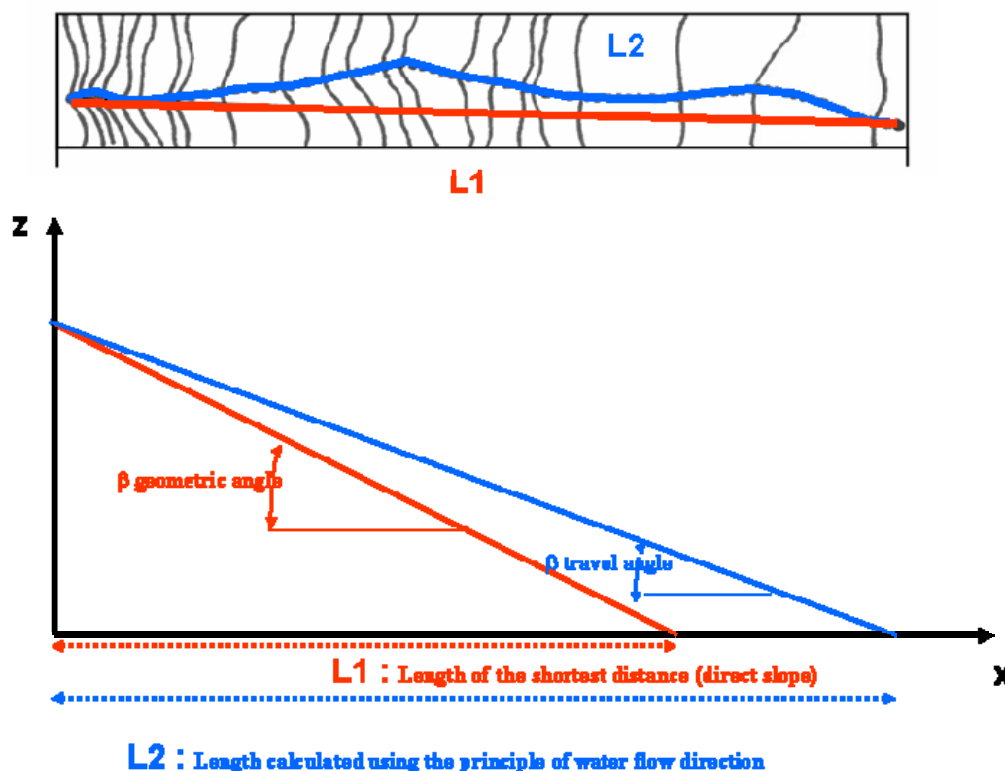
The advantage of such models is that in order to identify potential release and propagation zones they do not require any meteorological or geological data. Effectively these models are only based on topographical criteria and so the only input datum is a digital terrain model (DTM). Nowadays DTM are available for all the Alpine Space countries and so empirical models can be easily used for a preliminary geographical hazard assessment and pre-mapping.

Historically, the concept used for building up the first empirical model was established by Heim in 1932 for rockfall hazards. This concept is that of the Energy Line Angle (ELA). This concept states that the maximal run-out distance of a rockfall corresponds to the point resulting from the graphical intersection between the horizontal plane and a virtual line (the energy line) starting at the release point and having a specific slope angle ( $\beta$ ). The following figure (Figure 81) illustrates this concept.



**Figure 81: The rockfall Energy Line Angle concept**

Heim also proved that the determination of the run-out distance can be done using two different angles of the energy line. The calculation can be done either 1) using the geometric angle which is calculated using the horizontal projection of the direct slope line between the release point and the stopping one, or 2) using the travel angle which is calculated from the length of the horizontal projection of the line corresponding to the water flow direction along the slope. The travel angle is always flatter than the geometric one, because the distance derived from the water flow direction is longer than the one calculated along the direct slope and so the ratio of height and horizontal length is smaller (Figure 82).



**Figure 82: The difference between the Energy Line geometric angle (in red) and the Energy Line travel angle (in blue)**

Since 1932, all the published field observations show that the magnitude of the Energy Line Angle is within a certain range and above a certain limit with little variation (see below the chapter on rockfalls zoning). Therefore it is possible to get a realistic order of magnitude of the rockfall run-out length from a known release point. The Energy Line Angle concept of Heim was adapted by Scheller in 1970 in order to calculate the maximal run-out point using the foot of the cliff and not its top. This author has so defined the shadow angle ( $\gamma$ ). Figure 83 presents these two angles and the formula to be used for calculating the Energy Line Angle (the  $\Delta z$  has to be adapted for the calculation of the shadow angle). In 1998 Meissl determined that the difference between the geometric angle and the travel angle is less than 1 degree. The geometric angle is the easiest one to determine, either in the field with an inclinometer or using a DTM.

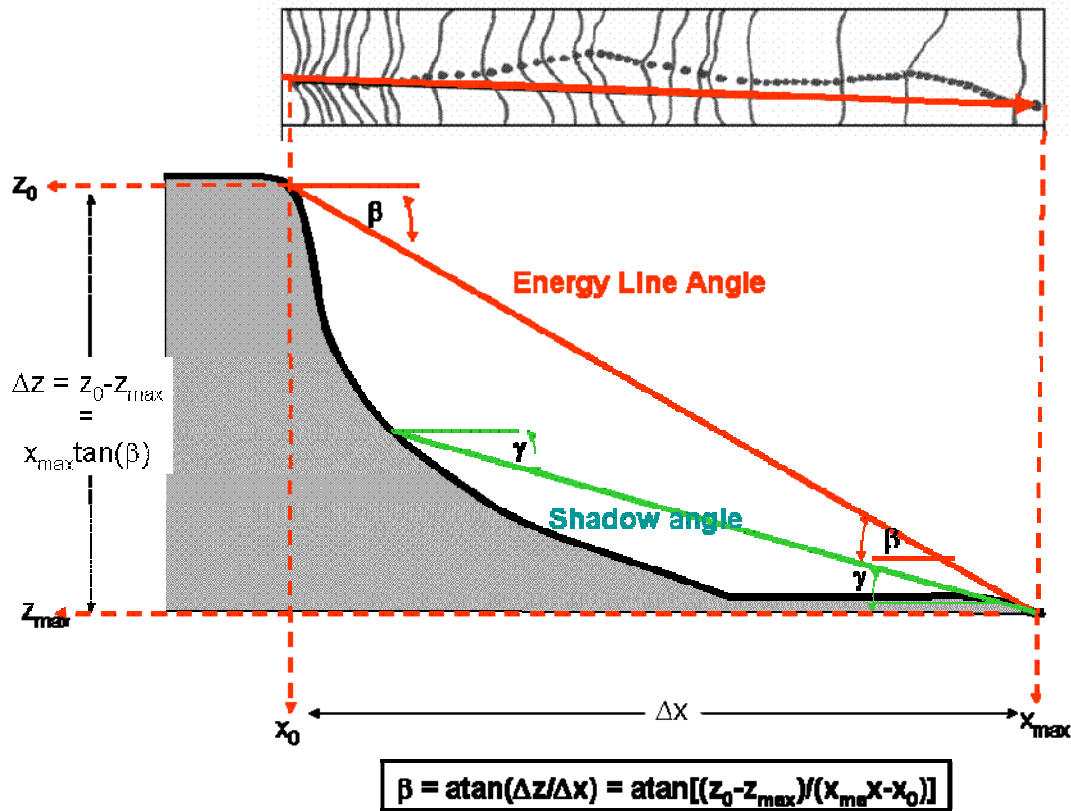


Figure 83: The difference between the Energy Line Angle ( $\beta$ ) and the shadow one ( $\gamma$ )

Dorren and Berger (2003) have confirmed the possibility of estimating the maximal speed of a rock using the maximal difference of altitude between the energy line angle and the slope profile (Figure 84).

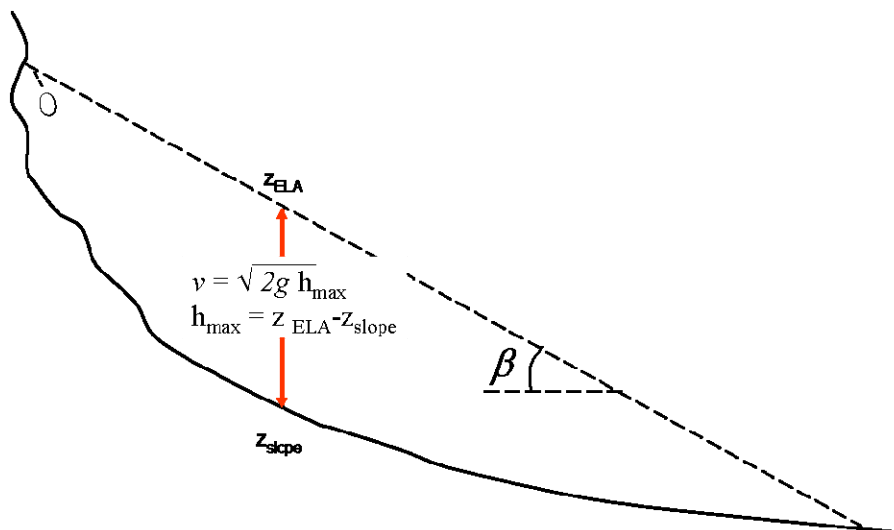


Figure 84: How to determine the maximal speed of a rock using the Energy line Angle

The Energy Line Angle (ELA) concept is perfectly adapted to a regional scale assessment if a past rockfall events database is available. For each past event the energy line angle can be calculated and so a statistical model can be calibrated. This simple concept based on the principle of the friction angle has been also tested for predicting maximal avalanche run-out distance. The first author to transpose this concept to avalanche problematics was Körner in 1976. In 1979 Lied has proposed, for Norwegian topographical conditions, the first maximal avalanche run-out distance predictive model derived from the energy line angle concept of Heim. Since then, the protocol used by this author for building up his model has become the international reference for calibrating maximal avalanche run-out distance empirical models. This protocol is presented in the next chapter. As for rockfalls, the calibration of energy line avalanche models needs a past event database in order to derive the statistical law to be applied. The simplicity of the ELA concept, and the fact that the statistical laws used by the ELA models are calibrated using past events data, meant that the resulting hazard mapping allowed risk managers to have a first rough and ready estimate of potential run-out distances and so to identify geographical sectors for which expert reports at local level need to be carried out. Mapping using the ELA concept can be very quickly effected using the terrain and grid calculation modulus of GIS tools.

Within the Paramount project, the French partner IRSTEA has developed two regional scale models based on the ELA concept. The first one, Avalfor<sup>LIN</sup>, is dedicated to avalanche hazard mapping and the second one, Rockfor<sup>LIN</sup>, to rockfall hazard mapping. These models, if they are able to display the geographical areas potentially affected by these hazards, also provide (if the forest map is available for the area being studied) the zoning of the forest areas offering a potential protection against these two natural hazards. As these models are dedicated to a regional scale mapping, they can then be used both for risk prevention and forest management strategic planning. The two main objectives of these models are to identify, for a given study area, if human infrastructures are potentially endangered and if forest stands located above these infrastructures can provide a protective function.

The general principle for this mapping is based on answers to the following questions:

1. Where are the release areas?
2. What is the maximum propagation area envelope?
3. Is any human infrastructure located in the propagation area and if so, is it endangered?
4. Are any forest stands located in the release area and/or in the propagation area above the human infrastructure endangered?

If the answer to the third question is yes, then a specific expert report has to be conducted in order to assess the need of protective works. If the answer to the fourth question is yes, then these forest stands serve a protective function, and an investigation at local level is needed in order to qualify and/or quantify the efficiency of this protection.

### **Rockfall hazard mapping with Rockfor<sup>LIN</sup>**

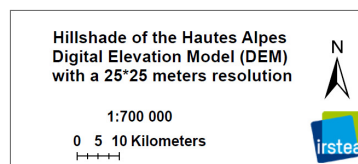
Rockfor<sup>LIN</sup> is a 2D raster GIS model developed by Irstea which is able, depending on the available input data, to answer to the 4 questions expressed above. Depending on the objectives, the input data needed are:



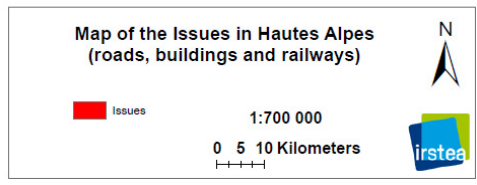
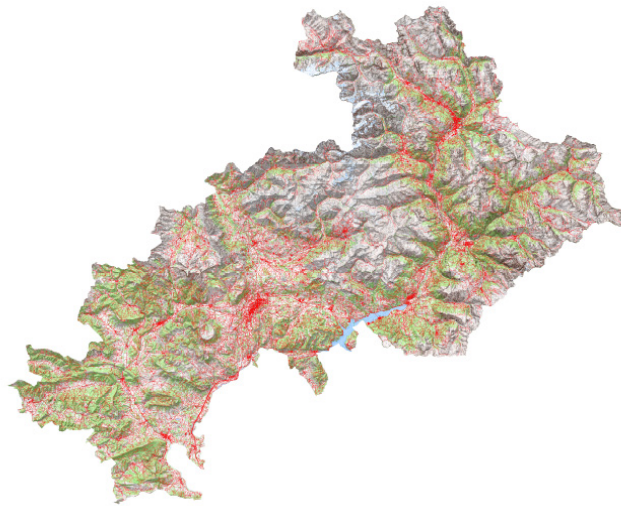
Objectives	Input data: raster maps (the resolutions can be different but the minimal resolution is the one of the DTM)			
	DTM	Past event cadastres or any geo-localised information	Human infrastructures	Forest map
Release zones mapping				
Run-out zones mapping				
Risk mapping				
Protection forestmapping				

**Figure 85: Table 1: The input data needed for the use of Rockfor<sup>LIN</sup>**

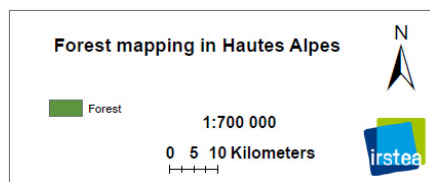
The following maps (Figure 86, Figure 87, Figure 88) illustrate the 3 main input data.



**Figure 86: The 25x25m resolution DTM (Digital Terrain Model) of the French Département des Hautes-Alpes case study (5549 km<sup>2</sup>)**



**Figure 87: The map of the issues of the French Département des Hautes-Alpes case study**



**Figure 88: The forest map of the French Département des Hautes-Alpes case study**

## Rockfall release areas mapping with Rockfor<sup>LIN</sup>

Rockfor<sup>LIN</sup> can only be used if all potential rockfalls release points have been mapped. This mapping can be done via field surveys, aerial photography analysis, past events database analysis or numerical processing on the DTM. Rockfor<sup>LIN</sup> offers the possibility of performing a DTM analysis for identifying rockfalls potential release areas.

The assumption which has been used is that the release areas depend only on the topographic conditions of the case study. So, a simple slope threshold can be applied to the slope surface raster (computed from the Digital Terrain Model [DTM] raster). The resolution and the accuracy of the DTM affect the results. A DTM resolution of at least 25x25m is necessary. According to the results of Dorren and Berger (2003), the equation used in Rockfor<sup>LIN</sup> is:

$$\alpha = 55 \times \text{RES}^{-0.075}, \text{ where RES is the DTM resolution}$$

All cells with values higher than the threshold  $\alpha$  are qualified as potential release zones for rockfalls. This equation has been established using a multi-resolution analysis of slope gradient in known existing rockfalls source area at five different locations: France (1), Austria (2), Switzerland (1) and Liechtenstein (1). The table below gives the threshold values for determining rockfall release areas for main DTM resolutions.

DTM resolution/cell size [m]	Threshold slope gradient [°]
1	55
5	49
10	46
25	43

**Figure 89: Threshold values for determining rockfall release areas for main DTM resolutions**

Within Rockfor<sup>LIN</sup> the user has to enter the DTM's resolution and then 1) the slope threshold is automatically calculated and 2) the map of potential rockfall release areas is automatically generated. If the user wants to work with another slope threshold value this is possible and he has to enter the value he wants to work with. It is important to keep in mind that the slope threshold value calculation using a DTM could generate local errors and that this way of calculation can only determine release areas with a minimal height. So the resulting map has to be validated by local experts.

Effectively, in a DTM, the real curvature of a slope is expressed by the slope value of the cells. For example a slope of 43° in a 25x25m DTM can represent very different curvature profiles as expressed in the figure below (Figure 90):

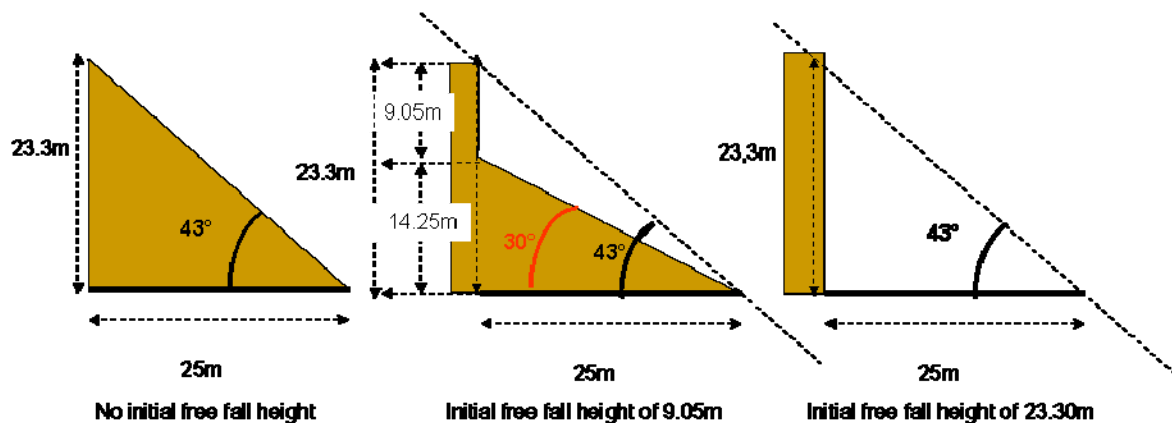


Figure 90: Example of variation of release area configuration expressed with a slope threshold of 43°

So in one cell the potential release vertical height depends on: the value ( $\phi$ ) and the length (value max = the DTM resolution) of the slope below the foot of the release area and, on the value of the slope angle threshold ( $\alpha$ ) used (Figure 91).

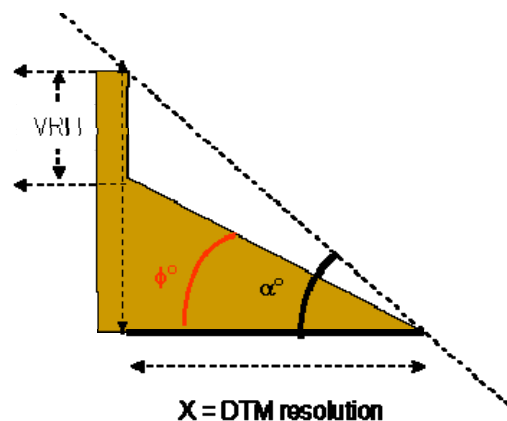


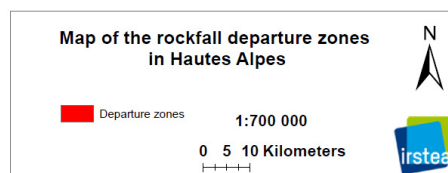
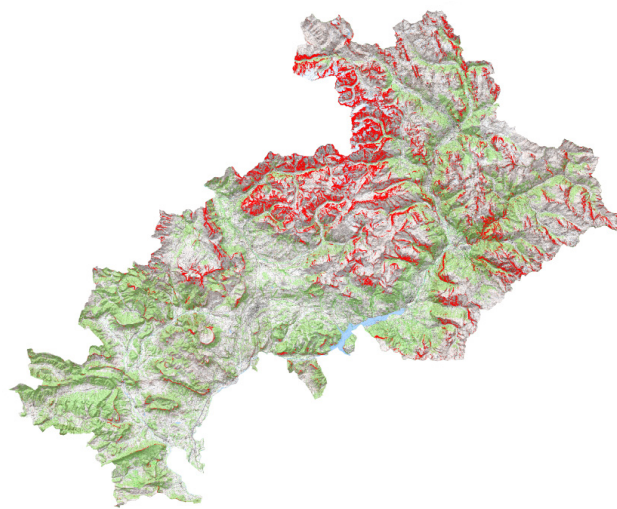
Figure 91: The parameters influencing the potential release vertical height

The table below (Figure 92) gives for 1x1, 10x10 and 25x25m DTM resolutions the potential Vertical Release Height (VRH) with  $\beta \leq \alpha$  and  $\beta$  slope length = DTM resolution.

DTM Resolution [m]	Slope threshold : $\alpha$ [°]	DTM Resolution [m]	Slope threshold [°]	DTM Resolution [m]	Slope threshold [°]
1,00	55,00	10,00	46,28	25,00	43,20
Slope : $\beta$ [°]	Vertical release height : VRH [m]	Slope : $\beta$ [°]	Vertical release height : VRH [m]	Slope : $\beta$ [°]	Vertical release height : VRH [m]
0	1,43	0	10,46	0	23,48
5	1,34	5	9,58	5	21,29
10	1,25	10	8,69	10	19,07
15	1,16	15	7,78	15	16,78
20	1,06	20	6,82	20	14,38
25	0,96	25	5,79	25	11,82
30	0,85	30	4,68	30	9,05
35	0,73	35	3,45	35	5,97
40	0,59	40	2,06	40	2,50
45	0,43	45	0,46	43,2	0,00
50	0,24				
55	0,00	46,28	0,00		

Figure 92: Value of the potential Vertical Release Height for 1x1, 10x10 and 25x25m DTM resolutions with  $\beta \leq \alpha$  and  $\beta$  slope length = DTM resolution

The use of the  $\alpha$  angle threshold is perfectly adapted for identifying the vertical release height of:  $\geq 23.5\text{m}$  in a DTM having a resolution of  $25 \times 25\text{m}$ ,  $\geq 10.5\text{m}$  in a DTM having a resolution of  $10 \times 10\text{m}$ ,  $\geq 1.5\text{m}$  in a DTM having a resolution of  $1 \times 1\text{m}$ . These values delimit the domain of validity of this method. For DTM resolutions lower than  $1\text{m}$ , the slope gradient release areas method allows the expert to obtain a pre-map which will identify all the potential release areas having a vertical height at minima equal to the DTM resolution. So the expert has to check the validity of this pre-map for release areas having a vertical height lower than the DTM resolution. One solution is to use a lowest angle threshold. In this case some spurious release areas can be detected and the validation of the pre-mapping by the expert is obligatory. This validation can be done by sampling check point in the field. The following map (Figure 93) illustrates the results obtained by this method in the French case study of the Paramount project.



**Figure 93: Map of rockfalls release zones obtained with Rockfor<sup>LIN</sup> (French Département des Hautes-Alpes case study)**

### Mapping rockfalls' potential maximal run-out areas with Rockfor<sup>LIN</sup>

From each of the identified potential release areas, RockFor<sup>LIN</sup> simulates the maximal probable propagation envelopes. For performing this calculation RockFor<sup>LIN</sup> uses formulae based on the Energy Line principle (Heim, 1932), and on the use of a lateral spread-off angle. The lateral spread off angle is used to characterise the potentiality of lateral deviation of a rock along the most probable trajectory path. The value of this angle has been fixed, using literature data (Dorren and Berger 2003, Jaboyedoff and Labiouse 2011), at  $20^\circ$ .



Concerning the choice of value of the Energy Line Angle, the same approach based on state of the art knowledge has been initially used. The table below (Figure 94) gives the available value in the literature of the Energy Line Angle.

Author/Source	Energy Line Angle	
	Between brackets the value for the geometrical angle	
	Minimum or interval of values	Average value
Shreve (1968)	(26.57° - 38.66°)	---
Hsü (1975)	31° (32°)	---
Onofri & Candian (1979)	28.34° – 40.73° (28.84 ° - 41.73°)	---
Grunder ( 1984)	32.6° - 33.4° (33.1° - 34.4°)	---
Moser (1986)	33° - 42° (34° - 43°)	---
Domaas(1985 in Toppe 1987)	32° (33°)	---
Mac ewen (1989)	(30.96°) ≈ (31°)	
Gerber (1994)	33° - 37° (33.5° - 38°)	---
Meissl (1998)	29° – 47.5° (29.5° - 48.5°)	38° (38°)
Heinimann et al. (1998)	33° - 37° (33.5° - 38°)	---
Focardi & lotti (2001)	27° - 29° (27.5° - 30°)	---
Ayala-carcedo et al. (2001)	(29.1° - 38.9°)	(31.9°)
Jaboyedoff & Labouise (2003)	32° (33°)	---
Jaboyedoff & Labouise (2011)	(32,6° - 35,6°)	34°
Corominas et al. (2003)	26° - 54° (27° 55°)	---
Dorren & Berger (2005,2006)	31.3° - 37° (31.9° - 38 °)	---
Copons et al.(2009) site a	(36.87° - 56.3°)	---
Copons et al.(2009) site b	(28.81° - 42.0°)	---
Hutter et al. (2005) reduced scale experiments	(30° - 37°)	---
Scheidegger (1973)	(29.68° - 39,69°)	---
Marquinez et al. (2002) site 1	(32.5° - 40.9°)	(31.5° - 40.2°)

Marquinez et al. (2002) site 2	(29.4° - 38.5°)	
Antoniou & Lekkas (2009)	(35°)	---
Deparis et al (2008)	(31.61° - 47.20°)	---
Hyndman & Hyndman (2009)	(33°)	---
Berger et al. (2009) with forest	(27.67° - 33.88°)	---
Berger et al. (2009) without forest	(31.32° - 37.86°)	---
Berger et al. (2009) reduced scale experiments	(32.57° - 48.99°)	---

**Figure 94: State of the Art for the Energy Line Angle values**

A statistical analysis has been performed on the data of Figure 94. Figure 95 presents the results of this analysis.

Statistics	Minimal Geometrical Angle	Maximal Geometrical Angle
Mean	31.14°	39.30°
Min	26.57°	30°
1 <sup>st</sup> quartile	29.45°	36.97°
2 <sup>nd</sup> quartile	31.61°	38.58
3 <sup>rd</sup> quartile	33°	41.80°
Max	36.87°	48.99°

**Figure 95: Statistical distribution of the published minimal and maximal geometrical Energy Line Angle**

In parallel to this state of the Art, the French Northern Alps rockfalls database has been used for a statistical analysis of the observed values' distribution (cf. Figure 96). The geometrical Energy Line Angle has been surveyed since 2010 for each event occurring in the French Northern Alps on which a field survey has been conducted.

Statistics	Volume (m <sup>3</sup> )	Energy Line Angle (°)	Centile	Energy Line Angle (°)	Centile	Energy Line Angle (°)
Minimum	0.02	24.65	0.001%	24.65	4.00%	28.00
Maximum	200.00	58.42	4.00%	28.00	20.00%	32.00
Mean value	6.46	36.69	9.00%	30.00	40.00%	35.00
Standard deviation	18.88	5.54	35.00%	34.00	65.00%	38.00
Median	1.50	36,00				
Total number of events	194					

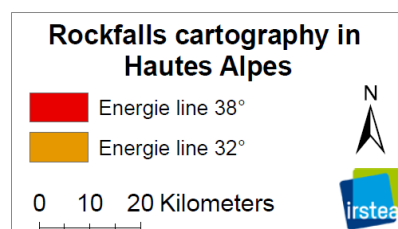
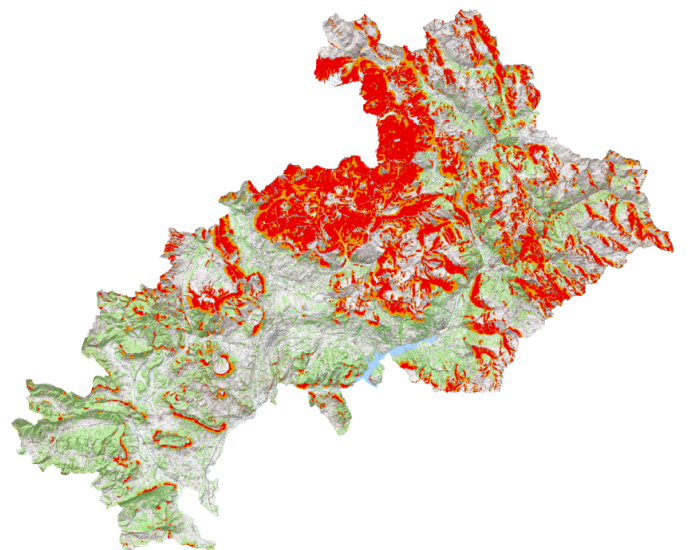
**Figure 96: Results of the statistical analysis of the geometrical ELA in the French Northern Alps rockfalls database**

All these data have been used for defining a matrix of rockfall propagation probabilities depending on the value of the geometrical Energy Line Angle ( $\beta$ ). This matrix, given below, is the one used within RockFor<sup>LIN</sup> for run-out zone calculation.

Geometrical Energy Line Angle thresholds	Probability of rockfalls propagation
$\geq 38^\circ$	High
$35^\circ \leq < 38^\circ$	Medium
$32^\circ \leq < 35^\circ$	Low
$28^\circ \leq < 32^\circ$	Very low but greater than zero

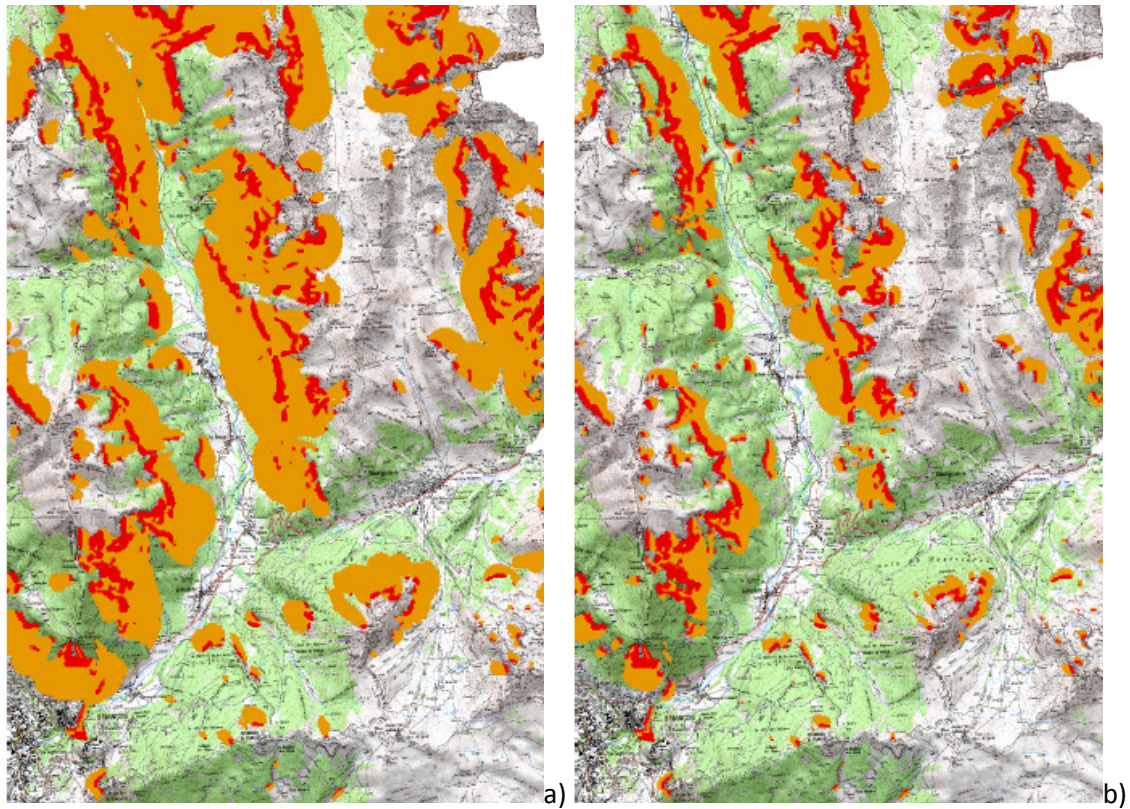
**Figure 97: the geometrical ELA matrix of RockFor<sup>LIN</sup>**

Usually the two main maps used by the experts are the  $32^\circ$  and the  $38^\circ$  ones. The  $32^\circ$  map represents the most probable maximum run-out zones without taking into account the role played by forests present on the path. The  $38^\circ$  map, on the other hand, represents the probable run-out zone taking into account the optimal role of an ideal forest. So the value of  $38^\circ$  displays the potential maximum efficiency that forests can provide. RockFor<sup>LIN</sup> also calculates a 'reaching frequency' which corresponds to the number of release zones feeding one propagation cell. So the result can be expressed with a uniform colour if the info mapped is only the envelope of the propagation area or with a colour gradient if the info mapped is the reaching frequency. The following maps (Figure 98, Figure 99) illustrate the results obtained with this method in the French case study. The same methods have also been applied to Italian, Austrian and Slovenian test beds in the PARAMOUNT project.



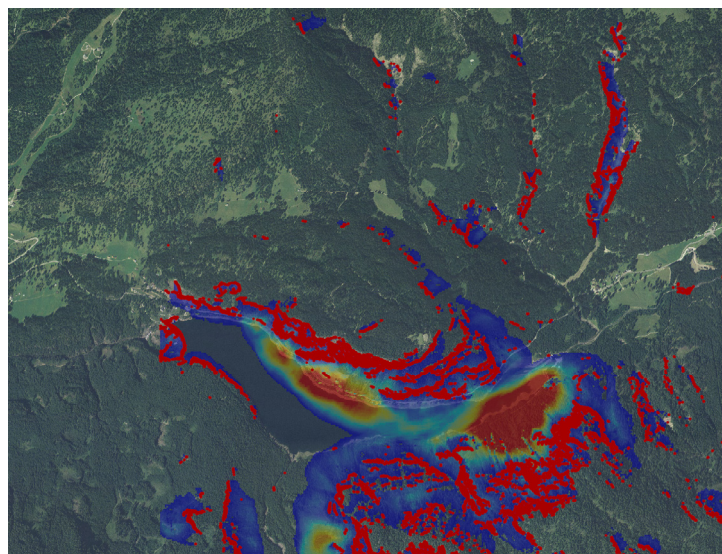
**Figure 98: Rockfalls probable propagation zones map obtained with RockFor<sup>LIN</sup>, and using a 25x25m DTM, for the French Département des Hautes-Alpes case study.**





**Figure 99:** a) Probable rockfall propagation zones (in orange, the release areas in red) determined with an ELA of 32° and using a 25x25m DTM for the Queyras area (zoom of the map on the scale of the Département des Hautes-Alpes case study - b) Probable rockfall propagation zones (in orange, the release areas in red) determined with an ELA of 38° and using a 25x25m DTM for the Queyras area (zoom of the map on the scale of the Département des Hautes-Alpes case study).

The following figures show application of this methodology in other European countries in close collaborations with the PARAMount project partners.



**Figure 100:** Probable rockfalls propagation zones including the probable reaching frequency (in red the release areas) determined with an ELA of 32° and using a 1x1m LiDAR DTM for Forte buso case study (Italy).



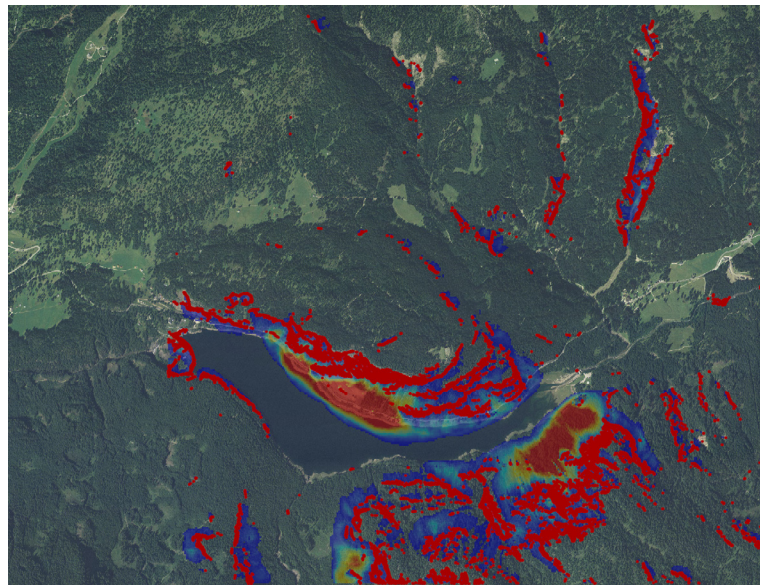


Figure 101: Probable rockfalls propagation zones including the probable reaching frequency (in red the release areas) determined with an ELA of 38° and using a 1x1m LiDAR DTM for Forte buso case study (Italy).

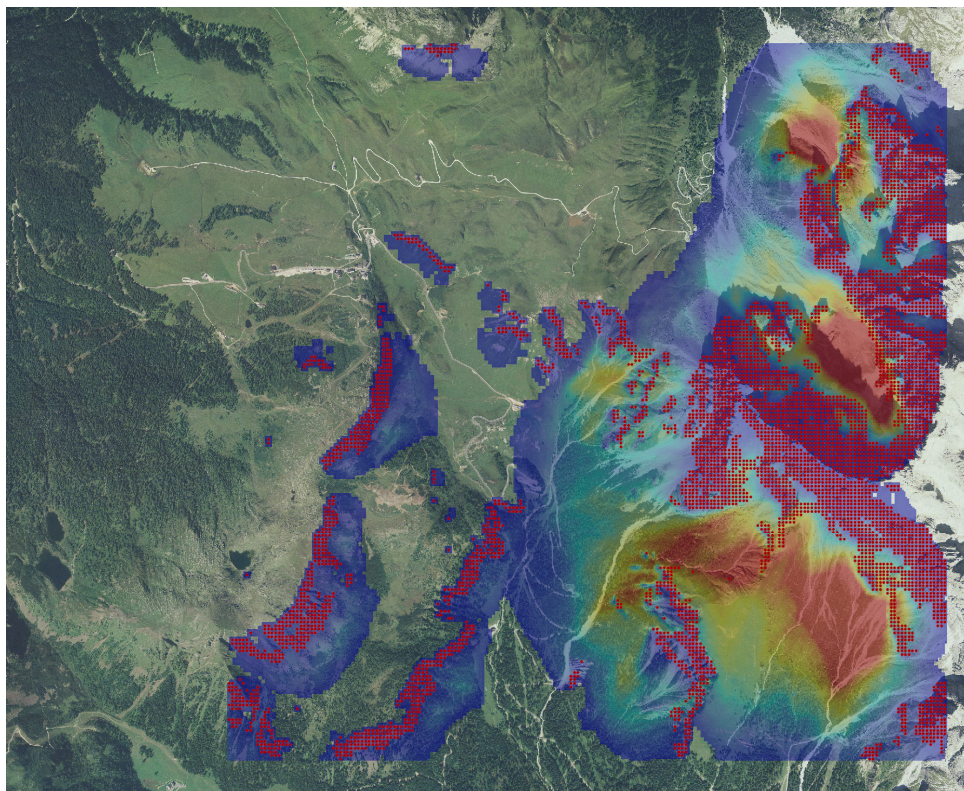
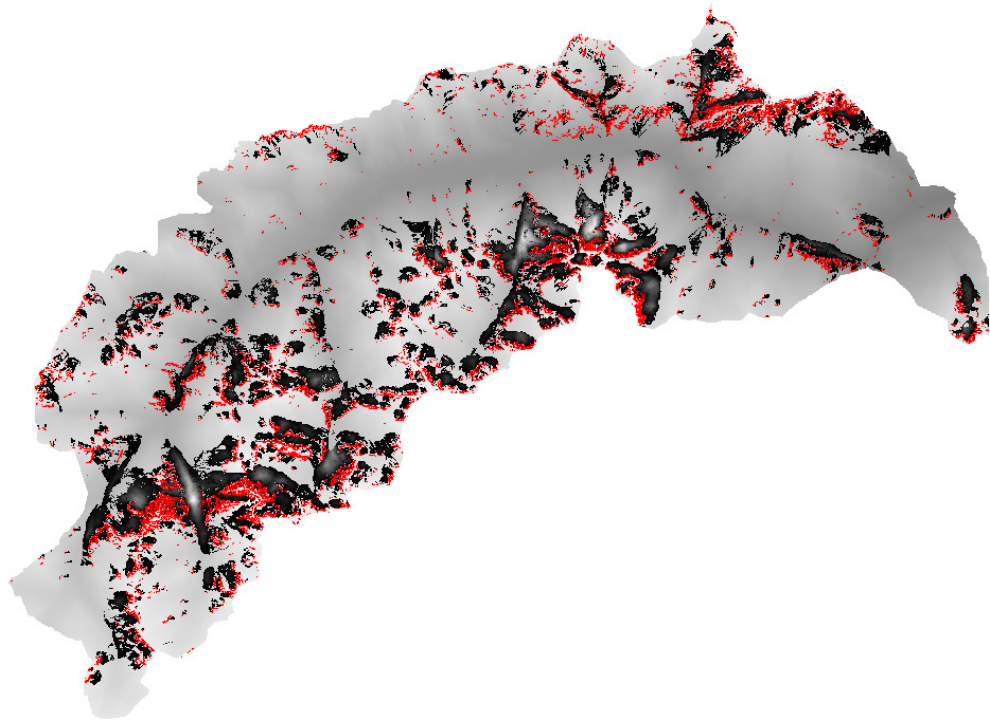
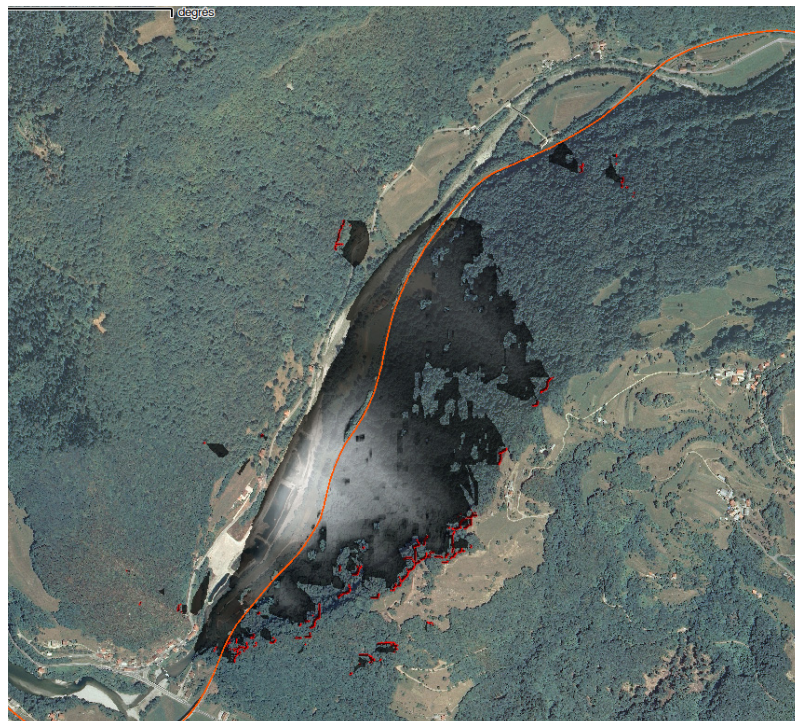


Figure 102: Probable rockfalls propagation zones including the probable reaching frequency (in red the release areas) determined with an ELA of 38° and using a 20x20m DTM for Tognazza Cavallazza case study (Italy).





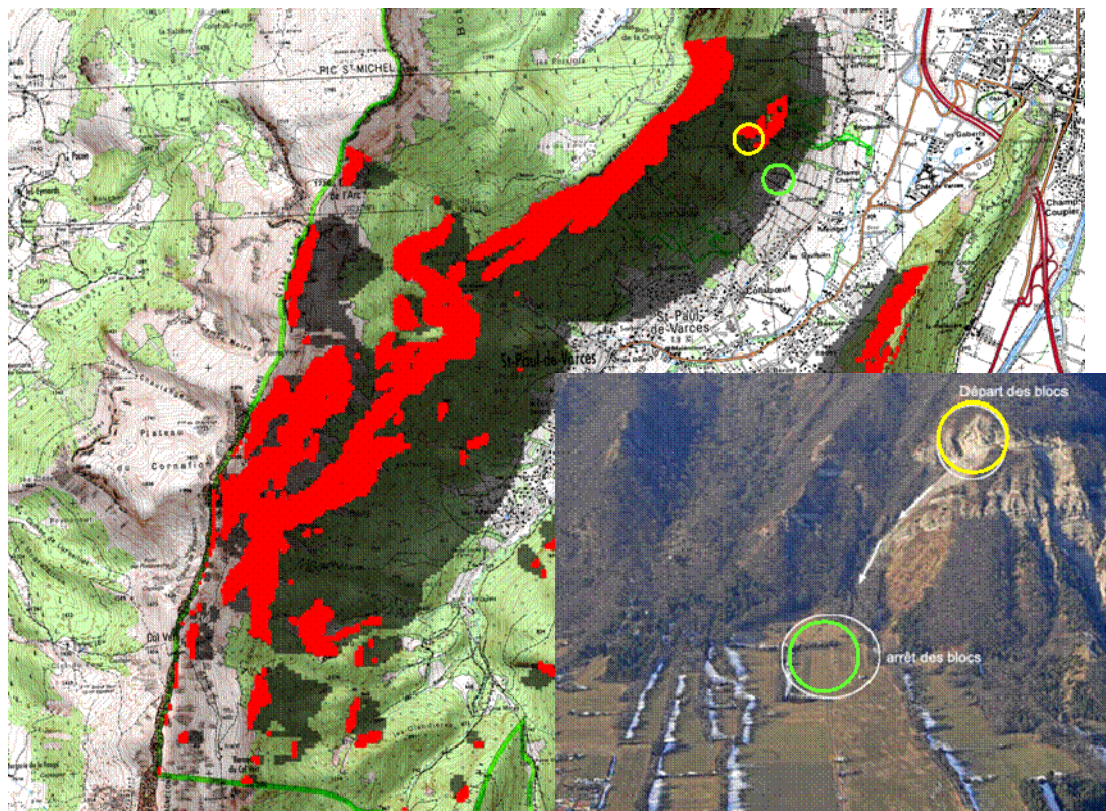
**Figure 103: Probable rockfalls propagation zones including the probable reaching frequency (in red the release areas) determined with an ELA of 32° for the Austrian case study.**



**Figure 104: Probable rockfalls propagation zones including the probable reaching frequency (in red the release areas) determined with an ELA of 32° for Baca case study (Slovenia).**

## Validation of Rockfor<sup>LIN</sup>

The RockFor<sup>LIN</sup> model has been validated using 20 well-documented past events. Each time the maximal run-out distance is at least included in the 32° ELA. The example below is the one of Saint Paul de Varcès in France. In this district a rockfall occurred on 28 December 2008. The observed trajectories fit with the 38° ELA propagation zone (the slope is forested). RockFor<sup>LIN</sup> has succeeded in identifying the release area (circle in yellow on the map and the photo) and the maximal run-out point (green circle on the map and the photo, Figure 105).



**Figure 105: An example of validation of the results obtained with RockFor<sup>LIN</sup> based on the event of the 28/12/2008 in the district of saint Paul de Varcès in France**

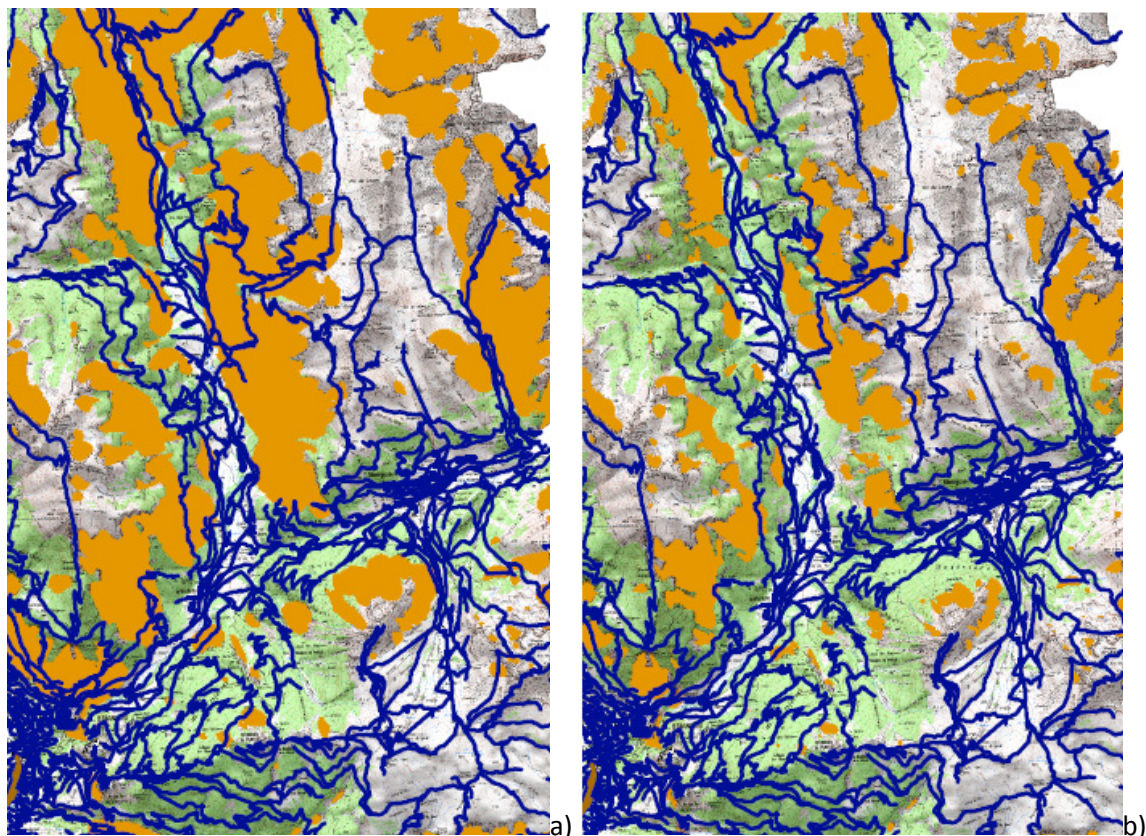
It is very important to remind users that the results obtained with RockFor<sup>LIN</sup> must always be compared with known events in the case study. If the observed run-out distances differ from the one calculated with RockFor<sup>LIN</sup>, then the value of the ELA has to be adapted.

## Rockfall risk mapping with Rockfor<sup>LIN</sup>



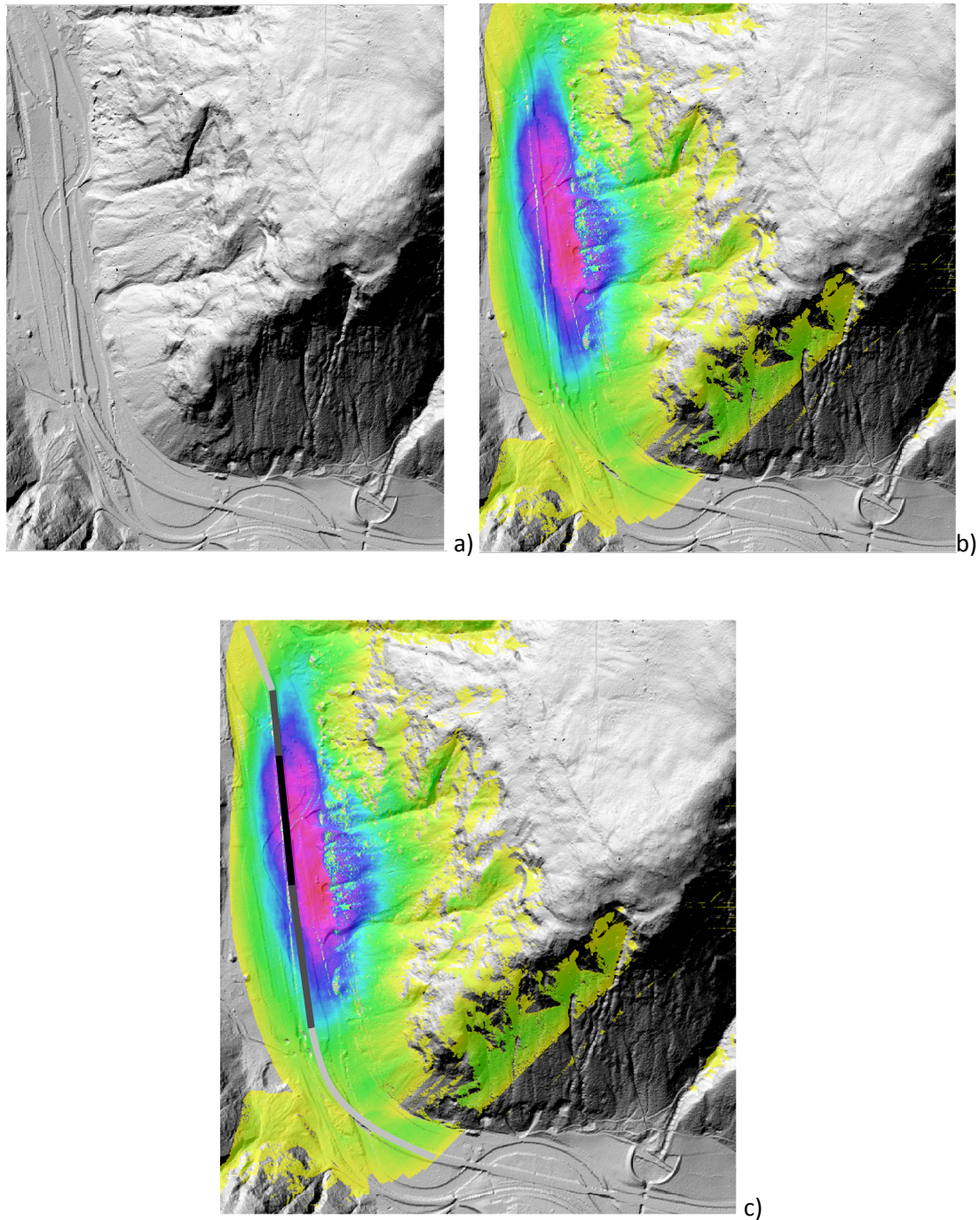
The last step of a risk mapping is to determine whether socioeconomic assets are endangered by the natural hazard under consideration. Good information on the location of facilities is then required. On a regional scale, each of the Alpine Space countries can find this information in the geographic database of their respective national geographic institutes.

Usually these databases list and correspondently map all human infrastructures: public facilities, dwellings, industries, as well as communication, electrical, gas and water infrastructures, etc. According to their importance or their extent, all these items can be classified into protection priority levels. This ranking is not obligatory, but facilitates the definition of priority levels for specific protective measures, depending firstly on the importance of the issues and secondly on the hazard's specifications. This ranking needs to be defined jointly by all actors involved in the risk prevention policy of the study area. By combining this map with the rockfalls run-out envelope map, the potentially endangered infrastructure can be identified by selecting all the items located between release points and run-out envelopes. The map obtained includes the endangered areas and the associated release and run-out zones. If the 'areas at risk' map is available, then RockFor<sup>LN</sup> performs the analysis automatically by map crossing. The following maps (Figure 106) illustrate different ways of presenting the results of this risk analysis.



**Figure 106: a) Probable rockfalls 32° ELA propagation zones (in orange) and human infrastructures localisation for the Queyras area (zoom of the map on the scale of the Département des Hautes-Alpes case study - (road networks in blue) b) Probable rockfalls' 38° ELA propagation zones (in orange) and human infrastructures localisation for the Queyras area (zoom of the map on the scale of the Département des Hautes-Alpes case study).**

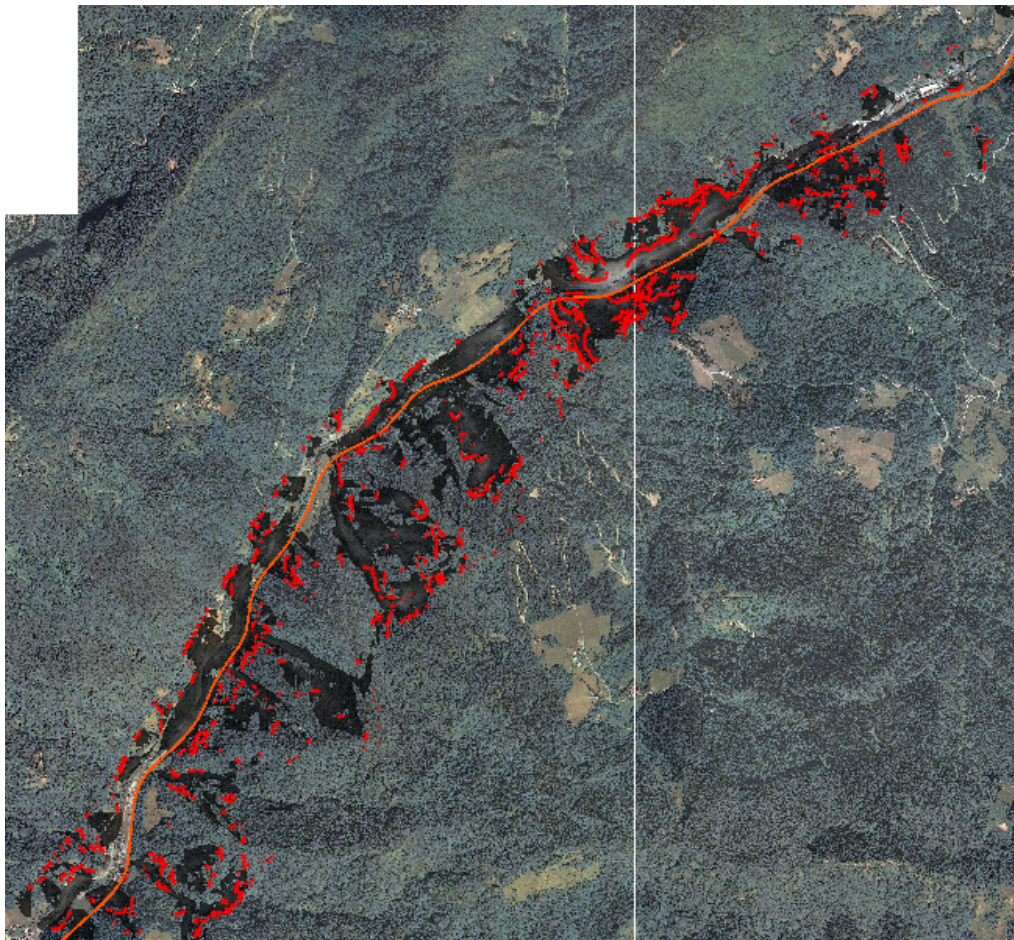




**Figure 107** :Illustration of the identification of endangered issues using the rockfalls propagation map provided by RockFor<sup>LIN</sup> for the case study Mittewald in Italy

The a) figure corresponds to 1x1m LiDAR DTM. The figure b) corresponds to the 32° ELA (Energy Line Angle) rockfalls propagation zone including the reaching probability. The figure c) identifies the sections of the road endangered and risk ranking using the reaching probability: sections in black = high level of risk, section in dark grey = medium level of risk, section in soft grey = low level of risk, no colour = no risk.





### Rockfalls protection forest mapping with Rockfor<sup>LIN</sup>

The protection forestmapping is the last step of the risk analysis than can be done with RockFor<sup>LIN</sup>. The general principle is to cross the map of endangered items with the map showing the geographical extension of forest stands. This forest map can be the one provided by National Forest Inventories or the one available to the forest services. As the mapping is made on a regional scale, the dendrometrical description of the forest stands is not required. The information required consists in the surfaces covered by forest. Identification of forest stands potentially serving a protective function is then obtained by combining the endangered items map with the forest cover map, and by selecting all forested areas located above an endangered item and on/or between the associated release and run-out zones. This selection is supplied automatically by RockFor<sup>LIN</sup>.

This map of potential protection forest areas needs to be validated by a field survey. But before this, it can be used to define an area within which forest management dedicated to the improvement of the protective function would be recommended. In other words, this map defines the potential area for the application of protection forest management guidelines.

The strength of this methodology lies in its ability to display the area within which forests are able to provide a protective function against rockfalls; often such areas are unknown having not been previously identified. A decrease in forest canopy in these protection forest areas could have dramatic consequences requiring adaptations to forest management with a view to ensuring the



sustainability of this protective function. The following maps (Figure 108, Figure 109) present examples of the results of the potential protection forest mapping performed with RockFor<sup>LIN</sup>.

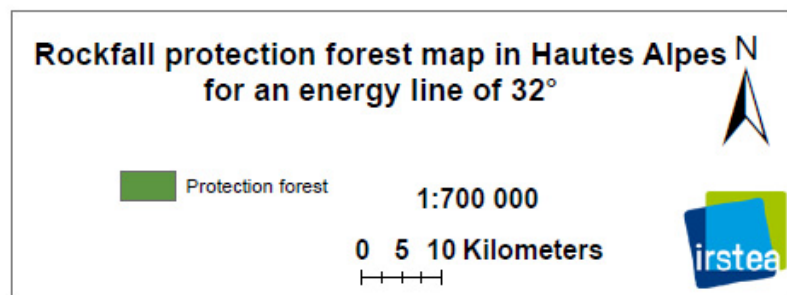
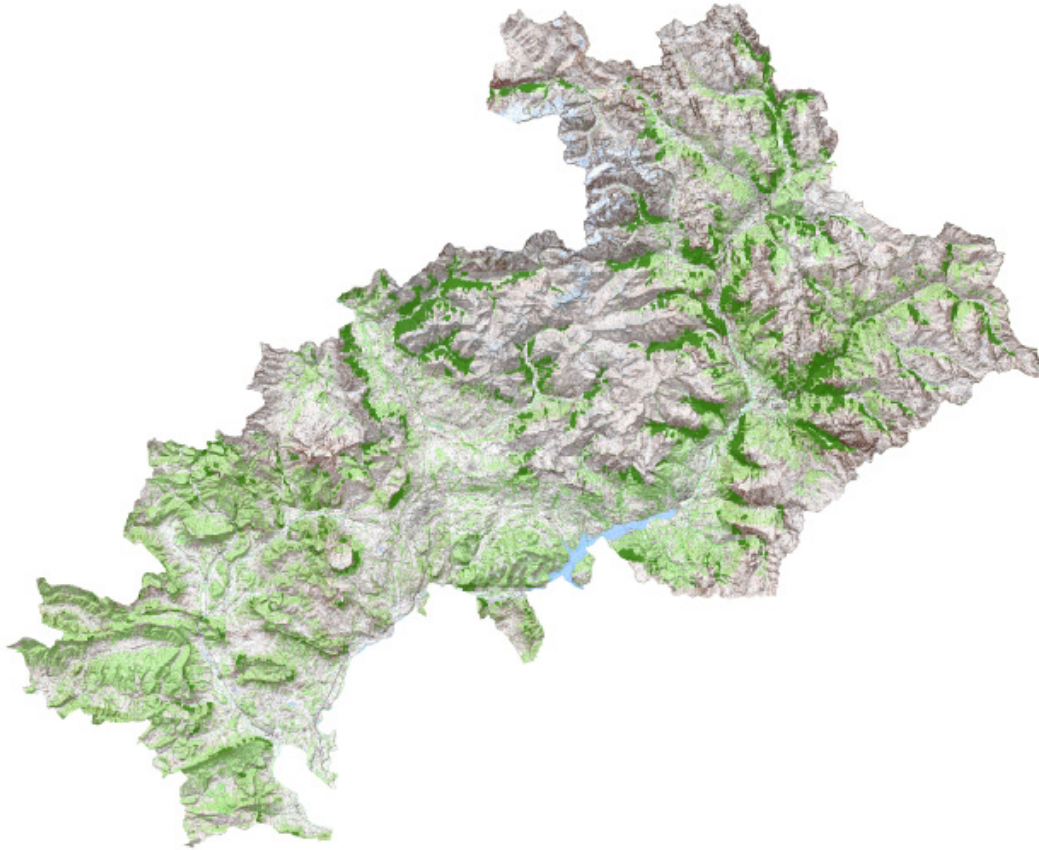
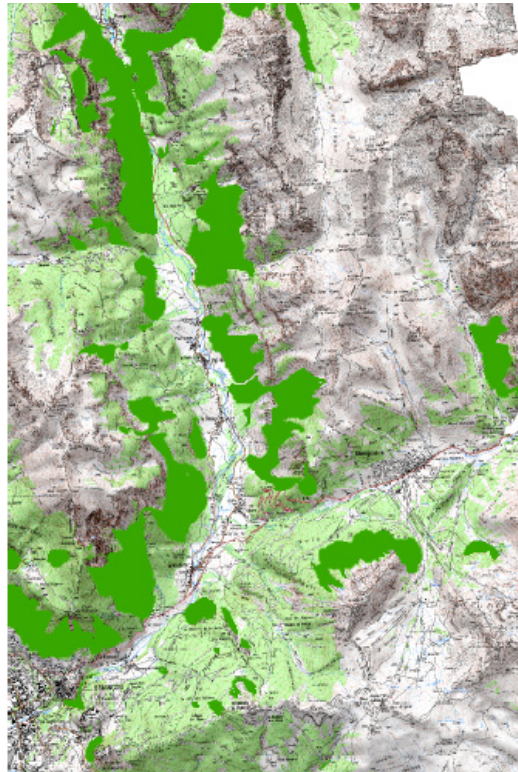


Figure 108: Rockfalls potential protection forest map obtained with RockFor<sup>LIN</sup>, and using a 25x25m DTM, for the French Département des Hautes-Alpes case study



**Figure 109: Rockfall potential protection forest (in green) map obtained with RockFor<sup>LIN</sup> (property of Irstea), and using a 25x25m DTM, for the French Queyras case study (zoom of the map on the scale of the Département des Hautes-Alpes case study)**

### **Avalanche hazard mapping with Avalfor<sup>LIN</sup>**

As shown in the introductory chapter, the general process of avalanche hazard mapping is based on the answers to the following questions:

1. Where are the release areas?
2. What is the maximum propagation area envelope?
3. Is any human infrastructure located in the propagation area and if so, is it endangered?
4. Are any forest stands located in the release area and/or in the propagation area above the human infrastructure endangered?

Having regard to the quality of the results obtained for rockfalls risk assessment with our tool Rockfor<sup>LIN</sup> tool, we have decided to use the same concept for avalanche risk assessment. So we have developed the Avalfor<sup>LIN</sup> model. This model allows natural risk experts to provide a avalanche risk assessment of a large geographical scale as well as on the regional one. As with rockfalls, the input data necessary to use Avalfor<sup>LIN</sup> are: a DTM, the map of socioeconomic issues, the forest map and, if possible, a past events database.

Like Rockfor<sup>LIN</sup>, Avalfor<sup>LIN</sup> is a 2D raster GIS model developed by Irstea. The main differences between Rockfor<sup>LIN</sup> and Avalfor<sup>LIN</sup> are:

1. The number of criteria to be used for determining the potential release areas
2. The use of a double angle Energy Line Angle model
3. The calculations are made using the travel angle.

As with rockfall risk assessment conducted with Rockfor<sup>LIN</sup>, those made with Avalfor<sup>LIN</sup> need a field survey to be validated. Due to the fact that only topographical criteria are used and according to the

DTM resolution and accuracy, some risk conditions can be underestimated or overestimated. Only a comparison with the register of past events and/or a campaign of field investigation can identify the error involved. If this validation phase is not provided then the results obtained with Avalfor<sup>LIN</sup> allow us only to propose a pre-mapping which gives a preliminary overview of the potential situation. Depending on the objectives, the input data needed for the use of Avalfor<sup>LIN</sup> are the following ones:

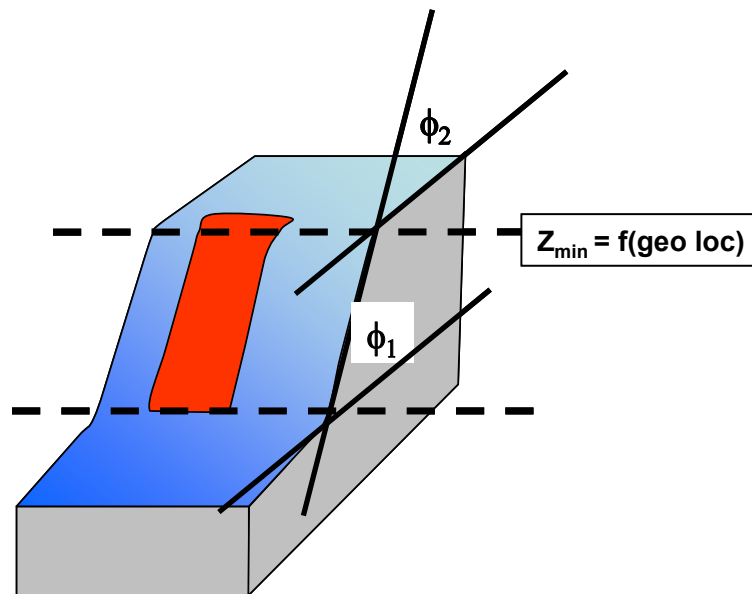
Objectives	Input data: raster maps (the resolutions can be different but the minimal resolution is the one of the DTM)			
	DTM	Past event registers or any geo-localised information	Human infrastructures	Forest map
Release zone mapping				
Run-out zone mapping				
Risk mapping				
Protection forest mapping				

### Avalanche release areas mapping with Avalfor<sup>LIN</sup>

Avalfor<sup>LIN</sup> can only be used if all potential avalanche release points have been mapped. This mapping can be done via field surveys, aerial photography analysis, past events database analysis or numerical processing on the DTM. Avalfor<sup>LIN</sup> offers the possibility of performing a DTM analysis to identify potential avalanche release areas over a large geographical sector.

The assumptions which have been used are that the release areas depend only on the topographical conditions and the altitude of the case study. So, simple slope thresholds can be applied to the slope surface raster (computed from the raster Digital Terrain Model [DTM]). The resolution and the accuracy of the DTM affect the results. The release area modulus of Avalfor<sup>LIN</sup> was initially developed for a DTM resolution of 25x25m. For lower DTM resolutions, as for example LiDAR DTM of 1x1m, Avalfor<sup>LIN</sup> automatically generates a DTM of 20x20m and then applies the criteria and the associated thresholds used for a 25x25m resolution.

For avalanches, the four criteria used for release area mapping are the curvature, the slope, the altitude and the surface. The thresholds of these criteria depend on regional and geoclimatic conditions. Commonly in the European Alps, all cells in 25x25m raster DTM with a slope of 28- 55 degrees, a convex form, an altitude higher than 1000m and a minimal surface of 500m<sup>2</sup> are considered as potential release zones for avalanches.



**Figure 110: The main criteria for the determination of avalanche release areas using a DTM raster**

The table below (Figure 111) gives the thresholds of the criteria used within Avalfor<sup>LIN</sup> for the determination of avalanche release areas with a 20x20m or a 25x25m DTM. These criteria and the associated thresholds have been selected from the scientific literature published on this subject.

Alpine region	Slope ( $\phi_1$ )	Minimal area	Convexity index (based on the curvature function of ArcGIS and related to $\phi_2 - \phi_1$ )	Altitude min (Zmin)
Northern and Western Alps	28 - 55°	$\geq 500\text{m}^2$	-0.5	800m
Southern and Western Alps				1250m
Central Alps				1000m
Jura				700m

**Figure 111: Criteria thresholds, using a 20x20m or 25x25m raster DTM, for determining avalanche release areas within Avalfor<sup>LIN</sup>**

The first step for the Avalfor<sup>LIN</sup> user is to select the Alpine region and the country for which the analysis will be provided. The thresholds and the values of the propagation model to be used are then automatically selected by Avalfor<sup>LIN</sup>. Finally, applications have been done in the French (Figure 117), Italian (Figure 112, Figure 113, Figure 114) and Austrian case studies (Figure 115, Figure 116).



The following figure and maps present the results obtain with a 1x1m LiDAR DTM resampled to 20x20 m for the Italian case studies and with a 25x25m DTM for Austrian and French case studies. For the Italian and the French case studies the maps present also the validation phase using the past event cadastre.

With the snow avalanche release area modulus of Avalfor<sup>LIN</sup>, each recorded past event has at least in the upper part of its mapped envelop one release area according to the criteria used within Avalfor<sup>LIN</sup>.

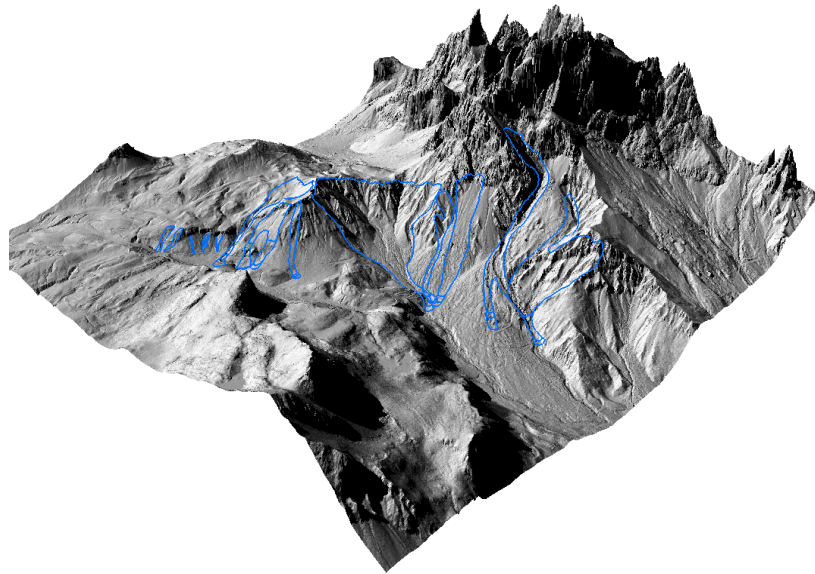


Figure 112: 3D view (derived form a 1x1m LiDAR DTM) of the Italian case study “Passo Rolle” with the draping of the snow avalanches past events cadastre

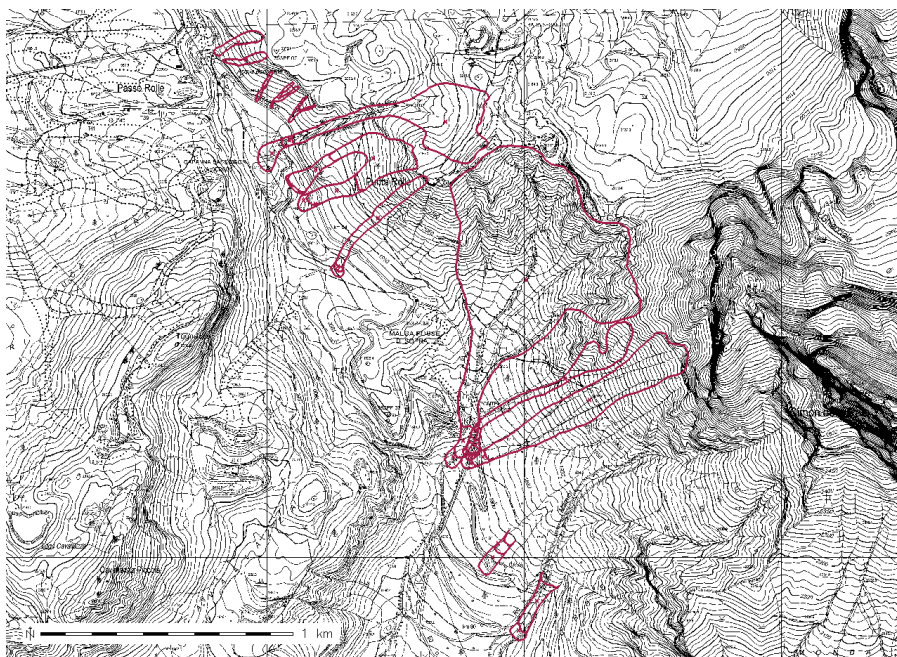


Figure 113: Snow avalanches past events cadastre of the Italian case study “Passo Rolle”



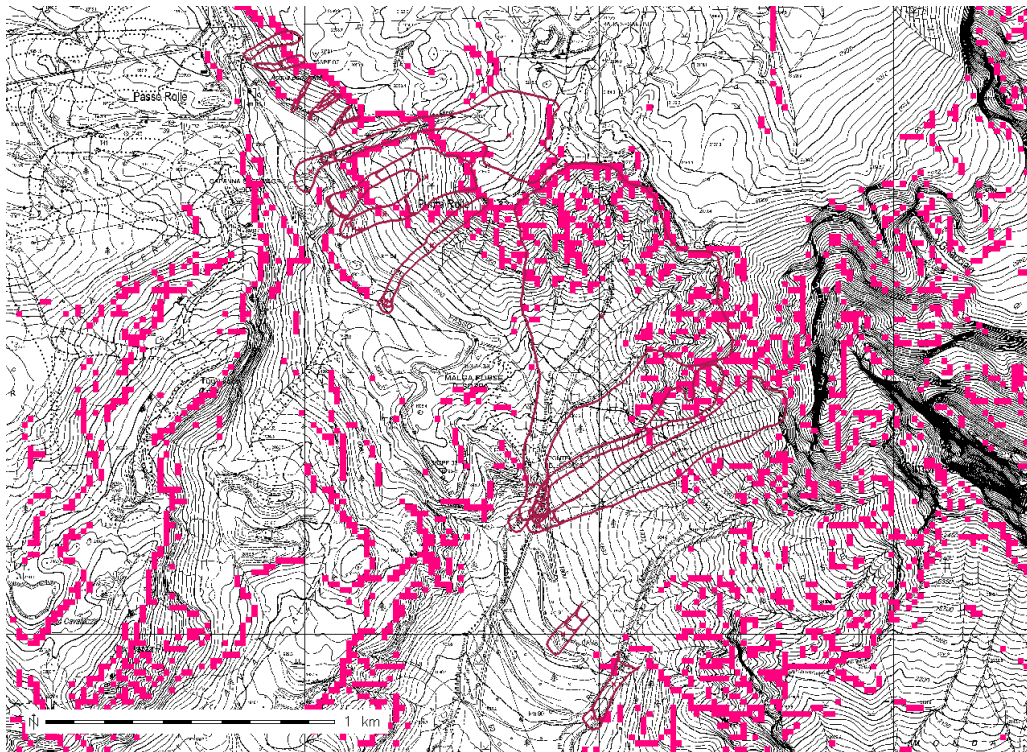


Figure 114: Snow avalanches release areas (in pink) determined with Avalfor<sup>LIN</sup> for the Italian case study “Passo Rolle”. The initial 1x1m Lidar DTM has been resampled to 20x20m.

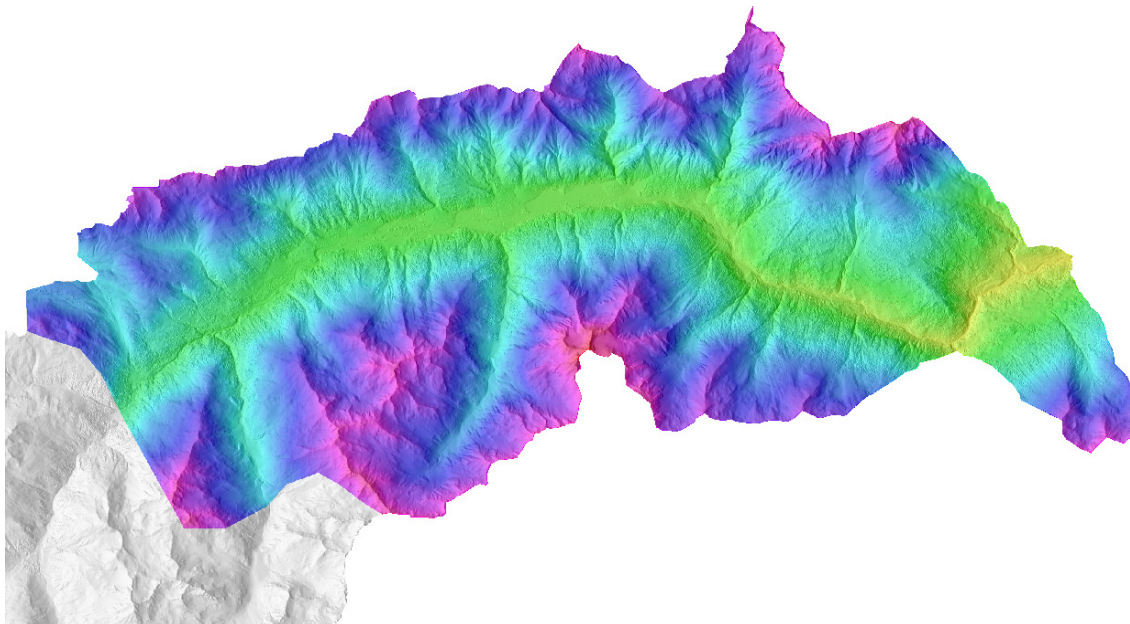


Figure 115: The DTM (expressed using the altitudinal range) of the Austrian case study of the Paramount project.



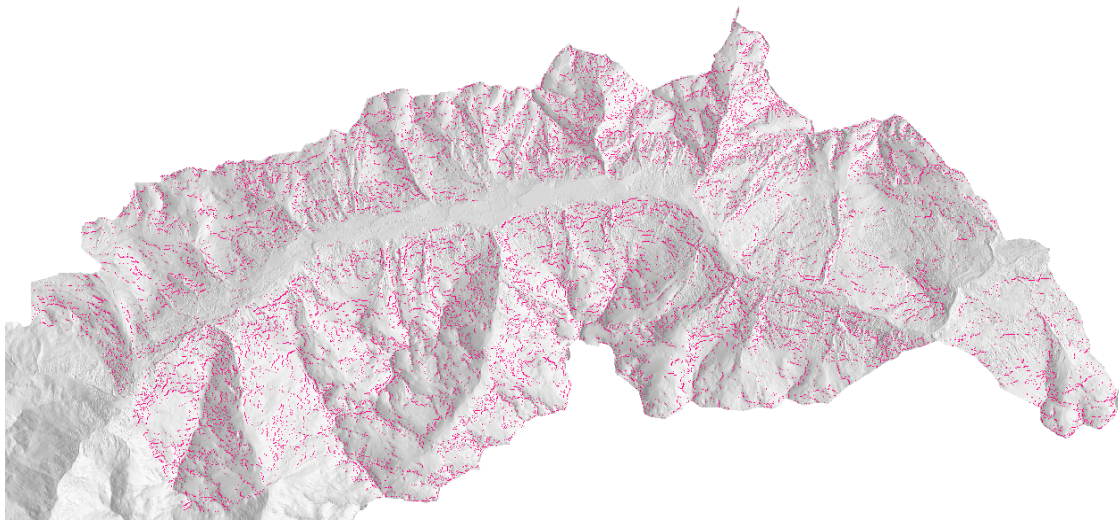


Figure 116: The localization, using Avalfor<sup>LIN</sup>, of potential snow avalanche release areas (in pink) in the Austrian case study of the Paramount project.

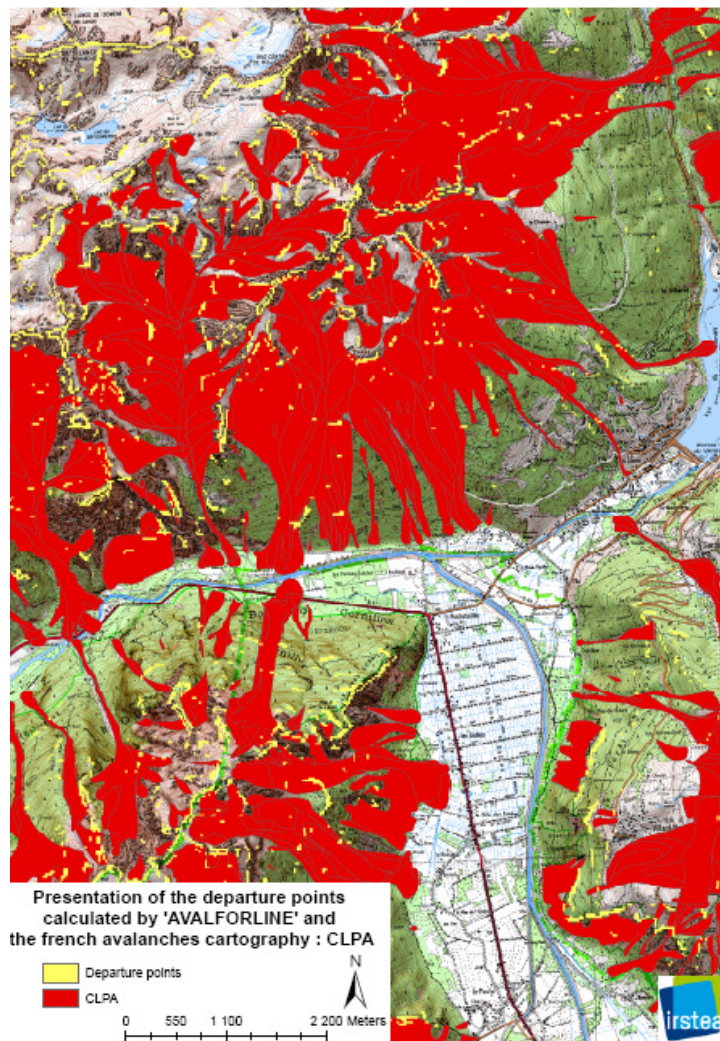


Figure 117: The localisation, using Avalfor<sup>LIN</sup>, of potential avalanche release areas (in yellow) in one of the French sites of the Paramount project. The envelopes in red correspond to the past event cadastre (called

## CLPA in French, Carte de Localisation de Phénomènes d'Avalanche [Localisation Map of Avalanche Phenomena]

### Avalanche potential maximal run-out area mapping with Avalfor<sup>LIN</sup>

AvalFor<sup>LIN</sup> for avalanches is also based on the Energy Line Angle concept initially formulated by Heim in 1932 and successfully adapted to the avalanche context by Lied in 1979. As with rockfalls, the maximal probable avalanche run-out envelope is determined by the creation of an intersection point between the ground and an imaginary line drawn from the release point with a calibrated angle. The first difference from the ELA for rockfalls is that for avalanches this angle ( $\alpha$ ) is determined using the value of an intermediary Energy Line Angle ( $\beta$ ) calculated for the first upper point on the slope for which the slope angle is equal to  $10^\circ$  (cf. Figure 118). The relation between  $\alpha$  and  $\beta$ ,  $\alpha = a\beta + b$ , is determined using recorded and mapped past events.

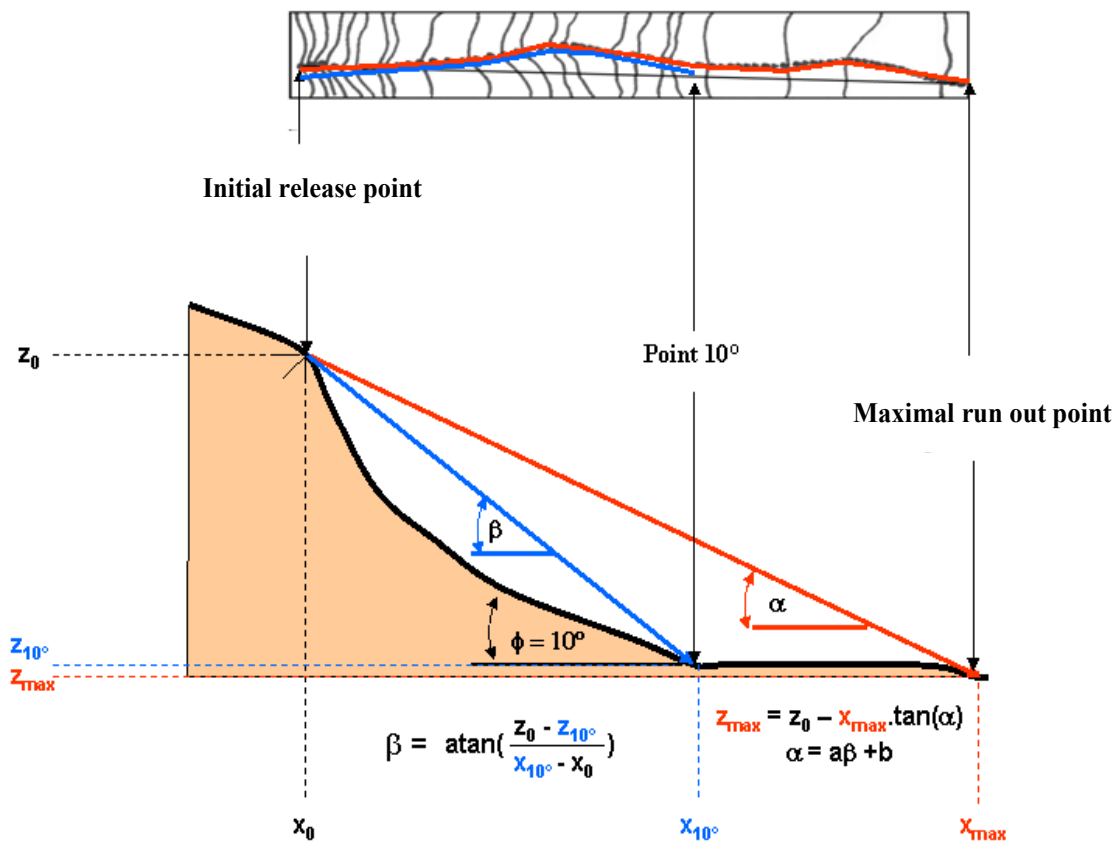
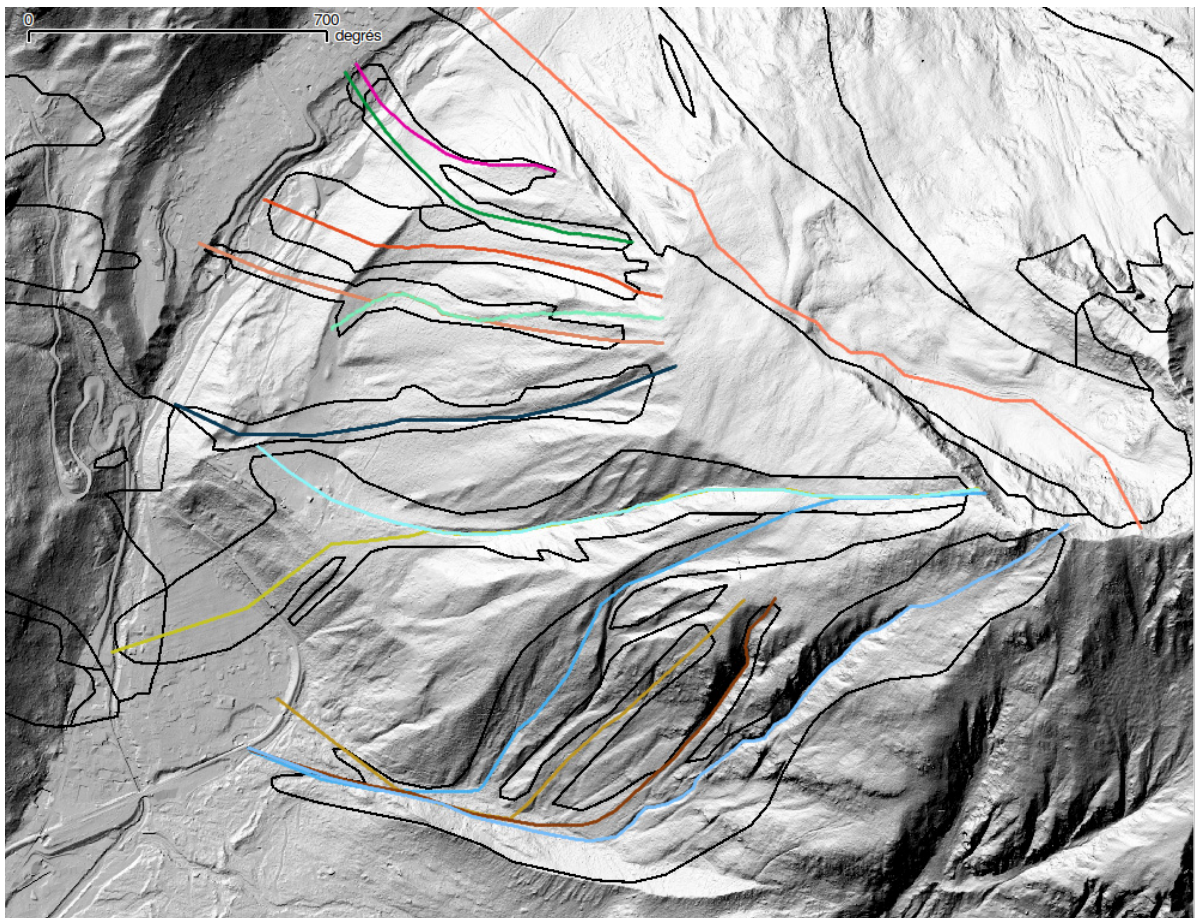


Figure 118: The avalanche Energy Line Angle concept

The second difference from the ELA for rockfalls is that for avalanches the travel angles are used and not the geometrical ones. So the calibration of this ( $\alpha, \beta$ ) model needs to determine the travel path using the principle of computed water flow direction along the steepest slope. Most GIS systems are able to provide such calculations using a DTM raster.



The robustness of the model calibrated using past events data depends both on the accuracy of the mapped past events' envelopes and on the resolution of the DTM used for the data processing. In France, Chamonix was used as a site for the calibration of a French  $(\alpha, \beta)$  model and for the analysis of the influence of the DTM resolution on the model's parameters. A 25x25m DTM and a 1x1m Lidar DTM were used. Figure 119 presents an extract from the French avalanche past events register of this site and the travel path used for the calibration of the  $(\alpha, \beta)$  model. With the 25x25m DTM the linear correlation between  $\alpha, \beta$  is  $\alpha = 0.97\beta - 1.50$  with a regression coefficient of  $R^2 = 0.82$ . With the 1x1m LiDAR DTM this coefficient rises to 0.94 and the relation is  $\alpha = 1.00\beta - 1.67$  (cf. Figure 120, Figure 121). It is important to notice that for the minimal value ( $27.02^\circ$ ) of  $\beta$ , cited in the literature, the difference between the  $\alpha$  calculated with these two models is only one of  $0.64^\circ$ .



**Figure 119: An extract of the geographical data used for the  $(\alpha, \beta)$  model calibration for the French topographical conditions of the valley of Chamonix. The black lines represent the limits of the propagation envelopes of the past events and the coloured ones the travel path associated with each envelope.**

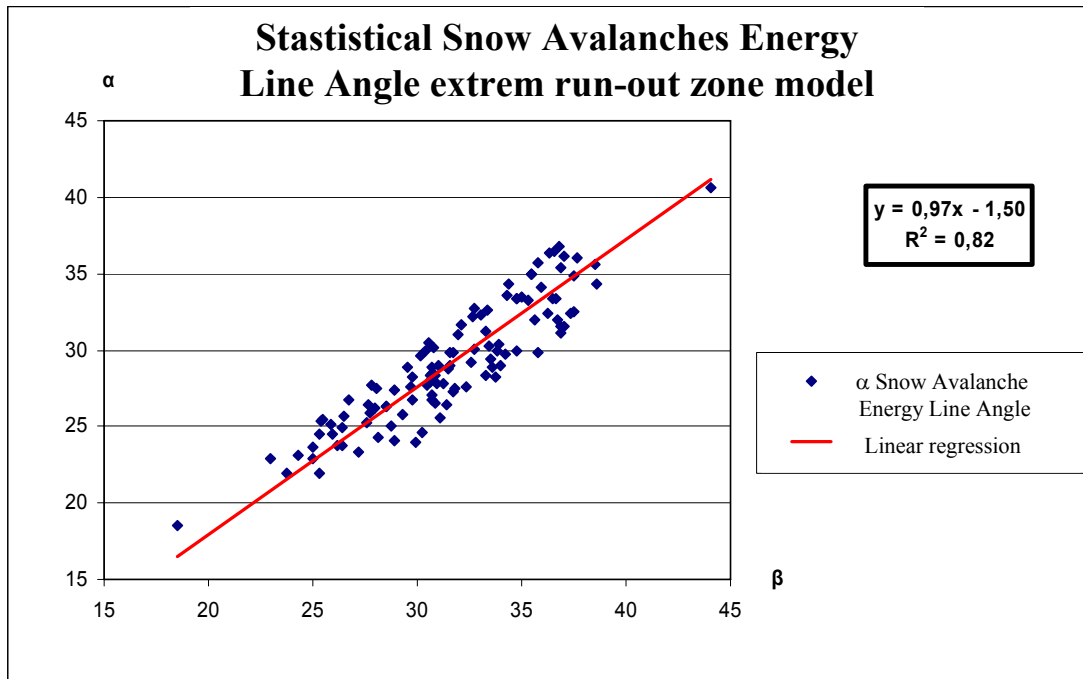


Figure 120: The ( $\alpha$ , $\beta$ ) model calibration using a 25x25m DTM for the French topographical conditions of the Valley of Chamonix

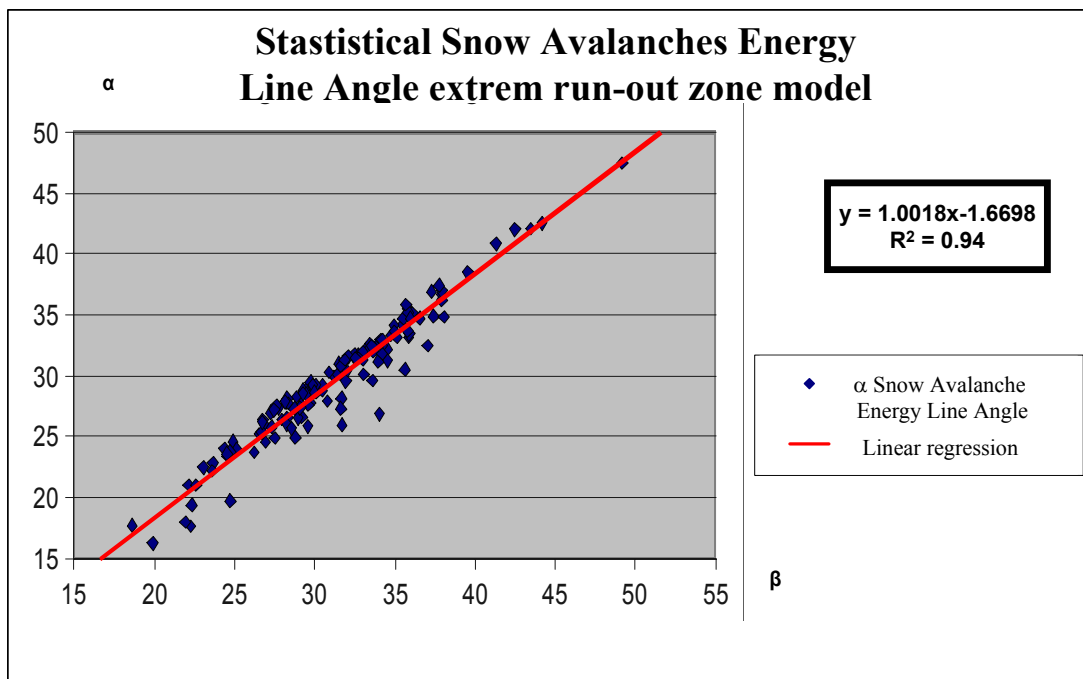


Figure 121: The ( $\alpha$ , $\beta$ ) model calibration using a 1x1m DTM for the French topographical conditions of the valley of Chamonix



Many authors have tested this  $(\alpha, \beta)$  model in different region of the world. The table below (Figure 122) gives the available value in the literature of this  $(\alpha, \beta)$  model for different countries (in red the parameters usable within the European space) and the statistics obtained with these data.

Country/ region	a	b	R <sup>2</sup>	$\sigma$	N	Mean $\alpha$ (°)	Mean $\beta$ (°)
Norway	0.93		0.86	2.10	192		
	0.94	0.20	0.89	1.74	127		
					423	31.00	
	0.96	-1.40	0.92	2.30	200	18.00	
Western Norway	0.90		0.87		127	29.40	32.60
Austria	0.95	-0.83	0.92	1.50	80		
Iceland	0.85		0.52	2.20	44		
Canadian mountains (High resolution)	0.93		0.89	1.10	35		
Canadian mountains (Low resolution)	0.93		0.89	1.05	35		
Canadian Rockies	0.93		0.75	1.75	126	27.80	29.80
Canadian Rockies	0.90	0.15	0.80	1.57	125	28.50	30.60
Canadian Coast Mountains	0.90		0.74	1.70	31	26.80	29.50
British Columbia	0.87	0.23	0.61	2.10	31		
Catalan Pyrenees	0.86	1.05	0.75	1.98	64	24.70	27.30
Alaska	0.86		0.58		52	25.40	29.60
Alaska	0.81	0.32	0.67	1.84	52		
Colorado	0.80		0.50		130	22.60	27.40
Colorado	0.77	0.14	0.51	2.31	130		
Sierra Nevada	0.76		0.60		90	20.70	26.10
Switzerland					50	28 (min 22°)	
French Northern Alps (Chamonix High resolution)	0.98	-1.00	0.90		103		
French Northern Alps (Chamonix+ Chablais High resolution)	1.00	-1.67	0.94		128		
French Northern Alps (Chamonix Low resolution)	0.97	-1.50	0.82		103		
Italy (Magafosse)	0.91	0.05	0.97		10		
					Mean	25.72	29.11
					$\sigma$	3.94	2.09
					min	21.41	27.02
					max	29.57	31.20

Figure 122: State of the art and associated statistics for the Energy Line Angle values,  $(\alpha, \beta)$  model, for avalanches

Within the Paramount project, an  $(\alpha, \beta)$  model has been calibrated for French, Italian and Austrian topographic conditions. These models are:

$$\text{France: } \alpha = 1.0018 * \beta - 1.6698; R^2 = 0.94$$

$$\text{Italy: } \alpha = 0.9074 * \beta + 0.0506; R^2 = 0.97$$

$$\text{Austria: } \alpha = 0.95 * \beta - 0.8; R^2 = 0.92$$

The following table (Figure 123) gives the different values and the differences of  $\alpha$  angle obtained with each of these models and using the minimal, mean and maximal  $\beta$  values of table 9.

	$\alpha_{\min}$ (°)	$\alpha_{\text{mean}}$ (°)	$\alpha_{\max}$ (°)
France	25.40	27.49	29.59
Italy	24.57	26.47	28.36
Austria	24.87	26.85	28.84

	$\Delta\alpha_{\min}$ (°)	$\Delta\alpha_{\text{mean}}$ (°)	$\Delta\alpha_{\max}$ (°)
F-I	0.83	1.03	1.22
F-At	0.53	0.64	0.75
I-At	-0.30	-0.39	-0.48

**Figure 123: The different values and the differences of  $\alpha$  angle obtained with the French, Italian and Austrian models**

Based on Figure 122 and the differences expressed in Figure 123, the concept of regional models presents itself. The same model could be used for Austria and Italy, but not for France. In view of the geographical proximity between Austria and Slovenia, the authors of the Avalfor<sup>LIN</sup> model have decided to use the Austrian model for Slovenian geographical conditions.

As  $(\alpha, \beta)$  models are 2D ones using water flow direction algorithms, they are not able to represent avalanches' spread-off in the run-out zone. This is the reason why in Avalfor<sup>LIN</sup> the potentiality of spread off in the run-out zone is expressed using a buffer zone around the calculated maximal run-out point. The width of this buffer zone depends on the local slope morphology. The maximal width of the buffer zone has been fixed at 220m. This value corresponds to the standard deviation (5.17°) of  $\alpha$  calculated with the data set for the calibration of the regional models. The use of this buffer zone increases the reliable interval of the models. The following maps (Figure 129, Figure 130) present the result of the avalanche mapping for the French case study.

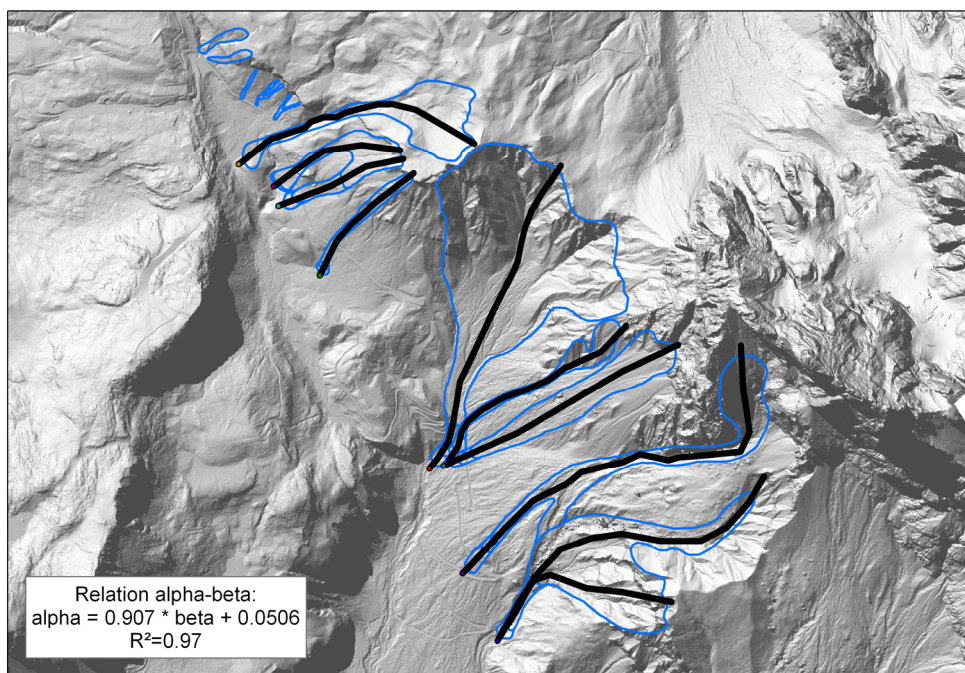


Figure 124: Snow avalanches past events data used for the calibration of the Italian model for the Italian case study “Passo Rolle”. The initial 1x1m Lidar DTM has been resampled to 20x20m.

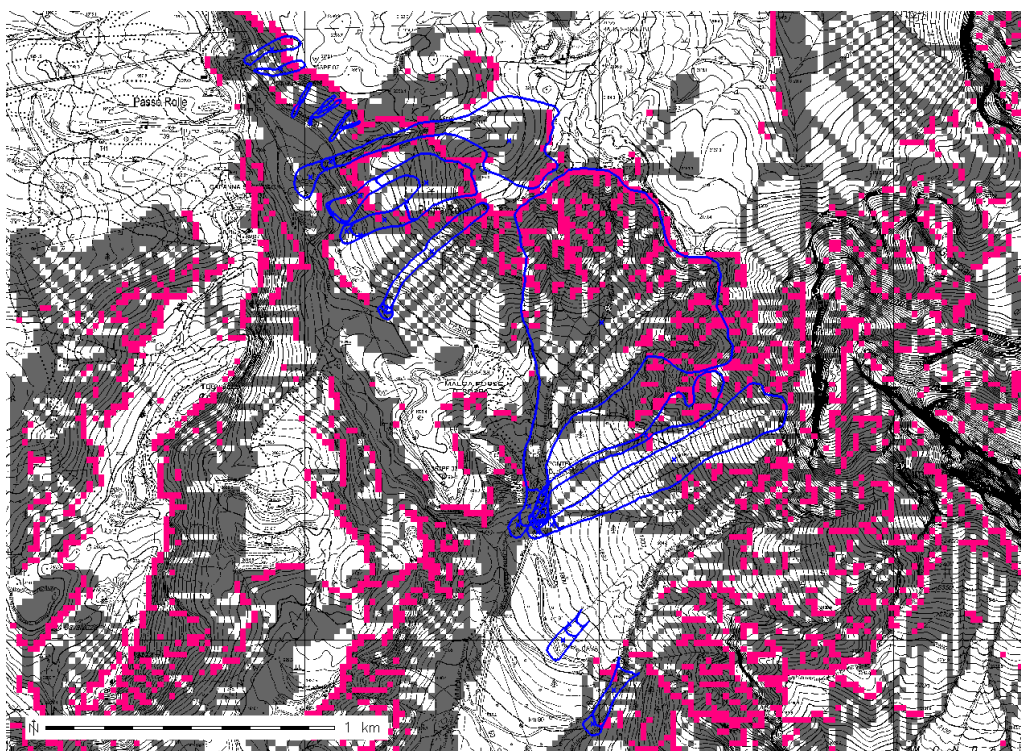


Figure 125 : Snow avalanches hazard mapping with Avalfor<sup>LIN</sup> for the Italian case study “Passo Rolle”. The initial 1x1m Lidar DTM has been resampled to 20x20m. In red the release areas, in grey the run-out zones and in blue the recorded past event data.

The following maps present for the Austrian case study the result of the snow avalanche mapping obtained with Avalfor<sup>LIN</sup>. The Figure 126 gives an illustration of the watershed and water flow



direction calculations within Avalor<sup>LIN</sup>. The Figure 127 represents only the travel paths and the buffer zones calculated at the run-out point.

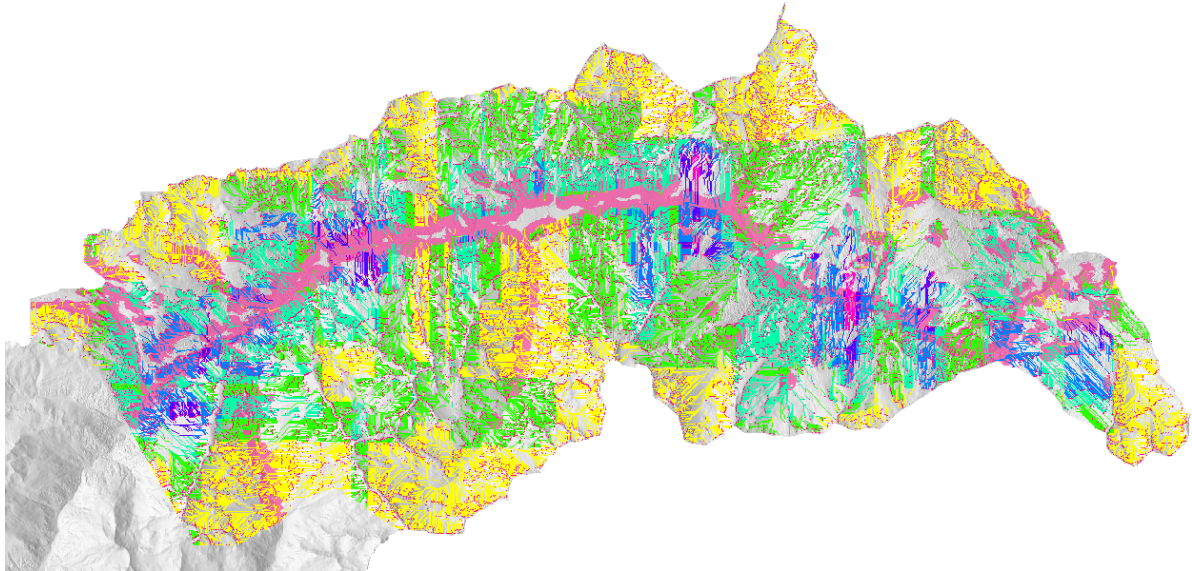


Figure 126: the result of the watershed analyses (in yellow, green and blue) including the determination of the travel paths, and of the buffer zones (in pink) calculation at the run-out point using Avalor<sup>LIN</sup>, in the Austrian case study of the Paramount project.

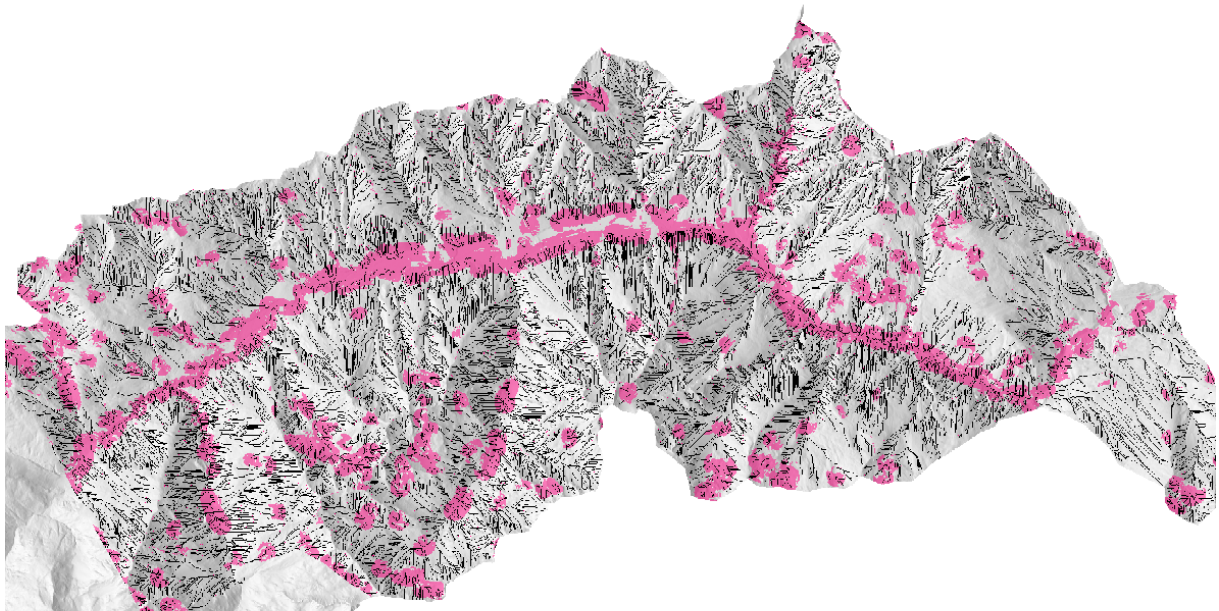
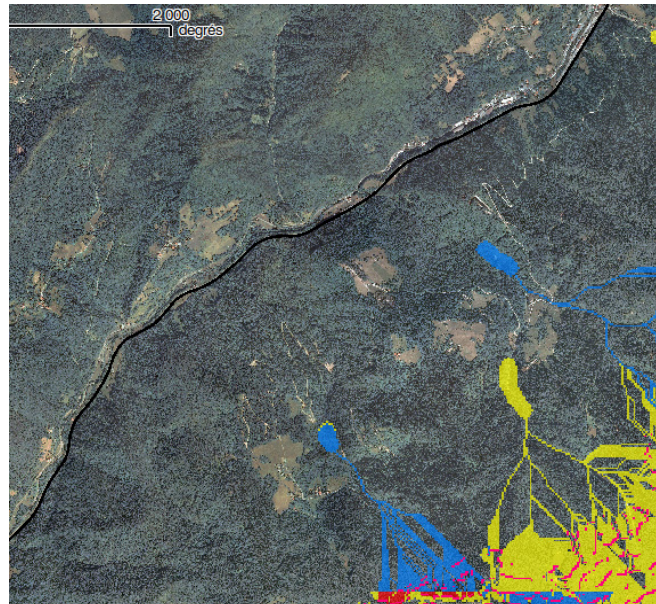


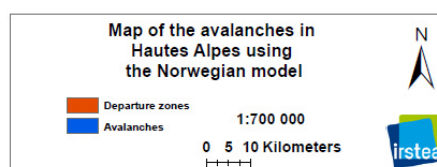
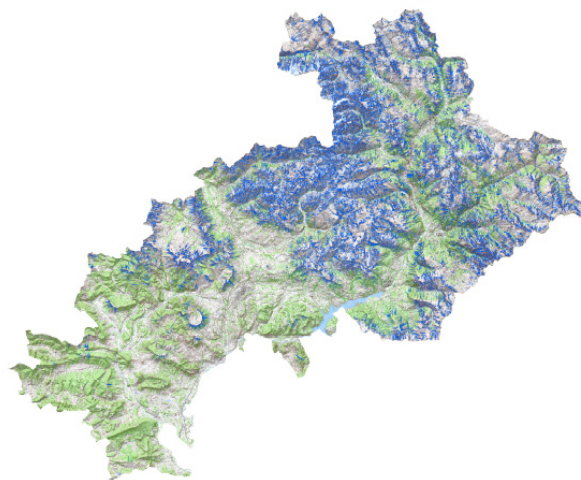
Figure 127: the result of the travel paths, and of the buffer zones (in pink) calculation at the run-out point using Avalor<sup>LIN</sup>, in the Austrian case study of the Paramount project.



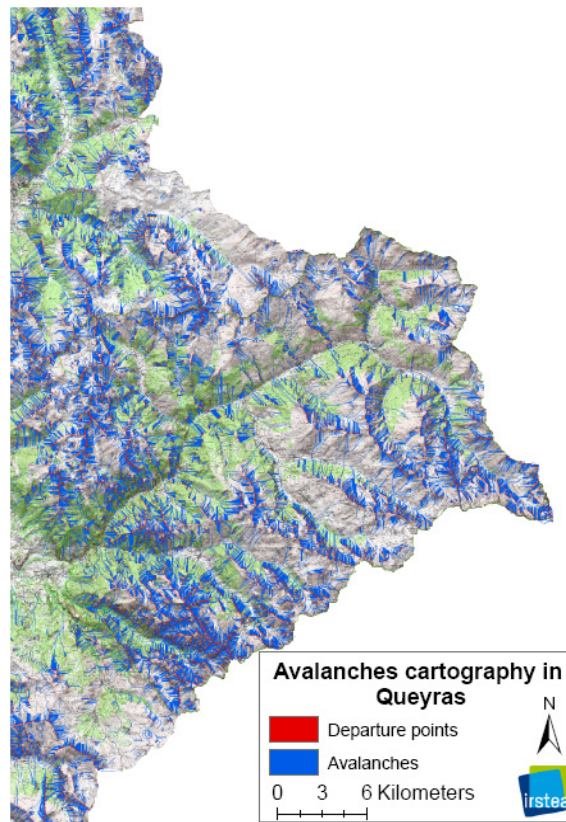
The maps below present the results for the Slovenian ( Figure 128) and French case studies (Figure 129, Figure 130).



**Figure 128:** extract of the snow avalanches hazard map for one of the Slovenian cases studies. In red the release areas, in blue and yellow simulated avalanche paths and run-out zones.



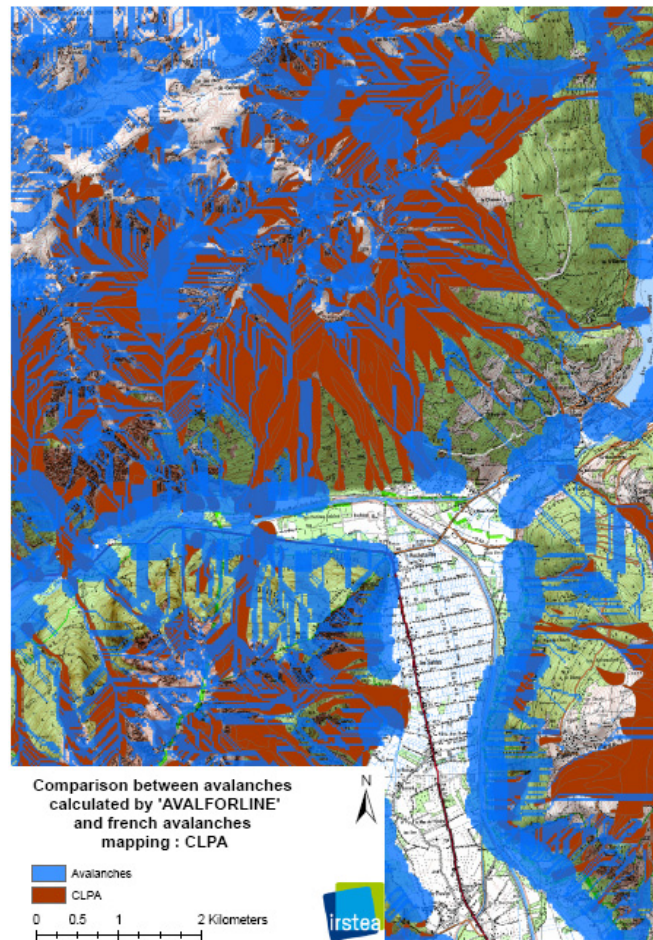
**Figure 129: Avalanche hazard map obtained with Avalfor<sup>LIN</sup>, and using a 25x25m DTM, for the French Département des Hautes-Alpes case study**



**Figure 130: Detail of avalanche hazard map obtained with Avalfor<sup>LIN</sup>, and using a 25x25m DTM, for the French Queyras case study (zoom of the map on the scale of the Département des Hautes-Alpes case study)**

### Validation of Avalfor<sup>LIN</sup>

The model Avalfor<sup>LIN</sup> has been validated, using for each case study some past events which have not been used for the  $(\alpha, \beta)$  model calibration. Each time the maximal run-out distance is at least included in the buffered run-out zone calculated with Avalfor<sup>LIN</sup>. The validation of this tool has also been made using registers from another source than those of the case studies. The map below (Figure 114) presents, for a French site located not in the Département des Hautes Alpes (PARAMOUNT French case study) but in another administrative district (Département de l'Isère), a confrontation of the Avalfor<sup>LIN</sup> results with the register of past events.



**Figure 131: An example of validation of the results obtained with Avalfor<sup>LIN</sup> using the past event database of a different French site from the one used for the calibration of the French  $(\alpha, \beta)$  model**

During the winter 2011-2012 an avalanche occurred in a French ski resort, and this event has been very well documented. Avalfor<sup>LIN</sup> has been used, without any post-calibration, in order to test the release area and run-out algorithms. Avalfor<sup>LIN</sup> was able to identify the release area (circle in yellow on the map and the photo, Figure 132) and the travel path of the avalanche. This event destroyed a chairlift station (green circle on the map and the photo); this chairlift station also matches the run-out of this event.





**Figure 132: An example of validation of the results obtained with Avalfor<sup>LIN</sup> using a real event which had occurred in another region than the one used for the calibration of the French ( $\alpha, \beta$ ) model. In red the release are determined with Avalfor<sup>LIN</sup>, in blue the travel path determined with Avalfor<sup>LIN</sup>, in the circles the real zones (yellow = release area, green = stopping point).**

It is very important to remind users that the results obtained with Avalfor<sup>LIN</sup> must always be compared with known events in the case study. If the observed run-out distances are longer than the one calculated with Avalfor<sup>LIN</sup>, then the ( $\alpha, \beta$ ) model used has to be changed, either by selecting another Alpine region given by Avalfor<sup>LIN</sup> or by recalibrating the model.

### Avalanche risk mapping with Avalfor<sup>LIN</sup>

The process used within Avalfor<sup>LIN</sup> for identifying the human infrastructures endangered by avalanches is exactly the same as that for rockfalls using Rockfor<sup>LIN</sup>. Here is the text of 'Rockfall risk mapping with Rockfor<sup>LIN</sup>' once again:

*The last step of a risk mapping is to determine whether socioeconomic assets are endangered by the natural hazard under consideration. Good information on the location of facilities is then required. On a regional scale, each of the Alpine region countries can find this information in the geographic database of their respective national geographic institutes.*

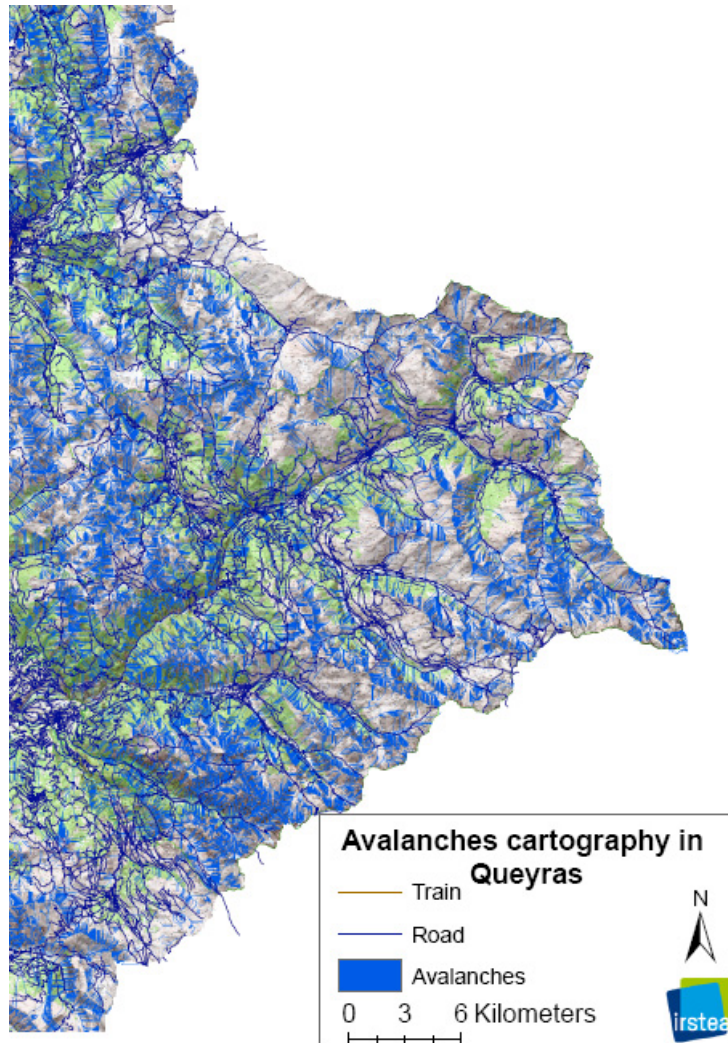
*Usually these databases list and correspondently map all human infrastructures: public facilities, dwellings, industries, as well as communication, electrical, gas and water infrastructures etc. According to their importance or their extent, all these items can be classified into protection priority*

*levels. This ranking is not obligatory, but facilitates the definition of priority levels for specific protective measures, depending firstly on the importance of the issues and secondly on the hazard's specifications. This ranking needs to be defined jointly with all actors involved in the risk prevention policy of the study area. By combining this map with the rockfalls run-out envelope map, the*



potentially endangered infrastructure can be identified by selecting all the items located between release points and run-out envelopes. The map obtained includes the endangered areas and the associated release and run-out zones.

If the 'endangered areas' map is available then Avalfor<sup>LIN</sup> performs the analysis automatically by map crossing. The following map (Figure 133) illustrates for the French case study the results of this risk analysis using Avalfor<sup>LIN</sup>.



**Figure 133: Avalanche hazard and human infrastructures localisation obtained with Avalfor<sup>LIN</sup> and using a 25x25m DTM, for the French Queyras case study (zoom of the map on the scale of the Département des Hautes-Alpes case study)**

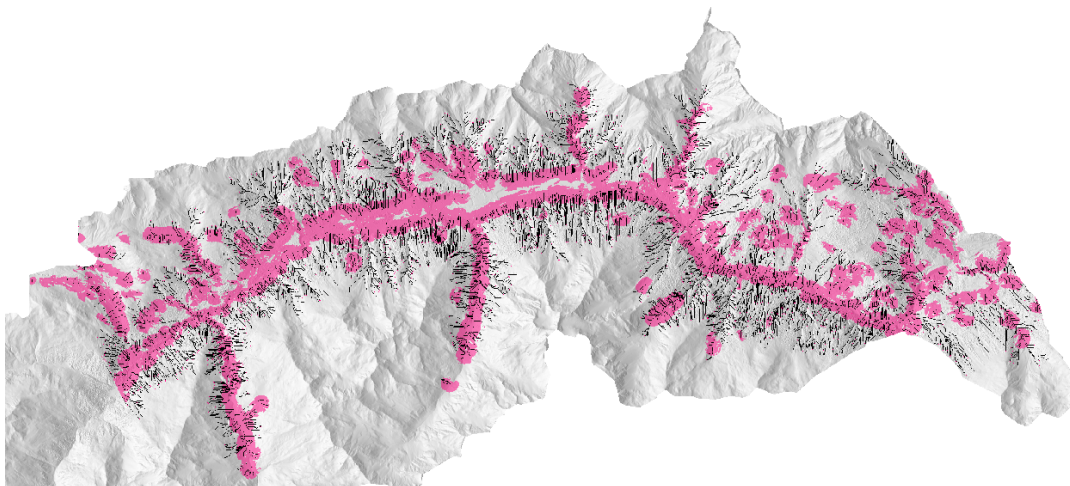
### **Avalanche protection forest mapping with Avalfor<sup>LIN</sup>**

Protection forest mapping is the last step of the risk analysis than can be done with Avalfor<sup>LIN</sup>. The general principle is to cross the map of endangered items with the map of the geographical extension of forest stands. This forest map can be the one provided by National Forest Inventories or the one available in the forest services. As the mapping is made on a regional scale, the dendrometrical description of the forest stands is not required. The only information required is that relating to the areas covered by forest. Identification of forest stands potentially serving a protective function is

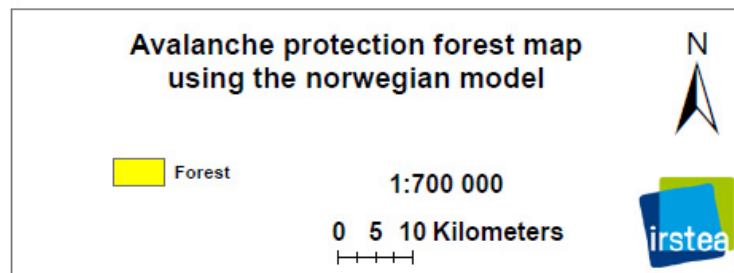
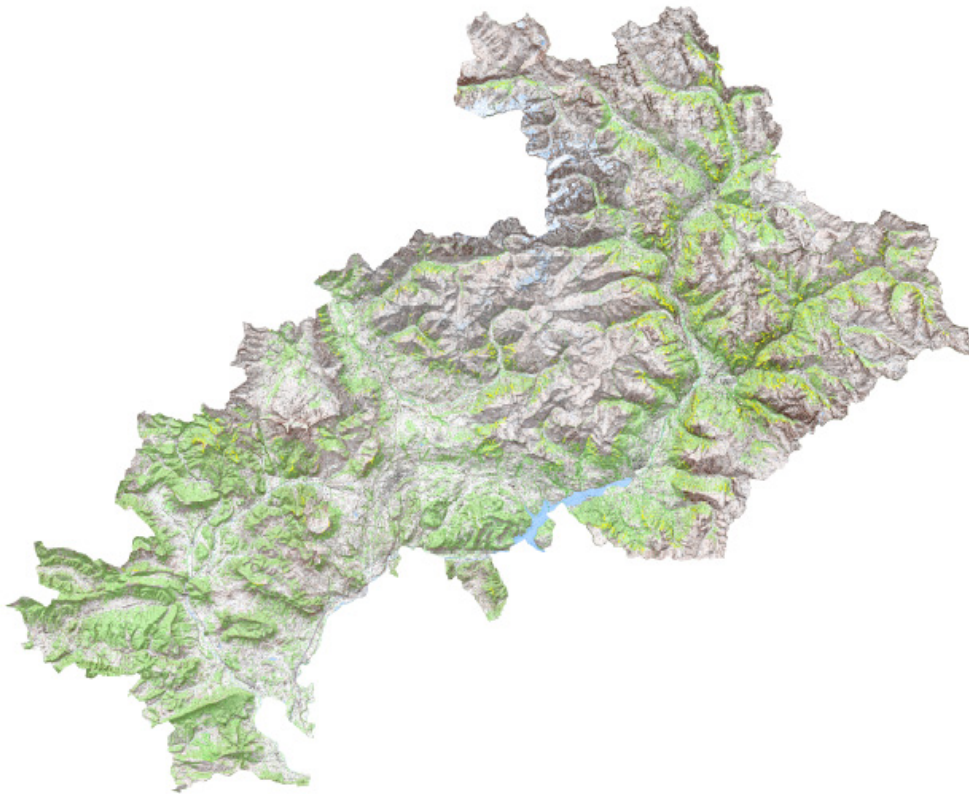
then obtained by combining the endangered items map with the forest cover map, and by selecting all forested areas located above an endangered item and on the associated release zones. Effectively a forest can have a potential efficient protective role only if it is located in the release area of an avalanche. This selection is provided automatically by Avalfor<sup>LIN</sup>. The map of potential protection forest areas needs to be validated by a field survey. But before this, it can be used to define an area within which forest management dedicated to the improvement of the protective function would be recommended. In other words, this map defines the potential area of use of protection forest management guidelines. The strength of this methodology lies in its ability to display the area within which forests are able to provide a protective function against avalanches; often such areas are unknown having not been previously identified. A decrease in forest canopy in these protection forest areas could have dramatic consequences, requiring changes in forest management to ensure the sustainability of this protective function. The following maps (Figure 134, Figure 135, Figure 136, Figure 137) present one example of the analysis processes performed by Avalfor<sup>LIN</sup> for generating potential protection forest mapping and some results of potential protection forest maps.



**Figure 134: snow avalanches potential release areas under forest canopy map obtained with Avalfor<sup>LIN</sup>, for the Austrian case study.**



**Figure 135: Snow avalanches run –out zones simulated from the potential release areas under forest canopy map obtained with Avalfor<sup>LIN</sup>, for the Austrian case study.**





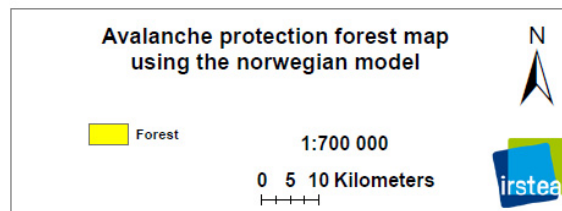
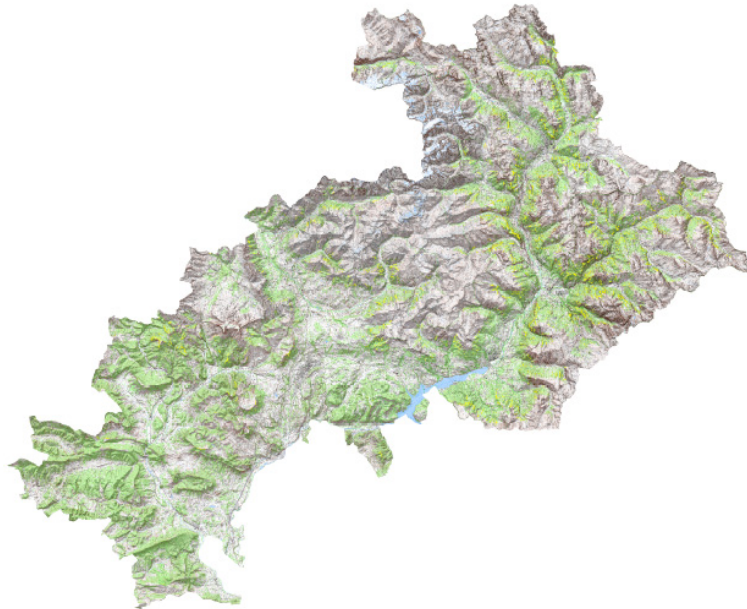


Figure 136: Avalanche potential protection forest map obtained with Avalfor<sup>LIN</sup>, and using a 25x25m DTM, for the French Département des Hautes-Alpes case study



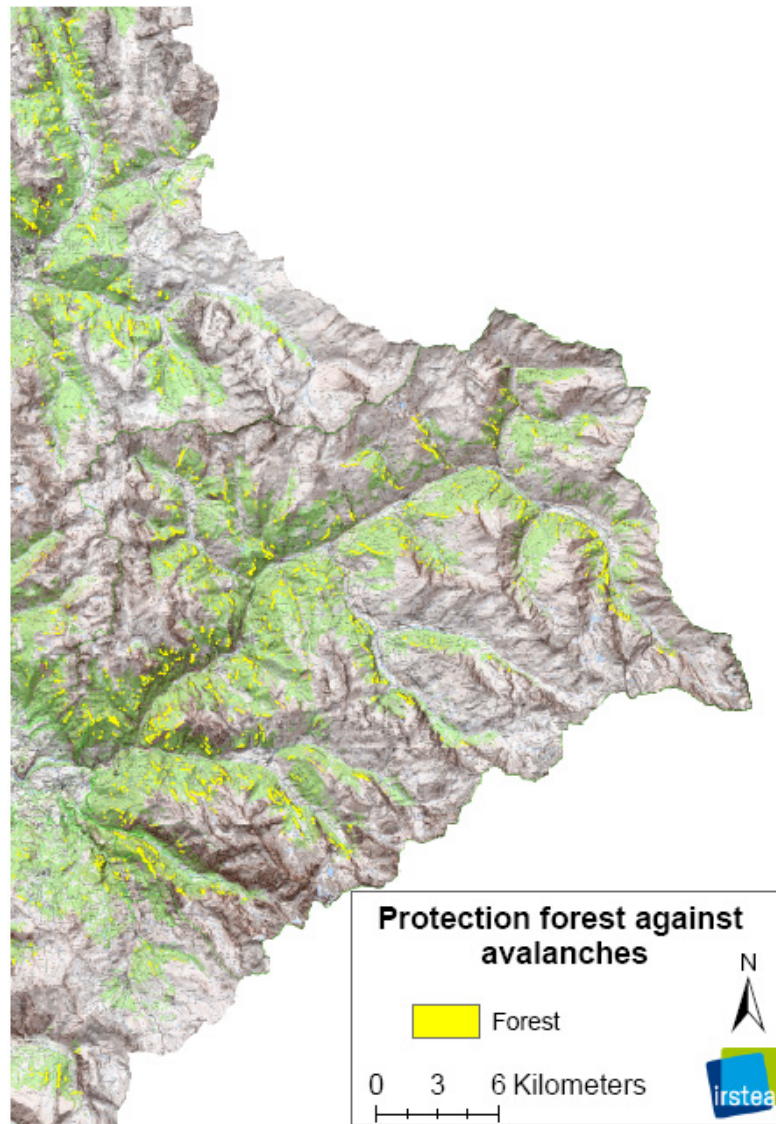


Figure 137: Avalanche potential protection forest (in yellow) map obtained with Avalfor<sup>LIN</sup> (property of Irstea), and using a 25x25m DTM, for the French Queyras case study (zoom of the map on the scale of Département des Hautes-Alpes case study)

## References

Bakkehøi S, Domaas U, Lied K, 1983: Calculation of snow avalanche run-out distances. Annals of Glaciology, 4, 24-30.

Berger, F., Dorren, L.K.A. Rockfor.NET : le premier outil de diagnostic rapide de l'aléa chute de pierres à l'aval d'une forêt de protection, [en ligne], Revue SET, 2010, no. 02, p. 186-197. Disponible sur : <URL :<http://www.set-revue.fr/rockfor-net-le-premier-outil-de-diagnostic-rapide-de-l-alea-chute-de-pierres-l-aval-d-une-foret-de-pr>>

Derron, M.H., 2012. Method for the Susceptibility Mapping of Rock Falls in Norway. Technical Report. Geological Survey of Norway (NGU), Trondheim, Norway. Institute of Geomatics and Risk Analysis, University of Lausanne, Switzerland

Dorren, L.K.A., 2012. Rockyfor3D (v5.1) revealed - Transparent description of the complete 3D rockfall model. ecorisQ paper ([www.ecorisq.org](http://www.ecorisq.org)): 31 p.

Dorren, L.K.A., Berger, F., 2012. Integrating forests in the analysis and management of rockfall risks: experiences from research and practice in the Alps In: Eberhardt et al. (eds). Landslides and engineered slopes: protecting society through improved understanding. Taylor and Francis Group, London: pp 117 – 127.

Dorren, L.; Berger, F.; Maier, B. 2005. Der Schutzwald als Steinschlagnetz. LWF aktuell 50, S. 25-27. Online-Version: 27.01.2011.  
[http://www.waldwissen.net/technik/naturgefahren/steine/lwf\\_steinschlagnetz/index\\_DE](http://www.waldwissen.net/technik/naturgefahren/steine/lwf_steinschlagnetz/index_DE)

Dorren, L.K.A., Domaas, U., Kronholm, K. & Labiouse, V., 2011. Methods for predicting rockfall trajectories and run-out zones. In: S. Lambert & F. Nicot (eds.). Rockfall engineering. ISTE Ltd. and John Wiley & Sons Inc.: pp. 143 - 173.

Evans, S. and Hungr, O. 1993. The assessment of rockfall hazard at the base of talus slopes. Canadian Geotechnical Journal, 30, pp. 620 - 630.

Fell R, Corominas J, Bonnard C, Cascini L, Leroi E; Savage W, 2008: Guidelines for landslide susceptibility, hazard and risk zoning for land use planning. Engineering Geology. 102; 3-4, 85-98.

Heim A, 1932 Bergsturz und Menschenleben - Fretz und Wasmuth, Zurich, 218 pp.

Jaboyedoff, M. 2003. CONEFALL 1.0 : A program to estimate propagation zones of rockfall based on cone method. Quanterra, [www.quanterra.ch](http://www.quanterra.ch).

Jaboyedoff M, Labiouse V, 2003: Preliminary assessment of rockfall hazard based on GIS data. ISRM 2003–Technology roadmap for rock mechanics, South African Institute of Mining and Metallurgy, 575-578.

Jaboyedoff M, Labiouse V, 2011 :Technical Note: Preliminary estimation of rockfall runout zones. Nat. Hazards Earth Syst. Sci., 11, 819–828, 2011 [www.nat-hazards-earth-syst-sci.net/11/819/2011/](http://www.nat-hazards-earth-syst-sci.net/11/819/2011/) doi:10.5194/nhess-11-819-2011

Lied K, Bakkehøi S, 1980: Empirical calculations of snow avalanche run-out distances based on topographic parameters. Journal of Glaciology, 26, 165-177.

Loye A, Jaboyedoff M, Pedrazzini A, 2009: Identification of potential rockfall source areas at a regional scale using a DEM-based geomorphometric analysis. Nat. Hazards Earth Syst. Sci., 9, 1643–1653.

McClung, D.M. 2001. Extreme avalanche runout: a comparison of empirical models. Can. Geotech. J. 38: 1254–1265 (2001). DOI: 10.1139/cgj-38-6-1254

McClung, D.M., and Lied, K. 1987. Statistical and geometrical definition of snow-avalanche run-out. Cold Regions Sci. Tech. 13 :180-184

Meissl, G. 1998. Modellierung der Reichweite von Felsstürzen. Fallbeispiele zur GIS-gestützten Gefahrenbeurteilung aus dem Beierischen und Tiroler Alpenraum. Innsbrucker Geografischen Studien 28. Ph.D. Thesis, Universität Innsbruck, Innsbruck, 249 pp.

Volkwein, A., Schellenberg, K., Labiouse, V., Agliardi, F., Berger, F., Bourrier, F., Dorren, L. K. A., Gerber, W., & Jaboyedoff, M., 2011. Rockfall characterisation and structural protection – a review. Nat. Hazards Earth Syst. Sci. 11: 2617-2651.

## 6.3 Prototype of a regional hazard management system on the Austrian railway network

*This section has been written and verified by Manfred Scheickl, David Powell (alpinfra consulting + engineering gmbh, sub-contactor of ÖBB) and Christian Rachoy (ÖBB Infrastruktur AG).*

### General

#### What is a decision support system?

As the authors see it, a Decision Support Systems in general is to be understood as a tool which supports a decision-making committee or a single decision-maker (persons) by means of a formalised decision protocol. The protocol can be processed on any medium: on ordinary paper-based tables or by means of complex software, with or without (spatial) visualisation.

The basics of a decision-finding process are the following aspects or segments:

- Definition of the desired state of the system or of the process
- Evaluation of the actual situation in context with a desired state of a process or a system
- Analysis of the factors that cause a deviation from the acceptable state
- Check of options to obtain an acceptable state of the system.

#### Legal framework for railway operation in Austria

According to § 19 (1) of the Austrian Railways Act (1957), a rail-way-operator legitimated for the construction and operation of railways has to undertake to build the railway, including the associated railway facilities, equipment and other facilities with a view to considerations of safety, order, and the requirements of the operation of the railway and of the traffic on the railway, to obtain, complete and operate in accordance with the law and according to the information required by this federal law concessions, permits and approvals, and has to make the necessary arrangements in this regard....

Further specification of safety requirements and safety levels or of an acceptable tolerance threshold is not given. The railway operator can fall back on the normative rules of the EC Series. These define security levels for specific failure consequence classes.

But in the context of natural hazards, the precise calculation of failure probability in constantly changing system states is not possible. Still, comprehensible decisions at already high endangerment need to be made. Therefore the best possible definitions of the endangering moments have to be found - with the help of locally experienced experts.

#### State of the art

Within actual railway operation, it is common to assess the risk situation based on

- a constantly implemented storm warning
- local avalanche committees
- geologists and other experts in case of an impact event (rockfall)

The experts involved need to investigate the situation jointly by means of a very individual point of view and based on their very individual and wide-ranging scope of experience.

All methods use an extensive documentation of the system-state as a basis for so-called weak decision arguments.

## Objectives

- The development should be carried out on the basis of the existing railway network of the ÖBB and the Road Administration.
- Nodes within the different infrastructure types and infrastructure levels (highway, country road, local road) are to be formed, so that a switch from one type to the other infrastructure-type can be taken into account and can be visualised.
- Within this step of development, the system should be related to the existing exposure analysis made within WP5 (Debris Flow Impact Analysis).
- For the impact scenarios a set of triggers will be defined; trigger-parameters will be described.
- A decision-making processes has to be formulated mathematically in such a way that relevant trigger parameters or parameters which provide us indirectly with information (they will be called indirect sensors within this work) about the danger-level are included, weighted and calibrateable.
- In the long term, the system will be realised as a dynamic GIS application and the basis therefore will be developed within the current programme.

## Test bed description

### Location

The area, where the system is to be designed is the Stanzertal valley in the Tyrol, Austria, which is the test bed where a regional debris-impact-analysis was performed under Work Package 5. It concerns the railway line and the roads situated between Landeck and St. Anton. The railway line is a part of the rail route Innsbruck to Bludenz. The highway investigated is a part of the S16 - Arlberg expressway. Besides the expressway, the L68 Stanzertalstrasse was also investigated.





Figure 138: general map, AMap 3D, undefined scale

The eastern ramp runs through the Stanzertal, which is formed by the eastern part of the Lechtaler Alps with a southerly aspect and the flanks of the eastern Verwall group facing north. The outfall is formed by the river Rosanna.

### Results of the impact analysis study

Within the impact analysis study, performed on an indicational scale, sections where the infrastructure is potentially affected are identified based upon the computed debris flow run-off. . Based on the height of the flow and the concentration of the debris three intensities of impact are distinguished. . The resulting legend for the analysis maps looks as follows:

#### Legende

##### Strassen

- Abfahrten
- Strassen hochrangig
- Tunnel

##### Stationierung

- HM
- KM

##### Paramount Events

- ★ Paramount Events

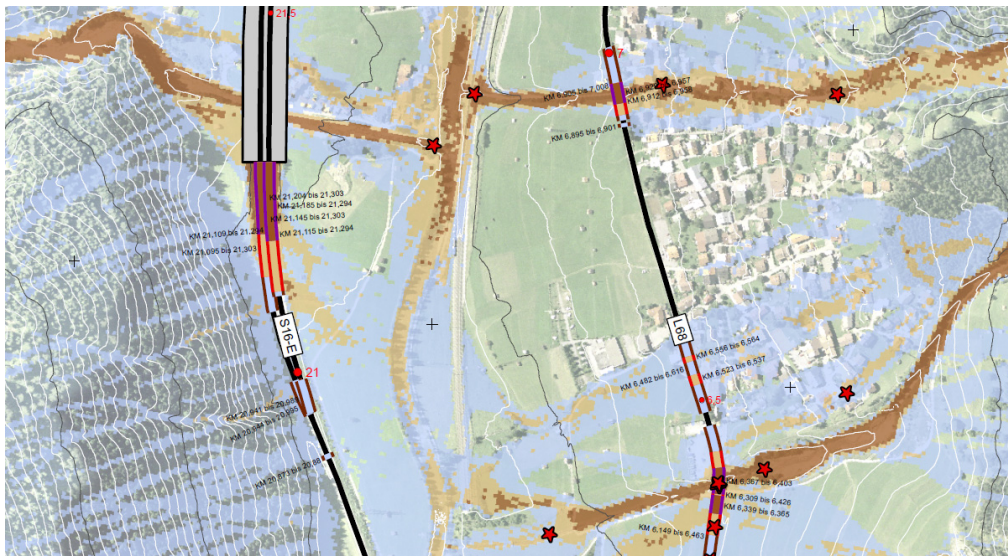
##### Potentieller Murabfluss

- Möglicher gering geschiebelasteter Abfluss
- Mögliche Übersarung
- Möglicher konzentrierter Murabfluss

##### Potentielle Einwirkungsbereiche

- Möglicher gering geschiebelasteter Abfluss
- Mögliche Übersarung
- Möglicher konzentrierter Murabfluss

The resulting impact sections are compared to documented events, or the documented events are located to search for compliance between numerically predicted and documented debris flows.



**Figure 139:** Example of the analysis along the S16 and the L68 near Pettneu

## **Formulation of the decision algorithm**

### **Danger-disposition, triggers and indirect sensors**

#### **Danger disposition related to debris flows**

According to Meyer et. al. (2010) the danger disposition of debris flow source areas can be divided into two levels (a) indication level and (b) a detailed and local applicable level. Further,

a) the danger-disposition or the potential of the occurrence of debris flow source areas on an indicational level can be estimated from the authors' point of view by means of a combination of

- Geological maps
- Danger maps related to the geological danger inventory
- Topographical and/or morphometrical data (elevation raster and derivative data)

b) the danger-disposition or the potential of the occurrence of debris flow source areas at local level can be estimated according to Meyer et. al. (2010) by means of

- Shear-parameters of potentially unstable source slopes (cohesion/shear angle)
- Numerical/physical stability evaluation

From the authors' point of view, the following parameters need to be implemented as well

- Mountain and/or slope water levels
- Potential discharge at channels which build the tow of potential debris source slopes. The potential discharge has to be derived from precipitation data and scenario-related run-off calculations.

#### **Triggers**



As a trigger related to debris-flow-events, we clearly need to take into account the precipitation occurring in the catchment area investigated or monitored by the decision support system. Here the pre-precipitation as well as the short term maximum precipitation is to be taken into account. Factors like dry periods with dry cracking resulting in an increased infiltration capacity in the surrounding of potentially unstable slopes and on the endangered slopes need to be weighted and taken into account, as do other factors like the permanent creeping tendency of slopes and so on.

### Indirect sensors

Indirect sensors give hints of impending events. The sensors or indicators do not have to be necessarily directly connected to the system processes within the monitored catchment area.

### Direct sensors

Direct sensors need to be taken into account in order to establish the possibility of measuring the relevant processes within the catchment area, like channel flow height at relevant sections probably in combination with geophones to detect flowing debris gravel on the channel ground, the precipitation at relevant spots and by means of weather radar.

### Governing formulation

As a first draft the following simple weighted average formulation, including all factors according to their importance or to their estimated significance within the investigated system, can be postulated.

$$IADV = \frac{iV_1 \times w_1 + iV_2 \times w_2 + iV_3 \times w_3 + \dots + iV_n \times w_n}{\sum_{n=1-i} w_i}$$

**IADV:** indicated average danger value

$iV_i$ : indicated danger value of criterion  $i$

$w_i$ : weight of criterion  $i$

### Factors and initial weights

The following initial triggers and sensors should be taken into account. The table is to be understood as a first draft which needs to be concretised with the help of a pilot field trial. The threshold for each factor has to be defined in consultation with experts and needs to be adapted as well as the initially defined weights within a first trial operation. Some factors or elements might need to be cancelled, or to be added.

Index	Factor	Type	Weight
<b>Precipitation</b>			
V01 / Prec 1	Specific extreme precipitation (catchment area related duration of maximum precipitation)	Trigger	1
V02 / Prec 2	SCS CNI – Value	Trigger	0.5
V03 / Prec 3	SCS CNII – Value	Trigger	0.75
V04 / Prec 4	SCS CNIII – Value	Trigger	1
<b>Geology</b>			
V05 / Geo 1	Earth quake dry	Disposition	0.3
V06 / Geo 2	Earthquake in combination with Prec 1 to Prec 4		
V07 / Geo 3	Proportion between potentially unstable and stable slopes (30-50° criterion after Damm et. al.)	Disposition	0.7
V08 / Geo 4	Proportion between potentially unstable and stable slopes related to investigated shear resistances (shear angle and cohesion)	Disposition	0.8
V09 / Geo 5	shorter date of the last event than a month	Disposition	1
V10 / Geo 6	longer date of the last event than 10 years in combination with	Disposition	0.5

Index	Factor	Type	Weight
Geo 3 and/or Geo 4			
<b>Direct sensors</b>			
V11 / Sen 1	Weather radar	Trigger	0.8
V12 / Sen 2 = Prec 1	Precipitation Gauche	Trigger	0.9
V13 / Sen 3	Flow height – Channel Section 1	Trigger	0.6
V13 / Sen 3	Flow height – Channel Section 2	Trigger	1
V14 / Sen 4	Geophone – Channel Section 2	Trigger	1
V X	Further Sensors		
<b>Exposition of the infrastructure (related to scenarios)</b>			
V11 / Exp 1	Low		0.7
V12 / Exp 2	Moderately		0.8
V13 / Exp 3	High		0.9
V14 / Exp 4	Very high		1

**Table 2:** Components for calculation the IADL-Value

## Potential Debris flow impact Sections

In order to solve the exposure factor, a pre-analysis of the potentially occurring impact sections was carried out. Therefore numerical calculations on an indicational level were done by means of the debris flow code aiDebrisFlow3D. A more detailed description can be found in the WP 5 report (Debris Flow Impact Analysis) of the current programme (alpinfra 2012 in contract with ÖBB and the BMLFUW). Within this calculation the criterion Geo 3 is already included.

## Dynamic debris impact analysis with aiDebrisFlow3D

### Basic rheology

The calculation tool used is based upon the friction model by Voellmy (1955), which includes (a) the friction parameter  $\mu$ , which increases according to the law of friction with rising normal stress ( $\rho gh$ ) and (b) the parameter for turbulence  $\xi$  that reduces the total friction resistance of the volume element under examination. The parameter for turbulence reduces that part of the friction, which, under constant density, yields a non-linear friction resistance that is dependent on pressure and velocity.

$$S = \mu \rho H g \cos \phi + \frac{\rho g U^2}{\xi}$$

S = Flow resistance [Pa]

$\rho$  = Density of the debris material

g = Gravity

$\Phi$  = angle of slope

H = Flow height

U = Flow velocity

### Model

The regional analysis of debris flow based on reference includes (a) the collection of existing indications of debris flow processes in the region and (b) a numerical simulation of potential debris flows. In the course of the geographical survey the hydrological catchment areas, soil delivery areas



as well as transport and accumulation zones are collected using remote sensing data and in situ investigations. These are required to obtain calibration data for the numerical analysis. The data was provided by the BFW. The model that is deployed in the course of the debris flow analysis can be run with following modes:

1. synchronic simulation of single particle with a defined volume and a Voellmy rheology (Voellmy, 1955), where the direction of movement is controlled by a 'Random Walk' algorithm (Révész, 1990) with constraints. With the highest probability, the direction of flow points in the direction of the topographic gradient. Because of the synchronic simulation the height of flow, which is a temporal and spatial variable, as well as the impulses of single-particles inside of a computational cell are considered,
2. hydraulic model for the specification of flow processes of a 3D topography. This alternative is based upon the numeric solution of the non-linear conservative form of shallow water equations (Saint-Venant equations), a variation of the Navier-Stokes equation that is depth-averaged (for the mathematical formulation cf.: Bouchut and Westdickenberg, 2004; Patra et al., 2005, Medina et al., 2008; Wang et al., 2008; Kuo et al., 2009). The characteristics of the available soil have an essential impact on the physics of debris flow and serve as the basis for the selection of an appropriate fluid model and its parameterisation (cf.: Iverson, 1997, Rickenmann, 1999, Kaitna et al., 2007, Iverson et. al., 2010). The physical characteristics of mud-flows and/or debris flows are ascribed to the interaction of a solid phase with a fluid phase. The granular character of the solid phase, the viscous behaviour of the fluid and the impact of the void water pressure are approached through various fluid models (Wang et al., 2008, Bertolo and Wiczorek, 2005).

## Estimating the plausibility of the calculations

### *Detachment areas*

In general the detachment areas caused by slope failure occur at slope angles between 20° and 45°. Within slopes shallower then 20° the effective stress avoids slope failures. On the other hand slopes steeper then 45° do not accumulate removable or mobilisable soil material in sufficiently significant quantities to produce debris flows (Hungri, 2005).

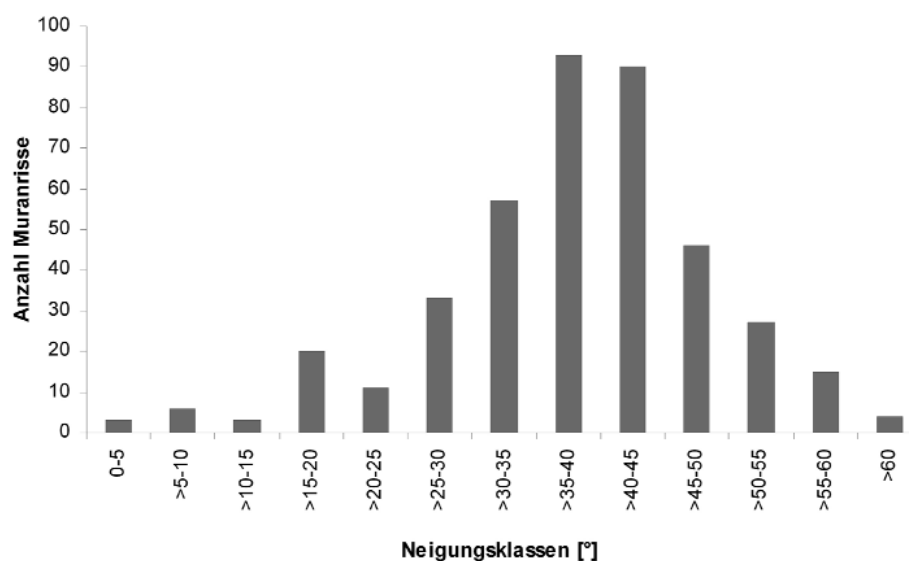


Figure 140: Relationship of slope and debris flow detachment areas (acc. Damm, 2008)

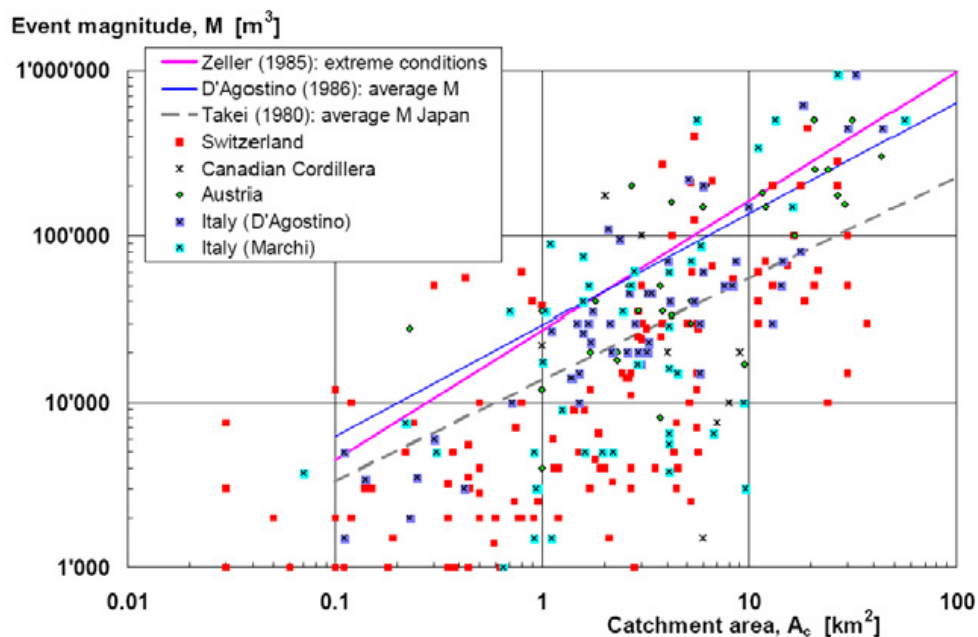
### *Calculation of the volume of debris flow based upon morphometric parameters*

The localisation of the magnitudes of events, in terms of the volume of a debris flow, can be derived from empirical relationships, which generally are based upon morphometric parameters of the catchment area. Various relationships are listed in Table 3. These facilitate the deduction of a peak as well as a mean value of potential event magnitudes. Figure 141: shows event magnitudes of debris flows and/or torrential floods with sediment discharge in relationship to the size of the catchment area.

**Table 3:** Relationship between catchment area and debris flow (IRASMOS 2011)

Formula	N	Source
$M = K A_c 100 S_c$	1420	Kronfellner-Kraus (1984); Kronfellner-Kraus (1987)
$M = 37000 A_c^{0.78}$	~ 65	Zeller (1985; "extreme conditions for sediment yield")
$M_a = 150 A_c (100 S_f - 3)^{2.3}$	15 (*)	Hampel (1977)
$M = L_c (110 - 250 S_f)$	82	Rickenmann and Zimmermann (1993)
$M_a = 13600 A_c^{0.61}$	551	Takei (1980)
$M_a = 29100 A_c^{0.67}$	64	D'Agostino (1996)
$M_a = 70 A_c S_c^{1.28} I_G$	64	D'Agostino & Marchi (2001)

**M** Maximum event magnitude [m<sup>3</sup>]  
**M<sub>a</sub>** Average event magnitude [m<sup>3</sup>]  
**A<sub>c</sub>** Catchment area [km<sup>2</sup>]  
**S<sub>c</sub>** Mean channel slope [-]  
**S<sub>f</sub>** Mean fan slope [-]  
**L<sub>c</sub>** Length of active channel [m]  
**K** Torrentiality factor [-]  
**I<sub>G</sub>** Geologic index [-]  
**N** Number of events [-]



**Figure 141:** Relationship between catchment area and debris flow (IRASMOS 2011)

### **Relationship between volume of debris flow and peak run-off**

According to Rickenmann (1999) and based upon 145 analysed events, there exists an empirical relationship between the volume of an event  $V$  and the peak run-off  $Q_{max}$  of the water and solid mixture of debris flows:  $Q_{max} = 0,1 V^{0,833}$

An empirical relationship by Mizuyama et al. (1992) between run-off and volume of an event can be described as follows:  $Q_{Mizuyama} = 0,135 V^{0,78}$

### **Verification method**

The magnitudes of the computed debris flow events were assessed using the approaches by Takei (1980) and D'Agostino (1996). The results in terms of location of the events with the highest possible magnitude were checked according to Zeller (1985).

### **Choice of parameters**

The simulation on an indicative scale is generally executed on a regular grid with a resolution of 5mx5m. As debris starting zones all areas with a topographic gradient between 35° - 50° were classified. Water was taken as unlimited into account (following Hungr 2005, Damm 2008). As water-soil ratio a (W/S-Value) of 1,03 was chosen. This relatively runny debris fluid leads to a low angle of friction and in consequence to conservative results concerning velocities. The parameters for internal friction and turbulence were obtained within a back-analysis. The parameters are within the range postulated by SLF and in particular by Medina et. al. (2008).

**Table 4:** Sets of parameters for the indication analysis

initial height of fluids (35-50°)	$\xi$ [m/s <sup>2</sup> ]	$\mu$	$\rho$ [kg/m <sup>3</sup> ]
0.06m – medium sized event	650	0.14	1800
0.09m – big event	650	0.14	1800
0.12m – very big event	650	0.14	1800
0.15m – extreme event	650	0.14	1800

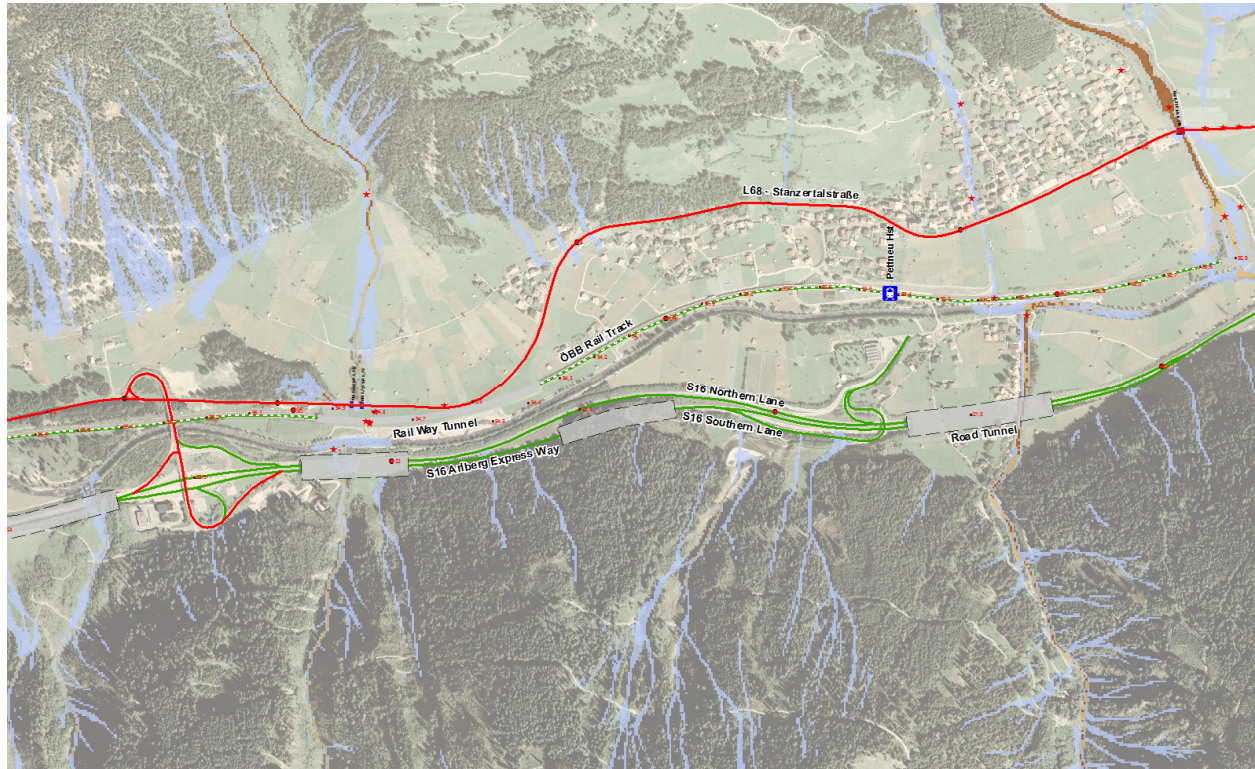
The density of the fluid of a debris flow results from taking a solid matter density of 27kN/m<sup>3</sup> and a W/F-value of approximately 1.03 as a basis.

## Scenario related warning related to infrastructure section

Under consideration of the criteria and the extended exposure analysis, the following virtual indicated danger situations can be derived theoretically – with a non-calibrated calculation.

The red labelled sections show a potential impact at different average danger values.

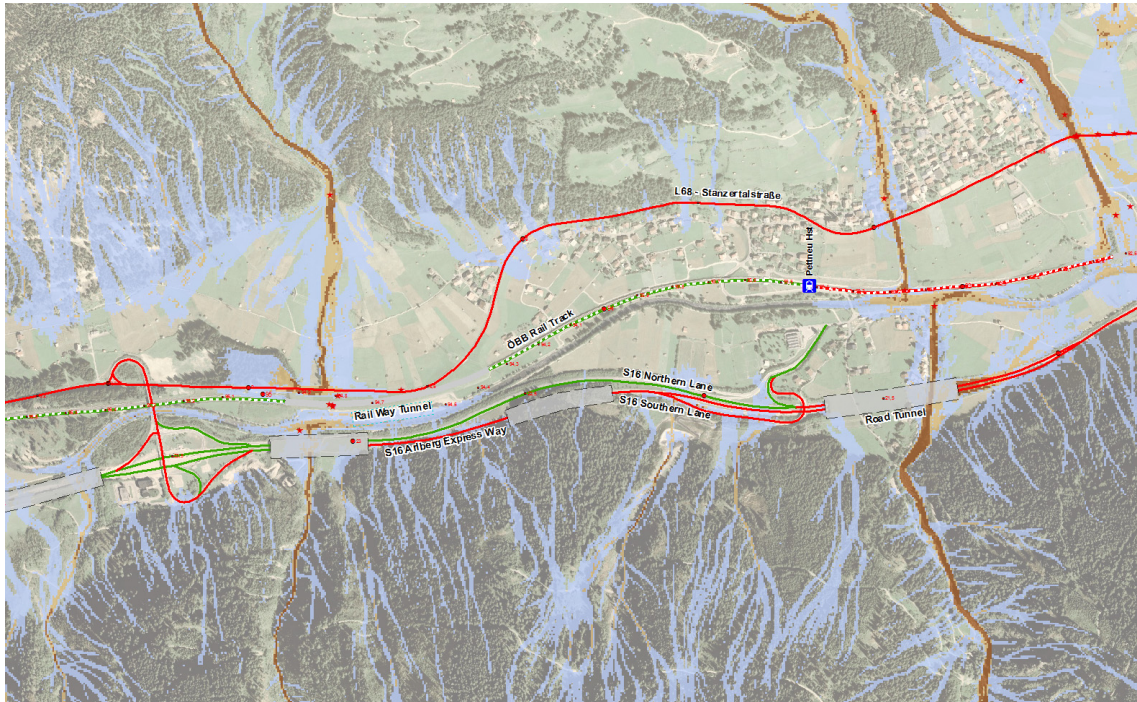
### Average Danger Value 0.5-0.7



**Figure 142:** Indicated endangerment around Pettneu am Arlberg at IADL of 0.5 - 0.7

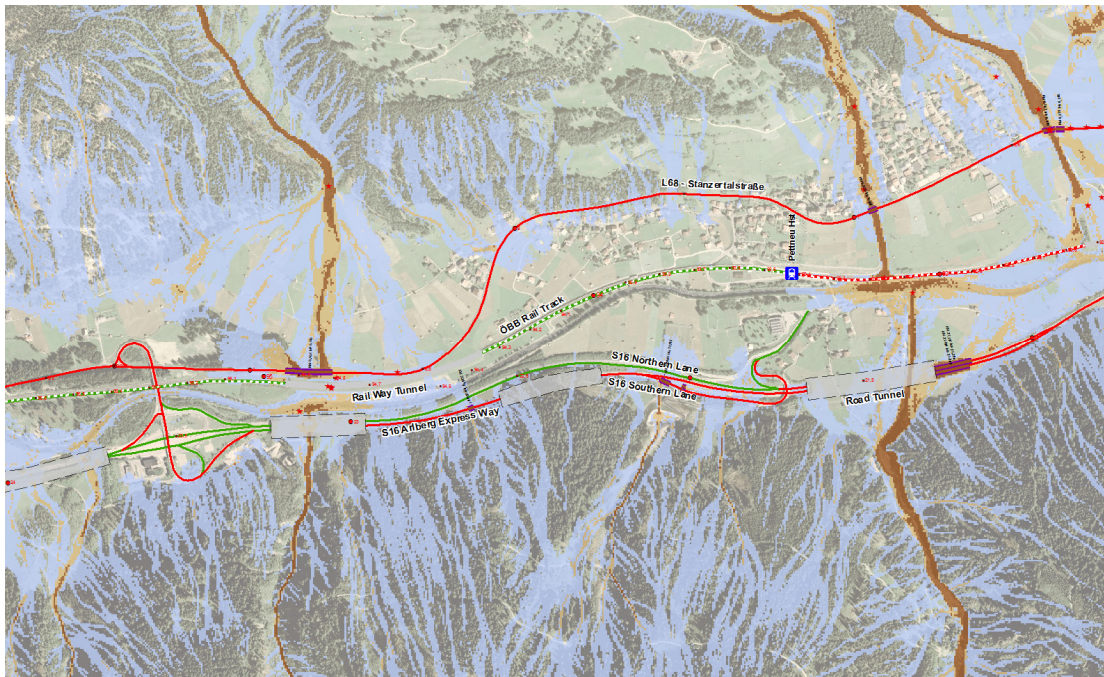


### Average Danger Value 0.7-0.8



**Figure 143:** Indicated endangerment around Pettneu am Arlberg at IADL of 0.71 - 0.8

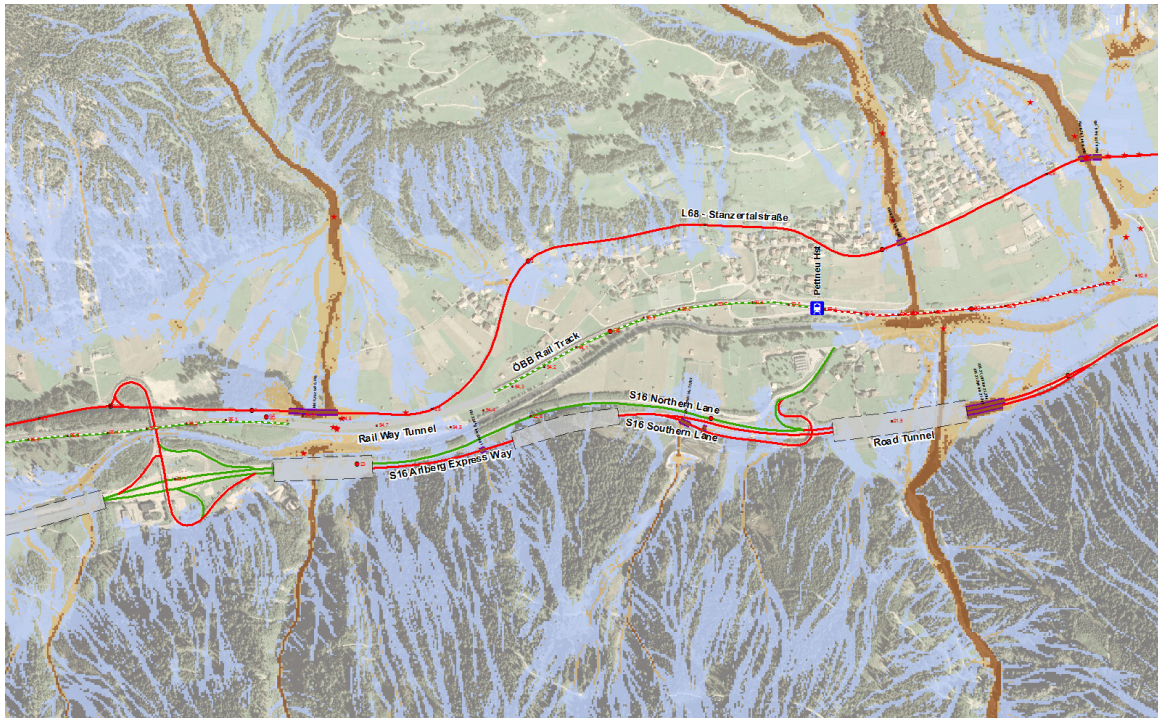
### Average Danger Value 0.8-0.9



**Figure 144:** Indicated endangerment around Pettneu am Arlberg at IADL of 0.81 - 0.9



## Average Danger Value 0.9-1.0



**Figure 145:** Indicated endangerment around Pettneu am Arlberg at IADL above 0.9

## Connected impact sections at an IADL of 0.7-0.8

**Table 5:** Potential impact sections between stops of the ÖBB at an IADL of 0.7-0.8

Node from	Node to
Landeck-Perfuchs km 73.8	Hst. Pians km 78
Strengen km 83	Flirsch km 87.2
Flirsch km 87.2	Schnann Hst. km 90.4
Schnann Hst. km 90.4	Pettneu Hst. km 93.3

**Table 6:** Potential impact sections between exits of the S16 at an IADL of 0.7-0.8

Node from	Node to
6	8.1
8.1	14.1
14.1	18.6
19.2	21.7

**Table 7:** Potential impact sections between S16-exits at the L68 at an IADL of 0.7-0.8

Node from	Node to
0	9.4

## References

- Meyer, F., Boley, C. (2010): Entwicklung eines Decision-Support-Systems zur Generierung einer zuverlässigen, lokalmaßstäblichen Gefahrenbeurteilung potentieller Hangmurbereiche. In: *Geotechnik*, 2010/4
- Scheikl, M.; Powell, P. (2012): Improved Accessibility Reliability and Security of Alpine Transport Infrastructure related to mountainous Hazards in a changing Climate; Debris Flow Impact Analysis (Stanzertal, AT) - Investigations on a regional applicable debris-flow-impact-analysis (WP 5).
- Bertolo, P., and G. F. Wieczorek (2005), Calibration of numerical models for small debris flows in Yosemite Valley, California, USA, *Natural Hazards and Earth System Sciences*, 5, 993-1001.
- Bouchut, F., and F. M. Westdickenberg (2004), Gravity driven shallow water models for arbitrary topography, *Comm. in Math. Sci.*, 2, 359-389.
- Bouchut, F., E. Fernández-Nieto, A. Mangeney, and P. Y. Lagrée (2008), On new erosion models of Savage–Hutter type for avalanches, *Acta Mechanica*, 199, 181-208.
- Denlinger, R. P., and N. R. Iverson (2001), Flow of variably fluidized granular masses across three-dimensional terrain. 2. Numerical predictions and experimental tests, *Journal of Geophysical Research*, 106, 553-566.
- Geroge, D. L., and R. M. Iverson (submitted), A Two-Phase Debris-flow Model that includes Coupled Evolution of Volume Fractions, Granular Dilatancy, and Pore-Fluid Pressure.
- Hochschwarzer, M. (2009): Vergleich von Simulationsmodellen zur Reichweitenabschätzung alpiner Murgänge - am Beispiel südtiroler Ereignisse. Diplomarbeit. Universität für Bodenkultur Wien. Department für Bautechnik und Naturgefahren
- Hürlimann, M., D. Rickenmann, V. Medina, and A. Bateman (2008), Evaluation of approaches to calculate debris-flow parameters for hazard assessment, *Engineering Geology*, 102, 152-163.
- Integral Risk Management of Extremely Rapid Mass Movements (IRASMOS): Specific Targeted Research Project: D3.1 – Technical evaluation report of current methods of hazard mapping of debris flows, rock avalanches, and snow avalanches. WSL Swiss Federal Institute for Snow and Avalanche Research. (01.06.2011)
- Iverson, N. R., and R. P. Denlinger (2001), Flow of variably fluidized granular masses across three-dimensional terrain. 1. Coulomb mixture theory, *Journal of Geophysical Research*, 106, 537-552.
- Iverson, N. R., M. Logan, R. G. LaHusen, and M. Berti (2010), The perfect debris flow? Aggregated results from 28 large-scale experiments, *Journal of Geophysical Research*, 115, doi:10.1029/2009JF001514.
- Iverson, R. M. (1997), The Physics of Debris Flows, *Rev. Geophys.*, 35.
- Kaitna, R., et al. (2007), Experimental study on rheologic behaviour of debris flow material, *Acta Geotechnica*, 2, 71-85.
- Kuo, C. Y., Y. C. Tai, F. Bouchut, A. Mangeney, M. Pelanti, R. F. Chen, and K. J. Chang (2009), Simulation of Tsaoiling landslide, Taiwan, based on Saint Venant equations over general topography, *Engineering Geology*, 104, 181-189.
- Mangeney, A., L. S. Tsimring, D. Volfson, I. S. Aranson, and F. Bouchut (2007), Avalanche mobility induced by the presence of an erodible bed and associated entrainment, *Geophys. Res. Lett.*, 34, 1-5.
- Mangeney, A., P. H. Heinrich, R. Roche, G. Boudon, and J. L. Cheminée (2000), Modeling of debris avalanche and generated water waves: Application to real and potential events in Montserrat, *Physics and Chemistry of the Earth, Part A: Solid Earth and Geodesy*, 25, 741-745.

Medina, V., M. Hürlimann, and A. Bateman (2008), Application of FLATModel, a 2D finite volume code, to debris flows in the northeastern part of the Iberian Peninsula, *Landslides*, 5, 127-142.

Mizuyama, T., Kobashi, S. und Ou, G. (1992): Prediction of debris flow peak

Patra, A. K., A. C. Bauer, C. C. Nichita, E. B. Pitman, M. F. Sheridan, M. Bursik, B. Rupp, A. Webber, A. J. Stinton, L. M. Namikawa, and C. S. Renschler (2005), Parallel adaptive numerical simulation of dry avalanches over natural terrain, *Journal of Volcanology and Geothermal Research*, 139, 1-21.

Pelanti, M., F. Bouchut, and A. Mangeney (2011), A Riemann solver for single-phase and two-phase shallow flow models based on relaxation. Relations with Roe and VFRoe solvers, *J. Comput. Phys.*, 230 515-550.

Révész, P. (1990), *Random walk in random and non-random environments*, World Scientific Pub Co. ISBN 981-02-0237-7

Rickenmann, D. (1999), Empirical Relationships for Debris Flows, *Natural Hazards*, 19, 47-77.

Rickenmann, D., D. Laigle, B. McArdell, and J. Hübl (2006), Comparison of 2D debris-flow simulation models with field events, *Computational Geosciences*, 10, 241-264.

Rickenmann, D.: Hyperconcentrated flow and sediment transport at steep slopes. *Journal of Hydraulic Engineering* 117(11) (1991), p. 1419–1439

Smart, G.M. und Jäggi, M.: Sedimenttransport in steilen Gerinnen. *Mitteilungen der Versuchsanstalt für Wasserbau, Hydrologie und Glaziologie, ETH Zürich*, Nr. 64, 1983.

Wang, C., T. Esaki, M. Xie, and C. Qiu (2008), Landslide and debris-flow hazard analysis and prediction using GIS in Minamata–Hougawachi area, Japan, *Environmental Geology*, 51, 91-102.

## 6.4 An operational avalanche risk evaluation system on an Alpine railway section

*This section has been written and verified by Gašper Rak, Gašper Zupančič, Daniel Kozelj, Jošt Sodnik, Jože Papež, Franci Steinman and Matjaž Mikoš (University of Ljubljana, Slovenia).*

The knowledge of the risk situation forms the basis for long and short term risk decision-making. Therefore a risk analysis of the ‘problem at hand’ is needed to make sound risk mitigation decisions. The ‘problem at hand’ in this case can be divided into two, based on spatial scale: local and national. The local ‘problem’ is the Slovenian Posočje (Baška grapa) test bed, or more accurately the Podbrdo – Most na Soči railway section, which runs through the Baška grapa valley (for more data on the test bed, see the *Risk Management and Implementation Handbook* or Papež et al. 2010). The wider – national ‘problem’ is the whole Slovenian railway (and even road) network, since the whole endangered transport lines could be treated in the same way as the test bed section.

### Requirements for the method

Avalanche and rockfall hazard mapping regarding traffic route does not have a long history in Slovenia, especially in the area of railway traffic. That is the reason for the lack of guidelines in this field. Understandably the state is the same or even worse in the field of vulnerability and risk assessment. For that reason a method for hazard, vulnerability and risk assessment had to be developed under the auspices of the PARAMount project. The basic conditions for the method include:



- a good level of accuracy,
- simplicity of method (inputs and results),
- transparency and clarity of results,
- possible application to the whole Slovenian railway (and road) network (a possibility of drawing up guidelines).

The first two conditions appear to be contradictory. Thus a great effort was made to achieve the right measure of accuracy while keeping the method simple. In development of the method, many risk evaluation methods were studied. The flood risk evaluation method, which is obligatory and described in the Slovenian legislation (Rules on methodology to define flood risk areas and erosion areas connected to floods and classification of plots into risk classes, OG RS, No. 60/2007) was taken as a good example for three reasons (Rak et al. 2012b):

- it is quite simple and accurate,
- it is well accepted in Slovenian practice and
- it is a binding guideline (in order to develop a new guideline, it seems wise to try to emulate an existing guideline).

## Application of the method

### Hazard analysis

Regarding avalanche hazard, the available data for hazard map elaboration were rather scarce:

- **Avalanche records**  
Records made for the whole country register 13 avalanche areas in the Baška grapa test bed. For each avalanche area, data included in the records consist of: area size, centroid coordinates, release area altitude, deposition area altitude, slope angle, shape of avalanche area, vegetation, soil stability, exposition and estimated recurrence interval.
- **Data gathered from the Slovenian Railways Ltd**  
Data on endangered sections of the railway were supplied by Slovenian Railways. Endangered sections are defined in the *Operational plan for winter traffic safety* and are based on past experiences.

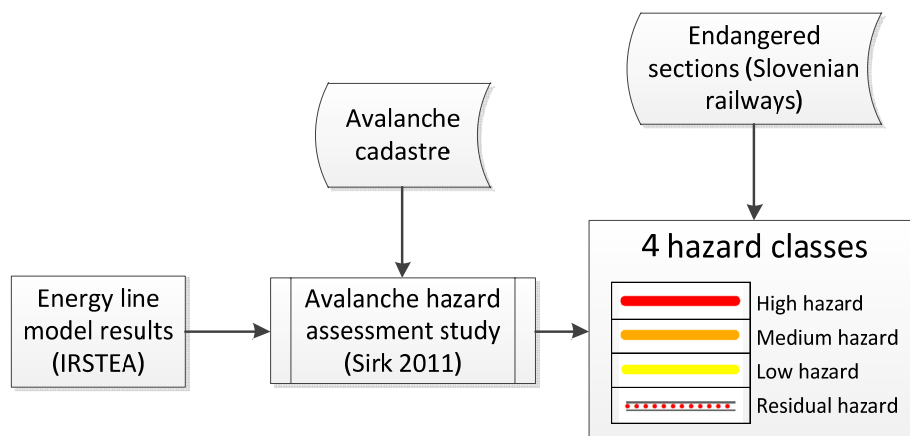
The data referred to are available for the whole Slovenian railway network and are thus universally available for the whole country (also for roads). But the quality and structure of data was not suitable for the creation of hazard classes. Therefore two steps now had to be taken:

- The whole test bed area was modelled with the Energy Line model for avalanches by the PARAMOUNT project partner no. 10 (French National Research Institute of Science and Technology for Environment and Agriculture – IRSTEA). According to the results, hazardous areas threatening the railway were defined, which coincided well with the areas of the avalanche records. These areas were then further investigated.
- On the defined hazardous areas a study incorporating data from the avalanche register, field surveys and numerical models was made (Sirk 2011). The numerical modelling was carried out in AVAL 1D. In the study, the field survey results (orientation, existing protection structures and vegetation) and the modelling results (impact energy and deposition depth) of snow depths with different probability (return intervals of 10, 30 and 300 years) formed the basis of an elaborate hazard assessment, which allowed the division of the railway network into hazard classes.

The 20 km long section of the railway through the test bed was divided into 10 meters long stretches. For each stretch the avalanche hazard was evaluated by the following rules, defining 4 hazard classes:

- High hazard: according to the existing hazard assessment study (Sirk 2011) the sections at which the assessed hazard was highest were classified as high hazard stretches.
- Medium hazard: according to the existing hazard assessment study (Sirk 2011) the sections at which the assessed hazard was medium were classified as medium hazard stretches. In addition all endangered sections as defined by the operational plan received from the Slovenian Railways were classified as medium hazard.
- Low hazard: according to the existing hazard assessment study (Sirk 2011) the sections at which the assessed hazard was low were classified as low hazard stretches.
- Residual hazard: all areas in the test bed were evaluated according to the slope angle. Wherever the slope angle above the railway track was higher than 25° the railway was classified as residual hazard, excluding railway tunnels and bridges, where expected avalanches pose no danger.

The choice of 4 hazard classes was made according to Slovenian flood mapping regulations, as was the choice of class markings (Figure 146).



**Figure 146: Hazard assessment procedure**

### Vulnerability evaluation

The method described below was consistent with the goal of maximum simplicity and applicability to all Slovenian railway lines. With this in mind, the procedures proposed by some international sources, such as the estimation of the monetary value of endangered objects and object resistance curves, were simplified or not taken into consideration.

The basis for the vulnerability evaluation was once again the officially defined method used in flood management practice. In accordance with this, 4 vulnerability classes and some of the evaluation measures were defined. Since the official method (from flood management) was not defined for avalanche hazard, additional measures for vulnerability classification were set. The following four measures were used:

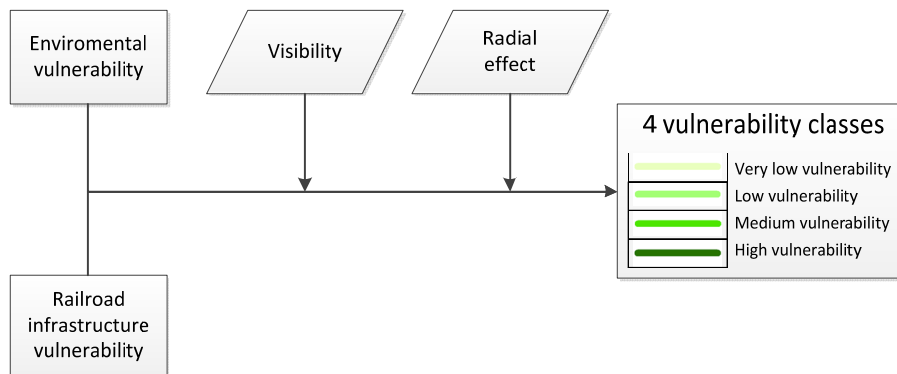
- Railway infrastructure vulnerability: a register of railway infrastructure elements (railway track, switches, tunnels, culverts, bridges, signal boxes, watchmen's houses, stops and stations) has been made according to Slovenian Railways data. On the basis of these elements, the 10 m long railway stretches were classified into 4 vulnerability classes on the basis of railway infrastructure.

- Environmental vulnerability: the railway runs through different natural habitats and some of them are protected. The whole bed of the Bača watercourse is marked as an ‘ecologically significant area’ and 48.15 kilometres of the track are even protected under Natura 2000, since two protected fish species appear in that area: the Italian Barbel (*Barbus plebejus*) and European Bullhead (*Cottus gobio*). Since rockfall and avalanche hazard entails a possibility of train derailment and the railway often crosses the Bača river or runs only metres away, environmental effects of derailments have to be considered. Not considering the possibility of hazardous goods that trains carry along the test bed section, diesel locomotives themselves, with up to 4000 litres of fuel, pose a threat of environmental contamination. Based on environmental vulnerability, the railway stretches have been classified into 4 vulnerability classes.
- Visibility: since the travelling speed is slow (60 to 70 km/h) there is a possibility that the engine driver may see the obstacle (avalanche or rockfall deposits) on the track far enough ahead and be able to stop the train or at least slow it down, so that the impact causes less damage. Visibility was estimated from the digital elevation model and orthophoto images. The train stopping distance was estimated considering the track slope, estimated deceleration, travelling speed and direction. Regarding both sets of lengths (the stopping distance and visibility length for trains travelling in both directions) the railway stretches were marked as: good visibility, moderate visibility or poor visibility.
- Radial effect: if a collision occurs, the probability of derailment (with greater damage) is higher if the collision takes place in a curve rather than on a straight line of track. On the basis of the data on curve sequence supplied by Slovenian Railways, an analysis of curve effects has been made. Besides the radius of bends the travelling speed was taken into consideration as well. From both parameters radial acceleration has been calculated and the railway stretches have been classified into two classes: significant radial effect and insignificant radial effect.

All the measures described above are based on data available for the whole Slovenia. Thus this method is applicable to the whole Slovenian railway system and, with some changes, to the road network as well. After all the above-mentioned measures had been taken into consideration, the final 4 vulnerability classes were defined according to the next three steps:

1. For each 10 metre stretch of the railway the higher class of the first two measures (railway infrastructure vulnerability and environmental vulnerability) was taken.
2. The resulting vulnerability factor was modified in the light of the third measure (visibility):
  - a. where visibility was marked as good, vulnerability was set one class lower (unless already lowest),
  - b. where visibility was marked as poor, vulnerability was set one class higher (unless already highest),
  - c. where visibility was marked as moderate no modifications have been made.
3. In the same way the vulnerability factor obtained was modified in the light of the last measure (radial effect):
  - a. where the radial effect was marked as significant, the vulnerability was set one class higher (unless already highest),
  - b. where radial effect was marked as insignificant no modifications have been made.

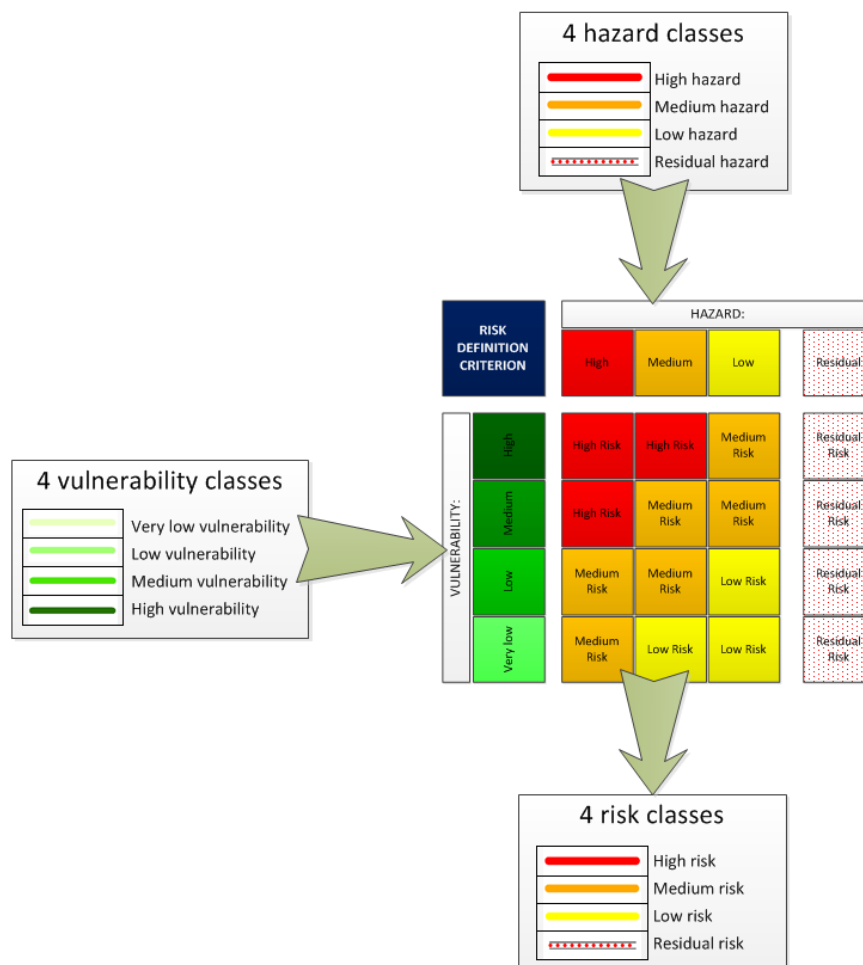
From these vulnerability classes the vulnerability map was made. The markings for the four classes and the vulnerability assessment procedure are shown in Figure 147.



**Figure 147: Vulnerability assessment procedure**

### Risk map elaboration and method

Risk is a combination of the probability of a natural event and of the potential adverse consequences. Based on this definition the risk for the railway infrastructure was evaluated from hazard and vulnerability assessed according to the method at hand. Four risk classes were defined: high, medium, low and residual risk. Markings for risk classes were set and are shown below (Figure 148). Ten metre long railway stretches were classified according to known hazard, vulnerability and the defined risk criterion matrix (Figure 148).



**Figure 148: Risk assessment procedure**



## Method result – avalanche risk map

One of the prescribed conditions of the method developed was transparency and clarity of results. The materialisation of this condition is the creation of the avalanche hazard, vulnerability and risk maps. The main result is the avalanche risk map created. It serves as a useful tool for decision-making, since it depicts the areas of high and low risk. This is crucial for establishing priorities in relation to risk mitigation activities.

## Conclusion

The method described above, developed for the goals of the PARAMount project, is a promising tool for improving risk-related decision-making on the Slovenian railway network, since it can easily be applied to other endangered railway sections and with some modifications even to the endangered roads. Although it is not sure that this concept will be accepted by the responsible authorities (Rak et al. 2012a), the possibility of a uniform risk evaluation, and especially a uniform representation of areas at risk, leads to the better understanding of risk by non-experts and thus to better decision-making with a view to risk mitigation.

## References

- Papež, J., Steinman, F., Rak, G. 2010. Projekt PARAMount - izboljšanje preventivnega upravljanja s tveganji pred naravnimi nevarnostmi na področju železniškega in cestnega prometa na območju Alp. Proceedings of the 10<sup>th</sup> Slovenian Congress on Roads and Traffic, Portorož, Slovenia.
- Rak, G., Kozelj, D., Papež, J., Steinman, F., Zupančič, G. 2012a. Ocena ogroženosti zaradi snežnih plazov in padajočega kamenja na železniškem odseku Podbrdo – Most na Soči. *To be published in the proceedings of the 11<sup>th</sup> Slovenian Congress on Roads and Traffic.*
- Rak, G., Zupančič, G., Papež, J., Kozelj, D. 2012b. Izdelava kart nevarnosti, ranljivosti in ogroženosti zaradi snežnih plazov in padajočega kamenja na odseku Bohinjske proge Podbrdo – Most na Soči v okviru projekta PARAMount. *To be published in Ujma No. 26.*
- Sirk, K. 2011. Ocena nevarnosti snežnih plazov na železniškem odseku Podbrdo – Hudajužna (Avalanche hazard assessment on the railway section Podbrdo - Hudajužna). Graduate Thesis, Faculty of Civil and Geodetic Engineering, University of Ljubljana.

## 7 Assessment of protection works' effectiveness

Road and railway infrastructure managers have often to consider the status and the effectiveness of existing protection works: where are the most important protection works? which one should we maintain first?... The following sections present three developments related to the assessment of protection works' effectiveness. The first development consists in the use of dependability analysis, a method based on functional analysis, to describe and then evaluate the failures scenarios of protection works against torrential floods. The second section deals with an analysis of mechanical capacity of old, poorly technically documented, rockfall protection barriers. The third section deals with the effectiveness of protection works based on the mechanical evaluation of rockfall barriers

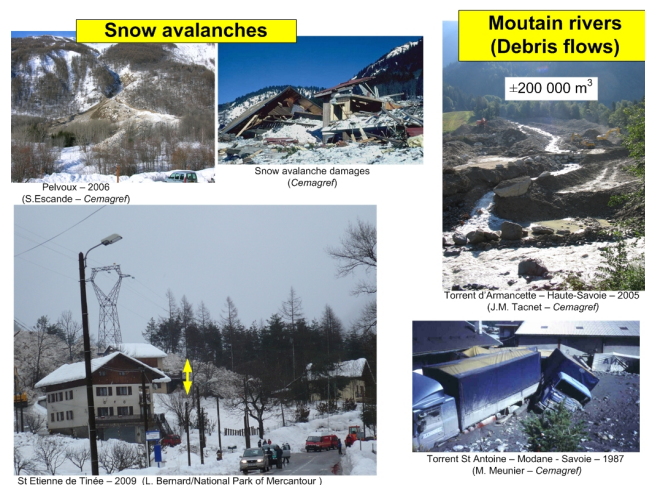
### 7.1 Effectiveness of protection works: an approach based on dependability (safety and reliability) analysis

*This section has been written and verified by Jean-Marc Tacnet (Irstea, Snow avalanche engineering and torrent control research unit, Grenoble, France).*

An integrated approach has been proposed and applied in the Saint-Antoine test bed to combine dependability analysis and multi-criteria decision analysis to assess the effectiveness of protection works [Tacnet et al., 2012b] [Tacnet et al., 2012a]

#### Introduction

Natural phenomena in mountains put people and assets at risk, and the management and control of natural risks remain important issues for society.

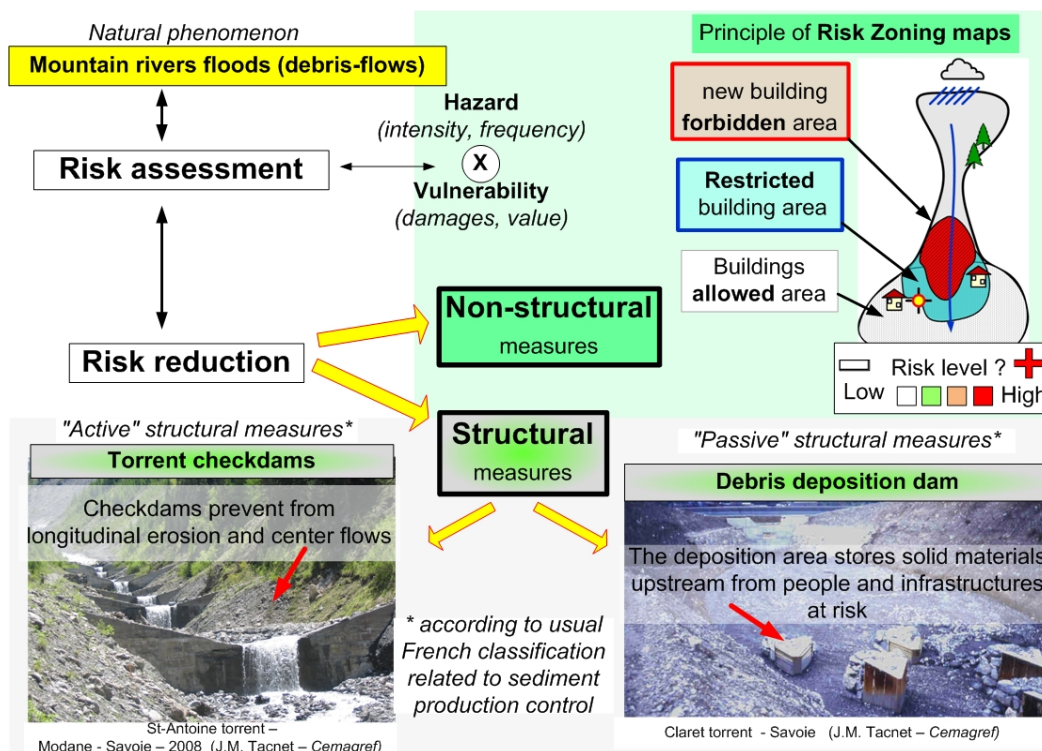


**Figure 149: Rapid mass movements such as debris flows are very destructive phenomena in mountain areas (Tacnet et al., 2009)**

This approach deals more specifically with these natural hazards in mountains and especially with debris flows, a torrential phenomenon which is one of the most dangerous rapid mass movements in mountainous areas (Figure 149).

## Effectiveness of protection measures conditions the risk level

Risk level is often described as a combination of hazard and vulnerability. Hazard relates to the intensity and frequency of phenomena while vulnerability concerns damages and values assessment. Risk assessment implies the combination of these two components, based on which risk reduction measures and strategies can be suggested. Mitigation actions are based both on non-structural measures such as land-use control and on structural measures such as protection works (Figure 150).



**Figure 150: Mitigation measures are based either on non-structural measures (such as land-use control) and structural measures (protection works) - adapted from (Tacnet et al., 2010b)(Tacnet et al., 2012)**

To prevent or at least limit these risks, protection works against flash floods thus play an essential part in reducing both the causes and effects of phenomena. The efficiency analysis of these protection works is consequently a very important issue for risk managers especially in the context of danger analysis of dykes and dams (MEEDDAT, 2008). For old protection devices, it is not easy to choose the best strategy for maintenance or to define priorities for selecting the first and most important sites to maintain. Decision support tools are needed to analyse the efficiency of these protection works taking both their structural state and functional effectiveness into account.

From a structural point of view, an important objective is to characterise and improve the efficiency of these protection works. This concept of efficiency is not clearly defined especially in the context of torrent protection works and requires specific design and building methods and technologies (Tacnet et Richard, 2010c). From a functional point of view, it remains essential to improve the knowledge of phenomena that threaten the protection works. To help the experts and decision-makers, numerical models are used to assess the height, speed and extent of flow.

For the global assessment of risk, the key issue is to combine the analysis of the phenomenon, the vulnerability assessment and the design of the protection works in question. Decision support tools are needed to analyse the efficiency of these protection works, taking into account both their structural state and their functional effectiveness. The goal of our approach is to introduce new techniques, mainly coming from the industrial domain, based on dependability analysis.

## **Objectives**

Risk depends both on phenomena intensity, frequency, vulnerability in exposed areas but also on the reliability and efficiency of protection works that are put in place. It is of main importance to provide methods and tools to make risk management as safe and efficient as possible for stakeholders and infrastructure managers. However, risk level assessment remains a complex process involving features of both natural and technological contexts. The methodology presented in this paper should contribute to a better comprehension and assessment of risky scenarios in the alluvial fans of torrent watersheds. The global integrated methodology uses both dependability approaches and also new advanced uncertainty analysis based on the hybrid approach for numerical modelling. This section presents some concepts related to the effectiveness (or efficiency) of protection works and a methodology which uses the MADS/MOSAR framework and the hybrid uncertainty assessment method to describe risk scenarios.

## **Adaptation of dependability analysis to protection works**

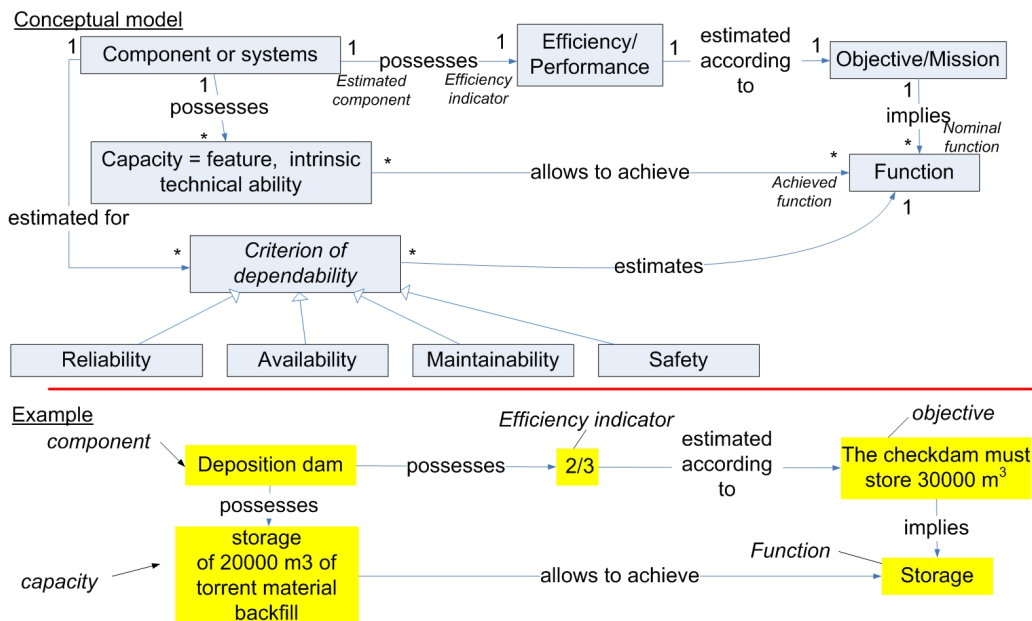
Our methodology is based on a combined used of dependability analysis and uncertainty analysis using ad hoc theories to take account of the imperfection of information.

### ***Definition of protection works effectiveness***

The risk assessment process depends mainly on hazard and vulnerability assessment but is also related to the effectiveness of protection works [Tacnet and Richard, 2010] [Tacnet et al., 2011a]. The concepts of dependability analysis (functional analysis and FMEA) are already used in the civil engineering domain and especially for hydraulic dams [Peyras, 2003] [Curt et al., 2011], to describe the systems and analyse their failure modes but remain quite new tools for analysis of the efficiency of protection works. Classic concepts of dependability have recently been discussed to assess the efficiency of protection works against torrential floods. Fuzzy intervals are used to assess the indicators that describe the possible failures and the performance level of disposals. A methodology is proposed for elicitation of the expert reasoning process and evaluation of the danger level of the protection works [Tacnet et al., 2012a] (Figure 151).

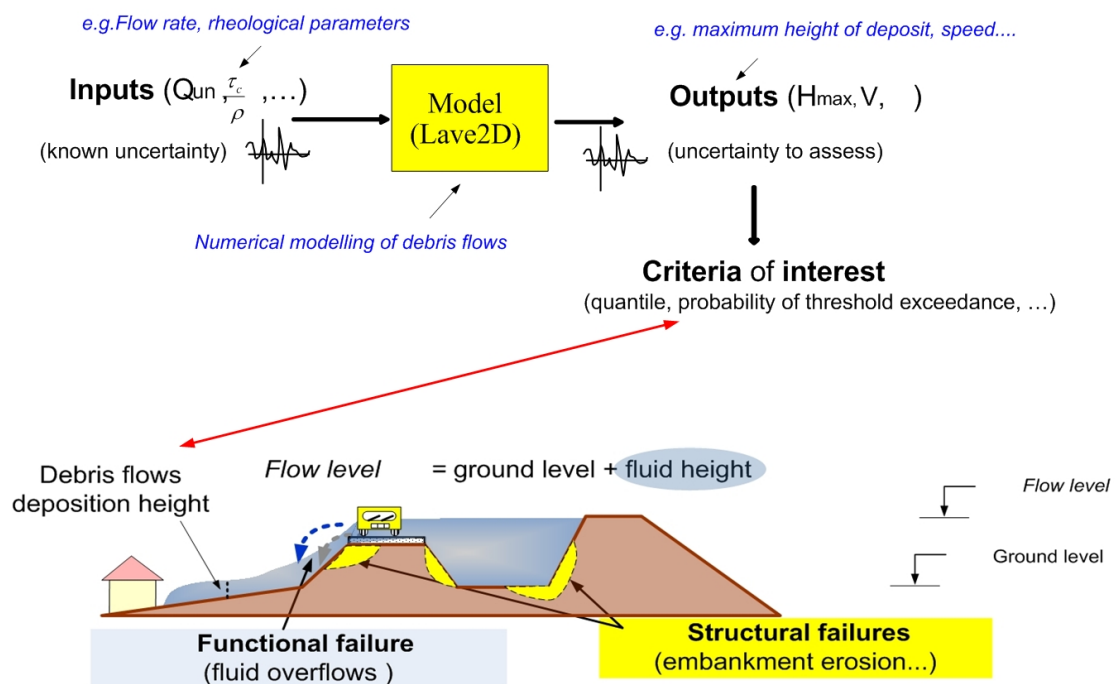


**Performance/Efficiency** : ability of a component, a system to carry out its mission, ability to reach its objectives

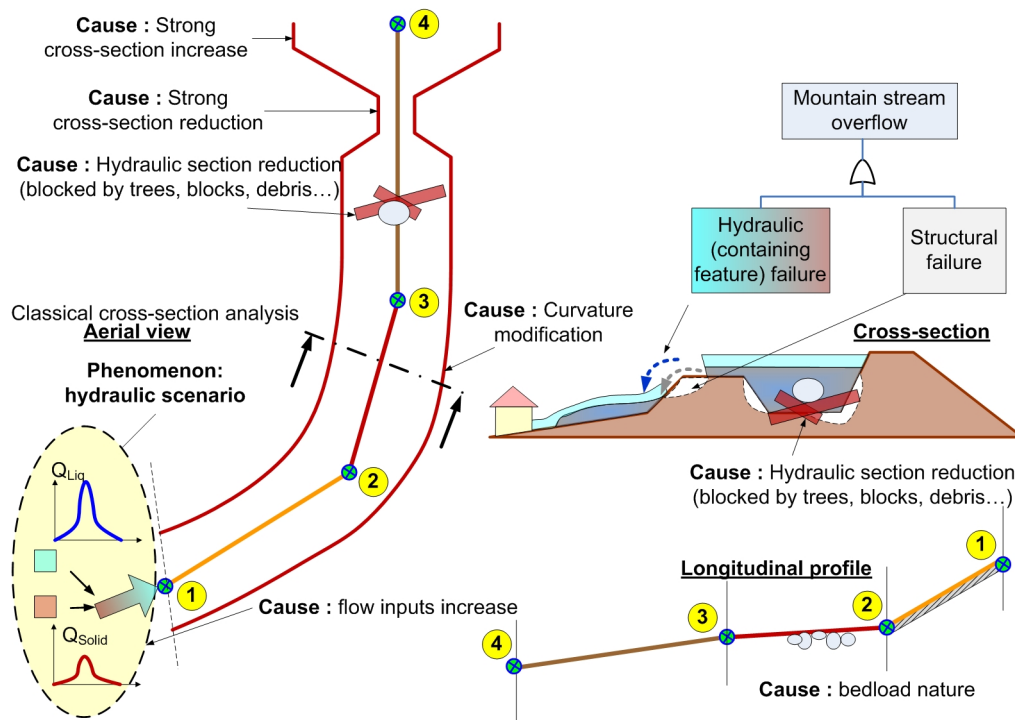


**Figure 151: Definition of the concept of efficiency (or effectiveness) [Tacnet et al., 2012a]**

This methodological framework has already been proposed for the adaptation of dependability analysis to the context of natural hazards. The definition of indicators of dependability as fuzzy numbers is a practical way to assess the capacity and efficiency levels. They are also used to analyse the danger level related to the protection works.



**Figure 152: results of numerical modelling (including uncertainty assessment like the hybrid approach) [Dupouy et al., 2012] are used as inputs for functional failure scenarios.**



**Figure 153: Principle of qualitative assessment of functional failures based on expert assessment (Tacnet et al., 2011)**

This approach has another interest and objective as well for works whose function is to limit risks: the estimation of performance (or efficiency) indicators is directly linked to a danger level downstream from them. It has an interest in the framework of risk prevention but also in the context of danger analysis which focuses on additional dangers resulting from the collapse of protection works [MEEDDAT, 2008]. In practical terms, its implementation is based first on a system description and on the proposal of indicators related to structural and functional failure modes [Tacnet et al., 2010d].

For functional failures, such as overflowing (Figure 153), the results of numerical modelling are used as input data especially to introduce quantitative approaches in terms of probability. The previous developments are therefore highly useful with a view to completing the expert analysis aimed at the identification of qualitative failure sensitivity (Figure 159).

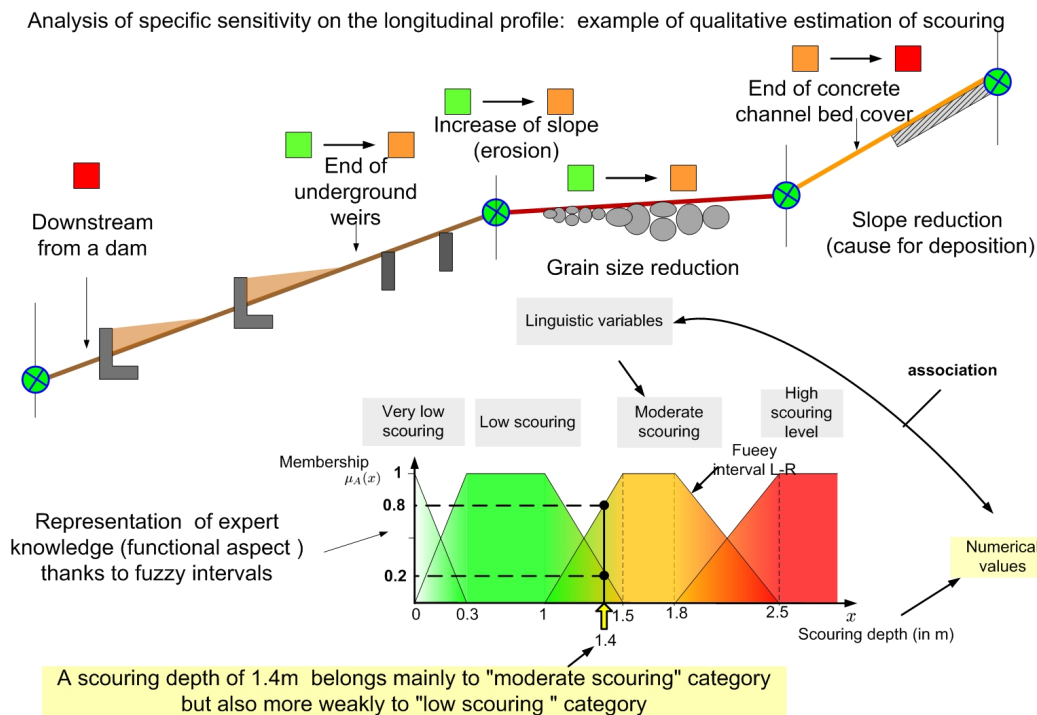


Figure 154: Quantitative assessment of functional failures based on fuzzy indicators (Tacnet et al., 2011)

### The input of an integrated approach based on MADS/MOSAR

The risk assessment of any rapid mass movement process implies the consideration of both triggering, propagation and extension zones: for a torrent, they correspond to the upper part of the catchment basin, the channel and the alluvial fan respectively (Figure 155). An analogy can therefore be proposed to assess risk for these different phenomena. We present here the case of debris flows but these approaches can obviously also be applied to avalanches and rockfalls.

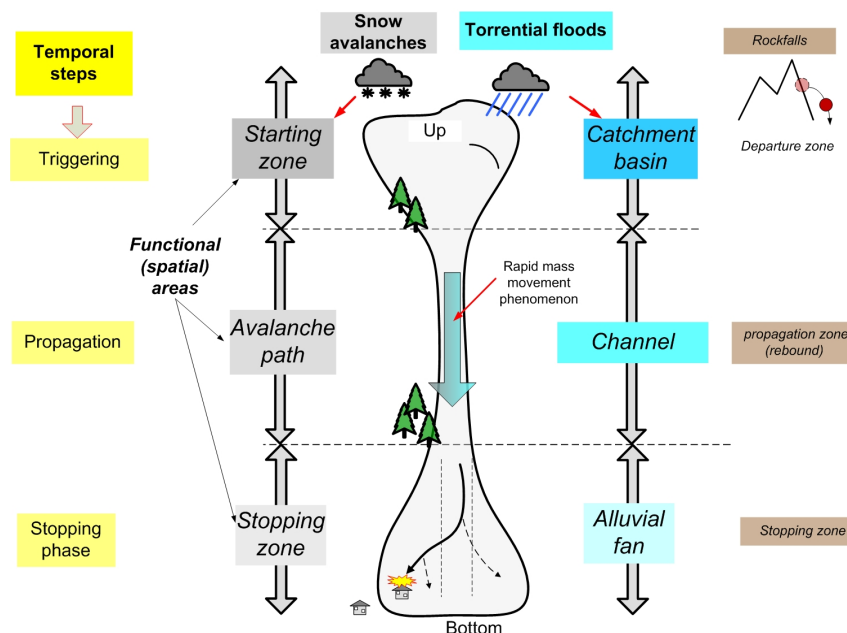
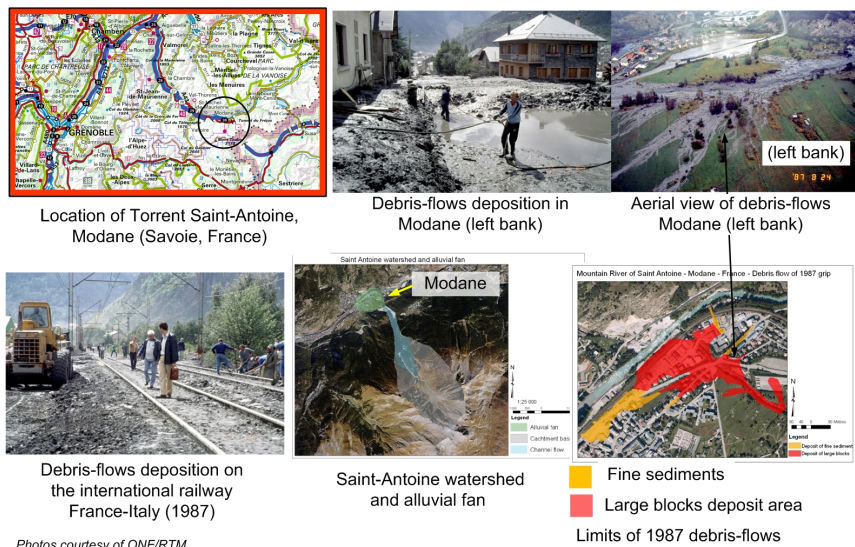
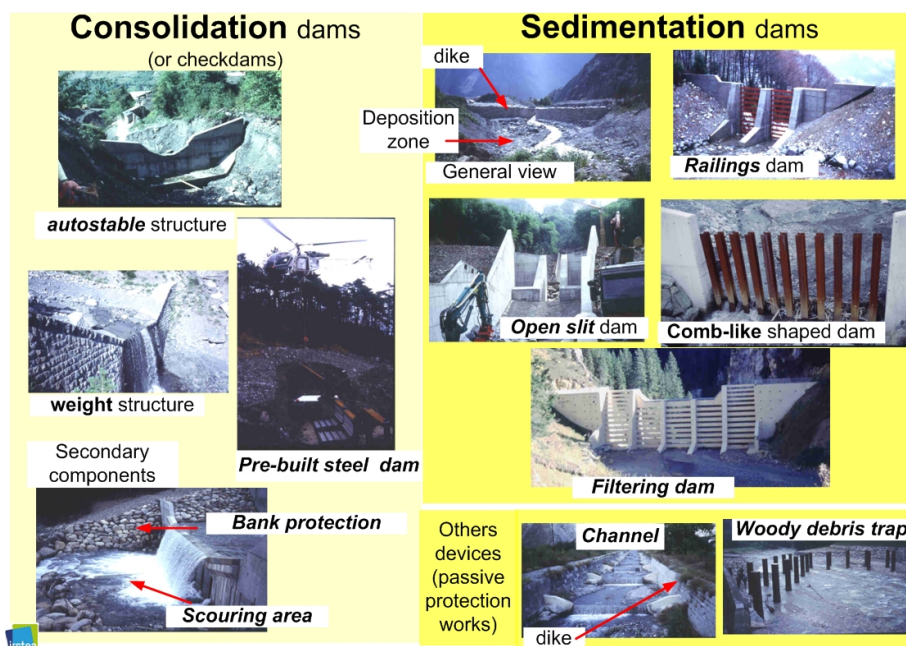


Figure 155: Temporal steps and functional areas for risk assessment: analogy between the different rapid mass movements (J.-M. Tacnet)



**Figure 156: Example of damage due to debris flows: protection works are built in order to reduce risk in the most vulnerable areas (buildings, roads, railways etc.) such as the alluvial fan [Dupouy et al., 2012]**

Different kinds of protection works are built in order either to limit sediment production (active protection measures) or to limit the consequences of overflowing in the stopping zones of the phenomena (passive measures) (). Therefore it is easy to understand that risk assessment in the lower part of the catchment basin, where vulnerability is high, closely depends on the entire protection chain that starts with protection works in the upper part of the risk basin, the channel (consolidation check-dams) and finishes on the alluvial fan (sedimentation dams, channels etc.). An integrated approach must be able to consider all the processes and their links from upper to lower parts of the catchment basin in relation to the people and objects at risk.



**Figure 157: Different kinds of active (check dams) and passive (sedimentation dams, channels) structural protection measures – adapted from (Tacnet, 2007)**



New developments adapt the risk assessment method MADS/MOSAR - see [Perilhon, 2007] (Perilhon, 2007) for a description of the principles of this method - which originates in the industrial domain to the natural risk context. The original methodology is based on a systemic approach and two main concepts. First, MADS (Méthodologie d'Analyse des Dysfonctionnements des Systèmes – Methodology of Analysis of the Dysfunctionality of Systems) proposes a general hazard model and describes the relations between a system and its environment. MOSAR (Méthode Organisée Systémique d'Analyse des Risques – Organised Systemic Method for the Analysis of Risks) is a global methodology to assess risk. MADS/MOSAR allows a global risk assessment since it associates a macroscopic approach and also a detailed risk analysis based on a microscopic approach, using classical dependability tools (FMECA, HAZOP, fault trees) [Magne and Vasseur, 2006].

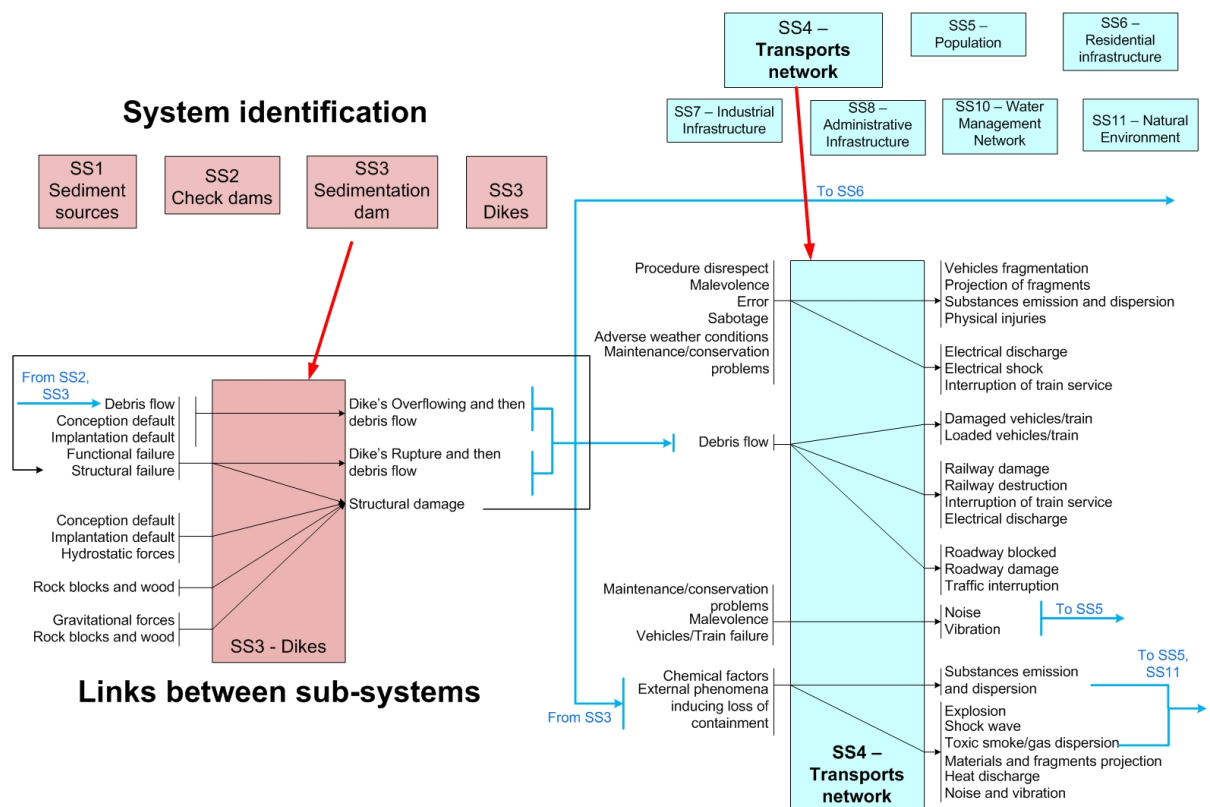
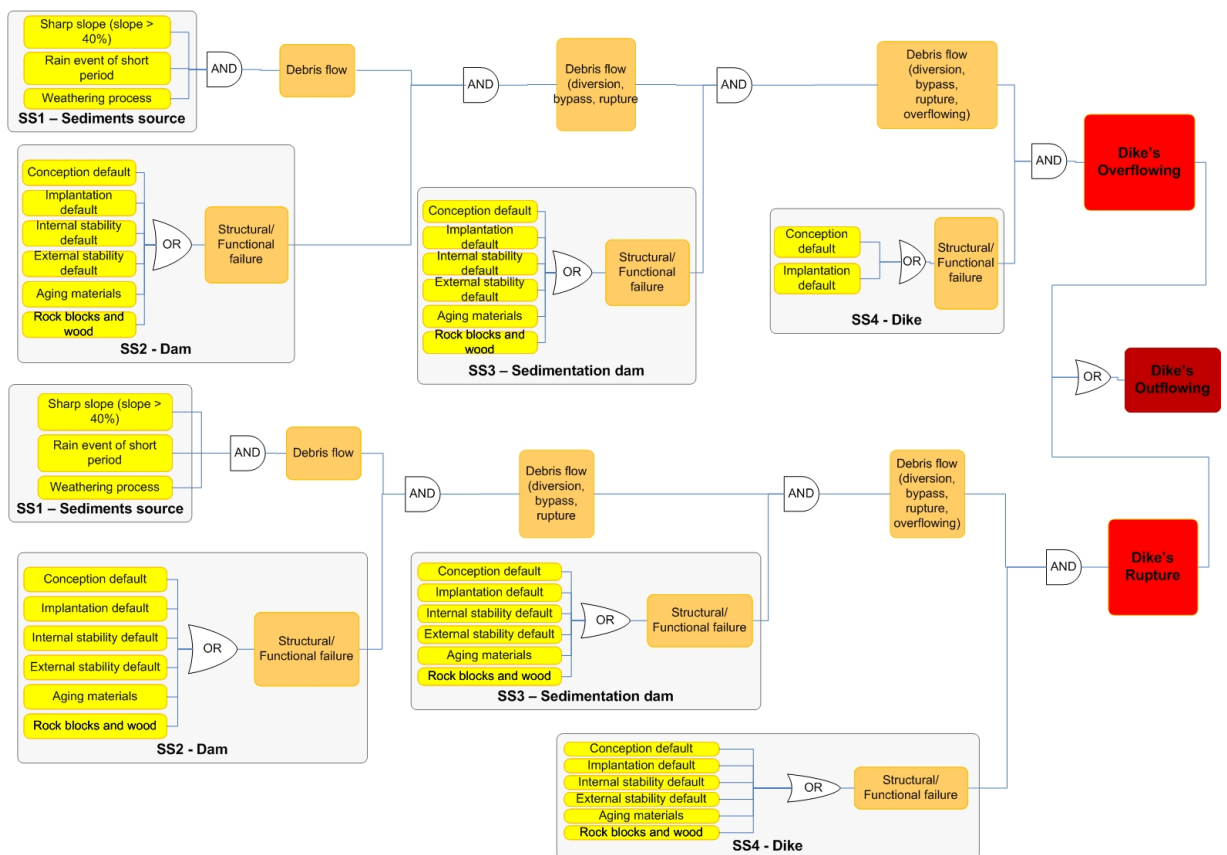


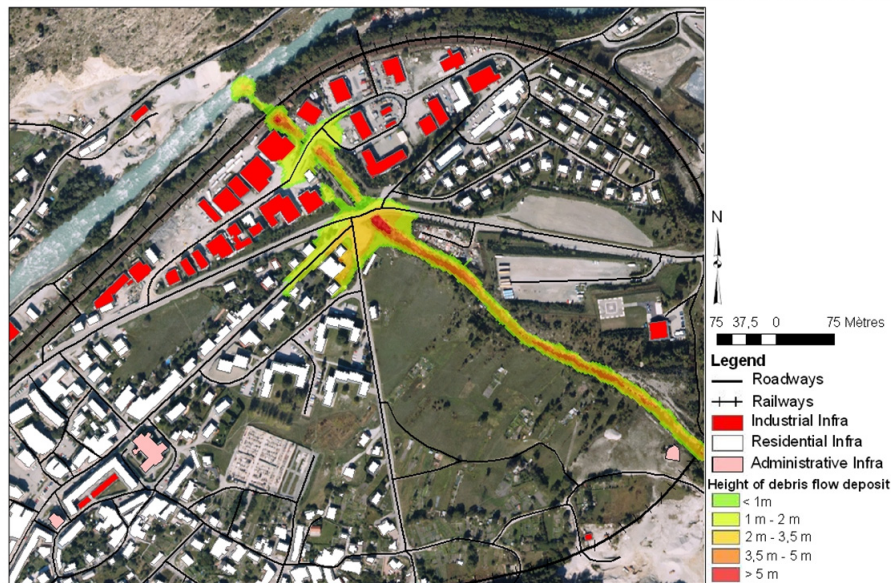
Figure 158: Examples of subsystem identification for MADS/MOSAR implementation in the context of torrent risk (Kaiber da Silva,2011)



**Figure 159: Example of a failure tree for a dike outflowing (Kaiber da Silva, 2011)**

This method is adapted to the alluvial fan of the Saint Antoine mountain river (Modane, France), our area of study, which is a diversified and complex environment. The plurality of actors and materials assets is significant. Historical data, expert advice and the results of numerical simulation in relation to our system are numerous. The systemic approach allows us to identify the subsystems with their interactions (Figure 158). On the other hand, different volumes of solid material mobilised in the catchment area arrive in the alluvial fan and lead to different interactions between the subsystems and consequently different levels of consequences (Figure 16). The previous modelling step is used to represent the physical scenarios. MADS/MOSAR method allows us to consider all the components of the whole system and their interactions in order to evaluate the different risky scenarios (including their criticality) that have been identified on the alluvial fan (Figure 160). One can finally represent these results corresponding to each uncertain phenomenon scenario in a GIS (Geographic Information System). These results are then used in order to assess the hazard level and the effectiveness of the protection works (Figure 160).

Mountain River of Saint Antoine - Modane - Savoie - France - Scenario 55 000 m3



**Figure 160: Application of a hybrid approach for information imperfection assessment to the context of natural hazards (debris flows): case study of the Paramount project – GIS representation of Scenario 55 000 m3 – quantile 95% (Dupouy et al., 2012) (Kaiber da Silva,2011)**

## Conclusion

This approach is a first attempt at the application of the MADS/MOSAR method to the context of torrent risk. This represents a major effort to to transpose a method arising in the industrial risk context to the context of natural risk. Our application of the method has shown shown that there are some difficulties in the description of natural phenomena scenarios. Some obstacles and limitations remain and require further development. However, we strongly believe in the potential of the methodology developed here for the assessment of risks in torrential river contexts.

Another key input of our approach is the use, as a preliminary result, of uncertainty analysis in relation to the numerical modelling of debris flows. Simulation is being more and more used in the risk management process, but scientists, technicians and all the stakeholders involved in decision-making must remember that any simulation model's result will be dependent on the quality of the input data that are used. When knowledge about inputs parameters is poor, they should consider very carefully the decisions that they are going to take when these are principally based on the numerical results. The hybrid approach is a new method to consider the real imperfection of information resulting from expert assessment. The results provided by this method are quite interesting for decision-makers since it shows how real knowledge influences the simulation results. In our opinion, no numerical modelling should be attempted without having first conducted uncertainty analysis along these lines, especially when severe consequences are expected as in the natural hazards context.

Finally, our integrated approach introduces and uses two new techniques based both on dependability analysis and hybrid uncertainty analysis to describe the risk scenarios related to debris flow events in mountainous areas. It looks like an innovative methodology, and the natural hazard context appears to be quite different from the industrial context, but some recent dramatic events

(such as the nuclear accident in Japan) show that risk analysis must closely include these two aspects. In our opinion, such kinds of combined methodologies are fully justified and represent an important research opportunity.

## 7.2 Comparison of the state of existing protection structures and the current risk situation as a way of setting risk mediation priorities

This section has been written and verified by Gašper Rak, Gašper Zupančič, Daniel Kozelj, Jošt Sodnik, Jože Papež, Franci Steinman and Matjaž Mikoš (University of Lubljana, Slovenia).

One of the areas that the Slovenian partners in the PARAMOUNT project chose as their test bed is the Baška grapa valley in Posočje. The valley has many distinctive interconnecting values: high natural value (pristine and protected ecosystems with endemic plants and endangered animals), high cultural value (it was the setting of the first Slovenian feature movie), high strategic value (it suffered severe fighting in WW1 and WW2) and transport value (through it runs the *Bohinjska proga / Woheinerbahn / Ferrovia Transalpina* railway). Baška grapa is a narrow valley with steep slopes, which are the source of avalanche and rockfall hazards (read more about the Baška grapa test bed in the *Risk Management and Implementation Handbook* or Papež et al. 2010). Although the railway is endangered, the state of current protective systems is somewhat obsolete. The Slovenian Railways (Slovenske železnice d.d.), also a PARAMOUNT observer, are the responsible authority for risk prevention. Their knowledge of the current risk situation and of the location and state of existing protection structures proved to be limited.

### Database of existing protection structures

Obrazec za popis objektov

ID objekta	055	Leto izgradnje	
Ime proge	Jesenice-Nova Gorica-Sežana	Kilometraža	41865
Nadomska višina [m.n.v.]	375	X	Y
		416023.69	114605.00
Odsek na pobočju	padanje	Vrsta objekta	palisada
Oddaljenost od proge [m]	15	Naklon pobočja	35-45
Dolžina [m]	60	Višina [m]	max 2.0 min 0.6
Oporniki	vrsta	tirnice	
	število	79	
Stanje objekta	slabo	Primernost objekta	zadovoljivo
<p>OPOMBE Objekt je delno še v dobrem stanju, vendar je že visoko zapolnjen in zato večinoma neefektiven. Nad objektom je veliko žarišče potencialnega materiala za padajoče kamenje.</p>			

SLIKA



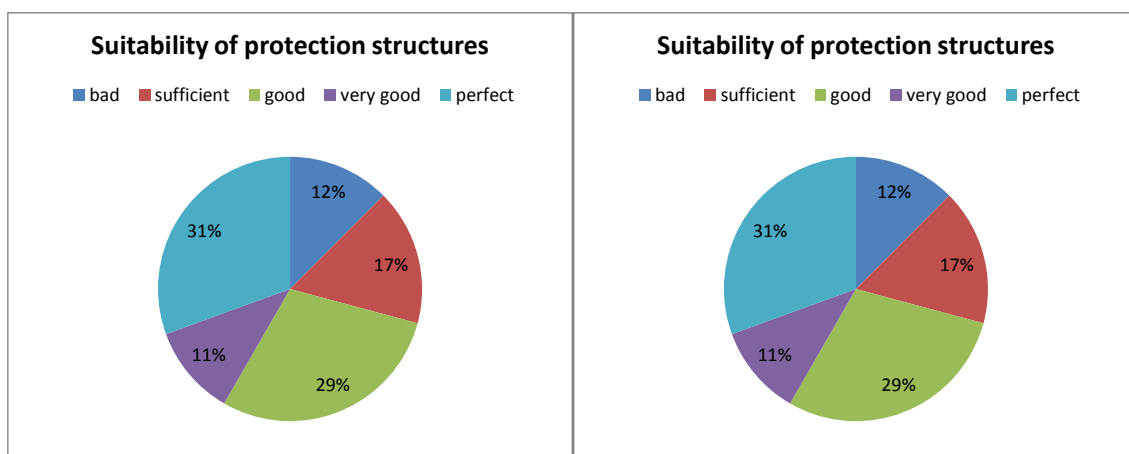
Figure 161: Protection structures survey form



Because of the initial state of things in the Baška grapa test bed, the Slovenian partners made an extensive database of the existing protection structures and their current state under the auspices of the PARAMount project. The database was created by multiple field surveys, at which for every protection structure a form (was filled out, so that the information gathered is transparent and can be easily accessed. Next characteristics were defined for every existing protection structure in the test bed area:

- Location (GPS coordinates)
- Distance from track and approximate railway chainage
- Altitude
- Slope inclination
- Year of construction (mostly unknown)
- Type of structure
- Structure dimensions (length, height)
- State of structure (bad, sufficient, good, very good, perfect)
- Suitability of structure for meeting expected hazards (bad, sufficient, good, very good, perfect).

In the survey, 72 protection structures were located along the 20 km long railway section Podbrdo – Most na Soči (Baška grapa test bed). The survey classified 17% of these structures as being in bad condition and 13% as being unsuitable (Figure 162); the average length of the structures is 37.5m and average height is 2m. Protection objects are typically either rigid wooden palisades, or light meshes or a combination of both (Figure 163). Many are not well maintained and some are in a state of collapse (Figure 164).



**Figure 162: State and suitability of existing protection structures**



Figure 163: Typical protection structure in Baška grapa



Figure 164: Collapsed protection structure due to neglect

## Existing structures and the risk situation

In the scope of the PARAMount project an innovative risk evaluation of the Baška grapa railway was carried out (see chapter 6.4). The results are the risk maps of the test bed area presented in chapter 4.1. Although the state of protection structures was taken into account in the risk evaluation method, some of the structures are in such a bad state that their protective function could be nullified in the near future, which would affect the risk situation. Thus a comparison of the current risk situation (the developed risk map) and the state of the existing protection structures gives us an overview of possible future risk situations.

Figure 165 gives us an overview of the current avalanche risk situation and the state of the existing protection structures. Two areas on the map are highlighted:

- Area A: The railway track in area A is classified as a low to residual risk area. Because many of the existing protection structures are in bad condition, the risk could easily increase if the protection structures continue to be neglected.
- Area B: the railway is already classified as a medium to high risk area. The ongoing neglect of the protection structures, which are already in bad condition, would maximise the risk in the area.

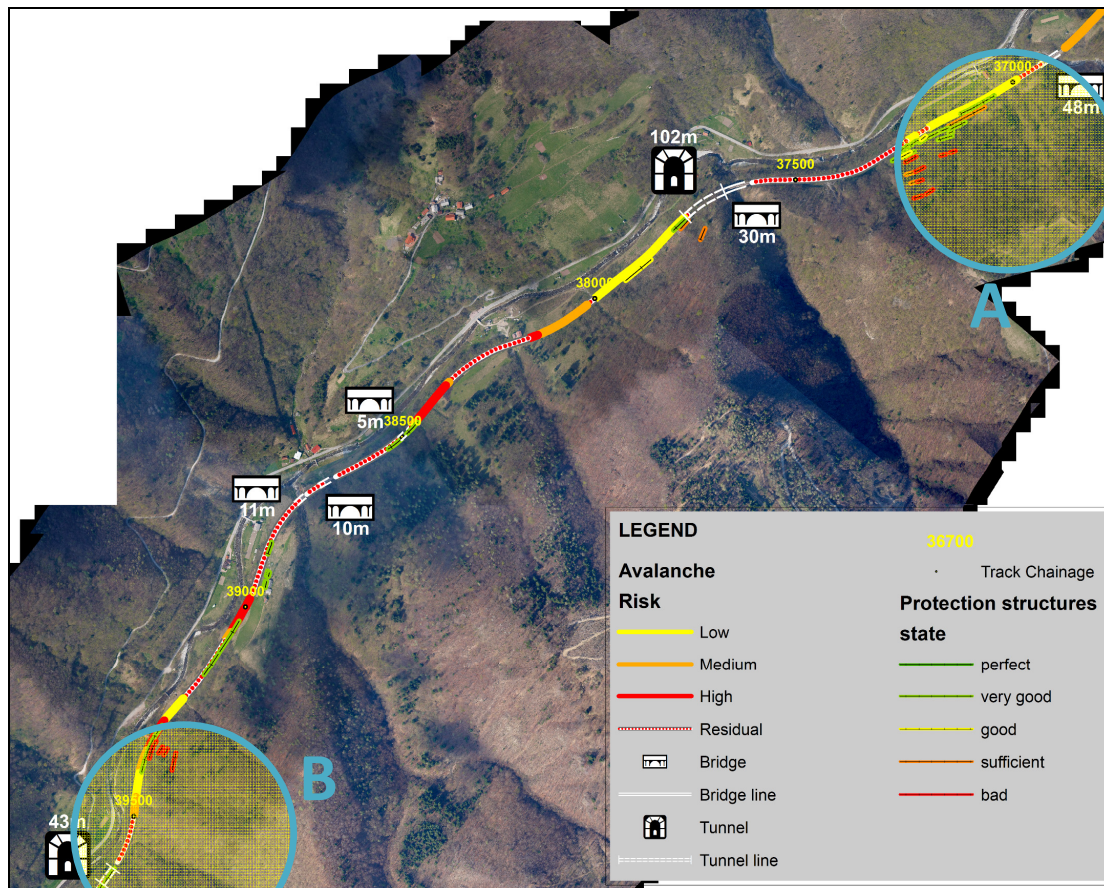


Figure 165: Avalanche risk map and state of the protection structures

For both the areas considered (A and B) and other critical sites, better maintenance of the existing protection structure is needed. Some of the structures would also need restoration works. Alternatively new state-of-the-art protection structures would bring even greater protection and would minimise the risk to the railway line. Since the construction of new structures or even restoration of the existing ones is not to be expected in the short term, the proposal to monitor the state of the protection structures, especially those in poor condition, seems well justified.

## Conclusion

In the Slovenian Posočje test bed (Baška grapa) the Slovenian partners of the PARAMount project created two important products: the database (register) of protection structures and the risk evaluation (risk map). While the risk situation needed for better risk management and decision support is presented on the risk map, and shows the important spatial risk distribution, the combination of the risk map and the database of protection structures offers other perspectives. The depiction of the risk situation and the state of the protection structures gives an overview of possible future risk situations, if the structures continue to be neglected as they have been for years. It shows also where the risk situation can be improved by the renovation of existing structures and where new structures are needed. With these possibilities, the combination of risk map and the protection structures database is a useful tool in connection with the decision support process.



### 7.3 Effectiveness of protection works based on the mechanical evaluation of rockfall barriers

*This section has been written and verified by Verena Larcher, Volkmar Mair and Claudia Stradia (Geological Service of Bolzano Province, Bolzano, Italy) and their subcontractors.*

A specific database called VISO for protective facilities has been developed. Many installed protective facilities are quite old, have no certification, and have suffered some damage over the years. Their protective function can no longer be guaranteed, but they should be able to prevent smaller events at least. For this reason, the University of Bologna DICAM department of transport engineering investigated the state of rockfall protection barriers installed in the Province of Bolzano, based on the VISO database, which incorporates the available technical documentation and in situ surveys. Additionally a set of FEM (finite element method) models was developed to predict the behaviour of these structures on suffering impact from blocks of known kinetic energy. These models were designed to evaluate the effectiveness of existing barrier types in relation to possible rockfall events. The results form a basis for forecasting the behaviour of existing barriers on rockfall impact, in terms of structural deformation and the forces impacting on the foundations and anchoring points.

#### **PARAMOUNT database for rockfall barriers**

A new database solely dedicated to rockfall protection barriers was required to support organised access to the data. This database included information relevant to the position, the geometry and the relevant dimensions, the principal components and corresponding materials; data on barrier certification as well as technical or design reports were also included. In particular, a capacity expressed in terms of kinetic energy absorption was associated with each catalogue item. It was especially useful to group the inventoried barriers into three principal categories: flexible, semi-flexible and rigid. Principal barrier types and subtypes were also identified.

Rockfall barriers are metallic structures typically made of three main parts: an interception structure, a supporting structure and connecting components (Figure 2). The interception structure is designed to bear the block impact, the supporting structures keep the interception structure in place and the connecting components, which are all the other system elements (e.g. longitudinal ropes, uphill cables, downhill cables and side cables, clamps, studs, energy dissipating devices) transfer the impact loads to all the foundations and anchorages.



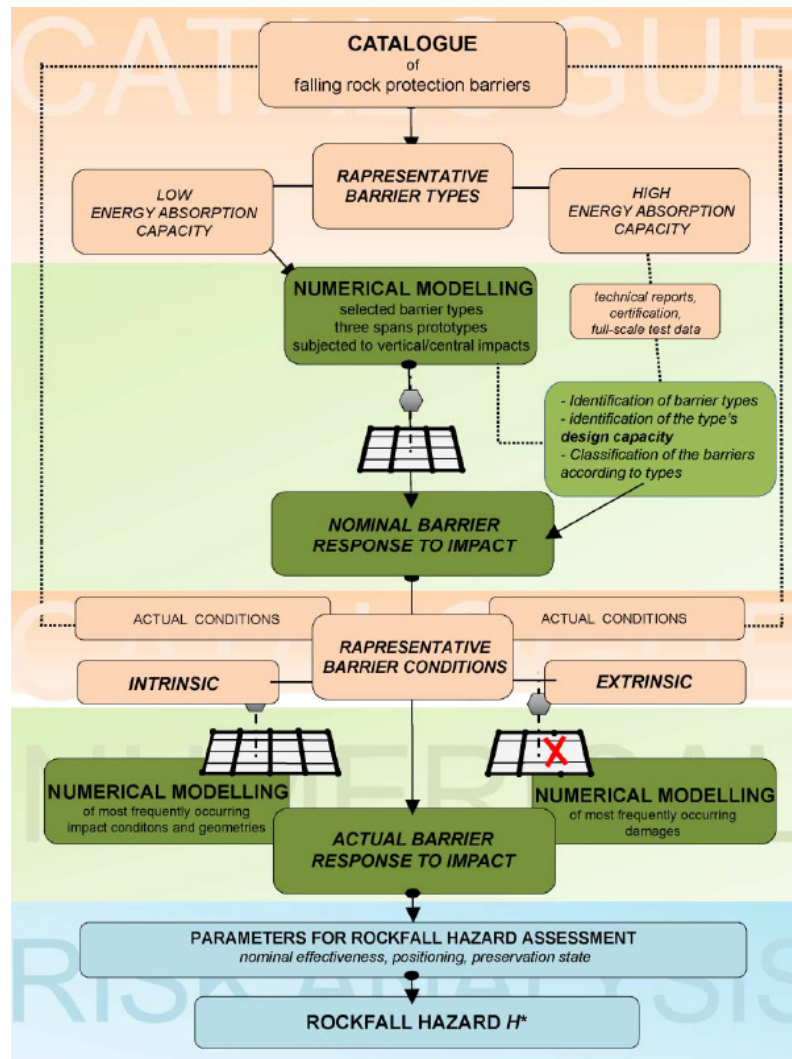


Figure 166: Method of analysing the response of rockfall protection barriers to produce reliable parameters for rockfall hazard assessment

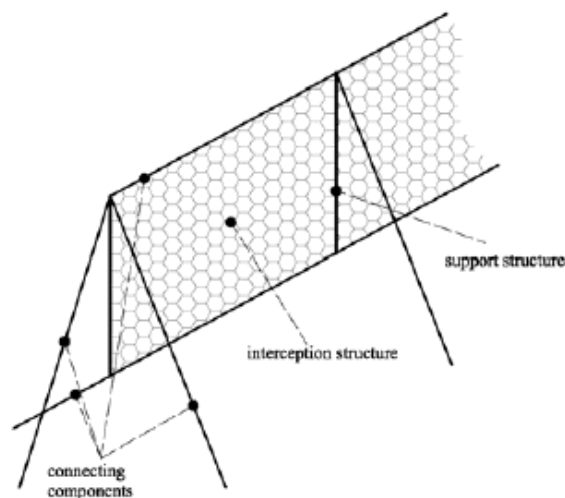


Figure 167: Main components of a typical rockfall protection barrier

The database included information relevant to the position, the geometry and the relevant dimensions, the principal components and corresponding materials, data on barrier certifications as well as technical or design reports. Information was also collected on the barrier's state of maintenance. The database was then analysed to identify the principal barrier types and subtypes and damage types and origin.

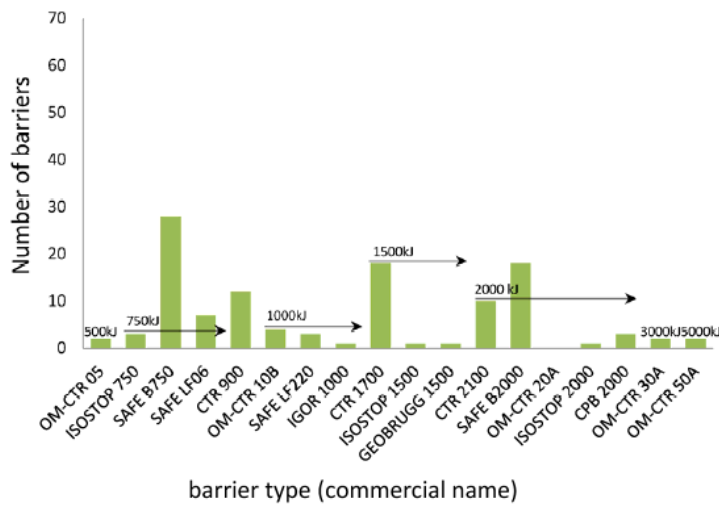
Barriera "Tipo ANAS"					
Altezza utile	3,2 m				
Montanti	all'estremità IPE 300 con passante per funi intermedi IPE 200				
Interasse	5 m				
Montante/fondazione	Il montante è fissato al pinto in cls mediante una piastra di base, con 4 tirafondi				
Fondazione	pinto in cls				
ancoraggio funi	controventi laterali, diametro 18 mm, fissata presumibilmente (non si vede) con un ancoraggio in barra d'acciaio;				
Funì orizzontali	nr. 15 funi orizzontali, diametro 12 mm, distanza di 25 cm, fissate attorno al montante estremo con 4 morsetti ciascuna				
Rete	rete metallica a doppia torsione, maglie 8"10cm, spessore filo 2,7 mm; la rete è fissata alle funi orizzontali mediante un filo di ferro				
Esempi dal database PARAMOUNT					
codice VISO	Strada	KM	H (m)	L (m)	I (da foto)
ss38_12_1_MS_029/028/031	SS38				



The figure includes several photographs of the barrier structure. One photo shows a close-up of a vertical post with a height label 'h=3,20m' and a width label 'l=5m'. Another photo shows a close-up of the base of a post with a label 'Piastrafuni del montante' and a '25cm' dimension. A third photo shows a close-up of the connection between a post and a concrete foundation, labeled 'pinto in cls'. A fourth photo shows a close-up of the lateral bracing and anchoring, labeled 'Particolare del collegamento controvento/montante' and 'Controvento laterale e relativo ancoraggio'. A fifth photo shows a close-up of the horizontal cables, labeled 'Particolare del collegamento controvento/montante'.

Figure 168: Data collected on a semi-flexible barrier by in situ surveys

The next step consisted in the development of a method to group all the inventoried barriers, including those for which the documentation was scarce or absent, under the identified and above-mentioned types. Each barrier type features particular structural components and specific technical details. Therefore a specific interception structure, connecting component or supporting structure can be used to recognise a barrier type quite easily.



**Figure 169:: Main types of flexible protection barriers within the PAB**

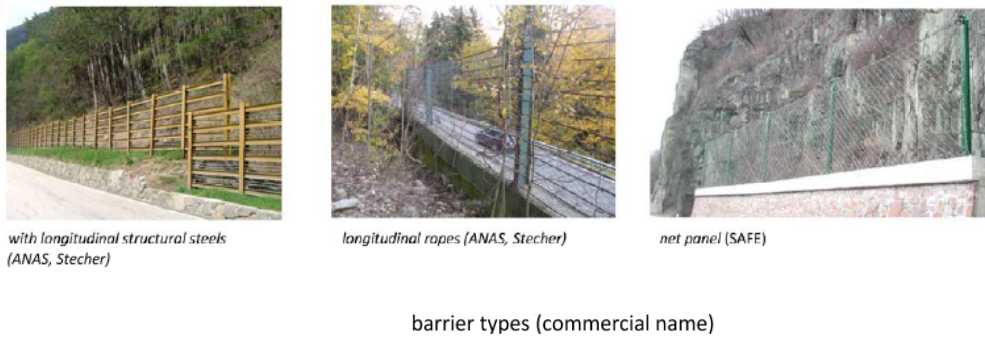
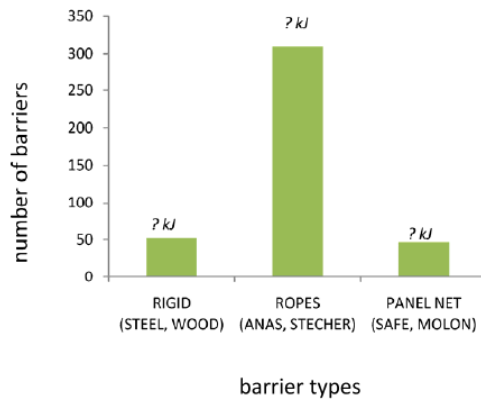


Figure 15 – Types of flexible protection barriers within the PAB.



**Figure 170: Main types of semi-flexible and rigid protection barriers within the PAB**

The data included in PARAMOUNT enable the identification of the type, origin and occurrence of the damages which affect the PAB’s rockfall protection barriers. The main causes are defective design, wear and tear and the consequences of natural events.

The most most frequently occurring types of damage are structural element failure, corrosion, accumulation of rocks boulders or fragments and accumulation of mixed materials.

**Figure 171: Main types semi-flexible and rigid barriers and damage (number 19 below)**

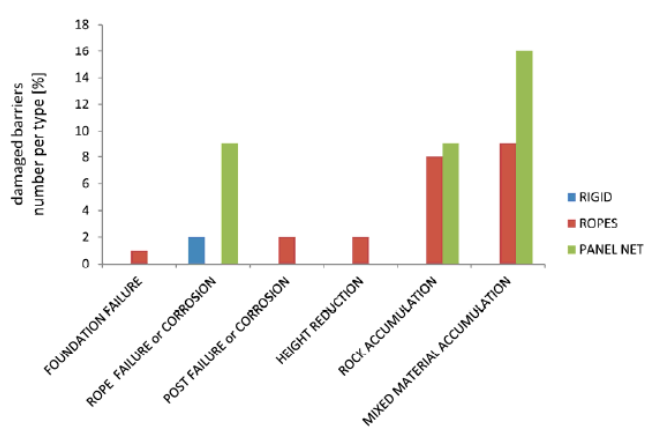
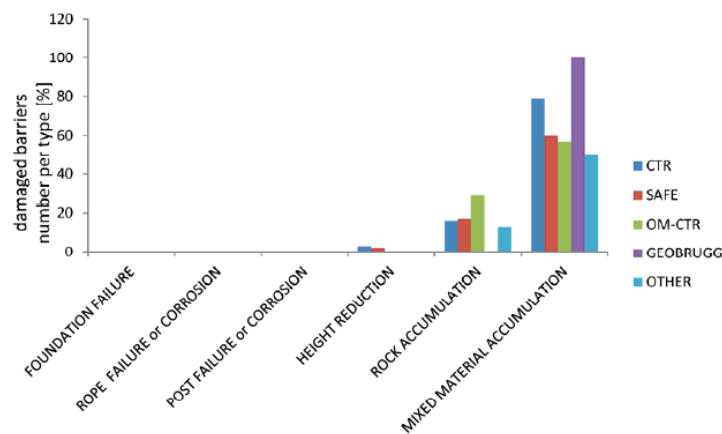


Figure 19 – Semi-flexible and rigid barriers and damage types



**Figure 172: Flexible barriers and damage types**

### **Prediction of the model failure and barrier capacity**

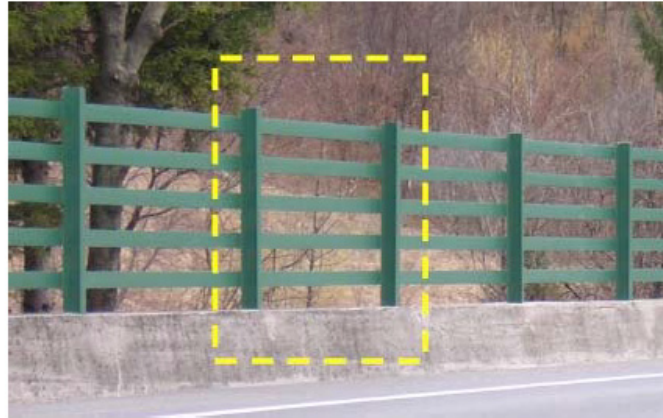
For the *semi-flexible* and *rigid* barriers, a procedure to predict the barrier’s actual capacity was developed. The procedure assumes that the cause of failure is the collapse of the structure itself, rather than the failure of the foundation. When structures collapse the model no longer converges, due to the formation of failure mechanisms produced by the creation of plastic hinges. The value of kinetic energy corresponding to such circumstances is considered as an upper bound for the barrier capacity, and the problem is traced back to the determination of the value of kinetic energy beyond which the model no longer converges. The procedure is as follows. By trial and error, a first non-linear and dynamic analysis is carried out using a small impact energy value, chosen so that the model reaches the convergence point. A new analysis is then carried out using a higher value of energy and the response of the model is observed. In general, plastic hinges may appear at this stage at the most stressed points. If the model still converges, a further analysis is carried out by further increasing the intensity of the impact energy. The process is reiterated until the barrier collapses. At this stage the procedure can be considered as having been completed, and the barrier capacity is taken as the impact kinetic energy in the second and last analysis. This energy level is the maximum energy level for the barrier in question.

For the *flexible* barriers, results of full-scale tests are generally available and the nominal capacity is known (Section 3). The experimental data are then used to develop numerical models of the barrier



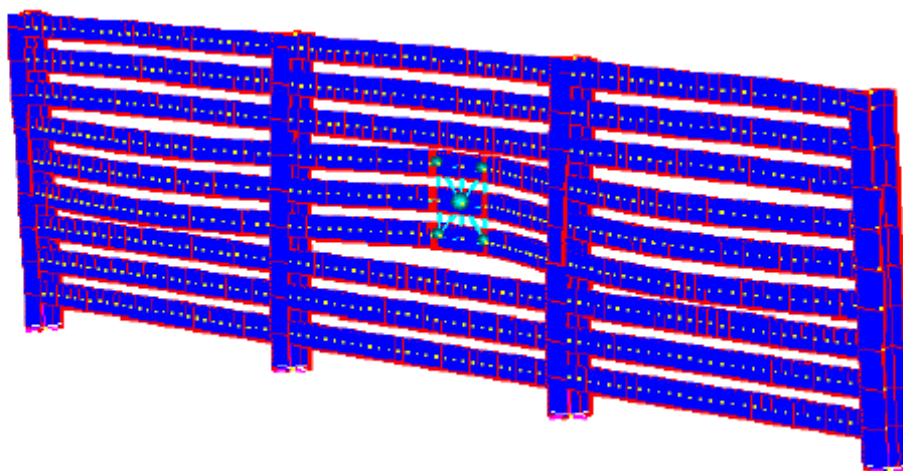
types which belong to this category. These numerical models are calibrated by reproducing the full-scale experiments and then used to explore the barrier *actual capacity*, with special regard to the evaluation of the barrier capacity in the presence of damages. In this case the actual barrier capacity is evaluated in relation to the nominal value, following a procedure which will be presented and discussed in the next section.

### Rigid steel barriers



**Figure 174: A steel, rigid barrier type in the Province of Bolzano**

The numerical analyses were carried out following the procedure described. The FE model, made of three functional modules, was impacted, in the centre, by a block shaped as a polyhedron. The model block was modelled using a set of non-structural concentrated masses as depicted in Figure 26. Velocity vectors of direction normal to the longitudinal beams were applied to the masses. The dimension of the block was chosen so that three longitudinal beams were involved in the impact. Preliminary analysis was carried out on the barrier model using a small energy value, and plastic hinges appeared at this stage at the most stressed points.



**Figure 175: Main types of formation of plastic hinges (in red) at the impact points**

As this analysis converged further analyses were carried out, keeping the block mass constant and increasing the velocity applied to the lumped masses. Following this procedure the barrier capacity was obtained according to the procedure illustrated.

The results relevant to the analysis which produced the barrier's actual capacity (maximum energy level) are shown in the following table:

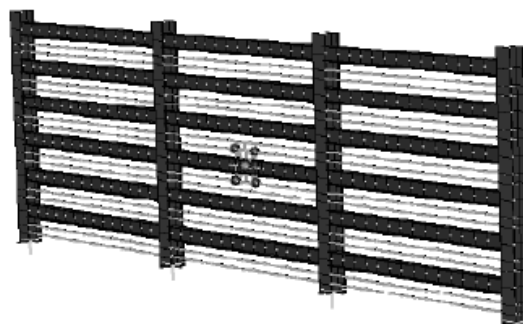
Block mass [kg]	311
Velocity [m/s]	1
Nominal Capacity [J]	100
Braking time [s]	0.015
Maximum elongation [m]	0.007
Maximum force at the foundation [kN]	30
Maximum moment at the foundation [kNm]	25

### The Tubre barrier type



**Figure 176: The Tubre steel rigid barrier type**

The FE model, made of three functional modules, was impacted, in the centre, by a block shaped as a polyhedron. The model block was modelled using a set of non-structural concentrated masses. Velocity vectors of direction normal to the longitudinal beams were applied to the masses. The dimensions of the block were chosen so that the central longitudinal beam and three longitudinal ropes were involved in the impact as depicted. The block dimensions were the same as for the previously analysed barrier model.



**Figure 177: Main types – the three functional modules model of the Tubre barrier type**

Block mass [kg]	311
Velocity [m/2]	3
Nominal Capacity [J]	100
Braking time [s]	0.042
Maximum elongation [m]	0.07
Maximum force at the foundation [kN]	160
Maximum moment at the foundation [kNm]	40

**Figure 178: Response of the barrier during an impact at the maximum energy level**

### The Anas barrier type



**Figure 179: The Anas steel semi-flexible barrier type**

The FE model, made of three functional modules, was impacted, in the centre, by a block shaped as a polyhedron. The block was modelled using a set of non-structural concentrated masses. Velocity vectors of direction normal to the longitudinal beams were applied to the masses. The dimension of the block were chosen so that three longitudinal ropes were involved in the impact as depicted in Figure 33. The block dimensions were the same as for the previously analysed barrier models.

As this analysis converged further analyses were carried out increasing the impact energy. Following this procedure the barrier capacity was obtained. The results relevant to the analysis which produced the barrier's actual capacity are shown in the table below:

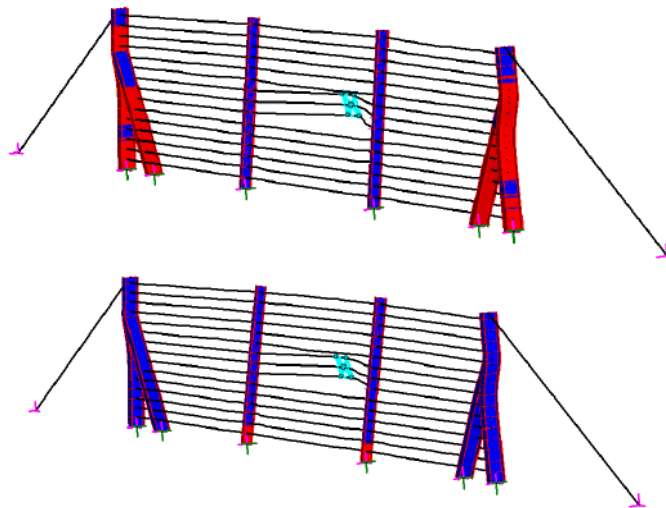


Figure 180:: Main types of formation of plastic hinges (in red)

Block mass [kg]	311
Velocity [m/2]	18
Nominal Capacity [kJ]	50
Braking time [s]	0.0478
Maximum elongation [m]	0.99
Maximum force at the foundation [kN]	600
Maximum moment at the foundation [kNm]	50
Maximum force at the side anchorages [kN]	90

Figure 181: Response of the barrier during an impact at the maximum energy level

### The Stecher barrier type



Figure 182: The Stecher steel semi-flexible barrier type

The FE model, made of three functional modules, was impacted, in the centre, by a block shaped as a polyhedron. The block was modelled using a set of non-structural concentrated masses. Velocity vectors of direction normal to the longitudinal beams were applied to the masses. The dimension of the block were chosen so that three longitudinal ropes were involved in the impact. The block dimensions were the same as for the previously analysed barrier models. As this analysis converged,



further analyses were carried out, increasing the impact energy. Following this procedure the barrier capacity was obtained. The results relevant to the analysis which produced the barrier's actual capacity have been inserted in the figure and the table.

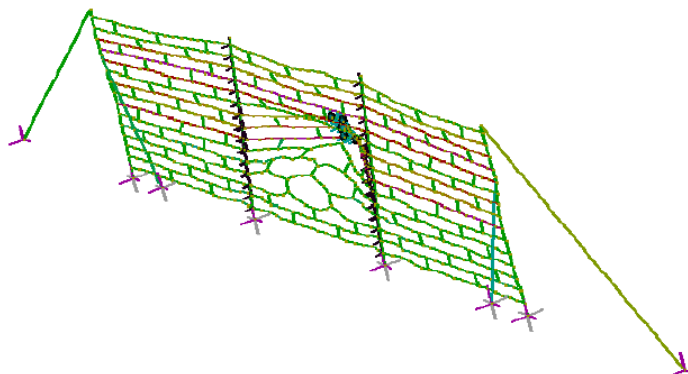
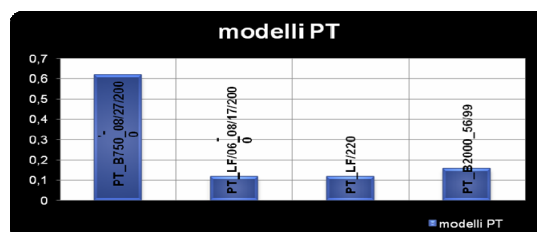
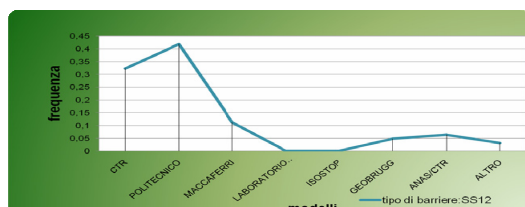


Figure 183:: Main types Deformed shape during the analysis

Block mass [kg]	311
Velocity [m/s]	18
Nominal Capacity [kJ]	50
Braking time [s]	0.078
Maximum elongation [m]	0.97
Maximum force at the foundation [kN]	600
Maximum moment at the foundation [kNm]	50
Maximum force at the side anchorages [kN]	105

Figure 184: Response of the barrier during an impact at the maximum energy level

## FE models of flexible barrier types



Different types of flexible barriers have been tested (Figure 185) .

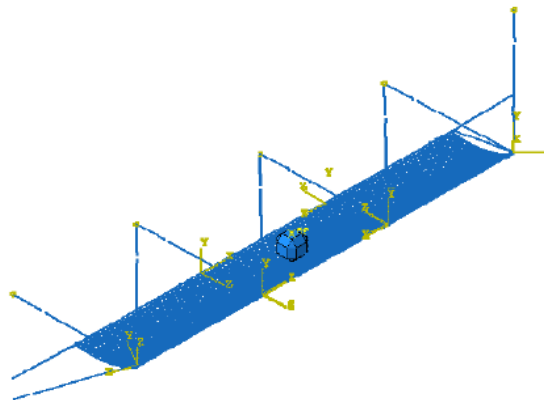
Figure 185: Different types of rockfall barriers

## The OM-CTR 30A barrier type



**Figure 186: Main types - the OM-CTR 30A flexible barrier type**

The barrier model, made of three spans as illustrated in the figure below, was subjected to a retrospective simulation of the full-scale test documented in the relevant report. As the barrier capacity is 3000 kJ, the analysis was run at about 3000 kJ of kinetic energy. Impact tests on a barrier model were simulated using a three-dimensional deformable body as the test block, with mechanical properties equal to those of high resistance concrete. The block's velocity was 25 m/s in the direction normal to the interception structure. The results are compared to those recorded in the experiments in the table.



**Figure 187: The three functional modules of the OM-CTR 30A barrier type**

Quantity [unit]	Full-scale tests	FE model
Energy [kJ]	3140	3140
Braking time [s]	0.3	0.34
Maximum elongation [m]	5.35	5.30
Maximum force at the foundation [kN]	300	330
Maximum force at the uphill anchorages [kN]	250	350
Maximum force at the side anchorages [kN]	350	400
Residual height [m]	3.55	2.49

**Figure 188 : Experimental and numerical response of the barrier during an impact at the maximum energy level**

## The Safe 750 barrier type



Figure 189: Main types – the OM-CTR 30A flexible barrier type

The barrier model, made of three spans, was subjected to a retrospective simulation of the full-scale test documented in the relevant report. As the barrier capacity is 750 kJ the non-linear and dynamic analysis was run at about 750 kJ of kinetic energy. Impact tests on the barrier model were simulated using a three-dimensional deformable body as the test block, with mechanical properties equal to those of high resistance concrete. The block's velocity was 15 m/s in the horizontal direction and  $v_y = 25$  m/s in the vertical direction following the report of the full-scale tests carried out at an inclined test site.

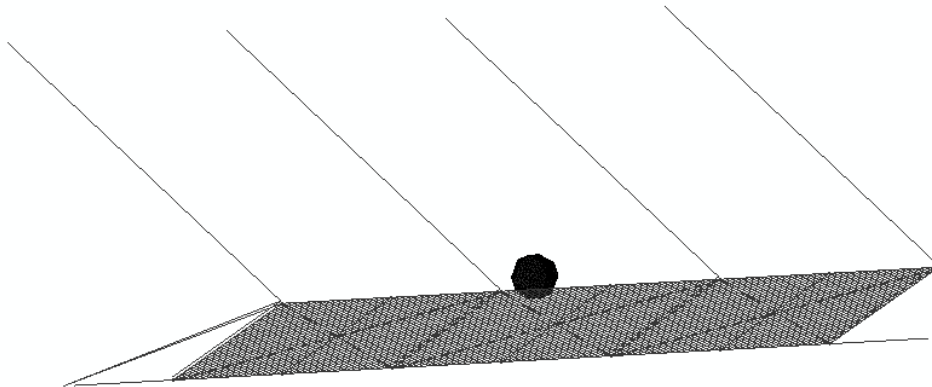


Figure 190: The three functional modules model of the Safe 750 barrier type

Quantity [unit]	Full-scale tests	FE model
Energy [kJ]	774	774
Residual height [m]	≈ 2.2	2.7
Maximum elongation [m]	≈ 3	3.5
Maximum force at the foundation [kN]	Not reported	250
Maximum force at the uphill anchorages [kN]	Not reported	95
Maximum force at the side anchorages [kN]	Not reported	120
Maximum travel of the energy dissipating devices [m]	0.95	1
Minimum travel of the energy dissipating devices [m]	0	0.15

**Figure 191: Experimental and numerical response of the barrier during an impact at the maximum energy level**

## Results of numerical modelling: towards an evaluation of actual barrier capacity

The nominal capacity can vary if the barrier has been installed in a configuration which diverges from the testing (experimental/numerical) configuration. This fact principally applies to the *rigid* and *semi-flexible* barrier types, whereas the flexible barriers are typically installed according to the manufacturer's technical specification. The data contained in VISO have shown that the same barrier type (*rigid* and *semi-flexible*) is often found in several geometrical configurations (e.g. post spacing, nominal height, presence of uphill or side cables). Furthermore, variations in the barrier elements have been also acknowledged (type and dimensions of beam's section, cable diameters). According to the data, the effects of the variation of these parameters have also been investigated using numerical models. Although such a procedure applies to any type of barrier, it is used in this section to study only the selected barrier type.

### **EFFECTS OF THE VARIATION IN THE GEOMETRY AND MECHANICAL PROPERTIES ON THE BARRIER'S CAPACITY**

In this section numerical models are developed to investigate the effect of geometrical and mechanical properties with reference to selected barrier types. In particular the Anas and the Stecher barrier types are examined. These types of barrier are, in fact, very widespread on the PAB's territory, in a variety of different configurations.

#### **Geometrical and mechanical variation**

With regard to the Anas reference barrier type, the following geometrical variations are examined: post spacing and nominal height. In both cases a three span model of the modified barrier was subjected to the impact of block, modelled with a set of concentrated masses of velocity directed normally to the interception structure. Several analyses were run until the model no longer converged. *Post spacing*. The following values are considered: 3.5 m (a) and 6.5 m (b). The deformed shape of the modified Anas barrier is shown for the maximum energy level analysis in case (a) and (b) respectively.



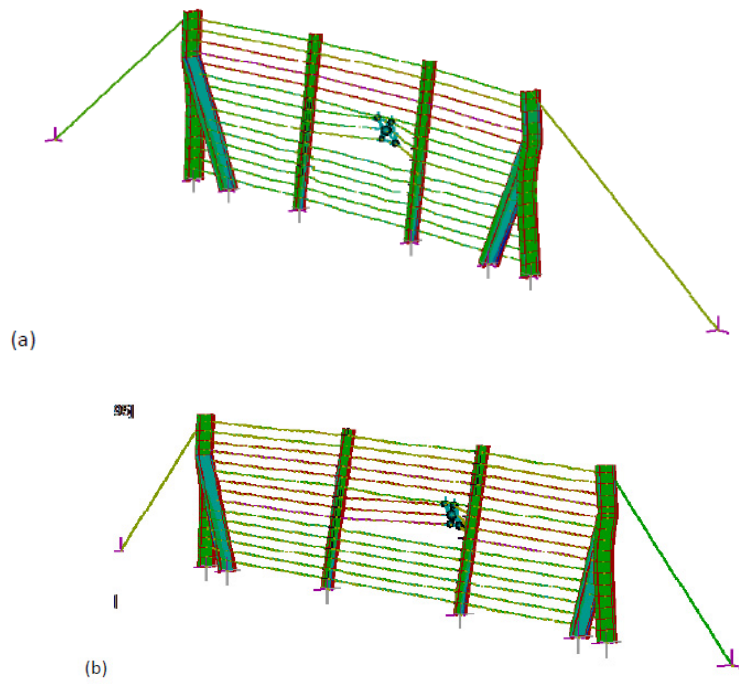


Figure 192: Deformed shape of the ANAS barrier type: a) 3.5 m post spacing and b) 6.5 m post spacing

Post spacing [m]	5 (Reference)	3.5	6.5
Block mass [kg]	311	311	311
Velocity [m/2]	18	16	21
Nominal Capacity [kJ]	50	40	70
Braking time [s]	0.0478	0.069	0.086
Maximum elongation [m]	0.99	0.75	1.26
Maximum force at the foundation [kN]	600	600	600
Maximum moment at the foundation [kNm]	50	50	55
Maximum force at the side anchorages [kN]	90	75	100

Figure 193: Response of the barriers during an impact at the maximum energy level

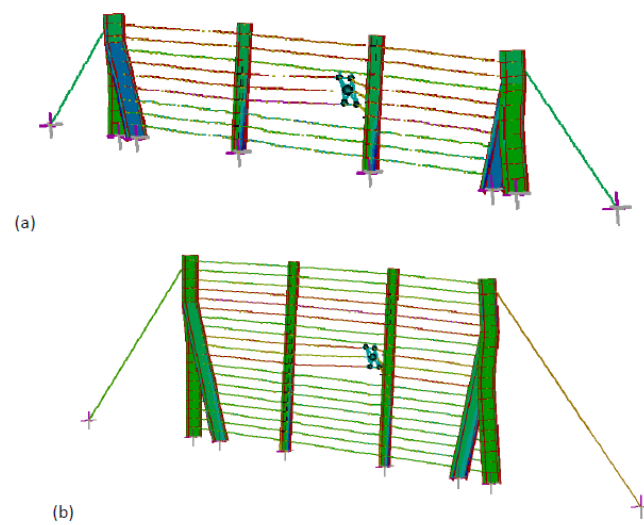


Figure 194: Deformed shape of the ANAS barrier type: a) 2 m nominal height and b) 4 m nominal height

Nominal height [m]	3.2 (Reference)	2	4
Block mass [kg]	311	311	311
Velocity [m/2]	18	16	21
Nominal Capacity [kJ]	50	40	70
Braking time [s]	0.0478	0.073	0.1
Maximum elongation [m]	0.99	0.82	1.94
Maximum force at the foundation [kN]	600	500	400
Maximum moment at the foundation [kNm]	50	55	50
Maximum force at the side anchorages [kN]	90	3	55

**Figure 195 : Table: response of the barriers during an impact at the maximum energy level**

### OBSERVATION OF THE EFFECTS OF THE DAMAGE

In this section, numerical models are developed to investigate the effect of damage on the barrier's nominal capacity. The damages can be considered and included in the barrier model types to predict a possible actual capacity of the barrier. A method for the estimation of the reduction in the barrier capacity due to the presence of damage was developed. The method can be used for any barrier type, but has been devised with reference to the *flexible* barrier type. The procedure is as follows. The response of a barrier prototype, as observed during full-scale tests carried out at the maximum energy level, is taken as the nominal or reference response. The reference response is described through the following quantities: nominal capacity, braking time, maximum elongation, residual height and forces mobilised at the anchorages and foundations. An FE model is then developed of the barrier prototype and the model parameters are calibrated by retrospectively simulating the full-scale tests. The model should be simple but must ensure a good match with the experimentally observed response.

The calibrated and verified model is then modified to incorporate a possible damage. According to the examination of the damage types and origin, the possible damages are: corrosion of structural elements, failure of structural elements, accumulation of rock or mixed materials. These damage types can be included in the FE models of a prototype as follows:

- corrosion of structural elements: reduction of the element section
- failure or loss of structural elements
- barrier deformation after a concentrated or distributed impact: investigation of an impacted model (successive launches).

The FE model, suitably modified to accommodate the damage, can be subjected to a nonlinear and dynamic analysis to explore its actual response in terms of braking time, maximum elongation, residual height and forces mobilised at the anchorages and foundations. The analysis should follow the procedure used to obtain the nominal or reference quantities to enable a comparison of the model response in the two different conditions.

Initially the analysis should be carried out at the maximum nominal energy level. If the results of the analysis ensure that:

- forces and displacements mobilised within the damaged barrier do not exceed the nominal forces and displacements;
- the barrier deformations are still acceptable;
- the stresses mobilised within the barrier elements are kept within the admissible threshold.

then the actual and nominal barrier capacity can be considered coincident.

In case these requirements are not fulfilled, a further analysis should be carried out at a diminished energy level and the process ends when the results of the analysis ensure that all the above-stated requirements have been fulfilled. The energy level at which the last analysis is carried out can then be taken as the actual maximum energy level and actual barrier capacity.

### The effects of structural element corrosion

The effect of the corrosion of the structural elements is investigated in this section with reference to two cases:

a) The corrosion has produced a reduction of section in all the cables equal to 40%. As all the barrier cables feature a 20 mm diameter, the damaged model of barrier OM-CTR 30A will present a 12 mm diameter cable;

b) The corrosion has produced a reduction in the section of the cables within the interception structure equal to 40%. As the equivalent truss elements of the model of barrier OM-CTR 30A features an 8 mm diameter, the damaged barrier will feature an interception structure of 4.8 mm diameter cables.

The modified model of barrier OM-CTR 30A (case a), made of three spans, was subjected to an impact at the maximum energy level. As the nominal barrier capacity is 3000 kJ the analysis was run at about 3000 kJ. Impact tests on a barrier model were simulated using a three-dimensional deformable body as the test block, with mechanical properties equal to those of high resistance concrete. The block's velocity was 25 m/s in the direction normal to the interception structure. The impact at the maximum energy level produced a non admissible deformation within a few elements in the longitudinal lower ropes. Therefore, the block's size was scaled down and further analyses were run up to a block size corresponding to an energy level equal to 2000 kJ. The response of the damaged barrier model yielded results comparable with the actual. The energy level at which this analysis was carried out is then taken as the actual maximum energy level and actual barrier capacity in case of a significant corrosion of the barrier cable.

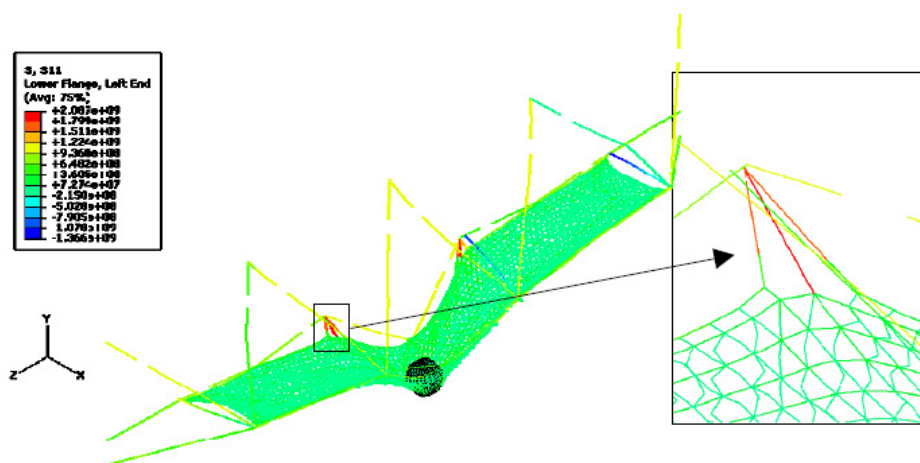


Figure 196: Main types - deformed shape of the damaged barrier (corrosion, case a) at the maximum nominal energy level (3000 kJ)

The modified model of barrier OM-CTR 30A (case b), made of three spans, was subjected to an impact at the maximum energy level. As the nominal barrier capacity is 3000 kJ the analysis was run at about 3000 kJ. Impact tests on a barrier model were simulated using a three-dimensional deformable body as the test block, with mechanical properties equal to those of high resistance concrete. The block's velocity was 25 m/s in the direction normal to the interception structure. The impact at the maximum energy level produced non-admissible stresses within a few elements in the interception structure. Therefore the block's size was scaled down and further analyses were run up to a value of size corresponding to an energy level equal to 1500 kJ. As illustrated in the table below, the response of the damaged barrier model is now comparable with the actual values. The energy level at which this analysis was carried out is then taken as the actual maximum energy level and actual barrier capacity in case of a significant corrosion of the barrier cable.

Quantity [unit]	Full-scale tests	FE model (nominal)	FE model (actual)
Energy [kJ]	3140	3140	2000
Braking time [s]	0.3	0.34	0.33
Maximum elongation [m]	5.35	5.30	4.92
Maximum force at the foundation [kN]	300	340	240
Maximum force at the uphill anchorages [kN]	250	350	130
Maximum force at the side anchorages [kN]	350	400	200
Residual height [m]	3.55	2.64	2.49

**Figure 197: Experimental and numerical nominal and actual (corrosion, case a)) response of the barrier during an impact at the maximum energy level.**

Quantity [unit]	Full-scale tests	FE model (nominal)	FE model (actual)
Energy [kJ]	3140	3140	1498
Braking time [s]	0.3	0.34	0.29
Maximum elongation [m]	5.35	5.30	4.61
Maximum force at the foundation [kN]	300	340	270
Maximum force at the uphill anchorages [kN]	250	350	260
Maximum force at the side anchorages [kN]	350	400	340
Residual height [m]	3.55	2.64	2.92

**Figure 198: Experimental and numerical nominal and actual (corrosion, case b)) response of the barrier during an impact at the maximum energy level**

### The effects of structural element failure

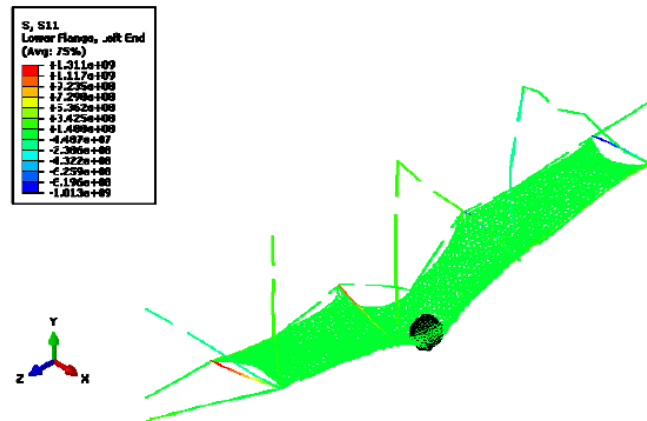
The effect of the failure of a structural element is investigated in this section with reference to two particular cases:

- a) Failure of an uphill anchorage. The relevant uphill cable is lost.
- b) Failure of a side anchorage. The relevant side cable is lost.

The modified model of barrier OM-CTR 30A (case a), made of three spans, was subjected to a retrospective simulation of the maximum energy full-scale test. As the nominal barrier capacity is 3000 kJ the analysis was run at about 3000 kJ. Impact tests on a barrier model were simulated using a three-dimensional deformable body as the test block, with mechanical properties equal to those of



high resistance concrete. The block's velocity was 25 m/s in the direction normal to the interception structure. The impact at the maximum energy level produced a value of maximum elongation higher than the reference and non-admissible deformations in some of the barrier elements.



**Figure 199: Deformed shape of the damaged barrier (failure case a) at the maximum nominal energy level (3000 kJ)**

Consequently the block's impact velocity was scaled down and further analyses were run up to a value of velocity corresponding to an energy level equal to 2500 kJ. The response of the damaged barrier model is now comparable with the actual values (see table below). The energy level at which this analysis was carried out is then taken as the actual maximum energy level and actual barrier capacity in case of a significant corrosion of the barrier cable. The modified model of barrier OM-CTR 30A (case b), made of three spans, was subjected to a retrospective simulation of the maximum energy full-scale test. As the nominal barrier capacity is 3000 kJ the analysis was run at about 3000 kJ. Impact tests on a barrier model were simulated using a three-dimensional deformable body as the test block, with mechanical properties equal to those of high resistance concrete. The block's velocity was 25 m/s in the direction normal to the interception structure. The impact at the maximum energy level produced a peak force at the foundation of the external post higher than the reference. Therefore the block's impact velocity was scaled down and further analyses were run. However no value of kinetic energy were found which sufficiently lowered the peak force at the foundation.

Quantity [unit]	Full-scale tests	FE model (nominal)	FE model (actual)
Energy [kJ]	3140	3140	2499
Braking time [s]	0.3	0.34	0.29
Maximum elongation [m]	5.35	5.30	4.88
Maximum force at the foundation [kN]	300	340	340
Maximum force at the uphill anchorages [kN]	250	350	250
Maximum force at the side anchorages [kN]	350	400	400
Residual height [m]	3.55	2.64	3

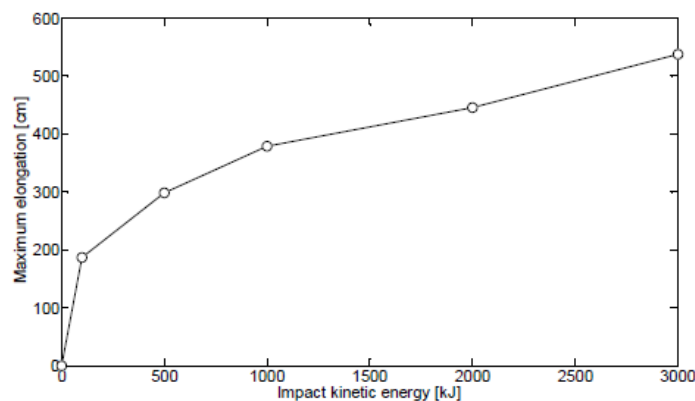
**Figure 200: Experimental and numerical nominal and actual (failure, case a)) response of the barrier during an impact at the maximum energy level**

### The effects of a deformed barrier shape

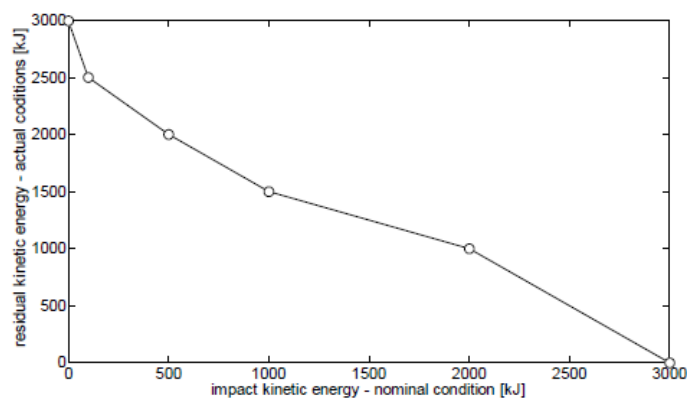
The effect of a deformed barrier shape is investigated in this section with reference to two particular cases:

- a) Barrier deformation caused by the impact of a single block of known kinetic energy (rock accumulation).
- b) Barrier deformation caused by the impact of a distributed mass of known impact velocity (mixed material accumulation).

In order to investigate case a) a set of numerical analyses were carried out on the OMCTR 30A barrier prototype. In particular, four identical and undamaged models of barrier OM-CTR 30A (hereafter called Model 1, 2, 3 and 4), each made of three spans, were subjected to central vertical impact tests. Model 1 was subjected to a test at the energy level of 100 kJ, Model 2, 500 kJ, Model 3, 1000 kJ and Model 4, 2000 kJ. At the end of each test the maximum elongation was measured and inserted in a graph which relates the impact energy and the elongation. Following this numerical testing programme the deformed Models 1-4 were subjected to a further impact to investigate the actual model capacity. For each of the models, the values of impact energy which produced a response close to the nominal and guaranteed the fulfilment of procedure requirements were recorded and inserted in a graph which relates the first launch energy to second launch energy providing an estimate of the residual kinetic energy or actual capacity. As a result, the barrier deformation can be related to the impacting block energy, which can in turn be related to the actual barrier capacity using the graphs below.



**Graph 1: Impact energy – maximum elongation relationship for an undamaged OM-CTR 30A barrier (single block)**



**Graph 2: Impact energy – actual impact energy relationship for a damaged OM-CTR 30A barrier (deformation case a) (single block)**

## Conclusion

These developments form the basis for a better understanding of the behaviour of protection works. Another key issue is the maintenance of installed protective facilities. Somebody has to be responsible for installed, possibly old, protective facilities that are no longer functional. In case of an event causing damage, the public institution has to take the responsibility. Therefore it is extremely important that maintenance work be carried out regularly and completely. This will be more difficult than expected, as in mountainous regions protective facility can easily be reached. Close collaboration with the road services is therefore essential.

After completion, the maintenance work recorded and incorporated in the relevant database. This makes it possible to keep an overview of the work carried out and money spent on maintenance.

Residual risk has been discussed extensively. From a general point of view it seems logical that despite all preventive measures a residual risk will always remain. This holds especially true for rockfall protective facilities along the road network. These facilities may partially or completely lose their efficiency and functionality after an impact or because of the failure to carry out maintenance work. This means that:

- A periodic checks/controls are absolutely necessary
- People should be made aware that protective facilities are only able to mitigate the risk, not to eliminate it!
- Based on this consideration and the fact that in some cases the appropriate technical systems for hazard mitigation do not exist, it is necessary to define a concept of residual - in many cases of acceptable - risk with a defined threshold.
- It will never be possible to protect every single road, from the biggest to the smallest. Also the available money will never be sufficient for all necessary investments. Therefore we should define an acceptable level of residual risk, explain it and sensitise the public to it. Everyone has to take the responsibility for his own actions to some extent. It is a matter of education and attitude to take personal responsibility, even if the trend goes in another direction.

## 8 Decision support systems for natural risk management: synthesis and perspectives for further developments

### Main results

#### Outputs and results of the project

From a general point of view, benefits gained by the PARAMount project in the domain of decision-facilitating methods are as follows:

- An increased risk awareness as well as awareness of costs resulting from disruptions of accessibility, resulting from risk dialogue activities, the description of decision contexts etc.;
- An improved regional knowledge of the actual risk situation along transportation axes through the development of multi-scale hazard and risk maps;
- A better understanding and knowledge of damage potentials in relation to scenarios descriptions.

The total output of the project<sup>5</sup> consists in:

- 5 hazard mapping tools implemented;
- 5 hazard early warning systems implemented;
- 4 Decision Support Systems adapted/implemented on the basis of pre-defined measure alternatives;
- 5 regional risk dialogue groups, bringing together all relevant actors as a prerequisite for a knowledge-based decision-making;
- Improved regional decision-making potential by better-educated staff;
- 5 approved regional action plans to mitigate hazard consequences available;
- Defined standard of safety, kept up on the transport routes on the basis of situation-specific action guidelines;
- 4 best-practice models and recommendations, ready to be implemented in comparable regions;
- Adequate argumentation for higher acceptance of risk-minimising measures (this can also be seen as a 'marketing strategy' for necessary measures);
- Improved regional and commercial image of beneficiaries.

---

<sup>5</sup> Including also the contributions from other work packages, see their reports and publications for details.



## Outputs and results of the project from a decision-facilitating perspective

From a more specific point of view, this synthesis describes the main findings of projects and possible improvements related to decision-facilitating systems. It can obviously be argued that any hazard/vulnerability assessment methods and any numerical modelling (such as the production of maps) can be considered as aids to decision-making. In Work Package n°7 of the PARAMOUNT project, we have tried to look at the problem of decision-making in a new light. Some issues have first been identified and new approaches have been explored. In the framework of the PARAMOUNT project, two kinds of tools have been proposed.

On the one hand, approaches such as hazard and risk assessment and the assessment of protection works effectiveness based on numerical modelling have been performed by the different partners. These techniques and methods are obviously valuable tools to help decision-makers and technicians to take decisions related to risk management: they correspond to the application of existing methods to the different national test beds. These applications have allowed the dissemination of technical and scientific knowledge throughout the different countries: as an example, regional approaches for avalanches and rockfalls have been widely applied and used by the different European partners. Through the calculation of vulnerability and exposure level of roads, many partners have moved from previous exclusively hazard-level-based approaches to risk level analysis. In many cases, several steps are still required. The risk management process remain very complex and some further developments are still expected after the conclusion of the PARAMOUNT project.

On the other hand, project partners have proposed some new interesting developments that can be summarised as follows:

- Implementation of existing methods for hazard assessment across wide geographical zones;
- Global risk awareness and communication improvement tools (e.g. BFW);
- Design of specific decision support systems such as information systems for road networks (e.g. Autonomous Province of Bolzano, University of Ljubljana, Slovenia) which have increased knowledge about the existing protection measures through specific surveys ;
- Advanced multi-criteria decision and analysis of network structural properties for road importance and criticality assessment ;
- Development of advanced decision support methods for multi-criteria decision-making including information imperfection management (Irstea);
- Innovative tools and methodologies to assess and consider information imperfection , including uncertainty, in the context of the decision process (Irstea).

All these methods are based on an integrated approach to risk management in mountain regions. Technical knowledge about phenomena is of course an essential step for effective risk management. At the same time, the experience of the PARAMOUNT project has shown that building specific decision-facilitating methods requires both the use of existing ad hoc methods and also the establishment of close collaboration relations with decision-makers. This risk dialogue, the capitalisation of knowledge from the stakeholders and infrastructure managers during the PARAMOUNT project, has led to an improvement in risk management. The decision-facilitating tools that have been developed are useful not only for the technicians but also for transport infrastructure administrations who are responsible for allocating money for new investments in an objective way and not on an arbitrary basis.

## **Perspectives**

When dealing, with natural risks management, it is not always easy to describe what a real decision-facilitating system. Are (classical) hazard and risk maps a part of decision-support systems or are they only pieces of information used in global decision processes? The PARAMount project has shown that describing real decision contexts and trying to develop specific decision support systems was not obvious even it remains a key question when the idea comes to develop a new decision-support system. A series of innovative tools and methods to assess the risk on transport infrastructures at the local level and take the imperfection of the available information into account have been proposed. Some prototypes have shown that promising applications of these techniques do exist.

### **Integration and consideration of information quality in the decision-facilitating methods and tools used for expert assessments**

In our opinion, there is still room for improvement in connection with decision-making methods and risk management methodologies in a research/development perspective (developing applied methodologies and research). The integrated approach is an important objective, but methodologies may not always appear totally objective. Some issues are sometimes undervalued (model validity, data availability, source reliability etc...) . As an example, we do know that in some cases our models are a rough simplification of reality, that probabilities cannot be assessed precisely, that estimations of losses are sometimes subjective and so on. In the end, no method can produce the real and unique truth. An analysis of the decision process and tools in relation with objective information quality assessment is still required: which method can be used in which cases ? how far can we be confident in results of expert based integrated risk assessment process.

### **Development of integrated approaches**

Integrated approaches, using different techniques and methods, are probably part of the solution of the problem (or at least a contribution to the solution). Some versatile decision support system using several techniques and sources still needs to be imagined. This could combine economic, classic and advanced multicriteria approaches with matrix-based approaches in specific application cases extending from well known cases to very uncertain situations. The application can relate to several decision contexts: roads, buildings, risk assessment, protection works effectiveness. This question of protection work effectiveness remains a key issue for infrastructure managers: the best protective measures are only able to mitigate the risk, not to prevent from it. In a context of reduced findings, new decision-facilitating methods are needed as a basis for making the right choices. Finally, the development done in the context of roads has also shown that indirect vulnerability, related to territorial approaches, is still difficult to assess. Territorial approaches are also probably needed in order to go further.

## To improve the capitalisation of knowledge

Information is the basis for decision. Effective information systems are required to support decision-making. To consider the effect of information quality on decisions, the traceability of information should be included in information systems in order to describe both existing links between information and its quality. Metadata are an effective way to link quality indexes to data and also to represent the genealogy of data making a difference between raw and processed information [Vidaud-Barral et al., 2010] [Tacnet, 2009]. Developments of new decision-facilitating systems have to integrate four different objectives<sup>6</sup> corresponding to the representation of information imperfection, integration and development of decision-facilitating methods, and the elicitation and capitalisation of data into information systems respectively (Figure 201).

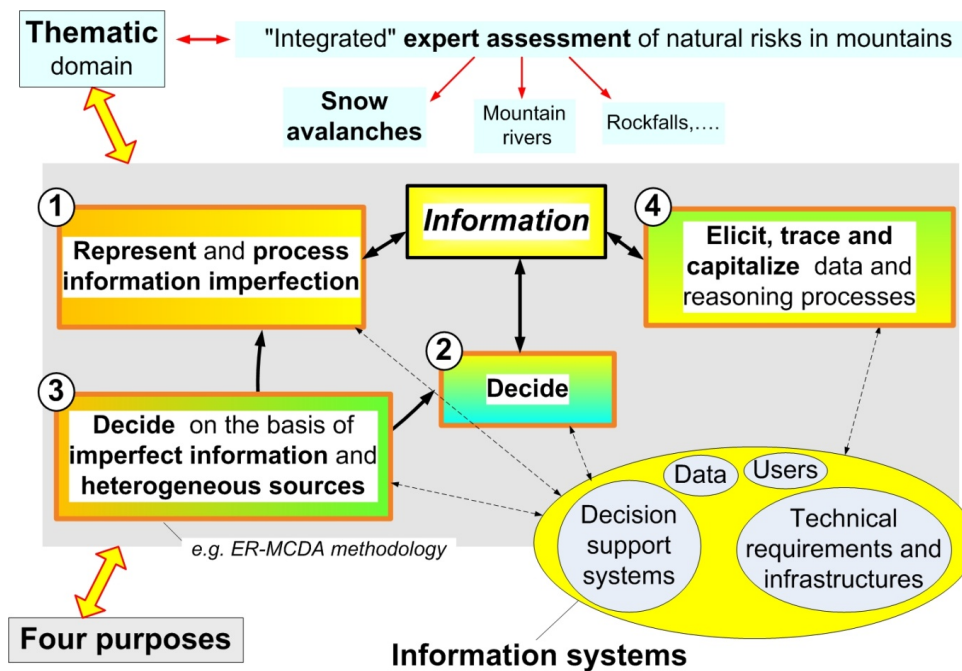


Figure 201 : Integration is necessary from decision support tools to information systems [Vidaud-Barral et al., 2010]

## To build new projects...

The consortium of partners and observers have now developed an effective network. Problems are now clearly stated, some of them have started to be solved. All the partners are sincerely grateful to the interReg Program and the European Commission for having helped them to achieve this contribution. As in any project, and especially in research/development activities, many issues and perspectives remain: there is still some place for others projects in the context of the InterReg programmes which would associate in an original way practioners, decision-makers and technical staff to improve the risk management process all over the Alpine Space.

<sup>6</sup> These objectives correspond to the strategic goals of the ADRET (**DARE** in English, meaning **D**ecision-Aiding based on imperfect information **RE**presentation and Treatment) research team of Irstea (inside the Rivage group).

## 9 References

Different references have been cited at the end of sections. This list corresponds to other additional references cited in the text (see also the list references of articles, posters and oral communications of the different PARAMount partners produced or used in connection with decision support for railway management on the project website <http://www.paramount-project.eu/> ).

[Baudrit, 2005] Baudrit, C. (2005). *Représentation et propagation de connaissances imprécises et incertaines : application à l'évaluation des risques liés aux sites et aux sols pollués - Thèse de doctorat*. PhD thesis, Université Toulouse III -U.F.R. Mathématiques Informatique Gestion, Toulouse.

[Baudrit et al., 2005] Baudrit, C., Guyonnet, D., and Dubois, D. (2005). Postprocessing the hybrid method for addressing uncertainty in risk assessments. *Journal of Environmental Engineering*, 131(12):1750–1754.

[CG73, 2011] CG73 (2011). Conseil général de la savoie - bilan des trafics et circulation hivernale de l'année 2010. Technical report, Conseil général de Savoie.

[Chojnacki et al., 2009] Chojnacki, E., Baccou, J., and Destercke, S. (2009). Numerical accuracy and efficiency in the propagation of epistemic and aleatory uncertainty. *International Journal of General Systems*, 0:1–23.

[Cuny, 2012] Cuny, V. (2012). Fini les crues, l'évitement de pontamafrey a vécu. *Ferrovissime*, 48:5–9.

[Curt et al., 2011] Curt, C., Talon, A., and Mauris, G. (2011). A dam assessment support system based on physical measurements, sensory evaluations and expert judgements. *Measurement*, 44:192–201.

[Dezert and Smarandache, 2006] Dezert, J. and Smarandache, F. (2006). *Advances and applications of DSMT for Information Fusion - Collected works - Volume 2*, chapter Proportional Conflict Redistribution Rules for Information Fusion. American Research Press, Rehoboth, USA.

[Dezert and Smarandache, 2009] Dezert, J. and Smarandache, F. (2009). *Advances and applications of DSMT for Information Fusion - Collected works - Volume 3*, chapter 1 : An introduction to DSMT, page 760. American Research Press, Rehoboth, USA.

[Dezert and Tacnet, 2012] Dezert, J. and Tacnet, J.-M. (2012). Soft electre tri outranking method based on belief functions. In *15 th International Conference on Information Fusion Proceedings, 9-12 July 2012*, pages 607–614, Singapore.

[Dubois et al., 2000] Dubois, D., NGuyen, H., and Prade, H. (2000). *Fundamental of Fuzzy Sets*, chapter Possibility theory, probability and fuzzy sets : Misunderstandings, bridges and gaps, pages 343–438. The Handbook of Fuzzy Sets Series. Kluwer Academic Publishers, Boston, Massachussets, USA.

[Dubois and Prade, 1988] Dubois, D. and Prade, H. (1988). *Possibility Theory : An approach to Computerized Processing of Uncertainty*. Plenum Press, New York (U.S.A).

[Dupouy, 2010] Dupouy, G. (2010). Risques naturels et simulation numérique. etude d'incertitude et de sensibilité par des approches hybrides : application au cas des crues torrentielles. Master's thesis, Université Paul Verlaine, Metz, France.

[Dupouy et al., 2012] Dupouy, G., Tacnet, J.-M., Laigle, D., and Chojnacki, E. (2012). Uncertainty in natural hazards numerical modelling: application of an hybrid approach to debri-flows simulation. In



*Proceedings of the 12th international conference Interpraevent, 23-27 april 2011, Grenoble, France, pages 95–106, Grenoble, France.*

[Dyer, 2005] Dyer, J. (2005). *Multiple Criteria Decision Analysis : State of the Art Surveys*, chapter Maut - Multiattribute Utility theory. International Series in Operations Research and Management Science. Springer, New-York.

[Figueira et al., 2005] Figueira, J., Mousseau, V., and Roy, B. (2005). *Multiple Criteria Decision Analysis : State of the Art Surveys*, chapter Electre methods, pages 133–162. International Series in Operations Research and Management Science. Springer, New-York.

[INSEE, 2011] INSEE (2011). Nomenclatures statistiques françaises des domaines économique et sociale et définition des concepts dans les enquêtes et études de l'insee.

[Keeney and Raiffa, 1976] Keeney, R. and Raiffa, H. (1976). *Decisions with multiple objectives; preferences ans values trade-offs*. J.Wiley and Sons, New York.

[Laigle et al., 2003] Laigle, D., Hector, A. F., Hübl, J., and Rickenmann, D. (2003). Comparison of numerical simulation of muddy debris flow spreading to record of real events. *International Conference on Debris-Flow Hazards Mitigation: Mechanics, Prediction, and Assessment, Proceedings*, pages 635–646.

[Magne and Vasseur, 2006] Magne, L. and Vasseur, D. (2006). *Risques industriels. complexité, incertitude et décision : une approche interdisciplinaire*, chapter 9 : le risque et sa gestion entre incertitude et ajustement de règles. Collection EDF R&D. Lavoisier, Paris.

[Maneerat, 2012] Maneerat, S. (2012). Evaluation de la vulnérabilité et de l'accessibilité des réseaux exposés aux risques naturels gravitaires rapides en montagne, rapport de master 2 sigat ( systèmes d'information géographique et aménagement du territoire). Master's thesis, Cemagref, Université de Haute-Bretagne, Rennes 2, France.

[MEEDDAT, 2008] MEEDDAT (2008). *Arrêté du 12 juin 2008 définissant le plan de l'étude de dangers des barrages et des digues et en précisant le contenu (J.O. du 19 juin 2008)*. Journal Officiel de la République Française.

[Mermet and Ruas, 2010] Mermet, E. and Ruas, A. (2010). Geographlab: a tool for exploring structural characteristics of transportation network. In *13th International Conference on Geographic Information Science (AGILE' 10) proceedings, 10-14 May*, Guimareas, Portugal.

[Mortureux, 2001] Mortureux, Y. (2001). *Techniques de l'Ingénieur -Traité 'L'entreprise industrielle'*, chapter La sûreté de fonctionnement : méthodes pour maîtriser les risques - Ref. AG 4 670 - 17 p., pages 1–17.

[Perilhon, 2007] Perilhon, P. (2007). *La gestion des risques - Méthode MADS/MOSAR II - manuel de mise en oeuvre*. Demos, Paris, France.

[Peyras, 2003] Peyras, L. (2003). *Diagnostic et analyse de risques liés au vieillissement des barrages - Développement de méthodes d'aide à l'expertise - Thèse de doctorat*. PhD thesis, Université Blaise Pascal - Clermont 2.

[Rapin et al., 2006] Rapin, F., Belanger, L., Hurand, A., and Bernard, J.-M. (2006). Sensitive avalanche paths : using a new method for inventory and classification of risk. In *International Snow Science Workshop Proceedings (ISSW) 2006 - september 30 to october 6*, Telluride - Colorado -Etats-unis -.

[Saaty, 1980] Saaty, T. (1980). *The analytic hierarchy process*. McGraw Hill, New York.

- [Schärlig, 1985] Schärlig, A. (1985). *Décider sur plusieurs critères - Panorama de l'aide à la décision multicritère*. Diriger l'entreprise. Presses polytechniques et universitaires romandes, Lausanne, 3<sup>ème</sup> édition.
- [Shafer, 1976] Shafer, G. (1976). *A mathematical theory of Evidence*. Princeton University Press.
- [Tacnet, 2009] Tacnet, J.-M. (2009). *Prise en compte de l'incertitude dans l'expertise des risques naturels en montagne par analyse multicritères et fusion d'information*. Thèse de doctorat en sciences et génie de l'environnement, Ecole Nationale Supérieure des Mines, Saint-Etienne, France.
- [Tacnet et al., 2009] Tacnet, J.-M., Batton-Hubert, M., and Dezert, J. (2009). *Advances and applications of DSMT for Information Fusion - Collected works - Volume 3 - <http://fs.gallup.unm.edu//DSMT.htm>*, chapter Information fusion for natural hazards in mountains, pages 565–659. American Research Press, Rehoboth, USA.
- [Tacnet et al., 2010a] Tacnet, J.-M., Batton-Hubert, M., and Dezert, J. (2010a). A two-step fusion process for multi-criteria decision applied to natural hazards in mountains. In *Belief 2010, Proceedings of International Workshop on the Theory of Belief Functions, Brest (France), 1-2 april 2010*.
- [Tacnet et al., 2010b] Tacnet, J.-M., Batton-Hubert, M., Dezert, J., and Richard, D. (2010b). Applying new uncertainty related theories and multicriteria decision analysis methods to snow avalanche risk management. In *ISSW 2010, Proceedings of International Snow Science Workshop, Squaw Valley, Colorado, USA, 17-22 october 2010*.
- [Tacnet et al., 2012a] Tacnet, J.-M., Curt, C., Rey, B., and Richard, D. (2012a). Efficiency assessment for torrent protection works: an approach based on safety and reliability analysis. In *Proceedings of the 12th international conference Interpraevent, 23-27 april 2011, Grenoble, France*, pages 821–831, Grenoble, France.
- [Tacnet et al., 2011a] Tacnet, J.-M., Curt, C., Richard, D., and Rey, B. (2011a). Efficacité des ouvrages de correction torrentielle : indicateurs basés sur la sûreté de fonctionnement. *Annales du Bâtiment et des Travaux Publics*, 4-5, août-septembre 2011:78–86.
- [Tacnet and Dezert, 2011] Tacnet, J.-M. and Dezert, J. (2011). Cautious owa and evidential reasoning for decision under uncertainty. In *14th International Conference on Information Fusion Proceedings, 5-8 July 2011*, pages 2074–2081, Chicago, Illinois, USA.
- [Tacnet and Dezert, 2012] Tacnet, J.-M. and Dezert, J. (2012). *Decision Support Systems - Collaborative Models and Approaches in Real Environments*, volume 121 of *Lecture Notes in Business Information Processing*, chapter New Belief Function Based Methods for Multi-Criteria Decision-Making, pages 103–120. Springer, Heidelberg, New-York, Dordrecht, London.
- [Tacnet et al., 2011b] Tacnet, J.-M., Dezert, J., and Batton-Hubert, M. (2011b). Ahp and uncertainty theories for decision making using the er-mcda methodology. In *ISAHP 2011, Proceedings of the International Symposium on Analytic Hierarchy/Network Process, Sorrento (Italy), 15-18 june 2011*.
- [Tacnet et al., 2012b] Tacnet, J.-M., Kaiber da Silva, J., Dupouy, G., Laigle, D., and Chojnacki, E. (2012b). Uncertainty assessment and integrated approach for risk management in mountains: application to debris-flows. In *Proceedings of 18th Lambda Mu conference, 15-18 october 2012, Tours, France*.
- [Tacnet et al., 2012c] Tacnet, J.-M., Mermet, E., and Maneerat, S. (2012c). Analysis of road networks exposed to natural hazards. In *Proceedings of AGILE'2012, 15 th international conference on geographic information science proceedings, April 24-27, 2012, Avignon, France*, pages 370–375.
- [Tacnet et al., 2010c] Tacnet, J.-M., November, V., Richard, D., and Batton-Hubert, M. (2010c). Expertise, décision et incertitude : jusqu'où une approche interdisciplinaire est-elle possible dans le

cadre de la gestion intégrée des risques naturels en montagne. In *Colloque OPDE 2010, 'Aide à la décision et gouvernance', 25-26 octobre, Montpellier, France.*

[Tacnet and Richard, 2010] Tacnet, J.-M. and Richard, D. (2010). De la conception à la sûreté des barrages de correction torrentielle - <http://www.set-revue.fr/de-la-conception-la-surete-des-barrages-de-correction-torrentielle>. *Sciences, Eaux et Territoires*, 2(2):164–175.

[Tacnet et al., 2010d] Tacnet, J.-M., Richard, D., Batton-Hubert, M., and Dezert, J. (2010d). Aide à la décision et fusion d'information pour l'expertise des risques naturels : analyse de l'efficacité des ouvrages de protection. In *Actes de JFMS' 2010 (6 èmes journées de fiabilité des matériaux et des structures)*, Toulouse, France, 25-26 mars 2010., Toulouse.

[Tacnet et al., 2010e] Tacnet, J.-M., Rosalie, M., Dezert, J., and Travaglini, E. (2010e). Spatial information fusion: application to expertise and management of natural risks in mountains. In *SAGEO 2010, International Conference on Spatial Analysis and GEOmatics, Toulouse (France), 17-19 november 2010*, pages 408–412.

[Vidaud-Barral et al., 2010] Vidaud-Barral, L., Tacnet, J.-M., Deschâtres, M., Bonnefoy, M., and Richard, D. (2010). Improving the interoperability and user-friendliness of the french snow avalanche information systems. In *ISSW 2010, Proceedings of International Snow Science Workshop, Squaw Valley, Colorado, USA, 17-22 october 2010*.

[Zadeh, 1965] Zadeh, L. (1965). Fuzzy sets. *Information and Control*, 8:338–353.

[Zadeh, 1978] Zadeh, L. A. (1978). Fuzzy sets as a basis for a theory of possibility. *Fuzzy Sets and Systems*, 1:3–28.

## Talks and posters produced

[Tacnet, 2011] Tacnet, J.-M., 2011. *Information, Decisions and experts: the case of natural hazards in mountains*, Keynote talk (invited conference), Slides presented during the Mid-term conference of PARAmount and Monitor II projects, 8th June 2011, Bolzano, Italy, 19 p.

Tacnet, J.-M., Laigle, D., Bertrand, M., Liebault, F., Berger, F., Mermet, E., Chojnacki, E., Dupouy, G., Maneerat, S., Kaiber da Silva, J., 2012. Gérer et protéger les routes exposées aux risques naturels en montagne (poster) Assises Nationales sur les Risques Naturels, 19-21 janvier 2012, Bordeaux, France.

Tacnet, J.-M., Curt, C., Richard, D., Eichenbaum-Voline, R., Boncompain, I., 2012. Analyser l'efficacité des ouvrages de protection contre les risques torrentiels (poster), Assises Nationales sur les Risques Naturels, 19-21 janvier 2012, Bordeaux, France.

## 10 Appendix

### 10.1 Discussion guidelines for DSS evaluation: a framework for decision context identification

*This section has been written and verified by Jean-Marc Tacnet (Irstea, Snow avalanche engineering and Torrent Control Research Unit, Grenoble, France).*

Describing the decision context is an essential step before developing any decision support system. Such an approach has been proposed in the very preliminary steps of the PARAMount project through discussions with the different observers. This section shows how this question was assessed in a very preliminary stage of the process.



*Avalanche Engineering and torrent control research unit*

*Mountain ecosystems research unit*



### **Paramount project**

**ImPROved Accessibility : Reliability and safety of Alpine transport infrastructure related to MOUNTainous hazards in a changing climate**

**WP7: Decision support for infrastructure protection**

**Actions 7.1 and 7.2**

**Guidelines for decision context and support systems elicitation**

**Version 0.5 february 2010**

Jean-Marc Tacnet (coord.)\* in collaboration with D. Laigle\*, D. Richard, F. Liebault\*, F. Berger\*, F. Bourrier

\* Cemagref – 2, rue de la papèterie B.P. 76 38402 SAINT-MARTIN D'HERES Cedex - FRANCE



## Objectives

The main goal of PARAMount is to improve accessibility in terms of the reliability, safety and cost efficiency of transport infrastructure in relation to natural hazards in a changing climate. Operational goals are to:

- ⇒ increase infrastructure relevance of hazard process analyses;
- ⇒ improve knowledge about hazard-specific impacts on transport infrastructure;
- ⇒ extend risk assessment to infrastructure lines outside of populated areas;
- ⇒ improve coverage of hazard maps relevant to transport infrastructure;
- ⇒ improve knowledge about regional damage potential;
- ⇒ improve knowledge transfer and risk awareness;
- ⇒ establish a risk dialogue with relevant actors: bring together experts from the field of transportation and natural hazard management.

This document has been introduced in the following actions of WP4 :

- ⇒ 4.4: Analysis of regional risk management tools/systems/methods and application to transport infrastructure protection ;
- ⇒ 4.5: Analysis of existing decision support systems in the transport sector.

It has also prepared some developments related to WP7 :

- ⇒ 7.1: Development of risk dialogue ;
- ⇒ 7.2: Adaptation and development of decision support systems.

The main purpose of this note was to propose some preliminary questions to decision-makers and infrastructure managers in order to determine what are the main decisions that they have to take, what are their main needs, the existing tools that they use and so on.

- ⇒ How are transport infrastructures considered in the global risk management framework? Does it refer to a regulatory framework?
- ⇒ Who is responsible for taking natural hazards into account in relation to transport infrastructures? Who decides?
- ⇒ What kinds of decision are taken (investment priorities, protection types, road closures, warnings)?
- ⇒ In what conditions are these decisions taken (prevention, crisis)?
- ⇒ Are these decisions mainly hazard-based or risk-based (e.g. comparing high hazard situation, low frequency with a low hazard situation, high frequency ...)
- ⇒ How are different levels of severity assessed?
- ⇒ What methods and decision supports are used (GIS<sup>7</sup> based systems, multi-criteria decision support systems, economic and cost/benefit approaches, empirical evaluation arrays...)? Are these methods shared or used by other partners?
- ⇒ Are they mandatory in your country? Does it remain possible to use other methods or not?
- ⇒ Where do these methods come from? Do you develop your own methods or do you use existing methods? Have they been validated? How has this validation been assessed?
- ⇒ Where does the information used for decision come from? Is it certain? reliable? precise? How are reliability and accuracy evaluated?
- ⇒ Does the level of information reliability and accuracy modify the decision?

---

<sup>7</sup> Geographical Information Systems.

These questions are purely indicative and may sound obvious. In many cases, we observed that decision-makers are not always able to provide a formal and clear description of their decision process.

The main questions about relations between railway infrastructures and decisions can be summarised as follows:

**What about decisions and transport infrastructures?**

**A 5WH approach**

**Who** (decides)? **What** (is decided)? **Why? When? Where? How?** (is it decided)

## CONTEXT

### Natural phenomena

#### **What?**

Examples of phenomena reaching or damaging transport infrastructures: rockfalls, avalanches, debris flows...

What are the main and more important (negative) consequences of these phenomena for you?

In a global management framework, do you use any kind of rating of these phenomena? Is this rating rather implicit or can you express it clearly?

What are the main criteria you use to categorise and prioritise the phenomena in relation to one another (severity, intensity, damage, opportunities of issuing alerts and warnings...)?

How do you evaluate the natural hazards in comparison with all the others classical risks related to transport infrastructures?

### Organisations

#### **Who/Why?**

Organisation : where do you work (private companies, road network managers)?

Why is your organisation involved in decisions related to railway infrastructures?

## Transport infrastructures at risk? What is exposed?

### What/Where?

How do natural hazards threaten the transport infrastructure? What are the effects, the consequences?

How many kms of roads are threatened in your area?

What is the annual cost due to natural hazards?

What are the main risks related to transport infrastructures?:

- human lives ( people in cars, railways)
- material assets: cars, railways, infrastructures (bridges)
- environment (dangerous and polluting products,e.g. pollution caused by an accident)
- effects on the economy (access interruption)

Do you prioritise these different kinds of risks? Are there admissible thresholds for each category?

## Existing regulatory framework

### Why/How?

What is the administrative, regulatory context?

What decisions have to be made? according to what rules?

Do you share your decisions with others organisations (e.g. civil defence)?

## Natural hazard assessment vs. railway infrastructures

Do you consider any difference between natural hazards when making decisions related to railway infrastructures : rockfalls, avalanches, debris flows?

- What are the common points?
- what are the main characteristics and difficulties encountered?

Do you have a GIS mixing natural hazards and infrastructures? ( linear or crossed sections)?

How do you assess natural hazards (existing , historical information)? Where does information come from? from your own survey or do you use existing data provided or collected by others...

How do you proceed to collect information related to transport infrastructure and natural hazards?

## DECISION

### What is decided?

#### What?

What kind of decisions have you already taken? What kind of decisions should you take (decisions that are not fully satisfactory for you)?

What are the different scales for your decisions (local, regional, national)?

What are the solutions? alternatives? How are they compared, ranked? (e.g. sites, risk management, rescue scenarios, warnings...)

How and when do you decide to make specific studies?

### Road or infrastructure related decisions

#### What?

What are the decisions related to railway infrastructure management (linked with natural hazards)?

- road protection (priorities of investment, maintenance, choice, ranking of type and location of protective facilities)
- road closure (where, when, how long) e.g. when is the Frejus tunnel closed?
- road maintenance
- user alerts.

### Decision failure situations

#### What?

Have you experienced situations where decisions were specially difficult to make?

What are the criteria that could affect the confidence level of each of your decisions?

### Who decides?

#### Who?

Who are the stakeholders?

Do you share your decisions with other organisations? Do you consider that your decisions have the same 'weight' in the global decision process?



Can you make a difference between technical and/or political decisions (in the project, we focus on technical points)?

## **When is it decided?**

### **When?**

When do you have to make a decision? Are you alone to decide? who else cares about your decision?  
How quickly do you have to make your decision?

## **Prevention: before crisis**

How are natural hazards taken into account through roads or infrastructures design methods?

How are protection works prioritised?

What kind of monitoring do you use? Does it cover all your territory?

## **During crisis**

When does an alert occur? who is responsible for issuing the warning?

## **Danger situations and scenarios**

What are the most dangerous situations for infrastructure management?

Are these situations pre-analysed? Do you refer to pre-described scenarios?

Do you make a difference between phenomena (rockfalls vs. debris flows) affecting these roads?

## **Where is it decided?**

### **Where?**

Where are the most dangerous areas?

Where should we plan more detailed studies?

Where are the zones where we are lacking information as a basis for decision?

Where are the most important roads?

Where are the most important protection works?

Where should invest first to enhance or at least maintain the protection level?

Can you make a difference between technical and/or political decisions (in the project, we focus on technical points)?

## **How is it decided?**

## Basis of decision

### How?

What are the main criteria used for decision? economic value, responsibility ...

Are the economic aspects taken into account? Do they concern monetary losses due to the interruption of exploitation activities, delayed trains (direct effects) or indirect effects (suspended activity...)

In case of cost-benefit-related approaches, how are the economic values of people and/or material assets at risk are calculated?

In case of protection works, how is the efficiency of protection works considered? What is the risk reduction level?

Are the indirect effects considered in the global decision process (e.g. high deposition level in sedimentation basin vs. increased scouring in the lower part of the river)?

## Existing frameworks

### How?

Have you some global principles (e.g. mountain roads will not be protected)?

## Group vs. individual decisions

Do your decisions result from your own analysis or from a group decision process?

How do you cope with conflicting positions between decision-makers (compromise, unequal relative importance of decision-makers)?

Do you act differently in cases where a decision would result either from a compromise or a set of contradicting positions?

## Criteria for decision

### How?

What is important for you? What criteria do you consider to make your decision?

Do you think that some criteria are more important than others?

How would you assess the relative importance of a criterion in comparison with others?

## Decision back-analysis

## How?

Do you back-analyse your decisions after they have been taken (in order to improve them or the decision process)?

Do you share your experience or analysis with other members of your organisation?

Is this analysis collocated in any quality plans?

## Relation between information and decision

### How?

What kind of available information do you use to make your decision?

Where does the information come from? what are the sources?

Do you consider this information as sufficient?

Is this information reliable? certain?

How far is the information reliability evaluated?

Do you produce your own analysis or data for decision purpose?

Do you use any existing geographic information dealing with natural hazards? Which one?

## Methods and tools for decision-making

### How?

What does a decision support system consist in for you?

What could help you to form a decision?

What is an efficient decision support tool for you?

## Typology of used methods and existing Decision Support Systems (DSS)

### How?

What kind of methods do you use? :

- GIS-based methods (simple maps)
- Safety and reliability based methods : are FMEA (Failure Mode Effects Analysis) used in relation to natural hazards?

- Multi-criteria decision analysis methods (GIS-based or not)? Which one?
- Decision theory based methods (optimisation)
- Cost-benefit approaches: comparison of protection works and risk reduction.

Have you made cross-comparisons between these methods?

## Design process of decision support systems

### How?

Can you describe the decision process?

How is the decision process described?

Does it refer to an existing predefined framework?

How are the decision-making tools (decision support systems) developed?

Are your decision support systems freely available (can everybody can use your tools)?

## Validation process of decision support systems (DSS)

### How?

Are the validation cases clearly elicited?

Have you any experience with the comparison of different decision-support systems?

Have you any feedback about the practical usefulness of existing decision support systems? What are their main advantages or disadvantages?

## Implementation

### How?

What databases are used?

Do these databases have public access?

Where do the data come from? How is their reliability defined?

## Examples

Description of effective decision situations (related to natural hazard management, focusing on debris flows, rockfalls and avalanches) would be a useful added value. This description could consist in:

- Location, size of geographical area of decision (maps) ;
- Date, nature of decision, timetable, duration ;
- Steps leading to a decision
- Criteria used ...
- Back-analysis ...



## 10.2 Numerical modelling in the decision process: examples of qualitative evaluation of model results

Numerical modelling is nowadays an important tool to help engineers, infrastructure managers and public bodies to decide about hazard levels related to natural phenomena. Different models have been used to assess rockfall hazards in the national test beds. The two following sections present qualitative feedback corresponding to some practical use of software. This information, of course, does not amount to a full and extensive analysis of the model hypothesis, the calibration process etc. The comments and feedback from partners show that uncertainty and sensitivity analysis as presented in the previous sections remain essential for risk assessment and should be performed in a systematic way [Dupouy et al., 2012] .

### Feed-back from the Geological Service of Bolzano Province, Italy

The table is filled according to the qualitative (and subjective) scale : -- very bad, - bad, = equal, + good, ++ very good. These criteria can be used in a multi-criteria decision tool as proposed in the previous sections.

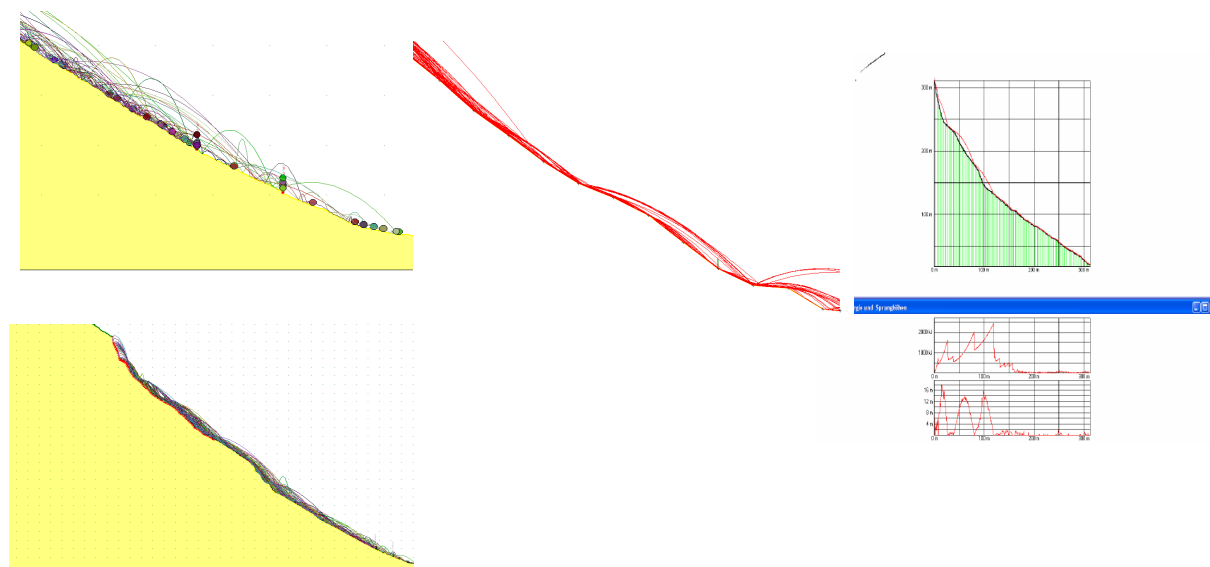
	Rotomap	RockyFor3D	RocFall	Georock2D	Rockfall (Dr. Spang)
Realistic results	-	++	+	+	+
Results comparable to field observations	--	++	=	+	+
Evaluation of forest protective role	-	=	-	-	-
Possibility of back analysis	--	--	++	+	=
Complexity of taking barriers into account	=	+	+	++	+
Complexity of input data process	-	=	++	+	-
Applicability parameters default	-	-	=	=	-
Experience with the software required	--	=	=	=	-
Preparation base data	+	=	+	=	=
Outputs (which diagrams...)	+	+	=	+	+

**Figure 202 : Qualitative comparison table of rockfall propagation software (proposed by PP3 – Serv. Geol. Bolzano)**

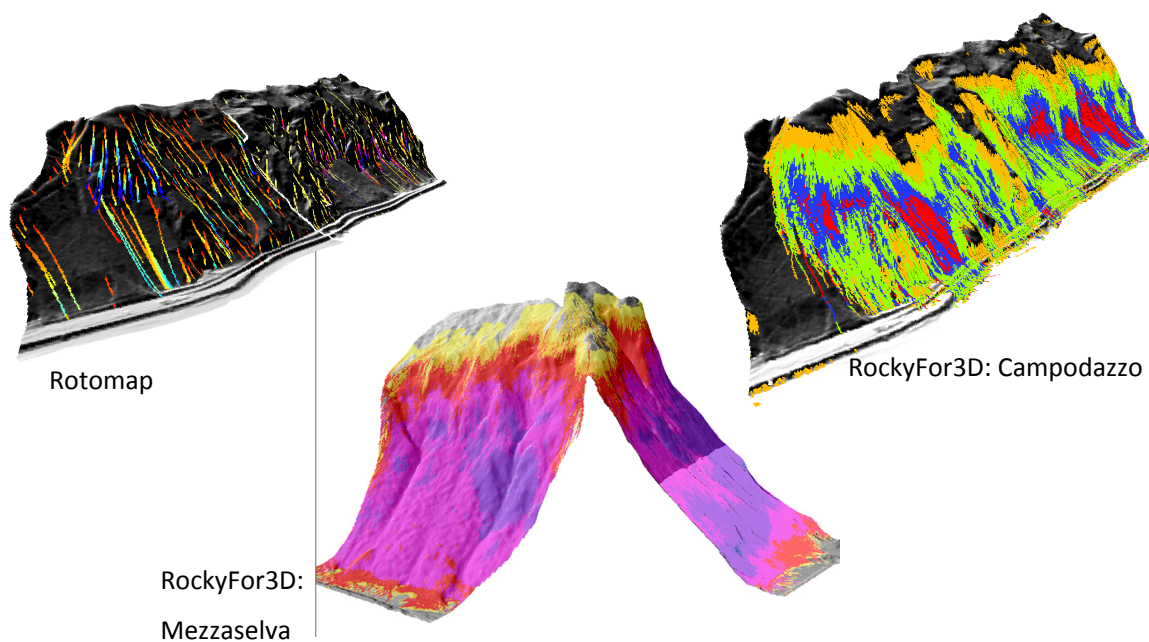
The feeling of the Geological Service of Bolzano Province is as follows:

*'The choice of the best rockfall software is not that simple. For hazard zone mapping, 3D software can be very helpful, because the hazard zones can easily be delimited according to a spatial distribution of energies. Nevertheless, a verification with 2D software can pinpoint in a more detailed way the given situation.*

*To plan new investments for protection measures, 2D software is more convincing with a view to obtaining an exact measure of energy on a certain hazard zone. But after having defined the energy, length and height of the protection measure, a verification in a 3D software, e. g. RockyFor3D is definitely useful.'*



**Figure 203 : Test of 2D rockfall simulation software (Serv. Geol. Bolzano)**



**Figure 204 : Test of 3D rockfall simulation software - examples of graphical results (Serv. Geol. Bolzano)**

## Feed-back from Slovenian partners of the project

For **rockfall hazard assessment** in the Slovenian test bed (Posočje, Baška grapa), two modelling tools were used: RockyFor3D and Rockfall (Dr. Spang). The comparison of both models is presented in the table below :

	RockyFor3D	Rockfall (Dr. Spang)
Strengths	The software provides a good overview of the spatial extension of rockfall hazards (good possibilities of different method of visualisation). Possibility of taking the effects of trees and forest stands into account. It allows the calculation of a large area, if detailed field data are available.	A statistical calculation of energies and jump heights is possible. Positive response from expert designer / practitioner regarding dimensioning.
Weaknesses	Back analysis with 2D rockfall models gives only an estimation of what happened. The quality of input data from field investigation very much depends on expert experiences – quite big differences are possible between different users (subjectivity).	A lot of experience is needed to define the specific soil values. Only a range is given by the software.
Opportunities	The function of protection forest can be calculated as help for the forest management teams regarding silviculture works. The results can be imported into a GIS.	Software could be even more user-friendly, especially regarding preparation of input data and possibility of saving different repeat experiments on the same spot.
Threats	Results have to be properly checked in the field, because of quite frequent defects of DEM input data – this applies to all 3D programs.	Results should be checked for speed of falling rocks – this is very sensitive and highly dependent on the characteristics of the soil.

**Table 8: Comparison of two rockfall modelling tools**

Feedback of the Slovenian team is given as follows

*'For **debris flow hazard assessment** (Koroška Bela test bed), the commercial numerical modelling tool Flo2D was used. Flo2D model is a user-friendly certified model for mass movement modelling. The interface of the model is schematic, input data required for modelling is well defined. User can set all control parameters of the model. Most important input data when modelling debris flow movement are topographic data (DEM) and magnitude of the event. With LiDAR technology we can solve the problem of data accuracy, but defining magnitude of the event remains a problem. Additional methods for magnitude (event scenario) assessment must be applied. Hydrological model in Flo-2D cannot be used for debris flow magnitude assessment. Flo 2D is suitable for modelling of the moving phase of the event and for hazard mapping. Surprisingly, Flo 2D has shown a small sensitivity*

*for rheological parameters of the debris flow. With defined magnitude, Flo 2D is a useful tool with schematic interface and tools for hazard mapping. User can define borders of hazard classes and model regarding modelling results hazard map is defined. Past research and model applications have shown that Flo 2D is an appropriate model for hazard assessment, but requires specific knowledge and experience with modelling.*

*The use of numerical models is already a must today for state-of-the-art hazard assessments. Therefore knowledge regarding several available modelling approaches is a prerequisite for the selection of the modelling approach, which will generate results of high accuracy on the basis of the data availability and the overall conditions in the problem at hand. Therefore such model evaluations offer valuable insights and in the long run lead to better hazard evaluations concerning the dangers of rockfall, avalanches and debris flows.'*