



**HAL**  
open science

## Energy efficiency of a LED lighting system using a Peltier module thermal converter

Ahlem Ben Halima, Zouhour Araoud, Laurent Canale, Kamel Charrada,  
Georges Zissis

► **To cite this version:**

Ahlem Ben Halima, Zouhour Araoud, Laurent Canale, Kamel Charrada, Georges Zissis. Energy efficiency of a LED lighting system using a Peltier module thermal converter. *Case Studies in Thermal Engineering*, 2022, 34, pp.101989. 10.1016/j.csite.2022.101989 . hal-03635536

**HAL Id: hal-03635536**

**<https://hal.science/hal-03635536>**

Submitted on 20 Jun 2023

**HAL** is a multi-disciplinary open access archive for the deposit and dissemination of scientific research documents, whether they are published or not. The documents may come from teaching and research institutions in France or abroad, or from public or private research centers.

L'archive ouverte pluridisciplinaire **HAL**, est destinée au dépôt et à la diffusion de documents scientifiques de niveau recherche, publiés ou non, émanant des établissements d'enseignement et de recherche français ou étrangers, des laboratoires publics ou privés.



Distributed under a Creative Commons Attribution - NonCommercial - NoDerivatives 4.0 International License

Contents lists available at [ScienceDirect](https://www.sciencedirect.com)

## Case Studies in Thermal Engineering

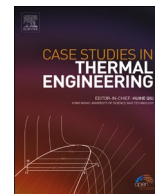
journal homepage: [www.elsevier.com/locate/csite](http://www.elsevier.com/locate/csite)

# Energy efficiency of a LED lighting system using a Peltier module thermal converter

Ahlem Ben Halima<sup>a,\*</sup>, Zouhour Araoud<sup>a</sup>, Laurent Canale<sup>b</sup>, Kamel Charrada<sup>a</sup>, Georges Zissis<sup>b</sup>

<sup>a</sup> Laboratory of Ionized and Reactive Media (EMIR), Monastir, Tunisia

<sup>b</sup> Laboratory of Plasma and Energy Conversion (LAPLACE), Université de Toulouse, CNRS, INPT, UPS, Toulouse, France

## ARTICLE INFO

## Keywords:

High power LED  
Peltier module  
Thermal behavior  
Energy efficiency

## ABSTRACT

With LED lighting systems, 70% of the energy consumed is lost in thermal form. It would be possible to increase the efficiency of the system by converting this wasted thermal energy into light. Some proposals using Peltier modules have been made. This article is interested in the limits of these solutions by evaluating the drop in the luminous efficiency of the LED system induced by the thermal effects generated by the addition of the Peltier module compared to the potential gain in terms of electrical power produced.

## 1. Introduction

Thanks to its energy efficiency and long lifespan, LED lighting has established itself globally in the space of a decade. Its energy frugality contributes to a general desire to reduce energy consumption and environmental impact [1,2].

Despite its many advantages (high energy efficiency, light, powered at low voltage, reliable, robust, etc.), it presents nearly 70% of energy losses, only in the form of heat, which is still excellent compared to -vis other light sources such as, for example, the incandescent lamp for example with 97% of energy lost in the form of infrared radiation and thermal losses [3–5].

High Power Light Emitting Diodes (H-P LEDs) are powered at 1W or more in a single LED chip.

Most of the energy of an LED is converted into heat (only losses because an LED does not emit infra-red or ultra-violet) rather than light.

To ensure good overall performance, the key component of the system is the heat sink. Indeed, an LED chip having a theoretical power consumption of 1w, a small part of this power (up to 30% for a very good white LED) is converted into light, the rest is heat. The excess heat must therefore be evacuated to the outside by conduction then convection, which requires a heat sink [6,7].

Temperature has other negative effects: LED color drifts with temperature and over 50% of premature LED failures are related to poor thermal management. Indeed, the fluorescence performance of the phosphor decreases with heat because the blue emitter shifts towards shorter wave lengths and therefore the contribution of phosphorus (white light) in the spectrum decreases. Thus, the thermal management of the system is the key to quality and reliability [8]. In addition, if this heat cannot be dissipated, the LED will light up at very high temperatures. This not only decreases the efficiency but also the lifespan of the LED. For example, if the junction temperature increases by 10 °C, the power increases, the lifespan of the LED decreases and even the quality of the light decreases. Therefore, the LED junction temperature must be kept below 120 °C [9–11].

\* Corresponding author.

E-mail address: [benhalima.ahlem@gmail.com](mailto:benhalima.ahlem@gmail.com) (A.B. Halima).

<https://doi.org/10.1016/j.csite.2022.101989>

Received 22 February 2022; Received in revised form 26 March 2022; Accepted 30 March 2022

Available online 5 April 2022

2214-157X/© 2022 The Authors. Published by Elsevier Ltd. This is an open access article under the CC BY-NC-ND license (<http://creativecommons.org/licenses/by-nc-nd/4.0/>).

**Table 1**  
Characteristics of Bridgelux W3500 LED [23].

Characteristics	Value	Unit
Luminous flow	4000	lm
voltage	24.6	V
Test current	2.1	A
Color temperature	3045	K
Maximum current	3	A
Case temperature	70	°C

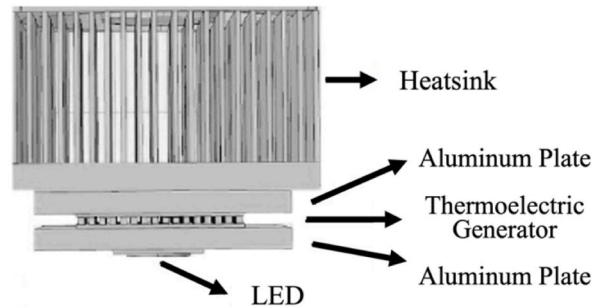

Fig. 1. Picture of the cooling system with TEC.

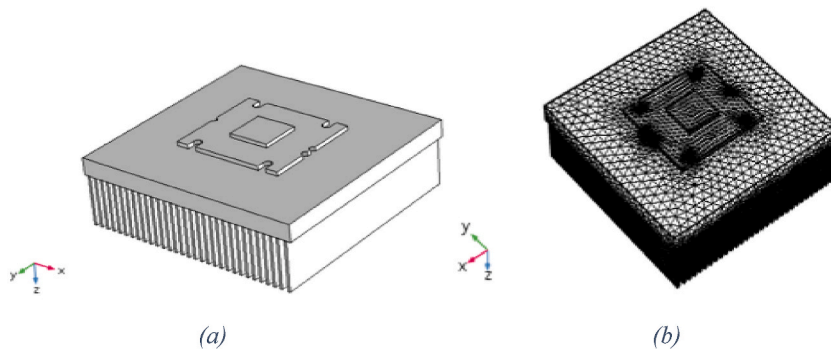

Fig. 2. Meshing adopted in the simulation.

Therefore, thermal management of high-power LEDs is an essential area for research and development. It is necessary to limit the junction temperature to a value which ensures the desired service life.

Different cooling methods have been published by many researchers such as studies on radial heat sinks adapted to circular shaped LED sources, have been carried out by Refs. [12–14], on the other hand, liquid cooling of LEDs has been studied for automotive applications where active cooling of the heat sink with cold plate has been proposed to dissipate heat [15]. Others have used the theory of entropy generation to optimize minimum thermal resistance [16]. Other experiments on LED vapor chamber-based plates have been studied [17]. These methods can minimize the junction temperature of LED chips. However, it has some drawbacks, such as high cost and poor stability.

With this, further work has been developed on the phenomena of electrical energy generation in relation to the thermal process, this phenomenon is the thermoelectric effect.

This generator is a solid device that generates electricity from thermal energy. Nowadays, this thermoelectric application is considered as a solution for activities in all fields and has wide applications in commercial field such as high-quality temperature control [18,19]. Many works deal with cooling by a thermoelectric element through experimental methods. This system was prepared to cool high-power LEDs and the result indicated that the junction temperature could be controlled down to less than 45 °C at an optimum value of thermoelectric module current [20]. Further work of the LED integrated into a TEC (thermoelectric cooler) has achieved an electrical energy saving of 22.34% and 44.73% under power dissipation conditions of 20 W and 30 W of the LED chip unlike the fluorescent lamp, respectively, but has 2.71% power less than 10 W [21,22]. Most of the work in these studies has focused on high power white LEDs and TECs, but the influence of TEC cooling on thermal junction temperature has rarely been investigated.

From these observations, there are only two solutions to increase the energy efficiency of LEDs: either reduce thermal losses, or use them to produce energy that can be converted into light. Some studies have been based on the second hypothesis and have been

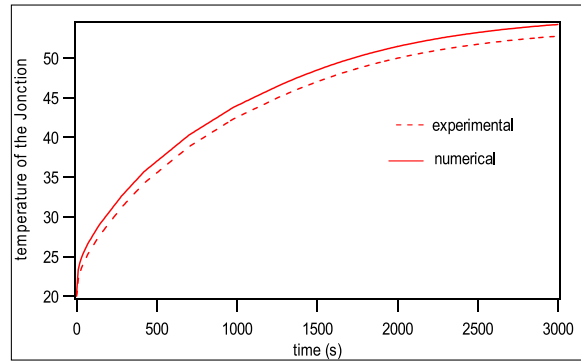

Fig. 3. Curve of validation between numerical and experimental results.

published showing proof of feasibility. This, using a Peltier module converts the heat flow into electrical energy which is then adapted to light up white LEDs.

However, the addition of a Peltier module on the heat sink increases the thermal resistance and therefore the temperature at the level of the LED source and its junction. These thermal effects induce a drop in the luminous efficiency of the LED source. This study proposes an energy balance of such a device in order to evaluate the potential gain or the losses generated by the addition of a Peltier module (TEC) and thus to estimate the necessary efficiency of a thermal converter which would allow at least a zero gain and discusses the limitations of this solution used in an LED lamp.

## 2. Model description

The power LED that we used is a H–P LED Bridgelux BXRA-W3500. The main characteristics of this light source are given in Table 1.

This study starts by identifying the components of the module that will be used for the simulation. The LED lamp (surface to be cooled), the TEC (thermoelectric cooler) and the heat sinks are represented using three dimensional schematics as in Fig. 1.

The characteristics of a TEC (thermoelectric cooler) are a small size, a long life and a high reliability. We have chosen the Peltier module which dimensions are 40x44 × 33 mm. It consists of 83 thermocouples made of bismuth telluride ( $Bi_2Te_3$ ), they are connected thermally in parallel and electrically in series. These thermocouples are connected by conductive plates based on copper. The copper plates are covered by two ceramic plates based on ( $Al_2O_3$ ) as an electrical insulator.

## 3. Numerical simulation

A three-dimensional time dependent COMSOL Multiphysics® was used to solve different equations of the system. The physics, solver setting and the mesh resolution were refined using this model, after that, a parametric study was adapted using the geometry proposed.

### 3.1. Equations

The perfect equations of the model with TEC generator are the one that deals with the heat transfer rates over the junctions of the thermoelectric couple, because there’s a part of hot side and cold side. The equations of heat flow and continuity of the electrical charge are coupled together with some thermoelectric equations [24–26].

### 3.2. The boundary conditions

The boundary conditions for the model were set as follows:

- Heat flux, the density  $q_0$  is as follows:

$$q_0 = - \vec{n} \cdot (-\lambda \cdot \nabla T) \tag{1}$$

- Natural convection: The “LED + Heatsink” is cooled by natural convection (the exterior surfaces):

$$- \vec{n} \cdot (-\lambda \cdot \nabla T) = h(T_{ext} - T) \tag{2}$$

Where h: the coefficient of convective exchange.

$T_{ext}$ : the ambient temperature

$\vec{n}$ : the normal to the surface outwards

COMSOL® uses empirical correlations that define the coefficient h according to the geometry.

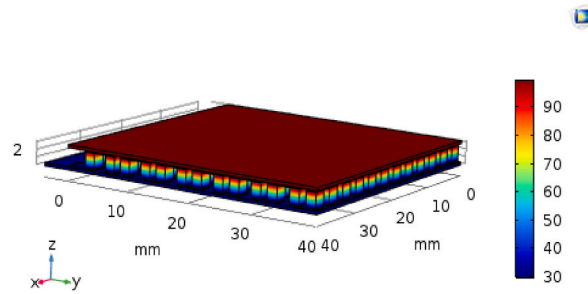

Fig. 4. Temperature profile in the thermoelectric module.

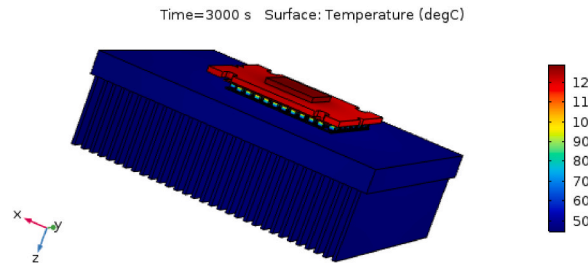

Fig. 5. Numerical profile of Junction temperature.

### 3.3. Meshing

The mesh is a fundamental step which conditions the precision of the results. Therefore, we chose a fine mesh since we noted that from this mesh the solution has become constant as well as there is an increase in computation time. The number of elements is 485195.

In fact, to assure the convergence of the model, the volume averaged temperature of the junction was the key. This was chosen because experimentally this temperature is easy to measure, and does not display spatial variation.

If the mesh is instructed, non-uniform and the refinement in region surrounding the LED is extensive, the value of the junction temperature will not be exact. A high resolution is needed (see Fig. 2).

### 3.4. Model validation

The model in this project was in first step validated by experimental measurements done in previous work [27]. As we can see in Fig. 3, the steady state is achieved and the temperature is around 60 °C. The verification is performed by taking the calculated temperature and comparing it with the experimental values at the junction.

## 4. Results and discussion

### 4.1. Simulation of the thermoelectric module

The thermoelectric generators produce electricity directly from the flow of heat. The elements are combined in series of pairs of 'P type' and 'N type' to increase voltage and power output. The electrons flow from hot to cold in the "N type"; while the electron holes' flow from hot to cold in the 'P type'. This allows them to be combined electrically in series.

Electrons on the hot side of a material are more energized than on the cold side. These electrons will flow from the hot side to the cold side. If a complete circuit can be made, electricity will flow continuously. We used a bismuth telluride module due to its high efficiency and high operating temperature [23,27].

As boundary conditions, the temperature on the hot side is 100 °C, temperature on the cold side is  $T = 30$  °C,  $V = 0V$  and  $I = 0A$ . Fig. 4 shows the profile of the temperature obtained by COMSOL's simulation.

### 4.2. Simulation of the LED lamp with TEC

Through the numerical simulation, the effect of TEC is obviously clear, when the thermoelectric module is added to the "LED + heat sink" system, the junction's temperature increase to 120 °C as shown in Fig. 5 and the heat made by this LED is dissipated close to the thermoelectric module and the heat sink by natural convection with the ambient air.

As we said before, a part of the electrical energy is converted onto heat energy. If this one cannot be accrued to the outside in time, the heat will be accumulated at the PN junction in the LED, which leads to an increase in temperature. This will lead to the change of spatial distribution of the light emitted by the LED. In fact, when the temperature is high enough, the position of the wavelength will change, and the peak of the phosphor becomes flat and deteriorate. So, it is necessary to control the junction temperature.

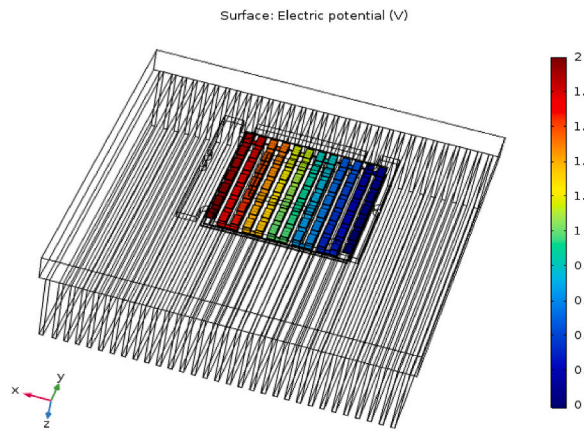

Fig. 6. Electric potential (V).

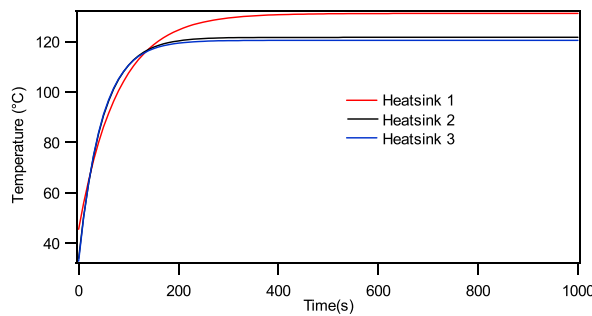

Fig. 7. Comparison of LED board temperature with different values of heat sink's dimensions.

Table 2  
The parameters of the heatsinks.

Parameter	Heatsink 1	Heatsink 2	Heatsink3
length	100	150	180
width	101.6	101.6	101.6
height	23.75	23.75	23.75
Number of heats sinks	30	30	30

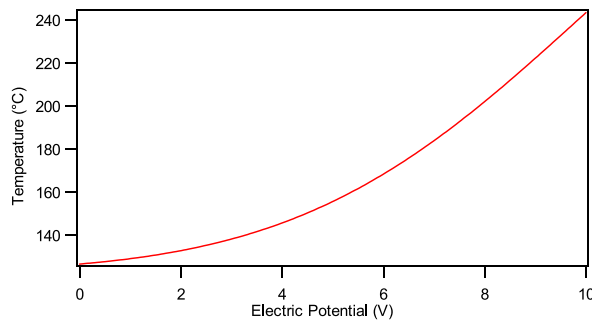

Fig. 8. Profile of the temperature in function of voltage at the Junction temperature.

Thus, following the heat transfer evacuated by the studied LED (Bridgelux [22]) which is dissipated to the thermoelectric module and the heatsinks, we obtained an electric potential gradient of the order of 2 V at the level of Peltier module as shown in Fig. 6. It can therefore use this current to turn on other LEDs since the threshold voltage for a red LED is 1.6V.

TEC is added, as shown in Fig. 7, then, the more the Joule heat is, and it is the enormous Joule heat in this case which results in the

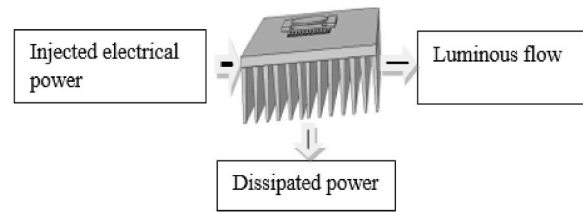

Fig. 9. Energy balance of an LED.

**Table 3**  
Energy efficiency of two cases.

System	Luminous flow [W]	Energetic efficiency %
LED + heatsink	8.34	17
LED + Peltier Module + heatsink	7.93	16

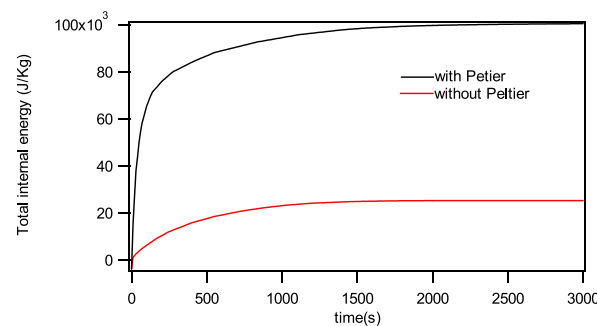

Fig. 10. Total internal energy with and without the Peltier module.

higher junction temperature and that is due to the decreases of thermal resistance of LED when TEC is used. When increasing the dimension of heat sink as shown in Table 2, the temperature increases a little but it becomes constant for certain dimension.

This is due to the gain of energy produced by the Peltier module in the system and overcome the effect of varying the dimension of heat sinks.

#### 4.3. Different input voltage of TEC

The heat absorbed and discharged turn on the input power of the TEC. Then, the effect of voltage is investigated in the thermal behavior in Fig. 8. The TEC continuously increases vary from 0V to 10V.

### 5. Energy balance and evaluation of the gain

The thermal modeling of the LED light source was carried out with and without the Peltier module. In order to assess the energy gain, an energy balance must be established.

For the same injected power, we quantify the luminous flux produced by the power LED with and without the Peltier system/heat-sink, to establish an energy balance for the two systems, in order to estimate the gain as shown in Fig. 9.

We have calculated the energy efficiency obtained numerically of two systems in the following table.

From Table 3, we found that the efficiency of such a LED system remains low by adding the thermoelectric module.

By comparison of the total internal energies found during the numerical simulation, we obtain the curve that shows the energy produced by the “LED + heatsink” system and the “LED + heatsink + Peltier” effect in the whole system. Then, we added the Peltier module and increased the energy of the system produced by the thermoelectric module as shown in Fig. 10.

From the curve in the datasheet of the Bridgelux LED light source which is the normalized Luminous Flux in function of the Junction Temperature [20], we obtain a loss in the efficiency around 18% between the two cases.

Based on the numerical results and when calculating the difference between the dissipated power and luminous efficiency, we obtained an energy loss in the order of 16.5%.

### 6. Conclusion

A 3D digital study was carried out to evaluate the thermal behavior of a high power LED lamp. The heat dissipation performance of the LED using a thermoelectric module was achieved using Comsol Multiphysics. The effect of the Peltier modulus has been studied



and discussed. The main results established are:

- Increasing the junction temperature by adding TEC to the Bridgelux LED + heatsinks system.
- The efficiency of the LED decreases with a Peltier module from 17% to 16%.
- The energy loss is about 16.5%.

If the principle idea seems interesting, we have shown that this basic system generates more losses than gain because the addition of the Peltier module increases the thermal resistance and reduces the luminous efficiency of the LED by increasing the LED chip temperature. This kind of system can therefore only be efficient if it does not hinder the dissipation of the LED light source or if the conversion of thermal energy into electrical energy reaches an efficiency threshold higher than the current device.

#### Author agreement

We certify that this paper has not been published elsewhere and it has not been submitted simultaneously for publication elsewhere.

#### Declaration of competing interest

The authors declare that they have no known competing financial interests or personal relationships that could have appeared to influence the work reported in this paper.

#### Acknowledgments

This work is part of PHC Maghreb (Program Hubert Curien) MELINA (Mastering Efficient Lighting In North Africa) supported by Campus France and funded by Ministry of Europe and Foreign Affairs (MEAE) and Ministry of Higher Education, Research and Innovation (MESRI) in France, and, in Tunisia by the Ministry of Higher Education and Scientific Research (MESRS).

#### References

- [1] Laurent Canale, Georges Zissis, 'Éclairage à base de LEDs - Composants LED', v1-e6501">, 2019, <https://doi.org/10.51257/a-v1-e6501>.
- [2] S. Leng, L. Canale, P. Dupuis, G. Zissis, 'Aging study of white high power LED under thermal and electrical stresses – new experimental setup prototype, photometric and electrical characterizations', in: Conference on Lasers and Electro-Optics, OSA Technical Digest (Online) (Optical Society of America, 2016 paper ATh3K.4.
- [3] K. Ben Abdelmlek, Z. Araoud, R. Ghnay, K. Abderrazak, K. Charrada, G. Zissis, Effect of thermal conduction path deficiency on thermal properties of LEDs package, *Appl. Therm. Eng.* 102 (2016) 251–260.
- [4] Ning Wang, Cong Gao, Can Ding\*, Hong-Zhi Jia, Guo-Rong Sui, Xiu-Min Gao, A thermal management system for energy harvesting from heat released by high-power LEDs, *IEEE Trans. Electron. Dev.* 66 (no. 11) (2019) 4790–4797.
- [5] J. Li, X. Zhang, C. Zhou, et al., New applications of an automated system for high-power LEDs, *IEEE/ASME Trans. Mechatronics* 21 (no. 2) (Apr. 2016) 1035–1042.
- [6] Khaoula Ben Abdelmlek, Z. Araoud, Laurent Canale, Georges Zissis, Optimal substrate design for thermal management of high power multi-chip LEDs module, *Optik Int. J. Light Electron. Optics.* 242 (2) (May 2021) 167179.
- [7] Khaoula Ben Abdelmlek, Zouhour Araoud, Kamel Charrada, Georges Zissis, Optimization of the thermal distribution of multi-chip LED package, *Appl. Therm. Eng.* (July 2017) 126, <https://doi.org/10.1016/j.applthermaleng.2017.07.136>.
- [8] G. Zissis, L. Canale, Éclairage à base de LEDs, Conception des systèmes, *Techniques de L'Ingénieur*, E6502, 23 pp. v1-e6502"><https://doi.org/10.51257/a-v1-e6502> (2019).
- [9] J. Li, B. Ma, R. Wang, L. Han, Study on a cooling system based on thermoelectric cooler for thermal management of high-power LEDs, *Microelectron. Reliab.* 51 (no. 12) (2011) 2210–2215.
- [10] H.H. Cheng, D.-S. Huang, M.-T. Lin, Heat dissipation design and analysis of high-power LED array using the finite element method, *Microelectron. Reliab.* 52 (no. 5) (2012) 905–911.
- [11] P. Anithambigai, K. Dinash, D. Mutharasu, S. Shanmugan, C.K. Lim, Thermal analysis of power LED employing dual interface method and water flow as a cooling system, *Thermochim. Acta* 523 (no. 1–2) (2011) 237–244.
- [12] Ha Minseok, et al., Development of a thermal resistance model for chip-on-board packaging of high-power LED arrays, *Microelectron. Reliab.* 32 (4) (2012) 836–844.
- [13] Ning Wang, Jian-nan Zhang, Zhi-Yuan Liu, Can Ding\*, Guo-Rong Sui, Hong-Zhi Jia, Xiu-Min Gao, An enhanced thermoelectric collaborative cooling system with thermoelectric generator serving as a supplementary power source, *IEEE Trans. Electron. Dev.* 68 (no. 4) (2021) 1847–1854.
- [14] Ning Wang, Zhi-Hao Shen, Cong Gao, Ming-Ming Chen, Can Ding\*, Guo-Rong Sui, Hong-Zhi Jia, Xiu-Min Gao, Electro-thermal collaborative cooling with delayed power rail switching and auxiliary charging Technique considering energy harvesting mechanism for high-power LEDs, *IEEE Trans. Compon. Packag. Manuf. Technol.* 10 (9) (2020) 1507–1514.
- [15] Yu Seung-Hwan, Lee Kwan-Soo, Yook Se-Jin, Optimum design of a radial heat sink under natural convection, *Int. J. Heat Mass Tran.* 54 (2011) 2499–2505.
- [16] Lai Yan, et al., Liquid cooling of bright LEDs for automotive applications, *Appl. Therm. Eng.* 29 (2009) 1239–1244.
- [17] Bladimir, et al., Comparison and optimization of single-phase liquid cooling devices for the heat dissipation of high-power LED arrays, *Appl. Therm. Eng.* 59 (2013) 648–659.
- [18] Mehmet Kaya, Experimental study on active cooling systems used for thermal management of high-power multichip light-emitting Diodes, hindawi publishing corporation, Article ID 563805, *Sci. World J.* (2014) 7, <https://doi.org/10.1155/2014/563805>.
- [19] Haonan Yang et al., 'Performance analysis of multi thermoelectric-cooling modules', *J. Phys.. : Conf. Ser.* 2030 012015, 2021.
- [20] J. Li, B. Ma, R. Wang, et al., Study on a cooling system based on thermoelectric cooler for thermal management of high-power LEDs, *Microelectron. Reliab.* 51 (no. 12) (Dec. 2011) 2210–2215.
- [21] D. Zhong, H. Qin, C. Wang, et al., Thermal performance of heatsink and thermoelectric cooler packaging designs in LED, in: *Proc. Int. Conf. Electron. Packag. Technol. High Density Packag.*, ICEPT-HDP, Xi'an, China, Sep. 2010, pp. 1377–1381.
- [22] H. Qin, D.L. Zhong, C.H. Wang, Thermal performance evaluation and economic analysis of LED integrated with thermoelectric cooler package, *Adv. Mater. Res.* 216 (2011) 106–110.
- [23] BXRA-W3500-00SOG Bridgelux, BXRA-W3500-00s0g Datasheet.
- [24] A. Ben Halima, Z. Araoud, K. Charrada, L. Canale, G. Zissis, Thermal valorization of the LED by a thermoelectric generator, in: Conference: 2021 3rd International Conference on High Voltage Engineering and Power Systems (ICHVEPS), October 2021, <https://doi.org/10.1109/ICHVEPS53178.2021.9601040>.



- [25] N. Wang, J. Zhang, H. Ni, H. Jia, C. Ding, Improved MPPT system based on FTSMC for thermoelectric generator array under dynamic temperature and impedance, in: Transactions IEEE sur l'électronique industrielle, 2022. PP (99), 1–1.
- [26] Ning Wang, Zhou-Xiao Liu, Can Ding\*, Jian-Nan Zhang, Guo-Rong Sui, Hong-Zhi Jia, Xiu-Min Gao, High efficiency thermoelectric temperature control system with improved proportional integral differential (PID) Algorithm using energy Feedback Technique, IEEE Trans. Ind. Electron. 69 (no. 5) (2022) 5225–5234.
- [27] R. Ben Hassen, L. Canale, Z. Araoud, G. Zisis, Feasibility study of thermal losses conversion into Light for High Power LEDs using thermoelectric modules, 16th International Symposium on the Science and Technology of Lighting, 17th – 22nd June 2018, Sheffield, (UK).