



HAL
open science

Modelling and Optimal Control of MIMO System -France Macroeconomic Model Case

Zilong Zhao, Bogdan Robu, Ioan Doré Landau, Luc Dugard, Nicolas Marchand,
Louis Job

► **To cite this version:**

Zilong Zhao, Bogdan Robu, Ioan Doré Landau, Luc Dugard, Nicolas Marchand, et al.. Modelling and Optimal Control of MIMO System -France Macroeconomic Model Case. 2022. <hal-03632679>

HAL Id: hal-03632679

<https://hal.science/hal-03632679v1>

Preprint submitted on 6 Apr 2022

HAL is a multi-disciplinary open access archive for the deposit and dissemination of scientific research documents, whether they are published or not. The documents may come from teaching and research institutions in France or abroad, or from public or private research centers.

L'archive ouverte pluridisciplinaire **HAL**, est destinée au dépôt et à la diffusion de documents scientifiques de niveau recherche, publiés ou non, émanant des établissements d'enseignement et de recherche français ou étrangers, des laboratoires publics ou privés.



HAL Authorization

Modelling and Optimal Control of MIMO System - France Macroeconomic Model Case

Zilong Zhao^{*†}, Bogdan Robu[†], Ioan Landau[†], Luc Dugard[†], Nicolas Marchand[†] and Louis Job[‡]

[†]University of Grenoble, France. {firstname.lastname}@grenoble-inp.fr

^{*}TU Delft, The Netherlands. {z.zhao-8}@tudelft.nl

[‡]Sciences Po Grenoble, France. {louis.job}@sciencespo-grenoble.fr

Abstract—Applying control theory to economic problems has been studied since 1970s. Early stage studies focus on policy analysis and optimizations. With the development of theory, recent researches touch on more applications such as (1) monetary policy, (2) fiscal policy, and (3) resource allocation problems using PID control and optimal control. Even the problems change, the studies that applied optimal control follow the same idea: finding a control law to optimize an objective function for a dynamic system under certain constraints.

In this paper, we focus on french macroeconomic model. Variables such as Gross Domestic Production, Exportation, Importation, Household Consumption, Gross Fixed Capital Formation and Public expenditure are included in the analysis. Our objective is to maintain a constant economic growth rate according to the available resources. We implement a one-of-a-kind optimal control via Linear-Quadratic regulator (LQR) to achieve that. Since we aim to maintain a constant growth rate instead of a constant value, a specific control system is designed for this purpose. We implement three experiments: (1) variation on parameter of LQR, (2) constraints on inputs, and (3) perturbations on outputs. Results show that our designed control system can guide the output to the desired growth rate. Varying parameters of LQR can change the convergence speed of the system. Constraints on specific inputs can delay the system convergence and stimulate other inputs to compensate for the constraints. Perturbations on outputs experiment show that our control law can help the system to recover to the original state-space.

Index Terms—MIMO, Optimal control, LQR, Macroeconomic data

I. INTRODUCTION

Control theory is commonly applied to mechanical and physical systems. But it is a strong tool to solve optimization problem in various areas [14], [22]–[26]. Applying control theory for economic problems has been studied since 1970s. [7] summarizes the development of stochastic control theory in macroeconomic policy analysis in three periods. The first is pre-1970 when the major ideas of policy analysis and of optimization were formed [9]. The second is the early and middle 1970s when formal stochastic control theory was rapidly developed for and applied to the study of macroeconomic policy [6], [11]. The third period, beginning in the late 1970s, was stimulated by the introduction of the idea of rational expectations in economic analysis [4].

Recent works focus more on applications. [16] proposes a general class of PID-based monetary policy rules, the feedback rules let the model use a control signal (e.g. central bank's

policy interest rate) responds to movements in a small number of macroeconomic factors, such as the current amount of labor market slack and the deviation of the rate of inflation from its target. Under an optimal control monetary policy [5], the current and expected future path of the policy is instead typically calculated with a procedure that minimizes a cost function subject to certain constraints. For fiscal policy [19] and resource allocation [8], [17] problems, they follow the same ideas of optimal control, differences are the cost function and the constraints. To estimate the asset holdings of a portfolio, [13] uses algorithms applied to nonlinear dynamic systems to estimate the state with a discrete-time observer.

In this paper, we will apply control techniques to a French macroeconomic model using real economic data (available as time series) starting from 1980s. Our objective would be to design a meaningful control policy that would allow a constant growth rate of the Gross Domestic Product. After choosing the appropriate variables as inputs and outputs, we will first model this system as Multiple-Input and Multiple-Output (MIMO) system. After data pre-processing to make the time series stationary, the orders and parameters of MIMO system are estimated and validated before transforming it into a state-space model. The model we estimate in this paper is an autoregressive model with external inputs. To satisfy our objective, an optimal control solution: Linear-Quadratic regulator (LQR) is designed and implemented. By varying parameters of LQR, we can control the converging speed of output to state-space. A further simulation result shows that if we put constraints on the level of one of input signals, we can observe the compensation effect from other inputs. But even there is no limitation on the amplitude of inputs variables, the level of output and its converging speed to state-space is still slightly worse than the case without constraints. Perturbations on outputs are also studied, which simulates a scenario of an economic crisis. The experiments are also developed with and without constraints on input signals. Results show that our system can quickly recover from the disturbance, and constraints on input signals delay the recovery.

II. SYSTEM IDENTIFICATION

In this section, the process of estimating the economic model is given. After the data preparation (to make it stationary), a MIMO model is computed. The parameters of the model are then estimated and validated.

A. Data Preparation

All the data used throughout this paper are obtained from the INSEE (Institut National de la Statistique et des Études Économiques) which regroups the official economic French Data ¹. A plethora of data is available, nevertheless for a non-expert it is hard to decide which makes sense in our case. After several discussions with experts on these macroeconomic issues, we decide to study 6 time series namely: Gross Domestic Production (GDP), Exportation (EXP), Importation (IMP), Household Consumption (HC), Gross Fixed Capital Formation (GFCF) and Public Expenditure (PE). In the INSEE database we find that all this data are quarterly, ranged from the first quarter of 1980 to the fourth quarter of 2018, 1980T1 to 2018T4, where T1 and T4 denote first and fourth quarter of the year². Following a similar analysis as the one performed in [?] we decide the inputs and outputs of the system. The inputs of the model would be variables on which the appropriate governmental structures can act and incite their modification, namely Household Consumption, Gross Fixed Capital Formation and Public Expenditure. On the other side, the outputs of the model are variables on which we suppose that, on a regular basis, are only measured but the government can not directly act on: Gross Domestic Production, Exportation, Importation.

The reader should note that the original data from INSEE are presented on the values of current price and make no adjustment for inflation. This is problematic as the current price measure measures for example GDP, inflation or asset prices using the actual prices we notice in the economy not the real, deflated, one. Before anything else, we therefore need to deflate it by using France GDP deflator (base year: 2014) obtained from the World Bank. Deflated time series are showed in Fig. 1.

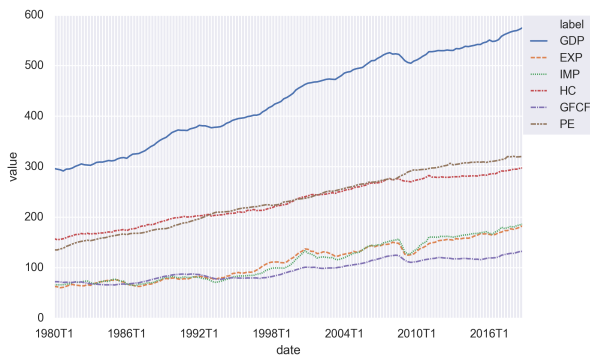

Fig. 1: Original data (Unit: Billion Euro).

As we deal with time series having an economic meaning, we prefer to use natural logarithm to better linearize them. The intuition behind this choice comes from macroeconomics, where it is quite common to consider it as it eases the analysis (see for example [12]). Moreover, as we will use these time

¹<https://www.insee.fr/fr/accueil>

²The reader must note that especially due to the arrival Covid-19 pandemics, data from 2019 were not taken into account in this study.

TABLE I: ADF test for unit root

Variables	ADF Level	ADF First Difference
LGDP	-1.10548(1)	-7.66072(0)***
LEXP	-3.28665(2)	-6.29252(3)***
LIMP	-2.87331(4)	-6.20372(3)***
LHC	-1.45805(3)	-5.59492(2)***
LGFCF	-3.60257(2)	-4.01801(1)***
LPE	-1.92627(1)	-5.69958(1)***

Null hypotheses: Variable contains an unit root

Notes: (1) ***, ** and * denote significance at the 1%, 5%, and 10% levels, respectively.

(2) Figures in parentheses are the number of lags (delays) used.

series to do linear regression, we must ensure that all these series are stationary.

Augmented Dickey–Fuller (ADF) test `cheung1995lag` is a commonly used statistical unit root test to examine whether a given time series is stationary or not. In our case, we would test the stationary for the natural logarithm of our original time series as well as the first difference of natural logarithm. Results are shown in Table I where LGDP, LEXP, LIMP, LHC, LGFCF and LPE denote the natural logarithm of our 6 time series introduced before: GDP, EXP, IMP, HC, GFCF and PE. From Table I we can therefore observe that the test, in the case of the natural logarithm of the original data, cannot reject the null hypothesis that the variable contains a unit root, which implies that the original time series are therefore not stationary. Nevertheless, we can notice that the results for the first difference of natural logarithm of all the series rejects the null hypothesis at 99% (i.e., note the *** following the values as indicator). We can therefore infer that these time series using the first difference of natural logarithm are stationary. Moreover, we will use the first difference of natural logarithm of GDP, EXP, IMP, HC, GFCF and PE in later analysis (hereinafter referred to as DLGDP - for difference logarithm GDP, DLEXP, DLIMP, DLHC, DLGFCF and DLPE).

B. Selection of model order

In order to introduce our economic model, we first define the input and output vectors as follows:

$$y = \begin{bmatrix} y_1 \\ y_2 \\ y_3 \end{bmatrix} = \begin{bmatrix} \text{DLGDP} \\ \text{DLEXP} \\ \text{DLIMP} \end{bmatrix} \quad u = \begin{bmatrix} u_1 \\ u_2 \\ u_3 \end{bmatrix} = \begin{bmatrix} \text{DLHC} \\ \text{DLGFCF} \\ \text{DLPE} \end{bmatrix} \quad (1)$$

where y is the output (endogenous variables) of our model, u is the input (exogenous variables) of our model. Note that the selections of y and u are done according to their economic interpretation and attributes. Input (exogenous) variables are therefore the factors we could manipulate in an economic system (e.g., increasing public expenditure for example) while output (endogenous) variables are the consequences that we could only observe in our case but not directly interfere with (e.g., the variation of importations for example).

In the general case, consider an "m-input-p-output" system represented by a canonical input-output representation [15], for $i = 1, 2, \dots, p$:

$$y_i(k) = \sum_{j=1}^p \sum_{q=1}^{n_{ij}} a_{ijq} y_j(k+q-n_i-1) + \sum_{j=1}^m \sum_{q=1}^{n_i} b_{ijq} u_j(k+q-n_j-1) + e_i(k) \quad (2)$$

where p and m is the numbers of outputs and inputs, $y_i(k)$ denotes the value of output y_i at time k , a_{ijq} and b_{ijq} are the coefficients of $y_i(k+q+n_i-1)$ and $u_i(k+q-n_j-1)$, $e_i(k)$ is the white noise at time k . Moreover, n_i are the observability indices and n_{ij} are given by:

$$n_{ij} = \min\{n_i, n_j\}, \text{ if } i \leq j \quad (3)$$

and

$$n_{ij} = \min\{n_i + 1, n_j\}, \text{ if } i > j \quad (4)$$

We apply this method for each output using the technique of "instrumental variables" (see for example [18]), and implementing a criterion which penalizes the model complexity as we want to estimate models of reduced order (see for example [10], [18] among others). Fig. 2 shows the order selection process for y_1 , y_2 and y_3 while *Criteria* variable calculates the average of estimation errors. The *Criteria* is defined as $J(\hat{n})$ as follows:

$$J(\hat{n}) = \min_{\hat{\theta}} \frac{1}{N} \|Y(t) - R(\hat{n})\hat{\theta}\|^2 \quad (5)$$

where \hat{n} is the estimated system order, N is the number of data, $\hat{\theta}$ is the estimation of parameters. $Y(t)$ is the real value and $R(\hat{n})\hat{\theta}$ is the estimated value. $S(\hat{n}, N)$ is the part served as *penalty* and defines as follows:

$$S(\hat{n}, N) = \frac{2\hat{n} \log(N)}{N} \quad (6)$$

According to [18], $J(\hat{n})$ goes towards 0 as the estimated order approaches the true one. Therefore, as order increases, we can see from Fig. 2 that *criteria* decreases to 0. But $S(\hat{n}, N)$ increases with the increase of the chosen order.

As it can be seen from Fig. 2, the estimated model between the inputs and each of the three outputs is: 5 for y_1 , 4 for y_2 and 5 for y_3 . One should notice that these estimated order are not definitive as we still need to pass the validation process to decide the final order.

C. Estimation and Validation of parameters

After finding the model order, Least Squares method is used to estimate the parameters of the 3 equations for y_1 , y_2 and y_3 . After each estimation, a whiteness test (autocorrelation test) will be applied to make sure the residuals from the estimated equation are white noise, which means the estimated model have already extracted all the knowledge from training data (this problem is well studied in both economic [2]

and control [18] domain). The algorithms of calculation vary through these studies, but the goal remains the same: testing if values are mutually uncorrelated. In this paper, we choose to use the implementation of autocorrelation test function in [3].

Consider T as the total number of data points in the dataset, we can therefore conclude that all the autocorrelation values should be in the range $(0 \pm \frac{1.96}{\sqrt{T}})$. In our case, from 1980T1 to 2018T4 we have 156 data points, so the limit is ± 0.157 here. Fig. 3 shows the final autocorrelation test for estimation residuals of y_1 , y_2 and y_3 where the limit of ± 0.157 is manifested by the horizontal blue lines.

Please recall that our objective is to find the minimal model, which means a model with the lowest order (minimum number of variables), but still valid. Therefore, once we find a valid candidate model we would still try to reduce the order by eliminating the variables whose coefficient is much smaller than the others by comparing their absolute value. Nevertheless this can pose problems concerning the validity of the mode (for example the residual not being a white noise anymore). Therefore, every time we delete one variable we need to re-estimate all the parameters then re-do the whiteness test on residuals in order to check the validity of the new model. We continue to remove variables until none can be removed from the equation without compromising the validity of the model.

The minimal model can be written as follows:

$$y_1(k) = a_{115}y_1(k-1) + a_{114}y_1(k-2) + a_{113}y_1(k-3) + a_{112}y_1(k-4) + a_{111}y_1(k-5) + a_{124}y_2(k-2) + a_{123}y_2(k-3) + a_{122}y_2(k-4) + a_{135}y_3(k-1) + a_{134}y_3(k-2) + a_{133}y_3(k-3) + b_{111}u_1(k-1) + b_{131}u_3(k-1) + e_1(k) \quad (7)$$

$$y_2(k) = a_{214}y_1(k-1) + a_{221}y_2(k-4) + a_{222}y_2(k-3) + a_{223}y_2(k-2) + a_{224}y_2(k-1) + a_{234}y_3(k-1) + b_{211}u_1(k-1) + b_{221}u_2(k-1) + e_2(k) \quad (8)$$

$$y_3(k) = a_{314}y_1(k-1) + a_{313}y_1(k-2) + a_{324}y_2(k-1) + a_{323}y_2(k-2) + a_{334}y_3(k-1) + a_{333}y_3(k-2) + a_{332}y_3(k-3) + a_{331}y_3(k-4) + b_{321}u_2(k-1) + e_3(k) \quad (9)$$

As we can see, the final orders of the reduced model are 5 for y_1 , 4 for y_2 and 4 for y_3 . The numerical values of the parameters are detailed in below

If we define our state vector X as:

$$X(k) = [y_1(k-1) \ y_1(k-2) \ y_1(k-3) \ y_1(k-4) \ y_1(k-5) \ y_2(k-1) \ y_2(k-2) \ y_2(k-3) \ y_2(k-4) \ y_3(k-1) \ y_3(k-2) \ y_3(k-3) \ y_3(k-4)]^T \quad (10)$$

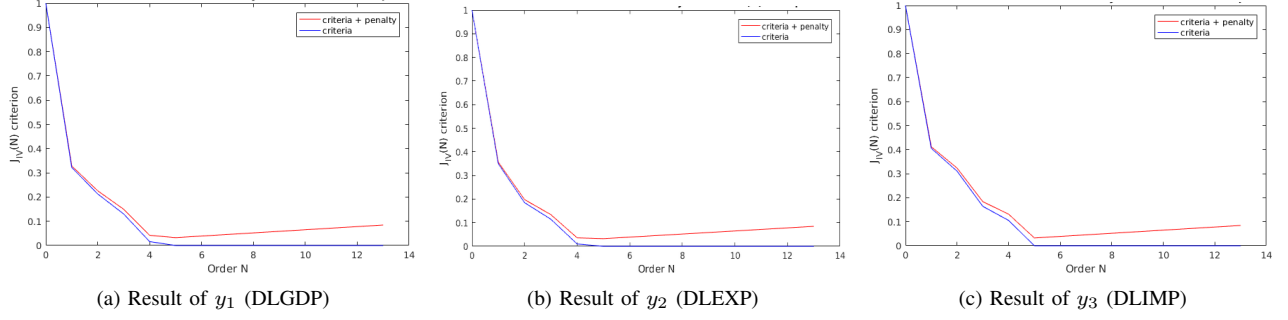

Fig. 2: Order Selection

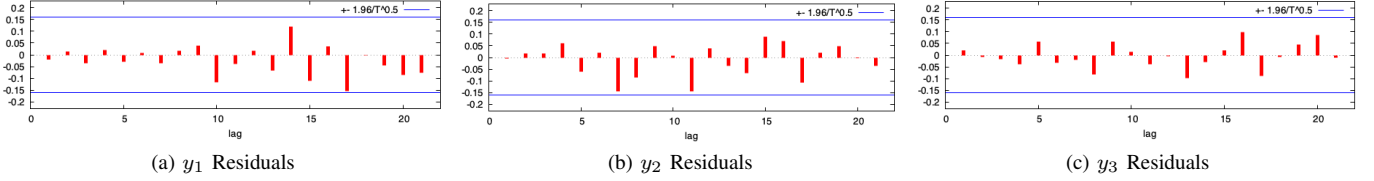

Fig. 3: Autocorrelation Test for the estimation of residuals

the Eq. (7), (8), (9) can be written as a discrete-time state-space model in the following form:

$$\begin{aligned} X(k+1) &= A \cdot X(k) + B \cdot u(k) \\ Y(k) &= C \cdot X(k) + D \cdot u(k) \end{aligned} \quad (11)$$

where $k \in \mathbb{Z}^+$, output y and control u vectors are given by equation 1, $A \in \mathbb{R}^{13 \times 13}$, $B \in \mathbb{R}^{13 \times 3}$, $C \in \mathbb{R}^{1 \times 13}$, $D \in \mathbb{R}^{1 \times 3}$. The values of A, B, C, D are showed in equation (12) below, where $O_{i \times j}$ is the zero matrix of size $i \times j$.

Eigenvalues of the state matrix A are checked and all are within the unit circle which means the open-loop model is stable as we expected. Controllability and observability of the system are also tested, the rank of the *observability* and *controllability* matrices are equal to the number of states, which suggests that our system is controllable and observable.

III. OPTIMAL CONTROL POLICY

The theory of optimal control is concerned with operating a dynamic system at minimum cost. The case where the system dynamics are described by a set of linear differential equations and the cost is described by a quadratic function is called the LQ problem [1].

In this section, we will first introduce Linear-Quadratic Regulator (LQR) and then, according to the physical nature of our input and output, we develop several modifications of the method.

First, consider a discrete-time linear system given by:

$$X(k+1) = A \cdot X(k) + B \cdot u(k)$$

the cost function of discrete time LQR in finite horizon can be presented as follows:

$$J = X(N)^T Q X(N) + \sum_{k=0}^{N-1} (X(k)^T Q X(k) \quad (13)$$

$$+ u(k)^T R u(k) + 2x(k)^T N u(k)) \quad (14)$$

where Q, R are the weight matrices for state and input and the cross term matrix N is set to 0 in our case as the states and input vectors do not have the same economic meaning in order to be multiplied together.

The feedback control law that minimizes the cost function J is:

$$u(k) = -K \cdot X(k) \quad (15)$$

where K is given by:

$$K = (R + B P^T B)^T (B^T P A + N^T) \quad (16)$$

and P is the unique positive definite solution to the discrete time algebraic Riccati equation (DARE):

$$P = A^T P A - (A^T P B + N)(R + B^T P B)^{-1} (B^T P A + N^T) + Q \quad (17)$$

More details about the practical implementation of LQR in our case are given in Sec. IV-A below.

A. Reference Input

As we will focus on controlling GDP, then we need to implement our designed reference to let output reach the desirable value. Recall that y_1 from Eq. 1 is the first difference of natural logarithm of GDP, illustrated below:

$$y_1(k) = \ln(\text{GDP}(k)) - \ln(\text{GDP}(k-1)) = \ln\left(\frac{\text{GDP}(k)}{\text{GDP}(k-1)}\right) \quad (18)$$

$$A = \begin{bmatrix} 0.397 & 0.06 & -0.126 & 0.193 & 0.066 & 0.037 & 0.05 & 0 & 0 & 0 & 0 & -0.29 & -0.038 \\ 1 & 0 & 0 & 0 & 0 & 0 & 0 & 0 & 0 & 0 & 0 & 0 & 0 \\ 0 & 1 & 0 & 0 & 0 & 0 & 0 & 0 & 0 & 0 & 0 & 0 & 0 \\ 0 & 0 & 1 & 0 & 0 & 0 & 0 & 0 & 0 & 0 & 0 & 0 & 0 \\ 0 & 0 & 0 & 1 & 0 & 0 & 0 & 0 & 0 & 0 & 0 & 0 & 0 \\ 0.264 & 0.072 & -1.055 & 0.958 & 0 & 0.225 & 0.331 & 0.008 & -0.223 & 0.208 & -0.185 & 0 & 0 \\ 0 & 0 & 0 & 0 & 0 & 0 & 1 & 0 & 0 & 0 & 0 & 0 & 0 \\ 0 & 0 & 0 & 0 & 0 & 0 & 0 & 1 & 0 & 0 & 0 & 0 & 0 \\ 0 & 0 & 0 & 0 & 0 & 0 & 0 & 0 & 1 & 0 & 0 & 0 & 0 \\ -1.0538 & 0.97 & -0.6 & 0 & 0 & 0.356 & 0.399 & 0 & 0 & 0.05 & -0.315 & 0.035 & -0.218 \\ 0 & 0 & 0 & 0 & 0 & 0 & 0 & 0 & 0 & 1 & 0 & 0 & 0 \\ 0 & 0 & 0 & 0 & 0 & 0 & 0 & 0 & 0 & 0 & 1 & 0 & 0 \\ 0 & 0 & 0 & 0 & 0 & 0 & 0 & 0 & 0 & 0 & 0 & 1 & 0 \end{bmatrix}$$

$$B = \begin{bmatrix} 0.177 & 0 & 0.118 \\ \dots & \mathbf{O}_{4 \times 3} & \dots \\ 0.342 & 0 & 0.364 \\ \dots & \mathbf{O}_{3 \times 3} & \dots \\ 0 & 0.869 & 0.765 \\ \dots & \mathbf{O}_{3 \times 3} & \dots \end{bmatrix}; C = [1 \ 0 \ 0 \ 0 \ 0 \ 1 \ 0 \ 0 \ 0 \ 1 \ 0 \ 0 \ 0]; D = [0 \ 0 \ 0] \quad (12)$$

If we want our GDP to have constant p percent (%) increasing, we have:

$$\frac{\text{GDP}(k)}{\text{GDP}(k-1)} = 1 + \frac{p}{100}$$

and then the quarterly GDP increasing ratio p can be interpreted as:

$$p = (e^{y_1(k)} - 1) \times 100 \quad (19)$$

where e is the base of the natural logarithm. One can remark that as we want a constant increasing ratio, i.e. p constant, y_1 needs to be constant.

B. Overall control system

In the state-space, the state and input vectors are constant. If we can define the optimal state-space X_r , the corresponding input vector as u_r and the desired output as Y_r , at equilibrium all these variables are satisfying the following equations according to Eq. (11):

$$\begin{aligned} X_r(k) &= A \cdot X_r(k) + B \cdot u_r(k) \\ Y_r(k) &= C \cdot X_r(k) + D \cdot u_r(k) \end{aligned} \quad (20)$$

We see from Fig. 4 that, different from general control method (e.g. PID), the Reference in LQR does not directly apply feedback from the output but reacts on feedback control law $u = -K \cdot X$. Nevertheless, as our state vector contains only the previous values of the output we do not need an observer before implementing our control law. To drive the error between $X(k)$ and $X_r(k)$ to 0, we make a change on Eq. (11), namely:

$$\begin{aligned} X(k) - X_r(k) &= A \cdot X(k) + B \cdot u(k) - X_r(k) \\ &= A \cdot X(k) + B \cdot u(k) - A \cdot X_r(k) - B \cdot u_r(k) \\ &= A \cdot (X(k) - X_r(k)) + B \cdot (u(k) - u_r(k)) \end{aligned} \quad (21)$$

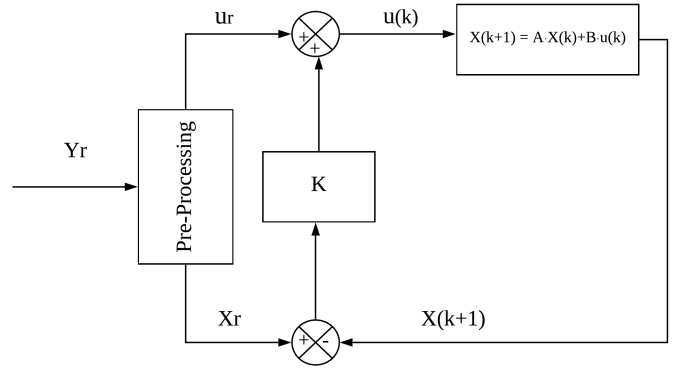

Fig. 4: Modified LQR Control problem

if we define $\Delta X(k) = X(k) - X_r(k)$ and $\Delta u(k) = u(k) - u_r(k)$, then we have a new linear system:

$$\Delta X(k) = A \cdot (\Delta X(k)) + B \cdot (\Delta u(k)) \quad (22)$$

and re-write the cost function of LQR (13) as:

$$\begin{aligned} J_r &= \sum_{k=0}^{N-1} ((\Delta X(k))^T Q (\Delta X(k)) + (\Delta u(k))^T R (\Delta u(k))) \\ &\quad + 2(\Delta X(k))^T N (\Delta u(k)) + (\Delta X(N))^T Q (\Delta X(N)) \end{aligned} \quad (23)$$

the feedback control law that minimizes J_r can be written as:

$$\Delta u(k) = -K \cdot \Delta X(k) \quad (24)$$

where $K = (R + B P^T B)^T (B^T P A + N^T)$ is independent of state and input vectors. We can notice therefore that the K in (15) and (24) does not change.

The control law (24) can also be written as:

$$u(k) = -K \cdot (X(k) - X_r(k)) + u_r(k) \quad (25)$$

According to Eq. (25) we can not directly apply designed output into the feedback, we will need a pre-processing function to transfer the desired output Y_r to the desired state vector X_r and input vector u_r when the system reaches the state-space. One thing to notice that there will not be only one pair of X_r and u_r to satisfy the pre-processing function condition, it will be a range for both value, we will let experts to choose the values which make more sense in real world.

Recall the cost function of LQR (13). where N is set to 0. In this case, we set the weight matrix $Q = C^T Q' C$, since $Y(k) = C \cdot X(k)$, and the auxiliary matrix Q' weights the plant output [21]. We find therefore the usual conclusions: when $R \gg C^T Q' C$, the cost function is dominated by the control effort u , and so the controller minimizes the control action itself, this control strategy is used when the control signal is constrained; when $R \ll C^T Q' C$, the cost function is dominated by the output Y , and there is less penalty for using large u .

IV. SYSTEM EVALUATION

A. Setting-up the evaluation

According to the reality, a yearly GDP growth ratio of 3.2% is interesting to study³. To reach this level, the quarterly GDP increasing ratio p is around 0.8% (i.e. $(1.008)^4 \approx 1.032$).

From (19) we know:

$$y_{1r} = \ln\left(1 + \frac{p}{100}\right) = \ln(1.008) = 0.007968 \approx 0.008$$

Following the same calculation process as above, we set $y_{2r} = 0.0175$ and $y_{3r} = 0.0086$. In the end, $Y_r = [y_{1r} \ y_{2r} \ y_{3r}]$ is the reference.

Recall the relations between Y_r , X_r and u_r in (20), in our experiment, since the output is identical to the first entry of the state vector, the matrix D will be 0 in our case. These equations can be re-written as:

$$\begin{aligned} X_r(k) &= (I - A)^{-1} \cdot B \cdot u_r(k) \\ Y_r(k) &= C \cdot X_r(k) \end{aligned} \quad (26)$$

where I is the identity matrix of suitable dimensions. As we explained in the end of Sec. III-B, there is not only one pair of X_r and u_r that satisfy (26). After our selection, one reasonable pair of X_r and u_r is:

$$X_r(k) = [0.008, 0.008, 0.008, 0.008, 0.008, 0.0173, 0.0173, 0.0173, 0.0173, 0.0086, 0.0086, 0.0086, 0.0086]^T$$

$$u_r(k) = [0.024, 0.003, 0.003]^T$$

³Actually, the recent 10 years (2010-2019) average GDP growth ratio of France is 1.38%, but if we look back 25 years ago, the highest GDP growth ratio are showing during 1998-2001, which the average ratio is around 3.2%. Therefore, we want to study what measurements should be implemented to sustain this growth ratio.

TABLE II: Output behavior. Please note that the state-space error is always 0 due to the type of the controller we consider.

ρ	time to state-space (unit in quarter)	output variation range
$\rho = 1$	18	(0.001, 0.008)
$\rho = 10$	32	(-0.001, 0.008)
$\rho = 100$	37	(-0.002, 0.008)
$\rho = 1$ and constraint on input	20	(0.001, 0.008)

Knowing about the constraint of u , diagonal weights [20] of Q and R are used.

$$Q = \begin{bmatrix} q_1 & & \\ & \ddots & \\ & & q_{n_q} \end{bmatrix}; R = \rho \begin{bmatrix} r_1 & & \\ & \ddots & \\ & & r_{n_r} \end{bmatrix} \quad (27)$$

where $n_q = \text{rank}(A) = 13$, $n_r = \text{rank}(B) = 3$. For the sake of simplicity, we will let $q_i = 1$ for all $i \in [1, 13]$, and $r_j = 1$ for all $j \in [1, 3]$, we will use ρ to adjust the input/state balance. We choose $\rho \in \{1, 10, 100\}$ to implement the experiments to compare the converging speech and observe the input signal range.

B. Experimental Evaluation

For the evaluation of the proposed control strategy, we implement the system detailed in Fig. 4.

The initial state vector X_0 of the state-space model is set by a linear regression over the real data only from 1980T1 to 1981T1. The resulting values are given below:

$$X_0 = [0.001, 0.012, -0.008, -0.004, -0.004, 0.036, 0.032, 0.013, -0.03, 0.007, 0.017, 0.006, -0.002]^T$$

Moreover, due to the meaning of our variables we have the following constraints regarding the three inputs: $u_1 \in [0, 0.3]$, $u_2 \leq [0, 0.008]$, $u_3 \leq [0, 0.008]$. Details about these limits are given below.

For the sake of better presenting our results, throughout all the evaluation procedure we will consider the same simulation time, namely 50 time points (i.e. quarters).

1) Variation of ρ without Constraints on Input Signals:

Let us first discard the limitations on the control signal in order to observe the behavior of the control system as well as its limitations for different values of ρ . The output (i.e. y_1) is illustrated in Fig. 5a for $\rho \in \{1, 10, 100\}$. A more detailed result is showed in Tab. II where the settling time as well as the variation range of the output are given. For the time being, the reader can just ignore the result of "1 with constraint" which will be detailed later on. From these results, we can clearly conclude that increasing the ρ value will also increase the convergence time to the state-space. Nevertheless, this comes with a significant impact on the inputs.

As we expected, the benefits of decreasing ρ come with cost, translated by the fact that the input exceeds the maximum allowed limits. Fig. 6a, 6b and 6c show the input signals evolution during the control. From the figures and table, we can see that when $\rho = 1$, the input signal ranges are much larger than the other two comparisons, and the maximum values are also always higher.

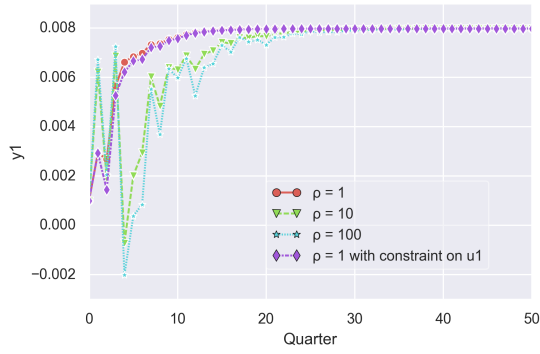

(a) Output y_1 under different ρ values

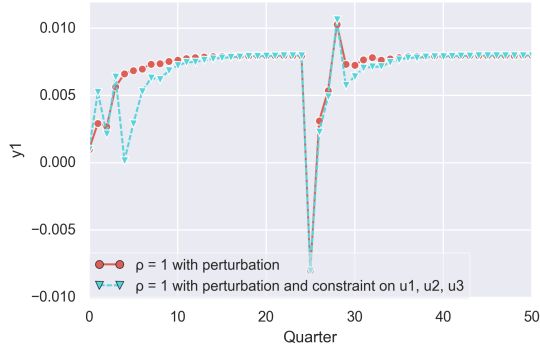

(b) Output y_1 under different ρ values

Fig. 5: Output y_1 under different ρ values

2) *Constraints on Input Signals*: In our first experiments, we do not impose constraints on input signals, but in reality, there are some levels that input signals cannot reach. Therefore, in this experiment, we set $\rho = 1$ as well as a maximum limit 0.03 on signal u_1 : $u_1 \leq 0.03$ (which is strictly lower than the maximum value of u_1 in the non-constrained case). Input signals results of " $\rho = 1$ with constraint on u_1 " are showed in Fig. 6a, 6b and 6c and Tab. III. Comparing to only $\rho = 1$ result, we can see for signal u_1 , the minimum value of the range is still 0.009, but the maximum value of the range becomes 0.03 (which is the limit) instead of 0.038. For u_2 and u_3 , the maximum value increases as they are being used to compensate for the insufficiency of u_1 . The reader should also note that for the sake of readability, all the input behavior is also detailed in Table III.

From Fig. 5a, 6a, 6b and 6c, we can observe that even u_2 and u_3 react to compensate limitation of u_1 , at 1st and 4th quarter, new results are slightly lower than the result without constraint. As for the converging speed, from Tab. II, we can also notice that experiment with constraint converges slower than the experiment without constraint. But still better than the results of $\rho = 10$ or 100.

Moreover, one thing to note is that the curves of " $\rho = 1$ with perturbation" and " $\rho = 1$ with perturbation and constraint" are overlapped during the quarter from 0 to 25. And the curves of $\rho = 1, 10, 100$ and " $\rho = 1$ with constraint" are overlapped during the quarter from 25 to 50. The signal ranges are showed

TABLE III: Summary of Input variation

ρ	input signal	signal variation range
1	u_1	(0.0163, 0.0375)
10	u_1	(0.0218, 0.0274)
100	u_1	(0.0237, 0.0245)
1 with constraint	u_1	(0.0163, 0.03)
1 with perturbation	u_1	(0.0146, 0.0375)
1 with perturbation and constraint	u_1	(0.0153, 0.03)
1	u_2	(-0.0095, 0.003)
10	u_2	(-0.0047, 0.0034)
100	u_2	(0.0017, 0.0032)
1 with constraint	u_2	(-0.0095, 0.0031)
1 with perturbation	u_2	(-0.0095, 0.0087)
1 with perturbation and constraint	u_2	(0.0, 0.0085)
1	u_3	(-0.0196, 0.0068)
10	u_3	(-0.0065, 0.0051)
100	u_3	(0.0014, 0.0034)
1 with constraint	u_3	(-0.0196, 0.008)
1 with perturbation	u_3	(-0.0196, 0.0103)
1 with perturbation and constraint	u_3	(0.0, 0.0099)

in Tab. III.

3) *Perturbation on Output Signals*: In this experiment, we still keep $\rho = 1$, and we add perturbation on output signals to simulate economic crisis, to see how the system will react. From the reference signals setting in Sec. IV-A, we know that when the system is stable, y_1, y_2, y_3 should equal to 0.008, 0.0173 and 0.0086. And u_1, u_2, u_3 should equal 0.024, 0.003 and 0.003.

From Fig. 5b, 6a, 6b and 6c, we can see that at 24th quarter, the system has converged to a stable state. **Then we add a negative perturbation pulse signal -0.16 on y_1, y_2 and y_3 at 25th quarter.** The " $\rho = 1$ with perturbation and constraint on u_i " curves are the scenario where we not only implement the perturbation, but also implement constraints on all the input signals, for u_1 limited between 0 and 0.03, u_2, u_3 are limited between 0 and 0.008: $u_1 \in [0, 0.3], u_2 \leq [0, 0.008], u_3 \leq [0, 0.008]$. " $\rho = 1$ with perturbation" experiment implements the perturbation, but has no constraints on input signals.

Fig. 5b shows that after about 20 quarters after 25th quarter, the two systems totally recover from the perturbation, apparently the curve without constraint recovers faster than the other. From Fig. 6a 6b and 6c, we can observe that the amplitude of all inputs for the experiment of " $\rho = 1$ with perturbation" is higher than " $\rho = 1$ with perturbation and constraint on u_i " (for each input). The input signal ranges shown in Tab. III also confirm that. One interesting point in Fig. 6b and 6c reveal that if we do not impose constraint on input signals, inputs u_2 and u_3 can be negative, recall that u_2 represents the first difference of logarithm of Gross Fixed Capital Formation (also called investment). A negative signal means instead of investing during the crisis, we should sell our assets. As u_3 represents the first difference of logarithm of Public Expenditure, negative means we need to reduce government spending. Nevertheless, all these conclusions, although correct from the engineering point of view, need to be coordinated with expert's advice.

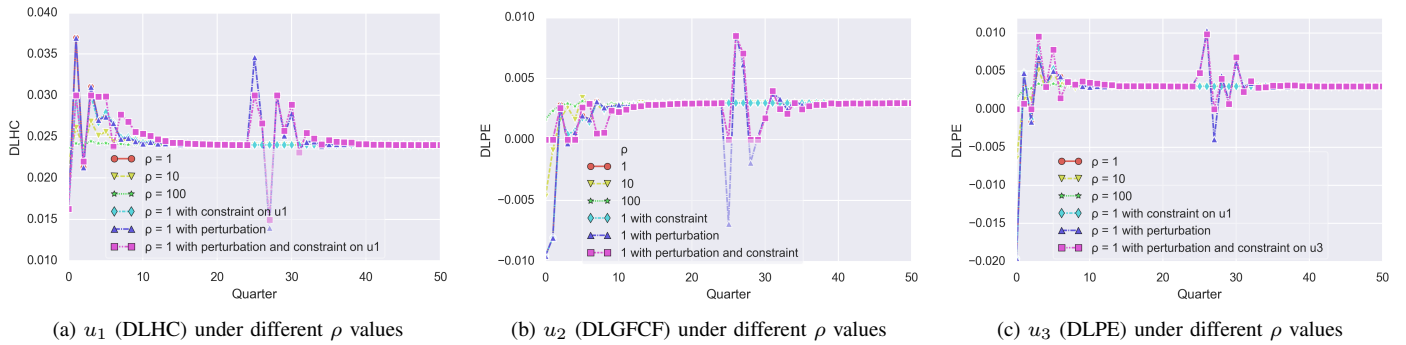

Fig. 6: Input traces under different ρ values

V. CONCLUSION

Applying control theory to economic problems has been successfully studied in many cases, resource allocation is one of the well-established problems in this area. It demands dynamically choosing available resources with constraints over time to maximize or minimize an objective function.

In this paper, to apply optimal control, French macroeconomic quarterly data from 1980T1 to 2018T4 are used. It consists of 6 variables: GDP (Gross Domestic Production), EXP (Exportation), IMP (Importation), HC (Household Consumption), GFCF (Gross Fixed Capital Formation) and PE (public expenditure). Three canonical input-output models are estimated, which first difference of natural logarithm of GDP, EXP and IMP are endogenous variables (outputs), and first difference of natural logarithm of HC, GFCF and PE are exogenous variables (inputs). We first estimate the order of each equation, then the parameters. Once the residuals of models pass the whiteness test, we transfer the models to a state-space model.

After estimating the model, an optimal control solution: (Linear–Quadratic regulator) LQR is designed for our problem which is to maintain a constant GDP increasing ratio at a certain level. The algorithm is developed on Simulink. The experiments with or without constraints on input signals are both implemented: 1) The results without constraints on input signals show that a lower parameter ρ in LQR will lead to a faster convergence to state-space; 2) For experiment with constraints on inputs, we impose a limitation on the maximum value that first difference of natural logarithm of HC can reach. The result shows that when one input cannot reach the level it used to reach, other inputs will compensate for this absence. This action will force other input signals to reach an even higher level, and the final result of output is still slightly worse than the experiment without constraint as we expected.

Perturbations on outputs are also studied, and the experiments are also developed with and without constraints on input signals. Results show that our system can quickly recover from the disturbance. And constraints on input signals can delay the recovery.

The control structure designed in this paper has good applicability and extensibility in economics. This work can be

further extended with more variables, the constraints are also not limited to only the range of input signals, it can impose the constraints on inputs and outputs subject to a specific model of the dynamics of the macro-economy.

ACKNOWLEDGMENTS

This work has been funded by the French LabEx PERSYVAL-Lab (ANR-11-LABX-0025-01).

This work has been partially supported by MIAI@Grenoble Alpes, (ANR-19-P3IA-0003)

REFERENCES

- [1] B. Anderson and J. Moore. *Optimal Control: Linear Quadratic Methods*. Dover Books on Engineering. Dover Publications, 2007.
- [2] C. Araujo, J.-F. Brun, and J.-L. Combes. *Econométrie*. Amphi Économie. Bréal, 2004.
- [3] G. Baiocchi and W. Distaso. GRETL: Econometric software for the GNU generation. *Journal of Applied Econometrics*, 18(1):105–110, 2003.
- [4] O. J. Blanchard. The production and inventory behavior of the american automobile industry. *Journal of Political Economy*, 91(3):365–400, 1983.
- [5] F. Brayton, T. Laubach, and D. Reifschneider. Optimal-control monetary policy in the frb/us model. *FEDS Notes*, Nov. 2014.
- [6] G. Chow. *Analysis and Control of Dynamic Economic Systems*. A Wiley publication in applied statistics. Wiley, 1975.
- [7] G. C. Chow. *Development of Control Theory in Macroeconomics*, volume 7. Springer, Dordrecht, 1987.
- [8] C. W. Clark. *Mathematical bioeconomics : the optimal management of renewable resources*. Wiley New York, 1976.
- [9] J. C. R. Dow. The optimum rate of saving. *The Economic Journal*, 69(274):353–356, 1959.
- [10] H. N. Duong and I. D. Landau. On a criterion for estimating the structure of linear mimo systems. In *European Control Conference*, Groningen, Netherlands, 1993.
- [11] B. M. Friedman. *Economic Stabilization Policy: Methods in Optimization*. North-Holland Publishing Company and American Elsevier Publishing Company, Amsterdam and New York, 1975.
- [12] A. Gelman and J. Hill. *Data analysis using regression and multilevel/hierarchical models*, volume Analytical methods for social research. Cambridge University Press, New York, 2007.
- [13] D. Georges and I. Girerd-Potin. A Discrete-Time State Observer Approach to Discovering Portfolio Holdings. In *20th IFAC World Congress (IFAC WC 2017)*, volume 50, pages 946 – 951, Toulouse, France, July 2017.
- [14] A. Ghiassi, T. Younesian, Z. Zhao, R. Birke, V. Schiavoni, and L. Y. Chen. Robust (deep) learning framework against dirty labels and beyond. In *2019 First IEEE International Conference on Trust, Privacy and Security in Intelligent Systems and Applications (TPS-ISA)*, pages 236–244. IEEE, 2019.

- [15] R. P. Guidorzi. Invariants and canonical forms for systems structural and parametric identification. *Automatica*, 17(1):117–133, 1981.
- [16] R. Hawkins, J. Speakes, and D. Hamilton. Monetary policy and PID control. *Journal of Economic Interaction and Coordination*, 10, 2014.
- [17] M. Intriligator. *The applications of control theory to economics*, volume 28, pages 605–626. Springer, Berlin, Heidelberg, 2005.
- [18] I. D. Landau and G. Zito. *Digital Control Systems: Design, Identification and Implementation (Communications and Control Engineering)*. Springer-Verlag, UK, London, 2006.
- [19] D. Léonard and N. V. Long. *Optimal Control Theory and Static Optimization in Economics*, page 117–126. Cambridge University Press, 1992.
- [20] R. M. Murray. Control and dynamical systems. <http://www.cds.caltech.edu/~murray/courses/cds110/wi06/lqr.pdf>, 2006.
- [21] M. Triantafyllou. Maneuvering and control of surface and underwater vehicles. <https://ocw.mit.edu/courses/mechanical-engineering/>, 2004.
- [22] T. Younesian, Z. Zhao, A. Ghiassi, R. Birke, and L. Y. Chen. Qactor: On-line active learning for noisy labeled stream data. *arXiv preprint arXiv:2001.10399*, 2020.
- [23] Z. Zhao, R. Birke, R. Han, B. Robu, S. Bouchenak, S. B. Mokhtar, and L. Y. Chen. Enhancing robustness of on-line learning models on highly noisy data. *IEEE Transactions on Dependable and Secure Computing*, 18(5):2177–2192, 2021.
- [24] Z. Zhao, S. Cerf, R. Birke, B. Robu, S. Bouchenak, S. B. Mokhtar, and L. Y. Chen. Robust anomaly detection on unreliable data. In *49th Annual IEEE/IFIP International Conference on Dependable Systems and Networks, DSN 2019, Portland, OR, USA*, pages 630–637, 2019.
- [25] Z. Zhao, S. Cerf, B. Robu, and N. Marchand. Feedback control for online training of neural networks. In *IEEE Conference on Control Technology and Applications*, pages 136–141, Hong Kong, SAR, China, 2019.
- [26] Z. Zhao, S. Cerf, B. Robu, and N. Marchand. Event-based control for online training of neural networks. *IEEE Control Systems Letters*, 4:773–778, 2020.