



HAL
open science

Energy management strategy of Supercapacitor/Fuel Cell energy storage devices for vehicle applications

Ali Djerioui, Azeddine Houari, Samir Zeghlache, Abdelhakim Saim, Mohamed Fouad Benkhoris, Tedjani Mesbahi, Mohamed Machmoum

► To cite this version:

Ali Djerioui, Azeddine Houari, Samir Zeghlache, Abdelhakim Saim, Mohamed Fouad Benkhoris, et al.. Energy management strategy of Supercapacitor/Fuel Cell energy storage devices for vehicle applications. International Journal of Hydrogen Energy, 2019, 44 (41), pp.23416 - 23428. 10.1016/j.ijhydene.2019.07.060 . hal-03628510

HAL Id: hal-03628510

<https://hal.science/hal-03628510>

Submitted on 20 Jul 2022

HAL is a multi-disciplinary open access archive for the deposit and dissemination of scientific research documents, whether they are published or not. The documents may come from teaching and research institutions in France or abroad, or from public or private research centers.

L'archive ouverte pluridisciplinaire **HAL**, est destinée au dépôt et à la diffusion de documents scientifiques de niveau recherche, publiés ou non, émanant des établissements d'enseignement et de recherche français ou étrangers, des laboratoires publics ou privés.



Distributed under a Creative Commons Attribution - NonCommercial 4.0 International License

Energy Management Strategy of Supercapacitor/ Fuel Cell Energy Storage Devices for Vehicle Applications

Ali DJERIOUI^{(a)(b)}, Azeddine HOUARI^(b), Samir ZEGHLACHE^(c), Abdelhakim SAIM^(d), Mohamed Fouad BENKHORIS^(b), Tedjani MESBAHI^(e), Mohamed MACHMOUM^(b)

(a) LGE, Laboratoire de Génie Electrique, University Mohamed Boudiaf of M'Sila, BP 166 Ichbilia, MSila, Algeria

(b) IREENA Laboratory, University of Nantes, Saint-Nazaire, France

(c) LASS, Laboratoire d'Analyse des Signaux et Systèmes, University Mohamed Boudiaf of M'Sila, BP 166 Ichbilia, Msila, Algeria

(d) LSEI Laboratory, University of Sciences and Technology Houari Boumediene (USTHB), Bab Ezzouar, Algiers, Algeria

(e) INSA Strasbourg, ICube (UMR CNRS 7357), France

Abstract

This paper addresses the management of a Fuel Cell (FC) – Supercapacitor (SC) hybrid power source for Electric Vehicle (EV) applications. The FC presents the main energy source and it is sustained with SCs energy storages in order to increase the FC source lifespan by mitigating harmful current transients. For this aim, the reported work proposes a Grey Wolf Optimizer (GWO) for an efficient power management of the studied hybrid power system. The key idea of the proposed approach is to incorporate the benefit of the GWO in terms of fast optimization and convergence accuracy, in order to achieve efficient energy sources exploitation and provide the desired driving performances. Simulations and experimental results verify the validity of the proposed management algorithm.

Keywords: Energy Management System (EMS), Fuel-Cell (FC), Supercapacitor (SC), Grey Wolf Optimizer (GWO), Electric Vehicle (EV).

I. Introduction

Recently, because of the increasing global warming concerns, the development of electric vehicle (EV) applications is gaining increased attention due to their benefits in reducing carbon and greenhouse gases emissions. Indeed, the world is moving toward the development of proper vehicular applications using low emission electric drive and power electronics technologies. To achieve satisfactory driving performances, EVs require energy source and storage systems such as, Batteries, Supercapacitors (SCs), and Fuel Cells (FCs) with advanced management strategies. The development of energy

management strategies (EMSs) for FC installations provides advantages to improve power quality export, flexibility and reliability [1]. The coupling of FC sources to SC storage systems is particularly important to satisfy transit power demands and provide vehicles with sufficient energy and power density to achieve appropriate driving performances [2]. Indeed, on the one hand, FCs sources can ensure an uninterrupted power supply when sufficient fuel (gases and hydrogen) quantity is available. However, these energy sources can present a relatively slow transient dynamic due to the time response of the gas supply system. On the other hand, SCs energy storage systems can ensure a high instantaneous power during short periods of time, but present lower energy density compared to other classical storage elements (batteries)[3][4][5].

Different EMSs for FC based hybrid energy systems have been reported in the literature [6][7][8][9][10]. These methods can be classified in four categories including rule-based methods, controller methods, filter and optimization based methods. Rule-based techniques are mainly based on State Machine, Fuzzy Logic, and Neural Networks [8][11]. For State Machine control [8]-[9], each rule or state is defined either heuristically or empirically. Besides, Fuzzy Logic rule-based methods associate membership functions to the inputs and the outputs in order to achieve the desired performance. The performances of rule-based methods relate to knowledge of the system. For controllers based EMSs, the main idea is to use control laws to compensate the error between the desired references and the actual states. Several energy management based controllers can be found in the literature, including Proportional–Integral (PI) control [12], Flatness based control [13][14], Passivity control [15], H-infinity control[16], Sliding control[17], Backstepping[18], and so on. These methods can achieve exact calculation of the reference taking into account system losses even under unknown operating point. Filter methods adopt a frequency decoupling approach considering the dynamic proprieties and the physical characteristics of the energy system. This is achieved using Low-Pass filter [19], Wavelet [20], or Fast Fourier Transform techniques [21]. The Filter based management strategy is simple and can improve significantly the lifetime of the FC system when the system frequencies are correctly identified. Recently, optimization based methods are explored to handle complex management objectives (cost, efficiency, lifespan,...). In such strategies, the desired references result from the minimization of an

instantaneous cost function. In the literature, the reported strategies include Model Predictive Control [22], Stochastic Dynamic Programming [23], Neural Networks [12], Adaptive Optimal Control [24], and Particle Swarm Optimization [26][27]. These strategies are complex and require large computation burden, which could potentially affect the response time of the energy management system.

In this work, a Grey Wolf Optimizer (GWO) based EMS is proposed for EV applications with hybrid FC-SC energy system. The GW-Optimizer is a new meta-heuristic algorithm that was initially proposed by Mirjalili [28]. This algorithm simulates the hunting behavior of grey wolves in nature. As its name implies, the GWO mimics the grey wolves' social hierarchy and the major hunting steps namely seeking for prey, encircling, and attacking. The GWO moves the wolves (search agents) toward prey by updating the location vector, which is an average of the group best locations. This algorithm has attracted the interest of several researchers in different field of applications since it presents several advantages compared to other optimization algorithms. These advantages are highlighted in [28] wherein a comparative study with different optimization algorithms demonstrated that the GW-Optimizer shows enhanced performances in terms of low computing complexity, solution accuracy, and global convergence. The GW-Optimizer has been already applied to deal with optimization problems in power systems [29][30][31][32][33]. For example, this algorithm is used to optimize the allocation of multiple distributed generation units in microgrids [31], to solve active power dispatch problems [32][34], and to minimize voltage harmonics in multilevel inverters [30].

In this paper, a GW-Optimizer based EMS is proposed to optimize the energy utilization of energy storages in EV applications. Indeed, an advanced EMS is proposed to manage the power between the FCs energy source and SCs under constraining conditions, namely time response and state of charge. The GWO acts to find the optimal management reference that minimize the fitness function with respect to the aforementioned constraints, and ensure the desired driving performances. The objective is also to provide the electric drive with sufficient power on demand and protect the energy source and storage system against transient currents.

This paper is organized as follows. A description of the studied system and its control

are presented in section II. In section III, the design principle of the proposed energy management strategy is provided. Finally, in section IV, simulations and experimental results validate the effectiveness of the proposed method.

II. Description of the hybrid energy system

The circuit configuration of the studied system is shown in Fig. 1. The FC and SCs are connected to a common DC-bus through an interleaved unidirectional boost converter and a bidirectional buck-boost converter, respectively. The interleaved DC-DC converters are considered in order to minimize current ripples at the input of the energy source. In this way, the input current can be shared between converters legs, which improves the heat dissipation capacity of the system. The inductances values are assumed to be equal.

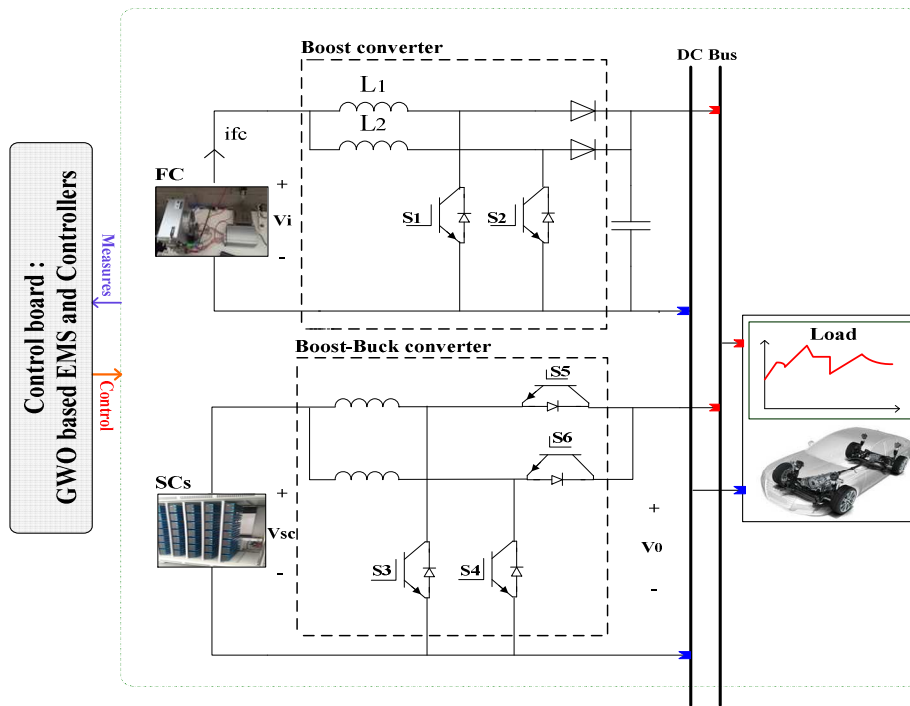

Fig. 1. Topology of the studied hybrid energy system.

A. Fuel Cell modeling

The FC is used to convert a chemical energy of reactant into electricity [35][36] [37][38][39]. In this study, a Proton Exchange Membrane Fuel Cell (PEMFC) is considered as the main energy source in the EV system. The output voltage of a single cell is expressed as follows [40].

$$V_{FC} = E_n - V_{act} - V_{ohmic} - V_{con} \quad (1)$$

where, E_n , V_{act} , V_{ohmic} and V_{con} represent, respectively, the Nernst voltage, and the activation, ohmic, and diffusion losses.

The Nernst voltage can be written as in [2].

$$E_n = \begin{cases} 1.299 + (T - 298) \frac{-44.43}{2F} + \frac{RT}{2F} \ln(P_{H_2} P_{O_2}^{1/2}) & \text{when } T \leq 100^\circ C \\ 1.299 + (T - 298) \frac{-44.43}{2F} + \frac{RT}{2F} \ln\left(\frac{P_{H_2} P_{O_2}^{1/2}}{P_{H_2O}}\right) & \text{when } T > 100^\circ C \end{cases} \quad (2)$$

where, R represents the gas constant (8.3145 J/mol K), T is the temperature of operation (Kelvin), F is the Faraday constant (96485 A s/mol), P_{H_2} is the hydrogen partial pressure (atm), and P_{O_2} is the partial oxygen pressure (atm).

The ohmic losses can be expressed as follows:

$$V_{ohmic} = R_{FC} i_{FC} \quad (3)$$

where, R_{FC} is the FC resistance, and i_{FC} is the FC current.

The relationship between activation losses and current densities, namely i_{FC} and i_0 , can be determined using the Tafel equation as follows [41]:

$$V_{act} = A \ln\left(\frac{i_{FC}}{i_0}\right) \quad (4)$$

where, A is a constant term that is higher for slow electrochemical reaction.

The diffusion losses can be expressed as follows:

$$V_{conv} = m e^{(n i_{FC})} + b \ln\left(\frac{P_{O_2}}{a}\right) \quad (5)$$

where, m, n, b and a are empirical coefficients that take into account the different polarization effects.

For standard operations, the hydrogen consumption rate of a FC is related to the current flow (i_{FC}). Therefore, the hydrogen consumption rate C_{H_2} is calculated as follows:

$$\square_{H_2} = \frac{i_{FC} N}{2F} \quad (6)$$

where, N is the number of cells.

The FC efficiency is theoretically defined as a ratio between the useful produced energy (electrical energy) and the energy input (enthalpy of hydrogen). The theoretic FC

efficiency can be calculated by:

$$\eta = \frac{\Delta G}{\Delta \zeta_{FC}} \quad (7)$$

Where ΔG is the enthalpy of hydrogen and $\Delta \zeta_{FC}$ is the produced electrical energy.

The FC efficiency decreases as long as the temperature increases, and can almost reach 83% at 25 °C [41][42]. The FC efficiency is based on the calculation of the enthalpy, which can be complex in practical operations. In this way, a simplified approach is proposed in [43], wherein the FC efficiency is only estimated based on the voltage measurement and the fuel utilization rate estimate.

The FC efficiency is referred as voltage efficiency and it is expressed bellow:

$$\eta_{FC_v} = \mu_F \frac{V_{FC}}{E_{th}} \quad (8)$$

where, μ_F is a fuel utilization rate that is commonly close to 0.95. E_{th} is the thermoneutral potential and its value depends in the hydrogen's heating value. The thermoneutral potential is equal to 1.462 V for the higher heating value (HHV), and 1.254 V for the lower heating value (LHV). In this work, the Horizon H-2000 PEM Fuel Cell is used. Its consists of a 2 kW self-humidified hydrogen FC with 48 cells. The efficiency of the FC at the rated conditions (28.8 V - 70 A) is about 40% [44]. The polarization and power curves various FC current are shown in Fig. 2.

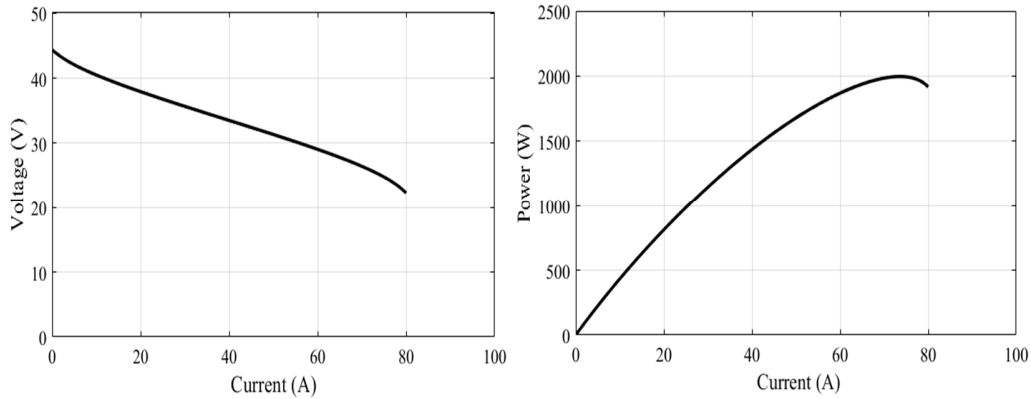

Fig. 2. FC voltage and power characteristics various the FC current.

B. Supercapacitor modeling

The supercapacitor is modeled as a simple RC circuit by the following equations:

$$U_{SC} = \frac{Q_T}{C_{SC}} - R_{SC}i_{SC} \quad (9)$$

where, R_{SC} is the internal resistance and C_{SC} is the cell capacity. The detailed modeling procedure can be found in [2].

The cell terminal voltage depends on the current demand and the SC State of Charge (SOC). The SOC of the SC can be obtained as follows:

$$SOC_{SC}(\%) = \frac{(Q_{int} + \int i_{SC} dt)}{C_{SC} \cdot V_{rated}} 100 \quad (10)$$

where, Q_{int} and V_{rated} represent the initial electric charge and the rated cell voltage, respectively.

C. Converter modeling

The interleaved converters are primarily controlled with an inner current control loop to achieve satisfactory dynamic and provide the system with sufficient protection [2].

Assuming that the currents i_{SC} and i_{FC} are tightly controlled to follow their respective references i_{SC}^{REF} and i_{FC}^{REF} . In this way, the currents expressions can be defined as follows:

$$i_{FC} = i_{FC}^{REF} = \frac{P_{FC}}{V_{FC}} = \frac{P_{FC}^{REF}}{V_{FC}} \quad (11)$$

$$i_{SC} = i_{SC}^{REF} = \frac{P_{SC}}{V_{SC}} = \frac{P_{SC}^{REF}}{V_{SC}} \quad (12)$$

where, P_{SC}^{REF} and P_{FC}^{REF} represent the SC and FC power references, respectively.

These converters are modeled as a reduced order model that considers only the FC and SCs converters static losses, r_{SC} and r_{FC} , respectively.

The DC-bus capacitive energy ζ_{Bus} and the SCs energy ζ_{SC} can be written as follows:

$$\zeta_{Bus} = \frac{1}{2} C_{Bus} v_{Bus}^2 \quad (13)$$

$$\zeta_{SC} = \frac{1}{2} C_{SC} v_{SC}^2 \quad (14)$$

The total electrostatic energy ζ_T stored in the DC-bus capacitor C_{Bus} and in the SCs can be written as follows:

$$\zeta_T = \frac{1}{2} C_{Bus} v_{Bus}^2 + \frac{1}{2} C_{SC} v_{SC}^2 \quad (15)$$

The differential equation describing the DC-bus capacitive energy ζ_{Bus} is given below in function of the FC power P_{FC} , the SC power P_{SC} , and the load power P_{Load} .

$$\dot{\zeta}_{Bus} = P_{FC} - r_{FC} \left(\frac{P_{FC}}{v_{FC}} \right)^2 + P_{SC} - r_{SC} \left(\frac{P_{SC}}{v_{SC}} \right)^2 - P_{Load} \quad (16)$$

where,

$$P_{Load} = v_{Bus} \cdot i_{Load} = \sqrt{\frac{2\zeta_{Bus}}{C_{Bus}}} \cdot i_{Load} \quad (17)$$

$$P_{SC} = v_{SC} \cdot i_{SC} = \sqrt{\frac{2\zeta_{SC}}{C_{SC}}} \cdot i_{SC} \quad (18)$$

To provide the system with power limitation capabilities and sufficient protection, a current limiter is added as follows:

$$i_{SC \min}(t) \leq i_{SC}(t) \leq i_{SC \max}(t) \quad (19.1)$$

$$0 \leq i_{FC}(t) \leq i_{FC \max}(t) \quad (19.2)$$

The SC current limitation function acts to limit the current reference to the interval $[i_{SC \min}, i_{SC \max}]$, where, $i_{SC \max}$ and $i_{SC \min}$ represent the maximum charging and discharging current, respectively.

II. Energy system control

As shown in Fig. 3, the proposed control strategy adopts a hierarchical structure with two levels and multiple control loops.

The First level is dedicated to the SC control and consists of two nested loops wherein the control of the DC bus voltage is done through the control of the SC current participation. Indeed, an external DC voltage loop is used to calculate the SC current reference to the inner current control loop using Proportional Integral (PI) regulators. This control scheme allows maintaining the DC bus voltage within acceptable ranges with an effective control of the SC current participation and sufficient over-current protection to preserve the system.

The Second level is dedicated to the FC management, which is based on the GW-Optimizer that is used to calculate the optimal FC current reference in such a way to

minimize both SC and DC bus energy error. The design principle of the GW-Optimizer is detailed in the following section. Indeed, the GW-Optimizer calculates the FC power correction effort v that minimizes the DC bus energy error and SC energy error. The resulting FC power correction effort is then used to calculate the optimal FC reference current with respect to the FC power range. The control of the FC current is achieved based on a PI regulator, which provides the FC with sufficient protection against current transients and minimizes the risk of gas starvation and overheating problems. Indeed, the FC power reference is first derived with regard to the maximum power capability of the FC (20).

$$P_{FC}^{Max} = \frac{v_{FC}^2}{4r_{FC}} \quad (20)$$

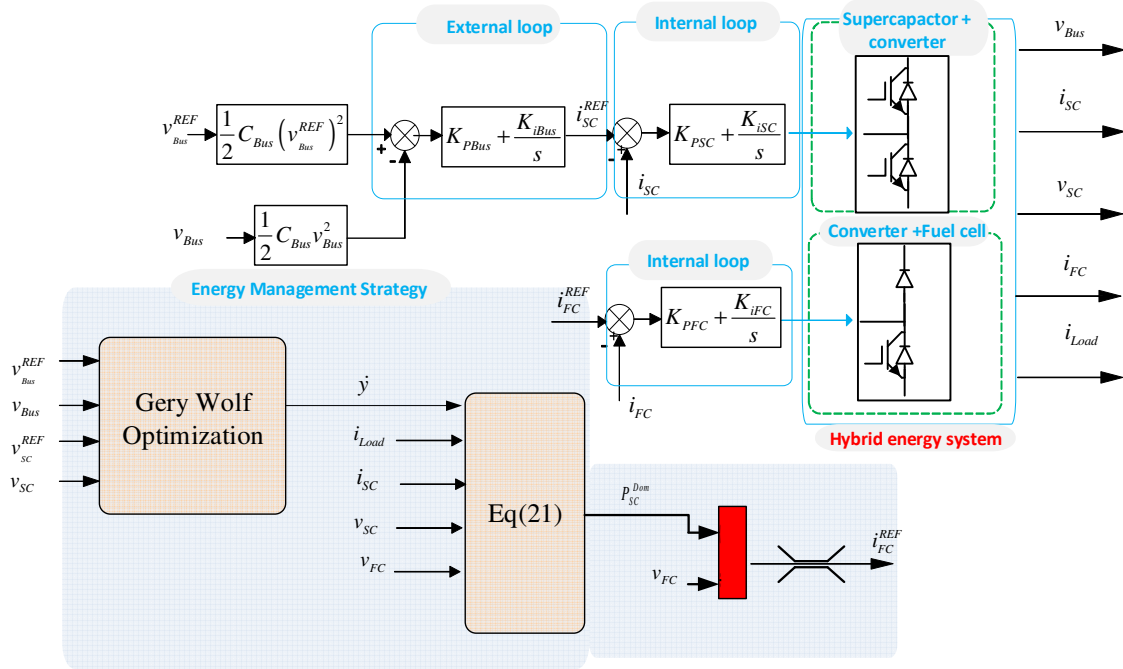

Fig.3. Control structure of the proposed EM-Strategy.

The calculation of the FC power reference is done through the resolution of the second order polynomial equation (16), considering equations (17) and (18), where the FC power is the variable.

$$P_{FC}^{Ref} = 2P_{FC}^{Max} \left(1 - \sqrt{1 - \frac{(r_{sc} i_{sc}^2 - (i_{sc} \sqrt{2\zeta_{sc}} / C_{Bus} + (i_{load} \sqrt{2\zeta_{Bus}} / C_{Bus} + v))}{P_{FC}^{Max}}}} \right) \quad (21)$$

Accordingly, the FC current reference is calculated as follows:

$$i_{FC}^{Ref} = \frac{P_{FC}^{Ref}}{V_{FC}} \quad (22)$$

IV. Grey Wolf based energy management strategy

The aim of this part is to detail the design method of the GW-Optimizer. The proposed EMS scheme is shown in Fig.3. The GW-Optimizer is chosen because of its usefulness in solving constrained problems with attractive convergence performances. In this work, the merits of this algorithm are devoted to find the optimal FC power correction effort (v) through the minimization of the system stockers' energy, namely the energy of the DC-bus and SCs. Indeed, an objective function that considers the DC-bus energy error and SCs energy error is proposed as expressed in (23).

$$J_{GWO} = \lambda_1 (\Delta\zeta_{SC} [k] + \Delta\zeta_{Bus} [k]) + \lambda_2 T_s (\Delta\zeta_{SC} [k-1] + \Delta\zeta_{Bus} [k-1]) \quad (23)$$

where, $\Delta\zeta_{SC} = \zeta_{SC}^{REF} - \zeta_{SC}$ is the SCs energy error, and $\Delta\zeta_{Bus} = \zeta_{Bus}^{REF} - \zeta_{Bus}$ is the DC-bus energy error. λ_1 and λ_2 represent the weighting coefficients whose design is presented in next section. T_s is the sample time.

As shown in Fig. 3, the GWO acts to find the optimal FC power correction effort (v) in such a way to minimize the error ($\Delta\zeta_{Bus} = \zeta_{Bus}^{REF} - \zeta_{Bus}$) between the DC-bus capacitive energy and its reference ζ_{Bus}^{REF} , and the error ($\Delta\zeta_{SC} = \zeta_{SC}^{REF} - \zeta_{SC}$) between the SCs energy and its reference ζ_{SC}^{REF} . The idea is to manage the system around a desired equilibrium that enhances the system performance. For that, the energy error is computed at the iteration (k) and at the previous iteration (k-1). The effort provided by the term at (k-1) can be considered as a memory with a forgetting factor that gives additional support to the term at (k) for robustness enhancement and tracking error reduction. However, the contribution of the (k-1) term is weighted to be significantly lower than the term at (k) in such a way to preserve the behavior of the dynamic system.

The proposed objective function is subject to the following constraint: $|\Delta P_{Load}/T| < 0.05$ where ΔP_{Load} represents the load power variation between iterations (k) and (k-1), and T is the sampling time. The main purpose of this constraint is to maintain the updating dynamic of the optimal FC power correction effort (v) within tolerable ranges essentially under sudden load changes. Therefore, this constraint is designed to act as a low pass

filter for sudden load changes. The constant limit of 0.05 is obtained when considering that the FC generates 2 kW within 4s duration. This constant can vary in function of FC technology.

The design procedure of the GWO consists of three steps. The first step, called “Encircling” depends on the iteration number to evaluate the whole hunting solutions. In the second step, called “Hunting”, the three best solutions are selected to evaluate the attacking candidate. Finally, the decision phase, called “Attacking”, the attacking candidate is checked, and then the best attacking solution is employed.

The prey encircling step is modeled mathematically as follows:

$$\begin{aligned}
 J_{GWO}(\chi^\alpha(k)) &= \min_{i=1\dots N} \left\{ J_{GWO}(\chi_i(k)) \mid \chi_i(k) \in \Theta_\rho \right\}, \\
 J_{GWO}(\chi^\beta(k)) &= \min_{i=1\dots N} \left\{ J_{GWO}(\chi_i(k)) \mid \chi_i(k) \in \Theta_\rho - \{\chi^\alpha(k)\} \right\}, \\
 J_{GWO}(\chi^\delta(k)) &= \min_{i=1\dots N} \left\{ J_{GWO}(\chi_i(k)) \mid \chi_i(k) \in \Theta_\rho - \{\chi^\alpha(k), \chi^\beta(k)\} \right\},
 \end{aligned} \tag{24}$$

Where χ^α , χ^β and χ^δ are the three best solutions that fulfill the following condition at the iteration (k).

$$J_{GWO}(\chi^\alpha(k)) < J_{GWO}(\chi^\beta(k)) < J_{GWO}(\chi^\delta(k)) \tag{25}$$

After that, a set of search coefficients is defined as follows:

$$\begin{aligned}
 q_r^f(k) &= q^f(k)(2\ell_{1r}^f - 1) \\
 \lambda_r^f(k) &= 2\ell_{2r}^f(k), r \in \{\alpha, \beta, \delta\}
 \end{aligned} \tag{26}$$

where, the coefficients q_r^f are linearly decreased from 2 to 0 according to iterations, while the coefficients ℓ_{1r}^f and ℓ_{2r}^f are random vectors in [0, 1], and r is the number of the hunters.

1) The hunt is guided by the leader search agents, i.e. alpha, beta then delta, since they present better knowledge about the potential location of the optimal solution. the other search agents should update their positions according to the position of best search agent. the update of their agent position can be formulated as follows:

$$d_i^{lf} = \left| \lambda_r^f(k) \chi^{lf}(k) - \chi^f(k) \right|, i = 1 \dots N, l \in \{\alpha, \beta, \delta\} \tag{27}$$

$$\chi^{rf}(k+1) = \chi^{rf}(k) - q_r^f(k) d_r^{if}(k), i = 1 \dots N, r \in \{\alpha, \beta, \delta\}$$

Finally, by the use of the predefined agent position, the reference power for FC source is calculated by:

$$\chi^{rf}(k+1) = (\chi^{\alpha f}(k+1) + \chi^{\beta f}(k+1) + \chi^{\delta f}(k+1)) / 3, \quad (28)$$

1) Exploration and exploitation of the obtained solutions is verified through the adaptive values of the distance q_r^f , which allows the GWO to smoothly transit between exploration and exploitation. At this level, when decreasing q_r^f , half of the iterations are devoted to exploration and the other half is dedicated to exploitation.

The pseudo code of the GW-Optimizer is given bellow.

Random initialization of the grey wolf population
While $k < k_{max}$
 Calculate the fitness of each agent
 x^α, x^β and x^δ are respectively the best, the second best and the third best agents
 Random generation of r_1 and r_2 .
 Calculation of q_r^f and λ_r^f
 For each agent update its position
 Decrease a
End while
 Return $\chi^\alpha \rightarrow \Delta y_i^{ref} = \chi^\alpha$

V. Simulation Results

In this part, simulation tests are conducted within a small-scale simulator in order to evaluate the impact of the proposed EM-Strategy on the behavior of the studied hybrid energy system and its performances under representative loading conditions. The system, shown in Fig. 1, is simulated using SimPower blocks in MATLAB/Simulink. In these tests, the DC-bus voltage is controlled to 80 V while the driving load profile is emulated. The system and control parameters are listed in Table.1. These parameters are the same then those of the experimental test bench.

Table. 1. Power system and control parameters

Fuel cell	Number of cells: 48 Rated power: 2 kW Rated voltage 28.8 V
Supercapacitor	Capacitance: 58 F Rated voltage: 32V ESR: 19 mΩ
Power stage parameters	Inductances (L1 & L2): 2 mH Resistances in series with inductors: 0.1 Ω DC bus capacitor: 20 mF
PI Control Parameters	SC controller: Outer loop: $K_{pBUS} = 0.07$, $K_{iBUS} = 250$ Inner loop: $K_{pSC} = 0.7$, $K_{iSC} = 150$ FC current controller: $K_{pFC} = 0.3$ and $K_{iFC} = 0.001$

A. GWO parameters setting

To evaluate the effect of the iteration number on the proposed algorithm convergence accuracy, the program is simulated for 10 times considering a varying number of iteration from 2 to 25. The number of search agents is set to 3. The obtained results are summarized in Fig. 4 illustrating the average, the lower and the upper values of J_{GWO} in function of the iteration number. As it can be appreciated, the optimization cost is highly related to the iteration number, and its value is significantly reduced when the iteration numbers is greater than 5.

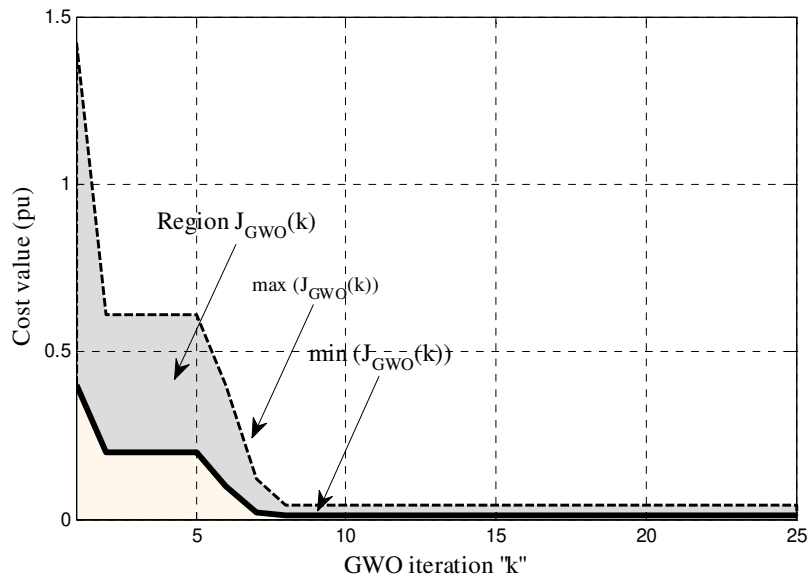

Fig. 4. Objective function cost versus the iteration number.

In this study, the GWO algorithm is coded in C-language based on 3 search agents and 7 iterations. The evaluated execution-time of the algorithm is about 31 μs with a sampling time of 100 μs .

In the following, the influence of the weighting factors on the DC-bus voltage ripple is evaluated based on the Ripple Factor (RF) defined as follows:

$$RF = \frac{V_{Bus, pk-pk}}{V_{Bus}^{REF}} * 100 \quad (29)$$

Where, $V_{Bus, pk-pk}$ is the peak-to-peak voltage and V_{Bus}^{REF} is the DC-bus voltage reference.

Fig. 5 illustrates the evolution of the voltage RF various the objective function parameters, when the weighting factors λ_1 is set to 10, and λ_2 is changed from 0 to 20. It can be seen that the RF evolution is more sensitive to the change of λ_1 and its values are minimized for λ_2 greater than 5.

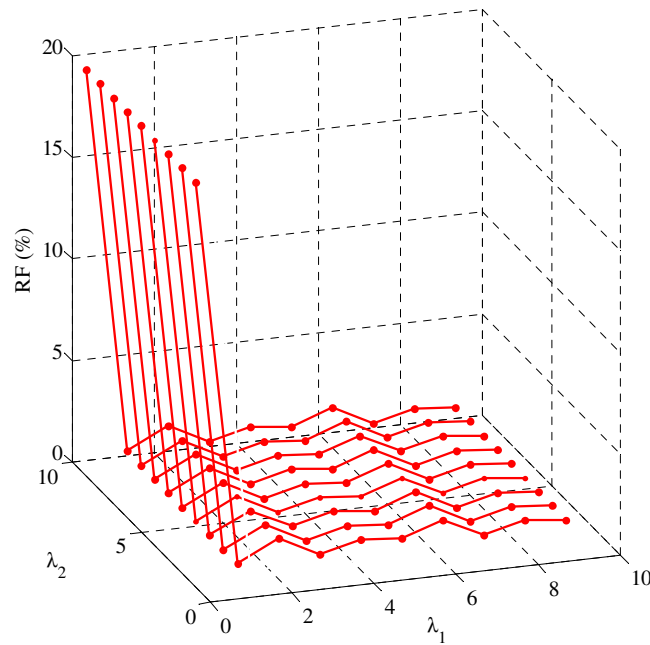

Fig. 5. Influence of the objective function parameters on the voltage RF evolution.

B. Comparative Study

To evaluate the performance of the proposed EMS, a comparison with a conventional Filter based EMS is proposed. As its name implies, the filter-based strategy synthesizes the reference using simple low-pass filter whose bandwidth is set with respect to the

dynamic of the physical system. This method is commonly used for its simplicity and efficiency [43]-[44]. In this study, the Filter based EMS calculates the FC current reference that correspond to the steady state load current and presents lower dynamic to variations.

The SC controller ensures the regulation of the DC-bus voltage in such a way to maintain the desired value and ensure fast response load solicitation. The relationship between the FC current reference and the load current is expressed in (30).

$$i_{FC_REF} = \frac{1}{(0.5s+1)(2s+1)} * \frac{i_{load}}{1-d} \quad (30)$$

where, d is the FC converter duty cycle, and i_{load} is the load current.

Fig. 6 compares the behavior of the exchanged power between the FC-SC hybrid energy source and the load using both the proposed GWO based EMS and the Filter based EMS. To illustrate the difference between the two EMSs, the load power is increased from 0.75 kW to 1.5 kW at $t = 30$ s. In this test, the initial SC SOC is equal to 92.2%. As can be appreciated in Fig. 6 (a) and (b), the SC sustains the FC energy source for transients with both EMSs. However, the power level at steady state is different between them. Indeed, the power of the SC is close to zero in steady state when using the proposed GWO based EMS while it changes according to the loading conditions when using the Filter based EMS. More specifically, the objective function (23) of the proposed GWO minimizes the SC energy, thereby minimizes the SC steady state effort and allows keeping its voltage around the desired reference. For high-power demand ($P_{load}=1.5$ kW) it can be noted that the GW-Optimizer acts on the FC to supply the load demand and compensate for the losses caused by the passive filters of the DC-DC converters. For further understanding of the system behavior, the SC SOC that results of using both the GWO based EMS and the Filter based EMS is reported in Fig. 7(a) and (b). In this result, it can be seen that the proposed algorithm allows a better SOC management especially under high power demand, namely from 30 to 60s. The SC SOC variation is minimized and kept around its reference when the proposed GWO based EMS is used while the SOC presents some variations depending on the power demand level when the Filter based EMS is used. Indeed, as it can be noticed, the SC SOC continues to be discharged under high-power demand, namely from 30 to 60 s, and this

influence can be more significant for longer durations. As a consequence of this operation behavior, the SC sizing can be reduced with the proposed GWO based EMS when keeping a good management of the hybrid energy system. This fact is very important in embedded applications where the weight and the volume are a highly constraining.

Fig 8.(a) and (b) show the voltage efficiency of FC when the fuel utilization is supposed

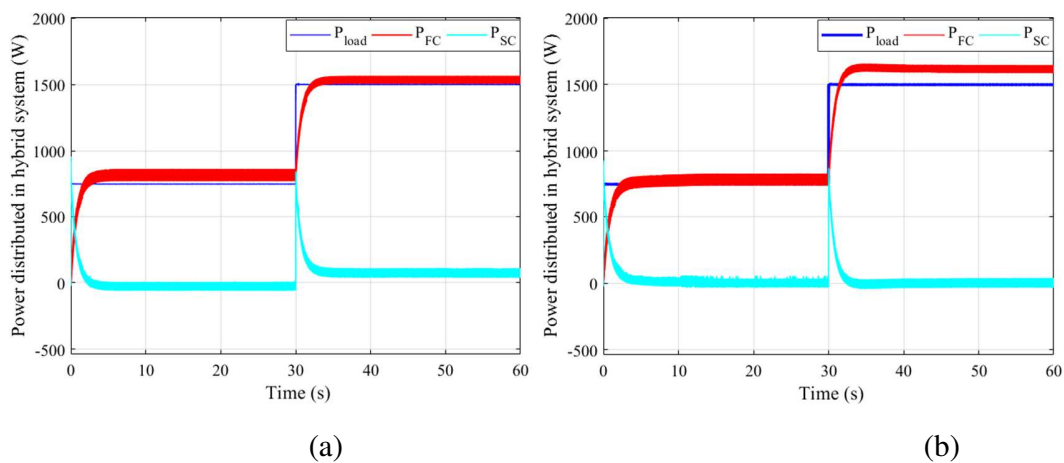

Fig. 6. Power curves in FC, SCs and load: (a) with Filter based EMS, (b) with GWO based EMS.

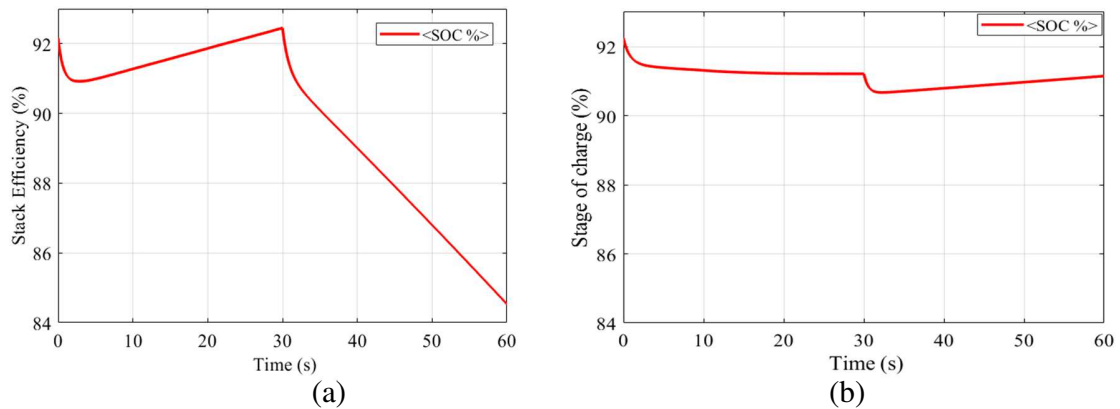

Fig. 7. State of Charge of SCs: (a) with Filter based EMS, (b) with GWO based EMS.

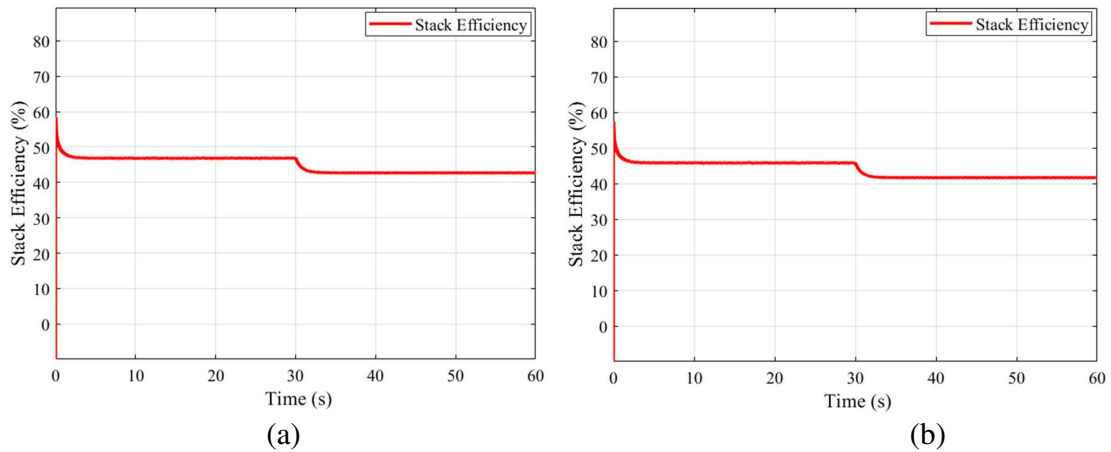

Fig. 8. Efficiency of FC: (a) with Filter based EMS (b) with GWO based EMS.

equal to 95%. The efficiency under the whole test duration is relatively the same, its value is higher with the GWO based EMS between 0 and 30 s and with the Filter based EMS between 30 and 60 s.

To verify the proposed EMS behavior under a representative EV operation, an ECE 15 urban driving cycle is performed. The corresponding speed profile is shown in Fig. 9. The power profile is characterized by repeated acceleration (positive power) and deceleration or braking (negative power) sequences, which implies a bidirectional power flow between the energy source and the drive load. As it can be appreciated in Fig. 7, the proposed EMS allows keeping the SC SOC within an acceptable range when satisfying the load demand. In contrast, the SC SOC evolution with the classical Filter based EMS increases with the repeated braking (negative power) at the risk of overcharge.

It can be noticed that the effectiveness of the employed EMS conditions the response of the hybrid energy source to varying loading conditions. Indeed, the analysis of the obtained comparison results shows that in the case of the Filter based EMS, the SOC of the SC presents large variations for long test durations, which can exceed system limitations. At this level, the SC needs to be over-sized in order to accommodate for such variations and guarantee reliable operations along with the FC under varying load profiles. Therefore, the use of an advanced EMS method like the proposed GWO based EMS can present better performances.

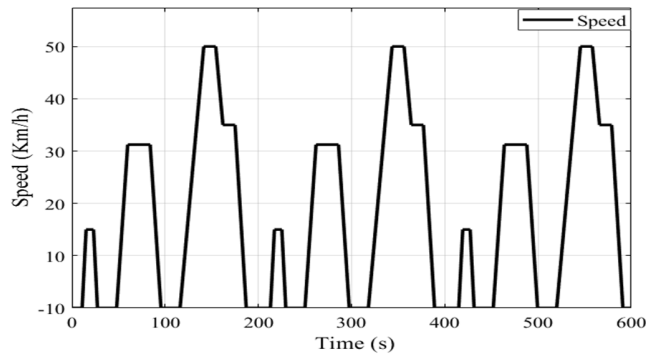

Fig. 9. Speed profile under ECE-15 driving cycle.

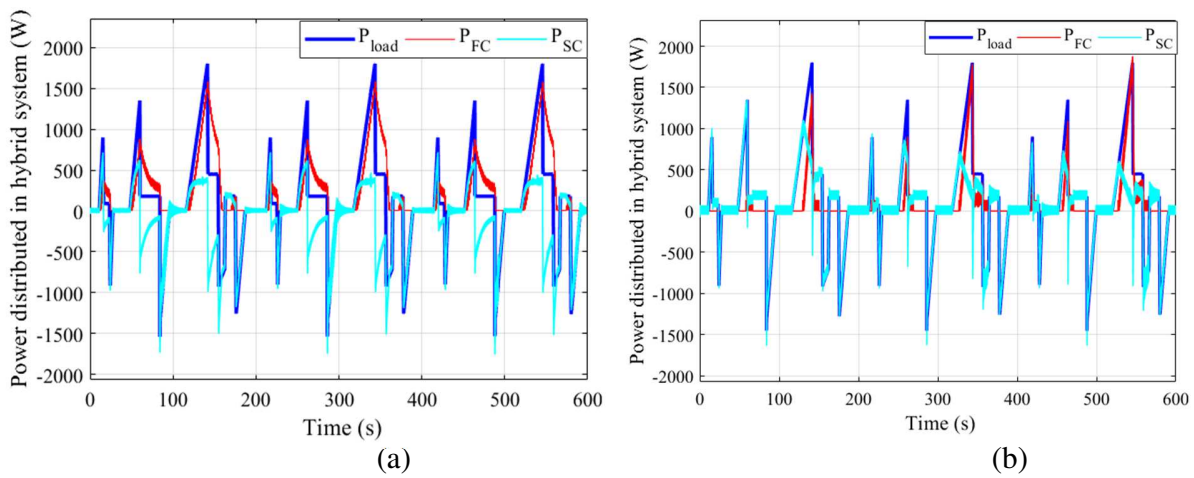

Fig. 10. Power evolution under ECE15 driving cycle: (a) with Filter based EMS (b) with GWO based EMS.

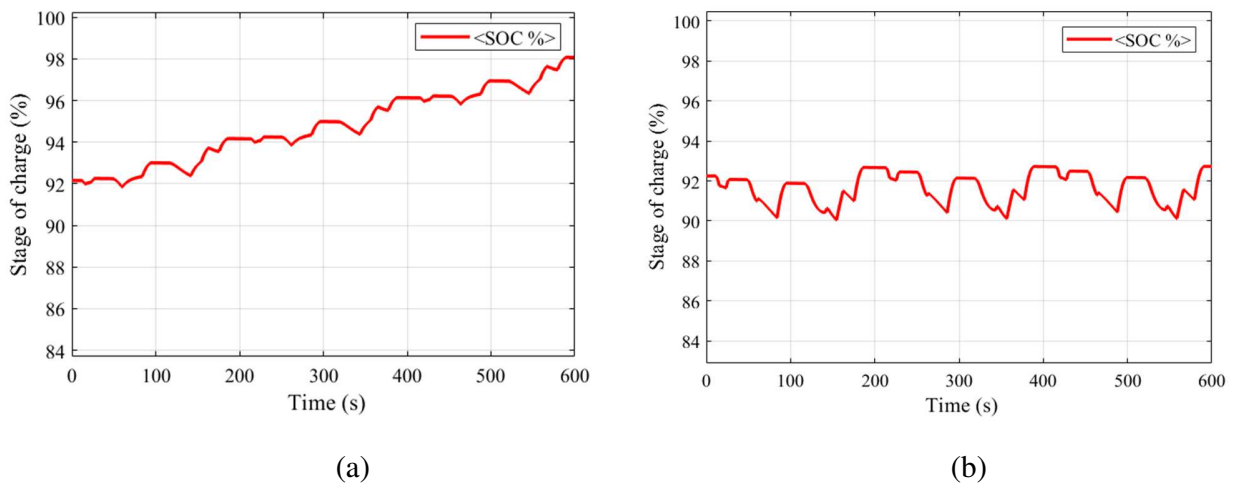

Fig. 11. SCs SOC evolution under ECE15 driving cycle: (a) with Filter based EMS (b) with GWO based EMS.

It is worth noting that EV power is commonly higher than 20 kW, whereas in this

study only a small-scale experimental bench with 2 kW FC is employed to test and compare the proposed energy management strategy.

V. Experimental validation

To check the real-time feasibility of the proposed EMS, experiments have been carried out. The experimental setup of the studied is shown in Fig. 12. The proposed EMS is implemented under a DSpace 1005 rapid prototyping system. The used hybrid sources consist of a Horizon H-2000 PEM Fuel Cell and the Maxwell SC modules. The FC and SC are interfaced to the common DC bus through Semikron converters, which are connected as shown In Fig. 1. The loading conditions are emulated by a controllable DC load.

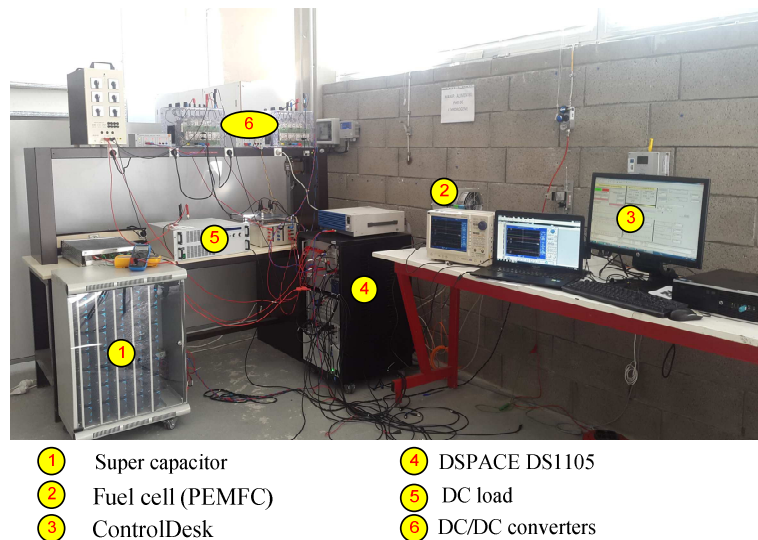

Fig. 12. Experimental test-bench of the studied system.

The GWO based EMS is evaluated under the load power profile of Fig. 13 that presents a simplified derive cycle, and the power evolution of the FC and the SC are reported respectively in Fig. 14 and Fig. 15. The provided results show that the proposed EMS allows a complementary operation of the FC and SC sources.

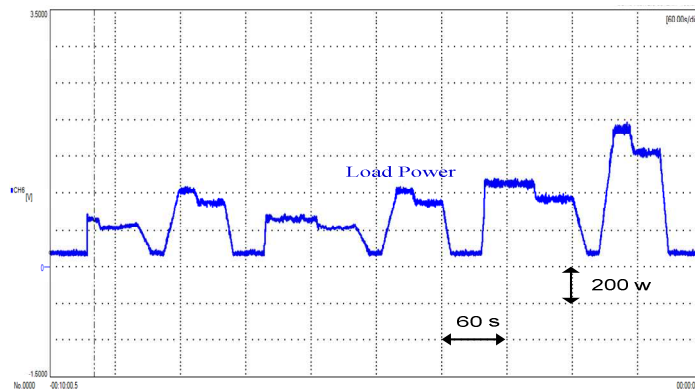

Fig. 13. Experimental result: load power profile.

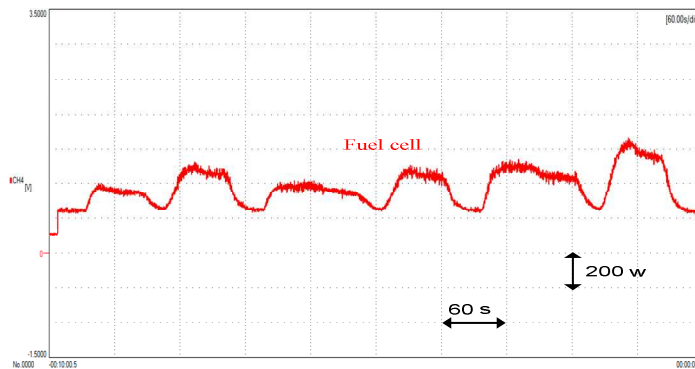

Fig. 14. Experimental result: FC power.

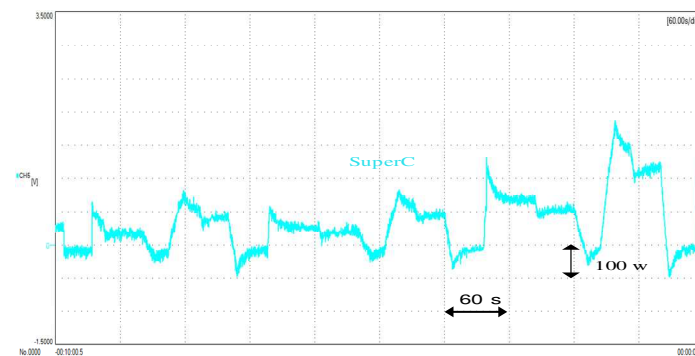

Fig. 15. Experimental result: SC power.

Indeed, a transients increase or decreases of the load power demand is satisfied with the SC power source while the steady state operation is satisfied by the FC energy source. The performance of the hybrid power system is proved to be desired under a further verification. Fig. 16 provides a zoom on the load power, the FC and SC powers. In this capture, the load demand is increased from 0.3 kW to 0.8 kW. As can be appreciated, the

proposed GWO based EMS allows to ensure a slow evolution of the FC source under a step load while the SC allows to respond to the load transient. Indeed, after a short time (about 4s), the FC is able to supply sufficient power to the load while SCs current is decreasing to 0.05 kW.

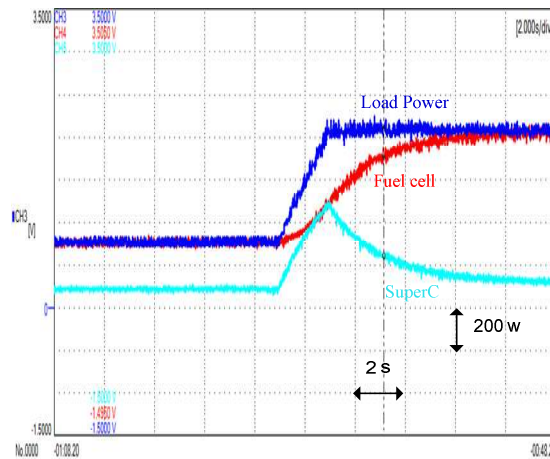

Fig. 16. Experimental result: FC and SC power responses after a load step (Zoom).

VI. Conclusion

This paper has proposed the use of a GWO based energy management strategy (EMS) for FC-SC powered electric vehicle. The proposed approach exploits the fast optimization process of the GWO algorithm in order to find the FC reference current, where the objective function minimizes the DC bus and SCs energies. The proposed strategy design is detailed and its performances are highlighted under a representative driving cycle. The analysis is supported by a comparative study with a Filter based EMS. The real-time feasibility is verified within rapid prototyping system. As perspective to this work, further researches are envisaged to include comparison with advanced management strategies.

VI. References

- [1] Hirohisa Aki, Tetsuya Wakui, Ryohei Yokoyama "Development of an energy management system for optimal operation of fuel cell based residential energy systems" International Journal of Hydrogen Energy Volume 41, Issue 44, 26 November 2016, Pages 20314-20325
- [2] A. Tahri, H. El Fadil, F. Z. Belhaj, and al « Management of fuel cell power and supercapacitor state-of-charge for electric vehicles » Electric Power Systems Research, Volume 160, July 2018, Pages 89-98
- [3] W. Wu, J. S. Partridge, R. W. G. Bucknall "Simulation of a stabilised control strategy for PEM fuel cell and supercapacitor hybrid propulsion system for a city bus" International Journal of Hydrogen Energy, In press, corrected proof, Available online 22 September 2018
- [4] W. Wu, J. S. Partridge, R. W. G. Bucknall Stabilised control strategy for

PEM fuel cell and supercapacitor propulsion system for a city bus International Journal of Hydrogen Energy, Volume 43, Issue 27, 5 July 2018, Pages 12302-12313

[5] Alireza Payman, Serge Pierfederici Farid Meibody-Tabar “Energy control of supercapacitor/fuel cell hybrid power source” Energy Conversion and Management Volume 49, Issue 6, June 2008, Pages 1637-1644

[6] Huan Li Alexandre Ravey Abdoul N'Diaye Abdesslem Djerdir “A novel equivalent consumption minimization strategy for hybrid electric vehicle powered by fuel cell, battery and supercapacitor Journal of Power Sources Volume 395, 15 August 2018, Pages 262-270

[7] Khalid Ettahir L. Boulon K. Agbossou “Optimization-based energy management strategy for a fuel cell/battery hybrid power system” Applied Energy Volume 163, February 2016 Pages 142-153

[8] Xiaohui Zhang Li Liu Yueling Dai ” Fuzzy State Machine Energy Management Strategy for Hybrid Electric UAVs with PV/Fuel Cell/Battery Power System” International Journal of Aerospace Engineering 2018, July 2018, pages 1-16

[9] Souleman Njoya Motapon ; Louis-A. Dessaint ; Kamal Al-Haddad “A Comparative Study of Energy Management Schemes for a Fuel-Cell Hybrid Emergency Power System of More-Electric Aircraft” IEEE Transactions on Industrial Electronics, Volume: 61 , March 2014, Pages 1320 – 1334

[10] Yakup Hames Kemal Kaya Ertugrul Baltacioglu ArzuTurksoy “Analysis of the control strategies for fuel saving in the hydrogen fuel cell vehicles” International Journal of Hydrogen Energy Volume 43, Issue 23, 7 June 2018, Pages 10810-10821

[11] Nadjwa Chettibi ; Adel Mellit ; Giorgio Sulligoi ; Alessandro Massi Pavan “ Adaptive Neural Network-Based Control of a Hybrid AC/DC Microgrid” IEEE Transactions on Smart Grid, Volume: 9 , Issue: 3 , May 2018, Pages 1667 – 1679

[12] Pablo Garcia, Luis M. Fernandez, Carlos Andres Garcia, and Francisco Jurado, “Energy Management System of Fuel-Cell-Battery Hybrid Tramway” IEEE transactions on industrial electronics, Volume: 57, Issue: 12, DECEMBER 2010, Page s: 4013 - 4023

[13] Phatiphat Thounthong, Luigi Piegari, Serge Pierfederici, Bernard Davat” Nonlinear intelligent DC grid stabilization for fuel cell vehicle applications with a supercapacitor storage device” Electrical Power and Energy Systems Volume 64,2015, pages 723–733

[14] Warit Thammasiriroj, Viboon Chunkag, Matheepot Phattanasak, Serge Pierfederici, Bernard Davat, Phatiphat Thounthong” Nonlinear single-loop control of the parallel converters for a fuel cell power source used in DC grid applications” Electrical Power and Energy Systems Volume 65,2015, pages 41–48

[15] Fan Yang, Bo Sheng, Yang Fu “Energy management for fuel cell-supercapacitor hybrid system using passivity-based controller with multi-equilibrium states” IECON 2015 - 41st Annual Conference of the IEEE Industrial Electronics Society, Yokohama, Japan, 9-12 Nov. 2015, Pages 511-516

[16] Prakash K. Ray ; Vijay P. Singh ; Soumya R. Mohanty ; Nand Kishor ; Sumit Sen” Frequency control based on H inf controller for small hybrid power system”, 2011 5th International Power Engineering and Optimization Conference ; Shah Alam, Selangor, Malaysia, 6-7 June 2011, Page s: 227 - 232

[17] K.SankarAmiya K.Jana,”Nonlinear multivariable sliding mode control of a reversible PEM fuel cell integrated system” Energy Conversion and Management, Volume 171, 1 September 2018, Pages 541-565

[18] Ravi Patel, Dipankar Deb “Parametrized control-oriented mathematical model and adaptive backstepping control of a single chamber single population microbial fuel cell” Journal of Power Sources Volume 396, 31 August 2018, Pages 599-605

[19] Phatiphat Thounthong, Stephane Raël, Bernard Davat “ Energy management of fuel cell/battery/supercapacitor hybrid power source for vehicle applications” Journal of Power Sources, Volume 193, 2009, Pages 376–385

[20] E.Pahon, N.Yousfi Steiner, S.Jemei , D.Hissel, M.C.Péra, K.Wang, P.Moçoteguy “Solid oxide fuel cell fault diagnosis and ageing estimation based on wavelet transform approach” International Journal of Hydrogen Energy Volume 41, Issue 31, 17 August 2016, Pages 13678-13687

[21] David M.Mackie Justin P.Jahnke Marcus S.Benyamin James J.Sumner “Simple, fast, and accurate methodology for quantitative analysis using Fourier transform infrared spectroscopy, with bio-hybrid fuel cell examples” MethodsX Volume 3, 2016, Pages 128-138

[22] Tianyu Li Huiying Liu Daolin Ding”Predictive energy management of fuel cell supercapacitor hybrid construction equipment” Energy, Volume 149, 15 April 2018, Pages 718-729

[23] Diego Feroldi Mauro Carignano” Sizing for fuel cell/supercapacitor hybrid vehicles based on stochastic driving cycles” Applied Energy Volume 183, 1 December 2016, Pages 645-658

[24] Kai Ou Wei-Wei Yuan Mihwa Choi Seugran Yang Seung hun Jung Young-BaeKim

“Optimized power management based on adaptive-PMP algorithm for a stationary PEM fuel cell/battery hybrid system” *International Journal of Hydrogen Energy* Volume 43, Issue 32, 9 August 2018, Pages 15433-15444

[25] Resmi Suresh Ganesh Sankaran Sreeram Joopudi Suman Roy Choudhury Shankar Narasimhan Raghunathan Rengaswamy “Optimal power distribution control for a network of fuel cell stacks” *Journal of Process Control* Available online 2 March 2018, In Press.

[27]Alaaeldin M.Abdelshafy Hamdy Hassan Jakub Jurasz “Optimal design of a grid-connected desalination plant powered by renewable energy resources using a hybrid PSO–GWO approach” *Energy Conversion and Management* Volume 173, 1 October 2018, Pages 331-347

[28]S. Mirjalili, S. M. Mirjalili, and A. Lewis, “Grey Wolf Optimizer,” *Adv. Eng. Softw.*, vol. 69, pp. 46–61, 2014.

[29] A. Djerioui, A. Houari, M. Ait-Ahmed, M.F Benkhoris, A. Chouder and M. Machmoum " Grey Wolf based control for speed ripple reduction at low speed operation of PMSM drives" *ISA Trans.*, vol. PP, pp. 1–8, 2018.

[30] R.E.Precup, R.-C.David and E.M. Petriu, " Grey wolf optimizer algorithm-based tuning of fuzzy control systems with reduced parametric sensitivity. *IEEE Transactions on Industrial Electronics* 64, 1., 527–534.2017

[31] U. Sultana, A. B. Khairuddin, A. S. Mokhtar, N. Zareen, and B. Sultana, “Grey wolf optimizer based placement and sizing of multiple distributed generation in the distribution system,” *Energy*, vol. 111, pp. 525–536, 2016.

[32] S. Sharma, S. Bhattacharjee, and A. Bhattacharya, “Grey wolf optimisation for optimal sizing of battery energy storage device to minimise operation cost of microgrid,” *IET Gener. Transm. Distrib.*, vol. 10, no. 3, pp. 625–637, 2016.

[33] M. Pradhan, P. K. Roy, and T. Pal, “Grey wolf optimization applied to economic load dispatch problems,” *Int. J. Electr. Power Energy Syst.*, vol. 83, pp. 325–334, Dec. 2016.

[34] N. Jayakumar, S. Subramanian, S. Ganesan, and E. B. Elanchezhian, “Grey wolf optimization for combined heat and power dispatch with cogeneration systems,” *Int. J. Electr. Power Energy Syst.*, vol. 74, pp. 252–264, Jan. 2016.

[35] A Harrag, S Messalti," How fuzzy logic can improve PEM fuel cell MPPT performances?" *International Journal of Hydrogen Energy*, Volume 43, Issue 1, 4 January 2018, Pages 537-550

[36] M Yue, S Jemei, R Gouriveau, N Zerhouni "Review on health-conscious energy management strategies for fuel cell hybrid electric vehicles: Degradation models and strategies" *International Journal of Hydrogen Energy*, Volume 44, Issue 13, 8 March 2019, Pages 6844-6861

[37] J. Zhao, H.S. Ramadan, M. Becherif " Metaheuristic-based energy management strategies for fuel cell emergency power unit in electrical aircraft" *International Journal of Hydrogen Energy*, Volume 44, Issue 4, 22 January 2019, Pages 2390-2406

[38] B Bendjedia, N Rizoug, M Boukhnifer , F Bouchafaa , M Benbouzid" Influence of secondary source technologies and energy management strategies on Energy Storage System sizing for fuel cell electric vehicles" *International Journal of Hydrogen Energy*Volume 43, Issue 25, 21 June 2018, Pages 11614-11628

[39] Z. Mokrani, D. Rekioua, N. Mebarki, T. Rekioua, S. Bacha "Proposed energy management strategy in electric vehicle for recovering power excess produced by fuel cells" *International Journal of Hydrogen Energy* Volume 42, Issue 30, 27 July 2017, Pages 19556-19575

[40] Z. Abdin, C.J. Webb, E. MacA. Gray " Modelling and simulation of a proton exchange membrane (PEM) electrolyser cell" *International Journal of Hydrogen Energy* Volume 40, Issue 39, 19 October 2015, Pages 13243 e13257

[41] C. Kunsch, P. Puleston, M. Mayosky "Sliding-Mode Control of PEM Fuel Cells", *Advances in industrial control*, 2012 Edition.

[42] Frano Barbir "PEM Fuel Cells Theory and Practice" *Sustainable World Series-Academic Press*, 2005 Edition.

[43] http://eng.harran.edu.tr/moodle/moodledata/134/Ders_Notlari/fuel_pilleri.pdf

[44] <https://www.fuelcellstore.com/manuals/horizon-pem-fuel-cell-h-2000-manual.pdf>

[43] Snoussi, J.; Elghali, S.B.; Outbib, R.; Mimouni, M.F. Sliding mode control for frequency-based energy management strategy of hybrid Storage System in vehicular application. In *International Symposium on Power Electronics, Electrical Drives, Automation and Motion (SPEEDAM)*; IEEE: Piscataway, NJ, USA, 2016; pp. 1109–1114.

[44] Jamila Snoussi, Seifeddine Ben Elghali, Mohamed Benbouzid, and Mohamed Faouzi Mimoun “Auto-

Adaptive Filtering-Based Energy Management Strategy for Fuel Cell Hybrid Electric Vehicles” *Energies* Volume 11, Issue 8, August 2018, Pages 1-20

[45] N. Matuli, G. Radica, F. Barbir, S. Nizeti ”Commercial vehicle auxiliary loads powered by PEM fuel cell” *International Journal of Hydrogen Energy* Volume 44, Issue 20, 19 April 2019, Pages 10082-10090