



**HAL**  
open science

## Synthesis, antiviral and antitumor activities investigations of a series of Ribavirin C-nucleoside analogue prodrugs

Nazarii Sabat, Abdelhakim Ouarti, Evelyne Migianu-Griffoni, Marc Lecouvey, Olivier Ferraris, Florian Gallier, Christophe Peyrefitte, Nadège Lubin-Germain, Jacques Uziel

### ► To cite this version:

Nazarii Sabat, Abdelhakim Ouarti, Evelyne Migianu-Griffoni, Marc Lecouvey, Olivier Ferraris, et al.. Synthesis, antiviral and antitumor activities investigations of a series of Ribavirin C-nucleoside analogue prodrugs. *Bioorganic Chemistry*, 2022, 122, pp.105723. 10.1016/j.bioorg.2022.105723 . hal-03627511

HAL Id: hal-03627511

<https://hal.science/hal-03627511v1>

Submitted on 22 Jul 2024

**HAL** is a multi-disciplinary open access archive for the deposit and dissemination of scientific research documents, whether they are published or not. The documents may come from teaching and research institutions in France or abroad, or from public or private research centers.

L'archive ouverte pluridisciplinaire **HAL**, est destinée au dépôt et à la diffusion de documents scientifiques de niveau recherche, publiés ou non, émanant des établissements d'enseignement et de recherche français ou étrangers, des laboratoires publics ou privés.



Distributed under a Creative Commons Attribution - NonCommercial 4.0 International License

## Synthesis, antiviral and antitumor activities investigations of a series of Ribavirin C-nucleoside analogue prodrugs

Nazarii Sabat <sup>a</sup>, Abdelhakim Ouarti <sup>a</sup>, Evelyne Migianu-Griffoni <sup>b</sup>, Marc Lecouvey <sup>b</sup>, Olivier Ferraris <sup>c</sup>, Florian Gallier <sup>a</sup>, Christophe Peyrefitte <sup>c,d</sup>, Nadège Lubin-Germain <sup>a</sup>, Jacques Uziel <sup>a\*</sup>

<sup>a</sup> CY Cergy Paris Université, CNRS, BioCIS, 95000, Cergy-Pontoise, France

Université Paris-Saclay, CNRS, BioCIS, 92290, Châtenay-Malabry, France

<sup>b</sup> Université Paris 13, Sorbonne Paris Cité, Laboratoire de Chimie, Structure, Propriétés de Biomatériaux et d'Agents Thérapeutiques (CSPBAT), CNRS UMR 7244, 74, rue Marcel Cachin F-93017 Bobigny, France

<sup>c</sup> Unité de virologie, Département Microbiologie et Maladies Infectieuses, Institut de Recherche Biomédicale des Armées (IRBA), Lyon, France

<sup>d</sup> Institut Pasteur, Dakar, Senegal

\*Corresponding author: [jacques.uziel@cyu.fr](mailto:jacques.uziel@cyu.fr)

### ABSTRACT

Phosphoramidates obtained according to the ProTide strategy are known for their ability to increase the biological activity of various nucleosides. A series of such prodrugs of SRO-91, a non-natural ribofuranosyl-1,2,3-triazole C-nucleoside obtained by a synthetic sequence involving an indium mediated alkynylation and a Huisgen cycloaddition, was prepared and the antitumor activity on 3 strains of tumor cells was investigated. Two compounds **9a** and **9c** exhibited interesting cell proliferative inhibitions ( $IC_{50} = 2.5-12.1 \mu M$ ) on two cell lines (pancreas and lung). Moreover, concerning the antiviral activity, another phosphoramidate **14** bearing a different aryl masking group exhibited an  $IC_{50}$  of  $5 \mu M$  on Crimean-Congo Hemorrhagic Fever orthonairovirus. In both cases, free SRO-91 presented no activity on these cell lines.

### KEYWORDS

C-nucleoside, Ribavirin, prodrugs, phosphoramidates, antitumor, antiviral

## 1. Introduction

Among the prodrug strategies for the discovery of nucleoside therapeutics, the “ProTide” one pioneered by Chris McGuigan is particularly powerful [1] and led to the discovery of two FDA-approved compounds (Sofosbuvir and Tenofovir alafenamide), some others being currently in phase III clinical trials (anti-HCV, anti-HIV, anti-EBOV, anticancer). As the *in vivo* activation of several antiviral and anticancer nucleosides involves phosphorylation and as the first phosphorylation step is the rate-limiting one, the synthesis of 5'-*O*-monophosphate derivatives to be delivered into cells has been developed. In the ProTide technology the phosphate group is masked with an amino acid ester and an aryl motif (phosphoramidate). *In vivo* these prodrugs are metabolized to release the nucleoside monophosphate by a mechanism involving the action of an esterase and a phosphoramidase-type enzyme [2,3].

Among the unnatural nucleosides, Ribavirin (RBV) a guanosine analogue, presents a unique broad-spectrum *in vitro* activity against both RNA and DNA viruses. Until recently, Ribavirin combined with IFN- $\alpha$ , was a major therapeutic agent in HCV treatment, but Ribavirin has also been indicated for respiratory syncytial virus infections, hemorrhagic fevers caused by viruses such as Lassa and Crimean-Congo, chronic hepatitis E virus infections, and many other severe, life-threatening viral infections. Presently, the use of Ribavirin in HCV therapy has diminished, but it continues to be recommended concomitantly with selected interferon-free, direct-acting antiviral (DAA) treatments such as Sofosbuvir. The major side effect of RBV is hemolytic anemia. RBV is also associated with increased risk of itching, rash, cough as well as neuropsychiatric side effects, such as insomnia [4].

Taking into consideration the potential of RBV, we turned to the synthesis of *C*-nucleoside analogs of RBV and to their evaluation for antiviral and antitumor activities. We have then published recently a first work on ovarian cancer, and we have shown that compound **1** (SRO-91, Figure 1) has the capacity to put ovarian cancer cells in quiescence and even to induce their apoptosis selectively [5]. Then we have investigated anti-tumor activities by testing SRO-91 on different cell lines. We have shown that SRO-91 exhibits micromolar activities on melanomas, epidermoid carcinomas, and gliomas with better IC<sub>50</sub> than RBV. [6]

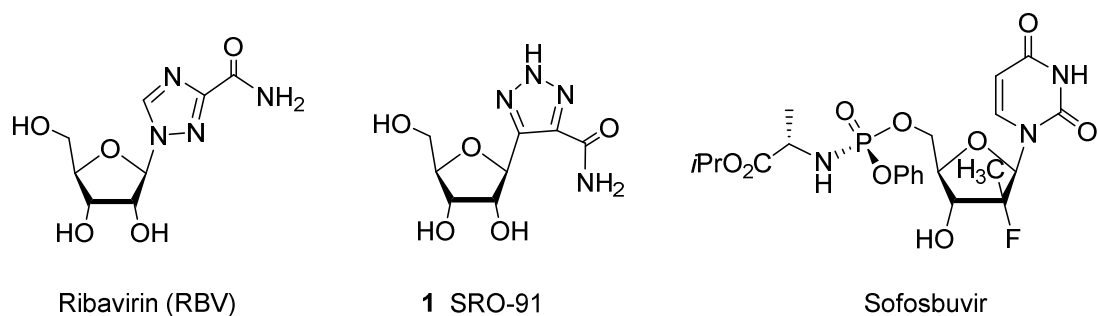
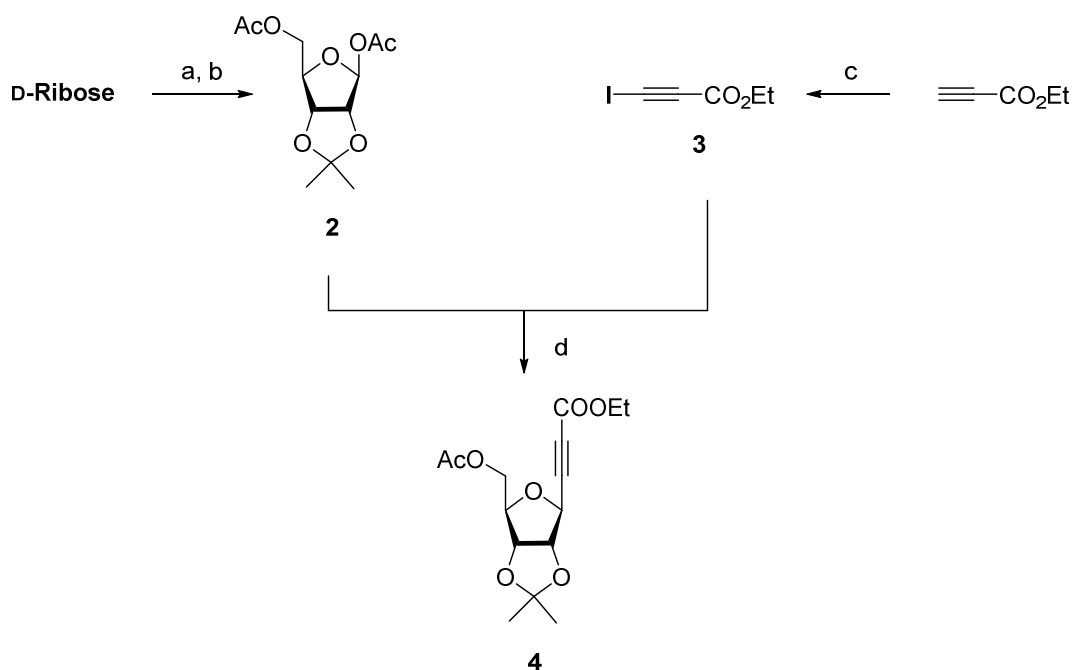

**Fig. 1.** RBV, its C-nucleoside analogue SRO-91 and Sofosbuvir a commercially available phosphoramidate prodrug

## 2. Results and discussion

### 2.1. Chemistry

The synthesis of **1** (SRO-91) is based on two key reactions, namely an indium mediated alkylation on riboside anomeric position and a Huisgen cycloaddition leading to the triazole moiety. During this work we revisited the synthesis developed in the laboratory in order to simplify the deprotection steps and to avoid the palladium catalyzed hydrogenolysis. Alkynyl derivative **4** was obtained under Barbier conditions from fully protected ribose **2**, ethyl iodopropionate (obtained by iodination of ethyl propionate with NIS) and metallic indium in refluxing DCM for 3 days [7,8] as illustrated in Scheme 1.



**Scheme 1.** Preparation of C-alkynyl glycoside **4**: (a) acetone, H<sub>2</sub>SO<sub>4</sub> cat. (quant.); (b) Ac<sub>2</sub>O, pyr (quant.); (c) NIS, AgNO<sub>3</sub>, acetone (85%); (d) In(0), DCM, reflux (44%).

C-alkynyl glycoside **4** was further engaged in Huisgen cycloaddition with 2-(trimethylsilyl)ethoxymethyl azide [9], obtained from 2-(trimethylsilyl)ethoxymethyl chloride, resulting in a 3:1 mixture of regioisomers **5a** and **5b**. The structure of these regioisomers was attributed according to <sup>13</sup>C NMR chemical shifts of triazole C<sub>4</sub> and C<sub>5</sub> (138.1 ppm for **5a** and 148.8 and 126.1 ppm respectively for **5b**) in accordance with the spectra of the corresponding isomers in previous work [6,7]. The two regioisomers can be partially separated by flash chromatography. However, this was not done since when the triazole is deprotected, they ultimately lead to the same tautomer **7**. The treatment of this mixture with gaseous ammonia led to both the carboxamide formation and the deprotection of the position 5 of the riboside. There is no difference of reactivity between these two isomers since the compounds **6a** / **6b** were obtained with the same ratio as **5a** / **5b** (3: 1). (Trimethylsilyl)ethoxymethyl protecting group removal was carried out using a TBAF solution, followed by basic treatment affording **7** as a single nucleoside derivative. However, the yield of this step was lower than expected due to partial deprotection. The *N*-hydroxymethyltriazole intermediate couldn't be transformed to the desired compound **7**. Finally, the acetonide group removal resulted in target nucleoside **1** (SRO-91) as illustrated in Scheme 2.

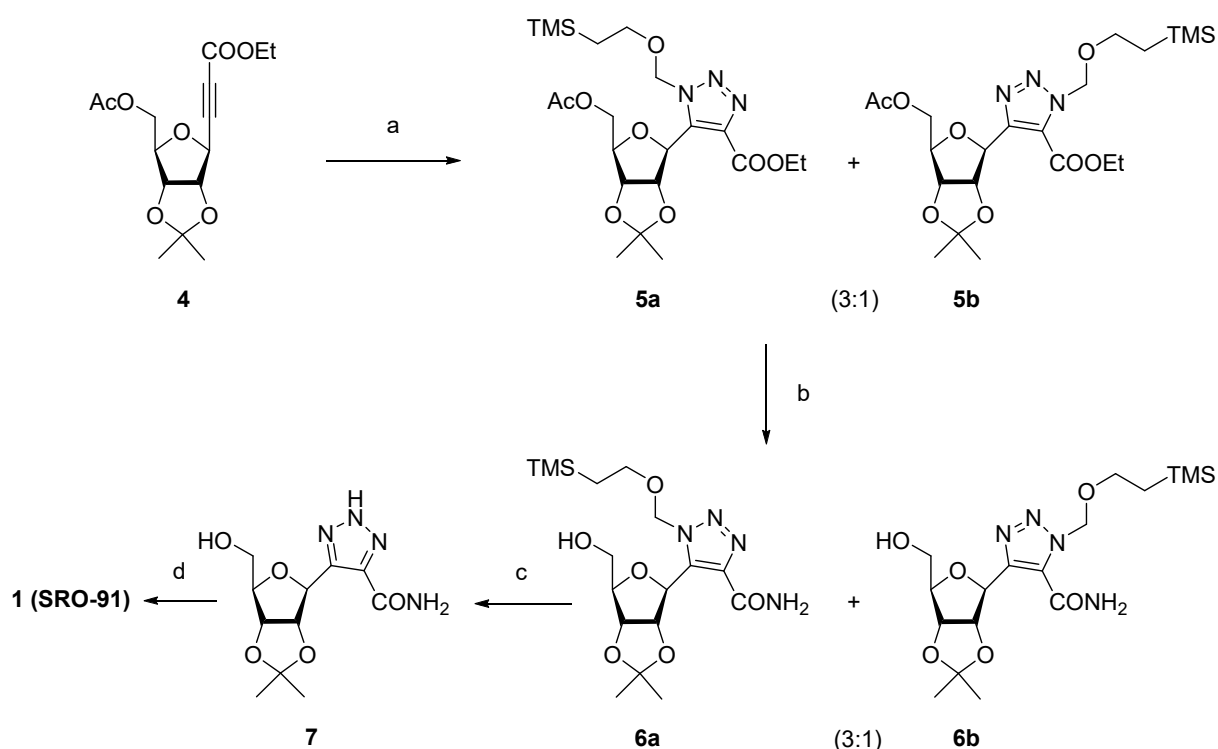

**Scheme 2.** Improved synthesis of 5-( $\beta$ -D-ribofuranosyl)-2H-1,2,3-triazole-4-carboxamide (SRO-91): (a)  $\text{TMS}(\text{CH}_2)_2\text{OCH}_2\text{N}_3$ , toluene, reflux (82%); (b)  $\text{NH}_3$  gas, MeOH, rt (92%); (c) 1M TBAF in THF, reflux, then  $\text{CaCO}_3$ , Amberlyst A21, rt, then  $\text{NH}_4\text{OH}$ , rt (51%); (d) DOWEX 50WX8, MeOH/ $\text{H}_2\text{O}$  (4:1) 50°C (72%) or TFA, r.t. (86%)

The choice of the SRO-91 prodrugs was made according to literature data [10-12] and firstly on phosphoramidates bearing phenyl as aryl masking group and alanine or valine ethyl, isopropyl or benzyl esters for the amino acid motif. The synthesis of these phosphoramidates **9** was achieved starting from diastereomerically pure pentafluorophenyl reagents **8**, obtained by reaction of the corresponding aminoacid (L-Ala or L-Val) with phenyl dichlorophosphate followed by reaction with pentafluorophenol as illustrated in Scheme 3. Single *S,S*<sub>P</sub>-diastereomers of **8** were isolated by crystallization as it has already been described by Ross *et al.* [13] (with the exception of **8c** obtained as a diastereomer mixture).

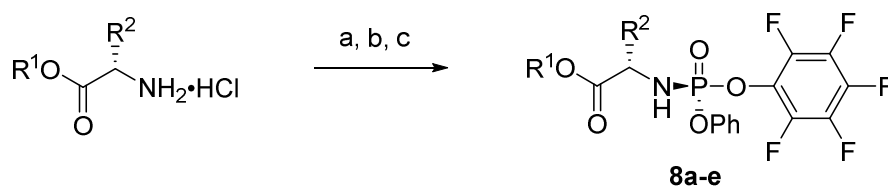

S, S<sub>P</sub> - diastereomer

R<sup>1</sup> = Et, R<sup>2</sup> = Me, **8a** (30%)

R<sup>1</sup> = *i*Pr, R<sup>2</sup> = Me, **8b** (31%)

R<sup>1</sup> = Bn, R<sup>2</sup> = Me, **8c** (24%)

R<sup>1</sup> = Et, R<sup>2</sup> = *i*Pr, **8d** (32%)

R<sup>1</sup> = Bn, R<sup>2</sup> = *i*Pr, **8e** (22%)

**Scheme 3.** Obtention of diastereomerically pure PFP-phosphoramidates **8**: (a) PhP(O)Cl<sub>2</sub>, NEt<sub>3</sub>, DCM, -70°C to 0°C; (b) C<sub>6</sub>F<sub>5</sub>OH, NEt<sub>3</sub>, DCM, 0°C; (c) crystallization with cyclohexane/Et<sub>2</sub>O (2:1)

A first attempt of coupling the deprotected SRO-91 nucleoside **1** with the phosphoramidate reagent **8a** under common coupling conditions, that is in presence of *t*-BuMgCl in THF, afforded the desired ProTide **9a** in low yield (10%) as illustrated in Scheme 4.

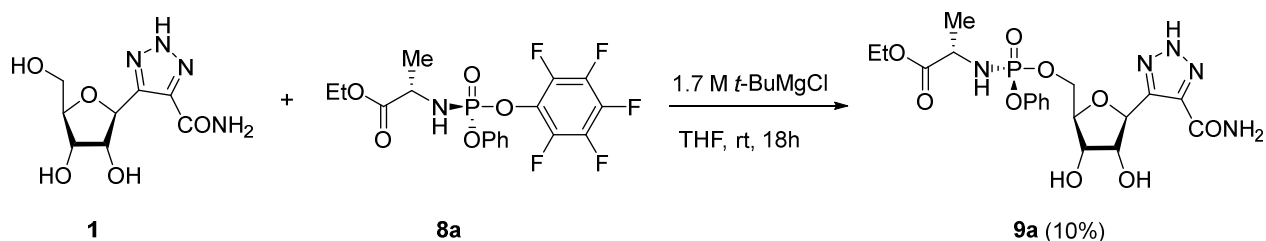

**Scheme 4.** Coupling of phosphoramidate reagent with free nucleoside **1**.

We then opted for an approach starting from the isopropylidene protected nucleoside **7**. Under the same coupling conditions, a series of protected phosphoramidates **10a-10e** was obtained in moderate yields (38-55%). Final removal of acetonide group gave the desired ProTides in quite good yields (56-60%) **9a-9e** as illustrated in Scheme 5. **Such two-step procedure is more efficient as it allows a better overall yield of the desired phosphoramidate (25% vs 10% in the case of 9a).**

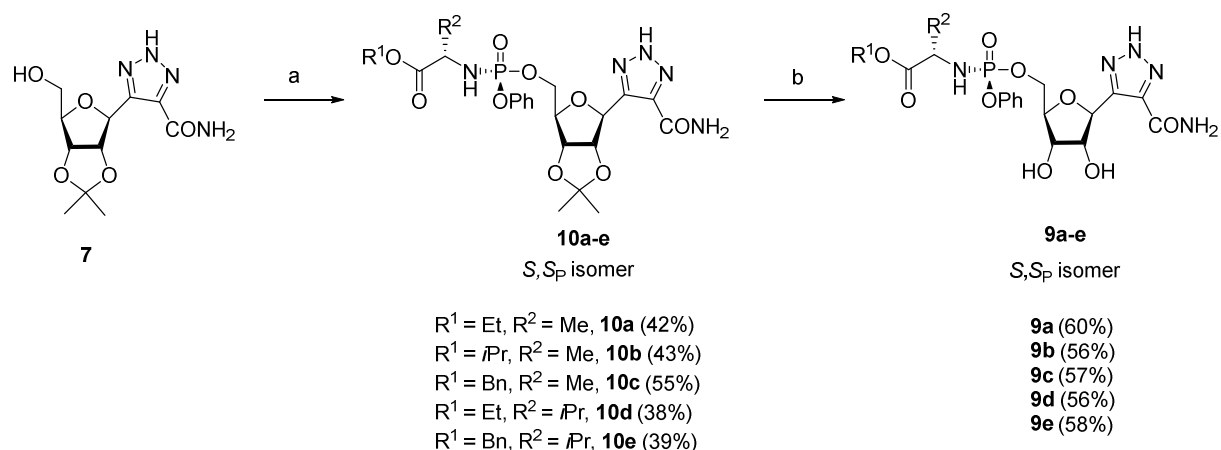

**Scheme 5.** Obtaining of a series of SRO-91 ProTides **9**: (a) **8a-e**, 1.7 M *t*-BuMgCl, THF, rt; (b) DOWEX 50WX8, MeOH/H<sub>2</sub>O (4:1) 50°C.

Although these prodrugs led to interesting antitumor activities (see §2.2.1), the disappointing results of this series towards the Crimean-Congo Hemorrhagic Fever orthonairovirus (see §2.2.2), led us to investigate the use of a different aryl group on phosphoramidate such as the naphthyl group [14-15]. The SRO-91 phosphoramidate derivative **14** was synthesized as a mixture of diastereomers according to the pathway of Scheme 6, starting from alkynyl glycoside **11** [16]. In this strategy the 2 and 3 positions of the sugar were protected with a cyclopentadiene group as also described in a work of McGuigan's group on RBV phosphoramidate [15] in order to enhance its stability and/or solubility. Compound **11** was engaged in a Huisgen cycloaddition with benzyl azide, followed by aminolysis and debenzylation, affording **12**. The coupling of this nucleoside derivative with *L*-AlaOBnP(O)(ONp)Cl (prepared from dichloronaphthylphosphate and *L*-AlaOBn.TsOH in presence of Et<sub>3</sub>N) under the previous conditions, *i.e.*, in the presence of *t*-BuMgCl in THF led to protected phosphoramidate **13** which was deprotected under mild acidic conditions.



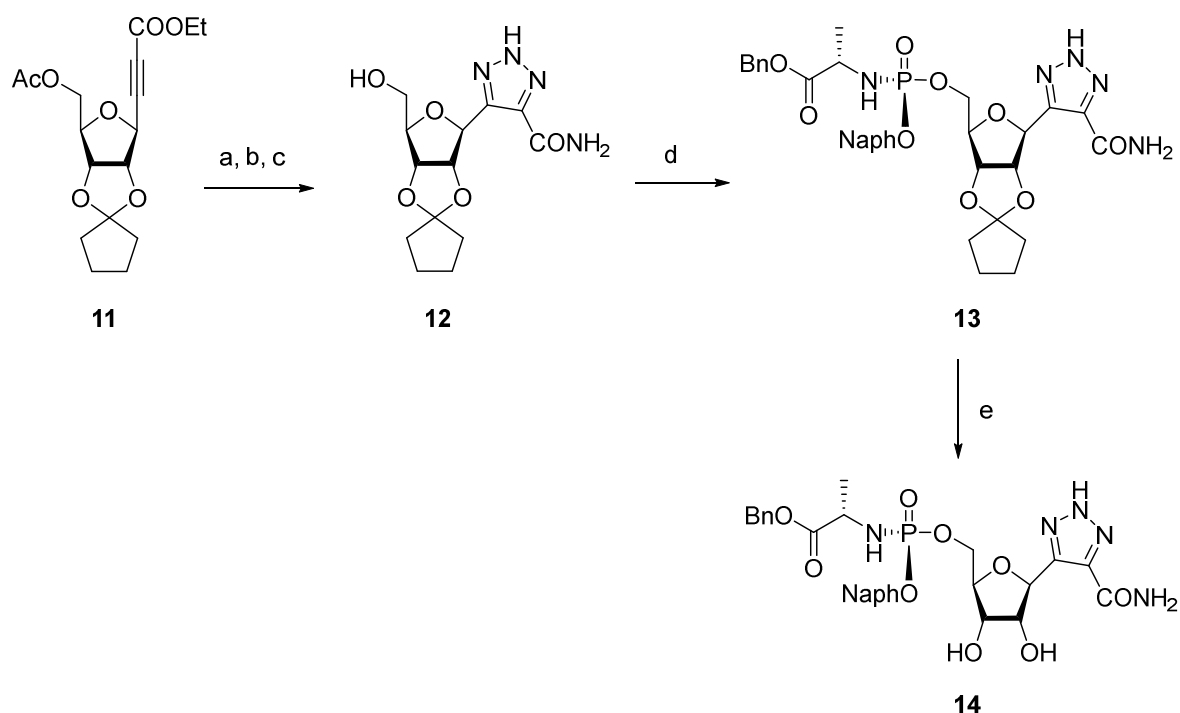

**Scheme 6.** Obtaining of SRO-91 ProTide **14**: (a)  $\text{BnN}_3$ , toluene, reflux (89%); (b)  $\text{NH}_3(\text{g})$ , MeOH,  $0^\circ\text{C}$  (92%); (c)  $\text{H}_2$ , Pd/C, EtOH, 6 bar (29%); (d) L-AlaOBnP(O)(ONaph)Cl, 1.7 M *t*-BuMgCl, THF, rt (29%); (e) DOWEX 50WX8, MeOH/ $\text{H}_2\text{O}$  (4:1)  $50^\circ\text{C}$  (39%).

It is known that the phosphoramidates activation mechanism involves initial hydrolysis of the carboxylic ester by a carboxypeptidase type enzyme, and subsequent spontaneous cyclisation with displacement of the aryloxy group, followed by opening of the unstable anhydride ring mediated by water. The last step in the bioactivation is considered to involve the hydrolysis of the P–N bond by a phosphoramidase-type enzyme [17].

In order to study the enzymatic hydrolysis of prodrug **14**, we used Carboxypeptidase Y (in a pH 7.4 buffer solution) and followed the progress of the hydrolysis by  $^{13}\text{P}$  NMR as depicted in Figure 2. A first spectrum having been carried out before the introduction of the enzyme ( $t = 0$ ). After the addition of the enzyme, the starting material ( $\delta = 4.69\text{--}4.00$ ) is quickly hydrolyzed to lead to metabolite **(I)** ( $\delta 5.52\text{--}5.02$  ppm) corresponding to the compound from which the benzyl ester of alanine has been deprotected, then to metabolite **(II)** ( $\delta 7.39$  ppm) in which the naphthyl group has also been lost, as suggested by Derudas *et al.* [17]. Compound **(II)** subsequently remains stable in the absence of phosphoramidase allowing the release of monophosphate.

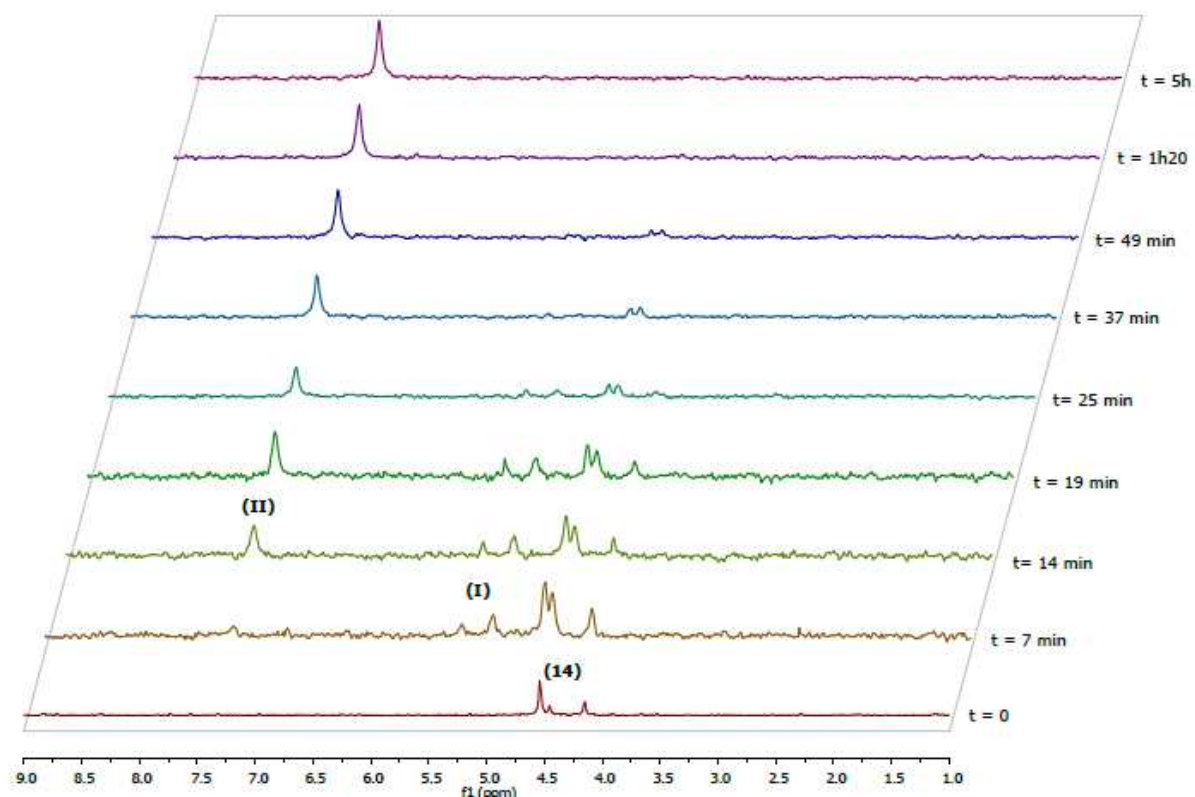

**Fig. 2.** <sup>31</sup>P NMR (101 MHz, acetone-*d*<sub>6</sub>) following of prodrug **14** enzymatic hydrolysis by Carboxypeptidase Y.

## 2.2. Biology

### 2.2.1. Antiproliferative activity of ProTides **9a-e** on tumor cell lines

In a previous study [6], we reported the *in vitro* micromolar activities of SRO-91 nucleoside **1** on various high cell density cancer lines, suggesting a potential efficiency in tumor reduction. Unfortunately, *in vivo*, this efficacy decreases as activation of anticancer nucleosides implies phosphorylations and the first phosphorylation step of the 5'-hydroxyl group is the rate-limiting one. Thus, in a promising strategy of 5'-*O*-monophosphate prodrugs, the *in vitro* properties of phosphoramidates **9a-e** were evaluated in lower cell densities on human cancer cell growth and compared to SRO-91 nucleoside **1** effects. Three cell lines were studied: MDA-MB-231 (breast), MIA PaCa-2 (pancreas) and A549 (lung). The choice of the first cell line was encouraged by the

limited treatment options for human triple-negative breast cancer of which MDA-MB-231 cells are a highly aggressive form. Otherwise, pancreas and lung cancers present low 5-year survival rates and limited chemotherapy, requiring investigation of new more efficient molecules. The antiproliferative activity of nucleoside analogues **9a-e** was measured by the MTT test after 72h incubation of treated cells and IC<sub>50</sub> were determined (concentration of the compound where the response was reduced by half, Table 1).

**Table 1.** Cell proliferative inhibition by SRO-91 **1** and ProTides **9a-e** (IC<sub>50</sub> [ $\mu$ M]<sup>[a]</sup>) after 72 h incubation on MIA PaCa-2 (pancreas) MDA-MB-231 (breast) and A549 (lung) human cancer cell lines.

Compound	MIA PaCa-2	MDA-MB-231	A549
<b>1</b>	> 100	> 100	> 100
<b>9a</b>	2.5 $\pm$ 0.3	11.5 $\pm$ 1.3 <sup>b</sup>	10.1 $\pm$ 1.9
<b>9b</b>	80 $\pm$ 4 <sup>c</sup>	> 100	> 100
<b>9c</b>	4.4 $\pm$ 0.3	> 100	12.1 $\pm$ 3.5
<b>9d</b>	> 100	> 100	> 100
<b>9e</b>	> 100	> 100	> 100

<sup>a</sup> IC<sub>50</sub> values correspond to the means of three independent experiments performed in triplicate ( $\pm$ standard deviation).

<sup>b</sup> The maximum inhibition of cell proliferation was 80% at 500  $\mu$ M.

<sup>c</sup> The maximum inhibition of cell proliferation was 90% at 500  $\mu$ M.

The best cell proliferative inhibitions were obtained on MIA PaCa-2 and A549 cell lines, with a better efficiency for the first one. These good results could be explained as carboxypeptidase enzymes are secreted in pancreas. Interest of the prodrug approach is clearly showed with IC<sub>50</sub> values between 2.5 and 12.1  $\mu$ M for phosphoramidates **9a** and **9c** whereas SRO-91 nucleoside **1** was inactive in these culture conditions (IC<sub>50</sub> > 100  $\mu$ M on all cell lines). Comparison of antiproliferative activities of analogues **9a-c** on MIA PaCa-2 and A549 cell lines allow to conclude about the importance of the ester function. Indeed, ethyl ester was more sensitive to carboxypeptidase enzyme than benzyl one while isopropyl group seemed to be inert towards carboxypeptidase. Moreover, the nature of the alkyl group in  $\alpha$ -position of phosphoramidate and ester was crucial for the activity. Thus, the presence of a methyl group was essential to have an alanine deprotection by carboxypeptidase and phosphoramidase enzymes (compounds **9a-c**). In contrast, the cleavage which could lead to a valine was not favorable giving no significative activities on the three cell lines (compounds **9d-e**). Finally, the best 5'-O-monophosphate prodrug

in this study was **9a** (with an ethyl ester and an alanine phosphoramidate) exhibiting encouraging cell proliferative inhibitions on all the tested cell lines ( $IC_{50} = 2.5-11.5 \mu M$ ).

### 2.2.2. Anti-CCHF virus activity

Crimean-Congo Hemorrhagic Fever virus was (CCHF) investigated on SRO-91 and prodrugs. SRO-91 and phosphoramidates **9a-e** showed no activity, while phosphoramidate derivative **14** bearing an alanine benzyl ester and a naphthyl masking group, is an effective antiviral molecule for CCHF virus. The 50% inhibitory concentration ( $IC_{50}$ ) value for prodrug **14** was  $5 \mu M$ .

Ribavirin was found to be effective against CCHF virus (CCHFV) in vitro [18,19]. Even considering ribavirin inhibitory activities on inosine monophosphate dehydrogenase, RNA capping, polymerase, as lethal mutagen, or immunomodulatory agent [20], the antiviral mechanism of ribavirin remains controversial but relates to alteration of cellular nucleotide pools and inhibition of viral messenger RNA synthesis [21]. Concerning the antiviral activity against CCHF virus, only the phosphoramidate carrying a naphthyl group rather than a phenyl demonstrated an interesting inhibitory activity ( $IC_{50} = 5 \mu M$ ). Studies on the influence of this non-polar aromatic group reveal that nucleic acids derivatives tethering a naphthyl group reveal modification of duplex stability between nucleic acids [22]. The inhibitory effect of naphthyl group was already investigated and described against viruses such as influenza or HIV [23,24] and could be extend to the property of the compound **14**. This last result leads us to turn to the synthesis of other prodrugs carrying this masking group.

## 3. Conclusion

In this work we studied the antitumor and antiviral activities of a series of SRO-91 phosphoramidates. We firstly revisited the synthesis of the free C-nucleoside previously obtained in our group, according to a (trimethylsilyl)ethoxymethyl-protecting group, then we synthesized a series of phosphoramidates bearing alanine and valine ester moieties. The study of antitumor activity of these prodrugs was achieved on 3 cancer cell lines and 2 of them revealed interesting  $IC_{50}$  ( $2.5-12 \mu M$ ) on pancreas and lung cell lines. Concerning the antiviral activity against the CCHF virus, only the phosphoramidate carrying a naphthyl group rather than a phenyl,

demonstrated an interesting inhibitory activity ( $IC_{50} = 5 \mu M$ ). This last result leads us to turn to the synthesis of other prodrugs carrying this masking group.

## 4. Experimental

### 4.1. Chemistry

All reactions were conducted under an inert atmosphere of argon. Metallic indium was purchased from Alfa Aesar. Dichloromethane was distilled under argon over  $CaH_2$ .  $^1H$  and  $^{13}C$  NMR spectra were recorded in  $CDCl_3$  or  $CD_3OD$  on a Jeol 400 MHz ECX. High resolution mass spectra were obtained with a LTQ orbitrap spectrometer. Optical rotations were determined at 25 °C in  $CHCl_3$  or MeOH, 589 nm, on an Anton Paar MCP200 instrument and IR spectra were recorded on a Bruker Tensor 27 spectrophotometer. Thin layer chromatography was carried out on silica gel plates 60 F<sub>254</sub> (Macherey-Nagel), spots were detected with UV light (254 nm) and revealed with a 10%  $H_2SO_4$  solution in ethanol. Flash chromatography was performed with silica gel 60, 40-63  $\mu m$ .

4.1.1. Ethyl 5-(5'-O-acetyl-2',3'-O-isopropylidene- $\beta$ -D-ribofuranosyl)-1-((2-(trimethylsilyl)ethoxy)methyl)-1,2,3-triazole-4-carboxylate (**5a**) and Ethyl 4-(5'-O-acetyl-2',3'-O-isopropylidene- $\beta$ -D-ribofuranosyl)-1-((2-(trimethylsilyl)ethoxy)methyl)-1,2,3-triazole-5-carboxylate (**5b**)

Ribosylpropiolate **4** [6,7] (1.56 g, 5.0 mmol) and 2-(trimethylsilyl)ethoxymethyl azide (3.466 g, 20.0 mmol) in toluene (10 mL) were stirred under reflux for 24h. After cooling the reaction mixture was concentrated under reduced pressure. The crude material was purified by flash column chromatography on silica gel (25-30% of EtOAc in cyclohexane) giving the inseparable mixture of desired products **5a-b** as yellowish oil (2 g, 82%) (**5a/5b**, 3:1). **5a**:  $^1H$  NMR (400 MHz,  $CDCl_3$ ):  $\delta$  6.05 (d,  $J = 10.9$  Hz, 1H, NCH<sub>2</sub>O), 5.86 (d,  $J = 5.0$  Hz, 1H, H<sub>1'</sub>), 5.69 (d,  $J = 10.9$  Hz, 1H, NCH<sub>2</sub>O), 4.85 (m, 1H, H<sub>2'</sub>), 4.73 (dd,  $J = 6.9, 5.4$  Hz, 1H, H<sub>3'</sub>), 4.43 (q,  $J = 7.2$  Hz, 2H, OCH<sub>2</sub>CH<sub>3</sub>), 4.38-4.36 (m, 1H, H<sub>5'</sub>), 4.33-4.24 (m, 1H, H<sub>5'</sub>), 4.20 (m, 1H, H<sub>4'</sub>), 3.57 (m, 2H, CH<sub>2</sub>O), 2.11 (s, 3H, OAc), 1.62 (s, 3H, C(CH<sub>3</sub>)<sub>2</sub>), 1.41 (t,  $J = 7.2$  Hz, 3H, OCH<sub>2</sub>CH<sub>3</sub>), 1.33 (s, 3H, C(CH<sub>3</sub>)<sub>2</sub>), 1.03-0.75 (m, 2H, CH<sub>2</sub>Si), -0.02 (s, 9H, SiMe<sub>3</sub>).  $^{13}C$  NMR (100 MHz,  $CDCl_3$ ):  $\delta$  170.7 (COCH<sub>3</sub>), 161.0

(CO<sub>2</sub>Et), 138.1 (C<sub>4</sub>, C<sub>5</sub>), 116.1 (C(CH<sub>3</sub>)<sub>2</sub>), 85.1 (C<sub>2'</sub>), 82.6 (C<sub>4'</sub>), 81.2 (C<sub>3'</sub>), 78.4 (NCH<sub>2</sub>O), 76.5 (C<sub>1'</sub>), 67.5 (CH<sub>2</sub>O), 63.3 (C<sub>5'</sub>), 61.6 (OCH<sub>2</sub>CH<sub>3</sub>), 27.5 (C(CH<sub>3</sub>)<sub>2</sub>), 25.7 (C(CH<sub>3</sub>)<sub>2</sub>), 20.8 (OCH<sub>2</sub>CH<sub>3</sub>), 18.0 (CH<sub>2</sub>Si), 14.3 (OCOCH<sub>3</sub>), -1.4 (SiMe<sub>3</sub>). **5b**: <sup>1</sup>H NMR (400 MHz, CDCl<sub>3</sub>): δ 6.01 (d, *J* = 10.4 Hz, 1H, NCH<sub>2</sub>O), 5.94 (d, *J* = 10.4 Hz, 1H, NCH<sub>2</sub>O), 5.57 (d, *J* = 3.4 Hz, 1H, H<sub>1'</sub>), 5.29 (dd, *J* = 6.4, 3.4 Hz, 1H, H<sub>2'</sub>), 4.85 (m, 1H, H<sub>3'</sub>), 4.43 (q, *J* = 7.2 Hz, 2H, OCH<sub>2</sub>CH<sub>3</sub>), 4.33-4.26 (m, 2H, H<sub>5'</sub>), 4.15-4.11 (m, 1H, H<sub>4'</sub>), 3.57 (m, 2H, CH<sub>2</sub>O), 2.05 (s, 3H, OAc), 1.59 (s, 3H, C(CH<sub>3</sub>)<sub>2</sub>), 1.41 (t, *J* = 7.2 Hz, 3H, OCH<sub>2</sub>CH<sub>3</sub>), 1.37 (s, 3H, C(CH<sub>3</sub>)<sub>2</sub>), 1.03-0.75 (m, 2H, CH<sub>2</sub>Si), -0.05 (s, 9H, SiMe<sub>3</sub>). <sup>13</sup>C NMR (100 MHz, CDCl<sub>3</sub>): δ 170.7 (COCH<sub>3</sub>), 158.1 (CO<sub>2</sub>Et), 148.8 (C<sub>4</sub>), 126.1 (C<sub>5</sub>), 114.4 (C(CH<sub>3</sub>)<sub>2</sub>), 84.3 (C<sub>2'</sub>), 83.6 (C<sub>4</sub>), 82.8 (C<sub>3</sub>), 78.6 (NCH<sub>2</sub>O), 78.1 (C<sub>1'</sub>), 67.7 (CH<sub>2</sub>O), 64.2 (C<sub>5'</sub>), 62.4 (OCH<sub>2</sub>CH<sub>3</sub>), 27.4 (C(CH<sub>3</sub>)<sub>2</sub>), 25.6 (C(CH<sub>3</sub>)<sub>2</sub>), 20.9 (OCH<sub>2</sub>CH<sub>3</sub>), 17.7 (CH<sub>2</sub>Si), 14.1 (OCOCH<sub>3</sub>), -1.4 (SiMe<sub>3</sub>). HRMS (ESI) calcd for C<sub>21</sub>H<sub>36</sub>N<sub>3</sub>O<sub>8</sub>Si [M+H]<sup>+</sup>: 486.2272; found 486.2269.

4.1.2. 5-(2',3'-*O*-Isopropylidene-β-*D*-ribofuranosyl)-1-((2-(trimethylsilyl)ethoxy)methyl)-1,2,3-triazole-4-carboxamide (**6a**) and 4-(2',3'-*O*-Isopropylidene-β-*D*-ribofuranosyl)-1-((2-(trimethylsilyl)ethoxy)methyl)-1,2,3-triazole-5-carboxamide (**6b**)

To a solution of 2-(trimethylsilyl)ethoxymethyl-protected nucleosides **5a-b** (97 mg, 0.2 mmol) was bubbled gaseous ammonia at 0°C for 2 hours. The reaction mixture was then stirred in a sealed flask for additional 48 hours at room temperature. The mixture was concentrated under reduced pressure and the crude material was then purified by flash column chromatography on silica gel (60-70% of EtOAc in cyclohexane) yielding the inseparable mixture of desired products **6a-b** as (76 mg, 92%) (**6a/6b**, 3:1). **6a**: <sup>1</sup>H NMR (400 MHz, CDCl<sub>3</sub>) δ 7.37 (bs, 1H, NH<sub>2</sub>), 6.72 (bs, 1H, NH<sub>2</sub>), 5.86 (d, *J* = 11.2 Hz, 1H, NCH<sub>2</sub>O), 5.66 (d, *J* = 11.2 Hz, 1H, NCH<sub>2</sub>O), 5.47 (d, *J* = 6.3 Hz, 1H, H<sub>1'</sub>), 4.95 (dd, *J* = 6.4, 3.1 Hz, 1H, H<sub>3'</sub>), 4.85 (dd, *J* = 6.4, 6.3 Hz, 1H, H<sub>2'</sub>), 4.23-4.20 (m, 1H, H<sub>4'</sub>), 4.10-3.90 (bs, 1H, OH), 3.87 (dd, *J* = 12.4, 1.9 Hz, 1H, H<sub>5'</sub>), 3.72 (dd, *J* = 12.4, 2.4 Hz, 1H, H<sub>5'</sub>), 3.60-3.52 (m, 2H, CH<sub>2</sub>O), 1.57 (s, 3H, C(CH<sub>3</sub>)<sub>2</sub>), 1.28 (s, 3H, C(CH<sub>3</sub>)<sub>2</sub>), 0.96-0.80 (m, 2H, CH<sub>2</sub>Si), -0.08 (s, 9H, SiMe<sub>3</sub>). <sup>13</sup>C NMR (100 MHz, CDCl<sub>3</sub>): δ 162.9 (CONH<sub>2</sub>), 139.6 (C<sub>4</sub>), 137.2 (C<sub>5</sub>), 115.1 (C(CH<sub>3</sub>)<sub>2</sub>), 85.3 (C<sub>2'</sub>), 84.9 (C<sub>4'</sub>), 81.3 (C<sub>3'</sub>), 78.0 (NCH<sub>2</sub>O), 76.0 (C<sub>1'</sub>), 67.6 (CH<sub>2</sub>O), 62.3 (C<sub>5'</sub>), 27.6 (C(CH<sub>3</sub>)<sub>2</sub>), 25.6 (C(CH<sub>3</sub>)<sub>2</sub>), 17.7 (CH<sub>2</sub>Si), -1.5 (SiMe<sub>3</sub>). **6b**: <sup>1</sup>H NMR (400 MHz, CDCl<sub>3</sub>) δ 7.84 (s, 1H, NH<sub>2</sub>), 7.13 (s, 1H, NH<sub>2</sub>), 5.98 (d, *J* = 10.5 Hz, 1H, NCH<sub>2</sub>O), 5.91 (d, *J* = 10.5 Hz, 1H, NCH<sub>2</sub>O), 5.25 (d, *J* = 5.0 Hz, 1H, H<sub>1'</sub>), 5.13 (dd, *J* = 6.4, 5.0 Hz, 1H, H<sub>2'</sub>), 4.89-

4.85 (m, 1H, H<sub>3'</sub>), 4.23-4.20 (m, 1H, H<sub>4'</sub>), 4.10-3.90 (bs, 1H, OH), 3.78 (dd, *J* = 12.2, 3.1 Hz, 1H, H<sub>5'</sub>), 3.64 (dd, *J* = 12.2, 3.7 Hz, 1H, H<sub>5'</sub>), 3.60-3.52 (m, 2H, CH<sub>2</sub>O), 1.54 (s, 3H, C(CH<sub>3</sub>)<sub>2</sub>), 1.31 (s, 3H, C(CH<sub>3</sub>)<sub>2</sub>), 0.96-0.80 (m, 2H, CH<sub>2</sub>Si), -0.09 (s, 9H, SiMe<sub>3</sub>). <sup>13</sup>C NMR (100 MHz, CDCl<sub>3</sub>): δ 159.8 (CONH<sub>2</sub>), 145.9 (C<sub>4</sub>), 129.1 (C<sub>5</sub>), 114.9 (C(CH<sub>3</sub>)<sub>2</sub>), 86.1 (C<sub>2'</sub>), 84.2 (C<sub>4'</sub>), 81.6 (C<sub>3'</sub>), 79.3 (C<sub>1'</sub>), 78.1 (NCH<sub>2</sub>O), 67.8 (CH<sub>2</sub>O), 62.0 (C<sub>5'</sub>), 27.3 (C(CH<sub>3</sub>)<sub>2</sub>), 25.4 (C(CH<sub>3</sub>)<sub>2</sub>), 17.7 (CH<sub>2</sub>Si), -1.5 (SiMe<sub>3</sub>). HRMS (ESI) calcd for C<sub>17</sub>H<sub>31</sub>N<sub>4</sub>O<sub>6</sub>Si [M+H]<sup>+</sup>: 415.2013; found 415.2015.

#### 4.1.3. 5-(2',3'-*O*-Isopropylidene-β-*D*-ribofuranosyl)-2*H*-1,2,3-triazole-4-carboxamide (**7**)

To a solution of 2-(trimethylsilyl)ethoxymethyl-protected nucleosides **6a-b** (486 mg, 1.0 mmol) in THF (5 mL) 1M solution of TBAF in THF (1.5 mL) was added and the mixture was refluxed for 12 hours. Upon cooling CaCO<sub>3</sub> (500 mg) and Amberlyst A21 ion-exchange resin (1.3 g) were added, the mixture was stirred for an additional 2 hours and filtered through celite (to remove TBAF residue). Filtrate was evaporated and then refluxed in a sealed tube with 1,4-dioxane (2 mL) and aqueous ammonia (35% w/w, 6 mL) for 48 hours. Upon cooling the mixture was concentrated under reduced pressure and the crude material was then purified by flash column chromatography on silica gel (10% of MeOH in DCM) yielding the nucleoside **6** (146 mg, 51%) as a white crystalline solid. m.p. = 64-66°C. [ $\alpha$ ]<sub>D</sub><sup>25</sup> -7.8 (c 1.0, MeOH). <sup>1</sup>H NMR (400 MHz, MeOD) δ 5.50 (d, *J* = 4.4 Hz, 1H, H<sub>1'</sub>), 4.92 (dd, *J* = 6.5, 4.4 Hz, 1H, H<sub>2'</sub>), 4.77 (dd, *J* = 6.5, 3.9 Hz, 1H, H<sub>3'</sub>), 4.10 (ddd, *J* = 4.5, 4.3, 3.9 Hz, 1H, H<sub>4'</sub>), 3.71 (dd, *J* = 12.1, 4.3 Hz, 1H, H<sub>5'</sub>), 3.63 (dd, *J* = 12.1, 4.5 Hz, 1H, H<sub>5'</sub>), 1.52 (s, 3H, C(CH<sub>3</sub>)<sub>2</sub>), 1.29 (s, 3H, C(CH<sub>3</sub>)<sub>2</sub>). <sup>13</sup>C NMR (100 MHz, MeOD): δ 164.8 (CONH<sub>2</sub>), 144.8 (C<sub>5</sub>), 139.1 (C<sub>4</sub>), 115.5 (C(CH<sub>3</sub>)<sub>2</sub>), 87.1 (C<sub>2'</sub>), 86.3 (C<sub>4'</sub>), 82.9 (C<sub>3'</sub>), 79.2 (C<sub>1'</sub>), 63.0 (C<sub>5'</sub>), 27.7 (C(CH<sub>3</sub>)<sub>2</sub>), 25.7 (C(CH<sub>3</sub>)<sub>2</sub>). HRMS (ESI) calcd for C<sub>11</sub>H<sub>17</sub>N<sub>4</sub>O<sub>5</sub> [M+H]<sup>+</sup>: 285.1199; found 285.1202.

#### 4.1.4. 5-(β-*D*-Ribofuranosyl)-2*H*-1,2,3-triazole-4-carboxamide (**1**)

**Procedure A.** To a solution of isopropylidene protected nucleoside **6** (114 mg, 0.4 mmol) in methanol/water (4:1, 5 mL) DOWEX 50WX8 (2 g) was added and the mixture was stirred at 50°C overnight. Upon cooling the mixture was filtered and concentrated under reduced pressure. The residue was purified by flash column chromatography on silica gel (0-50% MeOH in EtOAc) affording the final nucleoside **1** (70 mg, 72%) as a white crystalline solid. **Procedure B.**

Isopropylidene protected nucleoside **6** (85 mg, 0.3 mmol) was dissolved in TFA (3 mL) and stirred for 1 h at room temperature. Then the solvent was repeatedly co-evaporated with methanol under reduced pressure. The residue was purified by flash column chromatography on silica gel (0-50% MeOH in EtOAc) affording the final nucleoside **1** (84 mg, 86%) as a white crystalline solid. m.p. = 204-206 °C.  $[\alpha]_{\text{D}}^{25} +13.8$  (c 1.0, CH<sub>3</sub>OH). <sup>1</sup>H NMR (400 MHz, D<sub>2</sub>O) δ 5.25 (d, *J* = 5.4 Hz, 1H, H<sub>1'</sub>), 4.26 (dd, *J* = 5.4, 5.4 Hz, 1H, H<sub>2'</sub>), 4.16 (dd, *J* = 5.4, 5.4 Hz, 1H, H<sub>3'</sub>), 4.06 (ddd, *J* = 5.4, 4.7, 3.0 Hz, 1H, H<sub>4'</sub>), 3.86 (dd, *J* = 12.5, 3.0 Hz, 1H, H<sub>5'</sub>), 3.74 (dd, *J* = 12.5, 4.7 Hz, 1H, H<sub>5'</sub>). <sup>13</sup>C NMR (100 MHz, CD<sub>3</sub>OD) δ 165.6 (CONH<sub>2</sub>), 144.1 (C<sub>5</sub>), 138.4 (C<sub>4</sub>), 86.1 (C<sub>2'</sub>), 78.3 (C<sub>4'</sub>), 77.5 (C<sub>3'</sub>), 72.1 (C<sub>1'</sub>), 62.8 (C<sub>5'</sub>). HRMS (ESI) calcd for C<sub>8</sub>H<sub>12</sub>N<sub>4</sub>O<sub>5</sub> [M+H]<sup>+</sup>: 244.0808; found, 244.0811.

#### 4.1.5. 5-(2',3'-*O*-Cyclopentylidene-β-D-ribofuranosyl)-2*H*-1,2,3-triazole-4-carboxamide (**12**)

To a solution of ethyl 3-(5-*O*-acetyl-2,3-*O*-cyclopentylidene-β-D-ribofuranosyl)propionate **11** (1.72 g, 5.11 mmol) in toluene (15 mL) was added benzyl azide (2.72 g, 20.4 mmol). The mixture was stirred under reflux for 24 hours. After concentration under reduced pressure, the crude was purified by flash chromatography on silica gel (10% AcOEt in cyclohexane) affording a mixture of two regioisomers (2.15 g, 89%). Ethyl 1-benzyl-4-(5'-*O*-acetyl-2',3'-*O*-cyclopentylidene-β-D-ribofuranosyl)-1,2,3-triazole-5-carboxylate:  $[\alpha]_{\text{D}}^{25} -4.25$  (c 0.75, CHCl<sub>3</sub>). <sup>1</sup>H NMR (400 MHz, CDCl<sub>3</sub>) δ 7.35-7.25 (m, 5H, Ph), 5.89 (d, *J* = 14.6 Hz, 1H, CH<sub>2</sub>Ph), 5.85 (d, *J* = 14.6 Hz, 1H, CH<sub>2</sub>Ph), 5.53 (d, *J* = 3.6 Hz, 1H, H<sub>1'</sub>), 5.23 (dd, *J* = 6.4, 3.6 Hz, 1H, H<sub>2'</sub>), 4.77 (dd, *J* = 6.4 Hz, 3.6 Hz, 1H, H<sub>3'</sub>), 4.35 (q, *J* = 7.0 Hz, 2H, OCH<sub>2</sub>CH<sub>3</sub>), 4.32-4.25 (m, 2H, H<sub>4'</sub>, H<sub>5'</sub>), 4.16-4.07 (m, 1H, H<sub>5'</sub>), 2.03 (s, 3H, OAc), 2.03-1.98 (m, 2H, cyclopent.), 1.80-1.62 (m, 6H, cyclopent.), 1.34 (t, *J* = 7.0 Hz, 3H, CH<sub>3</sub>CH<sub>2</sub>O). <sup>13</sup>C NMR (100 MHz, CDCl<sub>3</sub>) δ 170.8 (COCH<sub>3</sub>), 158.3 (CO<sub>2</sub>Et), 148.6 (C<sub>4</sub>), 134.9 (Ph), 128.8 (Ph), 128.5 (Ph), 128.1 (Ph), 125.8 (C<sub>5</sub>), 123.8 (Cq cyclopent.), 84.3 (C<sub>2'</sub>), 83.2 (C<sub>4'</sub>), 82.7 (C<sub>3'</sub>), 77.8 (C<sub>1'</sub>), 64.6 (C<sub>5'</sub>), 62.3 (OCH<sub>2</sub>CH<sub>3</sub>), 54.3 (CH<sub>2</sub>Ph), 36.8 (CH<sub>2</sub> cyclopent.), 23.7 (CH<sub>2</sub> cyclopent.), 23.3 (CH<sub>2</sub> cyclopent.), 21.0 (OAc), 14.2 (CH<sub>3</sub>CH<sub>2</sub>O). HRMS (ESI) calcd for C<sub>24</sub>H<sub>30</sub>O<sub>7</sub>N<sub>3</sub> [M+H]<sup>+</sup>: 472.2084; found, 472.2099. Ethyl 1-benzyl-5-(5'-*O*-acetyl-2',3'-*O*-cyclopentylidene-β-D-ribofuranosyl)-1,2,3-triazole-4-carboxylate:  $[\alpha]_{\text{D}}^{25} +0.19$  (c 1.1, CHCl<sub>3</sub>). <sup>1</sup>H NMR (400 MHz, CDCl<sub>3</sub>) δ 7.36-7.24 (m, 3H, Ph), 7.18-7.10 (m, 2H, Ph), 5.74 (d, *J* = 15 Hz, 1H, CH<sub>2</sub>Ph), 5.69 (d, *J* = 15 Hz, 1H, CH<sub>2</sub>Ph), 5.54 (d, *J* = 4.9 Hz, 1H, H<sub>1'</sub>), 4.50-4.33 (m, 4H, OCH<sub>2</sub>CH<sub>3</sub>, H<sub>2'</sub>, H<sub>3'</sub>), 4.33-4.22 (m, 2H, H<sub>5'</sub>), 4.17-4.07 (m, 1H, H<sub>4'</sub>), 2.05 (s, 3H, OAc), 1.94 (m,



2H, cyclopent.), 1.71-1.50 (m, 6H, cyclopent.), 1.40 (t,  $J = 6.5$  Hz, 3H, CH<sub>3</sub>CH<sub>2</sub>O). <sup>13</sup>C NMR (100 MHz, CDCl<sub>3</sub>)  $\delta$  170.7 (COCH<sub>3</sub>), 161.1 (CO<sub>2</sub>Et), 137.8 (C<sub>5</sub>), 137.7 (C<sub>4</sub>), 134.8 (Ph), 129.1 (Ph), 128.7 (Ph), 127.1 (Ph), 125.4 (Cq cyclopent.), 84.3 (C<sub>2'</sub>), 82.4 (C<sub>4'</sub>), 81.3 (C<sub>3'</sub>), 76.3 (C<sub>1'</sub>), 63.7 (C<sub>5'</sub>), 61.6 (OCH<sub>2</sub>CH<sub>3</sub>), 53.2 (CH<sub>2</sub>Ph), 36.7 (CH<sub>2</sub> cyclopent.), 36.7 (CH<sub>2</sub> cyclopent.), 23.5 (CH<sub>2</sub> cyclopent.), 23.2 (CH<sub>2</sub> cyclopent.), 20.9 (OAc), 14.4 (CH<sub>3</sub>CH<sub>2</sub>O). HRMS (ESI) calcd for C<sub>24</sub>H<sub>30</sub>O<sub>7</sub>N<sub>3</sub> [M+H]<sup>+</sup>: 472.2084; found, 472.2071. A solution of the above compounds mixture (2.045 g, 4.34 mmol) in methanol was treated with NH<sub>3</sub> gas at 0°C for 2 hours. After stirring at room temperature for 5 hours and concentration under reduced pressure, the crude was purified by flash chromatography on silica gel (50% to 100% AcOEt in cyclohexane) the mixture of two regioisomers as white solids (1.565 g, 92%). 1-Benzyl-4-(2',3'-*O*-cyclopentylidene- $\beta$ -D-ribofuranosyl)-1,2,3-triazole-5-carboxamide: m.p. 106-107°C.  $[\alpha]_D^{25}$  -9.13 (c 0.95, CHCl<sub>3</sub>). <sup>1</sup>H NMR (400 MHz, CDCl<sub>3</sub>)  $\delta$  = 7.40-7.20 (m, 5H, Ph), 5.88 (d,  $J = 15.5$  Hz, 1H, CH<sub>2</sub>Ph), 5.86 (d,  $J = 15.5$  Hz, 1H, CH<sub>2</sub>Ph), 5.19 (bs, 2H, H<sub>1'</sub>, H<sub>2'</sub>), 4.78 (bs, 1H, H<sub>3'</sub>), 4.28 (bs, 1H, H<sub>4'</sub>), 3.78 (d,  $J = 12.3$  Hz, 1H, H<sub>5'</sub>), 3.60 (d,  $J = 12.3$  Hz, 1H, H<sub>5'</sub>), 2.04-1.98 (m, 2H, cyclopent.), 1.82-1.61 (m, 6H, cyclopent.). <sup>13</sup>C NMR (100 MHz, CDCl<sub>3</sub>)  $\delta$  159.5 (CONH<sub>2</sub>), 144.7 (C<sub>4</sub>), 135.2 (Ph), 128.8 (Ph), 128.5 (C<sub>5</sub>), 128.4 (Ph), 124.4 (Cq cyclopent.), 85.6 (C<sub>4'</sub>), 83.4 (C<sub>1'</sub>), 81.9 (C<sub>3'</sub>), 78.8 (C<sub>2'</sub>), 62.1 (C<sub>5'</sub>), 53.7 (CH<sub>2</sub>Ph), 36.6 (CH<sub>2</sub> cyclopent.), 36.5 (CH<sub>2</sub> cyclopent.), 23.7 (CH<sub>2</sub> cyclopent.), 23.2 (CH<sub>2</sub> cyclopent.). HRMS (ESI) calcd for C<sub>20</sub>H<sub>25</sub>O<sub>5</sub>N<sub>3</sub> [M+H]<sup>+</sup>: 401.1819; found, 401.1825. 1-Benzyl-5-(2',3'-*O*-cyclopentylidene- $\beta$ -D-ribofuranosyl)-1,2,3-triazole-4-carboxamide: m.p. = 125-126 °C.  $[\alpha]_D^{25}$  -4.05 (c 1.0, CHCl<sub>3</sub>). <sup>1</sup>H NMR (400 MHz, CDCl<sub>3</sub>)  $\delta$  7.35-7.17 (m, 5H, Ph), 5.67 (d,  $J = 16.7$  Hz, 1H, CH<sub>2</sub>Ph), 5.63 (d,  $J = 16.7$  Hz, 1H, CH<sub>2</sub>Ph), 4.97 (m, 3H, H<sub>1'</sub>, H<sub>2'</sub>, H<sub>3'</sub>), 4.20 (bs, 1H, H<sub>4'</sub>), 3.88 (d,  $J = 12.8$  Hz, 1H, H<sub>5'</sub>), 3.73 (d,  $J = 12.8$  Hz, 1H, H<sub>5'</sub>), 1.98-1.85 (m, 2H, cyclopent.), 1.72-1.53 (m, 6H, cyclopent.). <sup>13</sup>C NMR (100 MHz, CDCl<sub>3</sub>)  $\delta$  162.6 (CONH<sub>2</sub>), 139.2 (C<sub>5</sub>), 137.0 (C<sub>4</sub>), 134.1 (Ph), 129.2 (Ph), 127.0 (Ph), 124.4 (Cq cyclopent.), 85.3 (C<sub>4'</sub>), 84.0 (C<sub>1'</sub>), 81.8 (C<sub>3'</sub>), 76.2 (C<sub>2'</sub>), 62.6 (C<sub>5'</sub>), 52.8 (CH<sub>2</sub>Ph), 36.7 (CH<sub>2</sub> cyclopent.), 23.6 (CH<sub>2</sub> cyclopent.), 23.3 (CH<sub>2</sub> cyclopent.), 23.1 (CH<sub>2</sub> cyclopent.). HRMS (ESI) calcd for C<sub>20</sub>H<sub>25</sub>O<sub>5</sub>N<sub>3</sub> [M+H]<sup>+</sup>: 401.1819; found, 401.1827. A solution of the above compounds mixture (1.5 g, 3.75 mmol) containing palladium on charcoal (360 mg) was treated in an autoclave under 6 bar of H<sub>2</sub> for 3 days. The mixture was filtered on Celite and rinsed abundantly with ethanol. After concentration under reduced pressure, the crude was purified by flash chromatography on silica gel (100% AcOEt to 10% MeOH in AcOEt) affording **12** as a white solid (337 mg, 29%). m.p. = 181-182 °C.  $[\alpha]_D^{25}$

-1.54 (c 1.0, MeOH). <sup>1</sup>H NMR (400 MHz, MeOD) δ 5.51 (d, *J* = 4.3 Hz, 1H, H<sub>1'</sub>), 4.90-4.84 (m, 1H, H<sub>2'</sub>), 4.73 (dd, *J* = 6.7, 3.9 Hz, 1H, H<sub>3'</sub>), 4.13 (ddd, *J* = 4.2, 4.2, 3.9 Hz, 1H, H<sub>4'</sub>), 3.72 (dd, *J* = 12.0, 4.2 Hz, 1H, H<sub>5'</sub>), 3.65 (dd, *J* = 12.0, 4.2 Hz, 1H, H<sub>5'</sub>), 2.07-1.93 (m, 2H, CH<sub>2</sub> cyclopent.), 1.79-1.59 (m, 6H, CH<sub>2</sub> cyclopent.). <sup>13</sup>C NMR (100 MHz, MeOD) δ 163.5 (CONH<sub>2</sub>), 143.5 (C<sub>5</sub>), 137.8 (C<sub>4</sub>), 123.6 (C<sub>q</sub> cyclopent.), 85.5 (C<sub>4'</sub>), 85.0 (C<sub>2'</sub>), 81.7 (C<sub>3'</sub>), 77.5 (C<sub>1'</sub>), 61.8 (C<sub>5'</sub>), 36.4 (CH<sub>2</sub> cyclopent.), 36.3 (CH<sub>2</sub> cyclopent.), 23.2 (CH<sub>2</sub> cyclopent.), 22.8 (CH<sub>2</sub> cyclopent.). HRMS (ESI) calcd for C<sub>13</sub>H<sub>19</sub>N<sub>4</sub>O<sub>5</sub> [M+H]<sup>+</sup>: 311.1355; found, 311.1357.

#### 4.1.5. General procedure for the preparation of phosphoramidate reagents.

To a stirred solution of L-alanine or L-valine ester hydrochloride (3.0 mmol) in anhydrous dichloromethane (3 mL) at -70°C, triethylamine (668 mg, 0.92 mL, 6.6 mmol) was added dropwise over 15 min. Then solution of phenyl dichlorophosphate (633 mg, 0.44 mL, 3.0 mmol) in anhydrous dichloromethane (3 mL) was added over 1 h. The reaction mixture was stirred at this temperature for additional 30 min and then allowed to warm to 0°C over 2 h and stirred for 1 h. Next, to this mixture a solution of 2,3,4,5,6-pentafluoro phenol (552 mg, 3.0 mmol) and triethylamine (334 mg, 0.46 mL, 3.3 mmol) in dichloromethane (2 mL) was added over 20 min. The crude mixture was allowed to stir at 0°C for 4h, and the white solid (triethylamine hydrochloride) was filtered off and washed with dichloromethane (1×2 mL). The filtrate was concentrated under reduced pressure, the residue was triturated with TBME (9 mL), and the triethylamine hydrochloride salt was removed by filtration. The cake was washed with TBME (2×2 mL), and the combined filtrate was concentrated under reduced pressure to give a crude solid containing an even mixture of diastereomers. The mixture was triturated with 20% EtOAc in cyclohexane (6 mL), collected by filtration (or chromatographed using the same gradient) and then recrystallized from the mixture of cyclohexane/Et<sub>2</sub>O (2:1) 15 mL to give **8** as white crystals of *S<sub>P</sub>* diastereomer (> 99% d.e. as determined by NMR) except for **8c** which was obtained as a diastereomer mixture.

##### 4.1.5.1. Ethyl (*S*)-2-[-(*S*)-(2,3,4,5,6-pentafluorophenoxy)-phenoxy-phosphorylamino] propanoate (**8a**)

L-Alanine ethyl ester hydrochloride (461 mg, 3 mmol) was used as a starting material for the preparation of **8a** (400 mg, 30%). [ $\alpha$ ]<sub>D</sub><sup>25</sup> (c 1, CHCl<sub>3</sub>) +3.26; mp 95-97 °C. <sup>31</sup>P NMR (162 MHz,

CDCl<sub>3</sub>):  $\delta$  -1.01. <sup>1</sup>H NMR (400 MHz, CDCl<sub>3</sub>):  $\delta$  7.37-7.33 (m, 2H, Ph), 7.26-7.20 (m, 3H, Ph), 4.17 (q, 2H,  $J$  = 7.1 Hz, CH<sub>2</sub>O), 4.13 (m, 1H, CH $\alpha$ ), 4.10-4.06 (dd,  $J$  = 12.0, 9.7 Hz, 1H, NH), 1.46 (d,  $J$  = 6.9 Hz, 3H, CH<sub>3</sub>CH), 1.26 (t,  $J$  = 7.1 Hz, 3H, CH<sub>3</sub>CH<sub>2</sub>O). <sup>13</sup>C NMR (100 MHz, CDCl<sub>3</sub>):  $\delta$  173.0 (d,  $J_{CP}$  = 8.5 Hz, CO<sub>2</sub>Et), 150.2 (d,  $J_{CP}$  = 7.0 Hz, Ph), 142.8-136.5 (m, C<sub>6</sub>F<sub>5</sub>), 129.9 (Ph), 125.7 (Ph), 120.1 (d,  $J_{CP}$  = 4.8 Hz, Ph), 61.9 (CH<sub>2</sub>O), 50.6 (CH $\alpha$ ), 21.0 (d,  $J_{CP}$  = 4.5 Hz, CH<sub>3</sub>CH), 14.1 (CH<sub>3</sub>CH<sub>2</sub>O). HRMS (ESI) calculated for C<sub>17</sub>H<sub>15</sub>NO<sub>5</sub>F<sub>5</sub>NaP [M+Na]<sup>+</sup>: 462.0506; found 462.0514.

4.1.5.2. *Isopropyl (S)-2-[-(S)-(2,3,4,5,6-pentafluorophenoxy)-phenoxy-phosphorylamino] propanoate (8b)*

L-Alanine isopropyl ester hydrochloride (503 mg, 3 mmol) was used as a starting material for the preparation of **8b** (420 mg, 31%). [ $\alpha$ ]<sub>D</sub><sup>25</sup> (c 1, CHCl<sub>3</sub>) +4.09; mp 129-131 °C. <sup>31</sup>P NMR (162 MHz, CDCl<sub>3</sub>):  $\delta$  -0.93. <sup>1</sup>H NMR (400 MHz, CDCl<sub>3</sub>):  $\delta$  = 7.37-7.33 (m, 2H, Ph), 7.24-7.19 (m, 3H, Ph), 5.03 (sept,  $J$  = 6.1 Hz, 1H, CH(CH<sub>3</sub>)<sub>2</sub>), 4.16-4.03 (m, 2H, CH $\alpha$ , NH), 1.45 (d,  $J$  = 6.8 Hz, 3H), 1.24 (d,  $J$  = 5.9 Hz, 3H, (CH<sub>3</sub>)<sub>2</sub>CH), 1.22 (d,  $J$  = 5.9 Hz, 3H, (CH<sub>3</sub>)<sub>2</sub>CH). <sup>13</sup>C NMR (100 MHz, CDCl<sub>3</sub>):  $\delta$  172.6 (d,  $J_{CP}$  = 8.5 Hz, CO<sub>2</sub>*i*Pr), 150.2 (d,  $J_{CP}$  = 7.1 Hz, Ph), 142.7-136.5 (m, C<sub>6</sub>F<sub>5</sub>), 129.9 (Ph), 125.7 (Ph), 120.1 (d,  $J_{CP}$  = 4.8 Hz, Ph), 69.6 (CHO), 50.7 (CH $\alpha$ ), 21.7 ((CH<sub>3</sub>)<sub>2</sub>CH), 21.0 (d,  $J_{CP}$  = 3.4 Hz, CH<sub>3</sub>CH). HRMS (ESI) calculated for C<sub>18</sub>H<sub>18</sub>NO<sub>5</sub>F<sub>5</sub>NP [M+H]<sup>+</sup>: 454.0843; found 454.0844.

4.1.5.3. *Benzyl (S)-2-[-(S)-(2,3,4,5,6-pentafluorophenoxy)-phenoxy-phosphorylamino] propanoate (8c)*

L-Alanine benzyl ester hydrochloride (647 mg, 3 mmol) was used as a starting material for the preparation of **8c** (362 mg, 24%) obtained as a diastereomer mixture around 6/4. *Major diastereomer*: <sup>31</sup>P NMR (162 MHz, CDCl<sub>3</sub>):  $\delta$  -1.15. <sup>1</sup>H NMR (400 MHz, CDCl<sub>3</sub>):  $\delta$  7.43-7.13 (m, 10H), 5.13 (d,  $J$  = 16.3 Hz, 1H, CH<sub>2</sub>Ph), 5.09 (d,  $J$  = 16.3 Hz, 1H, CH<sub>2</sub>Ph), 4.28-4.18 (m, 1H, CH $\alpha$ ), 3.99 (dd,  $J$  = 11.7, 10.1 Hz, 1H, NH), 1.38 (d,  $J$  = 6.9 Hz, 3H, CH<sub>3</sub>). <sup>13</sup>C NMR (100 MHz, CDCl<sub>3</sub>):  $\delta$  172.9 (d,  $J_{CP}$  = 8.8 Hz, CO<sub>2</sub>Bn), 150.3 (d,  $J_{CP}$  = 6.7 Hz, Ph), 142.7-136.7 (m, C<sub>6</sub>F<sub>5</sub>), 135.1 (Ph), 130.0 (Ph), 128.9 (Ph), 128.8 (Ph), 128.5 (Ph), 128.4 (Ph), 125.8 (Ph), 120.2 (d,  $J_{CP}$  = 4.8 Hz, Ph), 67.7 (CH<sub>2</sub>Ph), 50.6 (CH $\alpha$ ), 21.1 (d,  $J_{CP}$  = 4.2 Hz, CH<sub>3</sub>CH). *Minor diastereomer*: <sup>31</sup>P NMR (162 MHz, CDCl<sub>3</sub>): -1.08. <sup>1</sup>H NMR (400 MHz, CDCl<sub>3</sub>):  $\delta$  7.43-7.13 (m, 10H), 5.11 (d,  $J$  =

16.3 Hz, 1H, CH<sub>2</sub>Ph), 5.06 (d,  $J = 16.3$  Hz, 1H, CH<sub>2</sub>Ph), 4.28-4.18 (m, 1H, CH $\alpha$ ), 3.99 (dd,  $J = 11.7, 10.1$  Hz, 1H, NH), 1.40 (d,  $J = 6.9$  Hz, 3H, CH<sub>3</sub>). <sup>13</sup>C NMR (100 MHz, CDCl<sub>3</sub>):  $\delta$  173.0 (d,  $J_{CP} = 8.5$  Hz, CO<sub>2</sub>Bn), 150.2 (d,  $J_{CP} = 6.7$  Hz, Ph), 142.7-136.7 (m, C<sub>6</sub>F<sub>5</sub>), 135.1 (Ph), 130.0 (Ph), 128.9 (Ph), 128.8 (Ph), 128.5 (Ph), 128.4 (Ph), 125.8 (Ph), 120.2 (d,  $J_{CP} = 4.8$  Hz, Ph), 67.6 (CH<sub>2</sub>Ph), 50.6 (CH $\alpha$ ), 21.0 (d,  $J_{CP} = 5.0$  Hz, CH<sub>3</sub>CH, min). HRMS (ESI) calculated for C<sub>22</sub>H<sub>17</sub>NO<sub>5</sub>F<sub>5</sub>NaP [M+Na]<sup>+</sup>: 524.0662; found 524.0669.

#### 4.1.5.4. Ethyl (S)-2-[-(S)-(2,3,4,5,6-pentafluorophenoxy)-phenoxy-phosphorylamino] 3-methylbutanoate (**8d**)

L-Valine ethyl ester hydrochloride (546 mg, 3 mmol) was used as a starting material for the preparation of **8d** (445 mg, 32%). [ $\alpha$ ]<sub>D</sub><sup>25</sup> (c 1, CHCl<sub>3</sub>) +5.54; mp 132-134 °C. <sup>31</sup>P NMR (162 MHz, CDCl<sub>3</sub>):  $\delta$  0.22. <sup>1</sup>H NMR (400 MHz, CDCl<sub>3</sub>):  $\delta$  7.37-7.33 (m, 2H, Ph), 7.24-7.18 (m, 3H, Ph), 4.17 (q,  $J = 7.1$  Hz, 2H, CH<sub>2</sub>O), 3.96 (ddd,  $J = 10.6, 10.2, 4.5$  Hz, 1H, CH $\alpha$ ), 3.89 (dd,  $J = 10.6, 10.6$  Hz, 1H, NH), 2.10 (m, 1H, CH(CH<sub>3</sub>)<sub>2</sub>), 1.25 (t,  $J = 7.2$  Hz, 3H, CH<sub>3</sub>CH<sub>2</sub>O), 0.95 (d,  $J = 6.8$  Hz, 3H, (CH<sub>3</sub>)<sub>2</sub>CH), 0.89 (d,  $J = 6.9$  Hz, 3H, (CH<sub>3</sub>)<sub>2</sub>CH). <sup>13</sup>C NMR (100 MHz, CDCl<sub>3</sub>):  $\delta$  172.1 (d,  $J_{CP} = 5.4$  Hz, CO<sub>2</sub>Et), 150.3 (d,  $J_{CP} = 7.3$  Hz, Ph), 142.8-136.6 (m, C<sub>6</sub>F<sub>5</sub>), 129.9 (Ph), 125.7 (Ph), 120.2 (d,  $J_{CP} = 4.9$  Hz, Ph), 61.6 (CH<sub>2</sub>O), 60.0 (CH $\alpha$ ), 32.5 (d,  $J_{CP} = 5.3$  Hz, CH(CH<sub>3</sub>)<sub>2</sub>), 18.7 ((CH<sub>3</sub>)<sub>2</sub>CH), 17.3 ((CH<sub>3</sub>)<sub>2</sub>CH), 14.2 (CH<sub>3</sub>CH<sub>2</sub>O). HRMS (ESI) calculated for C<sub>19</sub>H<sub>20</sub>NO<sub>5</sub>F<sub>5</sub>P [M+H]<sup>+</sup>: 468.0999; found 468.1006.

#### 4.1.5.5. Benzyl (S)-2-[-(S)-(2,3,4,5,6-pentafluorophenoxy)-phenoxy-phosphorylamino] 3-methylbutanoate (**8e**)

L-Valine benzyl ester hydrochloride (731 mg, 3 mmol) was used as a starting material for the preparation of **8e** (351 mg, 22%). [ $\alpha$ ]<sub>D</sub><sup>25</sup> (c 1, CHCl<sub>3</sub>) +5.22; mp 132-134 °C. <sup>31</sup>P NMR (162 MHz, CDCl<sub>3</sub>):  $\delta$  0.18. <sup>1</sup>H NMR (400 MHz, CDCl<sub>3</sub>):  $\delta$  7.37-7.19 (m, 10H, Ph), 5.14 (s, 2H, CH<sub>2</sub>Ph), 4.03 (ddd,  $J = 10.4, 10.2, 4.5$  Hz, 1H, CH $\alpha$ ), 3.88 (dd,  $J = 10.7, 10.4$  Hz, 1H, NH), 2.12 (m, 1H, CH(CH<sub>3</sub>)<sub>2</sub>), 0.93 (d,  $J = 6.8$  Hz, 3H), 0.86 (d,  $J = 6.9$  Hz, 3H). <sup>13</sup>C NMR (100 MHz, CDCl<sub>3</sub>):  $\delta$  172.0 (d,  $J_{CP} = 5.2$  Hz, CO<sub>2</sub>Bn), 150.3 (d,  $J_{CP} = 6.9$  Hz, Ph), 142.7-136.5 (m, C<sub>6</sub>F<sub>5</sub>), 135.2 (Ph), 129.9 (Ph), 128.7 (Ph), 128.6 (Ph), 128.5 (Ph), 125.7 (Ph), 120.2 (d,  $J_{CP} = 4.8$  Hz, Ph), 67.4 (CH<sub>2</sub>O), 60.1 (CH $\alpha$ ), 32.4 (d,  $J_{CP} = 5.3$  Hz, CH(CH<sub>3</sub>)<sub>3</sub>), 18.8 ((CH<sub>3</sub>)<sub>3</sub>CH), 17.2 ((CH<sub>3</sub>)<sub>3</sub>CH). HRMS (ESI) calculated for C<sub>24</sub>H<sub>21</sub>NO<sub>5</sub>F<sub>5</sub>NaP [M+Na]<sup>+</sup>: 552.0975; found 552.0975.

#### 4.1.6. General procedure for the nucleoside and phosphoramidate coupling.

To a stirred solution of nucleoside **1** or **7** (0.3 mmol) in dry THF (1 mL) a 1.7M solution of *tert*-butylmagnesium chloride in THF (0.37 mL, 0.63 mmol) was added dropwise. The white suspension was stirred for 30 min and a solution of phosphoramidate reagent **7a-e** (0.63 mmol) in THF (1 mL) was added over a period of 30 min. The mixture was stirred for 18h, then quenched with methanol (1 mL) and concentrated under reduced pressure. The residue was purified by flash column chromatography on silica gel (70% EtOAc in cyclohexane to remove less polar impurities and 5-10% MeOH in DCM to elute the product) affording nucleoside phosphoramidate **9a, 10** as white crystalline solid. Single diastereomer was detected (except for **10c**) and stereochemistry was assigned as *S<sub>P</sub>*, based on the known stereochemistry of the phosphoramidate reagent.

##### 4.1.6.1. 5-(2',3'-*O*-Isopropylidene- $\beta$ -D-ribofuranosyl)-2*H*-1,2,3-triazole-4-carboxamide-5'-[1-phenyl(ethoxy-*L*-alaninyl)] phosphate (**10a**)

Nucleoside **7** (79 mg, 0.275 mmol) and phosphoramidate reagent **8a** were used as starting compounds for the preparation of **10a** (62 mg, 42%).  $[\alpha]_D^{25}$  (c 1, MeOH)  $-12.45$ ; mp 89-91 °C.  $^{31}\text{P}$  NMR (162 MHz, MeOD):  $\delta$  4.46.  $^1\text{H}$  NMR (400 MHz, MeOD):  $\delta$  7.34-7.30 (m, 2H, Ph), 7.22-7.14 (m, 3H, Ph), 5.50 (d,  $J = 3.8$  Hz, 1H, H<sub>1'</sub>), 4.95-4.91 (m, 1H, H<sub>2'</sub>), 4.79 (dd, 6.3, 3.4 Hz, 1H, H<sub>3'</sub>), 4.30-4.05 (m, 5H, CH<sub>2</sub>O, CH $\alpha$ , H<sub>4'</sub>, H<sub>5'</sub>), 3.92 (ddd,  $J = 14.3, 9.5, 7.4$  Hz, 1H, H<sub>5'</sub>), 1.56 (s, 3H, (CH<sub>3</sub>)<sub>2</sub>C), 1.33 (s, 3H, (CH<sub>3</sub>)<sub>2</sub>C), 1.32 (d,  $J = 7.5$  Hz, 3H, CH<sub>3</sub>CH), 1.22 (t,  $J = 7.1$  Hz, 3H, CH<sub>3</sub>CH<sub>2</sub>O).  $^{13}\text{C}$  NMR (100 MHz, MeOD):  $\delta$  174.8 (d,  $J_{\text{CP}} = 5.3$  Hz, CO<sub>2</sub>Et), 165.0 (CONH<sub>2</sub>), 152.0 (d,  $J_{\text{CP}} = 7.2$  Hz, Ph), 144.7 (C<sub>5</sub>), 139.2 (C<sub>4</sub>), 130.7 (Ph), 126.1 (Ph), 121.5 (d,  $J_{\text{CP}} = 4.5$  Hz, Ph), 115.6 ((C(CH<sub>3</sub>)<sub>2</sub>), 86.1 (C<sub>2'</sub>), 85.0 (d,  $J_{\text{CP}} = 7.6$  Hz, C<sub>4'</sub>), 83.2 (C<sub>3'</sub>), 79.5 (C<sub>1'</sub>), 67.7 (d,  $J_{\text{CP}} = 5.5$  Hz, C<sub>5'</sub>), 62.4 (CH<sub>2</sub>O), 51.5 (CH $\alpha$ ), 27.7 ((CH<sub>3</sub>)<sub>2</sub>C), 25.7 ((CH<sub>3</sub>)<sub>2</sub>C), 20.5 (d,  $J_{\text{CP}} = 6.4$  Hz, CH<sub>3</sub>CH), 14.4 (CH<sub>3</sub>CH<sub>2</sub>O). HRMS (ESI) calculated for C<sub>22</sub>H<sub>31</sub>N<sub>5</sub>O<sub>9</sub>P [M+H]<sup>+</sup>: 540.1859; found 540.1860.

##### 4.1.6.2. 5-(2',3'-*O*-Isopropylidene- $\beta$ -D-ribofuranosyl)-2*H*-1,2,3-triazole-4-carboxamide-5'-[1-phenyl((propan-2-yl)oxy)-*L*-alaninyl)] phosphate (**10b**)

Nucleoside **7** (85 mg, 0.3 mmol) and phosphoramidate reagent **8b** were used as starting compounds for the preparation of **10b** (72 mg, 43%).  $[\alpha]_D^{25}$  (c 1, MeOH)  $-11.96$ ; mp 68-70 °C.

<sup>31</sup>P NMR (162 MHz, MeOD): δ 4.53. <sup>1</sup>H NMR (400 MHz, MeOD): δ 7.34-7.30 (m, 2H), 7.22-7.15 (m, 3H), 5.58 (d, *J* = 3.8 Hz, 1H, H<sub>1'</sub>), 4.95 (sept, *J* = 6.2 Hz, 1H, CH(CH<sub>3</sub>)<sub>2</sub>), 4.94-4.88 (m, 1H, H<sub>2'</sub>), 4.79 (dd, 6.2, 3.2 Hz, 1H, H<sub>3'</sub>), 4.29-4.12 (m, 3H, CHα, H<sub>4'</sub>, H<sub>5'</sub>), 3.89 (ddd, *J* = 14.1, 10.1, 7.3 Hz, 1H, H<sub>5'</sub>), 1.56 (s, 3H, (CH<sub>3</sub>)<sub>2</sub>C), 1.33 (s, 3H, (CH<sub>3</sub>)<sub>2</sub>C), 1.31 (d, *J* = 7.4 Hz, 3H, CH<sub>3</sub>CH), 1.21 (d, *J* = 6.2 Hz, 6H, (CH<sub>3</sub>)<sub>2</sub>CH). <sup>13</sup>C NMR (100 MHz, MeOD): δ 174.4 (d, *J*<sub>CP</sub> = 5.5 Hz, CO<sub>2</sub>*i*Pr), 164.9 (CONH<sub>2</sub>), 152.1 (d, *J*<sub>CP</sub> = 7.3 Hz, Ph), 144.7 (C<sub>5</sub>), 139.3 (C<sub>4</sub>), 130.7 (Ph), 126.2 (Ph), 121.6 (d, *J*<sub>CP</sub> = 4.3 Hz, Ph), 115.6 ((C(CH<sub>3</sub>)<sub>2</sub>), 86.1 (C<sub>2'</sub>), 85.0 (d, *J*<sub>CP</sub> = 7.5 Hz, C<sub>4'</sub>), 83.2 (C<sub>3'</sub>), 79.4 (C<sub>1'</sub>), 70.1 (CH(CH<sub>3</sub>)<sub>3</sub>), 67.6 (d, *J*<sub>CP</sub> = 5.1 Hz, C<sub>5'</sub>), 51.6 (CHα), 27.7 ((CH<sub>3</sub>)<sub>2</sub>C), 25.7 ((CH<sub>3</sub>)<sub>2</sub>C), 22.0 ((CH<sub>3</sub>)<sub>2</sub>CH), 21.9 ((CH<sub>3</sub>)<sub>2</sub>CH), 20.5 (d, *J*<sub>CP</sub> = 6.3 Hz, CH<sub>3</sub>CH). HRMS (ESI) calculated for C<sub>23</sub>H<sub>33</sub>N<sub>5</sub>O<sub>9</sub>P [M+H]<sup>+</sup>: 554.2016; found 554.2012.

4.1.6.3. 5-(2',3'-*O*-Isopropylidene-β-*D*-ribofuranosyl)-2*H*-1,2,3-triazole-4-carboxamide-5'-[1-phenyl(benzyloxy-*L*-alaninyl)] phosphate (**10c**)

Nucleoside **7** (71 mg, 0.25 mmol) and phosphoramidate reagent **8c** were used as starting compounds for the preparation of **10c** (83 mg, 55%) obtained as a diastereomer mixture around 6/4. *Major diastereomer*: <sup>31</sup>P NMR (162 MHz, MeOD): δ 4.45. <sup>1</sup>H NMR (400 MHz, MeOD): δ 7.35-7.10 (m, 10H), 5.59 (d, *J* = 4.0 Hz, 1H, H<sub>1'</sub>), 5.13 (d, *J* = 12.3 Hz, 1H, CH<sub>2</sub>Ph), 5.08 (d, *J* = 12.3 Hz, 1H, CH<sub>2</sub>Ph), 4.93 (dd, *J* = 6.4, 4.0 Hz, 1H, H<sub>2'</sub>), 4.77-4.71 (m, 1H, H<sub>3'</sub>), 4.32-4.07 (m, 3H, CHα, H<sub>4'</sub>, H<sub>5'</sub>), 4.05-3.93 (m, 1H, H<sub>5'</sub>), 1.55 (s, 3H, (CH<sub>3</sub>)<sub>2</sub>C), 1.31 (s, 3H, (CH<sub>3</sub>)<sub>2</sub>C), 1.29 (d, *J* = 7.3 Hz, 3H, CH<sub>3</sub>CH). <sup>13</sup>C NMR (100 MHz, MeOD): δ 175.0 (d, *J*<sub>CP</sub> = 3.4 Hz, CO<sub>2</sub>Bn), 165.1 (CONH<sub>2</sub>), 152.2 (d, *J*<sub>CP</sub> = 5.5 Hz, Ph), 144.8 (C<sub>5</sub>), 139.3 (C<sub>4</sub>), 137.3 (Ph), 130.8 (Ph), 129.7 (Ph), 129.4 (Ph), 126.3 (Ph), 121.7 (d, *J*<sub>CP</sub> = 2.4 Hz, Ph), 115.6 ((C(CH<sub>3</sub>)<sub>2</sub>), 86.2 (C<sub>2'</sub>), 85.0 (d, *J*<sub>CP</sub> = 6.9 Hz, C<sub>4'</sub>), 83.1 (C<sub>3'</sub>), 79.6 (C<sub>1'</sub>), 68.0 (CH<sub>2</sub>Ph), 67.7 (d, *J*<sub>CP</sub> = 5.1 Hz, C<sub>5'</sub>), 51.8 (CHα), 27.8 ((CH<sub>3</sub>)<sub>2</sub>C), 25.8 ((CH<sub>3</sub>)<sub>2</sub>C), 20.4 (d, *J*<sub>CP</sub> = 7.0 Hz, CH<sub>3</sub>CH). *Minor diastereomer*: <sup>31</sup>P NMR (162 MHz, MeOD): δ 4.40. <sup>1</sup>H NMR (400 MHz, MeOD): δ 7.35-7.10 (m, 10H), 5.58 (d, *J* = 3.9 Hz, 1H, H<sub>1'</sub>), 5.11 (d, *J* = 12.5 Hz, 1H, CH<sub>2</sub>Ph), 5.07 (d, *J* = 12.5 Hz, 1H, CH<sub>2</sub>Ph), 4.89 (dd, *J* = 6.4, 3.9 Hz, 1H, H<sub>2'</sub>), 4.77-4.71 (m, 1H, H<sub>3'</sub>), 4.32-4.07 (m, 3H, CHα, H<sub>4'</sub>, H<sub>5'</sub>), 4.05-3.93 (m, 1H, H<sub>5'</sub>), 1.54 (s, 3H, (CH<sub>3</sub>)<sub>2</sub>C, min), 1.33 (d, *J* = 7.5 Hz, 3H, CH<sub>3</sub>CH, min), 1.31 (s, 3H, (CH<sub>3</sub>)<sub>2</sub>C). <sup>13</sup>C NMR (100 MHz, MeOD): δ 174.8 (d, *J*<sub>CP</sub> = 3.9 Hz, CO<sub>2</sub>Bn), 165.1 (CONH<sub>2</sub>), 152.2 (d, *J*<sub>CP</sub> = 5.5 Hz, Ph), 144.7 (C<sub>5</sub>), 139.3 (C<sub>4</sub>), 137.3 (Ph), 130.8 (Ph), 129.7 (Ph), 129.4 (Ph), 126.3 (Ph), 121.7 (d, *J*<sub>CP</sub> = 2.4 Hz, Ph), 115.5 ((C(CH<sub>3</sub>)<sub>2</sub>), 86.2 (C<sub>2'</sub>), 85.0 (d, *J*<sub>CP</sub> = 6.9 Hz, C<sub>4'</sub>), 83.2 (C<sub>3'</sub>),

79.5 (C<sub>1'</sub>), 68.1 (CH<sub>2</sub>Ph), 67.8 (d,  $J_{CP}$  = 5.1 Hz, C<sub>5'</sub>), 51.6 (CH $\alpha$ ), 51.8 (CH $\alpha$ ), 27.8 ((CH<sub>3</sub>)<sub>2</sub>C), 25.8 ((CH<sub>3</sub>)<sub>2</sub>C), 20.5 (d,  $J_{CP}$  = 6.4 Hz, CH<sub>3</sub>CH). HRMS (ESI) calculated for C<sub>27</sub>H<sub>33</sub>N<sub>5</sub>O<sub>9</sub>P [M+H]<sup>+</sup>: 602.2016; found 602.2018.

4.1.6.4. 5-(2',3'-O-Isopropylidene- $\beta$ -D-ribofuranosyl)-2H-1,2,3-triazole-4-carboxamide-5'-[1-phenyl(ethoxy-L-valinyl)] phosphate (**10d**)

Nucleoside **7** (79 mg, 0.275 mmol) and phosphoramidate reagent **8d** were used as starting compounds for the preparation of **10d** (60 mg, 38%).  $[\alpha]_D^{25}$  (c 1, MeOH) -11.89; mp 66-68 °C. <sup>31</sup>P NMR (162 MHz, MeOD):  $\delta$  5.30. <sup>1</sup>H NMR (400 MHz, MeOD):  $\delta$  7.32-7.30 (m, 2H), 7.20-7.140 (m, 3H), 5.57 (d,  $J$  = 3.8 Hz, 1H, H<sub>1'</sub>), 4.98-4.88 (m, 1H, H<sub>2'</sub>), 4.80 (dd,  $J$  = 6.4, 3.3 Hz, 1H, H<sub>3'</sub>), 4.29-4.15 (m, 3H, CH<sub>2</sub>O, H<sub>4'</sub>), 4.11 (ddd,  $J$  = 14.4, 7.1, 3.9, 1H, H<sub>5'</sub>), 4.08 (ddd,  $J$  = 14.4, 10.7, 7 Hz, 1H, H<sub>5'</sub>), 3.63 (dd,  $J$  = 9.9, 6.3 Hz, 1H, CH $\alpha$ ), 2.05-1.95 (m, 1H, CH(CH<sub>3</sub>)<sub>2</sub>), 1.56 (s, 3H, (CH<sub>3</sub>)<sub>2</sub>C), 1.34 (s, 3H, (CH<sub>3</sub>)<sub>2</sub>C), 1.21 (t,  $J$  = 7.1 Hz, 3H, CH<sub>3</sub>CH<sub>2</sub>O), 0.91 (d,  $J$  = 7.3 Hz, 3H, (CH<sub>3</sub>)<sub>2</sub>CH), 0.90 (d,  $J$  = 7.3 Hz, 3H, (CH<sub>3</sub>)<sub>2</sub>CH). <sup>13</sup>C NMR (100 MHz, MeOD):  $\delta$  174.0(d,  $J_{CP}$  = 3.0 Hz, CO<sub>2</sub>Et), 164.9 (CONH<sub>2</sub>), 152.1 (d,  $J_{CP}$  = 7.1 Hz, Ph), 144.9 (C<sub>5</sub>), 139.3 (C<sub>4</sub>), 130.7 (Ph), 126.1 (Ph), 121.5 (d,  $J_{CP}$  = 4.6 Hz, Ph), 115.6 (C(CH<sub>3</sub>)<sub>2</sub>), 86.1 (C<sub>2'</sub>), 85.0 (d,  $J_{CP}$  = 7.5 Hz, C<sub>4'</sub>), 83.2 (C<sub>3'</sub>), 79.4 (C<sub>1'</sub>), 67.8 (d,  $J_{CP}$  = 5.6 Hz, C<sub>5'</sub>), 62.1 CH<sub>2</sub>O, 61.8 (CH $\alpha$ ), 33.2 (d,  $J_{CP}$  = 6.9 Hz, CH(CH<sub>3</sub>)<sub>2</sub>), 27.6 ((CH<sub>3</sub>)<sub>2</sub>C), 25.7 ((CH<sub>3</sub>)<sub>2</sub>C), 19.5 ((CH<sub>3</sub>)<sub>2</sub>CH), 18.3 ((CH<sub>3</sub>)<sub>2</sub>CH), 14.5 (CH<sub>3</sub>CH<sub>2</sub>O). HRMS (ESI) calculated for C<sub>24</sub>H<sub>35</sub>N<sub>5</sub>O<sub>9</sub>P [M+H]<sup>+</sup>: 568.2172; found 568.2181.

4.1.6.5. 5-(2',3'-O-Isopropylidene- $\beta$ -D-ribofuranosyl)-2H-1,2,3-triazole-4-carboxamide-5'-[1-phenyl(benzyloxy-L-valinyl)] phosphate (**10e**)

Nucleoside **7** (79 mg, 0.275 mmol) and phosphoramidate reagent **8e** were used as starting compounds for the preparation of **10e** (68 mg, 39%).  $[\alpha]_D^{25}$  (c 1, MeOH) -14.48; mp 67-69 °C. <sup>31</sup>P NMR (162 MHz, MeOD):  $\delta$  5.27. <sup>1</sup>H NMR (400 MHz, MeOD):  $\delta$  7.38-7.25 (m, 7H), 7.19-7.11 (m, 3H), 5.57 (d,  $J$  = 3.7 Hz, 1H, H<sub>1'</sub>), 5.12 (d,  $J$  = 12.3 Hz, 1H, CH<sub>2</sub>Ph), 5.07 (d,  $J$  = 12.3 Hz, 1H, CH<sub>2</sub>Ph), 4.95-4.85 (m, 1H, H<sub>2'</sub>), 4.75 (dd,  $J$  = 6.4, 3.2, 1H, H<sub>3'</sub>), 4.25-4.18 (m, 2H, CH $\alpha$ , H<sub>4'</sub>), 4.12 (ddd,  $J$  = 14.2, 12.4, 7.1, 1H, H<sub>5'</sub>), 3.75-3.66 (m, 1H, H<sub>5'</sub>), 2.05-1.96 (m, 1H, CH(CH<sub>3</sub>)<sub>2</sub>), 1.55 (s, 3H, (CH<sub>3</sub>)<sub>2</sub>C), 1.32 (s, 3H, (CH<sub>3</sub>)<sub>2</sub>C), 0.88 (d,  $J$  = 6.9 Hz, 3H, (CH<sub>3</sub>)<sub>2</sub>CH), 0.86 (d,  $J$  = 6.9 Hz, 3H, (CH<sub>3</sub>)<sub>2</sub>CH). <sup>13</sup>C NMR (100 MHz, MeOD):  $\delta$  173.8 (d,  $J_{CP}$  = 3.0 Hz, CO<sub>2</sub>Bn), 164.8 (CONH<sub>2</sub>), 152.0 (d,  $J_{CP}$  = 6.9 Hz, Ph), 143.9 (C<sub>5</sub>), 139.3 (C<sub>4</sub>), 138.0 (Ph), 130.7 (Ph), 129.6 (Ph), 129.5 (Ph)

129.4 (Ph), 126.1 (Ph), 121.6 (d,  $J_{CP} = 4.5$  Hz, Ph), 115.6 (C(CH<sub>3</sub>)<sub>2</sub>), 86.1 (C<sub>2'</sub>), 84.9 (d,  $J_{CP} = 7.3$  Hz, C<sub>4'</sub>), 83.1 (C<sub>3'</sub>), 79.3 (C<sub>1'</sub>), 67.8 (CH<sub>2</sub>Bn), 67.7 (d,  $J_{CP} = 4.5$  Hz, C<sub>5'</sub>), 61.8 (CH $\alpha$ ), 33.2 (d,  $J_{CP} = 7.1$  Hz, CH(CH<sub>3</sub>)<sub>2</sub>), 27.6 ((CH<sub>3</sub>)<sub>2</sub>C), 25.7 ((CH<sub>3</sub>)<sub>2</sub>C), 19.5 ((CH<sub>3</sub>)<sub>2</sub>CH), 18.3 ((CH<sub>3</sub>)<sub>2</sub>CH). HRMS (ESI) calculated for C<sub>29</sub>H<sub>37</sub>N<sub>5</sub>O<sub>9</sub>P [M+H]<sup>+</sup>: 630.2329; found 630.2324.

4.1.6.6. *5-(2',3'-O-Cyclopentylidene- $\beta$ -D-ribofuranosyl)-2H-1,2,3-triazole-4-carboxamide-5'-[1-naphthyl(benzyloxy-L-alaninyl)] phosphate (13)*

Nucleoside **12** (200 mg, 0.64 mmol) and 1-naphthyl(benzyloxy-L-alaninyl)-phosphorochloridate (296 mg, 0.73 mmol) were used as starting compounds for the preparation of **13** (128 mg, 29%) as a 1/1 mixture of diastereomers. <sup>31</sup>P NMR (162 MHz, CDCl<sub>3</sub>)  $\delta$  4.90. <sup>1</sup>H NMR (400 MHz, CDCl<sub>3</sub>)  $\delta$  8.09-7.02 (m, 12H, Np, Ph), 5.76 (d,  $J = 3.8$  Hz, 0.5H, H<sub>1'</sub>), 5.66 (m, 1H, NH<sub>2</sub>), 5.53 (dd,  $J = 5.0, 16.5$  Hz, 0.5H, H<sub>1'</sub>), 5.14 (s, 1H, CH<sub>2</sub>Ph), 4.97 (d,  $J = 12.2$  Hz, 0.5H, CH<sub>2</sub>Ph), 4.89 (d,  $J = 12.2$  Hz, 0.5H, CH<sub>2</sub>Ph), 4.78-4.57 (m, 2H, H<sub>2'</sub>, H<sub>4'</sub>), 4.47 (t,  $J = 11.5$  Hz, 0.5H, H<sub>5'</sub>), 4.36 (t,  $J = 11.5$  Hz, 0.5H, H<sub>5'</sub>), 4.25-4.03 (m, 2.5H, H<sub>3'</sub>, CH $\alpha$ , H<sub>5'</sub>), 3.94 (t,  $J = 13.3$  Hz, 0.5H, H<sub>5'</sub>), 2.05-1.84 (m, 2H, CH<sub>2</sub> cyclopent.), 1.80-1.58 (m, 6H, CH<sub>2</sub> cyclopent.), 1.45 (d,  $J = 7.2$  Hz, 1.5H, CH<sub>3</sub>CH), 1.28 (d,  $J = 6.3$  Hz, 1.5H, CH<sub>3</sub>CH). <sup>13</sup>C NMR (100 MHz, CDCl<sub>3</sub>)  $\delta$  174.6 (d,  $J_{CP} = 4.8$  Hz, CO<sub>2</sub>Bn), 164.9 (CONH<sub>2</sub>), 147.9 (C<sub>5</sub>), 137.2 (C<sub>4</sub>), 136.2 (Ph), 129.6-122.8 (Np, Ph), 116.7 (C<sub>q</sub> cyclopent.), 115.3 (C<sub>q</sub> cyclopent.), 85.9 (C<sub>2'</sub>), 84.4 (d,  $J_{CP} = 6.5$  Hz, C<sub>4'</sub>), 82.9 (C<sub>3'</sub>), 78.9 (C<sub>1'</sub>), 68.0 (CH<sub>2</sub>Ph), 66.8 (d,  $J_{CP} = 6.1$  Hz, C<sub>5'</sub>), 51.7 (CH $\alpha$ ), 37.6 (CH<sub>2</sub> cyclopent.), 37.5 (CH<sub>2</sub> cyclopent.), 24.5 (CH<sub>2</sub> cyclopent.), 24.1 (CH<sub>2</sub> cyclopent.), 20.5 (CH<sub>3</sub>CH). HRMS (ESI) calcd for C<sub>33</sub>H<sub>37</sub>N<sub>5</sub>O<sub>9</sub>P [M+H]<sup>+</sup>: 678.2329; found 678.2329.

4.1.7. *General procedure for the deprotection. Synthesis of the final ProTides.*

To a solution of protected pronucleotide **10a-e** (0.125 mmol) in methanol/water (4:1, 5 mL) DOWEX 50WX8 (1.0 g) was added and the mixture was stirred at 50°C overnight. Upon cooling the mixture was filtered and concentrated under reduced pressure. The residue was purified by flash column chromatography on silica gel (10% MeOH in DCM) affording the final ProTide **9a-e** as white crystalline solid.

4.1.7.1. *5-( $\beta$ -D-Ribofuranosyl)-2H-1,2,3-triazole-4-carboxamide-5'-[1-phenyl(ethoxy-L-alaninyl)] phosphate (9a)*



Protected pronucleotide **10a** (52 mg, 0.1 mmol) was used as a starting compound for the preparation of **9a** (30 mg, 60%).  $[\alpha]_D^{25}$  (c 1, MeOH) +13.85; mp 58-60 °C.  $^{31}\text{P}$  NMR (162 MHz, MeOD):  $\delta$  5.02.  $^1\text{H}$  NMR (400 MHz, MeOD):  $\delta$  7.26-7.20 (m, 2H, Ph), 7.16-7.07 (m, 3H, Ph), 5.36 (d,  $J = 5.5$  Hz, 1H,  $\text{H}_{1'}$ ), 4.30 (ddd,  $J = 11.4, 7.6, 2.9$  Hz, 1H,  $\text{H}_{5'}$ ), 4.20 (ddd,  $J = 11.4, 7.9, 4.7$  Hz, 1H,  $\text{H}_{5'}$ ), 4.12-3.99 (m, 5H,  $\text{CH}_2\text{O}$ ,  $\text{H}_{2'}$ ,  $\text{H}_{3'}$ ,  $\text{H}_{4'}$ ), 3.90 (dq,  $J = 9.8, 7.2$  Hz, 1H,  $\text{CH}\alpha$ ), 1.29 (d,  $J = 7.1$  Hz, 3H,  $\text{CH}_3\text{CH}$ ), 1.17 (t,  $J = 7.2$  Hz, 3H,  $\text{CH}_3\text{CH}_2\text{O}$ ).  $^{13}\text{C}$  NMR (100 MHz, MeOD):  $\delta$  174.9 (d,  $J_{\text{CP}} = 5.4$  Hz,  $\text{CO}_2\text{Et}$ ), 165.5 ( $\text{CONH}_2$ ), 152.0 (d,  $J_{\text{CP}} = 7.2$  Hz, Ph), 143.7 ( $\text{C}_5$ ), 138.7 ( $\text{C}_4$ ), 130.7 (Ph), 126.2 (Ph), 121.5 (d,  $J_{\text{CP}} = 4.6$  Hz, Ph), 84.1 (d,  $J_{\text{CP}} = 6.3$  Hz,  $\text{C}_{4'}$ ), 78.3 ( $\text{C}_{1'}$ ), 77.1 ( $\text{C}_{2'}$ ), 72.8 ( $\text{C}_{3'}$ ), 68.2 (d,  $J_{\text{CP}} = 5.4$  Hz,  $\text{C}_{5'}$ ), 62.4 ( $\text{CH}_2\text{O}$ ), 51.5 ( $\text{CH}\alpha$ ), 20.5 (d,  $J_{\text{CP}} = 6.4$  Hz,  $\text{CH}_3\text{CH}$ ), 14.4 ( $\text{CH}_3\text{CH}_2\text{O}$ ). HRMS (ESI) calculated for  $\text{C}_{19}\text{H}_{27}\text{N}_5\text{O}_9\text{P}$   $[\text{M}+\text{H}]^+$ : 500.1546; found 500.1536.

4.1.7.2. *5-( $\beta$ -D-Ribofuranosyl)-2H-1,2,3-triazole-4-carboxamide-5'-[1-phenyl((propan-2-yl)oxy)-L-alaninyl] phosphate (9b)*

Protected pronucleotide **10b** (67 mg, 0.125 mmol) was used as a starting compound for the preparation of **9b** (35 mg, 56%).  $[\alpha]_D^{25}$  (c 1, MeOH) + 12.58; mp 74-76 °C.  $^{31}\text{P}$  NMR (162 MHz, MeOD):  $\delta$  5.12.  $^1\text{H}$  NMR (400 MHz, MeOD):  $\delta$  7.31-7.25 (m, 2H), 7.21-7.16 (m, 2H), 7.16-7.10 (m, 1H), 5.41 (d,  $J = 5.6$  Hz, 1H,  $\text{H}_{1'}$ ), 4.94 (sept,  $J = 6.4$  Hz, 1H  $\text{CH}(\text{CH}_3)_3$ ), 4.36 (ddd,  $J = 11.3, 7.9, 2.6$  Hz, 1H,  $\text{H}_{5'}$ ), 4.24 (ddd,  $J = 11.3, 7.7, 4.6$  Hz, 1H,  $\text{H}_{5'}$ ), 4.17-4.02 (m, 3H,  $\text{H}_{2'}$ ,  $\text{H}_{3'}$ ,  $\text{H}_{4'}$ ), 3.93 (dq,  $J = 9.5, 7.3$  Hz, 1H,  $\text{CH}\alpha$ ), 1.34 (d,  $J = 7.1$  Hz, 3H,  $\text{CH}_3\text{CH}$ ), 1.21 (d,  $J = 6.4$  Hz, 6H,  $(\text{CH}_3)_2\text{CH}$ ).  $^{13}\text{C}$  NMR (100 MHz, MeOD):  $\delta$  174.4 (d,  $J_{\text{CP}} = 5.5$  Hz,  $\text{CO}_2i\text{Pr}$ ), 165.3 ( $\text{CONH}_2$ ), 152.0 (d,  $J_{\text{CP}} = 6.9$  Hz, Ph), 143.7 ( $\text{C}_5$ ), 138.7 ( $\text{C}_4$ ), 130.7 (Ph), 126.1 (Ph), 121.5 (d,  $J_{\text{CP}} = 4.6$  Hz, Ph), 84.1 (d,  $J_{\text{CP}} = 6.3$  Hz,  $\text{C}_{4'}$ ), 78.3 ( $\text{C}_{1'}$ ), 77.2 ( $\text{C}_{2'}$ ), 72.8 ( $\text{C}_{3'}$ ), 70.2 ( $\text{CH}(\text{CH}_3)_2$ ), 68.2 (d,  $J_{\text{CP}} = 5.3$  Hz,  $\text{C}_{5'}$ ), 51.7 ( $\text{CH}\alpha$ ), 21.9 (d,  $J_{\text{CP}} = 6.5$  Hz,  $(\text{CH}_3)_2\text{CH}$ ), 20.5 (d,  $J_{\text{CP}} = 6.4$  Hz,  $\text{CH}_3\text{CH}$ ). HRMS (ESI) calculated for  $\text{C}_{20}\text{H}_{29}\text{N}_5\text{O}_9\text{P}$   $[\text{M}+\text{H}]^+$ : 514.1703; found 514.1703.

4.1.7.3. *5-( $\beta$ -D-Ribofuranosyl)-2H-1,2,3-triazole-4-carboxamide-5'-[1-phenyl(benzyloxy)-L-alaninyl] phosphate (9c)*

Protected pronucleotide **10c** (60 mg, 0.1 mmol) was used as a starting compound for the preparation of **9c** (32 mg, 57%) obtained as a diastereomer mixture around 6/4. *Major*

*diastereomer*:  $^{31}\text{P}$  NMR (162 MHz, MeOD):  $\delta$  5.03.  $^1\text{H}$  NMR (400 MHz, MeOD):  $\delta$  7.36-7.22 (m, 7H, Ph), 7.19-7.10 (m, 3H), 5.43 (d,  $J = 5.0$  Hz, 1H,  $\text{H}_{1'}$ ), 5.10 (d,  $J = 12.3$  Hz, 1H,  $\text{CH}_2\text{Ph}$ ), 5.06 (d,  $J = 12.3$  Hz, 1H,  $\text{CH}_2\text{Ph}$ ), 4.39 (ddd,  $J = 11.5, 7.6, 2.5$  Hz,  $\text{H}_{5'}$ ), 4.24 (ddd,  $J = 11.5, 8.0, 4.0$  Hz,  $\text{H}_{5'}$ ), 4.21-3.95 (m, 4H,  $\text{H}_{4'}$ ,  $\text{H}_{3'}$ ,  $\text{H}_{2'}$ ,  $\text{CH}\alpha$ ), 1.31 (d,  $J = 7.3$  Hz, 3H,  $\text{CH}_3\text{CH}$ ).  $^{13}\text{C}$  NMR (100 MHz, MeOD):  $\delta$  175.1 (d,  $J_{\text{CP}} = 3.8$  Hz,  $\text{CO}_2\text{Bn}$ ), 165.5 ( $\text{CONH}_2$ ), 152.2 (d,  $J_{\text{CP}} = 7.0$  Hz, Ph), 144.0 ( $\text{C}_5$ ) 139.0 ( $\text{C}_4$ ), 137.4 (Ph), 130.9 (Ph), 129.7 (Ph), 129.5 (Ph), 126.3 (Ph), 121.7 (d,  $J_{\text{CP}} = 3.9$  Hz, Ph), 84.3 (d,  $J_{\text{CP}} = 6.1$  Hz,  $\text{C}_{4'}$ ), 78.4 ( $\text{C}_{1'}$ ), 77.3 ( $\text{C}_{2'}$ ), 72.8 ( $\text{C}_{3'}$ ), 68.0 ( $\text{CH}_2\text{Ph}$ ,  $\text{C}_{5'}$ ), 51.9 ( $\text{CH}\alpha$ ), 20.4 (d,  $J_{\text{CP}} = 7.3$  Hz,  $\text{CH}_3\text{CH}$ ). *Minor diastereomer*:  $^{31}\text{P}$  NMR (162 MHz, MeOD):  $\delta$  5.08.  $^1\text{H}$  NMR (400 MHz, MeOD):  $\delta$  7.36-7.22 (m, 7H, Ph), 7.19-7.10 (m, 3H), 5.41 (d,  $J = 5.7$  Hz, 1H,  $\text{H}_{1'}$ ), 5.13 (d,  $J = 12.3$  Hz, 1H,  $\text{CH}_2\text{Ph}$ ), 5.08 (d,  $J = 12.3$  Hz, 1H,  $\text{CH}_2\text{Ph}$ ), 4.31 (ddd,  $J = 11.3, 7.7, 2.6$  Hz,  $\text{H}_{5'}$ ), 4.21-3.95 (m, 5H,  $\text{H}_{5'}$ ,  $\text{H}_{4'}$ ,  $\text{H}_{3'}$ ,  $\text{H}_{2'}$ ,  $\text{CH}\alpha$ ), 1.35 (d,  $J = 7.2$  Hz, 3H,  $\text{CH}_3\text{CH}$ ).  $^{13}\text{C}$  NMR (100 MHz, MeOD):  $\delta$  174.8 (d,  $J_{\text{CP}} = 4.3$  Hz,  $\text{CO}_2\text{Bn}$ ), 165.5 ( $\text{CONH}_2$ ), 152.1 (d,  $J_{\text{CP}} = 6.8$  Hz, Ph), 143.6 ( $\text{C}_5$ ), 139.0 ( $\text{C}_4$ ), 137.4 (Ph), 130.9 (Ph), 129.7 (Ph), 129.5 (Ph), 126.3 (Ph), 121.7 (d,  $J_{\text{CP}} = 3.9$  Hz, Ph), 84.3 (d,  $J_{\text{CP}} = 6.1$  Hz,  $\text{C}_{4'}$ ), 78.4 ( $\text{C}_{1'}$ ), 77.3 ( $\text{C}_{2'}$ ), 72.9 ( $\text{C}_{3'}$ ), 68.3 (d,  $J_{\text{CP}} = 5.2$  Hz,  $\text{C}_{5'}$ ), 68.1 ( $\text{CH}_2\text{Ph}$ ), 51.7 ( $\text{CH}\alpha$ ), 20.5 (d,  $J_{\text{CP}} = 6.6$  Hz,  $\text{CH}_3\text{CH}$ ). HRMS (ESI) calculated for  $\text{C}_{24}\text{H}_{29}\text{N}_5\text{O}_9\text{P}$   $[\text{M}+\text{H}]^+$ : 562.1703; found 562.1705.

4.1.7.4. *5-( $\beta$ -D-Ribofuranosyl)-2H-1,2,3-triazole-4-carboxamide-5'-[1-phenyl(ethoxy-L-valinyl)] phosphate (**9d**)*

Protected pronucleotide **10d** (57 mg, 0.1 mmol) was used as a starting compound for the preparation of **9d** (30 mg, 56%).  $[\alpha]_{\text{D}}^{25}$  (c 1, MeOH) +12.97; mp 66-68 °C.  $^{31}\text{P}$  NMR (162 MHz, MeOD):  $\delta$  5.91.  $^1\text{H}$  NMR (400 MHz, MeOD):  $\delta$  7.30-7.7.26 (m, 2H, Ph), 7.19-7.16 (m, 3H, Ph), 5.42 (d,  $J = 5.6$  Hz, 1H,  $\text{H}_{1'}$ ), 4.37 (ddd,  $J = 11.4, 7.4, 2.7$  Hz, 1H,  $\text{H}_{5'}$ ), 4.26 (ddd,  $J = 11.4, 7.6, 4.9$  Hz, 1H,  $\text{H}_{5'}$ ), 4.17-4.05 (m, 5H,  $\text{H}_{2'}$ ,  $\text{H}_{3'}$ ,  $\text{H}_{4'}$ ,  $\text{CH}_2\text{O}$ ), 3.66 (dd,  $J = 9.9, 6.2$  Hz, 1H,  $\text{CH}\alpha$ ), 2.04-1.99 (m, 1H,  $\text{CH}(\text{CH}_3)_2$ ), 1.21 (t,  $J = 7.1$  Hz, 3H,  $\text{CH}_3\text{CH}_2\text{O}$ ), 0.92 (d,  $J = 7.1$  Hz, 3H,  $(\text{CH}_3)_2\text{CH}$ ), 0.90 (d,  $J = 7.1$  Hz, 3H,  $(\text{CH}_3)_2\text{CH}$ ).  $^{13}\text{C}$  NMR (100 MHz, MeOD):  $\delta$  174.0 (d,  $J_{\text{CP}} = 3.1$  Hz,  $\text{CO}_2\text{Et}$ ), 165.4 ( $\text{CONH}_2$ ), 152.0 (d,  $J_{\text{CP}} = 7.0$  Hz, Ph), 143.8 ( $\text{C}_5$ ), 138.7 ( $\text{C}_4$ ), 130.7 (Ph), 126.1 (Ph), 121.5 (d,  $J_{\text{CP}} = 4.6$  Hz, Ph), 84.2 (d,  $J_{\text{CP}} = 6.3$  Hz,  $\text{C}_{4'}$ ), 78.2 ( $\text{C}_{1'}$ ), 77.1 ( $\text{C}_{2'}$ ), 72.8 ( $\text{C}_{3'}$ ), 68.4 (d,  $J_{\text{CP}} = 5.4$  Hz,  $\text{C}_{5'}$ ), 62.2 ( $\text{CH}_2\text{O}$ ), 61.8 ( $\text{CH}\alpha$ ), 33.2 (d,  $J_{\text{CP}} = 6.9$  Hz,  $\text{CH}(\text{CH}_3)_2$ ), 19.5 ( $(\text{CH}_3)_2\text{CH}$ ), 18.3 ( $(\text{CH}_3)_2\text{CH}$ ), 14.5 ( $\text{CH}_3\text{CH}_2\text{O}$ ). HRMS (ESI) calculated for  $\text{C}_{21}\text{H}_{31}\text{N}_5\text{O}_9\text{P}$   $[\text{M}+\text{H}]^+$ : 528.1859; found 528.1860.

4.1.7.5. 5-( $\beta$ -D-Ribofuranosyl)-2H-1,2,3-triazole-4-carboxamide-5'-[1-phenyl(benzyloxy-L-valinyl)] phosphate (**9e**)

Protected pronucleotide **10e** (63 mg, 0.1 mmol) was used as a starting compound for the preparation of **9e** (35 mg, 58%).  $[\alpha]_D^{25}$  (c 1, MeOH) +14.02; mp 66-68 °C.  $^{31}\text{P}$  NMR (162 MHz, MeOD):  $\delta$  5.87.  $^1\text{H}$  NMR (400 MHz, MeOD):  $\delta$  7.36-7.09 (m, 10H, Ph), 5.41 (d,  $J = 5.8$  Hz, 1H,  $\text{H}_{1'}$ ), 5.12 (d,  $J = 12.1$  Hz, 1H,  $\text{CH}_2\text{Ph}$ ), 5.07 (d,  $J = 12.1$  Hz, 1H,  $\text{CH}_2\text{Ph}$ ), 4.32 (ddd,  $J = 11.2, 7.7, 2.5$  Hz, 1H,  $\text{H}_{5'}$ ), 4.18 (ddd,  $J = 11.2, 7.8, 5.0$  Hz, 1H,  $\text{H}_{5'}$ ), 4.14 (m, 1H,  $\text{H}_{4'}$ ), 4.08 (dd,  $J = 5.0, 5.0$ , 1H,  $\text{H}_{3'}$ ), 4.00 (dd,  $J = 5.8, 5.0$  Hz, 1H,  $\text{H}_{2'}$ ), 3.71 (dd,  $J = 9.8, 6.3$  Hz, 1H,  $\text{CH}\alpha$ ), 2.06-1.98 (m, 1H,  $\text{CH}(\text{CH}_3)_2$ ), 0.89 (d,  $J = 7.0$  Hz, 3H,  $(\text{CH}_3)_2\text{CH}$ ), 0.87 (d,  $J = 7.0$  Hz, 3H,  $(\text{CH}_3)_2\text{CH}$ ).  $^{13}\text{C}$  NMR (100 MHz, MeOD):  $\delta$  173.8 (d,  $J_{\text{CP}} = 2.8$  Hz,  $\text{CO}_2\text{Bn}$ ), 165.4 ( $\text{CONH}_2$ ), 152.0 (d,  $J_{\text{CP}} = 7.2$  Hz, Ph), 143.4 ( $\text{C}_5$ ), 138.7 ( $\text{C}_4$ ), 137.1 (Ph), 130.7 (Ph), 129.6 (Ph), 129.5 (Ph), 129.4 (Ph), 126.1 (Ph), 121.5 (d,  $J_{\text{CP}} = 4.6$  Hz, Ph), 84.1 (d,  $J_{\text{CP}} = 6.2$  Hz,  $\text{C}_{4'}$ ), 78.2 ( $\text{C}_{1'}$ ), 77.1 ( $\text{C}_{2'}$ ), 72.8 ( $\text{C}_{3'}$ ), 68.3 (d,  $J_{\text{CP}} = 5.4$  Hz,  $\text{C}_{5'}$ ), 67.8 ( $\text{CH}_2\text{Ph}$ ), 61.8 ( $\text{CH}\alpha$ ), 33.2 (d,  $J_{\text{CP}} = 6.7$  Hz,  $\text{CH}(\text{CH}_3)_2$ ), 19.5 ( $(\text{CH}_3)_2\text{CH}$ ), 18.3 ( $(\text{CH}_3)_2\text{CH}$ ). HRMS (ESI) calculated for  $\text{C}_{26}\text{H}_{33}\text{N}_5\text{O}_9\text{P}$   $[\text{M}+\text{H}]^+$ : 590.2016; found 590.2014.

4.1.7.6. 5-( $\beta$ -D-Ribofuranosyl)-2H-1,2,3-triazole-4-carboxamide-5'-[1-naphthyl(benzyloxy-L-alaninyl)] phosphate (**14**)

Protected pronucleotide **13** (128 mg, 0.19 mmol) was used as a starting compound for the preparation of **14** (40 mg, 39%).  $^{31}\text{P}$  NMR (162 MHz, MeOD)  $\delta$  5.34.  $^1\text{H}$  NMR (400 MHz, MeOD)  $\delta$  8.14-7.14 (m, 12H, Naph, Ph), 5.44-5.33 (m, 1H,  $\text{H}_{1'}$ ), 5.04-4.94 (m, 2H,  $\text{CH}_2\text{Ph}$ ), 4.54-4.24 (m, 2H,  $\text{H}_{5'}$ ), 4.24-3.95 (m, 4H,  $\text{H}_{2'}$ ,  $\text{H}_{3'}$ ,  $\text{H}_{4'}$ ,  $\text{CH}\alpha$ ), 1.35-1.20 (m, 3H,  $\text{CH}_3\text{CH}$ ).  $^{13}\text{C}$  NMR (100 MHz, MeOD)  $\delta$  174.5 ( $\text{CO}_2\text{Bn}$ ), 165.4 ( $\text{CONH}_2$ ), 153.2 (Naph), 148.0 ( $\text{C}_5$ ), 138.8 ( $\text{C}_4$ ), 129.5-122.7 (Naph, Ph), 116.4 (Naph), 84.2 ( $\text{C}_{4'}$ ), 78.2 ( $\text{C}_{1'}$ ), 77.1 ( $\text{C}_{2'}$ ), 72.8 ( $\text{C}_{3'}$ ), 68.3 ( $\text{C}_{5'}$ ), 67.9 ( $\text{CH}_2\text{Ph}$ ), 51.7 ( $\text{CH}\alpha$ ), 20.4 ( $\text{CH}_3\text{CH}$ ). HRMS (ESI) calculated for  $\text{C}_{28}\text{H}_{31}\text{N}_5\text{O}_9\text{P}$   $[\text{M}+\text{H}]^+$ : 612.1859; found 612.1859.

4.1.8. Enzymatic procedure

Compound **14** (5.8 mg) was dissolved in acetone- $d_6$  (0.17 mL) and Trizma buffer (0.35 mL, pH = 7.4) and  $^{31}\text{P}$  NMR (101 MHz) was recorded (Figure 2, t = 0). Then a solution of

Carboxypeptidase Y (0.1 mg) in Trizma buffer (0.17 mL) was added and  $^{31}\text{P}$  NMR experiments were performed and recorded at the times indicated on Figure 2.

## 4.2 Biology

### 4.2.1. Cancer cell line culture

MDA-MB-231 (human breast adenocarcinoma), MIA PaCa-2 (human pancreatic carcinoma) and A549 (human lung carcinoma) cell lines were obtained from the American Type Culture Collection (ATCC). Cells were cultured in high glucose Dulbecco's modified Eagle's medium (DMEM) supplemented with 10% fetal bovine serum (FBS) and 1% penicillin/streptomycin at 37 °C in a 5%  $\text{CO}_2$  humidified atmosphere. DMEM culture medium, FBS and all reagents were purchased from Sigma Aldrich.

### 4.2.2. *In vitro* antiproliferative activity

Cell proliferation inhibition was evaluated using the MTT microculture tetrazolium assay [25,26]. Cells were seeded in a 96-well plate at a density of  $4 \times 10^3$  cells/well for MDA-MB-231 cells and  $1 \times 10^3$  cells/well for MIA PaCa-2 and A549 cell lines, in the supplemented culture medium. After 24h incubation, the culture medium was removed and replaced by 100  $\mu\text{L}$  of supplemented culture medium containing increasing concentrations of evaluated compound **1** or **9a-e** (0, 0.1, 0.5, 1, 5, 10, 50, 100, 200 and 500  $\mu\text{M}$ ). After 72 h incubation at 37 °C, 10  $\mu\text{L}$  of a MTT solution (5 mg/mL in PBS) were introduced in each well and cells were incubated for additional 3h at 37 °C. The culture medium was removed and 50  $\mu\text{L}$ /well of DMSO were added to dissolve the insoluble purple formed product. Optical density was measured at 570 nm using a Thermo Scientific Multiskan FC microplate reader.  $\text{IC}_{50}$  values (concentration of the compound where the response is reduced by half) were determined by using GraphPad software. All experiments were carried out 3 times in triplicate.

### 4.2.3. Anti-CCHF virus activity

For CCHF virus studies, the strain 86-07 IbAr10200, Nigeria was used. All work involving infectious viruses had carried out in a biosafety level 4 (BSL-4) facility. Vero E6 cells (African

green monkey kidney, ATCC CRL-1586) were grown at 37°C in DMEM (Gibco®, Life technologies™) supplemented with 10% inactivated fetal calf serum (FCSi, Gibco®, Life technologies™). Inhibition assay tests were performed in flat-bottomed microtiter plates (96 wells), one day after seeding of the Vero E6 cells, fivefold serial dilutions of test molecules starting at 20µM were deposit on cells. After 10 min, an equal volume of CCHF virus (100 TCID<sub>50</sub>/50 µL) was added and incubated at 37°C. At day 3, the inhibition of the replication was revealed by IHC as previously described [27], except for the revelation step in which TMB reagent was used.

### **Funding sources**

The authors thank the Advanced Studies Institute of CY Cergy Paris Université for financial support of NS.

### **Declaration of competing interest**

The authors declare that they have no known competing financial interests or personal relationships that could have appeared to influence the work reported in this paper.

### **References**

- [1] M. Serpi, F. Pertusati An overview of ProTide Technology and its implications in drug discovery, *Expert Opin. Drug Discov.* 16 (2021) 1149-1161, <https://doi.org/10.1080/17460441.2021.1922385>
- [2] Y. Mehellou, H.S. Rattan, J. Balzarini, The ProTide Prodrug Technology: From the Concept to the Clinic, *J. Med. Chem.* 61 (2018) 2211-2226, <https://doi.org/10.1021/acs.jmedchem.7b00734>.
- [3] Y. Mehellou, J. Balzarini, C. McGuigan, Aryloxy phosphoramidate triesters: a technology for delivering monophosphorylated nucleosides and sugars into cells, *ChemMedChem* 4 (2009) 1779-1791, <https://doi.org/10.1002/cmdc.200900289>.

- [4] K. Nyström, J. Waldenström, K.W. Tang, M. Lagging, Ribavirin: pharmacology, multiple modes of action and possible future perspectives, *Future Virol.* 14 (2019) 153–160, <https://doi.org/10.2217/fv1-2018-0166>.
- [5] A. Wambecke, C. Laurent Issartel, J. Leroy-Dudal, F. Giffard, F. Cosson, N. Lubin-Germain, J. Uziel, S. Kellouche, F. Carreiras, Evaluation of the potential of a new ribavirin analog impairing the dissemination of ovarian cancer cells, *PLoS ONE* 14 (2019) e0225860, <https://doi.org/10.1371/journal.pone.0225860>.
- [6] N. Sabat, E. Migianu-Griffoni, T. Tudela, M. Lecouvey, S. Kellouche, F. Carreiras, F. Gallier, J. Uziel, N. Lubin-Germain, Synthesis and antitumor activities investigation of a C-nucleoside analogue of ribavirin. *Eur. J. Med. Chem.* (188) 2020, 112009, <https://doi.org/10.1016/j.ejmech.2019.112009>.
- [7] R. Ait Youcef, M. Dos Santos, S. Roussel, J.P. Baltaze, N. Lubin-Germain, J. Uziel, Huisgen cycloaddition reaction of C-alkynyl ribosides under micellar catalysis: synthesis of ribavirin analogues, *J. Org. Chem.* 74 (2009) 4318-4323, <https://doi.org/10.1021/jo900594x>.
- [8] N. Lubin-Germain, J.P. Baltaze, A. Coste, A. Hallonet, H. Lauréano, G. Legrave, J. Uziel, J. Augé, Direct C-glycosylation by indium alkynylation on sugar anomeric position, *Org. Lett.* 10 (2008) 725-728, <https://doi.org/10.1021/ol7029257>.
- [9] M. Prato, Q. C. Li, F. Wudl, V. Lucchini, Addition of azides to fullerene C60: synthesis of azafulleroids, *J. Am. Chem. Soc.* 115 (1993) 1148-1150, <https://doi.org/10.1021/ja00056a049>.
- [10] C. McGuigan, M.R. Kelleher, P. Perrone, S. Mulready, G. Luoni, F. Daverio, S. Rajyaguru, S. Le Pogam, I. Najera, J. A. Martin, K. Klumpp, D.B. Smith, The application of phosphoramidate ProTide technology to the potent anti-HCV compound 40-azidocytidine (R1479), *Bioorg. Med. Chem. Lett.* 19 (2009) 4250-4254, <https://doi.org/10.1016/j.bmcl.2009.05.099>.

- [11] W. Chang, D. Bao, B-K. Chun, D. Naduthambi, D. Nagarathnam, S. Rachakonda, P. G. Reddy, B.S. Ross, H-R. Zhang, S. Bansal, C.L. Espiritu, M. Keilman, A.M. Lam, C. Niu, H. Micolochick Steuer, P.A. Furman, M.J. Otto, M.J. Sofia, Discovery of PSI-353661, a novel purine nucleotide prodrug for the treatment of HCV infection, *ACS Med. Chem. Lett.* 2 (2011) 130-135, <https://doi.org/10.1021/ml100209f>.
- [12] D. Zeng, R. Zhang, Q. Nie, L. Cao, L. Shang, Z. Yin, Discovery of 2'- $\alpha$ -C-methyl-2'- $\beta$ -C-fluorouridine phosphoramidate prodrugs as inhibitors of hepatitis C virus, *ACS Med. Chem. Lett.* 7 (2016) 1197-1201, <https://doi.org/10.1021/acsmchemlett.6b00270>.
- [13] B.S. Ross, P.G. Reddy, H.R. Zhang, S. Rachakonda, M. Sofia, Synthesis of diastereomerically pure nucleotide phosphoramidates, *J. Org. Chem.* 76 (2011) 8311-8319, <https://doi.org/10.1021/jo201492m>.
- [14] G. Wang, N. Dyatkina, M. Prhac, C. Williams, V. Serebryany, Y. Hu, Y. Huang, J. Wan, X. Wu, J. Deval, A. Fung, Z. Jin, H. Tan, K. Shaw, H. Kang, Q. Zhang, Y. Tam, A. Stoycheva, A. Jekle, D.B. Smith, L. Beigelman, Synthesis and anti-HCV activities of 4'-fluoro-2'-substituted uridine triphosphates and nucleotide prodrugs: discovery of 4'-fluoro-2'-C-methyluridine 5'-phosphoramidate prodrug (AL-335) for the treatment of hepatitis C infection, *J. Med. Chem.* 62 (2019) 4555-4570, <https://doi.org/10.1021/acs.jmedchem.9b00143>.
- [15] P. Perrone, F. Daverio, R. Valente, S. Rajyaguru, J.A. Martin, V. L  v  que, S. Le Pogam, I. Najera, K. Klumpp, D.B. Smith, C. McGuigan, First example of phosphoramidate approach applied to a 4'-substituted purine nucleoside (4'-azidoadenosine): conversion of an inactive nucleoside to a submicromolar compound versus hepatitis C virus, *J. Med. Chem.* 50 (2007) 5463-5470, <https://doi.org/10.1021/jm070362i>.
- [16] G. Legrave, R. Ait Youcef, D. Afonso, A. Ferry, J. Uziel, N. Lubin-Germain, Synthesis of C-pyrimidyl nucleosides starting from alkynyl ribofuranosides, *Carbohydr. Res.* 462 (2018) 50-55, <https://doi.org/10.1016/j.carres.2018.04.005>.

- [17] M. Derudas, A. Brancale, L. Naesen, J. Neyts, J. Balzarini, C. McGuigan, Application of the phosphoramidate ProTide approach to the antiviral drug ribavirin, *Bioorg. Med. Chem.* 18 (2010) 2748-2755, <https://doi.org/10.1016/j.bmc.2010.02.015>.
- [18] G.H. Tignor, C.A. Hanham, Ribavirin efficacy in an in vivo model of Crimean-Congo hemorrhagic fever virus (CCHF) infection, *Antiviral Res.* 22 (1993) 309–325, [https://doi.org/10.1016/0166-3542\(93\)90040-P](https://doi.org/10.1016/0166-3542(93)90040-P)
- [19] D.M. Watts, M.A. Ussery, D. Nash, C.J. Peters, Inhibition of Crimean-Congo hemorrhagic fever viral infectivity yields in vitro by ribavirin, *Am. J. Trop. Med. Hyg.* 41 (1989) 581–585, <https://doi.org/10.4269/ajtmh.1989.41.581>
- [20] J.D. Graci, C.E. Cameron, Mechanisms of action of ribavirin against distinct viruses, *Rev. Med. Virol.* 16 (2006) 37–48, <https://doi.org/10.1002/rmv.483>
- [21] R.C. Tam, J.Y. Lau, Z. Hong, Mechanisms of action of ribavirin in antiviral therapies, *Antivir. Chem. Chemother.* 12 (2001) 261–272, <https://doi.org/10.1177/095632020101200501>
- [22] S. Nakano, Y. Uotani, Y. Sato, H. Oka, M. Fujii, N. Sugimoto, Conformational changes of the phenyl and naphthyl isocyanate-DNA adducts during DNA replication and by minor groove binding molecules, *Nucleic Acids Res.* 41 (2013) 8581-8590. <https://doi.org/10.1093/nar/gkt608>
- [23] S. Barman, L. You, R. Chen, V. Codrea, G. Kago, R. Edupuganti, J. Robertus, R.M. Krug, E.V. Anslyn, Exploring naphthyl-carbohydrazides as inhibitors of influenza A viruses, *Eur. J. Med. Chem.* 71 (2014) 81-90, <https://doi.org/j.ejmech.2013.10.063>
- [24] T. Kobayakawa, M. Yokoyama, K. Tsuji, M. Fujino, M. Kurakami, S. Boku, M. Nakayama, M. Kaneko, N. Ohashi, O. Kotani, T. Murakami, H. Sato, H. Tamamura, Small-molecule anti-HIV-1 agents based on HIV-1 capsid proteins, *Biomolecules*, 11 (2021) 208, <https://doi.org/10.3390/biom11020208>



[25] N. Ganot, S. Meker, L. Reytman, A. Tzuber, E.Y. Tshuva, Anticancer metal complexes: synthesis and cytotoxicity evaluation by the MTT assay, *J. Vis. Exp.* 81 (2013) e50767, <https://doi.org/10.3791/50767>.

[26] T. Legigan, E. Migianu-Griffoni, M. A. Abdenour, A. Descamps, J. Deschamp, O. Gager, M. Monteil, F. Barbault, M. Lecouvey, Synthesis and preliminary anticancer evaluation of new triazole bisphosphonate-based isoprenoid biosynthesis inhibitors, *Eur. J. Med. Chem.* 214 (2021) 113241-113249, <https://doi.org/10.1016/j.ejmech.2021.113241>.

[27] C.N. Peyrefitte, M. Perret, S. Garcia, R. Rodrigues, A. Bagnaud, S. Lacote, J.M. Crance, G. Vernet, D. Garin, M. Bouloy, G. Paranhos-Baccalà, Differential activation profiles of Crimean-Congo hemorrhagic fever virus-and Dugbe virus-infected antigen-presenting cells, *J. Gen. Virol.* 91 (2010) 189-198, <https://doi.org/10.1099/vir.0.015701-0>.

