



**HAL**  
open science

# A Summary Review on Experimental Studies for PCM Building Applications: Towards Advanced Modular Prototype

Khaireldin Faraj, Mahmoud Khaled, Jalal Faraj, Farouk Hachem, Cathy Castelain

## ► To cite this version:

Khaireldin Faraj, Mahmoud Khaled, Jalal Faraj, Farouk Hachem, Cathy Castelain. A Summary Review on Experimental Studies for PCM Building Applications: Towards Advanced Modular Prototype. *Energies*, 2022, 15 (4), pp.1459. 10.3390/en15041459 . hal-03621162

**HAL Id: hal-03621162**

**<https://hal.science/hal-03621162>**

Submitted on 20 Mar 2023

**HAL** is a multi-disciplinary open access archive for the deposit and dissemination of scientific research documents, whether they are published or not. The documents may come from teaching and research institutions in France or abroad, or from public or private research centers.

L'archive ouverte pluridisciplinaire **HAL**, est destinée au dépôt et à la diffusion de documents scientifiques de niveau recherche, publiés ou non, émanant des établissements d'enseignement et de recherche français ou étrangers, des laboratoires publics ou privés.

# A Summary Review on Experimental Studies for PCM Building Applications: Towards Advanced Modular Prototype

Khaireldin Faraj<sup>1,2</sup>, Mahmoud Khaled<sup>3,4,\*</sup>, Jalal Faraj<sup>3,5</sup>, Farouk Hachem<sup>1</sup>, Cathy Castelain<sup>2,\*</sup>

<sup>1</sup> Energy and Thermo-Fluid Group, Lebanese International University, LIU, PO Box 146404 Beirut, Lebanon; khaireldin.faraj@liu.edu.lb (K.F.); farouk.hachem@liu.edu.lb (F.H.).

<sup>2</sup> Laboratory of Thermal Energy of Nantes, LTEN, Polytech' Nantes, University of Nantes, Nantes-France; cathy.castelain@univ-nantes.fr (C.C.).

<sup>3</sup> Energy and Thermo-Fluid Group, The International University of Beirut BIU, PO Box 146404 Beirut, Lebanon; mahmoud.khaled@liu.edu.lb (M.K.); jalal.faraj@liu.edu.lb (J.F.).

<sup>4</sup> University Paris Diderot, Sorbonne Paris Cite, Interdisciplinary Energy Research Institute (PIERI), Paris, France.

<sup>5</sup> Lebanese university, Faculty of Technology, Saida, Lebanon.

\* Correspondence: mahmoud.khaled@liu.edu.lb; cathy.castelain@univ-nantes.fr.

**Abstract:** The use of Phase Change Material (PCM) as thermal energy storage system integrated in new buildings and as retrofits in old ones, proved its merit as promising renewable energy source. Heating and cooling building applications of PCM were studied by plenty of scientists, worldwide, on the basis of numerical and experimental analysis. The performed experiments mainly focused on one application, active or passive, using permanent prototype design for a certain duration and weather condition. The current study is a new review that focuses on two complementary aspects: (1) Reviewing latest studies in PCM domain and assessing the thermal performance of implemented prototypes within the conducted PCM experimental studies, namely, the effect of the design on the number of acceptable variables and possible PCM applications; and (2) suggesting a new, advanced, flexible and modular prototype, designed to enable several applications of PCM to be adapted and combined within the model. It was implied that the new design allows different configurations that are lacking in the literature, and serves for future PCM building application thermal analysis towards PCM integration optimization, as an attempt for transforming residential compartments into net zero energy buildings. The designed prototype overcome the deficiencies found in previous reviewed experimental facilities.

**Keywords:** phase change materials; modular prototype; heating; cooling; thermal energy storage.

---

## 1. Introduction

With the remarkable increase in the world's energy demand as a consequence of accelerating world population growth and economy prompt evolution, that lead to petrifying environmental crisis, current research focus is directed towards advancements in the share of renewable and sustainable energy [1–8]. According to the global energy and CO<sub>2</sub> status report of 2019, published by the international energy agency (IEA), the increase in energy demand world-widely have led to a historic rise in global energy-related CO<sub>2</sub> emissions by 1.7% in 2018, to reach 33.1 Gt CO<sub>2</sub> [9]. This emphasizes on the fact that fossil fuels fulfill about 75% of total energy requirements [10]. Besides, being the main cause of global warming, CO<sub>2</sub> emissions due to fossil fuels - namely due to coal combustion - are proved to be responsible of 0.3°C of the 1°C increase of average annual global surface temperature above pre-industrial levels [9]. Buildings contribute for about 40% of total energy consumption globally, and accounts for 30% of CO<sub>2</sub> emissions reflecting their involvement in global warming [11]. Statistical figures from different regions show that, out of total regional energy demand, buildings energy consumption have reached: 28% in Tunisia [12],

24% in USA [13], 20% in China [14] and 40% in EU [13,14]. These high percentages are mainly the draw backs caused by building materials fabrication and electrical energy production for sustaining occupants thermal comfort in modern erections [17]. Nevertheless, scientists estimate a 50% increase in global energy demand by 2050 if no energy solutions are arranged and applied [18].

Due to thermal comfort enhancement needs, with the fact that the replacement of low thermal capacity lightweight structures with high thermal mass materials in modern residents have led to high heating and cooling loads [19], 50% of buildings sector energy consumption is caused by heating, ventilating and air conditioning (HVAC) systems [20].

All this, encouraged scientists and policymakers to invest in projects that are directed toward reducing greenhouse gas emissions, basically relying on the application of energy efficiency strategies and the development of renewable energy technologies, comprising buildings applications [21]. Knowing that a 20% reduction in building consumption will alter up to 50% reduction in CO<sub>2</sub> emissions of the current state [19], renewable energy technologies such as integrating latent heat storage (LHS) systems in buildings are introduced as energy conservation management tools [22].

TES is subdivided into three main categories: sensible heat storage (SHS), latent heat storage (LHS), and thermochemical energy storage (TCES), or a combination of these [11]. The benefits of LHS systems seems superior over the others due to their high thermal energy storage densities over nearly a constant narrow temperature range, referred to as phase change temperature range [23–26]. For instance, the storage capacity of LHTES is 5 to 14 times greater than SHS capacity per unit volume [27]. Experiments conducted by Morrison and Abdel-khalik [28] and Ghoneim [29] showed that to store the same amount of energy stored in rock as SHS material, paraffin wax (LHS) storage mass required is less than seven-times that of rock, while a storage mass less than eight-times that of rock is required for Na<sub>2</sub>SO<sub>4</sub>·10H<sub>2</sub>O. LHS materials are mainly phase change materials (PCMs), and are classified into three main subdivisions, depending on their phase change states: (1) liquid-gaseous, (2) solid-liquid, and (3) solid-solid, with the second type being used in buildings [30]. For example, Chhugani et al. [31] proved that PCM wallboard is capable of storing double the amount of heat a conventional gypsum board can store, and the produced passive cooling power for the PCM wallboard (1.27 cm thick) is equivalent to that produced by a 15 cm thick concrete wall.

Researches published in the domain of PCM integrated to building applications are increasing and could be classified into various categories. PCM applications in buildings can be classified according to the following:

- Thermal storage driving force;
- Thermal load nature;
- Type of scientific study;
- Test facility type and size.

According to the thermal storage driving force, two sub-categories arise: (1) active systems, where the charging/discharging of PCM is influenced by forced convection of a fluid passing with thermal contact; and (2) passive systems, by which PCM charging/discharging is caused by the temperature difference between the PCM and surroundings, and consequently depends on daily solar radiation variations. Moreover, the thermal load nature is influenced by the climate of the region under test. It is either heating or cooling, or a combination between both which is referred to as hybrid systems. Add to that, the possible type of the study on PCM application: Experimental or Numerical/ simulation. Finally, the facility type and size play a big role in altering the results of PCM studies. This classification contains four main categories found in literature, and they are: (1) full-scale prototypes, (2) small-scale prototypes, (3) retrofitting of large-scale compartments, and (4) building partitions in laboratory controlled chambers. A hierarchy diagram presented in **Figure 1** summarizes the classification criteria for PCM building applications.

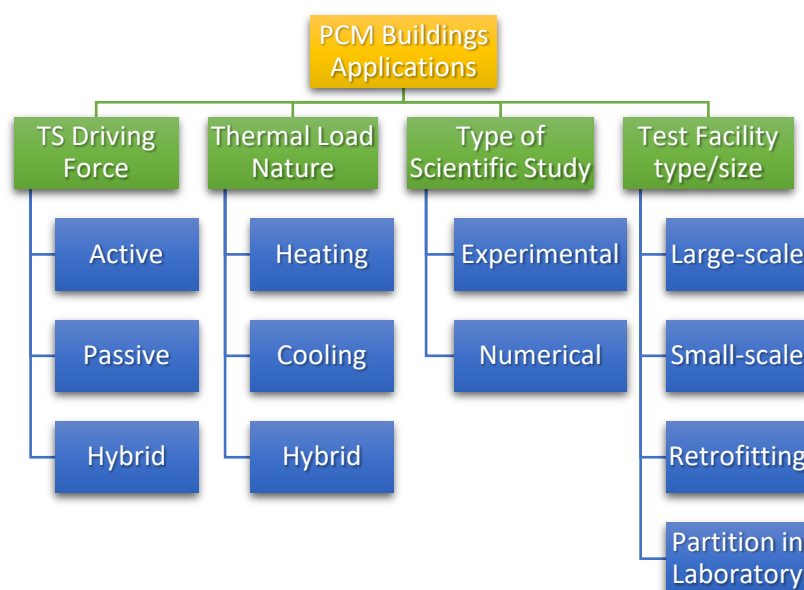

**Figure 1.** Classification criteria for PCM building applications.

It is essential upon studying PCM in buildings to cover the maximum possible studies and increase the number of variables to best meet real conditions. Several PCM studies are focused on one PCM application in terms of thermal storage driving force such as active radiant heating system integrated with PCM [27,28]. Most applications are either directed toward cooling or heating. Researchers perform numerical studies to eliminate high costs, and if experiments were done for validating simulations, most of the time they are directed on partitions of building components, such as floor, roof, or walls. Test facilities prepared in literature are capable of determining the effect of integrating PCM within limited variables. For instance, studies directed toward investigating the effect of PCM position in walls are deprived from the ability of combining active systems to the studied passive case; And, studies directed toward investigating the type of PCM used are deprived from their ability to study the position of PCM...etc. Thus, it is of high importance to address the design glitches in previous experimental studies and suggest a new prototype design that is modular, advanced, and appropriate in size and shape. This study is a new type of review articles that is directed toward summarizing PCM experimental tests of different sizes and forms, and ends up with conclusions, main findings and recommendations in the PCM domain. Novelty in this review article is reflected as it proposes a new, advanced, flexible and modular prototype design that allow several configurations to meet high number of possible application combinations with different configurations. The current work is the initiation of upcoming researches using the suggested prototype. Also, the design is detailed so that researchers working in the domain of PCM are enabled to implement the model and invest their analytical skills to conduct more studies that are still lacking.

### 1.1 PCM building applications recent reviews summary

In the past two decades, PCM technology kept developing continuously with special focus from scientists and researchers. Plenty of research articles were published and a lot of reviewers issued paper works to sum up variety of PCM studies and classify them to direct future work toward unveiling the unknown. Review studies took different forms, focus, concern and aim. From studies concerned with cooling applications of PCM [11,34], to studies related to encapsulation techniques of PCMs [35], to studies focusing on active and passive classification of PCM applications [36], passing by studies directed toward

enhancements in LHS performance [37], Life cycle assessment (LCA) of PCMs used in buildings [38]...ect; all together establish scientific PCM frameworks.

Du et al. [1] prepared a massive review article on the recent applications of PCM for heating, cooling and power generation. Navarro et al. [39,40] published a massive review study in two parts covering active and passive storage systems integrated in buildings as TES systems. Part 1, concerned with active systems, focused on seven different active applications based on the location of the TES system in the building. The applications were namely: Integrating the PCM-TES in (1) activated building core, (2) suspended ceilings, (3) ventilation systems, (4) external solar façade, (5) solar collectors, (6) photovoltaic panels for their thermal management, and (7) heat storage water tanks. On the other hand, the second part of the study, concerned with passive applications, focused on using PCM within building envelope as: (1) PCM impregnated in building materials, (2) PCM used as a new layer that is added to building components, and (3) Adding the PCM into windows and sun protections.

Mengjie et al. [41] published a review article on the enhancement of building energy performance by utilizing PCM. The authors considered the applications of PCM in buildings in two categories: PCMs in building envelope (side walls, roof and floor), and PCMs in building equipment (Air cooling, air heating and ventilation systems). It was shown that the temperature ranges of PCMs used for building envelope and building equipment vary between 10 °C and 39 °C and between -15.4 °C and 77 °C, respectively. Lizana et al. [42] reviewed studies related to the use of thermal energy storage systems integrated for cooling and heating applications of building and their advancements on low-carbon energy measures. Romdhane et al. [43] reviewed passive building applications using PCMs as thermal energy storage systems. Results showed that the integration of PCM in passive building applications improves building energy efficiency and thermal comfort, and decreases the cost of energy consumed. A comprehensive review on building heating applications with PCMs was published by Li et al. [44]. The study summarizes literature related to advancements in solar heaters and heat pumps combined with PCM-TES. Passive applications of PCM in building roof, ceiling, floor, walls, windows and solar chimneys, as well as, active applications such as solar heaters, heat pumps and electrical heaters are analyzed. The authors recommendations included encouragement for further research containing real implementation long-term experimental investigations, economic and energy analyses, environmental investigation and performance optimization. Recent reviews also contain more specified studies. Javadi et al. [45] reviewed literature on solar thermal systems and their thermal performance improvement by the integration of PCM. Magrini et al. [46] conducted a critical review following the European trends in transferring net zero energy buildings (NZEB) into positive energy buildings (PEB) by the use of advanced technologies and materials of which is the PCM. The study was terminated by a real case study of a PEB that reflected promising technologies.

The current work is directed toward summarizing recent research articles in the domain of PCM building applications. The study focuses on experimental type of studies reviewing design considerations in prototypes, retrofitting and laboratory tests and the respective outcomes and recommendations. After that, a new design for a modular prototype is suggested. The prototype design is detailed covering all its capabilities, configurations and dimensions. The new design permits researchers to perform a large set of experiments that are still lacking.

### *1.2 Scope of the current study*

The current study is divided into 7 sections other than the introduction. Section 2 deals with the methodology behind experimental aspects and considerations, and the comparison between different classification criteria. The following four sections covers studies that are categorized based on the last classification mentioned in the introduction, and related to test facility specification: Full-scale prototype experimental studies (section

3), Small-scale prototype experimental studies (section 4), Compartment retrofits experimental studies (section 5) and Laboratory building partitions experimental studies (section 6). Then comes section 7 to propose the new design of the modular prototype, and finally vital conclusions and relevant recommendations are addressed and summarized in section 8.

## 2. PCM Experiments Classification Criteria and Methodology

In the current article, studies are categorized based on the used prototypes and are classified according to their purpose, method and volume. Experimental huts that simulates zones of real dimensions with a volume  $\geq 5 \text{ m}^3$  are classified as Large-scale prototypes; Experimental huts utilizing conventional construction materials with a volume  $V$  such that:  $1 \text{ m}^3 \leq V \leq 5 \text{ m}^3$  are classified as Small-scale prototypes; Experiments done on an already existing compartment of large scale by integrating PCM into its sections are grouped under the title Retrofitting in full-scale compartment; and Experimental facilities that represent a partition from a system containing PCM that does not simulate a complete model are classified as Laboratory-based building partitions. **Table 1** summarizes the criteria followed in classifying the studied literatures according to test facility.

**Table 1.** Experimental studies classification based on test facility and the followed criteria.

Classification criteria	Classification based on test facility			
	Large-scale prototype	Small-scale prototype	Retrofitting in full-scale compartment	Laboratory-based test facility
<b>Purpose</b>	Test thermal behavior, heating/cooling load management, thermal comfort	Test thermal behavior, heating/cooling load management, thermal comfort	Test thermal behavior, heating/cooling load management, thermal comfort	Test thermal behavior
<b>Method</b>	Building up large hut subjected to real weather	Building up small hut subjected to real/artificial weather	Installing systems to already built full-scale buildings subjected to real weather	Building up systems (partitions) under controlled laboratory environment
<b>Volume</b>	$V \geq 5 \text{ m}^3$	$1 \text{ m}^3 \leq V \leq 5 \text{ m}^3$	$V \geq 5 \text{ m}^3$	<i>No complete hut or</i> $V \leq 1 \text{ m}^3$

## 3. Large-scale Prototype PCM Experimental Studies

Experimental investigation of the thermal performance of PCM integration in buildings aims to commercialize PCM products and establish genuine framework for architects and builders to follow. One method in the path of framework establishment is to prepare full-scale test cells that best matches reality and reflects possible outcomes of similar present households. Literature on active and passive large-scale applications are reviewed.

### 3.1 Active Large-scale Applications

Two full-scale cubicles designed and implemented by Mourid et al. [47] were tested under real weather conditions of the cold winter season. The test facilities' walls were manufactured from double brick layers (72 mm each with an additional mortar of 10 mm) with an air cavity in between (116 mm) by which a PCM wallboard is installed on the internal layers. Experiments covered the investigation of the thermal performance of the

rooms if the PCM was adhered to one wall internal layer, and if the PCM was installed in the ceiling. The main results showed that a saving of 20% in heat energy required can be reached. Comparing the effect of PCM position within the envelope, it is proved that placing the PCM in the ceiling is more efficient where 50% reduction in thermal losses across it is conquered. Lu et al. [48] combined in their study the advantages of PCM integrated in floor with the conventional solar water heating system. The designed prototype was modeled on TRNSYS and the respective experimental and numerical results were compared to validate the model. 95.1% consistency was triggered. Experiments proved that for an indoor temperature of 20 °C, the PFCSS building is capable of saving 5.87% of energy consumption compared to the reference prototype.

Gholamibozanjani and Farid [49] published a research on the performance of active PCM storage system for heating and cooling load reduction. Two identical huts were built each being supplied with an electrical heating system and a solar air heater (for heating), and an AC system (for cooling). And, one of the huts was equipped with two identical PCM heat storage unit. The novelty behind the investigated study is testing the effectiveness of combining active PCM storage system with an air-based solar collector. It was shown that 40% of accumulative energy-saving was achieved during May (heating load reduction) and 30% was achieved during March/April (cooling load reduction). In another study [50], the authors compared the effectiveness of passive and active systems applied to two identical large-scale prototypes in Auckland, New Zealand during both winter and summer. The passive system is presented by integrating PCM wallboards on the walls of one hut and the active system in the second hut utilized a PCM storage unit with a fan. Both huts were equipped with a control system, AC for cooling, solar air heater and electric heater for heating. Figure 2 illustrates the differences in both systems. Results proved that the active system has more potential in load shifting (Energy cost being 32% less than in passive system). And for identical storage capacity of used PCM in both systems, an increase in the reduction of energy consumption by 22% was achieved when active system was used during winter. On the contrary, passive system was more efficient for cooling purpose as the electricity consumption increased by 8% for active system.

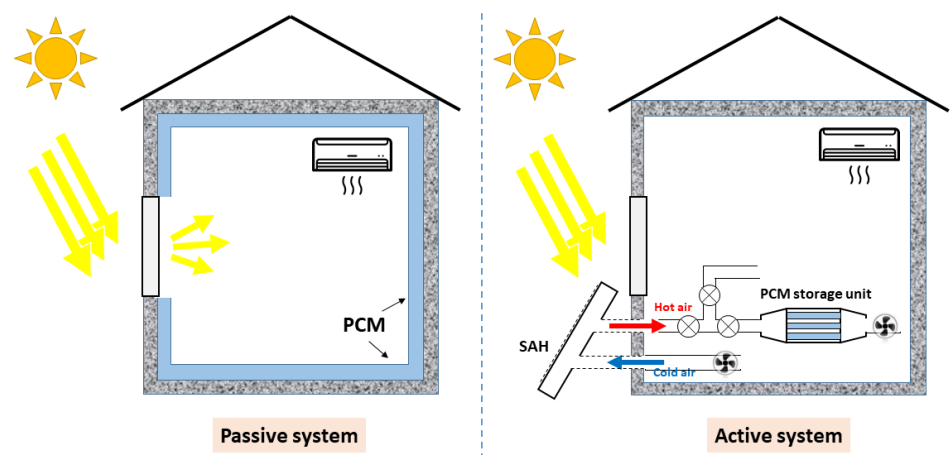
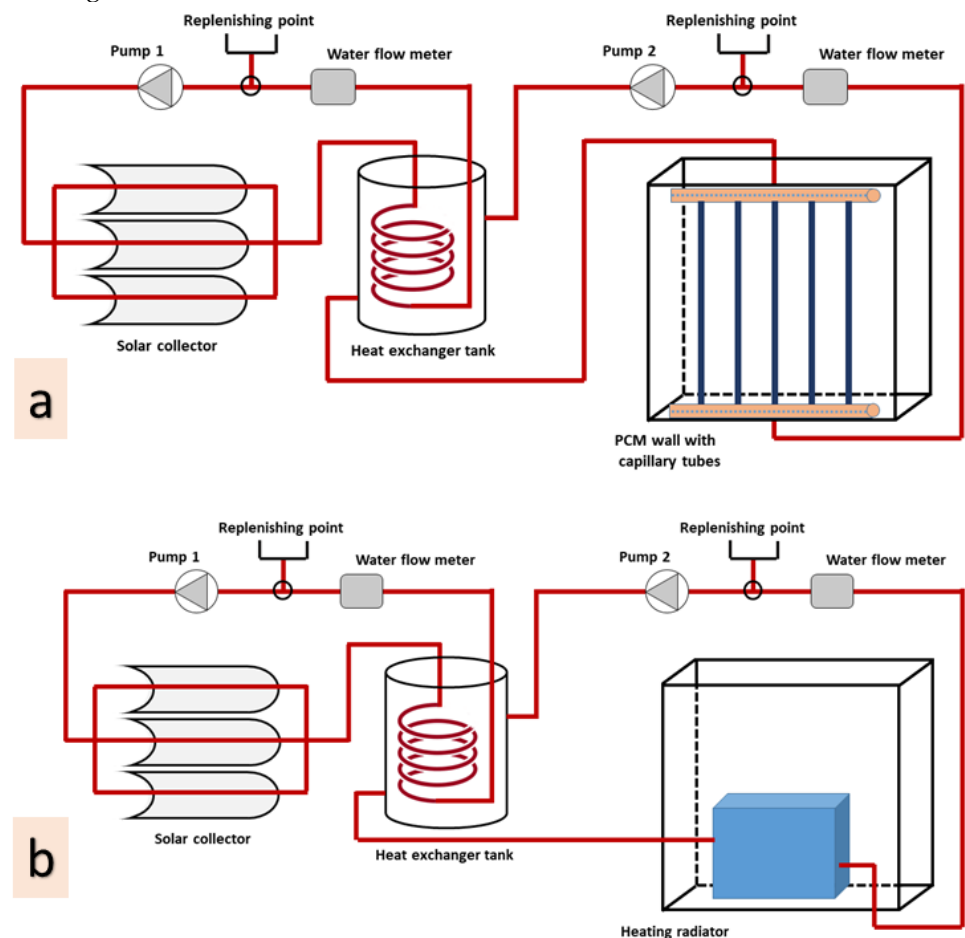

**Figure 2.** Passive and active systems integrated in tested prototypes [50].

Gracia et al. [51] performed an experimental study on a ventilated double-skin solar façade equipped with PCM. Two identical large-scale testing prototypes were built at Puigverd de Lleida, Spain. Results showed that by integrating PCM in the solar façade, thermal performance is enhanced and that the enhancement can be increased if thermal control was introduced.

The application of PCM combined to radiant heating systems have been studied by several researchers using large scale prototypes. Zhou et al. [52] compared the thermal performance enhancement for four different system combinations encountering latent and sensible heat storages, and by varying the pipe type (polyethylene coils and capillary

mat). Results proved that utilizing capillary mats is more efficient in terms of indoor vertical temperature uniformity and charging time (less by 50%) if compared to the case when polyethylene coils are used. Also, it was shown that during discharging, latent heat storage by PCM is more efficient than sand (sensible storage material) by two times. Radiant heating in walls coupled by solar thermal heat source and PCM was experimentally studied by Kong et al. [53]. Two identical test rooms were prepared such that the first room serving as reference room was equipped with a conventional heating radiator, and room B serving as PCM room was equipped with PCM wallboard integrated to capillary tubes forming the proposed PCM wall. Both test rooms were linked to solar thermal heating systems that represented the renewable energy source for heating. Figure 3 shows the difference between the two systems. Results showed that the daily energy consumption was reduced by 44.16% by means of PCM, thus enhancing the building energy efficiency and ensuring indoor thermal comfort.



**Figure 3.** Schematic representation of the studied hybrid system: (a) PCM room and (b) Reference room [53].

Sinka et al. [54] studied the effect of integrating PCM into internal surfaces of building walls and ceilings using 4 test rooms located in an experimental compound at Riga, Latvia. Two types of PCMs were used: DuPont Energain® plates installed in LOG building (representing light weight construction and referenced with PLY building), and Bio-PCM Q25 M51 installed in the walls and ceiling of the CER building (representing massive building construction and referenced with AER building). Radiant cooling with capillaries in conjunction with PCM was used in the ceiling. The buildings had different construction materials but had identical overall heat transfer U-values. Authors concluded that mechanical ventilation is an important requirement to prevent overheating and high temperature climates. The highest effectiveness was achieved when the used system included



radiant cooling ceiling with PCM. Finally, complex control systems are recommended to enhance the efficiency.

### 3.2 Passive Large-scale Applications

A study on the thermal performance of a PCM-enhanced cellulose insulation integrated in the cavities of a small scale prototype walls was prepared by Lee et al. [55]. The experimental investigation was performed on two identical large-scale prototypes, under full weather conditions. Results showed that reductions of 25.4% and 20.1% in daily average heat flux of individual walls and hourly average heat flux for the sum of all four walls, respectively, were obtained. Wang et al. [56] investigated the performance of a brick wall coupled to PCM at the exterior of a large scale prototype. The study was performed on a yearly basis covering: hot summer, midseason and cold winter of Shanghai, China. Results revealed that a reduction of 24.32% and 10-30% in in cooling and heating loads, respectively, were achieved by the composite PCM wall. Luo et al. [57] focused on the application of a modified Trombe wall system serving as a passive solar heating system, with the ability of heat preservation, and a passive cooling system with the ability of insulating heat. The system shows a potential in summer overheating prevention capability and a good heating effect during cold season, which was observed through the high indoor temperature of the test room compared to the reference room. Figure 4 illustrates the mechanism of the solar Trombe wall studied within the research. Sun and Wang [58] studied the heat transfer performance of a solar wall with PCM for winter heating, using two identical test prototypes located in Jilin, China. Results indicated that the indoor temperature fluctuations are reduced and air circulation is enhanced. Indoor thermal comfort achieved by the proposed system nominates it to be optimized and commercialized.

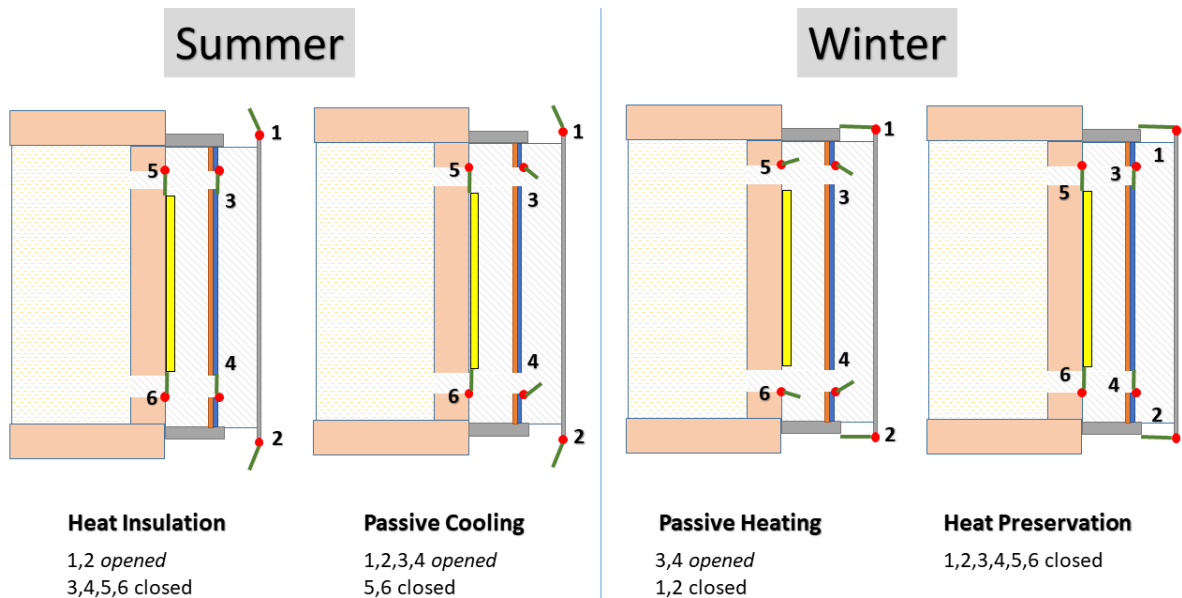
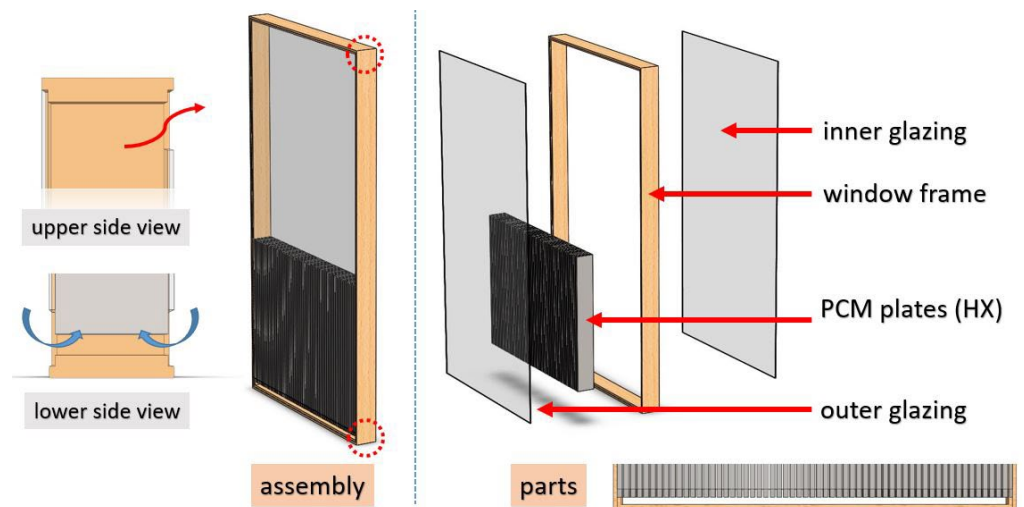

**Figure 4.** Modified Trombe wall mechanism studied by Luo et al. [57].

Guarino et al. [59] investigated the thermal behavior of a PCM wall placed on the other side of a glazed window during cold season of Montreal, Canada. Results showed that the integration of PCM leads to the storage of solar energy and its release after 6-8 hrs. This contributes to the decrease in stratification and reduction in heating demand that reaches 17% on yearly basis. Another study on the optimization of PCM position in the wall layers was investigated by Lee et al. [21]. The authors prepared two identical test prototypes and tested the effectiveness of PCM thermal shield (PCMTS) which is a thin layer of macro-encapsulated PCM covered with aluminum sheets on the two faces. Results showed that with a maximum reduction in peak heat flux that reached 51.3% and

29.7 % in south and west walls respectively, the optimum location of PCM inside the wall depends highly on the wall orientation. For instance, the time delays achieved for peak heat flux were 2.3 hrs for location 2 (west wall) and 6.5 hrs for location 1 (south wall). A study by Souayfane et al. [60] was performed to test the effectiveness of a novel PCM-TIM wall acting as a heat storage medium, thermal-acoustic insulator, and daylighting passage into the interior of the building. The wall mainly consisted of glazing, silica aerogel transparent insulation and macro-encapsulated PCM (glass bricks). The system was tested under real weather conditions for both winter and summer using a large-scale prototype. Results revealed that the effectiveness of using the wall is higher in winter and utilizing it within summer might cause overheating problems due to the incomplete solidification of PCM during night. The authors extended their study with performing numerical simulations that were validated by the tests of seven consecutive days. Recommendations stated that the use of shading systems reduces the problem of overheating.

Hu and Heiselberg [61] designed a full scale prototype equipped with a new ventilated window and a PCM heat exchanger to test its thermal performance and validate a numerical model for optimizing the design. The concept of the window illustrated in Figure 5 and is close to the trombe wall concept. The window is double glazing with a PCM heat exchanger in between at the lower part. Two openings at the bottom allows air to enter the heat exchanger and then continue to the upper opening: either toward the indoor environment (case of night free cooling or daytime ventilation pre-cooling) or toward outdoor environment (case of night ventilation). Results reflected the benefits behind the proposed and examined ventilated window where the optimum thickness of PCM HX was 10 mm. A reduction in average temperature of the ventilated air of 6.5 °C can be achieved in 3.9 hrs. Prior to window applications, coupling PCM to roof assembly is a promising method for decreasing heat gain to spaces in hot summer seasons. A study by Li et al. [62] traced a novel method of integrating PCM to building roof. The concept was integrating multiple layer PCM into a double layer roof separated by an air cavity for ventilation. Two identical full-scale prototypes were utilized with one set as a control test with a conventional roof, while the other containing the novel roof structure shown in Figure 6. The upper PCM layer has phase change temperature of 31°C to 32°C, and the lower PCM layer has a phase change temperature of 24 °C. Results revealed that a reduction in indoor peak temperature by 16.9-18.8% was achieved by the new system compared to conventional roofs.



**Figure 5.** Ventilating window with PCM heat exchanger [262].

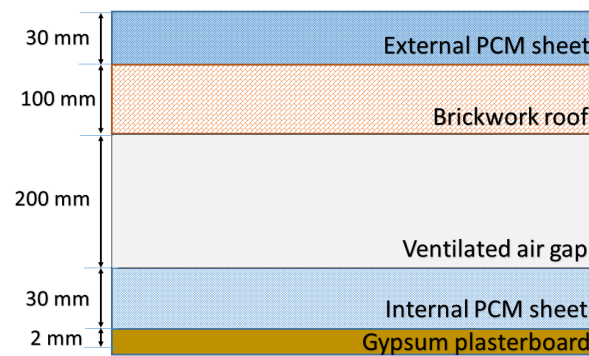

**Figure 6.** Ventilating roof with multilayer PCM cross-section [62].

#### 4. Small-scale Prototype PCM Experimental Studies

As an attempt for solving the problem of expensive costs required for preparing large-scale prototypes and to facilitate installation and test preparation, small-scale prototypes are introduced. Small-scale prototypes are familiar to be of low cost, low weight, and installation simplicity.

##### 4.1 Active Small-scale Applications

He and Yang et al. [63] conducted an experimental study on the use of a novel radiant cooling PCM wall. The novel wall combined the advantages of PCM serving as LHTES material with high energy density, micro-channel heat pipes (MCHPs) serving as a solution for the insufficient solidification of PCM at night and the release of accumulated heat into the room, due to its high thermal conductivity, and a radiative cooling plate having high emissivity. Three prototypes A, B and C having a conventional brick wall, PCM wall and the novel RC-PCM wall, respectively, were tested. Results showed respective reductions in cooling loads of 47.9% and 23.8%, from south wall, achieved by room C compared to rooms A and B. A small-scale prototype was constructed by Garg et al. [64] allowing the comparative study of 3 roof systems: (1) Thermally activated ceiling, (2) radiant panel in the chamber, and (3) encapsulated PCM based heat exchanger cooling system. Encapsulating PCM within the heat exchanger cooling system allowed a reduction of 50% in the heat gained by the room, corresponding to a decrease of 6 °C of the mean air temperature.

Small-scale prototypes are used for experimental investigations of specific application and are usually coupled with numerical models. The essence behind coupling both experiments and numerical analysis is to validate the numerical model to be used for full-scale building investigations. Another cause is the need for extending the studies for long-term periods which is tough and expensive as for experiments. Capillary tube embedded PCM component (CT-PCM) - installed in the wall and ceiling of a testing chamber - was investigated by Jobli et al. [65]. The authors proposed a numerical model that was validated by the experiments done. The system was composed of three main units: CT-PCM panel utilizing a 140 m long capillary tube for charging and discharging of PCM, dynamic thermal chamber and water bath system (see Figure 7). Results revealed that experimental data and numerical simulations agree for capillary flow rates above 800 ml/min, whereas, correction factors varying (between 1.2 and 1.6) are applied for lower flow rates.

Underfloor heating with electric radiant heating system equipped with PCM for energy saving purposes is a promising application. Fang et al. [66] prepared a novel Eutectic PCM mixture of sodium acetate trihydrate-formamide and expanded graphite as a carrier. The thermophysical properties tests showed that the proposed PCM had favorable phase change enthalpy (187.6 kJ/kg), high thermal conductivity (3.11 W/m.K), suitable transitional temperature (38.54 °C) and improved shape stability and thermal reliability. The prepared PCMs were added into a test room above an electrical radiant heater. Experimental investigations revealed that the addition of the PCM layer enhances the thermal

comfort greatly, where the total comfort time was 12.65 h for PCM room and 1.836 h for the room without PCM. Also, it was proven that the vertical temperature fluctuations were reduced effectively with PCM. Guo et al. [67] performed an experimental study on ventilated mortar block integrated with micro-encapsulated PCM in the floor for space heating. The concept relies on pumping hot air into copper tubes that are located at the central layer of the floor. Results indicated that PCM distribution in the floor has a strong impact on the performance of the system.

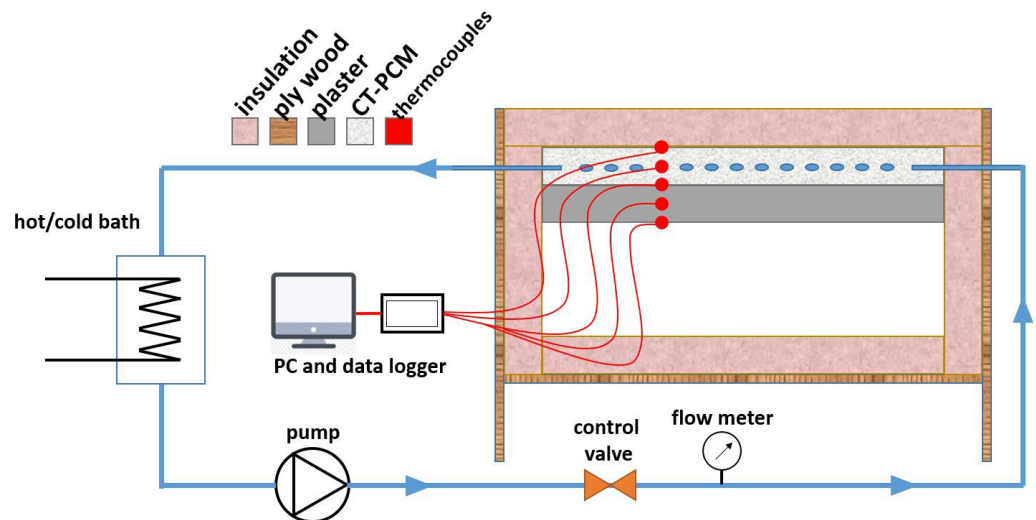

**Figure 7.** Thermally activated roof testing equipment [65].

#### 4.2 Passive Small-scale Applications

A study by Abbas et al. [68] aimed to investigate the thermal performance of a hollow-brick wall equipped with PCM capsules in a small-scale test room. It was found that the encapsulation of PCM in the wall lead to reduction of indoor and wall inner surface temperatures by about 4.7 °C and a reduction of 23.84% in temperature fluctuation. Rathore and Shukla [69] constructed two identical small test cubicles in Mathura, India. One of the test cubicles was equipped with tubular macro-capsules filled with PCM at the walls and roof, whereas the other was considered a reference. The study performed by the authors focused on examining the thermal behavior of the passive PCM application for the tropical summer conditions. The test facilities were made from concrete, mortar of cement and aluminum capsules such that the facilities are permanent in structure. Results showed that the integration of macro-encapsulated OM37 PCM lead to a reduction in thermal amplitude in all walls and roof ranging between 40.67% and 59.79%, a delay ranging between 60 and 120 minutes in attaining the peak temperatures at different faces, and a reduction in cooling load that reached 38.76%, triggering a cost saving equivalent to ~0.4 US\$/day. Khan et al. [70] prepared two models of composite walls to investigate the effect of using paraffin wax PCM on the wall heat transfer. The model was composed of rectangular layers insulated with wood and placed axially beside each other ensuring complete thermal contact. Model 1 contained PCM and model 2 was deprived from PCM. Results showed that for cooling load reduction, PCM position is preferred to be near the heat source within the wall fragment. And, with the PCM used, a time shift was monitored for the process of achieving a given temperature compared with other building materials. Integrating double-layer shape stabilized PCM wallboards in building walls was investigated by Lu et al. [71] through two identical test rooms located in Wuhan, China. Exterior and interior layers were proved to be active in both summer and winter, respectively. Overheating in summer and undercooling in winter could be prevented using PCM.

To manage the drawbacks behind high window to wall ratio (glazing walls) buildings, Berardi and Soudian [72] studied the effect of integrating passive PCM composites

in walls and ceiling. The aim was to reduce the high heat gains due to solar radiation and minimize temperature swings within the cooling zone. Two test facilities were prepared (see Figure 8), one acting as a reference and the other as the one equipped with PCM in walls and ceiling. The system included composite PCM layers (Energain® and BioPCM™) having different melting ranges that best suit indoor conditions during hot and cold seasons of Toronto, Canada. The hybrid system ensures thermal regulation through variable weather conditions (summer and winter). Results showed that using PCM decreased the indoor and surface temperatures by up to 6°C. In addition, the small thickness of the double layered PCM system (2cm) makes it favorable in retrofit projects for building thermal enhancement. Sun et al. [73] prepared residential building enhanced with pipe-encapsulated PCMs. The designed prototype was tested in the laboratory during summer season, with two main variables: pipe size and pipe depth (position) within the wall. It was shown that: (1) The reductions in heat fluxes through the PCM wall compared to control wall were 36.5% and 22.5% for the cases of middle depth and next to wallboard, respectively. However, in both cases the complete solidification of the PCM was not attained after the first experiment day. Moreover, it was proved that smaller pipe sizes with higher surface area to volume ratio are preferred. For 14 consecutive days of testing, Mehdaoui et al. [74] investigated the thermal performance of a PCM wall installed inside a small-scale prototype. Results showed that the installation of the PCM wall lead to enhancement in thermal comfort by reducing the indoor temperature fluctuations. A numerical simulation was added to the study making a significant proof that PCM melting occurs at the upper side of the PCM wall more than the bottom.

Zhang et al. [75] constructed a dynamic wall simulator to test the effect of PCMSIP on building thermal comfort enhancement in hot conditions. The test was directed toward optimizing PCMSIP regarding: core material, PCM encapsulating material and capsule configuration. The tests were made such that the interior of the chamber represented the hot outdoor weather and the exterior of the chamber represented the indoor cooled zone. Each wall from the 4 sides featured a change in one of the aforementioned testing specifications. Results show that: (1) Urethane cored SIP wall had lower heat flux than EPS cored SIP; (2) PCMSIP reduced heat flux compared to SIP deprived from PCM; (3) Copper encapsulation proved to be more efficient than PVC encapsulation; and (4) vertical PCM encapsulation configuration of PCMSIP resulted in higher indoor heat fluxes than the horizontal PCM encapsulation configuration.

The application of PCM in the whole envelope of a prototype was investigated by Meng et al. [76]. The study focused on comparing two testing huts: a reference with an ordinary wall and a testing facility containing composite PCM plates covering all the internal faces other than the glass door. The novelty behind using composite PCM of different melting temperature is to take the advantage of continuous functioning of the latent thermal energy storage system throughout the whole year (winter and summer). Results showed that the indoor air temperature fluctuations decreased by 28.8~67.8% and 17.7~25.4% for summer and winter cases respectively, reflecting the capabilities behind using composite PCM in the envelope.

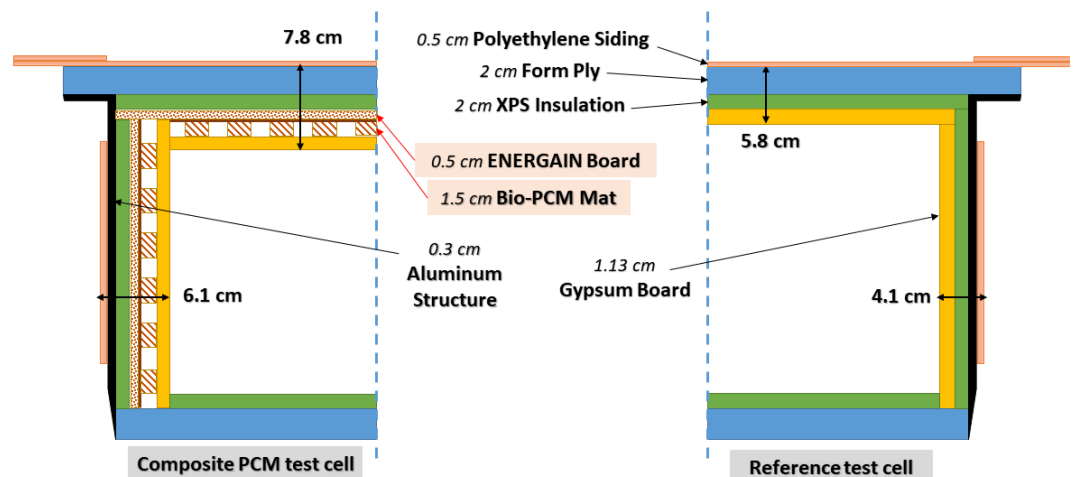

Figure 8. Cross-section of composite PCM test facility and reference facility [76].

## 5. Compartments Retrofitting PCM Experimental Studies

The majority of compartments are already teeming with residents. It is required to enhance their thermal environment inside their households without reformation of building features (walls, roof, floor or ceilings). The method of integrating new layers within constructed envelopes as retrofits gained the attention of engineers. Experimental investigation of retrofitted PCM applications were conducted by several researchers.

### 5.1 Active Retrofits Applications

Underfloor heating thermal performance with enhanced thermal conductivity shape stabilized PCM was tested by Cheng et al. [77]. Paraffin, high density polyethylene and expanded graphite were melt-mixed to form the SSPCM plates, which were placed above electrical mats in a conventional house room. The tested room located at the second floor of the house being located at Anhui province (subtropical weather) is 4 m long, 3 m wide and 3 m high. Results proved that among the three studied heating systems, the phase change energy storage system has the lowest economic consumption and highest cost-effective performance. Lu et al. [78] performed an experimental study on double pipe PCM floor heating system for a testing house located in Zhangjiakou, China. PCM was encapsulated within the annulus of the double-pipe. 3 Modules of heat pipe loops were installed in the floor of the 6.4 m long, 4 m wide and 2.7 m high room as shown in Figure 9. Results revealed that with the suitable operation strategy performed, thermal comfort could be achieved with fluctuations being reduced and controlled (average of 3 °C).

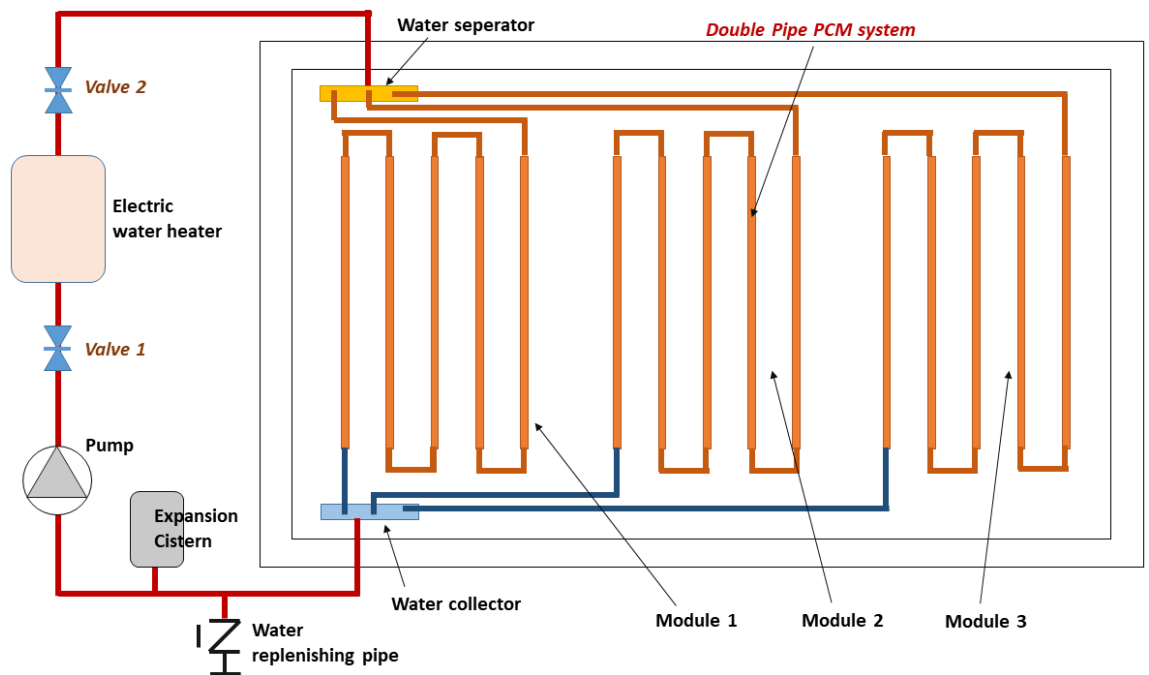

**Figure 9.** Underfloor double pipe PCM heating system studied by Lu et al. [78].

Stritih et al. [79] studied the effect of integrating PCM-LHTES at the termination of a solar air heater, mounted in a solar façade at the office building in Ljubljana, on the heating annual energy savings of the module. Operational cost savings have reached 24% using the PCM-LHTES compared to the system deprived from LHTES. Lamnatou et al. [80] investigated the performance of a novel building-integrated solar thermal system (BIST) equipped with myristic acid as PCM in Ajaccio, France. The system is composed of flat plate solar water heating collectors that are integrated into the building gutters. The study focused on performing life cycle assessment for two systems: with and without PCM to test the effect of PCM on environmental profile of the proposed system. Results showed that PCM has the highest impact related to ecosystem, compared to the effect of other components in the system.

The effect of integrating PCM component into conventional HVAC system was studied by Nada et al. [81]. A PCM module composed of SP-24E PCM plates was installed after the heating and cooling coil sections. Results showed that by increasing ambient temperature and the flow rate of fresh air, the number of required plates increases while the PCM discharge time decreases.

## 5.2 Passive Retrofits Applications

Wang et al. [82] performed an experimental study on the thermal behavior of disaster-relief prefabricated temporary houses (PTHs) equipped with PCM plates mounted on its internal faces. The aim of the study was to enhance the thermal environment of such houses that lack electrical thermal environmental control systems. Results were promising, by which both internal surface temperature and indoor temperature were monitored to be decreasing upon the integration of fixed PCM plates. Moreover, the authors concluded that using a movable PCM based energy storage system is preferred so that the PCM is brought outdoor to benefit from low temperatures during night and thus ensure complete solidification. However, such a method full of hard continuous work (fixing and dismantling plenty of plastic net-shape containers) is inconvenient for victims that are already in disastrous conditions, and can no more withstand daily aggression. For that, the authors recommended a new practical design that permits the removal of the PCM

plates from indoor to outdoor to benefit from nocturnal cooling, and that is by manufacturing the conventional wall with PCM fixed to it being divided into several pieces that can rotate on its axis and turn faces inside outside. Lee et al. [83] introduced the concept of plug-and-play walls that allows testing several construction materials, for residential and commercial applications, easily and under full weather conditions. The insertion of a PCM layer allowed an average daily reduction of 27.4% and 10.5% in heat transferred through the south and west walls, respectively. It was also shown that an average delay of two to three hours with the integration of PCM. The integration of PCM plates as suspended ceiling and side wall was investigated by Vik et al. [84]. After studying five different scenarios, authors concluded that using PCM plates as suspended ceiling without being covered by aluminum ceiling panels attained the highest effect, and that the PCM proved to be able to decrease the energy consumption needed for mechanical cooling of the building.

Li et al. [85] prepared a novel PCM blind system and installed it within a double skin façade to minimize the overheating problem in summer season filling the gap in the present knowledge in such domain. The prepared blind encountered an aluminum plate covered with micro-encapsulated PCM on its top surface by using epoxy risen material. The study also optimized the tilt angle of the PCM blind and its position to show that the best tilt angle was 30 degrees. The system was able to make a difference of 1 to 2.9 °C between the temperatures of the internal and external glass skins during daytime. Trombe wall systems can also be added to renovations, and suitable PCM integration and control system can enhance their performance. Favier et al. [86] prepared an automatic control system for a Trombe wall equipped with PCM located in a renovation located in Croisilles, France. The study was focused on diminishing the disadvantages behind such systems that are summarized to be: unpredictable heat transfer, night heat losses and the phenomenon of thermos-siphon. Experimental results of the designed system showed high effectiveness regarding solar energy capturing and energy management.

A novel design for a dynamic PCM layer incorporated in building envelopes was proposed Gracia et al. [87]. The system was concerned with removing the two main drawbacks of passive PCM applications in building envelopes: (1) the incomplete solidification of the PCM at night; and (2) the discharge of the absorbed internal gains (cooling load) back to indoors. The author proved the new concept by the promising results using a numerical tool that showed a cooling load reduction that can reach 379%. That means the system is able to provide cooling as well as being a thermal barrier. A schematic diagram for the proposed design is presented in Figure 10 below; The system is composed of two layers of plastic polymers containing an insulation wool layer in-between, where one side contains the PCM. It uses actuated rollers that can switch the position of the PCM from the near inside to the near outside, so that the discharge can be directed outdoors and the PCM will completely solidify.

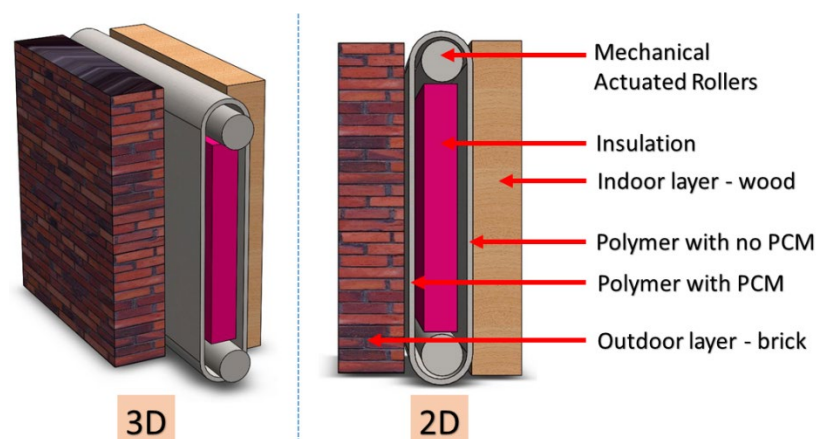

**Figure 10.** Dynamic wall concept proposed by Alvaro Gracia [87].



## 6. Laboratory-based PCM Building Partition Experimental Studies

Experiments of reduced scale prototypes or specified designed module/partition experimental studies contribute to further exploration of system performance with the advantage of higher control of variables, relatively low-cost, and the ability of working in laboratory controlled environments. Laboratory-based PCM building partition experimental studies can take the form of: (1) Building partition (i.e. walls, wallboards, window unit...etc.), (2) Heating/cooling system (i.e. HVAC with PCM unit...etc.) and (3) Reduced scale prototype ( $V \leq 1 \text{ m}^3$ ). Active and Passive Laboratory-based applications are reviewed ahead.

### 6.1 Active Laboratory-based Applications

Guo et al. [88] performed several experiments to assess the space heating performance and energy consumption characteristics; four ventilated blocks with different operation modes, and three blocks with different micro-encapsulated phase change material (PCM) distributions. The critical parameters under study were surface temperature of mortar block, the average temperature of space air, the temperature of black globe and the power consumption. The best result reached was a 41.5% increase in heating power consumption when PCM was concentrated on the upper part, and ventilation started at the same time as heating. In addition, the effect of some geometrical and operational parameters was also studied including, the thickness of mortar block, the air speed, and the diameter of tube.

As an attempt for the removal of released heat during discharging of PCM in summer nights, Yan et al. [89] proposed a novel self-activated PCM wall utilizing gravity heat-pipes imbedded into pipe-encapsulated PCM system, and linked to nocturnal radiative cooling. Figure 11 shows the mechanism of the system proposed where the working fluid used operates at its phase change temperature and pressure. During day time, PCM stores heat by transforming into its liquid state with the working fluid being transformed into gaseous state completely. During night, the gas carrying energy passes into the nocturnal radiator and releases its energy and condenses then returns into the PCM wall so that the PCM releases its stored energy into the working liquid that continues its cycle. By that, PCM will be releasing its stored energy away from the internal zone and complete solidification is ensured. Results proved that within a week of hot climate, a reduction of 74.5% in heat transferred accumulated at the interior surface of the novel PCM wall can be achieved, compared to conventional wall.

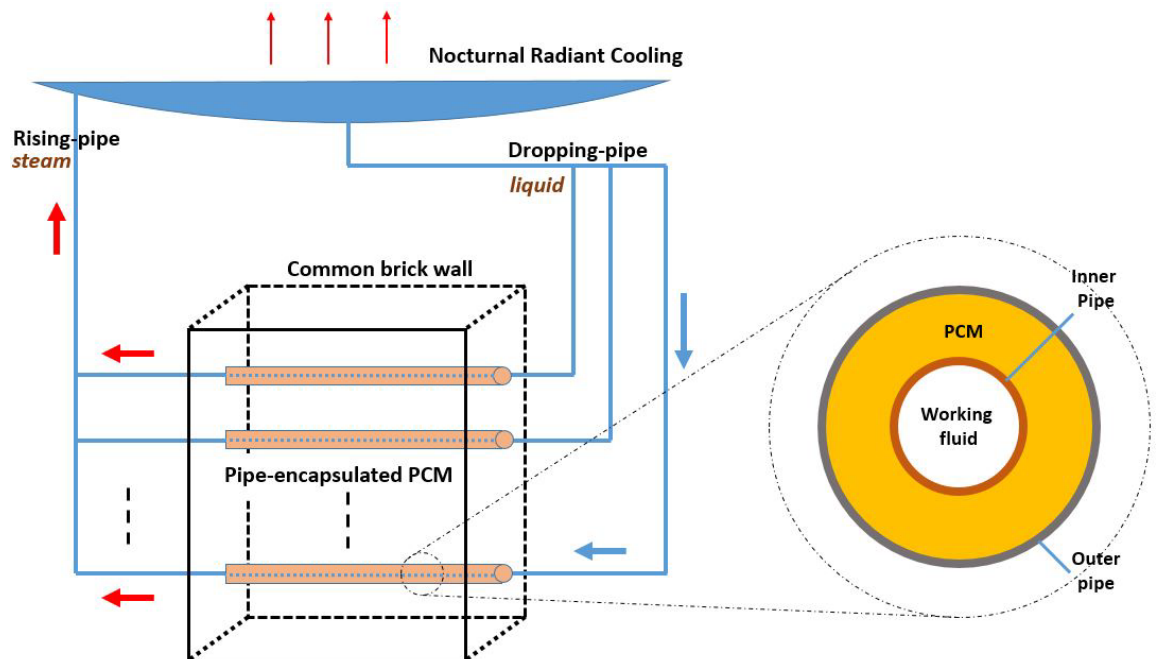

**Figure 11.** Novel self-activated PCM wall mechanism [89].

Qiao et al. [90] established a personal cooling system (PCS) integrated with PCM heat exchanger (PCMHX) as an active cooling system for local residential zones. The system comprises a vapor compression cycle where an enhanced compressed expanded natural graphite (CENG) shell-and-tube heat exchanger, filled with organic PCM, is located between the compressor and the expansion valve serving as a condenser in the cooling cycle. Two sets of thermostatic expansion valves with necessary check valves and a reversing valve allow the cycle to be reversed so that the PCM can recharge while the PCMHX serves as an evaporator. Results showed that occupants steady cooling, surrounding environment broad adaptive response, and enhanced recharging rate are achieved by the proposed PCM-PCS. Utilizing PCM cylindrical macro-capsules within an LHTES tank for heating load management in a mechanical heat pump system was studied by Xu et al. [91]. The study investigated the effect of tank orientation with specific parametric examinations. Results revealed that the temperature difference between HTF and melting PCM, and HTF flowrates are inversely proportional with PCM charging/discharging time in case of horizontal tank. Comparing the orientations, vertical tank shortens the charging/discharging time by 20% however the thermal capacity of PCM is decreased by 8.2%. A study by Saeed et al. [92] focused on investigating the effectiveness of plate type heat exchanger with phase change material as a thermal storage medium for load shifting. Results indicated that, compared to conventional systems, the prescribed design showed outstanding performance with an effectiveness reaching 83.1% regardless of poor thermal conductivity of used PCM. Sun et al. [93] designed and implemented a novel flat-heat-pipe heating system incorporating PCM and thermoelectric unit. The system was proven to be highly efficient in continuous intermittent heating. Thermoelectric unit was capable of supplying sufficient heat with high coefficient of performance (exceeding 1.7) when the heat by PCM is insufficient.

Sun et al. [94] prepared a small laboratory wind tunnel to investigate the thermal performance of ventilated slabs enhanced with paraffin-based PCM encapsulated with HDPE. The studied variables were the effect of wind speed, air temperature and inclination angles. It was found that an increase in the charging rate of the PCM equivalent to 201.7% was achieved with the increase of inlet air temperature from 35°C to 55°C. However, with a unit increase in air speed (from 4 to 5 m/s), a small increase of 8.7% in the average charging speed was recorded.

Solar air heaters equipped with PCMs are studied by various researchers on laboratory basis. Wadhawan et al. [95] analyzed the effect of using Lauric acid as PCM integrated in a thermal energy storage device (TESD) and installed in an active solar air heater module. The experimental set up used an electrical heater as a heating source while the whole setup was inside the lab. Results showed that the use of TESD yielded an average incremental rise of 86.47% regarding the output air temperature if compared to the system deprived from PCM. Abuska et al. [96] studied the effect of honeycomb core as PCM plate internal fin structure in a solar air heater. Three SAHs were used: (I) with PCM and honeycomb fins, (II) with PCM, and (III) without PCM. For different mass flow rates, results revealed that using the honeycomb matrix reduces the charge-discharge time of PCM with a slight reduction in instantaneous daily thermal efficiency. A recent study by Chen et al. [97] introduced the concept of closed collector-solar air heater system with PCM. The system was a closed loop that utilized a solar air collector with flat micro-heat pipe array, linked to a duct that allows the circulation of air through a multichannel flat-tube thermal storage unit containing PCM. Results proved that the proposed system can quickly increase PCM temperature with a maximum attainable value that have been recorded to be 68.52°C within 132 min.

### 6.2 *Passive Laboratory-based Applications*

Fateh et al. [98] prepared a numerical dynamic model for investigating the effect of PCM adoption into wall insulation layers. The model was validated by experiments done on a wall partition inside a laboratory insulated test facility simulating real environment. Results revealed that with the placement of PCM layer in positions 3 and 4 (i.e. in-between the layers of insulation at the wall center), a maximum reduction of 15% in heat energy consumption was achieved with a delay effect on the maximum heat flux of approximately 2 hrs. Evers et al. [99] tested the thermal performance of PCM-enhanced cellulose insulation placed as a wall partition in a dynamic wall simulator. The simulator was a small-scale cubicle that includes cavities in which different layers can be inserted. Two types of PCM were mixed with the insulation at 10% and 20% by weight of the wallboard: Paraffin and Salt-hydrate. Results proved that a reduction of 9.2% in the average peak heat flux was achieved by the wall containing paraffin, while no benefit was monitored regarding the salt-hydrate wall due to the hygroscopic behavior of un-encapsulated hydrate salt. Ryms and Klugmann-Radziemska [100] compared the thermal performances of three different building bricks equipped with PCM: The first containing microencapsulated PCM powder (Micronal DS 5040 X), the second containing RT22 in the form of liquid and the third containing RT22 impregnated in building porous aggregate as a carrier. Results revealed that the third method is the most promising. The problem of high expenses following the integration of microencapsulated PCMs can be solved by the presence of aggregate carrier and RT22.

A study by Li et al. [101] focused on investigating the thermal performance of a novel PCM wallboard containing three types of PCMs having consecutive melting points of 12, 18 and 29°C. The novelty behind the proposed wallboard is the ability to perform heat storage and enhance thermal comfort over a wide temperature range covering the whole year climates. Three identical reduced-scale test boxes were prepared and adopted with different wallboards: Mode 1 PCM wallboard, Mode 2 PCM wallboard and gypsum wallboard as shown in Figure 12. Preliminary results proved that thermal comfort is achieved all over the year. Also, it was found that Mode 2 is more suitable in regulating indoor temperature.

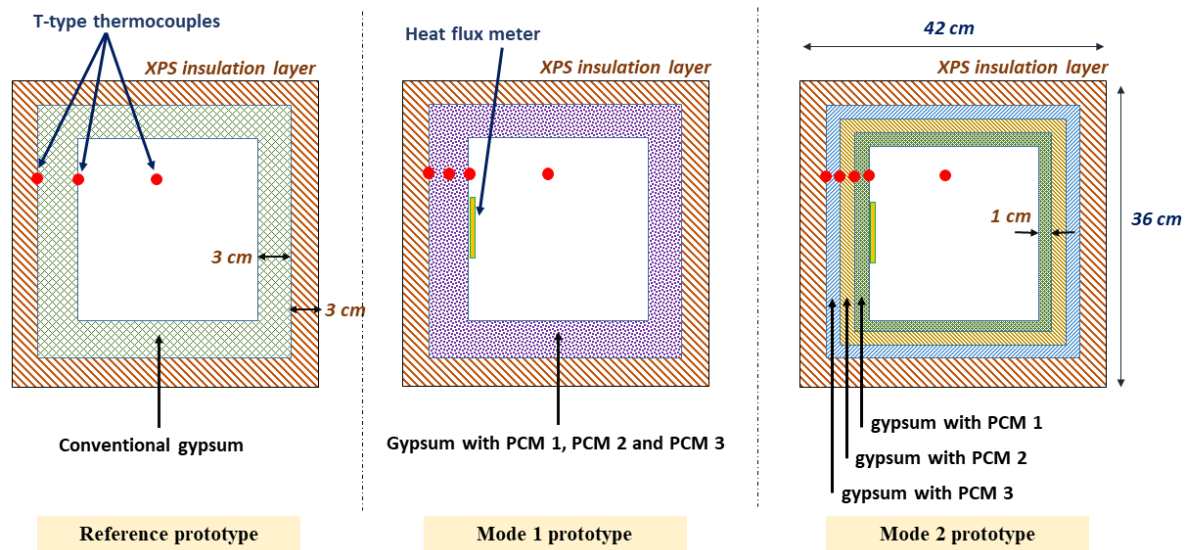

**Figure 12.** Experimental reduced-scale prototypes with PCM wallboards of different modes [101].

A study by Drissi et al. [102] covered the performance of a solar energy storage concrete panel equipped with PCM aggregates. The novel core-shell aggregates prevented the leakage of PCM and the overall concrete panels showed enhancement in their thermal performance. A reduction of 1 °C in peak temperature was monitored by means of the enhanced concrete panel ensuring a high potential for thermal comfort and electrical energy saving. Another study by Saxena et al. [103] investigated bricks embedded with PCM for building passive cooling. PCM bricks showed a reduction of 4 to 9.5 °C in temperature across their bodies compared to conventional ones. Enhancements in PCM wallboards have followed different scopes. Wang et al. [104] investigated the thermal performance of PCM honeycomb wallboard that was designed and fabricated using micro-encapsulated PCM and aluminum plate with honeycomb core. The preliminary results showed that indoor thermal conditions affect the performance of the wallboard which proved to be capable of improving heat management the next day.

Li et al. [105] studied the effect of integrating PCM with nanoparticles in a window unit for increasing building thermal inertia. The used PCM was paraffin wax having low thermal conductivity that affects the optical performance of the window presenting a disadvantage that was removed by dispersed nanoparticles. Results revealed that the PCM-nanoparticles window system encountered favorable enhancements in thermal and optical performances compared to pure PCM window. Authors recommended CuO nanoparticles, a volume fraction < 1% and a nanoparticle size < 15 nm.

**Table 2.** Thermo-physical properties of key PCMs used in experimental building applications.

PCM used	Type	Synthetic/ commercial	Application	Incorporation Method	Melting temperature, °C	Latent heat, kJ/kg	Thermal conductivity, W/m.K	Specific heat, kJ/kg.K	Reference
Rubitherm® RT28HC	Paraffin-based	Commercial	Cooling Radiative Wall	Macro- encapsulation	28	250	0.2	2	[63]
RT27	Paraffin-based	Commercial	Cooling Wall	Pipe macro- encapsulation	28	147	0.2	-	[73]
PCMTB	Paraffin-based	Commercial	Cooling Wall	Micro- encapsulation	20.6	73.4	-	-	[83]
MSPCMW	Paraffin-based	Commercial	Trombe wall	Macro- encapsulation	25-27	160	0.6	-	[57]
PCM-cellulose mixture	Paraffin-based	Synthetic	Cooling wall	Direct Mixing	28	60.45	0.2	-	[55]
Save® HS24	<i>In-organic</i>	Commercial	Radiant Roof	Macro- encapsulation	23-32	199	1.05	2.42 (l) 2.07 (s)	[64]
DuPont™ Energain® wallboards	Paraffin-based	Commercial	Heating walls	Macro- encapsulated	20-35	72.4	0.18	-	[47]
SP29	<i>In-organic</i>	Commercial	Hybrid envelope	Macro- encapsulated	28-30	190	0.6	-	[76]
RT18	Paraffin-based	Commercial	Hybrid envelope	Macro- encapsulated	17-19	225	0.2	-	[76]
-	-	Commercial	Heating Solar wall	-	18-24	70	-	2.5	[59]
CAHA PCM	<i>Organic Mixture</i>	Synthetic	Heating PCM floor with SWH	Pipe macro- encapsulation	19-25	266.28	0.148 (l) 0.116 (s)	2.21 (l) 1.975 (s)	[48]

PX35 with epoxy resin	<i>Organic</i>	Synthetic	Cooling PCM blind for DSF	Micro-encapsulated	28.2-38.5	77.8	0.1 (for PX35)	1.6 (for PX35)	[85]
-	<i>In-organic</i>	-	Cooling walls	Macro-encapsulation	18-26	216	0.25(l) 0.5 (s)	1.78	[82]
DuPont™ Energain® wallboards	Paraffin-based	Commercial	Cooling walls and ceiling	Macro-encapsulated	21.7	70	0.117	2.5	[72]
Bio-PCM ENRG Blanket™	<i>Organic</i>	Commercial	Cooling walls and ceiling	Macro-encapsulated	25	165-200	0.128	2.1	[72]
RT-26	Paraffin-based	Commercial	Cooling PCMSIP walls, floor and roof	Macro-encapsulated	26.1 – 32.2	131	0.2	2	[75]
PureTemp 37	<i>Organic</i>	Commercial	Active personal cooling system	Macro-encapsulated	37	210	0.15 (l) 0.25 (s)	2.63 (l) 2.21 (s)	[90]
ZDJN-28	Paraffin-based	Commercial	Active cooling ventilated slabs	Shape-stabilized	22.1-32.5	231.2	0.16 (l) 0.36 (s)	2.3 (l) 2.15 (s)	[94]
A23 Plus-ice	Paraffin-based	Commercial	Hybrid capillary tube PCM wall and ceiling	Micro-encapsulated	21	210	0.18	2.22	[65]
PCM-RT25HC	<i>Organic</i>	Commercial	Hybrid active PCM storage unit	Macro-encapsulated	22-26	230	0.2	2	[49]
SavE® OM-37	<i>In-organic</i>	Commercial	Cooling walls and roof	Macro-encapsulated	36-40	218	0.13 (l) 0.16 (s)	-	[69]
Paraffin wax	Paraffin-based	Commercial	Hybrid wall	Macro-encapsulated	42-72	250	0.25	1.84	[70]
Hydrate Salt	<i>In-organic</i>	Commercial	Cooling Insulation wall	Direct Mixing	29	175	1	2.3 (l) 1.4 (s)	[99]

Paraffin PCM	Paraffin-based	Commercial	Cooling Insulation wall	Direct Mixing	28	179	0.2	2.4 (l) 1.8 (s)	[99]
Paraffin wax 22	Paraffin-based	Commercial	Ventilated window	Immersion	22	216	0.18	2.85	[61]
Hydrated salt	<i>In-organic</i>	Synthetic	Cooling wall	Macro- encapsulated	31.4	149.9	-	-	[106]
Fatty-acid Eutectic	<i>Organic Eutectic</i>	Synthetic	Hybrid PCM- TIM wall	Macro- encapsulated	21.3	152	0.182	2.09 (l) 1.67 (s)	[60]
PCM-27	-	-	Cooling PCM wall	Macro- encapsulated	27	172.42	0.58 (l) 1.05 (s)	2.22 (l) 1.42 (s)	[74]
RT28 with EG	Paraffin-based	Synthetic	Self-activated cooling wall	Macro- encapsulated	26.5-28.5	160.2	9.8 (l) 9.5 (s)	1.981	[89]
Pure Temp PT20	Bio-based	Commercial	Cooling walls and ceiling	Impregnation	20	171	0.14 (l) 0.23 (s)	2.15 (l) 2.07 (s)	[32,107]
Bio-PCM Q25 M51	Bio-based	Commercial	Hybrid walls and radiant ceiling	Macro- encapsulation	25	200	0.2	-	[54]

3

**Table 3.** Summary of literature prototype designs and specifications for PCM building applications.

4

Testing Criteria	Prototype application (s)	Interchangeable sections	Climate	Testing duration	Design specifications			Instrumentation	Ref.	
					Test Cell Dimensions		Window			
					$(l \times w \times h)$					Door
Small-scale prototype	Radiant Cooling PCM Wall	-	Hot summer of Hefei, Anhui.	3 days	1000 × 950 × 1000 $mm^3$		-	500 × 500 $mm^2$	17 Cu-constant-Cu TCs, Pyranometer, Hot-wire anemometer	[63]

Small-scale prototype	PCM walls	Walls	Laboratory reflecting hot Midwestern US	120 hrs.	$1200 \times 1200 \times 1200 \text{ mm}^3$	-	-	T-type TCs, Heat flux meter	[73]
Retrofitting	PCM walls	60 PPW panels with variable thicknesses	Hot summer	Full year (3 days presented)	4200 m <sup>2</sup> (M2SEC)	N.A.	N.A.	T-type TCs, Heat flux meter	[83]
Large-scale prototype	Trombe wall	-	Hefei, Anhui.	3 days	N.A.	N.A.	N.A.	Cu-constantan TCs, Pyranometer	[57]
Large-scale prototype	PCM-insulation wall	-	DOE Region 4, USA	3 days	$1830 \times 1830 \times 1520 \text{ mm}^3$	N.A.	N.A.	T-type TCs, Heat flux meter	[55]
Small-scale prototype	Active radiant roof	Roof	Mumbai, India	16 hrs.	$710 \times 710 \times 710 \text{ mm}^3$	130 × 130 mm <sup>2</sup>	-	T-type TCs	[64]
Large-scale prototype	PCM walls and ceiling	-	Casablanca	3 days (2 periods)	$3000 \times 3000 \times 3000 \text{ mm}^3$	N.A.	N.A.	K-type TCs, weather station* (Vantage Pro 2), heat flux meter	[47]
Small-scale prototype	PCM walls, floor and roof	-	China	6 days (2 periods)	$1000 \times 1000 \times 1000 \text{ mm}^3$	700 × 700 mm <sup>2</sup>	-	K-type TCs, Solar radiation sensor	[76]
Large-scale prototype	PCM solar wall	-	Environment simulator (SSEC) Montreal, Canada	80 hrs.	$3000 \times 1500 \times 2650 \text{ mm}^3$	2000 × 2000 mm <sup>2</sup>	-	Thermocouples	[59]
Large-scale prototype	PCM floor with SWH	Door and window	Tianjin, China	15 days	N.A.	1st: 600 × 400 mm <sup>2</sup> 2nd: 1200 × 1200 mm <sup>2</sup>	800 × 1800 mm <sup>2</sup>	T-type TCs, Heat flow meter, ultrasonic heat meter, micro-weather station	[48]



<i>Retrofitting</i>	PCM blind system with DSF	Blinds	Ningbo, China	4 days	N.A.	$DSF: 1050 \times 950 \text{ mm}^2$	N.A.	20 K-type TCs, Pyranometer, hot wire anemometer weather station	[85]
Small-scale prototype	PCM walls and roof	-	Chengdu, China	3 days	$1000 \times 800 \times 1300 \text{ mm}^3$	-	-	26 T-type TCs	[82]
<i>Retrofitting</i>	PCM wall	-	Chengdu, China	3 days	$5600 \times 3800 \times 2700 \text{ mm}^3$	2 windows: $1700 \times 900 \text{ mm}^2$	$800 \times 2000 \text{ mm}^2$	9 T-type TCs	[82]
Small-scale prototype	PCM wall and ceiling	Internal wall layers	Toronto, Canada	9 weeks in 4 months (July-Oct)	(Scale 1:10 of conventional Canadian compartments)	80% of front wall	-	8 TCs, Netatmo weather station. and 2 HFP01 Hukseflux heat flux sensors	[72]
Small-scale prototype	PCMSIP walls	Walls, floor and roof	Laboratory hot environment (dynamic wall simulator)	2 days	$1129 \times 1129 \times 1129 \text{ mm}^3$	-	-	34 T-type TCs and 4 Heat flux sensors	[75]
Small-scale prototype	Capillary tube PCM wall and ceiling	Ceiling	Laboratory environment	250 min	$1200 \times 1300 \times 2000 \text{ mm}^3$	-	-	5 K-type TCs	[65]
Large-scale prototype	SAH with active PCM storage system / underfloor heating with PCM	Inner wall layers	Auckland, New Zealand	3 days	$2400 \times 2400 \times 2400 \text{ mm}^3$	$100 \times 100 \text{ mm}^2$	N.A.	T-type TCs, VAEQ08E pyranometer, power meter, and AM-4201 anemometer	[32,49]

Small-scale prototype	PCM walls and roof	-	Mathura, India	24 hrs	$1120 \times 1120 \times 1120 \text{ mm}^3$	$150 \times 150 \text{ mm}^2$	$150 \times 460 \text{ mm}^2$	12 K-type TCs, thermal imager and 10 heat flux meters	[69]
Small-scale prototype	PCM enhanced insulation wall	Walls, floor and roof	Laboratory environment	24 hrs	$1220 \times 1220 \times 1220 \text{ mm}^3$	-	-	12 T-type TCs and 4 heat flux meters	[70]
Large-scale prototype	Ventilated window with PCM HX	Window	Copenhagen, Denmark	15 hrs	N.A.	$1060 \times 1970 \text{ mm}^2$	-	56 K-type TCs	[61]
Laboratory test facility	PCM enhanced insulated wall	Wall layers	Laboratory environment	24 hrs	$1000 \times 2000 \times n.a. \text{ mm}^3$	-	-	NTC thermistors, and 8 heat flux meters	[98]
Large-scale prototype	PCMTS enhanced insulated wall	Wall layers	Lawrence, KS, USA	24 hrs	$1830 \times 1830 \times 1220 \text{ mm}^3$	N.A.	N.A.	T-type TCs and heat flux meters	[106]
Small-scale prototype	PCM wall	Single wall layer	Borj Cedria, Tunisia	14 days	$500 \times 500 \times 500 \text{ mm}^3$	-	-	13 T-type TCs	[74]
Laboratory test facility	Self-activated pipe-encapsulated PCM wall	-	Laboratory environment	~9 hrs	-	-	-	6 K-type TCs	[89]
Retrofitting	Double pipe PCM underfloor heating	-	Zhangjiakou, China	26 days	$6400 \times 4000 \times 2700 \text{ mm}^3$	Two windows: $2400 \times 800 \text{ mm}^2$	-	T-type TCs, hygrothermograph, micro weather station, and heat flux meters	[78]
Large-scale prototype	PCM solar wall	-	Jilin, China	16 hrs	$5000 \times 1600 \times 2200 \text{ mm}^3$	-	$800 \times 1800 \text{ mm}^2$	K-type TCs	[58]

\* Vantage Pro 2 is equipped with 9 sensors: Hot wire anemometer; wind vane; thermo-hygrometer; wind, rainfall, temperature and humidity sensors; barometer and a pyranometer. 5

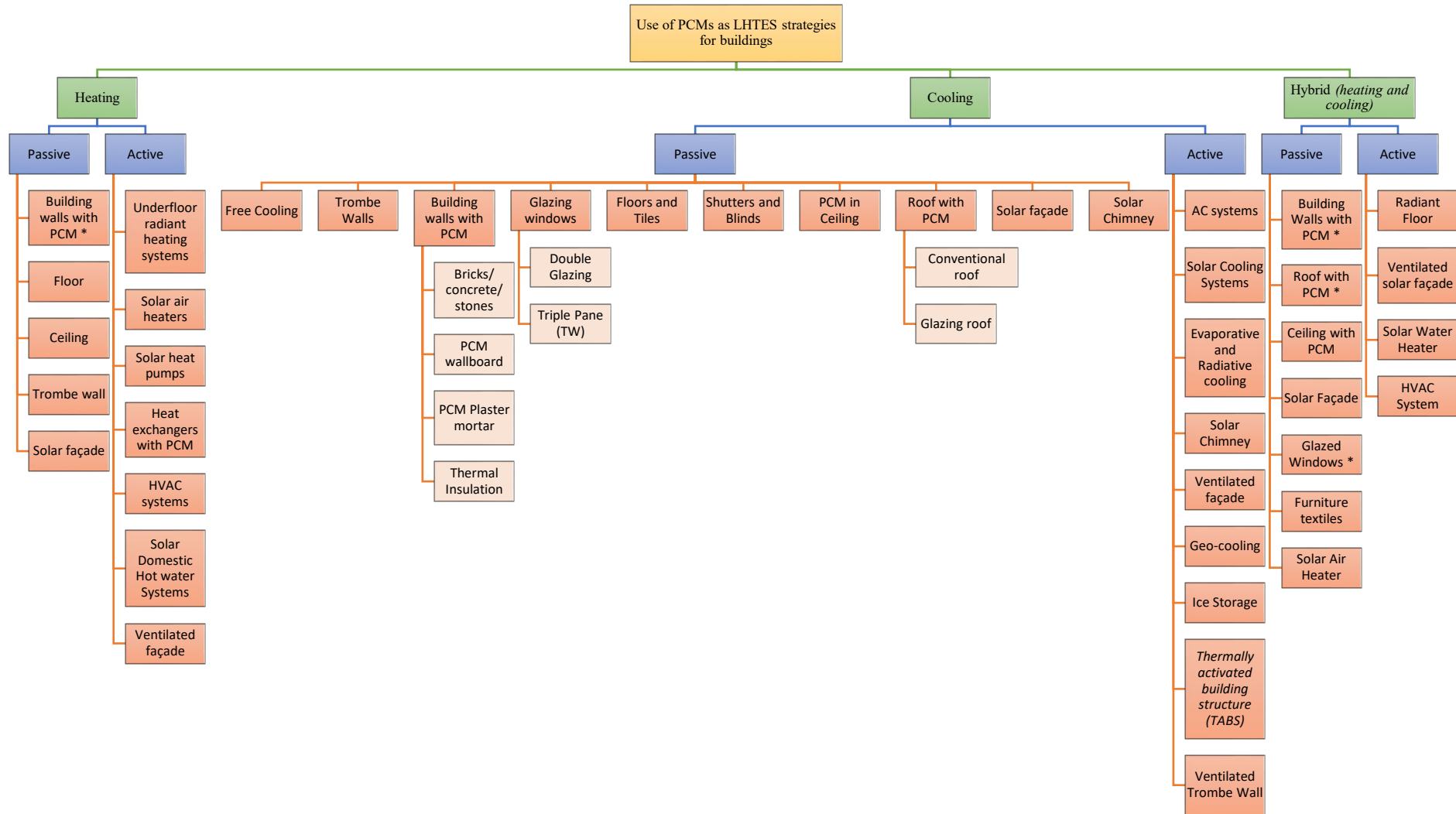

Figure 13. Summary of heating, cooling and hybrid PCM applications in buildings [30,108].

---

## 7. Discussion

As depicted from the reviewed articles above, different facilities of diverse purposes, components, sizes and methods, yield different results and variable feasibility in data treatment and analysis. However, for multi-purpose tests, parametric studies and optimization analysis, modular prototypes that best simulates reality with several possible configurations are essential. The reviewed articles vary in their approaching towards best modular design. To ensure building up proper design of an advanced modular prototype it is crucial to identify discrepancies and glitches of recent studied facilities.

The first aspect to be discussed is the assembling and disassembling methods and possibilities of the prototype used. Welded frames of prototypes [63][73], prohibit their rearrangement and packaging for long distance transportation (to be tested in different sites/ different weather). Side walls that are made from single layer of insulation [63][76], do not reflect conventional real wall compositions. Also, permanent constructed testing rooms, in case of large scale prototypes, are limited in the possibility to interchange layers and introduce applications. Rooms that utilize cement and bricks as the foundation of their frames and envelopes, lack the ability to be disassembled and thus are limited to few PCM applications and are located in permanent sites [47][48][51]. Although, in some studies different layers could be added/removed so that certain modified applications may be investigated [49][50], still the complete disassembling is difficult. On the other hand, removable plate walls [73][99] are highly esteemed, where the method of plug-and-play wall panels seems to be more efficient [83].

Parametric feasibility, being the second aspect, is related to but not only: Variable wall thicknesses (which were limited to 75 mm for the roof and 50 mm for other envelope components in [63]); Variable location of layers especially PCM (PCM placement was not varied in most studies, for instance, SP29 was placed in floor, ceiling and west walls while RT18 was placed in north and east walls throughout the whole study of Meng et al. [76]); and probable application integration and applications combinations. In this case, studies seem poor with combined applications. Limitation to one specific application was encountered by Guarino et al. (solar wall [59]), Hu and Heiselberg (window [61]) Garg et al. (radiant heat exchanger in the roof [64])...etc. A summary of all possible applications for active/passive, heating/cooling/hybrid PCM building applications is presented in the hierarchy diagram of Figure 13. All applications can be studied using one of the aforementioned experimental methods/ facilities: Large-scale prototype, small-scale prototype, retrofitting/renovation, or Laboratory-based modules/partitions, however, interests must be directed toward modular large-scale or small-scale prototypes as combinations of several applications fit with their capabilities if proper design was followed.

As for PCM position, changing the location of PCM could be done manually or by means of automated system. However, for manual movement of PCM layer occupants cannot withstand continuous dismantling of the envelope PCM layer for night cooling as this is against human comfort [82]. The method given by Gracia et al. [87] for PCM location variation, encounters some challenges, where having a movable layer inside the building construction build up the need of complete thermal contact. Friction while moving the layer is another problem and regular maintenance of the mechanical system is critical in this case.

Proper selection of PCM for each application and weather condition yields to maximize the benefit from PCM as in the case of Li et al. [85]. However, modular prototypes are affected with PCM utilization method in terms of encapsulation technique and possibility for type variation. PCMs that are embedded as shape-stabilized plates are permanent and the study of different PCM type requires preparation from the beginning. Macro-encapsulation with permanent containers that are sealed with no possibility to refill are not considered parametric containers. Zhou et al. [52] used two sizes of bags containing

an inorganic PCM with no conductivity enhancement and compared their effect on thermal comfort with sensible sand. Sinka et al. [54] used commercial DuPont Energain® wallboards (containing paraffin) and Bio PCM pouches. On the other hand, Wang et al. [104] PCM board was enhanced with honeycomb metal matrix. The used PCMs in the studied literature are summarized with their thermos-physical properties, application and incorporation methods in Table 2.

The fourth aspect is related to thermal performance under real or near real weather conditions, and parameter sensing tools (and control systems in case of active applications). It is acceptable to a certain extent, but not quite relevant, to swap between indoor and outdoor environments. Having a solar energy source inside the prototype and an AC outside was followed by Zhang et al. [75] and Sun et al. [73], where the environments are swapped. This questions the effect of room to surrounding relative volume. In addition, most laboratory-based partitions are subjected to heat transfer fluxes that do not reflect real weather [102] [105]. Even though some studies [96][103] investigate a partition under real weather condition, the real effect on thermal comfort and energy saving within typical construction is not conceivable. Control system for cooling/heating plays an important role in energy management and is complementary to PCM applications; this was recommended by Berardi and Soudian [72] and implemented by Favier et al. [86].

The fifth aspect is related to economic approaches and life cycle analysis, and is still a common issue lacking in most studies. For instance, Kong et al. [53] terminated their research with an economic study to show that the payback time is 3.32 years. Stritih et al. [79] found that payback time was 1 year for the conventional system and 2 years for that with LHTES. In this aspect, expensive prototypes and experiments loses interest, so advancements in prototype designs that are cost effective are highly desirable.

Finally, the whole study focused on reviewing experimental investigations using different facilities to generate a new design of a modular prototype. For that, a summary of the studied literature system/prototype designs and specifications is made and tabulated in Table 3 including application, testing duration and climate, design interchangeable sections, design dimensions and instrumentations used. The design of the new modular prototype can be then initiated and proposed.

## 8. Proposed Design of the New Modular Prototype

Recent studies are directed toward optimizing the use of PCM as TES system and benefit from its outstanding characteristics and properties. Optimization through software simulators still lack the ability to integrate a completely liable real picture of the suitable PCM type, position, application and amount. Experimental investigation directed toward optimization is the key answer for a better integration of PCM in buildings. In previous studies [30], it was shown that literature on PCMs are mainly focused on active and passive systems being studied separately. However, more research is needed to study the effectiveness of combining different systems. Possible combinations require modular prototypes that best fit with the changing variables, and easy in assembling and reassembling different partitions forming different systems.

Based on the studied literature, an advanced small-scale modular prototype is proposed and designed using a drawing CAD software: SolidWorks, with all dimensions, views and finishing presented in illustrations. The designed prototype target is to give the researcher during experiments an ability to perform comparative testing on a building modal that reflects real erections utilizing real construction materials, and following local and international standards. The prototype design process follows a deliberated criterion that fulfills three main goals: (1) The designed prototype must allow the integration of different configurations and system combinations; (2) the designed prototype must allow the integration and adaptation of different PCM types, amounts, and positions; and (3) the designed prototype must be of suitable scale and reflects real building compartments. A summary of the goals and their detailed features is presented in Figure 14.

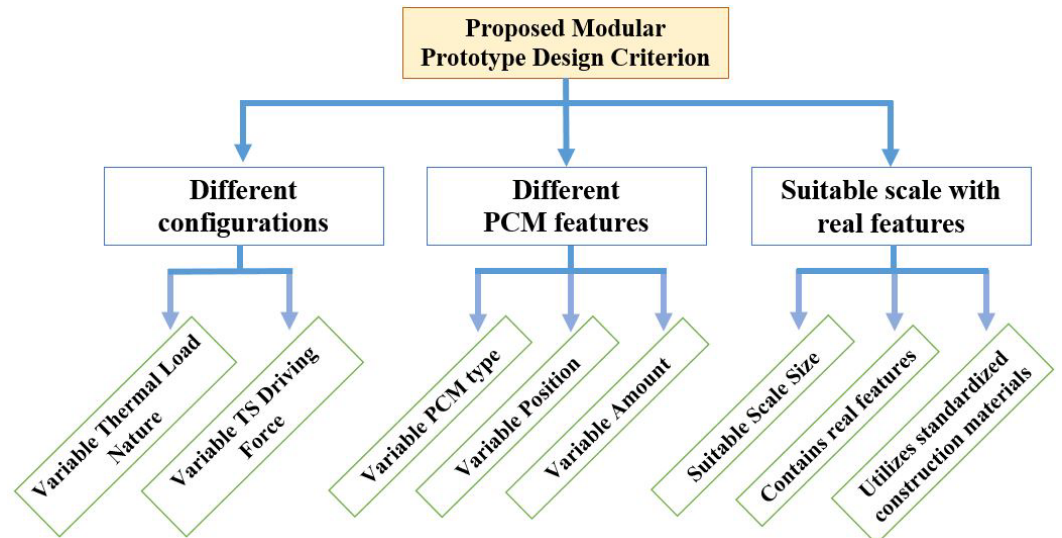

**Figure 14.** Summary of the goals and their details corresponding to the criterion followed in the design.

The designed prototype is suitable for varying configurations based on thermal load nature by which heating, cooling and hybrid PCM systems are enabled through the model. It also allows variant combinations of passive-passive, passive-active or active-active systems in correspondence to the TS driving force. Suitable macro-encapsulation technique is proposed such that different PCM types and amounts as well as position are allowed. Finally, the prototype scale is considered to be a small-scale prototype that can be used for real testing weather conditions as well as laboratory controlled environments (or other suitable controlled environment chambers such as agricultural refrigerators). The proposed test facility utilizes standardized construction materials such as aluminum studs, conventional insulations and wallboards, and contains real building features such as windows, doors, solar façade, trombe wall... etc.

The design steps of the prototype are presented in chronological order starting with the skeletal structure and its dimensions, methods followed for assembling and reassembling the facility, prototype features presenting different application modules and a summary of the capabilities and possible combinations, and finally the instrumentation prescribed for obtaining a complete set of data for analysis.

### 8.1 Structure and Dimensions

The prototype skeletal structure is illustrated in Figure 15. The skeleton is constructed from squared Aluminum hollow beams ( $A_{c,1} = 100 \times 100 \text{ mm}^2$ ) with the edge thickness of 2 mm. The skeleton uses L-shaped Aluminum connectors with suitable screws (presented in Figure 16) to be linked tightly allowing high weights. Two additional aluminum studs of a rectangular cross-section ( $A_{c,2} = 100 \times 40 \text{ mm}^2$ ) are joined to the frame of the wall that will be containing the prototype door. The assembled skeletal structure is composed of squared frames of side  $S = 1600 \text{ mm}$  (floor and roof) connected to each other by 4 beams and two studs having a length of 1200 mm. On the internal edges of each face lies Aluminum L-channels that are prescribed to hold different layers such that the total internal volume is preserved to be  $2.352 \text{ m}^3$  ( $V_{\text{int}} = 1400 \times 1400 \times 1200 \text{ mm}^3$ ) regardless of the application or layer thickness used.

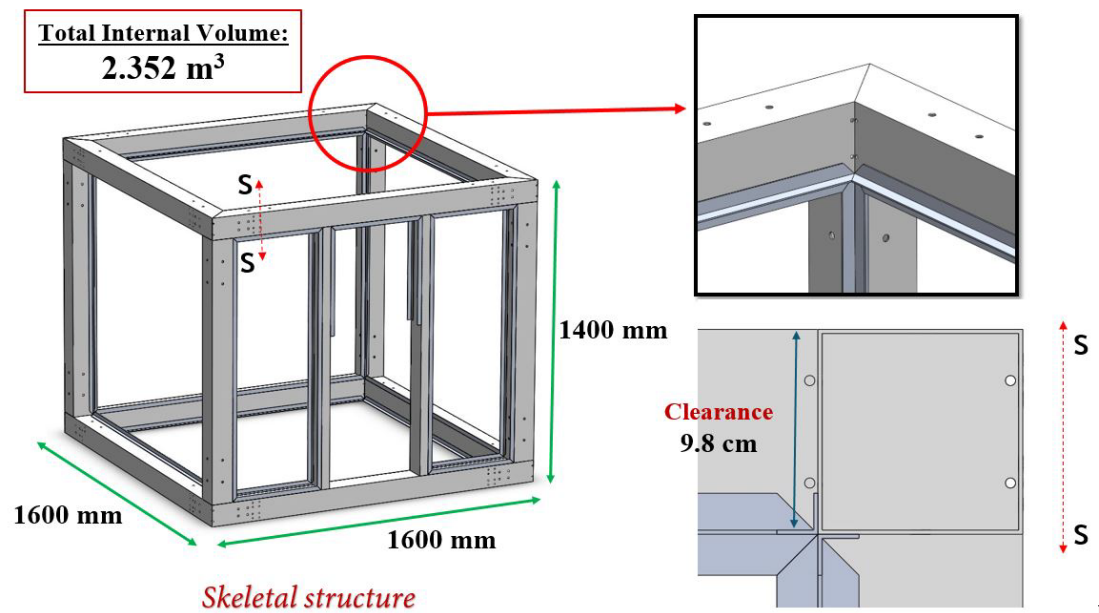

Figure 15. Skeletal structure of the prototype and its dimensions.

151  
152  
153

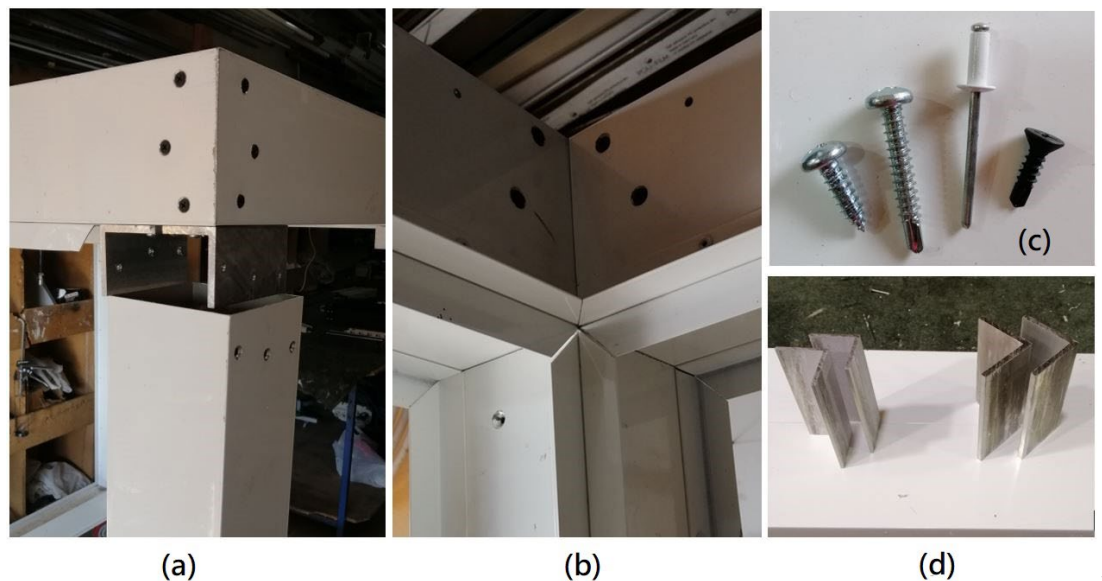

Figure 16. Joining the frames and L-channels: (a) outside view of the corner, (b) inside view of the corner, (c) suitable screws, and (d) L-connectors used.

154  
155  
156  
157  
158  
159  
160  
161  
162  
163  
164  
165  
166  
167  
168  
169  
170

Different internal wall layers are added to each side such that their total thickness in normal situations varies such that  $0 < t \leq 98$  mm. However, the possibility to have larger thicknesses is enabled if the 2<sup>nd</sup> method of assembling is followed (*refer to section 7.2*). The prescribed added layers are conventional materials used for construction of residents and their properties and dimensions are presented in Table 4. An example illustrating the installation of different layers is presented in Figure 17. The prototype is designed to have a door fixed on the vertical side that contains the studs, and a window on any other vertical side. The door is 450 mm wide and 700 mm long, made of aluminum frame and double glazing with air as insulation. The window is 600 mm wide, 420 mm wide, composed of two sliding parts (double glazing with aluminum frames). The prototype is mounted on 4 heavy-duty wheels allowing its free transformation. Two of the wheels are equipped with breaks to enable regular building stability during the test.

**Table 4.** Characteristics of possible wall layers used in the initial assembly of the prototype.

Possible wall layers	Characteristics					
	Thickness, t	Density, $\rho$	Specific Heat, $C_p$	Conductivity, $\lambda$	Flammability	Ref.
	mm	Kg/m <sup>3</sup>	kJ/kg.K	W/m.K	-	
Aluminum L-channel	2	2698	0.921	205	Fire resistant	[109,110]
Aluminum container	28	2698	0.921	205	Fire resistant	[109,110]
XPS insulation	30	20.8 – 43.1	-	0.029	Fire resistant	[111]
Glass Wool insulation	10	16-40	-	0.035-0.05	Fire resistant	[112]
Wood base layer and wood cover layer	12	-	1.3-2.4	0.41-0.19	Flammable	[109,113,114]
Aluminum composite ( <i>Alucobond</i> ®)	4	0.222	-	( $U = 5.54$ W/m <sup>2</sup> .K)	Fire resistant	[115]

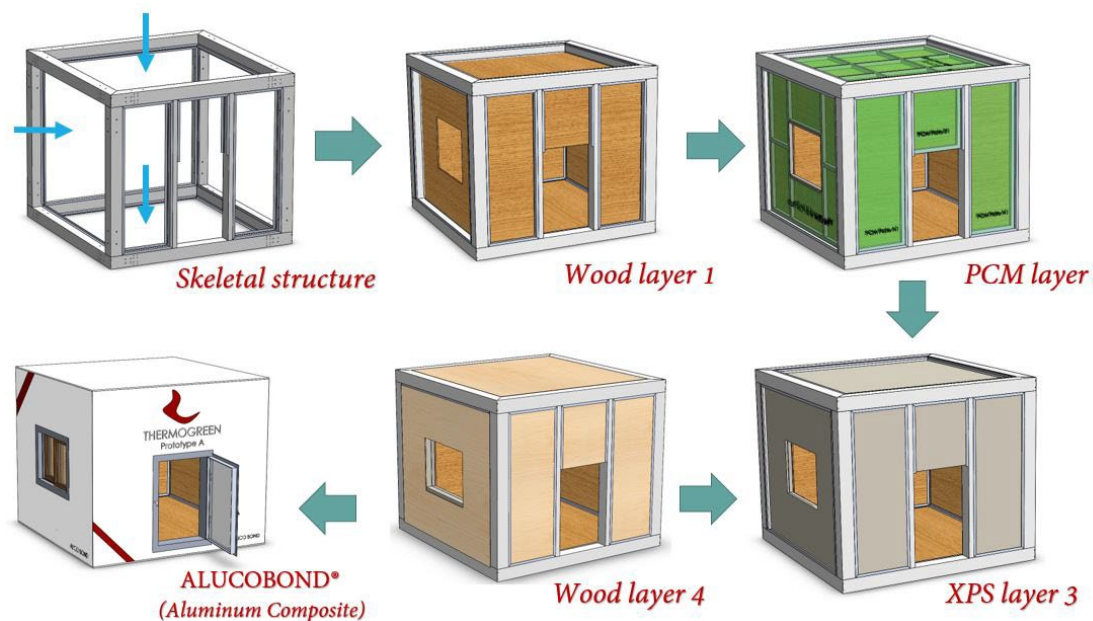

**Figure 17.** Installation of different layers to form a complete prototype.

The method of engaging PCM in the prototype is of highly importance. Incorporation techniques are known to be mainly 5: (1) direct mixing, (2) impregnation, (3) macro-encapsulation, (4) microencapsulation and (5) shape stabilization. The method proposed in the design is macro-encapsulation using fabricated aluminum containers. Aluminum is



known to be of high thermal conductivity and relatively low weight (compared to other metals), and is able to withstand high loads. The container is designed such that two options of the overall size are adopted: (1) small size and (2) large size, as presented in Figure 18. The final fabricated plate is formed of a rectangular aluminum foil (with a 1.5 mm thickness) bent at its edges to form a shell of 1400 mm length and 466 mm width. Another foil is bent at its edges and flipped upside down to form the cover of the first foil. Then they are welded together and two valves with screws are added on one top end of the plate for filling and draining PCM.

Since most PCMs suffer from low thermal conductivities, enhancement techniques are proposed by several researchers. For instance, vacuum impregnation of n-Octadecane PCM by a supportive material: Nano porous carbon was prepared by Ji et al. [116]. The composite obtained PCM proved to be promising in terms of thermal energy storage. Righetti et al. [117] studied the effectiveness of using 3D periodic structures of aluminum macro-containers embedded with paraffin wax PCM, having several base pore sizes. It was shown that the charging and discharging of the LHTES system was enhanced by the innovative metallic structures coupled to PCM. Lin et al. [118] reviewed recent studies on thermal conductivity enhancement for PCMs. The review states that thermal enhancement of PCM can be realized by adding high thermal conductivity additives such as carbon and encapsulation of PCM. In the current study, a novel method that combines both ways of PCM thermal conductivity enhancement is proposed. Macro-encapsulation with refillable high thermal conductivity Aluminum containers is coupled with the addition of aluminum buffers crossed with copper wires at the middle layer of the plate. Aluminum buffers of 350 mm length are placed 100 mm apart one by one on each consecutive side. These buffers are drilled at their middle fiber each 50 mm, by which 3 mm diameter copper wires are crossed as shown in Figure 18 and the final plate is shown in Figure 19. In addition to thermal conductivity enhancement, copper wires could be connected to electrical suppliers -with suitable insulators at the buffers pores around the wires- to form a thermally activated PCM layer in case of active heating application.

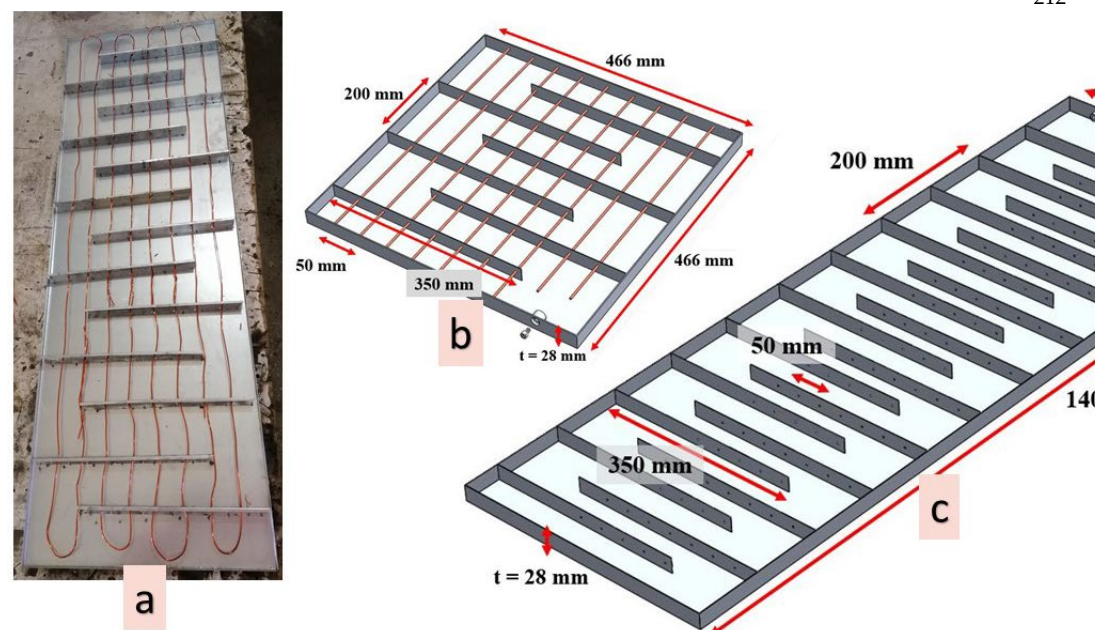

**Figure 18.** The enhanced plate: (a) a real picture, and detailed dimensions of: (b) small and (c) large containers.

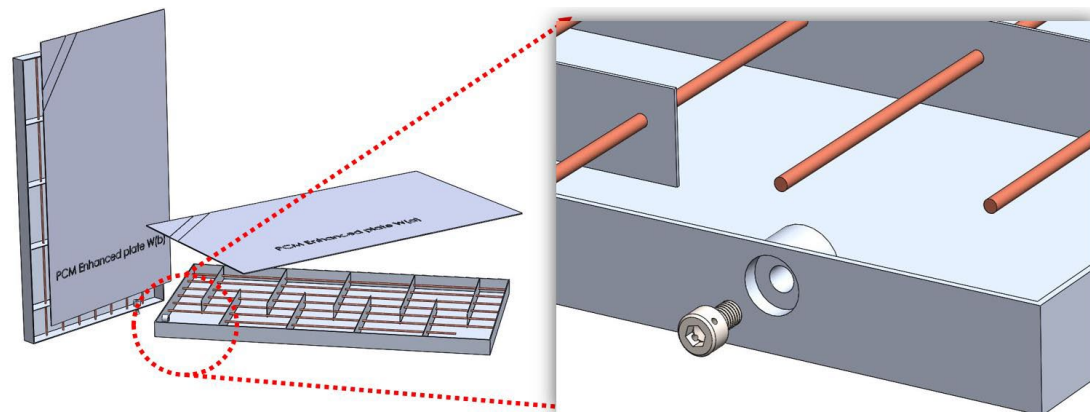

**Figure 19.** Enhanced PCM macro-encapsulating container.

### 8.2 Method of installation and disassembly

The prototype is designed to be modular, thus, different layers at each side, roof and floor are to be installed and adapted frequently (changing material, position, thickness...etc.) while ensuring complete thermal contact. The installation process follows two different methods or a combination of both:

- Vertical installation of all layers;
- Horizontal installation of sides and vertical installation of roof and floor.

The first method is done by eliminating the upper aluminum frame from the structure by unfastening the relevant screws and inserting the proper layers between two L-shape channels within a clearance of 96 mm presenting the maximum allowable thickness of each side. For varying the thickness, a convenient rigid frame of plastic or any other low conductivity material is to be used as a virtual layer. The role of the frame is to fill the gap between the outer layer and the supporting L-shape channel. After that, the roof skeletal frame is rejoined to the walls and screws are fastened. Roof layers are installed and finally the covering ALUCOBOND® wallboards are added. It is worth mentioning that there will be a clearance of 2 mm between the last two layers forming an insulation.

The second method is done by conserving the skeleton of the room, with only one L-shape channel at the internal edges as prescribed previously in the design, and placing the layers of the floor and roof vertically. In the case of sides, the layers are installed horizontally by plugging them over each other and finally locking/compressing them by means of hold down toggle clamps that are fixed to the skeleton of the room. The pin in the clamp is adjustable, such that variable thicknesses are allowed. Latching toggle clamps may be used to support the hold down toggle clamps and ensure that the layers do not buckle (refer to Figure 20). The implementation steps of the prototype are shown in real photographs on-site in Figure 21. The final ALUCOBOND layers can now be fixed by screws covering the skeleton and the final layer. The assembled prototype and the exploded view showing all layers in the case of a combined hybrid application: "Underfloor heating with PCM integrated in all layers" is shown in Figure 22. The designed prototype is named *ThermoGreen*®.

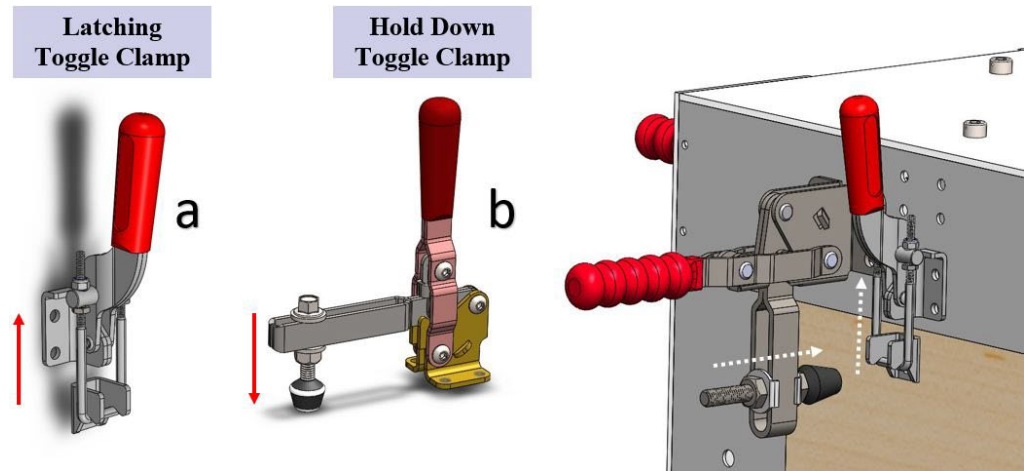

**Figure 20.** Toggle clamps used in the designed prototype: (a) Latching toggle clamp and (b) Hold down toggle clamp.



**Figure 21.** Real pictures showing different installed components in the implemented prototype.

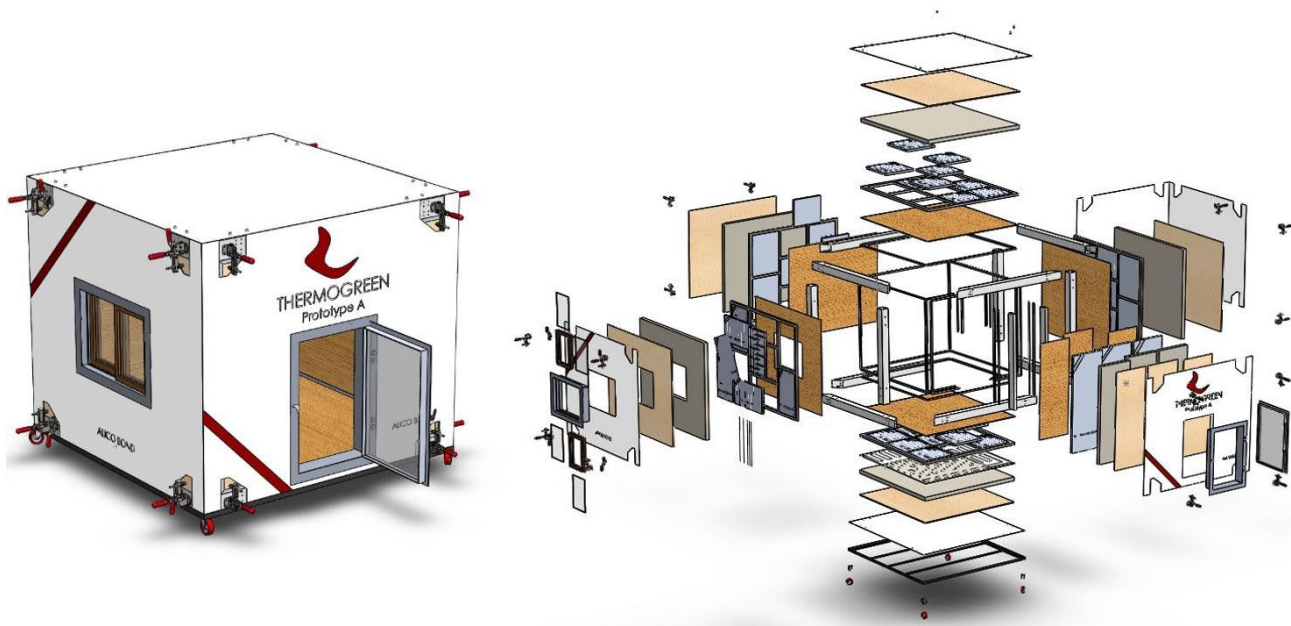

**Figure 22.** Proposed prototype design: final assembly and exploded view.

*8.3 Capabilities and Possible Combinations*

The applications that are enabled by the prototype are possible combinations of passive-passive, active-active or passive-active, heating, cooling or hybrid systems. A summary of the possible variable features *ThermoGreen®* is capable of is presented in Figure 23, and any combination of these applications is permitted. Two identical prototypes following the proposed design are prepared and built in Al-Rafid, Bekaa Valley, Lebanon. Figure 24 shows a photographed picture of one of the prototypes prepared.

THERMOGREEN® Capabilities		
Building wall	Solar façade	Evaporative and radiative cooling systems
Roofs and ceilings	Shutters and blinds	Underfloor radiant hybrid systems
Floors and tiles	Free cooling	Solar air heater
Glazing windows	Furniture Textiles	Solar water heater
Trombe wall	HVAC system	TABS

**Figure 23.** The capabilities of the proposed prototype.



**Figure 24.** Real photo of a prepared prototype following the design proposed in the study.

Building walls (including bricks with PCM), wallboards, PCM-enhanced insulations and PCM-enhanced plastering mortars are enabled in all the prototype faces: walls, roof and floor. Figure 25 illustrates a brick wall installed on one side with covering plastering mortar. An extra plastic frame can be added on the internal sides of the aluminum skeletal frame preventing its damage upon building up brick wall with cement. Double glazing window and door are removable and can be filled with PCM. A solar air heater can be installed after editing the side wall with another set of layers containing two openings at the upper and lower regions as shown in Figure 25. The same layers can be equipped with solar façade module (Figure 26) or Trombe wall system (Figure 27), all being easily installed and removed by adjustable tensioning screws that are located at pre-designed locations covering all applications. All layers could be deprived and special radiant heating/cooling layers are added. These layers are enhanced full size plates containing PCM and have radiant copper/PEX pipes embedded within. The piping system terminals of all layers passes through the internal cavity of the skeletal aluminum structure and are finally joined using a collector manifold that is linked to a circulating pump with necessary valves and pressure gauges.

Finally, any combination of the aforementioned applications and other applications mentioned in Figure 28 can be implemented with the prototype for the sake of conducting investigating experiments. The objective behind such experiments is the optimization of: PCM type, quantity, position, application and combination. All is toward giving best set of applications and PCMs toward NZEB.

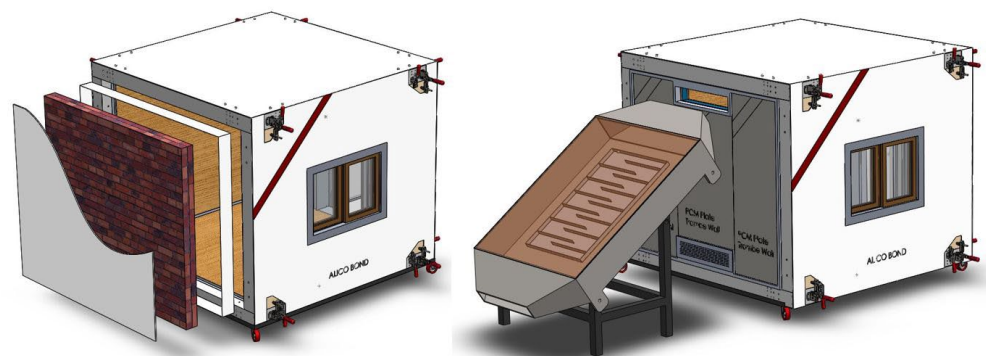

**Figure 25.** Brick wall sections for application P1 (to the left) and Solar air heater installed with necessary edits of the side wall of ThermoGreen® (to the right).

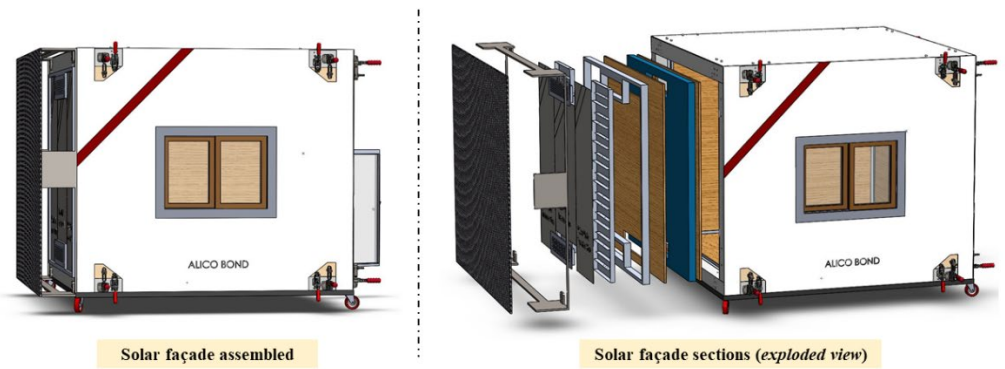

Figure 26. Solar façade sections mounted on the side wall of ThermoGreen®.

305

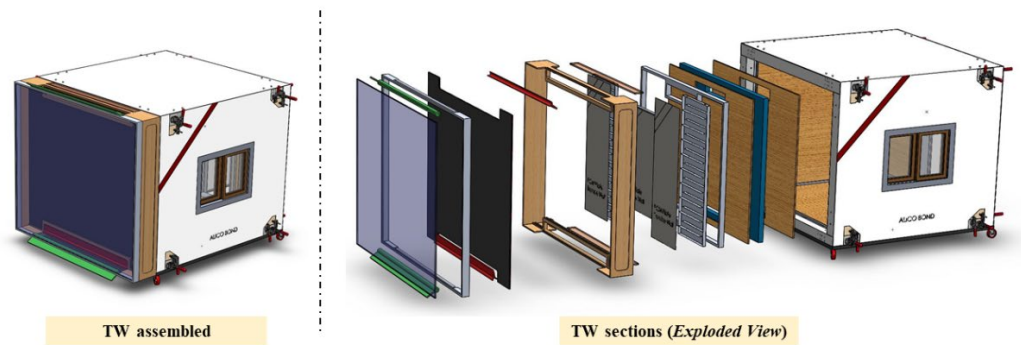

Figure 27. Modified Trombe wall sections mounted on the side wall of ThermoGreen®.

307

308

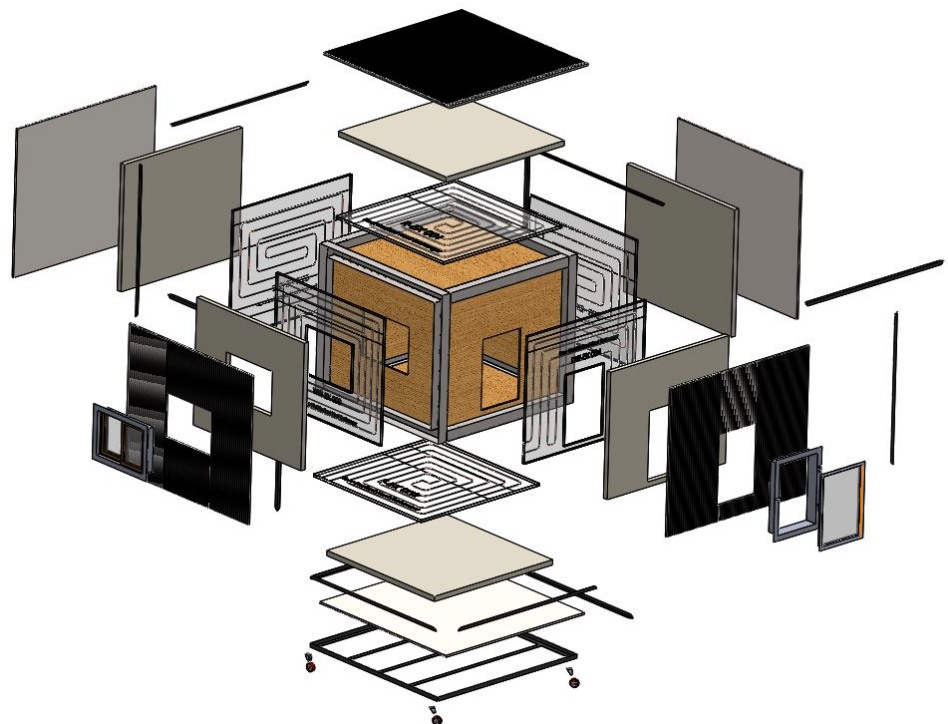

Figure 28. Thermally activated building structure (TABS) applied within the prototype using radiant pipes embedded in PCM plates.

309

310

311

312

8.4 Measurement Instrumentations

313

314

Adequate experimental results that are directed toward optimization and further standardization requires advanced measurement instrumentations that are: (1) reliable

315

316

with low uncertainty values; (2) available and cost-effective; (3) covers all required data of all influencing variables; (4) positioned in relevant sensing locations; (5) highly sensitive and (6) referenced to international/local standards. From this point, instruments used in reviewed studies by researchers (*summarized in* Table 3) are organized in a table of measurement instruments possibilities that can be used for experimental studies covered by ThermoGreen® (See Table 5). An example of connecting measuring system of the application of underfloor active radiant heating with PCM is illustrated in Figure 29.

**Table 5.** Measured parameters and their possible instrumentations from literature.

Measured Parameters	Possible Instrument	Ref.
Temperature, T	• K-type and T-type thermocouples	[47], [48]
	• NTC thermistors	[98]
	• Ebro TFX430	[32]
	• PT100 RTD	[52]
Heat flux, q	• HF01 Hukseflux heat flux sensor	[72]
	• Sequoia heat flux plates	[119]
	• HM-25-U/100	[52]
Radiation, q	• Solar Pyranometer (TBQ-2)	[63], [57]
	• VAEQ08E pyranometer	[32,49]
Humidity h, and pressure, P	• Vantage Pro 2 weather station	[47]
	• Netatmo weather station	[72]
Air velocity (wind speed), v	• Hot-wire anemometer, AM-4201	[32,49]
Flow rate, Q	• LWGYB-25	[52]
Electrical Consumption, P	• Carrel Electrade LP-1W1	[32]
	• Agilent 34970A	[52]
Data Acquisition	• HOBO U-10-003	[72]
	• Agilent 34970A	[57]
	• HIOKI LR840-21	[63]

326

327

328

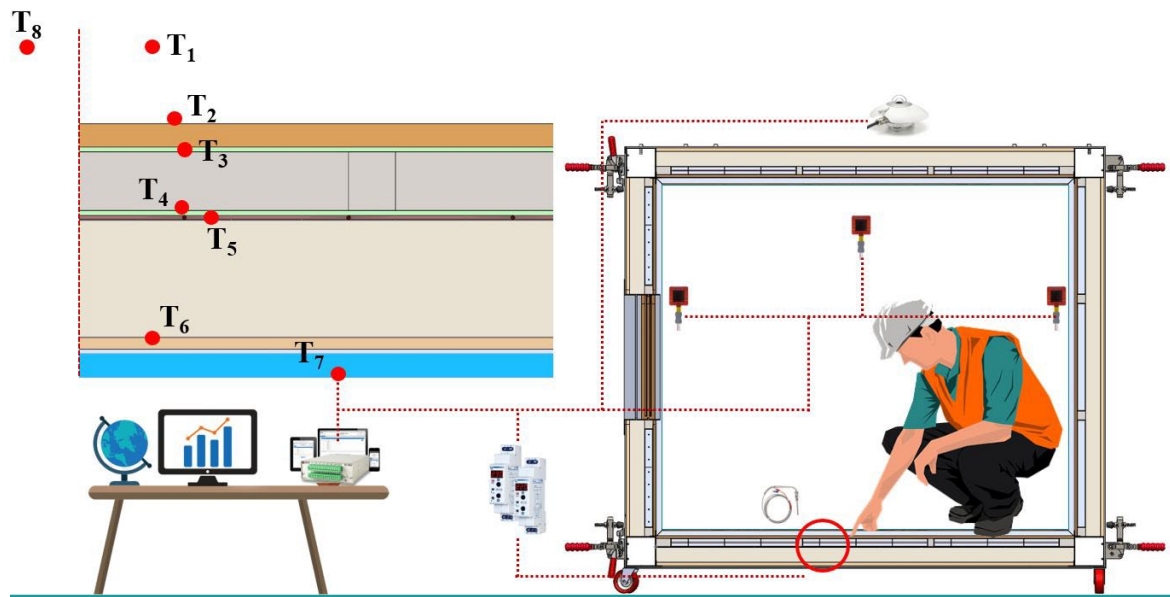

**Figure 29.** Schematic diagram showing the locations of different sensing instruments (heat flux meters, thermocouples, pyranometer and data acquisition tool with a computer) for underfloor heating with PCM using ThermoGreen®.

## 9. Conclusions and Recommendations

A summary review on recent research articles covering experimental investigations of thermal performance for PCM-LHTES building applications in heating, cooling and hybrid modes. Experimental type of studies requires a facility that best reflects the performance of PCM on real-basis. The study summarized articles after classifying them into four main categories: (1) Large-scale prototypes, (2) Small-scale prototypes, (3) Retrofits and (4) Laboratory-based partitions/modules. Presented literature in each category were then classified into two sets: active and passive systems, and a helical diagram that summarizes all applications was illustrated. Then, two tables were generated; The first summarized the used PCMs in each classified application with their respective thermo-physical properties and encapsulation techniques; While, the second table summarized the facilities used in literature studies, their design specifications, and instrumentations. After monitoring the prototypes presented in experiments of literature, a proposed modular design was explained and possible experimental investigations for different applications were abridged.

Conclusions are then drawn showing that:

- Phase change material serving as latent heat storage system is a promising technology that permits building energy consumption reduction and thermal comfort sustainability.
- Experimental studies were classified into four categories based on the size of the used facility:
  - Small-scale prototypes do have plenty of advantages: e.g. variables control... etc., with a risk of not presenting reality.
  - Large-scale prototypes are expensive but have high level of matching real weather performance.
  - Retrofitting applications are limited in possibilities
  - Laboratory-based studies are easily adapted but includes high level of uncertainty compared to other realistic studies (utilizing prototypes).
- Heat Transfer Enhancement for the incorporated PCM is critical for diminishing its incomplete solidification is solved by the designed enhanced macro-encapsulated plates.



- 
- A new design of an advanced modular prototype: “ThermoGreen®” is proposed and is proven to allow experimental investigation of several PCM applications and their combinations toward NZEB. 366
  - Experimental Optimization is a major capability offered by the designed prototype (Variable thickness, position, material, application...etc.) 367

368

369

370

371

Finally, it is worth mentioning that PCMs is a promising evolving technology that can help in energy consumption reduction toward sustainable living. This limitless horizon of unknown potentials in such domain requires more research that is organized and direct properly. 372

373

374

375

376

**Conflicts of Interest:** The authors declare no conflict of interest. 377

## References

1. Du, K.; Calautit, J.; Wang, Z.; Wu, Y.; Liu, H. A Review of the Applications of Phase Change Materials in Cooling, Heating and Power Generation in Different Temperature Ranges. *Applied Energy* **2018**, *220*, 242–273, doi:10.1016/j.apenergy.2018.03.005. 378–381
2. Plytaria, M.T.; Bellos, E.; Tzivanidis, C.; Antonopoulos, K.A. Numerical Simulation of a Solar Cooling System with and without Phase Change Materials in Radiant Walls of a Building. *Energy Conversion and Management* **2019**, *188*, 40–53, doi:10.1016/j.enconman.2019.03.042. 382–384
3. Liu, J.; Mei, C.; Wang, H.; Shao, W.; Xiang, C. Powering an Island System by Renewable Energy—A Feasibility Analysis in the Maldives. *Applied Energy* **2018**, *227*, 18–27, doi:10.1016/j.apenergy.2017.10.019. 385–386
4. Peker, M.; Kocaman, A.S.; Kara, B.Y. Benefits of Transmission Switching and Energy Storage in Power Systems with High Renewable Energy Penetration. *Applied Energy* **2018**, *228*, 1182–1197, doi:10.1016/j.apenergy.2018.07.008. 387–388
5. Zia, M.F.; Elbouchikhi, E.; Benbouzid, M. Microgrids Energy Management Systems: A Critical Review on Methods, Solutions, and Prospects. *Applied Energy* **2018**, *222*, 1033–1055, doi:10.1016/j.apenergy.2018.04.103. 389–390
6. Husein, M.; Chung, I.Y. Optimal Design and Financial Feasibility of a University Campus Microgrid Considering Renewable Energy Incentives. *Applied Energy* **2018**, *225*, 273–289, doi:10.1016/j.apenergy.2018.05.036. 391–392
7. Zhu, C.; Li, B.; Yan, S.; Luo, Q.; Li, C. Experimental Research on Solar Phase Change Heat Storage Evaporative Heat Pump System. *Energy Conversion and Management* **2021**, *229*, doi:https://doi.org/10.1016/j.enconman.2020.113683. 393–394
8. Wu, D.; Rahim, M.; El, M.; Djedjig, R.; Bennacer, R.; Liu, B. Experimental Investigation on the Hygrothermal Behavior of a New Multilayer Building Envelope Integrating PCM with Bio-Based Material. *Building and Environment* **2021**, *201*, doi:10.1016/j.buildenv.2021.107995. 395–397
9. IEA *Global Energy & CO2 Status Report 2019*; Paris, 2019; 398
10. Preet, S. Water and Phase Change Material Based Photovoltaic Thermal Management Systems: A Review. *Renewable and Sustainable Energy Reviews* **2018**, *82*, 791–807, doi:10.1016/j.rser.2017.09.021. 399–400
11. Zeinelabdein, R.; Omer, S.; Gan, G. Critical Review of Latent Heat Storage Systems for Free Cooling in Buildings. *Renewable and Sustainable Energy Reviews* **2018**, *82*, 2843–2868, doi:10.1016/j.rser.2017.10.046. 401–402
12. Mehdaoui, F.; Hazami, M.; Messaouda, A.; Taghouti, H.; Guizani, A. Thermal Testing and Numerical Simulation of PCM Wall Integrated inside a Test Cell on a Small Scale and Subjected to the Thermal Stresses. *Renewable Energy* **2018**, doi:10.1016/j.renene.2018.12.029. 403–405
13. Saeed, R.M.; Schlegel, J.P.; Castano, C.; Sawafta, R.; Kuturu, V. Preparation and Thermal Performance of Methyl Palmitate and Lauric Acid Eutectic Mixture as Phase Change Material ( PCM ). *Journal of Energy Storage* **2017**, *13*, 418–424, doi:10.1016/j.est.2017.08.005. 406–408
14. Yan, T.; Luo, Y.; Xu, T.; Wu, H.; Xu, X.; Li, J. Experimental Study of the Coupled Wall System of Pipe-Encapsulated PCM Wall and Nocturnal Sky Radiator for Self-Activated Heat Removal. *Energy & Buildings* **2021**, *241*, doi:10.1016/j.enbuild.2021.110964. 409–411
15. Memarian, S.; Mohammad, B.; Fayaz, R.; Asadi, S. Single and Combined Phase Change Materials: Their Effect on Seasonal Transition Period. *Energy & Buildings* **2018**, *169*, 453–472, doi:10.1016/j.enbuild.2018.03.085. 412–413
16. Erlbeck, L.; Schreiner, P.; Fasel, F.; Methner, F.; Rädle, M. Investigation of Different Materials for Macroencapsulation of Salt Hydrate Phase Change Materials for Building Purposes. *Construction and Building Materials* **2018**, *180*, 512–518, doi:10.1016/j.conbuildmat.2018.05.204. 414–416
17. Drissi, S.; Ling, T.; Hung, K.; Eddhahak, A. A Review of Microencapsulated and Composite Phase Change Materials: Alteration of Strength and Thermal Properties of Cement-Based Materials. *Renewable and Sustainable Energy Reviews* **2019**, *110*, 467–484, doi:10.1016/j.rser.2019.04.072. 417–419

- 
18. Marin, P.; Saffari, M.; Gracia, A. De; Zhu, X.; Farid, M.M.; Cabeza, L.F.; Ushak, S. Energy Savings Due to the Use of PCM for Relocatable Lightweight Buildings Passive Heating and Cooling in Different Weather Conditions. *Energy & Buildings* **2016**, *129*, 274–283, doi:10.1016/j.enbuild.2016.08.007. 420–422
  19. Fateh, A.; Klinker, F.; Brütting, M.; Weinläder, H. Numerical and Experimental Investigation of an Insulation Layer with Phase Change Materials (PCMs). *Energy & Buildings* **2017**, doi:10.1016/j.enbuild.2017.08.007. 423–424
  20. Young, B.A.; Falzone, G.; Wei, Z.; Sant, G.; Pilon, L. Reduced-Scale Experiments to Evaluate Performance of Composite Building Envelopes Containing Phase Change Materials. *Construction and Building Materials* **2018**, *162*, 584–595, doi:10.1016/j.conbuildmat.2017.11.160. 425–427
  21. Lee, K.O.; Medina, M.A.; Raith, E.; Sun, X. Assessing the Integration of a Thin Phase Change Material ( PCM ) Layer in a Residential Building Wall for Heat Transfer Reduction and Management Q. *APPLIED ENERGY* **2014**, doi:10.1016/j.apenergy.2014.09.003. 428–430
  22. Yang, L.; Huang, J.; Zhou, F. Thermophysical Properties and Applications of Nano-Enhanced PCMs: An Update Review. *Energy Conversion and Management* **2020**, *214*, 112876, doi:10.1016/j.enconman.2020.112876. 431–432
  23. Liu, A.F.; Zhu, J.; Liu, J.; Ma, B. Preparation and Properties of Capric-Stearic Acid / White Carbon Black Composite for Thermal Storage in Building Envelope. *Energy & Buildings* **2017**, doi:10.1016/j.enbuild.2017.09.076. 433–434
  24. Kara, Y.; Kurnuc, A. Performance of Coupled Novel Triple Glass and Phase Change Material Wall in the Heating Season: An Experimental Study. *Solar Energy* **2012**, *86*, 2432–2442, doi:10.1016/j.solener.2012.05.012. 435–436
  25. Farid, M.M.; Khudhair, A.M.; Razack, S.; Al-Hallaj, S. A Review on Phase Change Energy Storage: Materials and Applications. *Energy Conversion and Management* **2004**, *45*, 1597–1615, doi:10.1016/j.enconman.2003.09.015. 437–438
  26. Li, C.; Yu, H.; Song, Y.; Liu, Z. Novel Hybrid Microencapsulated Phase Change Materials Incorporated Wallboard for Year-Long Year Energy Storage in Buildings. *Energy Conversion and Management* **2019**, *183*, 791–802, doi:10.1016/j.enconman.2019.01.036. 439–441
  27. Wei, G.; Wang, G.; Xu, C.; Ju, X.; Xing, L.; Du, X.; Yang, Y. Selection Principles and Thermophysical Properties of High Temperature Phase Change Materials for Thermal Energy Storage: A Review. *Renewable and Sustainable Energy Reviews* **2017**, doi:10.1016/j.rser.2017.05.271. 442–444
  28. Morrison, D.J.; Abdel-Khalik, S.I. Effects of Phase-Change Energy Storage on the Performance of Air-Based and Liquid-Based Solar Heating Systems. *Solar Energy* **1978**, *20*, 57–67, doi:10.1016/0038-092X(78)90141-X. 445–446
  29. Ghoneim, A.A. Comparison of Theoretical Models of Phase Change and Sensible Heat Storage for Air and Water-Based Solar Heating Systems. *Solar Energy* **1989**, *42*, 209–220. 447–448
  30. Faraj, K.; Khaled, M.; Faraj, J.; Hachem, F.; Castelain, C. Phase Change Material Thermal Energy Storage Systems for Cooling Applications in Buildings: A Review. *Renewable and Sustainable Energy Reviews* **2019**, doi:10.1016/j.rser.2019.109579. 449–450
  31. Chhugani, B.; Klinker, F.; Weinlaeder, H.; Reim, M. Energetic Performance of Two Different PCM Wallboards and Their Regeneration Behavior in Office Rooms. *Energy Procedia* **2017**, *122*, 625–630, doi:10.1016/j.egypro.2017.07.360. 451–452
  32. Barzin, R.; Chen, J.J.J.; Young, B.R.; Farid, M.M. Application of PCM Underfloor Heating in Combination with PCM Wallboards for Space Heating Using Price Based Control System. *Applied Energy* **2015**, *148*, 39–48, doi:10.1016/j.apenergy.2015.03.027. 453–455
  33. Faraj, K.; Faraj, J.; Hachem, F.; Bazzi, H.; Khaled, M.; Castelain, C. Analysis of Underfloor Electrical Heating System Integrated with Coconut Oil-PCM Plates. *Applied Thermal Engineering* **2019**, *158*, doi:10.1016/j.applthermaleng.2019.113778. 456–457
  34. Souayfane, F.; Fardoun, F.; Biwole, P.H. Phase Change Materials (PCM) for Cooling Applications in Buildings: A Review. *Energy and Buildings* **2016**, *129*, 396–431, doi:10.1016/j.enbuild.2016.04.006. 458–459
  35. Giro-paloma, J.; Martínez, M.; Cabeza, L.F.; Fernández, A.I. Types , Methods , Techniques , and Applications for Microencapsulated Phase Change Materials ( MPCM ): A Review. *Renewable and Sustainable Energy Reviews* **2016**, *53*, 1059–460–461

- 1075, doi:10.1016/j.rser.2015.09.040. 462
36. Kasaeian, A.; bahrami, L.; Pourfayaz, F.; Khodabandeh, E.; Yan, W.M. Experimental Studies on the Applications of PCMs and Nano-PCMs in Buildings: A Critical Review. *Energy and Buildings* **2017**, *154*, 96–112, doi:10.1016/j.enbuild.2017.08.037. 463
37. Tao, Y.B.; He, Y. A Review of Phase Change Material and Performance Enhancement Method for Latent Heat Storage System. *Renewable and Sustainable Energy Reviews* **2018**, *93*, 245–259, doi:10.1016/j.rser.2018.05.028. 464
38. Kylili, A.; Fokaides, P.A. Life Cycle Assessment (LCA) of Phase Change Materials (PCMs) for Building Applications: A Review. *Journal of Building Engineering* **2016**, *6*, 133–143, doi:10.1016/j.job.2016.02.008. 465
39. Navarro, L.; Gracia, A. De; Colclough, S.; Browne, M.; McCormack, S.J.; Grif, P.; Cabeza, L.F. Thermal Energy Storage in Building Integrated Thermal Systems: A Review. Part 1. Active Storage Systems. *Renewable Energy* **2016**, *88*, 526–547, doi:10.1016/j.renene.2015.11.040. 466
40. Navarro, L.; Gracia, A. De; Niall, D.; Castell, A.; Browne, M.; McCormack, S.J.; Grif, P.; Cabeza, L.F. Thermal Energy Storage in Building Integrated Thermal Systems: A Review. Part 2. Integration as Passive System. *Renewable Energy* **2016**, *85*, 1334–1356, doi:10.1016/j.renene.2015.06.064. 467
41. Mengjie, S.; Fuxin, N.; Ning, M.; Yanxin, H.; Shiming, D. Review on Building Energy Performance Improvement Using Phase Change Materials. *Energy and Buildings* **2018**, *158*, 776–793, doi:10.1016/j.enbuild.2017.10.066. 468
42. Lizana, J.; Chacartegui, R.; Barrios-padura, A.; Ortiz, C. Advanced Low-Carbon Energy Measures Based on Thermal Energy Storage in Buildings: A Review. *Renewable and Sustainable Energy Reviews* **2018**, *82*, 3705–3749, doi:10.1016/j.rser.2017.10.093. 469
43. Romdhane, S. Ben; Amamou, A.; Khalifa, R. Ben; Saïd, N.M.; Younsi, Z.; Jemni, A. A Review on Thermal Energy Storage Using Phase Change Materials in Passive Building Applications. *Journal of Building Engineering* **2020**, *32*, doi:10.1016/j.job.2020.101563. 470
44. Li, Y.; Nord, N.; Xiao, Q. Building Heating Applications with Phase Change Material: A Comprehensive Review. *Journal of Energy Storage* **2020**, *31*, doi:10.1016/j.est.2020.101634. 471
45. Javadi, F.S.; Metselaar, H.S.C.; Ganesan, P. Performance Improvement of Solar Thermal Systems Integrated with Phase Change Materials (PCM), a Review. *Solar Energy* **2020**, *206*, 330–352, doi:10.1016/j.solener.2020.05.106. 472
46. Magrini, A.; Lentini, G.; Cuman, S.; Bodrato, A.; Marengo, L. From Nearly Zero Energy Buildings (NZEB) to Positive Energy Buildings (PEB): The next Challenge - The Most Recent European Trends with Some Notes on the Energy Analysis of a Forerunner PEB Example. *Developments in the Built Environment* **2020**, *3*, doi:10.1016/j.dibe.2020.100019. 473
47. Mourid, A.; El Alami, M.; Kuznik, F. Experimental Investigation on Thermal Behavior and Reduction of Energy Consumption in a Real Scale Building by Using Phase Change Materials on Its Envelope. *Sustainable Cities and Society* **2018**, *41*, 35–43, doi:10.1016/j.scs.2018.04.031. 474
48. Lu, S.; Zhao, Y.; Fang, K.; Li, Y.; Sun, P. Establishment and Experimental Verification of TRNSYS Model for PCM Floor Coupled with Solar Water Heating System. *Energy & Buildings* **2017**, *140*, 245–260, doi:10.1016/j.enbuild.2017.02.018. 475
49. Gholamibozanjani, G.; Farid, M. Application of an Active PCM Storage System into a Building for Heating/Cooling Load Reduction. *Energy* **2020**, doi:10.1016/j.energy.2020.118572. 476
50. Gholamibozanjani, G.; Farid, M. A Comparison between Passive and Active PCM Systems Applied to Buildings. *Renewable Energy* **2020**, doi:10.1016/j.renene.2020.08.007. 477
51. de Gracia, A.; Navarro, L.; Castell, A.; Ruiz-Pardo, Á.; Álvarez, S.; Cabeza, L.F. Experimental Study of a Ventilated Facade with PCM during Winter Period. *Energy and Buildings* **2013**, *58*, 324–332, doi:10.1016/j.enbuild.2012.10.026. 478
52. Zhou, G.; He, J. Thermal Performance of a Radiant Floor Heating System with Different Heat Storage Materials and Heating Pipes. *Applied Energy* **2015**, *138*, 648–660, doi:10.1016/j.apenergy.2014.10.058. 479
53. Kong, X.; Wang, L.; Li, H.; Yuan, G.; Yao, C. Experimental Study on a Novel Hybrid System of Active Composite PCM Wall and Solar Thermal System for Clean Heating Supply in Winter. *Solar Energy* **2020**, *195*, 259–270, 480

- doi:10.1016/j.solener.2019.11.081. 504
54. Sinka, M.; Bajare, D.; Jakovics, A.; Ratnieks, J.; Gendelis, S. Experimental Testing of Phase Change Materials in a Warm-Summer Humid Continental Climate. *Energy and Buildings* **2019**, *195*, 205–215, doi:10.1016/j.enbuild.2019.04.030. 505
55. Lee, K.O.; Medina, M.A.; Sun, X.; Jin, X. Thermal Performance of Phase Change Materials (PCM)-Enhanced Cellulose Insulation in Passive Solar Residential Building Walls. *Solar Energy* **2018**, *163*, 113–121, doi:10.1016/j.solener.2018.01.086. 506
56. Wang, X.; Yu, H.; Li, L.; Zhao, M. Experimental Assessment on the Use of Phase Change Materials (PCMs)-Bricks in the Exterior Wall of a Full-Scale Room. *Energy Conversion and Management* **2016**, *120*, 81–89, doi:10.1016/j.enconman.2016.04.065. 507
57. Luo, C.; Xu, L.; Ji, J.; Liao, M.; Sun, D. Experimental Study of a Modified Solar Phase Change Material Storage Wall System. *Energy* **2017**, *128*, 224–231, doi:10.1016/j.energy.2017.04.020. 508
58. Sun, D.; Wang, L. Research on Heat Transfer Performance of Passive Solar Collector-Storage Wall System with Phase Change Materials. *Energy & Buildings* **2016**, *119*, 183–188, doi:10.1016/j.enbuild.2016.03.048. 509
59. Guarino, F.; Athienitis, A.; Cellura, M.; Bastien, D. PCM Thermal Storage Design in Buildings: Experimental Studies and Applications to Solaria in Cold Climates. *Applied Energy* **2017**, *185*, 95–106, doi:10.1016/j.apenergy.2016.10.046. 510
60. Souayfane, F.; Henry, B.; Fardoun, F. Thermal Behavior of a Translucent Superinsulated Latent Heat Energy Storage Wall in Summertime. *Applied Energy* **2018**, *217*, 390–408, doi:10.1016/j.apenergy.2018.02.119. 511
61. Hu, Y.; Heiselberg, P.K. A New Ventilated Window with PCM Heat Exchanger –performance Analysis and Design Optimization. *Energy and Buildings* **2018**, *169*, 185–194, doi:10.1016/j.enbuild.2018.03.060. 512
62. Li, H.; Li, J.; Xi, C.; Chen, W.; Kong, X. Experimental and Numerical Study on the Thermal Performance of Ventilated Roof Composed with Multiple Phase Change Material (VR-MPCM). *Energy Conversion and Management* **2020**, *213*, doi:10.1016/j.enconman.2020.112836. 513
63. He, W.; Yu, C.; Yang, J.; Yu, B.; Hu, Z.; Shen, D.; Liu, X.; Qin, M.; Chen, H. Experimental Study on the Performance of a Novel RC-PCM-Wall. *Energy and Buildings* **2019**, *199*, 297–310, doi:10.1016/j.enbuild.2019.07.001. 514
64. Garg, H.; Pandey, B.; Saha, S.K.; Singh, S.; Banerjee, R. Design and Analysis of PCM Based Radiant Heat Exchanger for Thermal Management of Buildings. *Energy and Buildings* **2018**, *169*, 84–96, doi:10.1016/j.enbuild.2018.03.058. 515
65. Jobli, M.; Yao, R.; Luo, Z.; Shahrestani, M.; Li, N.; Hong, L. Numerical and Experimental Studies of a Capillary-Tube Embedded PCM Component for Improving Indoor Thermal Environment. *Applied Thermal Engineering* **2019**, *148*, 466–477, doi:10.1016/j.applthermaleng.2018.10.041. 516
66. Fang, Y.; Ding, Y.; Tang, Y.; Liang, X.; Jin, C.; Wang, S.; Gao, X. Thermal Properties Enhancement and Application of a Novel Sodium Acetate Trihydrate-Formamide/Expanded Graphite Shape-Stabilized Composite Phase Change Material for Electric Radiant Floor Heating. *Applied Thermal Engineering* **2019**, *150*, 1177–1185, doi:10.1016/j.applthermaleng.2019.01.069. 517
67. Guo, J.; Jiang, Y.; Wang, Y.; Zou, B. Thermal Storage and Thermal Management Properties of a Novel Ventilated Mortar Block Integrated with Phase Change Material for Floor Heating: An Experimental Study. *Energy Conversion and Management* **2020**, *205*, doi:10.1016/j.enconman.2019.112288. 518
68. Abbas, H.M.; Jalil, J.M.; Ahmed, S.T. Experimental and Numerical Investigation of PCM Capsules as Insulation Materials Inserted into a Hollow Brick Wall. *Energy & Buildings* **2021**, *246*, doi:10.1016/j.enbuild.2021.111127. 519
69. Kumar, P.; Rathore, S. AN EXPERIMENTAL EVALUATION OF THERMAL BEHAVIOR OF THE BUILDING ENVELOPE USING MACROENCAPSULATED PCM FOR ENERGY SAVINGS. *Renewable Energy* **2019**, *149*, 1300–1313, doi:https://doi.org/10.1016/j.renene.2019.10.130. 520
70. Khan, R.J.; Bhuiyan, Z.H.; Ahmed, D.H. Investigation of Heat Transfer of a Building Wall in the Presence of Phase Change Material (PCM). *Energy and Built Environment* **2020**, *1*, 199–206, doi:https://doi.org/10.1016/j.enbenv.2020.01.002. 521
71. Zhu, N.; Hu, N.; Hu, P.; Lei, F.; Li, S. Experiment Study on Thermal Performance of Building Integrated with Double Layers Shape-Stabilized Phase Change Material Wallboard. *Energy* **2018**, doi:10.1016/j.energy.2018.11.042. 522

- 
72. Berardi, U.; Soudian, S. Experimental Investigation of Latent Heat Thermal Energy Storage Using PCMs with Different Melting Temperatures for Building Retrofit. *Energy and Buildings* **2019**, *185*, 180–195, doi:10.1016/j.enbuild.2018.12.016. 546  
547
73. Sun, X.; Medina, M.A.; Lee, K.O.; Jin, X. Laboratory Assessment of Residential Building Walls Containing Pipe-Encapsulated Phase Change Materials for Thermal Management. *Energy* **2018**, *163*, 383–391, doi:10.1016/j.energy.2018.08.159. 548  
549
74. Mehdaoui, F.; Hazami, M.; Messaouda, A.; Taghouti, H.; Guizani, A. Thermal Testing and Numerical Simulation of PCM Wall Integrated inside a Test Cell on a Small Scale and Subjected to the Thermal Stresses. *Renewable Energy* **2019**, *135*, 597–607, doi:10.1016/j.renene.2018.12.029. 550  
551  
552
75. Zhang, Y.; Sun, X.; Medina, M.A. Experimental Evaluation of Structural Insulated Panels Outfitted with Phase Change Materials. *Applied Thermal Engineering* **2020**, *178*, doi:https://doi.org/10.1016/j.applthermaleng.2020.115454. 553  
554
76. Meng, E.; Yu, H.; Zhou, B. Study of the Thermal Behavior of the Composite Phase Change Material (PCM) Room in Summer and Winter. *Applied Thermal Engineering* **2017**, doi:10.1016/j.applthermaleng.2017.07.110. 555  
556
77. Cheng, W.; Xie, B.; Zhang, R.; Xu, Z.; Xia, Y. Effect of Thermal Conductivities of Shape Stabilized PCM on Under-Floor Heating System. *APPLIED ENERGY* **2015**, *144*, 10–18, doi:10.1016/j.apenergy.2015.01.055. 557  
558
78. Lu, S.; Xu, B.; Tang, X. Experimental Study on Double Pipe PCM Floor Heating System under Different Operation Strategies. *Renewable Energy* **2020**, *145*, 1280–1291, doi:10.1016/j.renene.2019.06.086. 559  
560
79. Stritih, U.; Charvat, P.; Koželj, R.; Klimes, L.; Osterman, E.; Ostry, M.; Butala, V. PCM Thermal Energy Storage in Solar Heating of Ventilation Air—Experimental and Numerical Investigations. *Sustainable Cities and Society* **2017**, doi:10.1016/j.scs.2017.10.018. 561  
562  
563
80. Lamnatou, C.; Motte, F.; Notton, G.; Chemisana, D.; Cristofari, C. Building-Integrated Solar Thermal System with/without Phase Change Material: Life Cycle Assessment Based on ReCiPe, USEtox and Ecological Footprint. *Journal of Cleaner Production* **2018**, *193*, 672–683, doi:10.1016/j.jclepro.2018.05.032. 564  
565  
566
81. Nada, S.A.; Alshaer, W.G.; Saleh, R.M. Experimental Investigation of PCM Transient Performance in Free Cooling of the Fresh Air of Air Conditioning Systems. *Journal of Building Engineering* **2020**, *29*, doi:10.1016/j.jobee.2019.101153. 567  
568
82. Wang, C.; Huang, X.; Deng, S.; Long, E.; Niu, J. An Experimental Study on Applying PCMs to Disaster-Relief Prefabricated Temporary Houses for Improving Internal Thermal Environment in Summer. *Energy and Buildings* **2018**, *179*, 301–310, doi:10.1016/j.enbuild.2018.09.028. 569  
570  
571
83. Lee, K.O.; Medina, M.; Sun, X. On the Use of Plug-and-Play Walls (PPW) for Evaluating Thermal Enhancement Technologies for Building Enclosures: Evaluation of a Thin Phase Change Material (PCM) Layer. *Energy and Buildings* **2015**, *86*, 86–92, doi:10.1016/j.enbuild.2014.10.020. 572  
573  
574
84. Vik, T.A.; Madessa, H.B.; Aslaksrud, P.; Folkedal, E.; Øvrevik, O.S. Thermal Performance of an Office Cubicle Integrated with a Bio-Based PCM: Experimental Analyses. *Energy Procedia* **2017**, *111*, 609–618, doi:10.1016/j.egypro.2017.03.223. 575  
576
85. Li, Y.; Darkwa, J.; Kokogiannakis, G.; Su, W. Phase Change Material Blind System for Double Skin Façade Integration: System Development and Thermal Performance Evaluation. *Applied Energy* **2019**, *252*. 577  
578
86. Favier, P.; Zalewski, L.; Lassue, S.; Anwar, S. Designing an Automatic Control System for the Improved Functioning of a Solar Wall with Phase Change Material (PCM). *Open Journal of Energy Efficiency* **2016**, *5*, 19–29, doi:10.4236/ojee.2016.51003. 579  
580
87. Gracia, A. De Dynamic Building Envelope with PCM for Cooling Purposes – Proof of Concept. *Applied Energy* **2019**, *235*, 1245–1253, doi:https://doi.org/10.1016/j.apenergy.2018.11.061. 581  
582
88. Guo, J.; Zou, B.; Wang, Y.; Jiang, Y. Space Heating Performance of Novel Ventilated Mortar Blocks Integrated with Phase Change Material for Floor Heating. *Building and Environment* **2020**, *185*, doi:10.1016/j.buildenv.2020.107175. 583  
584
89. Yan, T.; Gao, J.; Xu, X.; Xu, T.; Ling, Z.; Yu, J. International Journal of Thermal Sciences Dynamic Simplified PCM Models for the Pipe-Encapsulated PCM Wall System for Self-Activated Heat Removal. *International Journal of Thermal Sciences* **2019**, *144*, 27–41, doi:https://doi.org/10.1016/j.ijthermalsci.2019.05.015. 585  
586  
587

- 
90. Qiao, Y.; Cao, T.; Muehlbauer, J.; Hwang, Y.; Radermacher, R. Experimental Study of a Personal Cooling System Integrated with Phase Change Material. *Applied Thermal Engineering* **2020**, *170*, doi:https://doi.org/10.1016/j.applthermaleng.2020.115026. 588  
589
91. Xu, T.; Chiu, J.N.; Palm, B.; Sawalha, S. Experimental Investigation on Cylindrically Macro-Encapsulated Latent Heat Storage for Space Heating Applications. *Energy Conversion and Management* **2019**, *182*, 166–177, doi:10.1016/j.enconman.2018.12.056. 590  
591
92. Saeed, R.M.; Schlegel, J.P.; Sawafta, R.; Kalra, V. Plate Type Heat Exchanger for Thermal Energy Storage and Load Shifting Using Phase Change Material. *Energy Conversion and Management* **2019**, *181*, 120–132, doi:10.1016/j.enconman.2018.12.013. 592  
593
93. Sun, H.; Lin, B.; Lin, Z.; Zhu, Y. Experimental Study on a Novel Flat-Heat-Pipe Heating System Integrated with Phase Change Material and Thermoelectric Unit. *Energy* **2019**, *189*, doi:10.1016/j.energy.2019.116181. 594  
595
94. Sun, X.; Chu, Y.; Medina, M.A.; Mo, Y.; Fan, S.; Liao, S. Experimental Investigations on the Thermal Behavior of Phase Change Material (PCM) in Ventilated Slabs. *Applied Thermal Engineering* **2019**, *148*, 1359–1369, doi:10.1016/j.applthermaleng.2018.12.032. 596  
597  
598
95. Wadhawan, A.; Dhoble, A.S.; Gawande, V.B. Analysis of the Effects of Use of Thermal Energy Storage Device (TESD) in Solar Air Heater. *Alexandria Engineering Journal* **2017**, doi:10.1016/j.aej.2017.03.016. 599  
600
96. Abuşka, M.; Şevik, S.; Kayapınar, A. A Comparative Investigation of the Effect of Honeycomb Core on the Latent Heat Storage with PCM in Solar Air Heater. *Applied Thermal Engineering* **2018**, doi:10.1016/j.applthermaleng.2018.11.056. 601  
602
97. Chen, C.Q.; Diao, Y.H.; Zhao, Y.H.; Wang, Z.Y.; Liang, L.; Wang, T.Y.; Zhu, T.T.; Ma, C. Thermal Performance of a Closed Collector-Storage Solar Air Heating System with Latent Thermal Storage: An Experimental Study. *Energy* **2020**, *202*, doi:10.1016/j.energy.2020.117764. 603  
604  
605
98. Fateh, A.; Klinker, F.; Brütting, M.; Weinsläder, H.; Devia, F. Numerical and Experimental Investigation of an Insulation Layer with Phase Change Materials (PCMs). *Energy and Buildings* **2017**, *153*, 231–240, doi:10.1016/j.enbuild.2017.08.007. 606  
607
99. Evers, A.C.; Medina, M.A.; Fang, Y. Evaluation of the Thermal Performance of Frame Walls Enhanced with Paraffin and Hydrated Salt Phase Change Materials Using a Dynamic Wall Simulator. *Building and Environment* **2010**, *45*, 1762–1768, doi:10.1016/j.buildenv.2010.02.002. 608  
609  
610
100. Rymas, M.; Klugmann-radziemska, E. Possibilities and Benefits of a New Method of Modifying Conventional Building Materials with Phase Change Materials (PCMs). *Construction and Building Materials* **2019**, *211*, 1013–1024, doi:10.1016/j.conbuildmat.2019.03.277. 611  
612  
613
101. Li, C.; Yu, H.; Song, Y.; Tang, Y.; Chen, P.; Hu, H.; Wang, M.; Liu, Z. Experimental Thermal Performance of Wallboard with Hybrid Microencapsulated Phase Change Materials for Building Application. *Journal of Building Engineering* **2019**, *28*, 101051, doi:10.1016/j.jobbe.2019.101051. 614  
615  
616
102. Drissi, S.; Ling, T.; Hung, K. Thermal Performance of a Solar Energy Storage Concrete Panel Incorporating Phase Change Material Aggregates Developed for Thermal Regulation in Buildings. *Renewable Energy* **2020**, *160*, 817–829, doi:10.1016/j.renene.2020.06.076. 617  
618  
619
103. Saxena, R.; Rakshit, D.; Kaushik, S.C. Experimental Assessment of Phase Change Material (PCM) Embedded Bricks for Passive Conditioning in Buildings. *Renewable Energy* **2020**, *149*, 587–599, doi:10.1016/j.renene.2019.12.081. 620  
621
104. Wang, S.M.; Matiašovský, P.; Mihálka, P.; Lai, C.M. Experimental Investigation of the Daily Thermal Performance of a MPCM Honeycomb Wallboard. *Energy and Buildings* **2018**, *159*, 419–425, doi:10.1016/j.enbuild.2017.10.080. 622  
623
105. Li, D.; Wu, Y.; Liu, C.; Zhang, G.; Arıcı, M. Numerical Investigation of Thermal and Optical Performance of Window Units Filled with Nanoparticle Enhanced PCM. *International Journal of Heat and Mass Transfer* **2018**, *125*, 1321–1332, doi:10.1016/j.ijheatmasstransfer.2018.04.152. 624  
625  
626
106. Lee, K.O.; Medina, M.A.; Raith, E.; Sun, X. Assessing the Integration of a Thin Phase Change Material (PCM) Layer in a Residential Building Wall for Heat Transfer Reduction and Management. *Applied Energy* **2014**, doi:10.1016/j.apenergy.2014.09.003. 627  
628  
629

- 
107. Entropy Solutions *PureTemp 20 Technical Information*; Minneapolis, 2020; 630
108. Faraj, K.; Khaled, M.; Faraj, J.; Hachem, F.; Castelain, C. A Review on Phase Change Materials for Thermal Energy Storage in Buildings: Heating and Hybrid Applications. *Journal of Energy Storage* **2020**, doi:10.1016/j.est.2020.101913. 631  
632
109. Young, H.D. Values for Diamond and Silica Aerogel from CRC Handbook of Chemistry and Physics Available online: 633  
<http://hyperphysics.phy-astr.gsu.edu/hbase/Tables/thrcn.html>. 634
110. Thermtest COMMON MATERIAL THERMAL PROPERTIES Available online: <https://thermtest.com/materials-database>. 635
111. Owens-corning Foamular Extruded Polystyrene (XPS) Insulation: SI and IP Units for Selected Properties Available online: 636  
<https://dcpd6wotaa0mb.cloudfront.net/mdms/dms/EIS/10015703/10015703-FOAMULAR-SI-and-I-P-Units-for-Selected-Properties-Tech.-Bulletin.pdf>. 637  
638
112. Hammond, G.; Jones, C. *Inventory of Carbon and Energy*; 2nd ed.; Elsevier, 2011; 639
113. Engineering Toolbox Specific Heat of Some Common Substances Available online: 640  
[https://www.engineeringtoolbox.com/specific-heat-capacity-d\\_391.html](https://www.engineeringtoolbox.com/specific-heat-capacity-d_391.html) (accessed on 30 September 2020). 641
114. Maclean, J.D.; Madison, W. Thermal Conductivity of Wood. *Heating, Piping and Air conditioning* **1941**, *13*, 380–391. 642
115. 3A Composites ALUCOBOND Technical Data Available online: <https://alucobond.com.sg/products/alucobond/technical-data/>. 643  
644
116. Ji, R.; Wei, S.; Xia, Y.; Huang, C.; Huang, Y.; Zhang, H. Enhanced Thermal Performance of Form-Stable Composite Phase- 645  
Change Materials Supported by Novel Porous Carbon Spheres for Thermal Energy Storage. *Journal of Energy Storage* **2020**, 646  
*27*, doi:10.1016/j.est.2019.101134. 647
117. Righetti, G.; Savio, G.; Meneghello, R.; Doretti, L.; Mancin, S. Experimental Study of Phase Change Material (PCM) 648  
Embedded in 3D Periodic Structures Realized via Additive Manufacturing. *International Journal of Thermal Sciences* **2020**, *153*, 649  
doi:10.1016/j.ijthermalsci.2020.106376. 650
118. Lin, Y.; Jia, Y.; Alva, G.; Fang, G. Review on Thermal Conductivity Enhancement, Thermal Properties and Applications of 651  
Phase Change Materials in Thermal Energy Storage. *Renewable and Sustainable Energy Reviews* **2018**, *82*, 2730–2742, 652  
doi:10.1016/j.rser.2017.10.002. 653
119. Vanaga, R.; Blumberga, A.; Freimanis, R.; Mols, T.; Blumberga, D. Solar Facade Module for Nearly Zero Energy Building. 654  
*Energy* **2018**, *157*, 1025–1034, doi:10.1016/j.energy.2018.04.167. 655  
656