



HAL
open science

A New combined transient extraction method coupled with WO₃ gas sensors for polluting gases classification

Khalifa Aguir

► **To cite this version:**

Khalifa Aguir. A New combined transient extraction method coupled with WO₃ gas sensors for polluting gases classification. *Sensor Review*, 2021. hal-03618788

HAL Id: hal-03618788

<https://hal.science/hal-03618788v1>

Submitted on 24 Mar 2022

HAL is a multi-disciplinary open access archive for the deposit and dissemination of scientific research documents, whether they are published or not. The documents may come from teaching and research institutions in France or abroad, or from public or private research centers.

L'archive ouverte pluridisciplinaire **HAL**, est destinée au dépôt et à la diffusion de documents scientifiques de niveau recherche, publiés ou non, émanant des établissements d'enseignement et de recherche français ou étrangers, des laboratoires publics ou privés.



Distributed under a Creative Commons Attribution - NonCommercial 4.0 International License

A New combined transient extraction method coupled with WO₃ gas sensors for polluting gases classification

Abstract

Purpose- this paper dealt with the classification improvement of pollutant using WO₃ gases sensors. To evaluate the discrimination capacity, some experiments were achieved using three gases: ozone, ethanol, acetone and a mixture of ozone and ethanol via four WO₃ sensors.

Design/methodology/approach-To improve the classification accuracy and enhance selectivity, some combined features that were configured through the Principal Component Analysis (PCA) were used. First, evaluate the discrimination capacity; some experiments were performed using three gases: ozone, ethanol, acetone and a mixture of ozone and ethanol, via four WO₃ sensors. To this end, three features that are derivate, integral and the time corresponding to the peak derivate have been extracted from each transient sensor response according to four WO₃ gas sensors used. Then these extracted parameters were used in a combined array.

Findings-The results show that the proposed feature extraction method could extract robust information. The Extreme Learning Machine (ELM) was used to identify the studied gases. In addition, ELM was compared with the Support Vector Machine (SVM). The experimental results prove the superiority of the combined features method in our E-nose application since this method achieves the highest classification rate of 90% using the ELM and 93.03% using the SVM based on Radial Basis Kernel Function SVM-RBF.

Originality/value- combined features have been configured from transient response to improve the classification accuracy. The achieved results show that the proposed feature extraction method could extract robust information. The Extreme Learning Machine ELM and Support Vector Machine SVM were used to identify the studied gases.

Keywords— *Electronic nose, combined features, Gas sensors, ELM classifier, Support Vector Machine SVM*

1. Introduction

Gas sensors based on tungstic oxide (WO₃) have attracted a great deal of research interest in many fields such as environment, control and especially the identification and discrimination of polluting gases. These metal oxide semiconductor (MOX) sensors have many outstanding advantages such as high sensitivity, rapid response speed, good reproducibility and simple design. However, this type of gas sensors exhibits an inherent lack of selectivity. For this reason, investigations have focused on the selective detection for gases using many approaches. Among these approaches, the electronic nose plays a constantly growing role as a general-purpose detector of polluting gases (Lecce, 2009; Machado, 2005). The term electronic nose refers to a device that

emulates human smell by combining sensor response and recognition algorithms to distinguish gas samples (Gardner and Bartlett, 1994; Martin et al., 2001).

In the same way of role of metal oxide in pollution detection, (Danish et al., 2020) discusses the structural features and photocatalytic applications of a variety of metal oxide-based materials. The review paper explores the footprint analysis as well as a simple framework to relate metal oxide application possibilities within energy, environmental, and economic sustainability.

In their research, authors highlight how metal oxide are used in applications for energy and environmental sustainability, taking into account also the limit of their practical application on large scale. WO_3 has the advantage of being chemically stable in acidic aqueous media, having a high hole diffusion length and a good electron mobility. It was reported that metal oxides especially continue to be explored for the environmental remediation, for solving the energy crisis and for decarbonization.

Focusing on the electronic nose performance improvement, many researchers have continuously studied the related technologies to enhance the e-nose performance. In the gas detection field, investigations have focused on the two most important parts of the e-nose system: hardware and software (intelligent) parts. For the first part, sensitive material selection, sensor array optimization was investigated (Zaretskiy et al, 2011). Also, various techniques using different measurement strategies were explored (Ghasemi et al., 2018).

Frequently, investigations have been focused on the use of oxides or polymers to discriminate sensitivity between gases based on molecules size or surface reactions. In (Yumashev and Mikhaylov, 2020), the controlled incorporation of nanoinclusions into the polymer matrix suggests itself as an obvious solution to the tribological problem. Data from numerous tests were processed using the Kalman filter.

It is an effective recursive filter that estimates the state vector of a dynamic system using a series of incomplete and noisy measurements.

For the intelligent part, a great deal of research focused on both of the enhanced feature extraction method and the pattern recognition method.

Among the techniques used to improve the electronic nose system, the hybrid approach known as data fusion has emerged as a real solution to solve the lack of cross-selectivity problem of individual electronic sensor systems. The aim of data fusion is to combine information from two or more data sources in order to obtain more complete, better quality global information, allowing for a better decision and action than either of the individual data sources.

In addition, data fusion techniques are also rated as low (sensors combination), mid (features fusion) and high (classifiers fusion), depending on the processing stage at which the fusion occurred.

In literature, several applications of hybrid systems involve the use of the low level of fusion (Banerjee et al., 2014; Buratti et al., 2018; Haddi et al., 2014). This data fusion corresponds to the fusion of information directly at the output of the sensors. It is a simple concatenation of the raw variable vectors. Although it performs very well when it comes to a comparable number of sensors used for each device, it is not very suitable when the source contains a large number of variables. In addition, the combination of several data raises the problem of dimensionality (Boilot et al., 2004).

The high-level fusion (HLF) relates to the merger of information corresponding to the formulation of hypotheses from an expert or a system. Besides, many studies in such various fields as image segmentation, sensor networks, and image recognition have been devoted to classifier fusion (Amini et al., 2013; Sun et al., 2017; Vergara et al., 2012; Faleh et al., 2018). Indeed, after each source has determined its own decision or partial identity of the present objects, this approach combines the information to form a global decision (Luo et al., 2018)

In this work, we focused on the mid-level fusion (features fusion). It is the fusion of data collected directly from the sensors. The mid-level fusion provides the builder with the possibility of displaying the database size to prevent dimensionality and preponderance problems.

This approach has increasingly gained attention for e-nose applications (Malegoria et al., 2020; Huang et al., 2019).

In our previous paper (Faleh et al., 2016), we used the “classifiers fusion” method to improve the classification accuracy and enhance selectivity. In the present paper, however, we used an alternative method that relies on “features fusion” which is based on transient parameters. The idea was to combine transient features in order to improve the classification accuracy.

The remaining of this paper was structured as follows: Section 2 provided an overview on the “features fusion” approach. Section 3 detailed the measurement process for the sensor array and data collection. In section 4 we described the data preprocessing procedure before discussing the experimental results in section 5. Finally, we drew the main conclusions we reached in this study.

2. Features Fusion approach; State of the art

2.1.Motivation

For any specific application, the extraction method is a key factor for good gas discrimination (Yan et al., 2015; Eklöv et al., 1999). Current features investigated in gas detection can be divided into two main categories: The first is extracted from the steady-state phase whereas the second extracts features related to the transient phase of the sensor response. A recent research identified certain characteristics in the transformation domain, such as Fourier transform (Vergara et al., 2007; Ionescu et al., 2005) trying to reach a high classification rate in order to discriminate samples of gases. Another kind of extraction technique is the extraction of characteristics based on a particular model (Haddad et al., 2007, Chambon et al., 1999). However, other researchers concentrated on extracting piecemeal signal features, such as maximum sensitivity (Xiong et al., 2014).

Throughout the literature, the use of transient features (Siadat et al., 2012; Haddi et al., 2011) has been shown to lead to a better classification. Distant et al. (Distant et al., 2002) analyzed the effect of both steady-state feature maximum value and transient features to detect gases using five SnO₂ sensors. Their results showed that integral and derivative methods have higher recognition rates than accuracy classification obtained from steady state values. In (Zhang et al., 2007), the Linear Discriminant Analysis (LDA) results showed that the higher classification rate was obtained with transient features.

In a previous work, (Faleh et al., 2016) demonstrated that the transient parameters derivate an integral lead to better classification compared to standard features. However, it is well known that a single feature cannot fully represent the characteristics of the sensor signals, thus leading to low classification accuracy. Hence, the features fusion strategy (Giungato et al., 2017) might be a suitable alternative for improving prediction accuracy for gas sensors array. The aim of features

fusion is to combine the parameters obtained from multiple sources and tested individually. This fusion could, therefore, potentially achieve a better definition and improve the classification accuracy (Zhi et al., 2017).

2.2. Methodology

The underlying idea of features combination is to use the extracted features in the same dataset. As shown in figure 1, the mid level of the data fusion corresponds to the mergence of the extracted raw measurements. Unlike the low level of abstraction, the intermediate level requires a preprocessing step of the data before combining them into a single dataset. This can be ensured by either a direct extraction of sensor responses or a selection of variables among those of origin. The mid-level offers the designer the possibility to control the dimension of the database so as to avoid the problems of dimensionality and preponderance.



Figure 1. Mid-level abstraction of data fusion

2.3. Related works

In recent years, the hybrid approach, which is a mid-level features combination, has emerged as a real solution to overcome the problem of lack of cross-selectivity of individual sensors. In addition, the use of multiple data sources offers a compelling path to better decision making. Indeed, data fusion is applied in a wide variety of fields like food security and image processing.

Many researches showed that hybrid systems or features extraction systems can improve the classification accuracy compared to individual features. The combination of heterogeneous features is widely used in the field of food security,. In fact (Haddi et al., 2014) offer a multisensory data fusion approach which combines an e-Nose and an e-Tongue that were investigated in order to generate combined aroma and taste profiles.

Researchers in (Buratti et al., 2018) have shown that classification is often more accurate when using combined features rather than an individual ones. They suggested an efficient mid-level data fusion approach for discussing the applicability of an E-nose, E-eye and E-tongue for quality decline assessment and olive oil characterization, demonstrating their ability to identify samples and substantially improve the K-Nearest Neighbors (KNN) classification model.

Combining correlations between chemical features from an E-nose and E-tongue were explored for discrimination of red wines (Rodriguez-Mendez et al., 2014). Their results showed a significant improvement of classification accuracy. Besides, previous research demonstrated that a weighted fusion framework with a logarithmic form that focused on the contribution of each function can increase the classification rate (Dang et al., 2015). In addition, compared to different standard

techniques, the combined sensor response can classify tea samples more accurately and is considered as an appropriate tool for tea discrimination (Banerjee et al., 2019). Also, and in the same field, a qualitative discrimination, E-nose, E-tongue, E-eye were merged by the SVM and Random Forest RF classification model to obtain a better classification accuracy of black tea and improve the performances of identification and prediction models (Xu et al., 2019). In the field of gas detection and electronic nose, a great deal of research has focused on data fusion, especially features combination, to detect eight gas types that were tested and classified using sensors array (Choi et al., 2016).

2.4. Suggested features combination method

As shown in figure 2, the combined method process is organized as follows: Derivate, integral and time corresponding for the pic derivate parameters is extracted individually from the transient response of sensors constructing hence a data base. A first individual evaluation is achieved. A new data base combines the N observations represented by the variables (D , I , T_{Dmax}). These N observations are the input parameters for such classification methods as the SVM and the ELM.

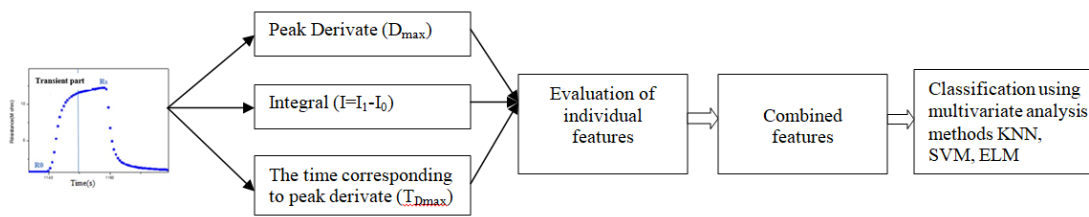

Figure2. Construction process flow of the combined features

3. Materials and methods

3.1. Measurement system

As illustrated in figure 3, the main elements of our test bench are the sensors array, which are fitted in the test chamber, the gas dispensing and mixing system, the polarization electronic circuits, the heating sensors, the measuring devices and the data acquisition system.

To measure almost simultaneously the voltage of each sensor, a data acquisition system that consists of a multimeter (Keithley) controlled by a computer was used. The used gases are ozone, ethanol and acetone. Ozone has been investigated for its oxidation effect. As for ethanol and acetone, they were used as reducing gases. Finally, we investigated a mixture of ozone and ethanol as a separate class.

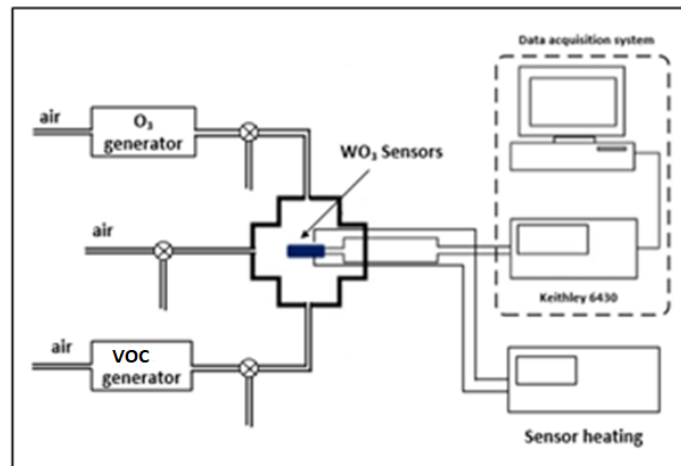

Figure3. Gas measurement experiment set-up for data acquisition

The ozone generation system consists of a flow meter, a humidity filter and a UV lamp. In fact, the dry air passes through a quartz tube, lit by the UV lamp. The concentration of ozone at the outlet of the tube is calculated based on the flow of dry air at the inlet (constant flow equal to 0.5 L / min) and the surface of the tube exposed to UV. A graduated copper tube is used to more or less expose the dry air to the lamp. The graduations on the copper tube correspond to the concentrations 6, 35, 95, 195 and 265 ppb. The ethanol / acetone test bench is mainly composed of a steam generator. It is named VOC generator. It has been always used the same test enclosure and the same acquisition system. The steam / air mixtures can be generated by bubbling air through ethanol / water or acetone / water mixture at 34°C. The alcohol density values are used at 34 ° C , ethanol = 0.77639 g / ml and acetone = 0.7803 g / ml. Thus, for each concentration is corresponding a volume of liquid to introduce into the bubbler. The measured samples were made up of different ozone concentrations 6, 35, 95, 195, 265 ppb, five concentration levels of acetone and ethanol ranging from 10 to 50 ppm and five concentrations of 265 ppm mixture of ozone with a variation of ethanol concentration from 10 to 50 ppm.

The gas sensors are mounted in a box. It is in the shape of a cylindrical cross. The distribution of gas in the enclosure is done by the four channels used for the gas inlets, as well as for making the electrical contacts (heater and electrodes) and for the evacuation of gases. The gas inlets can be used separately in the case where gas is tested or simultaneously to test a mixture of two or more gases. The used chip contains 4 sensors which are tested one by one.

The polarization voltage of the sensors ranges between 0 and 5 V. The sensors are heated at constant temperatures (isothermal mode). Each sensor works at a given temperature as indicated in table 1.

Table1. Sensors characteristics

	Temperature (°C)
Sensor1	275
Sensor2	300
Sensor3	303

For each temperature value corresponds a heating voltage. Indeed, the temperature is not measured each time. The heating furnace is calibrated up to 250°C. It was previously demonstrated that each sensor has an optimal temperature for each gas (Faleh et al.2018).

The sensor heater part is connected in series by a Keithley 2000 multimeter which is used as an ammeter.

A very low voltage U of the order of 0.02 V feeds the heater and enables the resistance of the latter to be measured for each temperature value imposed inside the oven.

It then allows the temperature of the sensitive layer to be identified as a function of the heating voltage applied to the heating element terminals.

The measured data were collected with a laptop via an HP-VEE program. All experiments were performed using four WO_3 gas sensors mounted on the same package (Figure 4). The array consists of a matrix of four sensors in order to have different signatures. In fact, a micro-heater is used in metal oxide gas (MOX) sensors as a hotplate. The gas exposure time (30 s) is long enough to reach the equilibrium state, i.e. to obtain a bearing.

These structures may be used as a base component of an electronic nose, in order to selectively detect a number of target gases. The box contains four micro-sensors.

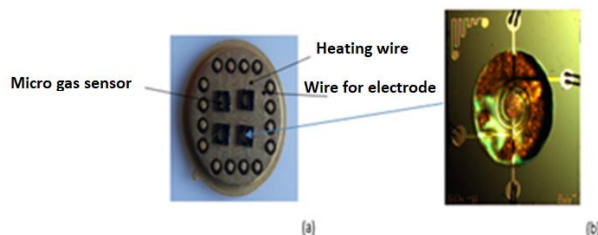

Figure4. (a)Four-element micro gas sensors array mounted on a standard package (b) Presentation of a micro gas sensor

3.2.Sensor characterization

Figure 5 (a) shows the response of the WO_3 gas sensor (sensor1) for ozone (O_3) injections at different concentrations. The gas exposure time is 15 s and the time for return to the baseline is approximately 5 minutes. For the other sensors, similar responses are obtained, except for the resistance ratio value R_s/R_0 that was changed, where R_s is the resistance in the presence of a gas is and R_0 is the reference resistance. The same figure shows that the sensor responds proportionally to the gas concentration, and that it was stable enough during the test. It should be noted that the WO_3 sensor is so sensitive for this gas that it can be a promising oxide for ozone detection even at low concentrations and that the baselines are also stable during the test period.

Figure5 (b) shows the response of a sensor based on WO_3 for ethanol and acetone injections for different concentration levels from 10 to 50 ppm, using the same temperature. The resistance value was decreasing when the ethanol and acetone concentrations were increased. It is noteworthy that resistance increases and exceeds the initial value at the return time to the baseline. This might be

explained by the training of new radicals and the complexity of the chemical reactions during adsorption taking place on the WO_3 surface.

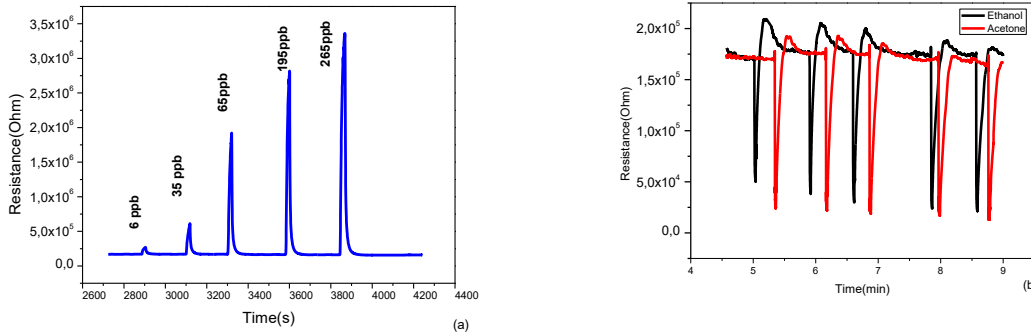

Figure 5. Sensor WO_3 S₁ response to (a) oxidizing gas (O_3), (b) reducing gases ethanol and acetone

In figure 5.b, it is quite noticeable that upon returning to the baseline, the resistance increases and exceeds the value of the baseline. This can be explained by the fact that the new radicals and by the complexity of chemical reactions during adsorption that take place at the surface of WO_3 . By increasing the concentration, this rise disappears. For the extracted parameters, this inconsistency in baseline does not affect any parameter example T_{Dmax} is extracted from derivate not from sensors raw data.

3.3. Signature representation

As mentioned above, our sensors array consists of four WO_3 gas sensors in order to detect different gases simultaneously. The response of the four sensors exposed to a given gas plays an important role in the concept of electronic noses. Figure 6 show that we get a very specific signature for each gas. For the oxidizing gas, we used the ratio R_s/R_0 opposite to the reducing gases for which R_0/R_s ratio was used as a response. The notation S1 to S4 is the same as WO_3 S1 to WO_3 S4. These sensors are different in terms of temperature. Gas sensor data such as resistance is raw data that does not show any trend if viewed separately. This is why the normalized parameter R_s/R_0 has been calculated.

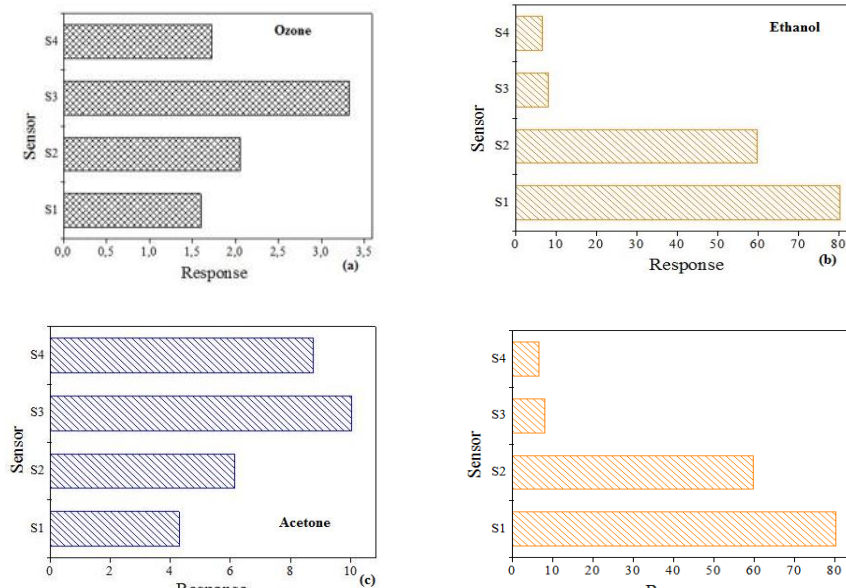

Figure 6. Normalized response of four sensors for (a) 265ppb of ozone (b) 40ppm of ethanol, (c) 40 ppm of acetone, (d) 265ppb of ozone and 40ppm of ethanol.

In our experience, the ozone concentration is set at 265 ppb and the ethanol concentration is varied from 10 to 50 ppm. we find that by increasing the concentration of ethanol, the resistance value decreases. This is explained by the presence of the reducing effect.

4. Signal preprocessing

The pre-processing stage is achieved to pick a set of parameters that identify the sensor array going from feature extraction to dimensionality reduction.

4.1.Extracted features

The optimization process consists in using a satisfactory identification rate while minimizing the number of the initially extracted variables (Boilot et al., 2003).

The aim of this paper was to reach the best accuracy rate through a good exploration of the information of each experiment. To achieve this purpose, three combined transient features in the same dataset were obtained after analyzing each feature independently. For each sensor, three features were extracted (figure 7) whose expressions are shown in table 2.

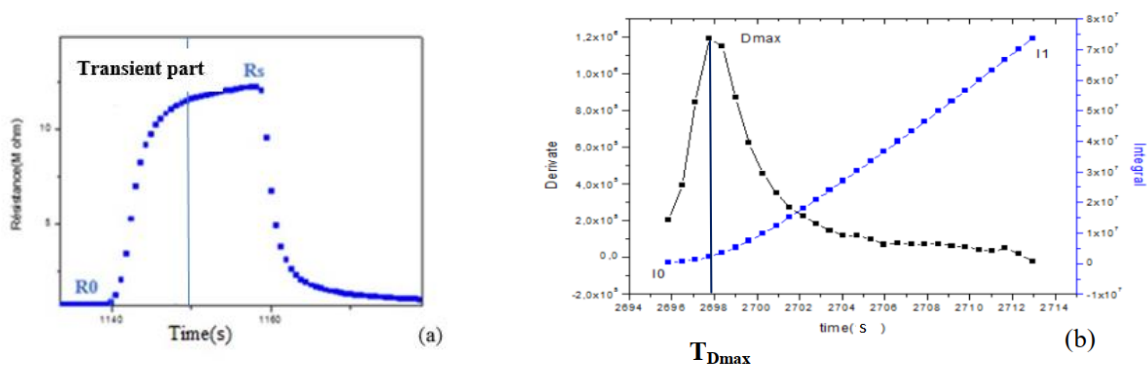

Figure7.a) Characteristic response of a chemical gas sensor showing the transient part b) derivate integral signals and T_{Dmax} measured for each gas sensors

Table2 .Used features extracted from transient sensors curves

feature extraction method	Description
Peak Derivate	The maximum value of derivate calculated by $D(t) = dR(t)/dt$
integral	Calculation of difference accumulative total reaction in the presence of sample gas i.e I1-I0 $I(t) = \int_a^t R(s)ds$ <p>where a: is the beginning of the transient phase, and t: is an any instant in the transient phase</p>
T_{Dmax}	the time corresponding to the peak derivate

Before the classification phase, the data of each sensor using mid-level fusion approach were measured. The significant parameters matrix would be a merge of an individual evaluated parameter: derivate, integral and the time corresponding to peak derivate. The N observations represented by the variables (D, I, T_{Dmax}), collected on the artificial system, would make a database. The merged matrix composed of the derivate, integral and time corresponding for each pic derivate is presented in the following form:

$$T = \begin{bmatrix} D_{t,1}^1 & \dots & D_{t,j}^1 & D_{t,4}^1 & I_{t,1}^1 & \dots & I_{t,j}^1 & I_{t,4}^1 & T_{Dmax,t,1}^1 & \dots & T_{Dmax,t,j}^1 & T_{Dmax,t,4}^1 \\ \vdots & \vdots & \vdots & \vdots & \vdots & \vdots & \vdots & \vdots & \vdots & \vdots & \vdots & \vdots \\ D_{t,1}^c & \dots & D_{t,j}^c & D_{t,4}^c & I_{t,1}^c & \dots & I_{t,j}^c & I_{t,4}^c & T_{Dmax,t,1}^c & \dots & T_{Dmax,t,j}^c & T_{Dmax,t,4}^c \\ \vdots & \ddots & \vdots & \vdots & \vdots & \ddots & \vdots & \vdots & \vdots & \ddots & \vdots & \vdots \\ D_{t,1}^4 & \dots & D_{t,j}^4 & D_{t,4}^4 & I_{t,1}^4 & \dots & I_{t,j}^4 & I_{t,4}^4 & T_{Dmax,t,1}^4 & \dots & T_{Dmax,t,j}^4 & T_{Dmax,t,4}^4 \end{bmatrix}$$

where $D_{tj}^c, I_{tj}^c, T_{Dmax,tj}^c$ represents, respectively, the derivate, integral and the time corresponding to the derivate peak for each sensor j taken by the observation i for the c classes.

j= 1, 2, 3, 4; is the sensor number.

c=1, 2, 3, 4; is the class number, it corresponds to ozone, ethanol, acetone and the mixture ozone and ethanol, respectively.

5. Classification

The multivariate analysis methods serve to construct a data set based on observations of the functioning of the system through learning. Once this step is accomplished, the system is ready to recognize unknown objects that it will receive. There are two main distinct classification approaches applied in sensor array systems; supervised (SVM, KNN, LDA, ANN) and unsupervised (PCA...).

5.1. Support Vector Machine

The Support Vector machine is known to have reached a high classification rate in gas identification (Haddi et al.,2011; Güney and Atasoy,2012). It is a kernel learning method inspired from Vladimir Vapnik's theory introduced in 1979. It was primarily designed for a binary prediction, i.e. discrimination of two classes. However, multi-class versions have been developed in order to consider more complex cases consisting of more than two classes. The SVM Classification can be easily adapted to tackle multiclass problems. The two common strategies are:

One Versus Another method (OVA): This is the simplest and oldest decomposition method where the number of classifiers is selected to be equal to the number of classes.

One Versus One method (OVO): if the class number is k , the classifier number is also designed as $k(k-1)/2$. Each classifier separates the data into two classes. There are different methods of combining the obtained classifiers and the most common is a simple voting scheme.

In this work, we resorted to the SVM classifier especially the One Versus One method (OVO), as it proved to be a good classification method of the three gases.

5.2. Extreme Learning Machine ELM

The ELM is designed to train the Single Layer Feed-forward Networks (SLFNs) (Qiu et al.,2015; Huang et al.,2006; Huang et al.,2011). This method was proven to be extremely simple and efficient and to enjoy a high speed. The weights of the hidden layer can be initialized randomly and analytically determine the output weights of the SLFNs thus urging only the optimization of the weights of the input layer and the biases of the output layer.

After the input weights and the hidden layer biases are chosen arbitrarily, the SLFNs can be simply considered as a linear system and the output weights (linking the hidden layer to the output layer) of the SLFNs can be analytically determined through a simple generalized inverse operation of the hidden layer output matrices.

Assuming that there are N training samples (x_i, t_i) , where $x_i = [x_{i1}, x_{i2}, \dots, x_{in}]^T \in R^n$ denotes one sample point in the n -dimensional space, $t_i = [t_{i1}, t_{i2}, \dots, t_{in}]^T \in R^m$ is the sample class label and the number of hidden nodes is M .

The SLFN output and the activation function are defined as:

$$o_i = \sum_{j=1}^M \beta_j g_j(x_i) = \sum_{j=1}^M \beta_j g(w_j x_i + b_j) , \quad (1)$$

where $W_j = [w_{j1}, w_{j2}, \dots, w_{jn}]^T$, $\beta_i = [\beta_{i1}, \beta_{i2}, \dots, \beta_{im}]^T$, $j=1, \dots, M$

with x_i is the i -th sample, M is the number of hidden nodes; w_j and b_j denote the input weights of the hidden layer and the output weight linking the j -th hidden node to the output layer, respectively. Meanwhile, b_j is a bias of the j -th hidden node and o_i is the output vector of the input sample x_i .

This SLFN can approximate those N samples with zero error, which means that:

$$\sum_{i=0}^M \|o_i - t_i\| = 0, \quad (2)$$

Where t_i is the sample class label vector of the input sample x_i . Based on this approximation, the parameters vectors β_j , w and b_j can be written as follows:

$$\sum_{j=1}^M \beta_j g(w_j x_i + b_j) = t_i \quad (3)$$

This can be written as:

$$\begin{pmatrix} g(w_1 x_1 + b_1) & \cdots & g(w_M x_1 + b_M) \\ \vdots & \ddots & \vdots \\ g(w_1 x_N + b_1) & \cdots & g(w_M x_N + b_M) \end{pmatrix} \begin{pmatrix} \beta_1^T \\ \vdots \\ \beta_M^T \end{pmatrix}_{M,m} = \begin{pmatrix} t_1^T \\ \vdots \\ t_M^T \end{pmatrix}_{N,n} \quad (4)$$

Equation (4) may then also be written in a matrix form:

$$H\beta = T \quad (5)$$

Where H is the hidden layer output matrix and it is written as:

$$H = \begin{bmatrix} h(x_1) \\ h(x_N) \end{bmatrix} = \begin{pmatrix} g(w_1 x_1 + b_1) & \cdots & g(w_M x_1 + b_M) \\ \vdots & \ddots & \vdots \\ g(w_1 x_N + b_1) & \cdots & g(w_M x_N + b_M) \end{pmatrix} \quad (6)$$

To train the SLFN is equivalent to find a least squares solution of the linear system. The least-square solution takes the following form:

$$\beta' = H^+ T, \quad (7)$$

where H^+ is the Moore-Penrose generalized inverse of the matrix.

To calculate the output weights, Huang et al. suggested adding a positive value $1/C$ (C is a regularization coefficient). According to the ridge regression theory, it is calculated as follows:

$$\beta = H^T \left(\frac{1}{C} + HH^T \right)^{-1} T \quad (8)$$

The SLFN output function is:

$$f(x_i) = h(x_i) \beta, \quad (9)$$

where $h(x_i)$ is the output of the hidden nodes and actually maps the data from input space to the hidden layer feature space H .

Therefore, substituting Equation (8) for Equation (9) will describe the output function as follows:

$$f(x_i) = \begin{bmatrix} h(x_i) & h(x_1)^T \\ h(x_i) & h(x_N)^T \end{bmatrix} \left(\frac{1}{C} HH^T \right)^{-1} T \quad (10)$$

While the discrimination power of each feature was tested using PCA, the ELM and SVM classifiers were applied to complete the classification process. The Matlab software was used for the data analysis.

6. Results and discussion

The PCA was used for data preprocessing and dimensionality reduction. The e-nose dataset was projected in a low dimensional space. This was achieved by computing the orthogonal and uncorrelated variables of the covariance matrix from the features of the sensors' response. The two first principal components were used based on their greatest amount of variance.

From each sensor response curve, three different transient features were extracted for each sample. The first feature extraction is the peak derivate from the transient part. The second feature extraction presents the difference accumulative total reaction in the presence of sample gas, i.e., I1–I0. The last one is the time corresponding of the peak derivate.

Each data set extracted from each proposed feature in the form of $X_{20 \times 4}$ was introduced into the PCA process. A mean-centering pre-processing technique was applied to the datasets. The PCA results of the data sets were extracted by the proposed method.

The peak derivate, integral, and time corresponding to the peak derivate and the combination of the three features are shown in Figure8 a–d, respectively.

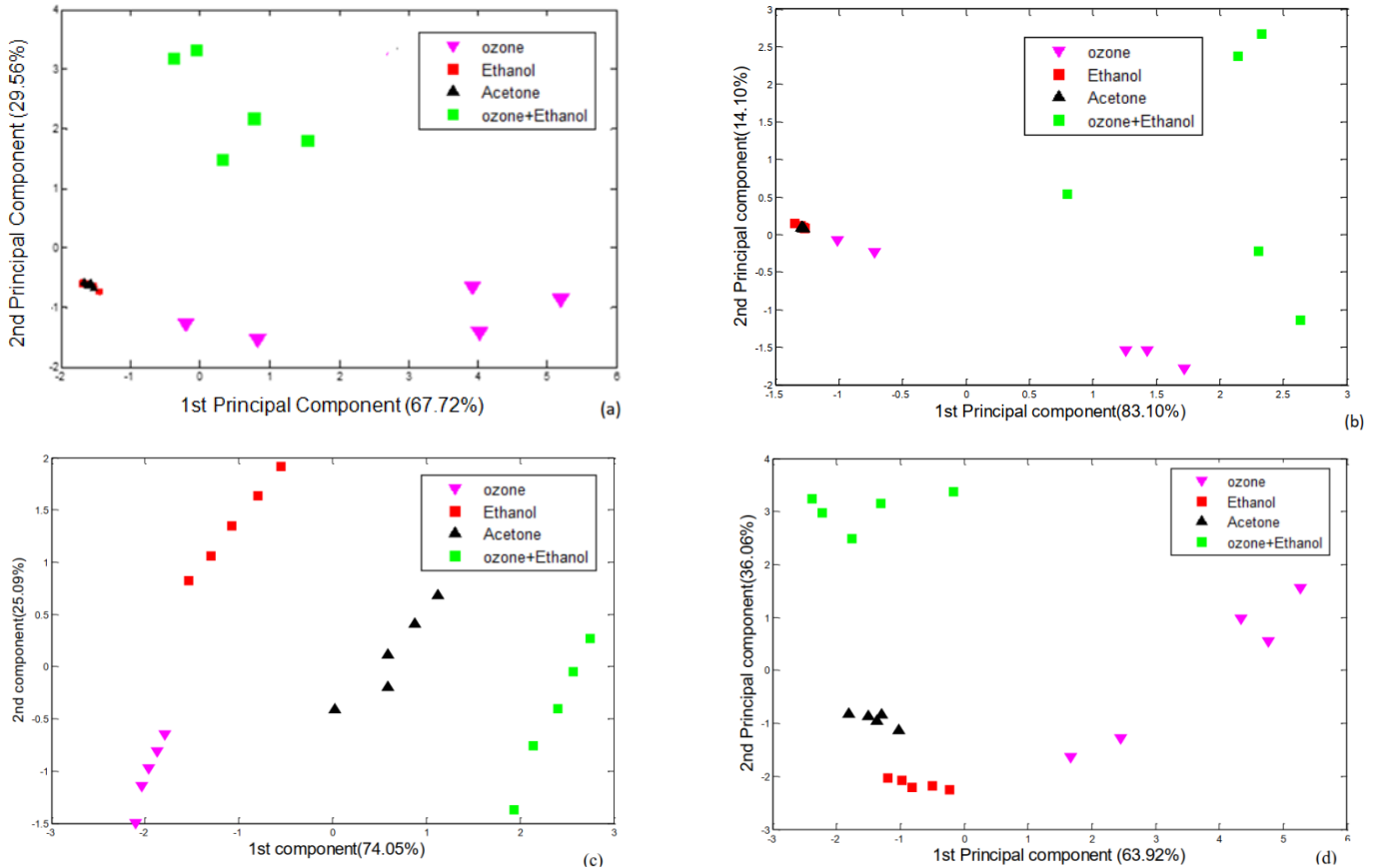

Figure 8.PCA discrimination (a) using derivate parameter (b) integral parameter(c) time corresponding to the derivate pic (d) using the three combined parameters

The PCA results show that the feature extraction based on the peak derivate and integral cannot classify and discriminate between ethanol and acetone. The Time corresponding to the peak derivate seems to give a better result than derivate and integral. However, the linearity of the samples classification does not seem to lead to a better classification rate since it is not enough to guarantee the best classification accuracy. (Faleh et al., 2016) proved that combining derivate and integral leads to a better classification rate compared to standard features. For the feature extraction using the integral, peak derivate and the time corresponding to the peak derivate, the PCA results show a perfect classification between the four classes and the problem of discrimination between the two reducing gases ethanol and acetone has been overcome. The best classification scenario can be observed from the plot and each gas is widely separated from the others.

The classification and validation of the combined transient features method PCA were performed to explore the pollutant gases ozone, ethanol, acetone and a mixture of ozone and ethanol. However, this qualitative method cannot be used as an identification method. In this way, the ELM and SVM models were used to evaluate the effectiveness of the transient extracted features. Leave-one-out cross validation method was employed to evaluate the performances of the used methods in this experiment for the data set.

The main idea underlying the ELM is that the network hidden layer parameters were randomly assigned. The only parameter is the number of hidden nodes in the SLFN hidden layer, which is normally obtained by a trial. While the input weights are within $(-1, 1)$, those of the hidden layer biases are within $(0, 1)$. According to the number of hidden nodes in the hidden layer, 20 experiments were carried out

Figure 9 shows only the classification results of one of the 20 repeated experiments to display the change process with the number of hidden nodes in the hidden layer varying from 1 to 20. It can be clearly seen that the classification rate gradually improved with the number of hidden nodes from 4 to 6 and from 17 to 18, while the classification rate gradually declined with the number of hidden nodes from 7 to 16. Moreover, the best classification accuracy the ELM can achieve is 85% when the number of hidden nodes is 4, 6.

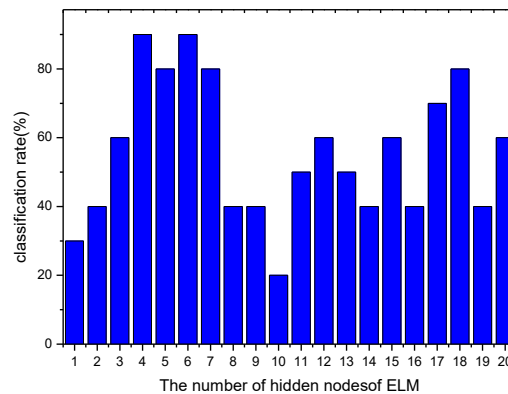

Figure9. Performance of ELM using combined features according to the number of hidden nodes from 1 to 20.

Table 3 shows that both different features and classification models impact the classification accuracy of the four gas classes. It also proves that the combined features method outperforms the classification accuracy of the studied classes.

This very same table displays that regardless of the used classification method, the combined features present the highest accuracy compared to individual transient features.

Using the peak derivate, integral and time of peak derivate, the SVM classification accuracy was better than that achieved when using the polynomial kernel. However, using the combined features, the best accuracy rate was obtained using the RBF Kernel method. For the ELM classification, the best classification depends on the hidden nodes number that is 20 in our case. When combining transient features, the ELM and SVM classifiers provided very satisfactory results for the gas classification.

The following remarks can be therefore forwarded: the first is that using combined transient features yields a better classification rate than individual features. The second is that the SVM classifier implementation with a selection of a kernel function leads to a better discrimination capability than the ELM classifier. In this context, we are thinking that optimizing this classifier would be an interesting future perspective.

Table 3. Classification results

Features	Method	Parameters	Classification rate
Peak derivate	ELM	Activation function: RBF Hidden nodes=20	76,5%
	SVM	Polynomial Kernel, $p=2$, $C=1$	85,83
Integral	ELM	Activation function: RBF Hidden nodes=20	75%
	SVM	RBF kernel, $\sigma =0,2$	90,41
Time of peak derivate	ELM	Activation function: RBF Hidden nodes=20	80%
	SVM	Polynomial Kernel, $p=2$, $C=1$	92,97%
Combined features	ELM	Activation function: RBF Hidden nodes=20	90%
	SVM	RBF kernel, $\sigma =0,2$	93,03%

7. Conclusion

The aim of this work was to improve the performance of the existing electronic nose by exploiting three new transient features combined in the same matrix. Initially, samples from the data set were introduced in the PCA algorithm to analyze the ability of the sensors array to discriminate the three gases and a mixture of two gases. This does illustrate that the system was able to discriminate the samples. To improve the classification accuracy, we resorted to another classification algorithm namely the SVM classifier and the ELM algorithm. As a future perspective, we are planning to improve the ELM algorithm by using the kernel ELM (K-ELM) and PSO optimization.

References

- Amini, A., Bagheri M. and Montazer, G.A. (2013),” Improving gas identification accuracy of a temperature modulated gas sensor using an ensemble of classifiers”, *Sensors and Actuators B*,Vol.187, pp. 241-246
- Banerjee, M.B., Roy, R.B., Tudu, B., Bandyopadhyay, R. and Bhattacharyya,N. (2019), " Black tea classification employing feature fusion of E-Nose and E-Tongue responses", *Journal of Food Engineering*, Vol.244, pp.55-63,doi: 10.1016/j.jfoodeng.2018.09.022
- Banerjee, R., Chattopadhyay, P., Tudu, B., Bhattacharyya, N. and Bandyopadhyay, R. (2014), “Artificial flavor perception of black tea using fusion of electronic nose and tongue response: A Bayesian statistical approach”, *Journal of Food Engineering*,Vol.142,pp.87-93
- Boilot, P., Hines, E.L., Gongora, M. and Folland, R.S. (2003), "Electronic noses inter comparison, data fusion and sensor selection in discrimination of standard fruit solutions", *Sensors and Actuators B*, Vol.88, pp. 80–88,doi: 10.1016/S0925-4005(02)00313-1
- Buratti, S., Malegorib, C., Benedetti, S., Oliveri, P. and Giovanelli, G. (2018),” E-nose, e-tongue and e eye for edible olive oil characterization and shelf life assessment: a powerful data fusion approach”,*Talanta journal*,Vol.182,pp.131-141
- Chambon, L., Germain, J. P., Pauly, A., Demarne,V. and Grisel, A. (1999),"A metallic oxide gas sensor array for a selective detection of the CO and NH₃ gases", *Sensors Actuators B*, Vol. 60, pp. 138–147,doi: 10.1016/S0925-4005(99)00259-2
- Cho, J.H. and Kurup, P.U. (2011), "Decision tree approach for classification and dimensionality reduction of electronic nose data" *Sensors and Actuators B: Chemical*, Vol.160, pp.542–548, doi:10.1016/j.snb.2011.08.027
- Choi, S., Eom, T. and Jeong, G.M. (2016), "Gas Classification Using Combined Features Based On a Discriminant Analysis for an Electronic Nose", *Journal of Sensors*, Vol. 2016, pp 1-9,doi: 10.1155/2016/9634387

Dang, L., Tian, F., Zhang, L., Kadri, C., Yin, X., Peng, X. and Liu, S. (2015), "A novel classifier ensemble for recognition of multiple indoor air contaminants by an electronic nose", *Sensors and Actuators A: Physical*, Vol. 207, pp. 67–74.

Danish, M.S.S., Bhattacharya, A., Stepanova, D., Mikhaylov, A., Grilli, M.L., Khosravy, M., Sengyu, T. (2020). "A Systematic Review of Metal Oxide Applications for Energy and Environmental Sustainability". *Metals*, 10(12), 1604.

Distante, C., Leo, M., Siciliano, P. and Persaud, K. (2002), "On the study of feature extraction methods for an electronic nose", *Sensors and Actuators B: Chemical*, Vol. 87, pp.274–288, doi: 10.1016/S0925-4005(02)00247-2

Eklöv, T., Mårtensson, P. and Lundström, I. (1999), "Selection of variables for interpreting multivariate gas sensor data", *Anal. Chim. Acta*, Vol. 381, pp. 221–232 doi:10.1016/S0003-2670(98)00739-9,

Faleh, R., Gomri, S., Othman, M., Aguir, K. and Kachouri, A. (2017), "Enhancing WO₃ gas sensor selectivity using a set of pollutant detection classifiers", *Sensor Review journal*, Vol. 38 No. 1, pp. 65-73. <https://doi.org/10.1108/SR-12-2016-0273>

Faleh, R., Othman, M., Gomri, S., Aguir, K. and Kachouri, A. (2016), "A transient signal extraction method of WO₃ gas sensors array to identify pollutant gases", *IEEE Sensors Journal*, Vol. 16 No. 9, pp. 3123-3130, doi: 10.1109/JSEN.2016.2521578

Gardner, J.W and Bartlett, P.N. (1994), "A brief history of electronic noses", *Sensors Actuators B Chemical*, vol. 18, no. 1–3, pp. 210–211, doi: 10.1016/0925-4005(94)87085-3

Ghasemi, M., Mohtasebi, S., Siadat, M., Ahmadi, H. and Ravazi, S. (2015) "From simple classification methods to machine learning for the binary discrimination of beers using electronic nose data", *Engineering in Agriculture. Environment Food*, Vol.8, pp.44–51 10.1016/j.eaef.2014.07.002, doi:

Ghasemi, M., Tohidi, M., Mishra, M., Izadi, Z. (2018), "Temperature modulation of electronic nose combined with multi-class support vector machine classification for identifying export caraway cultivars", *Postharvest Biology and Technology*, Vol.138, pp. 134-139

Giungato, P., Laiola, E. and Nicolardi, V. (2017), "Evaluation of Industrial Roasting Degree of Coffee Beans by Using an Electronic Nose and a Stepwise Backward Selection of Predictors", *Food Analysis Method*, Vol. 10, pp.3424–3433.

Güney, S. and Atasoy, A. (2012), "Multiclass classification of n-butanol concentrations with k-nearest neighbor algorithm and support vector machine in an electronic nose", *Sensors and Actuators B: Chemical*, Vol.166, pp.721–725, doi: 10.1016/j.snb.2012.03.047

Haddad, R., Carmel, L. and Harel, D. (2007), "A feature extraction algorithm for multi-peak signals in electronic noses", *Sensors Actuators B: Chemical*, Vol. 120, pp. 467–472, doi: 10.1016/j.snb.2006.02.048

Haddi, Z., Amari, A., Alami, H., El Bari, N., Llobet, N. and Bouchikhi, B. (2014), "A portable electronic nose system for the identification of cannabis-based drugs", *Sensors Actuators B: Chemical*, vol. 155, pp. 456–463,doi: 10.1016/j.snb.2010.12.047

Haddi, Z., Mabrouk, S., Bougrini, M., Tahri, K., Sghaier, k., Barhoumi, H., ElBari, N., Maaref, A., Jaffrezic, N.and Bouchikhi, B. (2014), "E-Nose and e-Tongue combination for improved recognition of fruit juice samples", *Food chemistry journal*, Vol. 150, pp. 246–253, doi:10.1016/j.foodchem.2013.10.105

Huang, G., Wang, D.and Lan, Y. (2011), "Extreme learning machines: A survey ". *Int. J. Mach. Learn. Cybern.* ,Vol.2, pp.107–122

Huang, G., Zhu, Q. and Siew, C. (2004)," Extreme learning machine: A new learning scheme of feed forward neural networks ",*Proc. IEEE Int. jt. Conf. Neural Network*, pp.985–990, 10.1109/IJCNN.2004.1380068

Huang, G., Zhu, Q., Siew, C. (2006),"Extreme learning machine: Theory and applications", *Neurocomputing journal*, Vol.70, pp.489–501,doi: 10.1016/j.neucom.2005.12.126

Huang, L., He, A., Wang, M., Bai, R. and Nie, X. (2019)," A Multi-Feature Fusion Based on Transfer Learning for Chicken Embryo Eggs Classification", *Symmetry journal*,Vol 11,pp.1-16

Ionescu, R., Hoel, A., Granqvist, C.G., Llobet, E. and Heszler, P. (2005), "Low-level detection of ethanol and H₂S with temperature-modulated WO₃ nanoparticle gas sensors," *Sensors Actuators B: Chemical*, Vol. 104, pp. 132–139,doi: 10.1016/j.snb.2004.05.015

Lecce, V., Amato, A., Martines, C., Bari, P. and Dario, R. (2009), "Air quality control for health care centres. The application of an intelligent distributed system", *2009 IEEE Workshop on Environmental, Energy, and Structural Monitoring Systems*, pp. 27–30,doi: 10.1109/EESMS.2009.5341321

Luo, H., Jia, P., Qiao, S. and Duan, S. (2018)," Enhancing electronic nose performance based on a novel QPSO-RBM technique", *Sensors and Actuators B*,Vol.256,pp. 241–249

Machado, R. F. , Laskowski, D. , Deffenderfer, O. , Burch, T. , Zheng, S. , Mazzone, P. J. , Mekhail, T. , Jennings, C. , Stoller, J. K. , Pyle, J. , Duncan, J. , Dweik, R. A. and Erzurum, S. C. (2005), "Detection of Lung Cancer by Sensor Array Analyses of Exhaled Breath", *Am. J. Respir. Crit. Care Med.*, Vol. 171, no. 11, pp. 1286–1291, doi:10.1164/rccm.200409-1184OC

Malegoria, C., Burattib, S., Benedettib, S., Oliveria, P., Rattib, S., Cappab, C. and Lucisanob, M.(2020)," A modified mid-level data fusion approach on electronic nose and FT-NIR data for evaluating the effect of different storage conditions on rice germ shelf life", *Talanta*,Vol.206,pp. 120-208

Martin, Y., Oliveros, M., Pavon, J. L., Pinto, C. and Cordero, B. (2001), "Electronic nose based on metal oxide semiconductor sensors and pattern recognition techniques: characterization of vegetable oils" *Analytica Chimica Acta Journal*, Vol. 449, no. 1–2, pp. 69–80,doi: 10.1016/S0003-2670(01)01355-1

Qiu, S., Gao, L. and Wang, J. (2015), "Classification and regression of ELM, LVQ and SVM for E-nose data of strawberry juice", *J. Food Engineering*, Vol.144, pp.77–85, 10.1016/j.jfoodeng.2014.07.015

Qiu, S., Wang, J. and Gao, L. (2014), "Discrimination and characterization of strawberry juice based on electronic nose and tongue: Comparison of different juice processing approaches by LDA, PLSR, RF, and SVM". *J. Agric. Food Chem.*, Vol.62, pp.6426–6434, doi:10.1021/jf501468b

Rodriguez-Mendez, M.L., Apetrei, C., Gay, M., Medina-Plaza, C., De Saja, J.A., Vidal, S., Aagaard, O., Ugliano, M., Wirth, J. and Cheynier, V. (2014), "Evaluation of Oxygen Exposure Levels and Polyphenolic Content of Red Wines Using an Electronic Panel Formed by an Electronic Nose and an Electronic Tongue", *Food Chemistry*, Vol.155, pp. 91–97

Saraoglu, H.M., Selvi, A.O. and Ebeoglu, M.A. (2013), "Electronic nose system based on quartz crystal microbalance sensor for blood glucose and HbA1c levels from exhaled breath odor". *IEEE Sensor Journal*, Vol.13, pp.4229–4235,doi: 10.1109/JSEN.2013.2265233

Siadat, M., Sambemana, H. and Lumbreras, M. (2012), "Procedia Engineering New transient feature for metal oxide gas sensor response processing", *Procedia Engineering*, Vol. 47, pp. 52–55,doi: 10.1016/j.proeng.2012.09.082

Sun, X., Liu, L., Wang, Z., Miao, J., Wang, Y., Luo, Z. and Li, G. (2017), "An optimized multi-classifiers ensemble learning for identification of ginsengs based on electronic nose", *Sensors and Actuators A*, Vol.266,pp.135-144

Tian, X., Wang, J. and Cui, S. (2013), "Analysis of pork adulteration in minced mutton using electronic nose of metal oxide", *sensors. J. Food Eng.*, Vol.119, pp.744–749, 10.1016/j.jfoodeng.2013.07.004

Vergara, A., Vembu, S., Ayhan, T., Ryan, M., Homer, M. and Huerta, M. (2012), "Chemical gas sensor drift compensation using classifier ensembles", *Sensors and Actuators B*, Vol.166,pp. 320–329

Vergara, A., Llobet, E., Brezmes, J., Ivanov, P., Cané, C., Gràcia, I., Vilanova, X., and Correig, X. (2007), "Quantitative gas mixture analysis using temperature-modulated micro-hotplate gas sensors: Selection and validation of the optimal modulating frequencies", *Sensors Actuators, B: Chemical*, vol. 123, pp. 1002–1016,doi: 10.1016/j.snb.2006.11.010

Westenbrink, E., Arasaradnam, R.P., O'Connell, N., Bailey, C., Nwokolo, C., Bardhan, K.D. and Covington, J.A. (2015), "Development and application of a new electronic nose instrument for the detection of colorectal cancer", *Biosens. Bioelectron.*, Vol 67, pp.733–738,doi: 10.1016/j.bios.2014.10.044.

Xiong, Y., Xiao, X., Yang, X., Yan, D., Zhang, C., Zou, H., Lin, H., Peng, L., Xiao, X. and Yan, Y. (2014), "Quality control of *Lonicera japonica* stored for different months by electronic nose", *J. Pharm. Biomed.*, Vol91, pp.68–72,doi: 10.1016/j.jpba.2013.12.016

Xu, M., Wang, J. and Zhu, L. (2019), "The qualitative and quantitative assessment of tea quality based on E-nose, Etongue and E-eye combined with chemometrics", *Food chemistry Journal*, Vol.289, pp. 482-489, doi:10.1016/j.foodchem.2019.03.080

Yan, J., Guo, X., Duan, S., Jia, P., Wang, L., Peng, C. and Zhang, S. (2015), "Electronic Nose Feature Extraction Methods: A Review ", *Sensors journal*, Vol.15, pp.27804-27831; doi:10.3390/s151127804

Yumashev, A and Mikhaylov, A. (2020) Development of Polymer Film Coatings with High Adhesion to Steel Alloys and High Wear Resistance. *Polymer Composites*, 41(7), 2875-2880. <https://doi.org/10.1002/pc.25583>

Zaretskiy, N., Menshikov, L., Vasiliev, A. (2011), " Theory of gas sensitivity of nano-structured MOX layers. Selection rules for gas sensitive materials", *Procedia Engineering*, Vol. 25, pp.268-271

Zhang, L., Tian, F., Liu, S., Guo, J., Hu, B. and Ye, Q. (2013), "Chaos based neural network optimization for concentration estimation of indoor air contaminants by an electronic nose", *Sensors and Actuators A:Physical*, Vol 189, pp.161–167, doi: 10.1016/j.sna.2012.10.023

Zhang, S., Xie, C., Zeng, D., Zhang, Q., Li, H. and Bi, Z. (2007), " A feature extraction method and a sampling system for fast recognition of flammable liquids with a portable E-nose", *Sensors and Actuators B: Chemical*, Vol 124, pp.437–443, doi: 10.1016/j.snb.2007.01.013

Zhi, R., Zhao, L. and Zhang, D. (2017), " A Framework for the Multi-Level Fusion of Electronic Nose and Electronic Tongue for Tea Quality Assessment", *Sensors*, Vol. 17, pp.1007