



HAL
open science

Polylactones synthesis by enzymatic ring opening polymerization in flow

Christian Rolando, Wissal Adhami, Youssef Bakkour

► **To cite this version:**

Christian Rolando, Wissal Adhami, Youssef Bakkour. Polylactones synthesis by enzymatic ring opening polymerization in flow. *Polymer*, 2021, 230, pp.124040. 10.1016/j.polymer.2021.124040 . hal-03614553

HAL Id: hal-03614553

<https://hal.science/hal-03614553v1>

Submitted on 2 Aug 2023

HAL is a multi-disciplinary open access archive for the deposit and dissemination of scientific research documents, whether they are published or not. The documents may come from teaching and research institutions in France or abroad, or from public or private research centers.

L'archive ouverte pluridisciplinaire **HAL**, est destinée au dépôt et à la diffusion de documents scientifiques de niveau recherche, publiés ou non, émanant des établissements d'enseignement et de recherche français ou étrangers, des laboratoires publics ou privés.



Distributed under a Creative Commons Attribution - NonCommercial 4.0 International License

1 Polylactones synthesis by enzymatic ring opening 2 polymerization in flow

3

4 Wissal ADHAMI^{a,b}, Youssef BAKKOUR^b and Christian ROLANDO^{a,c,*}5 ^a Univ. Lille, CNRS, USR 3290, MSAP, Miniaturisation pour la Synthèse l'Analyse et
6 la Protéomique, F-59 000 Lille, France7 ^b Laboratoire de Chimie Appliquée, Faculté des Sciences III, Université Libanaise,
8 Ras Maska, Campus Mont Michel, Tripoli, Lebanon9 ^c Shrieking Sixties, 1-3 Allée Lavoisier, 59650 Villeneuve-d'Ascq, France

10 Corresponding author's email : christian.rolando@univ-lille.fr

11

12 **Abstract** Polycondensation in batch is the classical way to produce polyesters.
13 However, this method requires harsh conditions to reach high conversions and drive
14 the equilibrium of the reaction forward. In order to produce controlled polymers in a
15 greener way, we worked on the enzymatic ring opening polymerization (e-ROP) of
16 lactones using the CALB lipase immobilized on porous beads (Novozym® 435) as a
17 catalyst and 3-phenyl-1-propanol (PP) as initiator in a flow tubular reactor made of
18 fluorinated ethylene propylene (FEP) tubing with $i.d = 1.55$ mm. In a short residence
19 time of 214 s ϵ -caprolactone (CL) was fully polymerized (conv = 100%) with a fair
20 dispersity ($\mathcal{D} = 1.30$). Polymerization of δ -valerolactone (VL) (conv = 93%, $\mathcal{D} = 1.27$)
21 as well as copolymerization of CL and VL mixtures (conv up to 88%, $\mathcal{D} = 1.24$)
22 behaved similarly. By alternating the lactones, a block-polymer was obtained. As
23 expected, primary alcohols were more efficient than secondary ones for initiating the
24 e-ROP of lactones. Very interestingly, using cholesterol as initiator induced the
25 formation of cyclic polylactones only. In addition, we showed the importance of the
26 residence time as at a long time the formed polymer was depolymerized by the
27 enzyme. We demonstrated also that the enzyme may be reused more than ten times
28 with maintaining its high efficiency. The whole study shows that the use of tubular
29 reactor for performing e-ROP improves its control as shown by the low \mathcal{D} values and
30 decreases the residence time needed to reach high conversions compared to similar
31 reactions in batch.

32

33 **Key Words**34 *Enzymatic Ring Opening Polymerization (e-ROP), Flow system, Polylactones, Novozym® 435*

35 **I Introduction**

36 The importance of polyesters comes from their wide uses in our daily life. Polyesters are
37 non-toxic and biocompatible which explains their use in both medical and
38 pharmaceutical fields [1]. Ring Opening Polymerization (ROP) is mainly used to
39 produce polyesters from the corresponding cyclic monomers [2]. Many metal based
40 catalysts are used in polyesters synthesis: Aluminium [3, 4], Zinc [5, 6] and Tin [7, 8].
41 Among these catalysts, Tin(II)octanoate is the most commonly used. Poly (ϵ -
42 caprolactone) (PCL) was successfully synthesized in flow using FTEP tubes with metal
43 based catalyst $\text{Sn}(\text{OTf})_2$. The reaction time was enough to reach high conversions and
44 good molecular weight dispersitys of polymers under controlled reactions [9]. In
45 addition, they used an initiator which contains hydroxyl and thiol functions. It conserved
46 the thiol-end fidelity after the chemoselective polymerization towards alcohol [10].
47 However, metal based catalysts are not safe in catalyzing the synthesis of
48 biodegradable polyesters destined for biomedical use [1, 11].

49 Green chemistry has now become a very attractive field. It represents a new point of
50 view in chemistry, promoting the use of green starting materials, solvents and process
51 that respect the environment and afford products which are not damaging our
52 environment [12]. In this paper, we focused on green synthesis of macromolecules.
53 Enzymes; performing clean reactions with no side products and providing high
54 selectivity with respect to enantio-, regio- and chemo-selectivities are the archetype of
55 green catalysts. No conventional catalytic system affords such a degree of selectivity. In
56 addition, enzymes are natural, renewable and nontoxic. Furthermore, enzymes are
57 recyclable which allows their reuse multiple times [13-16]. The traceless green solvent,
58 supercritical carbon dioxide (scCO_2) can be used for promoting enzymatic
59 polymerization [17]. Lipases are a class of enzymes which hydrolyse fatty acide esters
60 and they are the most commonly used in enzymatic polymerization [15, 16]. Novozym
61 435® from Novochem is a lipase B (CALB) immobilized on an acrylic resin which is
62 commercially available [18]. Novozym 435® has been found the most effective enzyme
63 to promote the ring opening polymerization of lactones [19].

64 Flow microreactors allow high performance organic syntheses. High surface to volume
65 ratio of microreactors, short diffusion paths and more efficient heat and mass transfer
66 compared with conventional platforms explain these improved performances [20-23].
67 The reaction parameters are easily controlled. For example, the reaction time is
68 adjusted by the simple variation of the flow rate or of the microchannel length. Polymer
69 synthesis has also been developed in continuous flow microreactors [24, 25]. In a
70 seminal work, Gross and Beers employed immobilized enzyme in continuous flow
71 system to achieve ϵ -caprolactone (CL) ring opening polymerization in toluene [26]. The
72 polymerization took place in an Aluminium microchannel reactor coated with Kapton®
73 film. In comparison with batch system, they obtained a higher number-average
74 molecular weight (M_n) of PCL in less reaction time proving the advantages of using
75 N435® beads in a microreactor to catalyze the ROP of CL. Neither conversion nor
76 chemoselectivity are affected when using toluene saturated with water [27]. These
77 works have paved the way to several poly lactones synthesis in micro-flow system [28-
78 30]. In addition, Zhu et al. examined the chemoselectivity towards hydroxyl versus thiol
79 functions via enzymatic ring opening polymerization of δ -valerolactone (VL) in flow
80 mode as well as its copolymerization where they obtained interesting results compared
81 to the batch [31].
82 In order to develop a green polyester synthesis, we combined the advantages of micro-
83 flow system, ROP and green catalyst using a homemade setup easily built in any
84 laboratory. CL and VL poly lactones were synthesized as well as their copolymers via
85 enzymatic ring opening. A comprehensive study of the parameters (initiators, flow rate,
86 temperature and reaction time) of each reaction was performed. In this study, we were
87 able to show the special behavior of cholesterol affording cyclic polyesters. The formed
88 polymers were characterized by ^1H nuclear magnetic resonance spectroscopy (NMR),
89 mass spectrometry (MS) and gel permeation chromatography (GPC). Furthermore we
90 studied the degradation of the formed polyesters to understand the kinetics and
91 therefore to optimize the eROP. Our results show that the combination of enzymatic ring
92 opening polymerization and micro-flow technology open the access to well-defined and
93 cost effective polymer synthesis.

94 **II Methods and materials**

95 *II.1 Chemicals*

96 Initiators (1-propanol, 1-octanol, 3-methyl-1-butanol, 3-phenyl-1-propanol (PP), 4-
97 phenyl-2-butanol, 1-pyrenebutanol and cholesterol), solvent (anhydrous toluene),
98 ionization agent for MALDI analysis sodium iodide (NaI) and matrix dihydroxybenzoic
99 acid (DHB) were purchased from Sigma-Aldrich® (St. Louis, MO, USA) and used as
100 received. The two monomers: δ -valerolactone (VL) and ϵ -caprolactone (CL) were
101 purchased from TCI (Tokyo Chemical Industry, Tokyo, Japan) and conserved on
102 activated molecular sieves. Novozym 435® (N435®) beads was purchased from STREM
103 chemicals (Newburyport, MA, USA).

104

105 *II.2 Analytical methods*

106 Proton nuclear magnetic resonance spectra (^1H NMR) were recorded on an AVANCE
107 300 spectrometer (300 MHz) (Bruker Biospin, Wissembourg, France) using
108 tetramethylsilane (TMS) as the internal standard and using CDCl_3 as solvent. The peak
109 of non-deuterated chloroform resonates at 7.23 ppm. The experiments were carried out
110 at 293 K.

111 Size exclusion chromatography (SEC) was performed on a Prominence chromatography
112 chain (Shimadzu, Kyoto, Japon) fitted with a Refractive Index (RI) detector (RID-20A)
113 and an UV detector (SPD-20A). The columns (KF-802 and KF-803L from Shodex
114 (Tokyo, Japan)) were eluted with tetrahydrofuran (THF) at a flow rate of 1 mL/min at 30
115 °C. The samples were previously prepared by dissolving 10 mg of sample in 1 mL THF.
116 The solution was then filtered through a PTFE filter with a pore diameter of 0.45 μm . A
117 volume of 20 μL was injected into the size exclusion chromatography to carry out the
118 analysis. The SEC was calibrated with poly (styrene) standards. The number average
119 molecular weight was determined from the UV detector absorbance.

120 Matrix assisted laser desorption ionization-time of flight mass spectra (MALDI-TOF MS)
121 were recorded at 20 kV in positive ion mode on an ABISciex (Framingham, MA, USA)
122 4800 plus mass spectrometer. Samples, NaI were dissolved in THF at a concentration
123 of 5 $\text{mg}\cdot\text{mL}^{-1}$ and dithranol matrix at 15 $\text{mg}\cdot\text{mL}^{-1}$. These three solutions were mixed in a

124 volume ratio of 1:1:1. Then, 0.1 μL of the final solution was spotted on the target plate.
125 The mass range was set to m/z 200–5000. The applied laser's power was 4500
126 (arbitrary value) and 1000 laser shots were accumulated for each scan.

127 High resolution MALDI mass spectra were acquired on a SolariX XR FTICR instrument
128 fitted with a 9.4 T actively shielded superconducting magnet and a dynamically
129 harmonized cell (Bruker Daltonics, Bremen, Germany). This instrument was equipped
130 with both laser desorption ionization source (Smartbeam® II, Nd:YAG harmonic 3 laser
131 at 355 nm) and an electrospray source. Matrix-assisted laser desorption/ionization
132 Fourier transform ion cyclotron resonance (MALDI-FT-ICR) mass spectra were acquired
133 in positive ion mode. The mass range was set to m/z 200–5000. The applied laser
134 power was 20% and 500 laser shots were accumulated for each scan. Samples were
135 deposited on the plate as previously described.

136

137 *II.3 Enzymatic ring opening polymerization (e-ROP) of lactones in FEP microreactor*

138 The enzyme immobilized tubular reactor was made from fluorinated ethylene propylene
139 (FEP) tubing (i.d. 1.55 mm, length 25 or 50 cm, Cluzeau Info Labo (C.I.L.), Sainte-Foy-
140 La-Grande, France) fitted with 8-mL stainless-steel syringe (thread 1/4–28 inch,
141 $\varnothing = 1/16$ inch, PC5 702268, Harvard Apparatus) powered by a Harvard Apparatus
142 (Holliston, MA, USA) PHD ULTRA XF syringe pump as shown in Fig. S1. The tube
143 outlet was plugged by cotton to hold the enzymes beads after what the tube was filled
144 with N435® beads. The enzyme bead load was 100 mg (10%w of CL) in the 25 cm long
145 of FEP tube in which we performed the e-ROP of CL and 200 mg (20%w of VL) in the
146 50 cm one for the VL e-ROP. The volume of the tubular reactor was estimated by
147 flowing toluene through the reactor and estimated to be 0.28 and 0.55 mL, respectively
148 for the 25 and 50 cm reactors. The stock solution lactone and initiator in dried toluene
149 was prepared using Schlenk technique under nitrogen. All reactions were carried out
150 following the same equivalents: 20/1/40 respectively for the monomer, the initiator and
151 toluene (solvent). The mixture was transferred into the 8 mL stainless steel syringe
152 under nitrogen atmosphere. The enzyme immobilized tubular reactor was flushed with
153 dried toluene to remove the moisture and air. The stock solution was pumped into the
154 tubular reactor at the desired flow rate, and the reactor was placed into a water bath at

155 the specific temperature. The residence time was calculated from the flow rate and the
156 residence volume of the tubular reactor filled by N435® beads (Eq. S1). The products
157 were collected after precipitation in the cold methanol, filtration, and drying (see SI). We
158 verified that no polymerization was taking place in absence of the enzyme N435®
159 beads neither at room temperature nor at 70 °C (Table S3, runs 6 and 7), proving that
160 the polymerization is immediately quenched once the reaction medium is no longer in
161 contact with the enzyme.

162

163

164 *II.4 Enzymatic ring opening copolymerization (e-ROCP) of lactones in the integrated*
165 *FEP microreactor system by sequential addition.*

166 The enzyme immobilized tubular reactor for copolymerization was an extension of the
167 previous one. The end of the first FEP tube (diameter = 1.55 mm, length = 25 cm) was
168 connected to a tee mixer fed by a second 8 mL stainless steel syringe powered by the
169 same syringe pump, and connected to a FEP tube (diameter = 1.55 mm,
170 length = 50 cm). The stock solution (A) contains the first monomer (CL), the initiator and
171 toluene as solvent and the stock solution (B) contains the second monomer (VL) and
172 toluene as solvent. A and B stock solutions were pumped into the tubular reactor at the
173 same flow rate (0.067 ml.min⁻¹). After solutions (A) and (B) had been mixed, the flow
174 rate in the second reactor became double of that in the first one (0.134 ml.min⁻¹), so that
175 residence times in the first and the second tube are the same (4 min). The reactors
176 were placed into water bath at 70 °C. The products were collected after precipitation in
177 the cold methanol, filtration, and drying as described in SI.

178

179 *II.5 Degradation of polylactones by the Novozym 435®*

180 In order to verify the degradation of polylactones by the action of the enzyme, we
181 prepared PCL and PVL. A specific mass of each polymer in toluene (5 ml) was injected
182 in a FEP tubular reactor containing 300 mg of N435® beads. Three stages were
183 studied: (i) stage 1- the initial polylactone in its dried form; (ii) stage 2- the solution
184 recovered after passing the initial polylactone through the tubular reactor filled of N435®

185 beads, so before its purification and (iii) stage 3- the final product recovered after
186 purification of the later solution (precipitation, filtration and drying).

187 The polymers were characterized by Matrix-assisted laser desorption/ionization Fourier
188 transform ion cyclotron resonance mass spectrometry (MALDI-FTICR-MS) at each
189 stage to detect possible variations in their molecular weight dispersity as well as their
190 chains structure.

191

192 III Results and discussion

193 *III.1 Enzymatic ring opening polymerization (e-ROP) of lactones in FEP microreactor.*

194 *III.1.1 Poly (ϵ -caprolactone) synthesis.*

195 Following Gross et al.'s pioneering work [26, 27], we studied CL conversion versus
196 residence time by e-ROP (Scheme 1) in flow in dry toluene using immobilized Novozym
197 N435 (100 mg) and 3-phenyl-1-propanol as initiator with a monomer to initiator
198 concentration ratio ($[M]/[I]$) of 20 at a concentration of 4.5 M. The microreactor used in
199 this study had approximately the same cross-section as the one used by Kundu et al.
200 [26, 27] (1.9 mm² versus 2.0 mm²) and the same length (250 mm versus 260 mm). In a
201 recent study Zhu et al [29] used a larger cross section of 11.34 mm² and a slightly
202 longer length (300 mm).

203

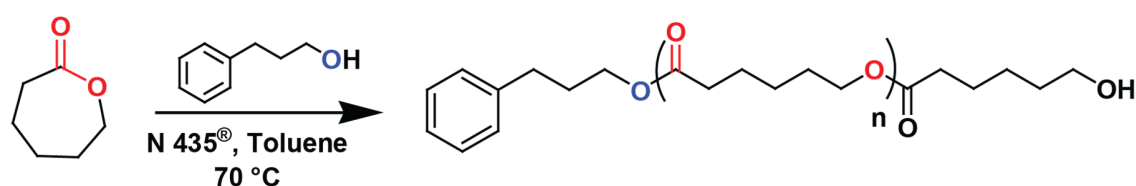

204

205

Scheme 1. e-ROP of CL.

206

207 Table 1 shows that at room temperature (20 °C), the CL conversion increased from 15%
208 to 94% when the residence time was increased from 0.5 min to 10 min, and above 10
209 min the conversion remains at 94% (Fig. 1). The polymerization followed a first-order
210 kinetics during the whole course of the reaction as the logarithm of the monomer
211 concentration vs. residence time (min) exhibited a linear relationship. The slope gave a

212 rate constant of 0.004 s^{-1} with a coefficient of correlation R^2 of 0.98 (Fig. 2). This linear
 213 correlation indicates a good control on the polymerization. During the propagation step
 214 the concentration of active centers was not altered and no termination reactions
 215 occurred [32]. In agreement with this kinetics, GPC showed a pretty narrow molecular
 216 weight dispersity ($\mathcal{D} = 1.35$). The MALDI-TOF spectrum (Fig. 3) presented a bell-shaped
 217 peak distribution in agreement with GPC. A negligible presence of macrocycles was
 218 also detected. We repeated the same study but at $70 \text{ }^\circ\text{C}$. As indicated in Table S1, the
 219 conversion increased from 30% to 100% when the residence time was increased from
 220 15 s to 240 s, and above 240 s the conversion remains at 100% (Fig. S4). So, at $70 \text{ }^\circ\text{C}$
 221 a lower residence time was enough to afford complete conversion. From the linear
 222 kinetic plot presented in Fig. S5 a rate constant of 0.011 s^{-1} was obtained with a
 223 coefficient of correlation R^2 of 0.96. This first order kinetic rate constant is in agreement
 224 with Kundu et al [26] who also found a rate constant of 0.011 s^{-1} for the same reaction.
 225 GPC analysis showed that the molecular weight dispersity is slightly better at $70 \text{ }^\circ\text{C}$ than
 226 at $20 \text{ }^\circ\text{C}$ (respectively $\mathcal{D} = 1.30$ and $\mathcal{D} = 1.35$). This molecular weight dispersity is better
 227 than those Kundu et al [26] who showed the presence of oligomers and slightly higher
 228 than the molecular-weight dispersity reported by Zhu et al [29] in approximately the
 229 same conditions ($\mathcal{D} = 1.12$ and 1.17 for $([M]/[I])$ of 10 and 30). In all cases flow mode
 230 provided lower molecular weight dispersity than batch since under the same conditions
 231 Zhu et al [29] obtained PCL of $\mathcal{D} = 1.48$ with a much higher reaction time of 14 h. As
 232 shown below the molecular-weight dispersity is sensitive to the nature of the initiator
 233 (see Table 3). The use of 6-mercapto-1-hexanol as initiator may explain their lower
 234 molecular-weight dispersity. In the MALDI-TOF spectrum (Fig. S6) two other minor
 235 species of PCLs were detected, chains initiated by H_2O and macrocycles which result
 236 from their cyclisation, but the overwhelming majority remains PP end chains (Fig. 4).

237

238 **Table 1**

239 PCL produced by e-ROP in flow at room temperature.^a

| <i>Residence time</i> (min) | 0.5 | 1.0 | 1.5 | 2.0 | 4.0 | 6.0 | 8.0 | 10 | 12 |
|---|-----|-----|-----|-----|-----|-----|-----|-----|-----|
| Conv. (%) ^b | 15 | 25 | 31 | 42 | 55 | 77 | 86 | 94 | 94 |
| $M_{n,NMR} \times 10^{-3}$ (g/mol) ^a | - | - | - | 1.9 | 3.0 | 2.1 | 1.9 | 2.3 | 2.1 |

Poly lactones synthesis by enzymatic ring opening polymerization in flow

240 ^a [CL] = 4.5 M and [PP] = 0.225 M in toluene

241 ^b Determined by ¹H NMR.

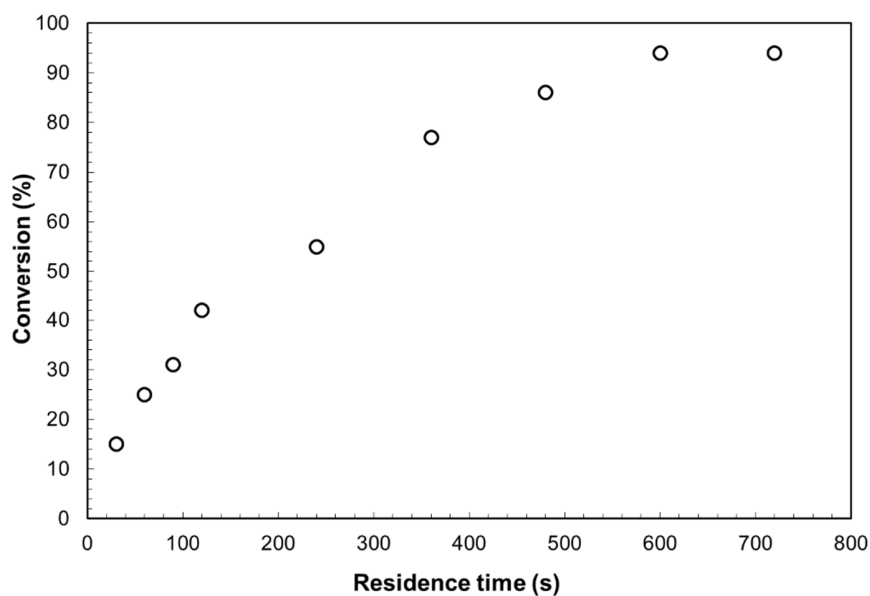

242

243 **Fig. 1.** Conversion (%) of PCL versus residence time (s) at room temperature.

244

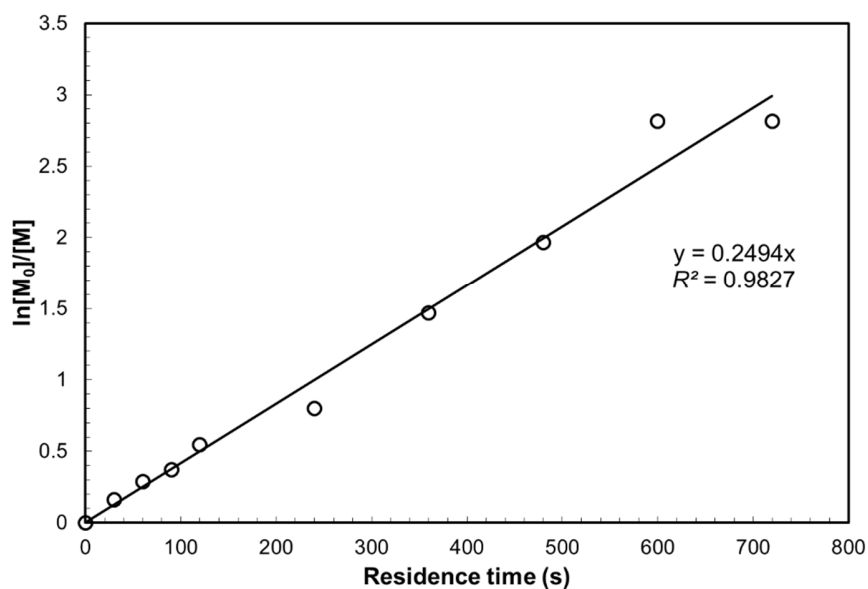

245

246 **Fig. 2.** Semilogarithmic kinetic plot for e-ROP of CL at room temperature in flow.

247

Poly(lactones) synthesis by enzymatic ring opening polymerization in flow

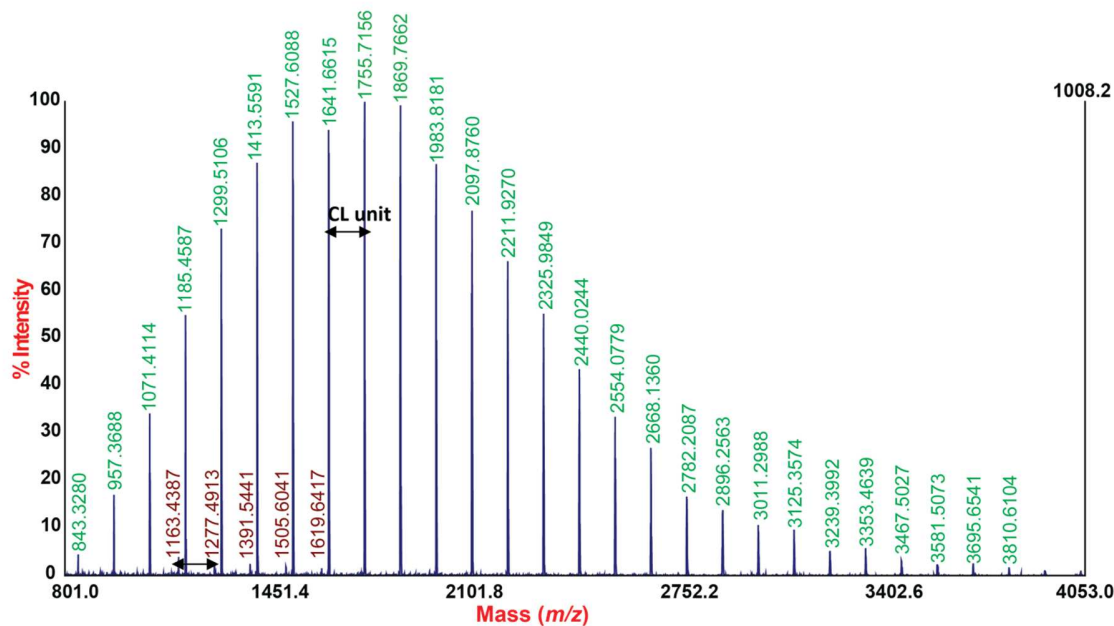

248

249 **Fig. 3.** MALDI-TOF MS of PCL initiated by PP in flow at room temperature using a residence
 250 time of 600 s.

251 **Green, chains initiated by PP:** $M = (M_{monomer} \times nb\ monomer) + M_{PP} + M_{Na^+}$

252 **Red, macrocycles:** $M = (M_{monomer} \times nb\ monomer) + M_{Na^+}$

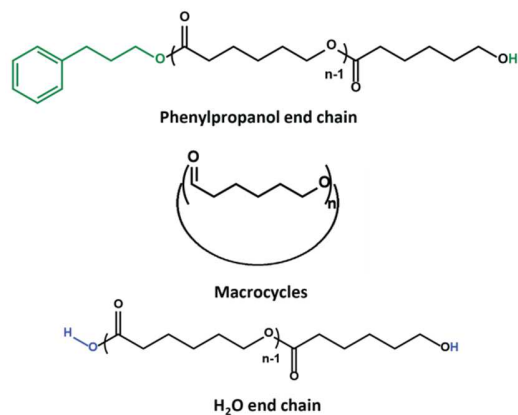

253

254 **Fig. 4.** PCL with different end chains.

255

256 *III.1.2 Poly(δ -valerolactone) synthesis.*

257 The same study previously described with CL was repeated on VL at 60 °C (Scheme 2)
 258 also in dried toluene and using PP as initiator with a $[M]/[I]$ of 20. VL is a more difficultly

Poly lactones synthesis by enzymatic ring opening polymerization in flow

259 polymerized compared to CL [33, 34], therefore we increased the amount of N435®
260 beads from 100 mg to 200 mg.

261

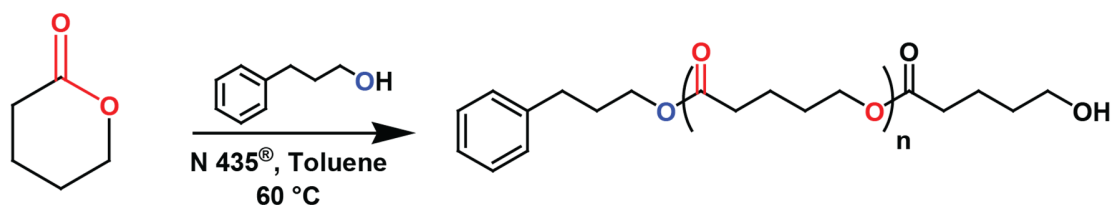

262

263

Scheme 2. e-ROP of VL.

264

265 Table S2 shows that at 60 °C, the conversion of VL increased from 12% to 93% when
266 the residence time was increased from 20 s to 214 s (Fig. S7). The linear relationship
267 between the logarithm of the monomer concentration vs. residence time (s) indicates
268 that the polymerization followed a first order kinetics. The rate constant and the
269 coefficient of correlation R^2 given by the slope are 0.012 s^{-1} and 0.96 respectively (Fig.
270 S8). This rate constant, which is almost equivalent to the one for CL at 70 °C, was
271 obtained by doubling the quantity of N435® beads. This result is in agreement with van
272 der Mee et al. [34] who gave a Michaelis-Menten relationship in which the Michaelis
273 constant K_M is almost the same for CL and VL but the catalytic rate constant k_{cat} is
274 nearly the double for CL, leading to polymerization rates for CL that are twice as high.
275 This linear relationship proved again the good control of the polymerization progress,
276 also verified by GPC, which gave a good narrow molecular weight dispersity ($\mathcal{D} = 1.27$).
277 This value is slightly higher than those obtained by Zhu et al [31] in almost comparable
278 reactions conditions ($\mathcal{D} = 1.13$ and 1.16 for $[M]/[I]$ of 10 and 30) using a larger cross
279 section tube compared to us (11.34 mm² versus 1.9 mm² respectively) with a shorter
280 length (300 mm versus 500 mm). However, a much higher residence time of 20 min
281 was required to reach the highest conversions of 98%. In contrast, a residence time of
282 214 s (≈ 3.5 min) was enough in our case at $[M]/[I] = 20$ to reach the highest conversion
283 of 93%. The same reaction performed in batch system gave widely dispersed polymers
284 ($\mathcal{D} = 1.35$ for $[M]/[I]$ of 30) for a higher reaction time of 600 min. The MALDI-TOF
285 spectrum (Fig. S9) revealed the presence of two other families of species, chains
286 initiated by H₂O and macrocycles, although the dominant one still being the PP end

287 chains. Above 214 s of residence time the molecular weight decreased, which can be
 288 explained by the beginning of the depolymerization of the formed polymer [35] by the
 289 enzyme that will be discussed later in section IV. Moreover, we carried out the e-ROP of
 290 VL at room temperature (Table 2). Within 600 s (10 min), we were able to reach the
 291 complete conversion of 100% (Table 2, Run 2) with approximately the same dispersity
 292 as the one recorded at 60 °C ($\bar{D} = 1.28$ vs $\bar{D} = 1.27$). Remarkably, the conversion and
 293 dispersity obtained were the same at room temperature as at 60 °C. This residence time
 294 remains lower than those published in the work of Zhu et al [31] at 60 °C in the
 295 conditions cited previously (10 min vs 12 min and 20 min). Interestingly, the MALDI-TOF
 296 spectrum indicates that the two minor species are almost suppressed at room
 297 temperature (Fig. 6).

298

299 **Table 2**

300 PVL produced by e-ROP in flow at room temperature.^a

| Run | Residence time (s) | $M_{n,theo} \times 10^{-3}$ (g/mol) ^b | $M_{n,NMR} \times 10^{-3}$ (g/mol) ^c | \bar{D} ^d | Conv (%) ^c |
|-----|-----------------------|---|--|------------------------|-----------------------|
| 1 | 480 | 1.9 | 2.5 | - | 97 |
| 2 | 600 | 2.3 | 2.0 | 1.28 | 100 |

301 ^a [VL] = 4.5 M, [PP] = 0.225 M in toluene using 200 mg of N435® beads

302 ^b Calculated from $([M]/[I])Conv. \times Mw(VL) + Mw(PP)$.

303 ^c Determined by ¹H NMR.

304 ^d Determined by GPC.

305

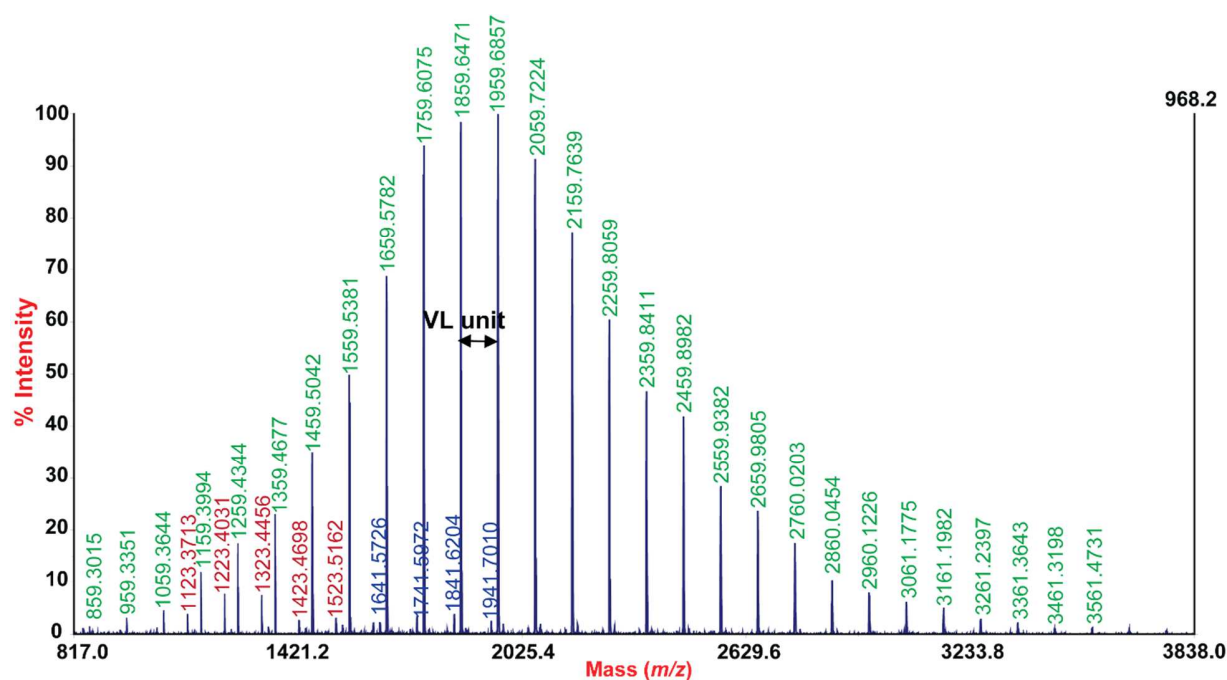

306

307 **Fig. 5.** MALDI-TOF of PVL e-ROP initiated by PP in flow at room temperature using a
 308 residence time of 600 s.

309 **Green, chains initiated by PP:** $M = (M_{monomer} \times nb\ monomer) + M_{PP} + M_{Na^+}$

310 **Red, macrocycles:** $M = (M_{monomer} \times nb\ monomer) + M_{Na^+}$

311 **Blue, chains initiated by residual water:** $M = (M_{monomer} \times nb\ monomer) + M_{water} + M_{Na^+}$.

312

313 III.2 Effect of initiators on enzymatic ring opening polymerization (e-ROP).

314 As shown by Table 3, we used different alcohols as initiator to polymerize CL and VL to
 315 study their effects on polymers molecular weight and molecular weight dispersity. We
 316 started by primary alcohols which differ in their carbon chain length and in their steric
 317 hindrance. Propanol gave a PCL of $\bar{D} = 1.24$, elongating the chain carbon length from
 318 C3 to C8 using octanol increased this value to $\bar{D} = 1.28$. MALDI-TOF spectra show a
 319 bell-shaped peak distribution for both propanol (Fig. S10) and octanol (Fig. S11)
 320 initiators in which macrocycles and H₂O end chains are in minority in both cases. 3-
 321 methyl-1-butanol, a primary branched alcohol, increased the molecular weight dispersity
 322 compared to the two previous linear alcohols ($\bar{D} = 1.24$ and 1.28 vs $\bar{D} = 1.4$) and
 323 afforded a greater quantity of macrocycles (Fig. S12). Pyrenebutanol, a primary but
 324 bulky alcohol, gave the highest molecular weight dispersities among primary alcohols
 325 both in CL polymerization ($\bar{D} = 1.44$) and VL polymerization ($\bar{D} = 1.39$). MALDI-TOF

326 spectra present two major species, chains with initiator extremity and macrocycles (Figs
327 S13 to S14), the former being much more abundant. When using 4-phenyl-2-butanol (a
328 secondary alcohol) structurally close to 3-phenyl-1-propanol, the MALDI-TOF spectrum
329 revealed the presence of same species macrocycles and chains initiated by the initiator
330 (Fig. 6) as for 3-phenyl-1-propanol but the quantity of macrocycles increased. When
331 cholesterol (a bulky secondary alcohol) was taken as initiator, polymers with the
332 appearance of cotton were obtained (Fig S15) instead of powder like for the other
333 synthesized polyesters. MALDI-TOF spectrum only showed the formation of
334 macrocycles (Fig. 7). The GPC analysis, calibrated with polystyrene, gave a molecular
335 weight for this polymer $M_n = 19 \times 10^3$ g/mol and a molecular weight dispersity $D = 1.6$
336 (Table 3). However, cyclic polymers exhibit higher molecular weight by GPC, leading to
337 the conclusion that these values are overestimated [36]. The appearance of cotton for
338 this polymer is agreement with the unique properties of cyclic polyesters leading to
339 specific applications in biology in particular [37, 38]. Cholesterol behaved similarly with
340 VL where macrocycles formation was obtained in addition to H₂O end chains (Fig. S16).
341 So as expected, primary alcohols were more efficient at initiating the e-ROP of lactones
342 than the secondary ones, as the propagating chain implies a primary alcohol [39]. The
343 lower activity of secondary alcohols has two consequences; (i) the high percentage of
344 initiation by residual water and (ii) the more important formation of macrocycles as the
345 acid extremity is not esterified. As an illustration 4-phenyl-2-butanol gave a high
346 percentage of macrocycles (Fig. 6) contrary to 3-phenyl-1-propanol (PP) (Fig. 6). It must
347 be pointed out that water cannot be completely removed as the CALB requires a
348 minimum of free water to be active [40]. Reversible conformational changes of CALB
349 occurred upon interaction with substrates. The presence of free water on the surface of
350 CALB maintains its flexibility during these changes by acting as lubricant [41].
351 Therefore, no attempt was made to work in a totally anhydrous toluene.

352

353 **Table 3**

354 e-ROP of CL^a and VL^b using different alcohols as initiators in flow^c.

| Initiator | Monomer | $M_{n,GPC} \times 10^{-3}$ (g/mol) ^d | $M_{w,GPC} \times 10^{-3}$ (g/mol) ^d | \bar{D} ^d | Conv (%) ^e |
|----------------------------------|---------|--|--|------------------------|-----------------------|
| 1-propanol | CL | 5.1 | 6.3 | 1.24 | 88 |
| 1-octanol | CL | 5.2 | 6.5 | 1.28 | 95 |
| 3-methyl-1-butanol | CL | 3.7 | 5.2 | 1.40 | - |
| 3-phenyl-1-propanol | CL | 5.1 | 6.6 | 1.30 | 95 |
| 3-phenyl-1-propanol ^f | CL | 3.4 | 4.6 | 1.35 | 94 |
| 3-phenyl-1-propanol | VL | 4.1 | 5.2 | 1.27 | 93 |
| 3-phenyl-1-propanol ^f | VL | 3.7 | 4.8 | 1.29 | 100 |
| Pyrenebutanol | CL | 3.3 | 4.8 | 1.44 | 96 |
| Pyrenebutanol | VL | 3.7 | 3.8 | 1.39 | 90 |
| 4-phenyl-2-butanol | CL | 5.7 | 7.0 | 1.24 | 90 |
| Cholesterol | CL | 19 | 23.4 | 1.23 | 91 |
| Cholesterol | VL | 6.3 | 10.1 | 1.60 | 78 |

355 ^a Reaction temperature is 70 °C, in toluene, [M]/[I](mol) = 20, 100 mg of N435.

356 ^b Reaction temperature is 60 °C, in toluene, [M]/[I](mol) = 20, 200 mg of N435.

357 ^c Reactions in flow system with residence time of 240 s. [M] = 4.5 M, [I] = 0.225 M.

358 ^d Determined by GPC.

359 ^e Determined by ¹H NMR.

360 ^f Reactions at room temperature.

Polyactones synthesis by enzymatic ring opening polymerization in flow

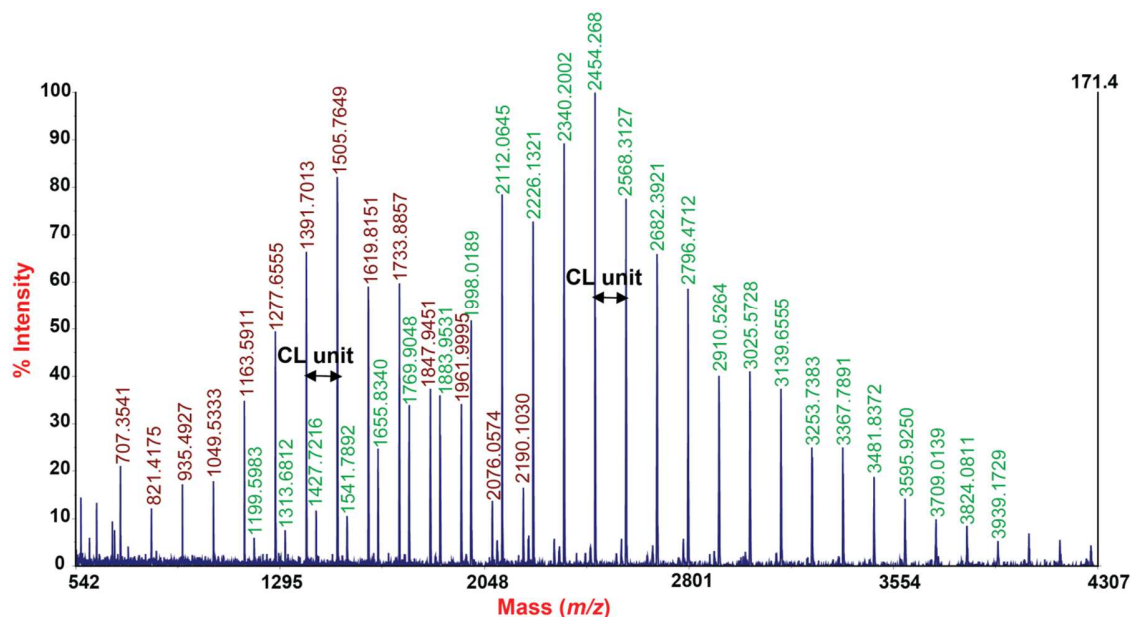

361
362
363
364
365

Fig. 6. MALDI-TOF MS of PCL initiated by 4-phenyl-2-butanol in flow.

Green, chains initiated by PP: $M = (M_{monomer} \times nb\ monomer) + M_{PP} + M_{Na^+}$

Red, macrocycles: $M = (M_{monomer} \times nb\ monomer) + M_{Na^+}$

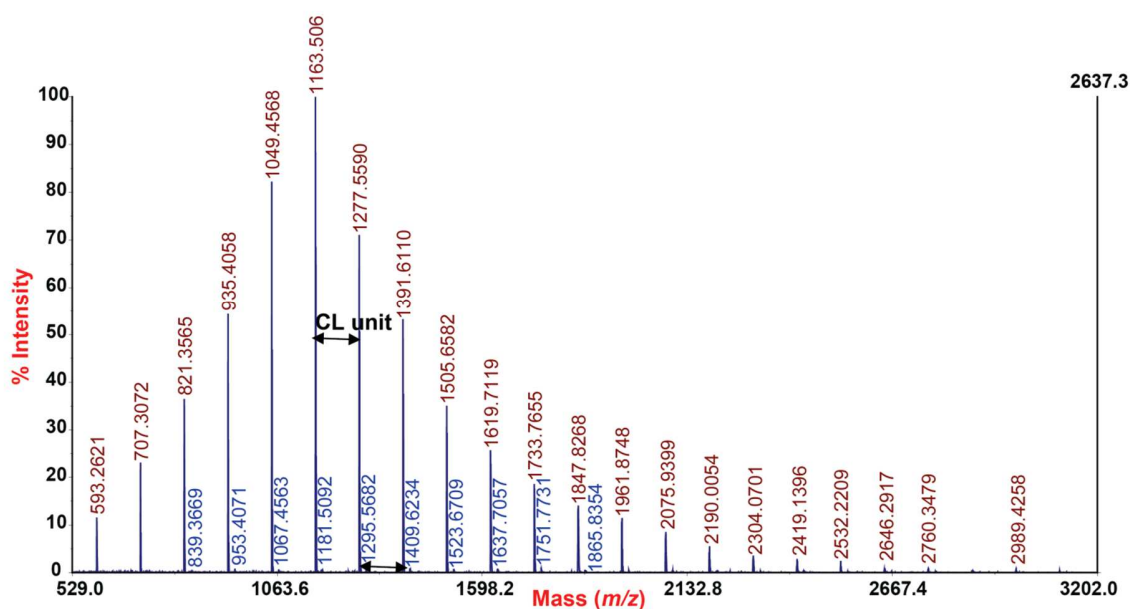

366
367
368
369

Fig. 7. MALDI-TOF MS of PCL initiated by cholesterol in flow.

Red, macrocycles: $M = (M_{monomer} \times nb\ monomer) + M_{Na^+}$

Blue, chains initiated by residual water: $M = (M_{monomer} \times nb\ monomer) + M_{water} + M_{Na^+}$

370 In view of the results obtained with cholesterol, we carried out the e-ROP of CL at 70°C
371 in the absence of added initiator. As shown in Table S3, we obtained 100% of
372 conversion using 100 mg of N435® beads at a residence time of 120 s or 240 s (S3,
373 entries 1 and 2). In addition, 44% of conversion was obtained at room temperature in
374 240 s of residence time (Run 3). Increasing the quantity of N435® beads to 200 mg at a
375 residence time of 240 s gave the same results showing that the obtain polymer is
376 resistant to depolymerization (Run 4). Unsurprisingly the polymers had the appearance
377 of cotton exactly like those obtained when using cholesterol as an initiator. MALDI-TOF
378 spectra also indicate the presence of macrocycles only (for an example of MALDI-TOF
379 spectrum see Fig. S17). Nevertheless, the GPC of these polymers showed a much
380 wider molecular weight dispersity [$D = 1.99-2.68$]. Epoxidized cholesterol is specifically
381 acetylated in presence of vinylacetate by N435® beads, showing that cholesterol is a
382 substrate for immobilized CALB [42]. In other words, even if it not directly implied in
383 lactone polymerization, cholesterol modulates the CALB activity. The maximum CALB
384 which can be immobilized on Lewatit VP OC 1600 support is 30 mg per gram [43]. As
385 the molecular weight of CALB is around 33 kDa the quantity of CALB enzyme in the
386 reactor which contains 100 mg or 200 mg of N435® beads was around 100 pmol for CL
387 polymerization and 200 fmol for VL polymerization. The quantity of cholesterol in the
388 reactor was 63 μM and 126 μM for CL and VL respectively. Hence, cholesterol is
389 present in a more than 100-fold excess compared to CALB. CALB has a stereospecific
390 pocket for secondary alcohols [44] and the non-reacting enantiomer during kinetic
391 resolution modulates its reactivity [45], which may explain the effect of a large excess of
392 cholesterol. Another explanation is the complexation of cholesterol to the surface of the
393 Lewatit VP OC 1600 support and the modification of the hydrophobicity of the enzyme
394 environment, which also modulates its reactivity [43].

395

396 *III.3 Enzymatic ring opening copolymerization (e-ROCP) of lactones to produce di-block*
397 *copolymer in the integrated microreactor system by sequential addition*

398 We performed the copolymerization of CL and VL at 70 °C (Table 4) by sequential
399 addition using the integrated microreactors with CL fed in the first reactor and CL after
400 polymerization and fresh VL in the second one (Fig. 8). We fed the two reactors with

401 two identical syringes on the same syringe pump. For obtaining the same residence
402 time in the two reactors, the length of the second microreactor was twice as the length
403 of the first one (50 cm and 25 cm respectively). This set-up implies that the quantity of
404 N435[®] beads in the second reactor is twice as the quantity in the first one, thus giving
405 approximately the same rate of polymerization of VL as CL rate of polymerization is
406 about twice as the rate for VL. So there is only small changes in conversion and
407 molecular weight dispersity when going from [CL]/[I] = 40, [VL]/[I] = 40 (Table 4, entry 1)
408 to [CL]/[I] = 40, [VL]/[I] = 20, (Table 4, entry 2) and [CL]/[I] = 20, [VL]/[I] = 40 (Table 4,
409 entry 3). In addition, experimental molecular weights were relatively close to the
410 theoretical previewed ones proving the livingness of PCL produced and its effectiveness
411 as a macro-initiator. In details, when using 40/40 equivalents respectively for CL and VL
412 the conversion was 93% and the molecular weight dispersity $\bar{D} = 1.26$ (entry 1). The
413 much lower M_n value than theoretical value in entry 1 even though conversion reached
414 93% is explained by the presence of oligomers which are not recovered after
415 precipitation. The monomer decrease measured by NMR combines monomer
416 consumption by both polymer and oligomer formation. Thus, oligomers formation
417 increases the determined conversion. When decreasing the VL equivalents to 40/20,
418 the conversion increased to 97% (entry 2), whereas by decreasing the CL equivalents
419 to 20/40, the conversion dropped to 88% (entry 3). This result show that living PCL is
420 slightly less efficient as the PP initiator as the initiation of the CL and VL alone by PP in
421 the same conditions led to the same conversion (Table S1, conv = 100% and S2, conv
422 = 93% respectively).

423

Poly lactones synthesis by enzymatic ring opening polymerization in flow

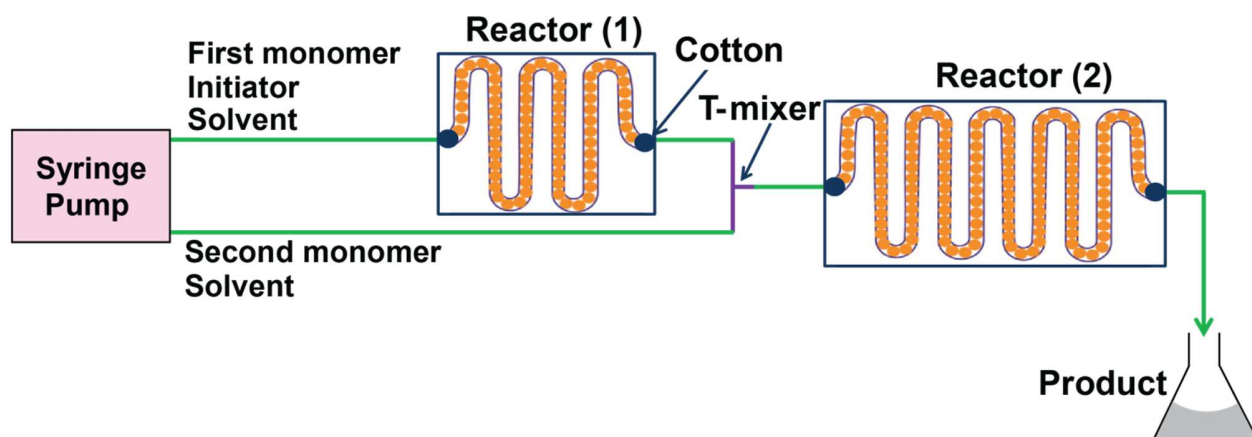

424
425 **Fig. 8.** Immobilized enzymes in the integrated FEP tubing for enzymatic ring opening copolymerization.
426

427 **Table 4**
428 Enzymatic ring opening copolymerization of CL and VL in flow at 4 min
429 of residence time for the two tubular reactors.^a

| Run | M (1) | M (2) | Eq. | $M_{n,theo} \times 10^{-3}$ (g/mol) ^a | $M_{n,NMR} \times 10^{-3}$ (g/mol) ^b | \bar{D}^c | Conv (%) ^a |
|-----|-------|-------|---------|---|--|-------------|--------------------------|
| 1 | CL | VL | 40/40/1 | 8.1 | 5.8 | 1.26 | 93 |
| 2 | CL | VL | 40/20/1 | 6.4 | 5.7 | 1.32 | 97 |
| 3 | CL | VL | 20/40/1 | 5.8 | 6.1 | 1.24 | 88 |

430 ^a Calculated from $(\frac{[M_1]+[M_2]}{[I]} \times Conv) \cdot (M_w(CL) + M_w(VL)) + M_w(PP)$.

431 ^b Determined by ¹H NMR.

432 ^c Determined by GPC.

433 *M: Monomer *Eq: molar equivalents

434

435 **IV Degradation of polylactones by the action of N435® beads**

436 We performed the degradation of PCL and PVL by the action of N435® beads (table
437 S4). At 70 °C, 0.5 g of PCL were fed into the microreactor at flow rates affording

438 residence times from 0.5 to 4 min. The recovered solution was submitted to the same
439 precipitation procedure in cold methanol as the starting PCL. We recovered for all
440 residence times between 32% and 38% of the initial weight of the injected PCL (Table
441 S4) which corresponds to 62 to 68% degradation. MALDI-FTICR spectra showed a high
442 m/z distribution which was roughly similar to the intact polymer, but for the
443 disappearance of the low m/z distribution (Fig. 9). Consequently, 62% to 68% of the
444 PCL was degraded by the enzyme to oligomers that were not recovered by
445 precipitation. MALDI-FTICR spectra presented in Fig. 10 showed that the highest peaks
446 of the initial PCL (top spectrum, Fig. 10) is comprised between m/z 1400 and 2400.
447 After degradation and without precipitation of the polymer in the recovered solution (Fig.
448 10), the dominant peaks are shifted to smaller masses around m/z 500 and 1000 which
449 proves again the degradation of these polymers. After zooming (Figs. S18 and S19), we
450 detected the presence of three different species, (1) polymer chains with initiator
451 extremity, which are the dominant structure in the initial PCL, (2) macrocycles, the
452 intensity of which increased after degradation and (3) chains with H₂O extremity, which
453 are minority before and after degradation. We realized also the degradation of PVL at
454 60 °C, and it resulted in around 56%-70% of degradation (Table S4) in the same range
455 as CL. The analyses MALDI-FTICR (Figs. S20, S21 and S22) supports also the same
456 conclusions as for CL. In brief, the enzymes were able to degrade polylactones even
457 with low residence time of 0.5 min.

458 The degradation of polylactones by lipase is already known, but in this study the
459 degradation occurred in few minutes instead of several hours by other methods [46]
460 even those including flow conditions [47]. This study shows the importance of choosing
461 the optimum residence time to apply in order to prevent the degradation of the polymer
462 formed along its synthesis.

463

Poly lactones synthesis by enzymatic ring opening polymerization in flow

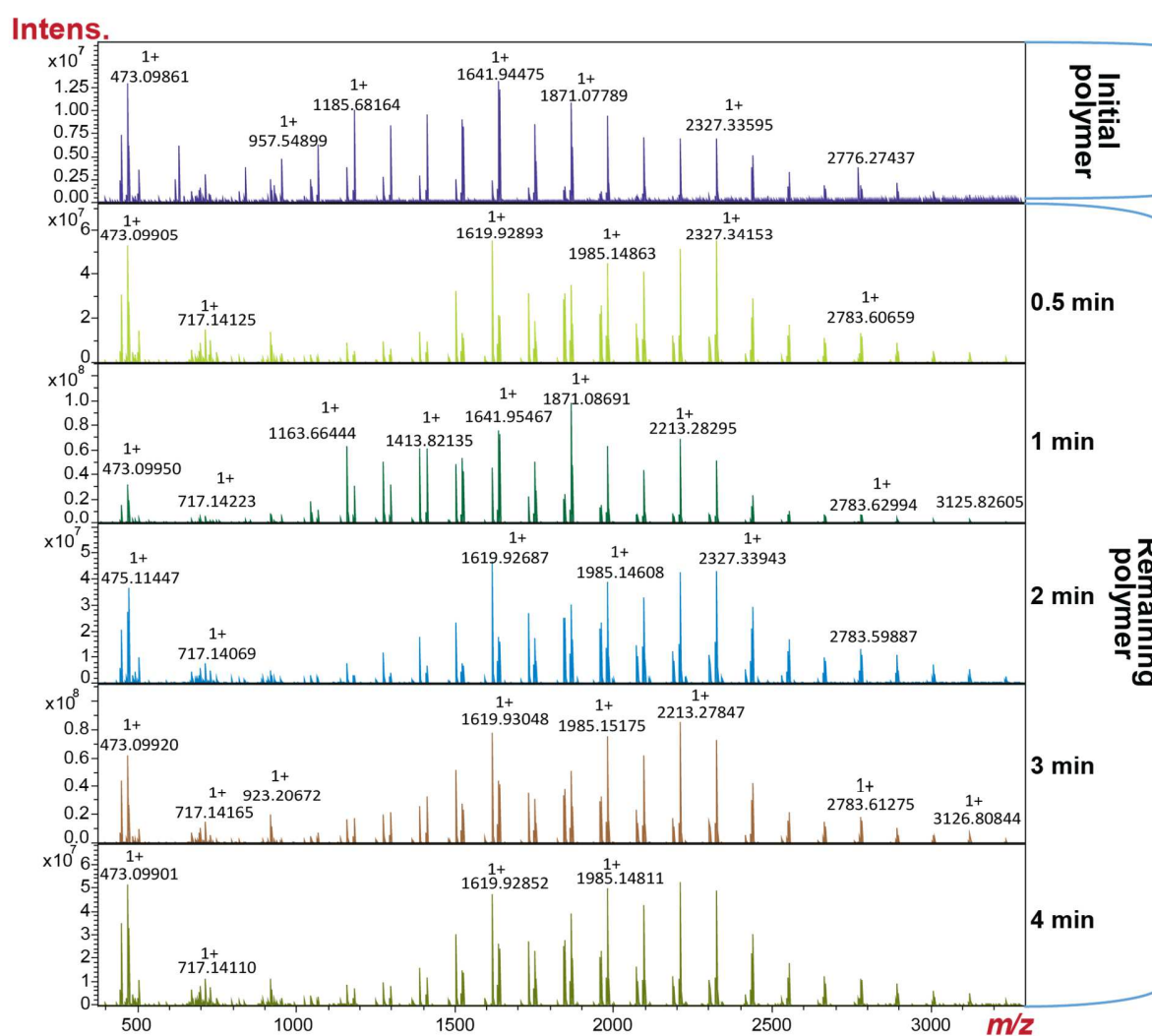

464
 465 **Fig. 9.** MALDI-FTICR MS of the initial PCLs prepared at 70 °C and those remained in their dried
 466 form after the degradation at 70 °C using different residence time in flow.

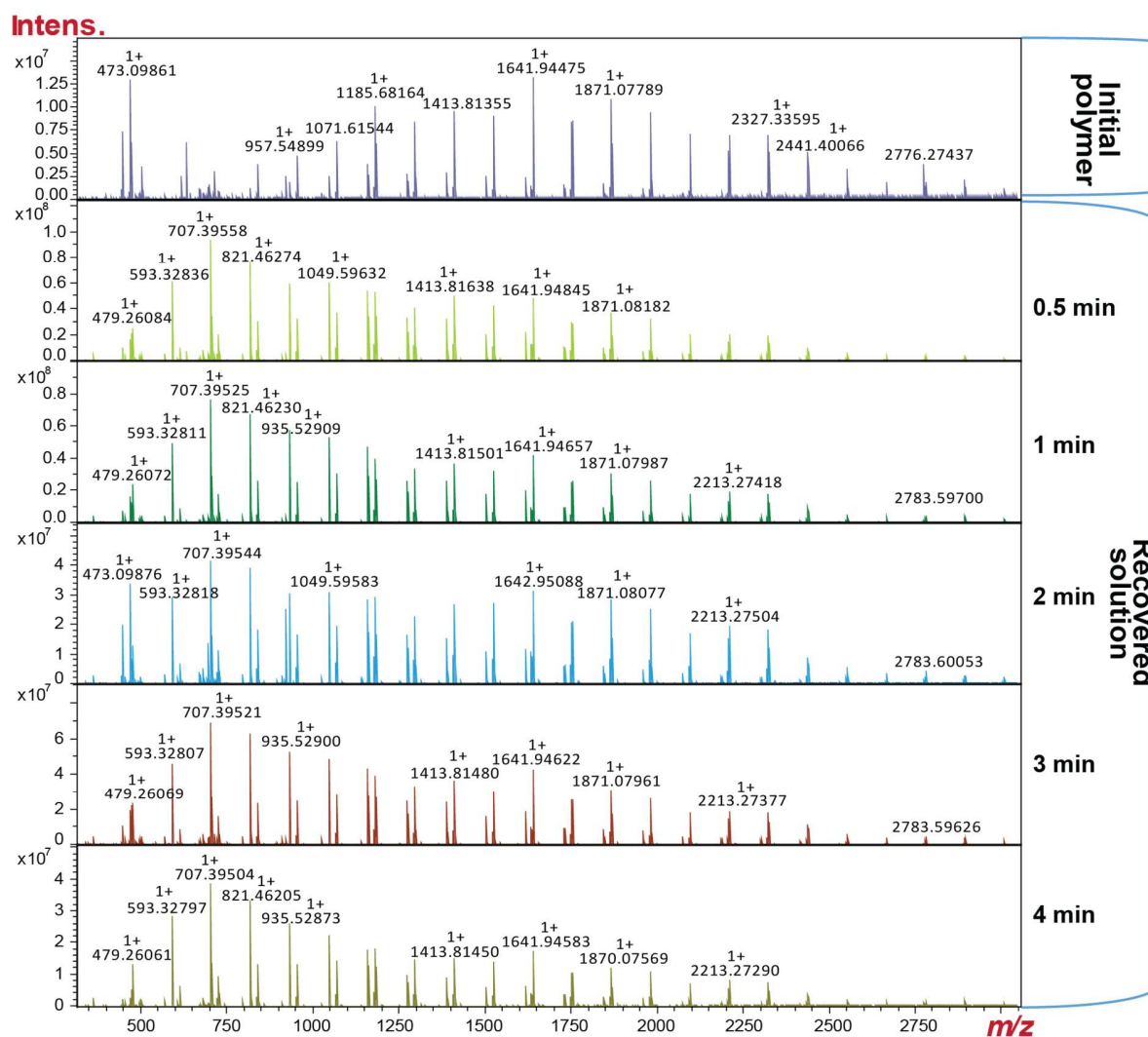

467
 468 **Fig. 10.** MALDI-FTICR MS of the initial PCLs prepared at 70 °C and the recovered solution after
 469 the degradation at 70 °C using different residence time in flow.
 470

471 **V Recycling of N435® beads**

472 N435® beads immobilized into the tubular reactor were reused several times in the
 473 eROP of CL under identical conditions (residence time = 240 s and T = 70 °C). As
 474 shown in table S5, until reaction number 8, conversion was constantly higher than 96%,
 475 then decreased below 90% in reaction 18 and reached 77% in reaction 21. The
 476 molecular weights previewed by ¹H NMR were in agreement with the experimental
 477 ones. This study proved the high efficiency of enzyme, which may be used about twenty

478 times in flow system without the need of any extra step or to recover the catalyst after
479 each reaction. These results are in agreement with those obtained by Kundu et al [27]
480 for flow lactone polymerization catalyzed by N435® beads. In their experiment the
481 conversion dropped from 90% to 70% after twenty cycles of polymerization. In batch
482 and under the same conditions, toluene at 70 °C, Poojari et al could recycle the N435®
483 beads with maintaining constant the molecular weight of PCL for ten times which is the
484 half of the cycles number that we reached in flow [48]. However, they found that in
485 batch a disintegration of the resin particles occurred due to the stirring speed which was
486 a limitation for the recovery and reuse of N435® beads. Furthermore, this mechanical
487 disintegration induced CALB leaching. In our case, the reaction time was for 30 min (Eq.
488 S2) for each cycle which is eight times less than the reaction time needed in batch (30
489 min in flow vs 4 h = 240 min in batch) which affected also the number of reuse cycles of
490 N435® beads in batch.

491

492 **VI Conclusion.**

493 In conclusion, we successfully produced PCL and PVL via e-ROP of CL and VL
494 catalyzed by N435® beads in tubular reactor in flow. Under the best conditions at 70 °C
495 and residence time of 240 s, the CL conversion was 100% with a molecular weight
496 dispersity of $\bar{D} = 1.3$. In similar conditions (60°C, residence time = 214 s) VL afforded a
497 conversion of 93% and a molecular weight dispersity of $\bar{D} = 1.27$. By increasing the
498 residence time to 600 s both CL and VL were cleanly polymerized at room temperature,
499 with a conversion of 94% and molecular weight dispersity of $\bar{D} = 1.34$ for CL, and a
500 conversion of 100%, $\bar{D} = 1.28$ for VL. We verified that no conversion occurred without
501 N435® beads neither at room temperature nor at 70 °C. As initiators, we found that
502 unhindered primary alcohols are more efficient for the initiation than secondary alcohols.
503 With hindered or bulky secondary alcohols or without added initiator, the initiations were
504 done by residual water and the main products are macrocycles obtained with a large
505 molecular weight dispersity [$\bar{D} = 1.99-2.68$] and molecular weight of [1600 – 2600
506 g/mol]. The only exception is cholesterol, a bulky secondary alcohol, which gave a
507 sharper molecular weight dispersity [$\bar{D} = 1.6$] presumably by interacting with CALB.
508 Successful copolymerizations of CL and VL were done by sequential addition which

509 yielded copolymers of $D_{max} = 1.32$ and conversions up to 88%. We showed also the
510 importance of choosing the optimum residence time in order to prevent the degradation
511 of the formed polymers by the enzyme. Finally, under our conditions N435® beads kept
512 a very good efficiency when the same beads packing in the microreactor more than
513 twenty times without any regeneration. These results show that homemade tubular
514 reactor readily assembled in the laboratory are efficient devices to produce polylactones
515 by eROP. This setup paves the way to explore more stringent polymerization catalyzed
516 by CALB such as the eROP of chiral lactones to obtain chiral polyesters [49]. This setup
517 also opens the way to the study of enzymatic polycondensation in flow catalyzed by
518 CALB, which is able to catalyze the transamidation of dimethyl 2,5-furandicarboxylate
519 and heteroatom diamines [50]. The structure of the substrates, which modulates the
520 activity of CALB to produce predominantly cyclic polyesters, deserves further studies.

521

522 **Declaration of competing interest**

523 The authors declare that they have no known competing financial interests or personal
524 relationships that could have appeared to influence the work reported in this paper.

525

526 **Acknowledgments**

527 This work was supported by the Lebanese university. The NMR and Mass Spectrometry
528 facilities used in this study were funded by the European Community (ERDF), Région
529 Haut de France (France), the CNRS, and the Université de Lille, Faculty of Sciences
530 and Technologies. We thank the Mäder company for providing access to the GPC at
531 their central research laboratory (Mulhouse or Villeneuve d'Ascq, France). Access to the
532 FT-ICR MS in the frame of the EU_FT-ICR_MS network installation funded by the EU
533 Horizon 2020 grant 731077 and in the frame of the FR3624 CNRS High field FTICR
534 altogether with the support for conducting research are gratefully acknowledged.
535 Authors thank Caterina Bordin for her careful proofreading of the manuscript.

536

537

538 **I. References**

- 539 [1] H. Seyednejad, A.H. Ghassemi, C.F. van Nostrum, T. Vermonden, W.E. Hennink, Functional aliphatic
540 polyesters for biomedical and pharmaceutical applications, *J. Controlled Release* 152 (2011) 168-176.
541 <https://doi.org/10.1016/j.jconrel.2010.12.016>
- 542 [2] O. Dechy-Cabaret, B. Martin-Vaca, D. Bourissou, Controlled ring-opening polymerization of lactide
543 and glycolide, *Chem. Rev.* 104 (2004) 6147-6176. <https://doi.org/10.1021/cr040002s>
- 544 [3] A. Kowalski, A. Duda, S. Penczek, Polymerization of l,l-Lactide Initiated by Aluminum Isopropoxide
545 Trimer or Tetramer, *Macromolecules* 31 (1998) 2114-2122. <https://doi.org/10.1021/ma971737k>
- 546 [4] T.M. Ovitt, G.W. Coates, Stereochemistry of Lactide Polymerization with Chiral Catalysts: New
547 Opportunities for Stereocontrol Using Polymer Exchange Mechanisms, *J. Am. Chem. Soc.* 124 (2002)
548 1316-1326. <https://doi.org/10.1021/ja012052+>
- 549 [5] G. Schwach, J. Coudane, R. Engel, M. Vert, Ring opening polymerization of D,L-lactide in the presence
550 of zinc metal and zinc lactate, *Polym. Int.* 46 (1998) 177-182. [https://doi.org/10.1002/\(SICI\)1097-
551 0126\(199807\)46:3<177::AID-PI937>3.0.CO;2-S](https://doi.org/10.1002/(SICI)1097-0126(199807)46:3<177::AID-PI937>3.0.CO;2-S)
- 552 [6] G.A. Abraham, A. Gallardo, A.E. Lozano, J.S. Roman, ϵ -Caprolactone/ZnCl₂ complex formation:
553 Characterization and ring-opening polymerization mechanism, *J. Polym. Sci. Part A: Polym. Chem.* 38
554 (2000) 1355-1365. [https://doi.org/10.1002/\(SICI\)1099-0518\(20000415\)38:8<1355::AID-
555 POLA20>3.0.CO;2-Z](https://doi.org/10.1002/(SICI)1099-0518(20000415)38:8<1355::AID-POLA20>3.0.CO;2-Z)
- 556 [7] P. Degée, P. Dubois, R. Jérôme, S. Jacobsen, H.-G. Fritz, New catalysis for fast bulk ring-opening
557 polymerization of lactide monomers, *Macromol. Symp.* 144 (1999) 289-302.
558 <https://doi.org/10.1002/masy.19991440126>
- 559 [8] H. von Schenck, M. Ryner, A.-C. Albertsson, M. Svensson, Ring-Opening Polymerization of Lactones
560 and Lactides with Sn(IV) and Al(III) Initiators, *Macromolecules* 35 (2002) 1556-1562.
561 <https://doi.org/10.1021/ma011653i>
- 562 [9] N. Zhu, Z. Zhang, W. Feng, Y. Zeng, Z. Li, Z. Fang, K. Zhang, Z. Li, K. Guo, Sn (OTf)₂ catalyzed
563 continuous flow ring-opening polymerization of ϵ -caprolactone, *RSC Adv.* 5 (2015) 31554-31557.
564 <https://doi.org/10.1039/C5RA02583D>
- 565 [10] N. Zhu, Y. Liu, W. Feng, W. Huang, Z. Zhang, X. Hu, Z. Fang, Z. Li, K. Guo, Continuous flow protecting-
566 group-free synthetic approach to thiol-terminated poly (ϵ -caprolactone), *Eur. Polym. J.* 80 (2016) 234-
567 239. <https://doi.org/10.1016/j.eurpolymj.2016.04.010>

Polylactones synthesis by enzymatic ring opening polymerization in flow

- 568 [11] I. Manavitehrani, A. Fathi, H. Badr, S. Daly, A. Negahi Shirazi, F. Dehghani, Biomedical applications of
569 biodegradable polyesters, *Polymers* 8 (2016) 20. <https://doi.org/10.3390/polym8010020>
- 570 [12] I.T. Horvath, P.T. Anastas, Innovations and green chemistry, *Chem. Rev.* 107 (2007) 2169-2173.
571 <https://doi.org/10.1021/cr078380v>
- 572 [13] S. Kobayashi, Enzymatic Polymerization, *Encyclopedia of Polymer Science and Technology*.
- 573 [14] I.K. Varma, A.-C. Albertsson, R. Rajkhowa, R.K. Srivastava, Enzyme catalyzed synthesis of polyesters,
574 *Prog. Polym. Sci.* 30 (2005) 949-981. <https://doi.org/10.1016/j.progpolymsci.2005.06.010>
- 575 [15] S. Kobayashi, Enzymatic ring-opening polymerization and polycondensation for the green synthesis
576 of polyesters, *Polym. Adv. Technol.* 26 (2015) 677-686. <https://doi.org/10.1002/pat.3564>
- 577 [16] S.-i. Shoda, H. Uyama, J.-i. Kadokawa, S. Kimura, S. Kobayashi, Enzymes as Green Catalysts for
578 Precision Macromolecular Synthesis, *Chem. Rev.* 116 (2016) 2307-2413.
579 <https://doi.org/10.1021/acs.chemrev.5b00472>
- 580 [17] J.G. Venera, D. de Oliveira, S.R.S. Ferreira, J.V. Oliveira, Continuous enzymatic synthesis of
581 polycaprolactone in packed bed reactor using pressurized fluids, *Chem. Eng. Sci.* 175 (2018) 139-147.
582 <https://doi.org/10.1016/j.ces.2017.09.037>
- 583 [18] C. Ortiz, M.L. Ferreira, O. Barbosa, J.C. dos Santos, R.C. Rodrigues, Á. Berenguer-Murcia, L.E. Briand,
584 R. Fernandez-Lafuente, Novozym 435: the “perfect” lipase immobilized biocatalyst?, *Catalysis Science &*
585 *Technology* 9 (2019) 2380-2420. <https://doi.org/10.1039/C9CY00415G>
- 586 [19] H. Uyama, K. Takeya, S. Kobayashi, Enzymatic Ring-Opening Polymerization of Lactones to
587 Polyesters by Lipase Catalyst: Unusually High Reactivity of Macrolides, *Bull. Chem. Soc. Jpn.* 68 (1995)
588 56-61. <https://doi.org/10.1246/bcsj.68.56>
- 589 [20] T. Wirth, *Microreactors in organic chemistry and catalysis*, John Wiley & Sons 2013.
- 590 [21] V. Hessel, D. Kralisch, N. Kockmann, T. Noël, Q. Wang, Novel process windows for enabling,
591 accelerating, and uplifting flow chemistry, *ChemSusChem* 6 (2013) 746-789.
592 <https://doi.org/10.1002/cssc.201200766>
- 593 [22] S.G. Newman, K.F. Jensen, The role of flow in green chemistry and engineering, *Green Chem.* 15
594 (2013) 1456-1472. <https://doi.org/10.1039/C3GC40374B>
- 595 [23] L.N. Protasova, M. Bulut, D. Ormerod, A. Buekenhoudt, J. Berton, C.V. Stevens, Latest Highlights in
596 Liquid-Phase Reactions for Organic Synthesis in Microreactors, *Org. Process Res. Dev.* 17 (2013) 760-791.
597 <https://doi.org/10.1021/op4000169>

Polylactones synthesis by enzymatic ring opening polymerization in flow

- 598 [24] C. Tonhauser, A. Natalello, H. Löwe, H. Frey, Microflow technology in polymer synthesis,
599 *Macromolecules* 45 (2012) 9551-9570. <https://doi.org/10.1021/ma301671x>
- 600 [25] M.H. Reis, F.A. Leibfarth, L.M. Pitet, Polymerizations in continuous flow: recent advances in the
601 synthesis of diverse polymeric materials, *ACS Macro Lett.* 9 (2020) 123-133.
602 <https://doi.org/10.1021/acsmacrolett.9b00933>
- 603 [26] S. Kundu, A.S. Bhangale, W.E. Wallace, K.M. Flynn, C.M. Guttman, R.A. Gross, K.L. Beers, Continuous
604 flow enzyme-catalyzed polymerization in a microreactor, *J. Am. Chem. Soc.* 133 (2011) 6006-6011.
605 <https://doi.org/10.1021/ja111346c>
- 606 [27] A.S. Bhangale, K.L. Beers, R.A. Gross, Enzyme-catalyzed polymerization of end-functionalized
607 polymers in a microreactor, *Macromolecules* 45 (2012) 7000-7008. <https://doi.org/10.1021/ma301178k>
- 608 [28] X. Hu, N. Zhu, Z. Fang, K. Guo, Continuous flow ring-opening polymerizations, *React. Chem. Eng.* 2
609 (2017) 20-26. <https://doi.org/10.1039/C6RE00206D>
- 610 [29] N. Zhu, W. Huang, X. Hu, Y. Liu, Z. Fang, K. Guo, Chemoselective polymerization platform for flow
611 synthesis of functional polymers and nanoparticles, *Chem. Eng. J.* 333 (2018) 43-48.
612 <https://doi.org/10.1016/j.cej.2017.09.143>
- 613 [30] W. Huang, N. Zhu, Y. Liu, J. Wang, J. Zhong, Q. Sun, T. Sun, X. Hu, Z. Fang, K. Guo, A novel
614 microfluidic enzyme-organocatalysis combination strategy for ring-opening copolymerizations of
615 lactone, lactide and cyclic carbonate, *Chem. Eng. J.* 356 (2019) 592-597.
616 <https://doi.org/10.1016/j.cej.2018.09.033>
- 617 [31] N. Zhu, W. Huang, X. Hu, Y. Liu, Z. Fang, K. Guo, Enzymatic Continuous Flow Synthesis of Thiol-
618 Terminated Poly (δ -Valerolactone) and Block Copolymers, *Macromol. Rapid Commun.* 39 (2018)
619 1700807. <https://doi.org/10.1002/marc.201700807>
- 620 [32] K. Kaluzynski, P. Lewinski, J. Pretula, R. Szymanski, S. Penczek, ϵ -Caprolactone Polymerization
621 Catalyzed by Heteropolyacid. Derivation of the Kinetic Equation for Activated Monomer Propagation and
622 Determination of the Rate Constants of Propagation, *Macromolecules* 52 (2019) 6405-6415.
623 <https://doi.org/10.1021/acs.macromol.9b00672>
- 624 [33] W. Saiyasombat, R. Molloy, T. Nicholson, A. Johnson, I. Ward, S. Poshyachinda, Ring strain and
625 polymerizability of cyclic esters, *Polymer* 39 (1998) 5581-5585. [https://doi.org/10.1016/S0032-](https://doi.org/10.1016/S0032-3861(97)10370-6)
626 [3861\(97\)10370-6](https://doi.org/10.1016/S0032-3861(97)10370-6)

Polylactones synthesis by enzymatic ring opening polymerization in flow

- 627 [34] L. van der Mee, F. Helmich, R. de Bruijn, J.A. Vekemans, A.R. Palmans, E. Meijer, Investigation of
628 lipase-catalyzed ring-opening polymerizations of lactones with various ring sizes: Kinetic evaluation,
629 *Macromolecules* 39 (2006) 5021-5027. <https://doi.org/10.1021/ma060668j>
- 630 [35] G. Sivalingam, G. Madras, Modeling of lipase catalyzed ring-opening polymerization of ϵ -
631 caprolactone, *Biomacromolecules* 5 (2004) 603-609. <https://doi.org/10.1021/bm0344405>
- 632 [36] T.E. Gartner III, F.M. Haque, A.M. Gomi, S.M. Grayson, M.J. Hore, A. Jayaraman, Scaling exponent
633 and effective interactions in linear and cyclic polymer solutions: Theory, simulations, and experiments,
634 *Macromolecules* 52 (2019) 4579-4589. <https://doi.org/10.1021/acs.macromol.9b00600>
- 635 [37] J.N. Hoskins, S.M. Grayson, Cyclic polyesters: synthetic approaches and potential applications,
636 *Polym. Chem.* 2 (2011) 289-299. <https://doi.org/10.1039/C0PY00102C>
- 637 [38] N. Nasongkla, B. Chen, N. Macaraeg, M.E. Fox, J.M. Fréchet, F.C. Szoka, Dependence of
638 pharmacokinetics and biodistribution on polymer architecture: effect of cyclic versus linear polymers, *J.*
639 *Am. Chem. Soc.* 131 (2009) 3842-3843. <https://doi.org/10.1021/ja900062u>
- 640 [39] S. Kobayashi, Lipase-catalyzed polyester synthesis—a green polymer chemistry, *Proceedings of the*
641 *Japan Academy, Series B* 86 (2010) 338-365. <https://doi.org/10.2183/pjab.86.338>
- 642 [40] A. Kumar, R.A. Gross, *Candida antarctica* lipase B catalyzed polycaprolactone synthesis: effects of
643 organic media and temperature, *Biomacromolecules* 1 (2000) 133-138.
644 <https://doi.org/10.1021/bm990510p>
- 645 [41] H. Dong, S.G. Cao, Z.Q. Li, S.P. Han, D.L. You, J.C. Shen, Study on the enzymatic polymerization
646 mechanism of lactone and the strategy for improving the degree of polymerization, *J. Polym. Sci. Part A:*
647 *Polym. Chem.* 37 (1999) 1265-1275. [https://doi.org/10.1002/\(SICI\)1099-0518\(19990501\)37:9<1265::AID-POLA6>3.0.CO;2-I](https://doi.org/10.1002/(SICI)1099-0518(19990501)37:9<1265::AID-POLA6>3.0.CO;2-I)
- 648
- 649 [42] J.F. Carvalho, M.M. Cruz Silva, J.N. Moreira, S. Simoes, M.L. Sa e Melo, Efficient chemoenzymatic
650 synthesis, cytotoxic evaluation, and SAR of epoxyesters, *J. Med. Chem.* 52 (2009) 4007-4019.
651 <https://doi.org/10.1021/jm9003973>
- 652 [43] Z. Cabrera, G. Fernandez-Lorente, R. Fernandez-Lafuente, J.M. Palomo, J.M. Guisan, Novozym 435
653 displays very different selectivity compared to lipase from *Candida antarctica* B adsorbed on other
654 hydrophobic supports, *Journal of Molecular Catalysis B: Enzymatic* 57 (2009) 171-176.
655 <https://doi.org/10.1016/j.molcatb.2008.08.012>
- 656 [44] J. Uppenberg, N. Oehrner, M. Norin, K. Hult, G.J. Kleywegt, S. Patkar, V. Waagen, T. Anthonsen, T.A.
657 Jones, Crystallographic and molecular-modeling studies of lipase B from *Candida antarctica* reveal a

Polylactones synthesis by enzymatic ring opening polymerization in flow

- 658 stereospecificity pocket for secondary alcohols, *Biochemistry* 34 (1995) 16838-16851.
659 <https://doi.org/10.1021/bi00051a035>
- 660 [45] T. Xu, L. Zhang, E. Su, D. Cui, X. Wang, D. Wei, Disparity in productive binding mode of the slow-
661 reacting enantiomer determines the novel catalytic behavior of *Candida antarctica* lipase B, *Journal of*
662 *Molecular Catalysis B: Enzymatic* 62 (2010) 288-296. <https://doi.org/10.1016/j.molcatb.2009.11.011>
- 663 [46] A. Kundys, E. Bialecka-Florjańczyk, A. Fabiszewska, J. Malajowicz, *Candida antarctica* lipase B as
664 catalyst for cyclic esters synthesis, their polymerization and degradation of aliphatic polyesters, *J. Polym.*
665 *Environ.* 26 (2018) 396-407. <https://doi.org/10.1007/s10924-017-0945-1>
- 666 [47] M. Ganesh, R.A. Gross, Embedded enzymatic biomaterial degradation: Flow conditions & relative
667 humidity, *Polymer* 53 (2012) 3454-3461. <https://doi.org/10.1016/j.polymer.2012.06.017>
- 668 [48] Y. Poojari, J.S. Beemat, S.J. Clarson, Enzymatic synthesis of poly (ϵ -caprolactone): Thermal
669 properties, recovery, and reuse of lipase B from *Candida antarctica* immobilized on macroporous acrylic
670 resin particles, *Polymer bulletin* 70 (2013) 1543-1552. <https://doi.org/10.1007/s00289-013-0916-1>
- 671 [49] Y. Zhang, Q. Zhu, Z. Fei, X. Lin, B. Xia, Q. Wu, Stereoselectivity-tailored chemo-enzymatic synthesis
672 of enantiocomplementary poly (ω -substituted- δ -valerolactone) enabled by engineered lipase, *Eur.*
673 *Polym. J.* 119 (2019) 52-60. <https://doi.org/10.1016/j.eurpolymj.2019.07.006>
- 674 [50] D. Maniar, K.F. Hohmann, Y. Jiang, A.J. Woortman, J. van Dijken, K. Loos, Enzymatic polymerization
675 of dimethyl 2, 5-furandicarboxylate and heteroatom diamines, *Acs Omega* 3 (2018) 7077-7085.
676 <https://doi.org/10.1021/acsomega.8b01106>
- 677

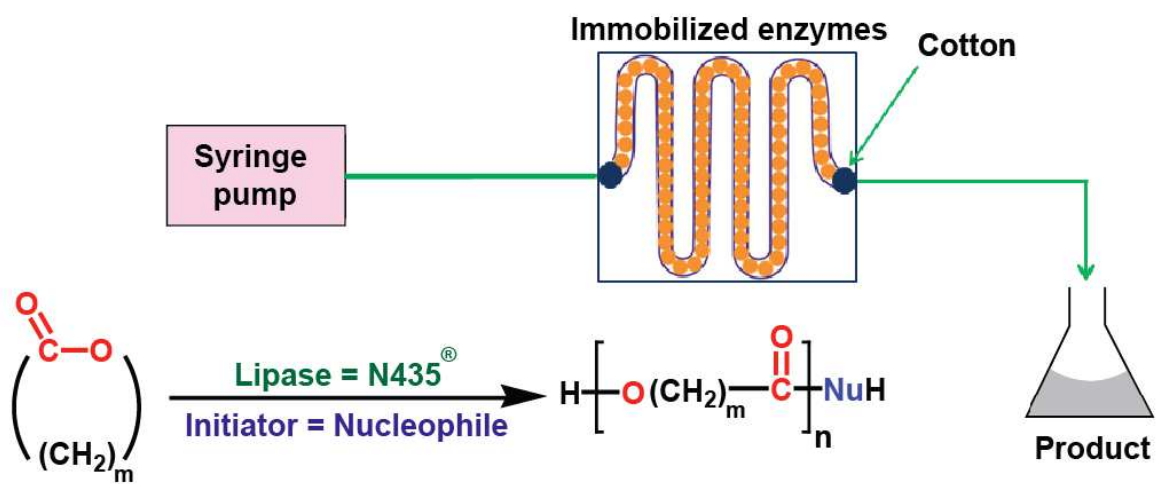

Immobilized enzymes in FEP tubing for lactone e-ROP in flow.