



HAL
open science

A Novel Emergency Controller for Quadrotor UAVs

Abdel-Razzak Merheb, Hassan Noura, Francois Bateman

► **To cite this version:**

Abdel-Razzak Merheb, Hassan Noura, Francois Bateman. A Novel Emergency Controller for Quadrotor UAVs. IEEE Conference On Control Applications (CCA), Oct 2014, Antibes, France. <10.1109/CCA.2014.6981430>. <hal-03612665>

HAL Id: hal-03612665

<https://hal.science/hal-03612665v1>

Submitted on 18 Mar 2022

HAL is a multi-disciplinary open access archive for the deposit and dissemination of scientific research documents, whether they are published or not. The documents may come from teaching and research institutions in France or abroad, or from public or private research centers.

L'archive ouverte pluridisciplinaire **HAL**, est destinée au dépôt et à la diffusion de documents scientifiques de niveau recherche, publiés ou non, émanant des établissements d'enseignement et de recherche français ou étrangers, des laboratoires publics ou privés.



HAL Authorization

A Novel Emergency Controller for Quadrotor UAVs

Abdel-Razzak Merheb¹, Hassan Noura² and François Bateman³

Abstract—In this paper, an emergency controller is developed for AscTec Pelican quadrotor suffering a severe failure in one of its motors or rotors. With one of its motors badly damaged, it is impossible to perform the control of a quadrotor using old control strategies or conventional fault tolerant control techniques. The emergency controller designed in this paper detects online any failure or fault in the quadrotor UAV motors, and whenever a severe fault (one which the Passive Fault Tolerant Sliding Mode Controller of the quadrotor cannot hold) occurs the controller applies some weight modifications so the three remaining motors are used to control the UAV as a trirotor. The controller uses a nonlinear sliding mode observer as Fault Diagnosis and Identification (FDI) unit to detect and estimate the magnitude of the fault online. SIMULINK results show that the proposed controller is fast in fault detection and successful in controlling the damaged quadrotor until it finishes its path.

I. INTRODUCTION

The increase use of UAVs in many military and civil applications emphasizes the importance of controllers with fault tolerant capabilities. Quadrotors are easy to control and powerful UAVs; with four rotors, they can carry more payload than other types of UAVs of the same weight. However, quadrotors are under-actuated systems i.e. they have less actuators than controlled variables, and any total loss or stuck of one of their motors/rotors results in a catastrophic crash. Fault tolerant control of quadrotors were the subject of many recent fault tolerant control studies [1] [2] [3] [4] [5] [6] [7]. Despite the evolution made in this field, lack of redundancy still the main problem of quadrotors that prevents any fault tolerant control to handle high fault percentages, severe damages, and total failure of actuators.

In this article, we introduced a novel emergency controller for AscTec Pelican quadrotor used when one of its motors is severely damaged or totally lost. Whenever a severe fault is detected, the new controller is responsible for applying a weight re-distribution maneuver so that the quadrotor control is performed using only three rotors, and the quadrotor continues its path as a trirotor. Because both UAV configurations are under-actuated, the loss of one actuator makes the heading of the quadrotor uncontrollable resulting in a continuous spin of the UAV around its z-axis. The Sliding

Mode Control is the core of the new controller, its inherent high reliability and robustness are used to tackle for model uncertainties, disturbances, and aerodynamic changes which rise when one of the actuators is lost. The control technique shown in this article is not to fly the quadrotor under normal conditions, but an emergency control technique that tries to use all the dynamic properties of the system and take the controls to their extreme effort. The control of a fixed-wing aircraft using unconventional control effectors was proved in two incidences. In 1989, the crew of a McDonnell Douglas DC-10 airplane was able to perform a successful emergency landing despite the loss of all hydraulics and rear engine. The pilots used throttle difference between motors 1 and 3 to steer the aircraft and land it successfully in Sioux city airport with 185 survivors out of 296 passengers [8]. In 2003, an Airbus 300 airplane was hit by an anti-aircraft missile short time after leaving Baghdad airport. With total loss of hydraulics the crew used the total thrust of motors to control the pitch angle by applying phugoid maneuver, and the throttle difference between right and left motors to control the roll angle. In a short time, the pilots learned how to control the airplane, fly it back to Baghdad airport, and performed a successful landing [9].

Trirotor design and control is a new topic for UAV researchers. Authors in [10] present the design of a tail tilt trirotor UAV system. The dynamics of the trirotor is shown, a model linearization is applied, and an optimal LQR controller is designed for the attitude angles control. Simulation results and flight tests show the performance of the new design in hovering position despite the existence of disturbance. A hybrid Two-Wheel Trirotor UAV robot is designed in [11]. Two of the rotors can be tilted to perform the total control of the system. Two control algorithms, Linear Quadratic Regulator (LQR) and PID with feedback linearization are designed for the trirotor and simulated in Simulink. Results show that the proposed controllers were successful in stabilizing and controlling the hybrid robot. In [12], the design, model, and control allocation of a single and coaxial type trirotors are introduced, and a control strategy for each type is proposed. Simulation results using a PID controller shows acceptable performance for the proposed control strategies of both type trirotors. The design and practical realization of different trirotor UAVs is shown in [13] and [14]. In [15], a two stage flight control procedure using two autonomous control subsystems to address the dynamics variation and performance requirement difference in initial and final stages of flight trajectory is proposed for a nonlinear trirotor mini-UAV. Simulink results show the good performance for the

* This research is supported by the United Arab Emirates University, Al-Ain, UAE.

¹A. Merheb is a PhD student and member of LSIS at Aix-Marseille University, France, and Lab instructor at the Lebanese International University, Lebanon abdelrazzac10@yahoo.fr

²Prof. H. Noura is the Chairman of EENG Department at United Arab Emirates University, Al Ain, UAE hnoura@uaeu.ac.ae

³François Bateman, PhD, is at the French Air Force Academy, Salon-de-Provence

proposed controller in real time search-and-rescue operations. In [16], Shahbaz et al. suggest a new highly stable design for trirotor UAV. Instead of the tail tilting mechanism responsible for yaw stabilization, two motors turning in different directions are implemented. The new design compensates air drag moments of rotors resulting in simple system dynamics and more stable design at steady state hover.

II. QUADROTOR AND TRIROTOR DYNAMICS

Trirotors and quadrotors are under-actuated UAVs that use few actuators (four in both trirotors and quadrotors) to control six variables: the coordinates x , y , and z , and the altitudes ϕ , θ , and ψ . Both systems are under-actuated, and any problem with one of the actuators causes the crash of the UAV.

Quadrotors are controlled using the thrust difference of its four rotors (Figure 1). To perform the rolling motion (rotation about x-axis), speeds of left and right rotors are made different. Pitching motion (rotation around y-axis) is achieved by setting different speeds for front and rear rotors. Heading or yawing (rotation around z-axis) is controlled by the difference between the sum of speeds of front and rear with respect to left and right rotors. The height of the quadrotor is controlled by the total thrust of the four rotors.

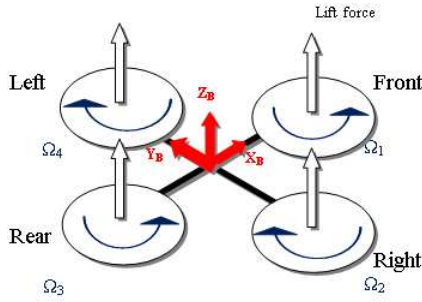
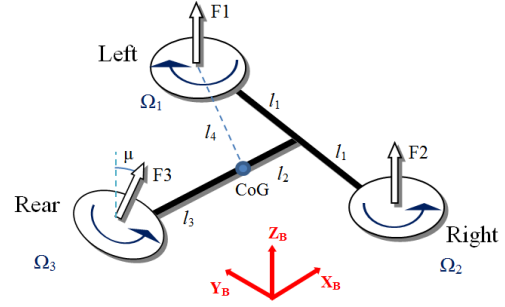
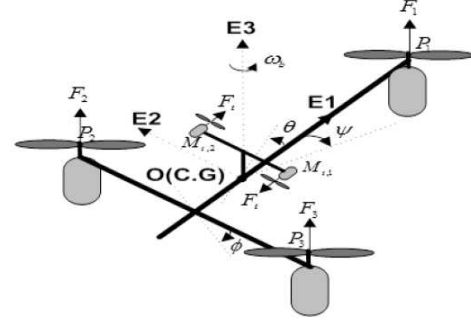

Fig. 1: Quadrotor schematic.

Trirotor UAV's are controlled using only three rotors as shown in (Figure 2). Here also motion is achieved using the differences between motor thrusts. The difference between left rotor and the sum of left and rear rotors speeds controls rolling rotation, and difference between speeds of front rotors (left and right rotors) and the rear rotor controls pitching rotation. The height of trirotors is controlled similar to quadrotors by the total thrust of the three rotors. The yaw angle in trirotors is controlled in different ways. One way to control the yaw angle is to allow the third rotor (tail rotor) to tilt around x-axis which generates a torque around the center of gravity [10]. Another simpler and less noisy way to perform the pitch rotation is to use two small motors with rotors connected in opposite direction, parallel to the axis holding the left and right rotors [16]. Here, the drag difference between the two motors results in yaw motion. A different way to control the Yaw angle is to have rotor 1 and rotor 2 with tilting mechanisms, while rotor 3 is fixed [11]. Without using one of the mechanisms stated previously, it is impossible to us to control the Yaw angle (heading) of the



(a) Trirotor with tilting mechanism for Yaw control.



(b) Trirotor with two opposite motors for Yaw control [16].

Fig. 2: Trirotor schematic.

Trirotor, and the UAV spins around z-axis in the direction and speed of the resultant torque of its three rotors.

The dynamics of quadrotor and trirotor UAVs are similar and have the following equations ([16] and [17])

$$\ddot{x} = \frac{U_1}{m} \cdot (\sin\psi \cdot \sin\phi + \cos\psi \cdot \sin\theta \cdot \cos\phi) - \frac{K_{ftx}}{m} \cdot \dot{x} \quad (1)$$

$$\ddot{y} = \frac{U_1}{m} \cdot (-\cos\psi \cdot \sin\phi + \sin\psi \cdot \sin\theta \cdot \cos\phi) - \frac{K_{fity}}{m} \cdot \dot{y} \quad (2)$$

$$\ddot{z} = \frac{U_1}{m} \cdot \cos\theta \cdot \cos\phi - \frac{K_{ftz}}{m} \cdot \dot{z} - g \quad (3)$$

$$\ddot{\phi} = \frac{I_y - I_z}{I_x} \cdot \dot{\theta} \cdot \dot{\psi} + \frac{I_{rotor}}{I_x} \cdot \dot{\theta} \cdot \dot{\gamma} - \frac{K_{fax}}{I_x} \cdot \dot{\phi}^2 + \frac{l \cdot U_2}{I_x} \quad (4)$$

$$\ddot{\theta} = \frac{I_z - I_x}{I_y} \cdot \dot{\phi} \cdot \dot{\psi} - \frac{I_{rotor}}{I_y} \cdot \dot{\phi} \cdot \dot{\gamma} - \frac{K_{fay}}{I_y} \cdot \dot{\theta}^2 + \frac{l \cdot U_3}{I_y} \quad (5)$$

$$\ddot{\psi} = \frac{I_x - I_y}{I_z} \cdot \dot{\phi} \cdot \dot{\theta} - \frac{K_{faz}}{I_z} \cdot \dot{\psi}^2 + \frac{U_4}{I_z} \quad (6)$$

K_{fax} , K_{fay} , and K_{faz} are the aerodynamic friction coefficients; K_{ftx} , K_{fity} , and K_{ftz} are the coefficients of the translation drag forces affecting the coordinates of the quadrotor. The quadrotor constants such as its moments of inertia, friction and drag forces coefficients, mass, drag and thrust factor, along with the motor speed bounds are given by the manufacturer of Pelican quadrotor and can be found in [7]. Because no sensor is implemented on the motors, it is impossible from a practical point of view to measure the speed of each motor (however prediction is possible using observers). This means that the value of γ ($\gamma = U_1 - U_2 + U_3 - U_4$) is not available for the controller of the quadrotor, and the term $\frac{I_{rotor}}{I_i} \cdot \dot{\gamma} \cdot \dot{\gamma}$ with $i = x, y$, and

$j = \phi, \theta$ cannot be used in the controller design. This is why we assume the effect of γ as disturbance, well known for us but impossible to measure practically.

By taking the state vector as $X = [x \dot{x} y \dot{y} z \dot{z} \phi \dot{\phi} \theta \dot{\theta} \psi \dot{\psi}]^t$, the dynamics of the UAV can easily be expressed in the state space form

$$\dot{X} = f(X) + g(X).u(t) \quad (7)$$

Where $u(t) = [U_1 U_2 U_3 U_4]^t$ is the control input.

The main difference between quadrotor and trirotor UAVs is in the relation between their controls U_1, U_2, U_3, U_4 and the speeds of their rotors. Moreover, the main structural difference between the two UAV's is in the position of their Centers of Gravity (CoG). While the quadrotor has its CoG right in the mid-point between motor 1 - motor 3 and motor 2 - motor - 4, the trirotor has its CoG closer to the rear motor. This allows the trirotor to perform the Pitch motion by changing the thrust difference between front and rear motors. If the CoG were in the middle, the torques of front motors are zeros, and no rotation around y-axis is possible.

For the quadrotor UAV, the controls are presented by the speeds of the four rotors as

$$U_1 = b.(\Omega_1^2 + \Omega_2^2 + \Omega_3^2 + \Omega_4^2) \quad (8)$$

$$U_2 = b.l.(-\Omega_2^2 + \Omega_4^2) \quad (9)$$

$$U_3 = b.l.(-\Omega_3^2 + \Omega_1^2) \quad (10)$$

$$U_4 = d.(-\Omega_1^2 + \Omega_2^2 - \Omega_3^2 + \Omega_4^2) \quad (11)$$

Where Ω_i with $i = 1, 2, 3, 4$ is the speed of motor i , l is the distance between the CoG of the quadrotor and the center of each rotor, and b and d are respectively the thrust and drag factors of the quadrotor. The relation between rotor speeds and trirotor controls with tail tilting mechanism are [10]

$$U_1 = b.(\Omega_1^2 + \Omega_2^2) + b.\Omega_3^2 \cos(\mu) \quad (12)$$

$$U_2 = b.l_1.(\Omega_1^2 - \Omega_2^2) \quad (13)$$

$$U_3 = b.l_2.(\Omega_1^2 + \Omega_2^2) - b.l_3.\Omega_3^2 \cos(\mu) \quad (14)$$

$$U_4 = d.l_4.(-\Omega_1^2 + \Omega_2^2) + l_3.d.\Omega_3^2 + b.l_3.\Omega_3^2 \sin(\mu) \quad (15)$$

Where μ is the angle of the tail rotor controlled with the tilting mechanism as shown in figure (2).

III. CONTROLLING QUADROTORS AS TRIROTORS

A. Quadrotors Used As Trirotors

Without the tilting mechanism, it is impossible to control the yaw angle of the trirotor. However, even without controlling the heading of the trirotor, it is still possible to control the remaining attitude variables (roll and pitch angles) and displacement variables (x , y , and z) of the trirotor. This means that the trirotor is still able to follow a given path but with uncontrolled yaw. Without the tilting mechanism, the angle μ between the axis of the third rotor and the y-axis is always zero, and the trirotor control-motor speed relations are simplified by setting $\cos(\mu) = 1$ and $\sin(\mu) = 0$ in the equations (12) to (15). To study the ability to control a

quadrotor as trirotor, we compare both UAV schematics in Figure (1) and Figure (2). The main difference between both UAVs is in the location of their centers of gravity (CoG). While the quadrotor has its CoG right in the middle point of its diagonal intersection, the trirotor has its CoG shifted towards the rear rotor. This is essential for the trirotor to perform the pitch angle. If the CoG were in the middle of the right-left rotors axis and l_2 is zero, both left and right rotors torques will be zero and the thrust of only rotor 3 controls the pitch angle or $U_3 = -b.l_3.\Omega_3^2$ (equation (14) with $\cos(\mu) = 1$). This means that if we want to increase the control U_3 rotor 3 should turn in opposite direction which is inapplicable. As a conclusion, to use the quadrotor as trirotor and perform its control using only three rotors it is essential that its Center of Gravity is shifted towards the rear rotor. This is possible by increasing the weight of one of the rotors and using it as tail rotor, while the opposite rotor is turned off (figure (3)).

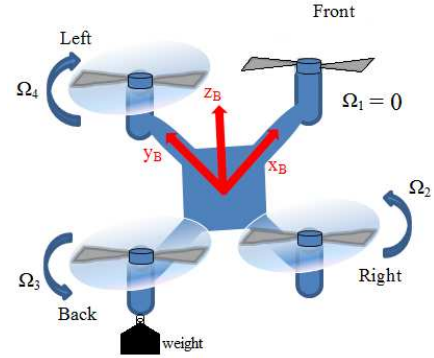

Fig. 3: Shifting the CoG of the quadrotor towards the tail rotor.

B. Different Quad/Tri Configurations

In figure (3), the front motor is turned off while a weight is added to the rear rotor in order to shift the CoG backward and ensure the control of the pitch angle. If on the other hand the right motor is turned off, the left motor becomes the rear motor of the new trirotor, and the weight should be added to the left motor. Note that the controller used in the previous configuration (when front motor of the quadrotor is turned off) can no longer be used with the new configuration (right motor is off) because the definition of the rear and front motors has totally changed. It is important to emphasize that controlling the quadrotor as trirotor requires the design of four different controllers as shown in figure (4). This is essential because with different rotors turned off, the definition of the left, right, and rear rotors change. Tables I and II show the main differences between the four controllers. If the first rotor is turned off, rotor 4 will be the left rotor, rotor 2 is the right rotor, and the rear rotor is rotor 3. Here, x , y , and z axes of the trirotor coincide with the axes of the quadrotor. On the other hand, if rotor 2 is turned off, left rotor will be rotor 1, right rotor is rotor 3, and rear rotor is rotor 4. Here x -axis of the quadrotor is y -axis of the trirotor and vice versa. Now, if we intend to turn

TABLE I: Angle change from Quadrotors to Trirotors

| Rotor off | Roll | Pitch | Yaw |
|-----------|----------|----------|--------|
| Rotor 1 | ϕ | θ | ψ |
| Rotor 2 | θ | ϕ | ψ |
| Rotor 3 | ϕ | θ | ψ |
| Rotor 4 | θ | ϕ | ψ |

TABLE II: Rotor change from Quadrotors to Trirotors

| Rotor off | Left rotor | Right rotor | Rear rotor |
|-----------|------------|-------------|------------|
| Rotor 1 | R4 | R2 | R3 |
| Rotor 2 | R1 | R3 | R4 |
| Rotor 3 | R2 | R4 | R1 |
| Rotor 4 | R3 | R1 | R2 |

around x-axis of the trirotor, it is rotor1 and rotor3 of the quadrotor that need to be set with different thrusts. All these changes should be taken into consideration while designing the controllers.

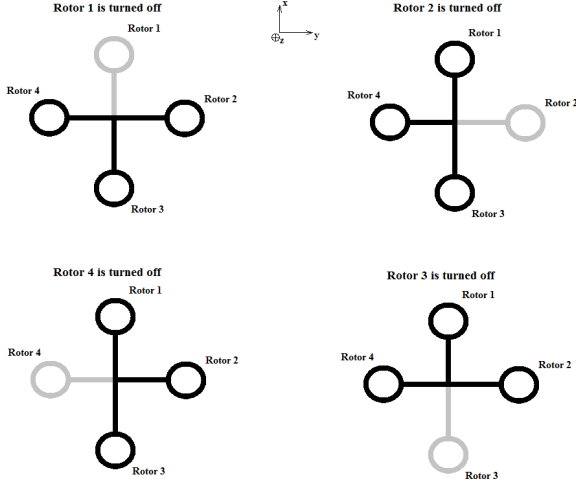

Fig. 4: Different configurations of the quadrotor used as trirotor.

If Rotor 1 is damaged and turned off, the controls-speeds relation of the trirotor will be

$$U_1 = b.(\Omega_4^2 + \Omega_2^2 + \Omega_3^2) \quad (16)$$

$$U_2 = b.l_1.(\Omega_4^2 - \Omega_2^2) \quad (17)$$

$$U_3 = b.l_2.(\Omega_4^2 + \Omega_2^2) - b.l_3.\Omega_3^2 \quad (18)$$

$$U_4 = d.l_4.(-\Omega_4^2 + \Omega_2^2) + l_3.d.\Omega_3^2 \quad (19)$$

If Rotor 2 is turned off, the controls-speeds relation of the trirotor will be

$$U_1 = b.(\Omega_1^2 + \Omega_3^2 + \Omega_4^2) \quad (20)$$

$$U_2 = b.l_1.(\Omega_1^2 - \Omega_3^2) \quad (21)$$

$$U_3 = b.l_2.(\Omega_1^2 + \Omega_3^2) - b.l_3.\Omega_4^2 \quad (22)$$

$$U_4 = d.l_4.(-\Omega_1^2 + \Omega_3^2) + l_3.d.\Omega_4^2 \quad (23)$$

If Rotor 3 is turned off, the controls-speeds relation of the trirotor will be

$$U_1 = b.(\Omega_2^2 + \Omega_4^2 + \Omega_1^2) \quad (24)$$

$$U_2 = b.l_1.(\Omega_2^2 - \Omega_4^2) \quad (25)$$

$$U_3 = b.l_2.(\Omega_2^2 + \Omega_4^2) - b.l_3.\Omega_1^2 \quad (26)$$

$$U_4 = d.l_4.(-\Omega_2^2 + \Omega_4^2) + l_3.d.\Omega_1^2 \quad (27)$$

If Rotor 4 is turned off, the controls-speeds relation of the trirotor will be

$$U_1 = b.(\Omega_3^2 + \Omega_1^2 + \Omega_2^2) \quad (28)$$

$$U_2 = b.l_1.(\Omega_3^2 - \Omega_1^2) \quad (29)$$

$$U_3 = b.l_2.(\Omega_3^2 + \Omega_1^2) - b.l_3.\Omega_2^2 \quad (30)$$

$$U_4 = d.l_4.(-\Omega_3^2 + \Omega_1^2) + l_3.d.\Omega_2^2 \quad (31)$$

Where Ω_i is the speed of rotor i . Note that when rotor i is damaged, it is enough to shift the CoG of the UAV 5 cm towards rotor i . This is done using pre-installed weights under each motor. Whenever a motor loses effectiveness (is infected by a severe fault) all the weights are released except the one opposite to the infected motor (using solenoid or motor mechanisms) shifting the CoG towards the opposite motor so the corresponding trirotor controller is applicable (the same maneuver could be done by releasing the weight under only the infected motor/rotor).

IV. SLIDING MODE CONTROL OF QUADROTOR AND TRIROTOR

In this paper, we used the quadrotor Passive Fault Tolerant Sliding Mode Controller (PFTSMC) developed in [7]. The PFTSMC of the quadrotor has the following equation

$$u = g^{-1}(X). \left[\dot{X}_d + c.e - f(X) \right] - k.sat(s) \quad (32)$$

Where $c = diag([c_z; c_\phi; c_\theta; c_\psi])$ is a positive gain matrix, and $k = [k_z \ k_\phi \ k_\theta \ k_\psi]$ is a positive gain vector affecting the conversion speed of the discontinuous control. The optimal values of c and k along with the stability test of the controller can be found in [17]. Note that the same controller is suitable for trirotor control as well since it has the same dynamics as the quadrotor UAV. Sliding Mode Controller (SMC) is essential for the trirotor control because we need a powerful controller able to handle disturbances and aerodynamic changes which rise from the improper use of the quadrotor.

V. DESIGN OF SLIDING MODE OBSERVER

A Sliding Mode Observer is designed for the quadrotor to estimate the loss of effectiveness fault magnitude affecting the motors. The equations of the Sliding Mode Observer are

$$\dot{\tilde{X}} = f(\tilde{X}) + g(\tilde{X}).u(t) + v(t) + L.(Y - \tilde{Y}) \quad (33)$$

$$\tilde{Y} = C.\tilde{X} \quad (34)$$

Where \tilde{Y} is the observed output of the system, $C^{1 \times 12}$ is a constant vector with all its elements alternating between one

and zero, $v(t)$ is the time-varying estimation function of the fault, and L is the observer gain vector with

$$L = \frac{f(X) - f(\tilde{X}) + [g(X) - g(\tilde{X})] \cdot u}{e_y} + \eta \quad (35)$$

Where $e_y = Y - \tilde{Y}$, η is a positive design parameter affecting the convergence speed of the output error to zero, and $v = v_{eq} + v_{dis}$ with

$$v_{eq} = f(X) - f(\tilde{X}) + [g(X) - g(\tilde{X})] \cdot u - L \cdot e_y + f(t) \quad (36)$$

and

$$v_{dis} = -K \cdot \text{sat}(S) \quad (37)$$

K is the gain affecting the conversion speed of v_{dis} . By trial and error, K_i is found as $K_\phi = K_\theta = K_\psi = 0.05$, and $K_x = K_y = K_z = 0.1$. More on the development of the Sliding Mode Observer can be found in [17]. Now, we are able to estimate the states of the faulty system using the sliding mode observer of equation (33). When the observer reaches the sliding surface, the equivalent part of the estimation term converges to the fault magnitude $v_{eq} \rightarrow f(t)$, the observed states converge to their actual values $\tilde{X} \rightarrow X$, and the observer error becomes zero. Therefore, it is possible for us to reconstruct the fault based on v_{eq} values. We construct a look-up table for v_{eq} values based on well-known fault magnitudes injected to the sliding mode controlled system. To find the magnitude of any fault, it is now enough to measure v_{eq} and use the look-up table.

VI. EMERGENCY CONTROL OF QUADROTOR

In this section, an emergency controller for the quadrotor is developed based on the quadrotor to trirotor conversion maneuver. Whenever the observer detects a fault greater than 40% (the Passive SMC of the quadrotor can handle up to 55% faults [7]), the quadrotor switches to the trirotor controller after turning off the infected motor and making the relevant weight redistribution. The challenge is to make all these steps as short as possible so the quadrotor recovers before it crashes or becomes uncontrollable. To perform the controller change, a controller switching unit is designed. The switch receives input from the PFTSMC, and whenever a severe fault notification is received from the observer it makes the control re-direction and sends the new commands to the quadrotor. When the conversion maneuver is applied, the quadrotor keeps following its desired path but with uncontrolled yaw angle. This is an undesired control behavior but affordable to prevent the crash of the quadrotor and travel it to the nearest landing zone. Weight re-distribution shifts the center of gravity towards the rear rotor. Without this step, it will be impossible to control the pitch angle of the UAV and the quadrotor will crash as soon as one of its motors is severely damaged. To realize this step, an extra weight is attached under each rotor. With equal weights added, the center of gravity of the quadrotor remains at the same position, and the sum of the new weights are added to the quadrotor's total weight. When one of the

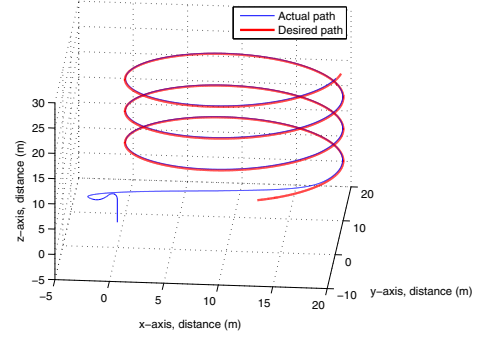

(a) Quadrotor path

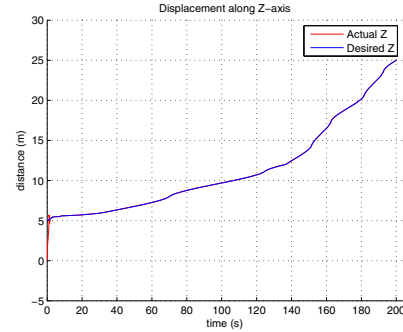

(b) Quadrotor height

Fig. 5: Quadrotor path and height (Damage of fourth rotor).

rotors is severely damaged, the observer detects the damage, sends a command to the controller switch, and sends another command to a solenoid mechanism to open and throw the extra weight under the damaged rotor (now assumed as head rotor). This shifts the center of gravity towards the tail rotor. The proposed controller is used in Simulink to control the quadrotor performing a helical path in space for 200 seconds where a severe fault is injected at $t = 135s$. Tests with different rotors damage show that the proposed maneuver was successful in maintaining the quadrotor on its path despite the severe damage or stop of one of its rotors. Figures (5) to (7) show the path followed, the height and angles response, and the rotor speeds of the quadrotor before and after the severe damage of the fourth rotor. At the start, the quadrotor exhibits oscillations in rotor speeds caused by the extra weight added. More powerful motors could be used, or less weight could be added in order to get rid of these oscillations.

VII. CONCLUSION

In this paper, an emergency controller is designed for quadrotors suffering a severe damage in one of their rotors. The controller is based on quadrotor to trirotor conversion concept. Four SMC controllers are designed to control the quadrotor as trirotor with one of its rotors turned off. A sliding mode observer is then designed to play the role of an FDI unit; it detects motor/rotors faults and estimates their magnitudes. Whenever a rotor suffers a fault that approaches the limits of the Passive Fault Tolerant SMC of the quadrotor,

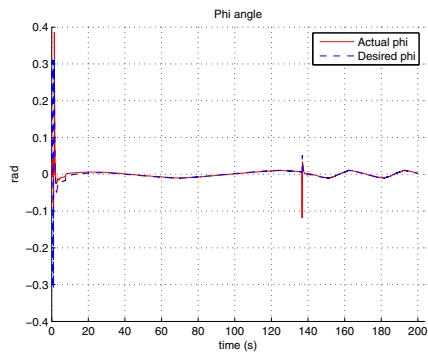

(a) Phi angle

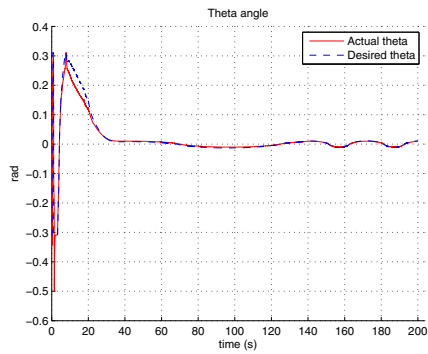

(b) Theta angle

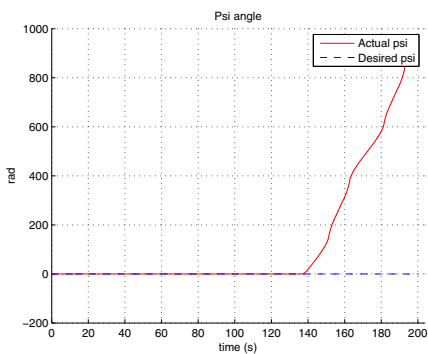

(c) Psi angle

Fig. 6: Attitude of the quadrotor (Damage of fourth rotor).

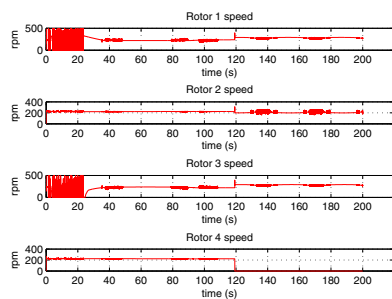

Fig. 7: Rotor speeds of the quadrotor (Damage of fourth rotor).

this rotor is turned off, the suitable controller is switched on, weight re-distribution is applied, and the quadrotor

continues its path as trirotor but with uncontrollable heading. SIMULINK results show that even with total damage of one of the rotors, the UAV was able to continue its path as desired. Future work includes the addition of wind gust and turbulence along with sensor noise, and the practical application of this controller on real quadrotors.

REFERENCES

- [1] I. Sadeghzadeh and Y. Zhang, "A review on fault-tolerant control for unmanned aerial vehicles (uavs)," in *INFOTECH@AEROSPACE 2011 Conference, AIAA*, St. Louis, Missouri, USA, March 2011.
- [2] T. Li, Y. Zhang, and B. W. Gordon, "Passive and active nonlinear fault-tolerant control of a quadrotor unmanned aerial vehicle based on the sliding mode control technique," *Proceedings of the Institution of Mechanical Engineers, Part I: Journal of Systems and Control Engineering published online*, October 2012.
- [3] H. Alwi and C. Edwards, "Fault tolerant control using sliding modes with on-line control allocation," *Automatica*, vol. 44, pp. 1859–1866, April 2008.
- [4] U. Demirci and F. Kerestecioglu, "Fault tolerant control with re-configuring sliding-mode schemes," *Turk J Elec Engin*, vol. 13, no. 1, 2005.
- [5] F. Sharifi, M. Mirzaei, B. Gordon, and Y. Zhang, "Fault tolerant control of a quadrotor uav using sliding mode control," in *Conference on Control and Fault Tolerant Systems (2010)*, Nice, France, October 2010, pp. 239–244.
- [6] Y. Zhang and A. Chamseddine, "Fault tolerant flight control techniques with application to a quadrotor uav testbed," in *Automatic Flight Control Systems - Latest Developments*, D. T. Lombaerts, Ed., no. 5. InTech, 2012, pp. 119–150.
- [7] A. Merheb, H. Noura, and F. Bateman, "Passive fault tolerant control of quadrotor uav using regular and cascaded sliding mode control," in *The second International Conference on Control and Fault-Tolerant Systems (SysTol'13)*, Nice, France, October 2013.
- [8] Y. Hitachi, *Damage-Tolerant Flight Control System Design for Propulsion-Controlled Aircraft*, Master thesis, Graduate Department of Aerospace Science and Engineering, University of Toronto, Toronto, Canada, 2009.
- [9] J. Rosay, *Baghdad A300 Incident Discussion*, Airbus Customer Services, Airbus, October 2004.
- [10] S. Yoon, S. Lee, B. Lee, C. Kim, Y. Lee, and S. Sung, "Design and flight test of a small trirotor unmanned vehicle with a lqr base onboard attitude control system," *International Journal of Innovative Computing, Information and Control*, vol. 9, no. 6, p. 2347 – 2360, 2013.
- [11] H. Alwafi, K. Arkan, and B. İrfanoğlu, "Attitude and altitude control of two wheel trirotor hybrid robot," *International Journal of Scientific Knowledge, Computing and Information Technology*, vol. 2, no. 1, p. 42 – 56, 2013.
- [12] D. Yoo, H. Oh, D. Won, and M. Tahk, "Dynamic modeling and stabilization techniques for tri-rotor unmanned aerial vehicles," *International Journal of Aeronautical and Space Sciences*, vol. 3, no. 11, p. 167 – 174, 2010.
- [13] A. Rys, R. Czyba, and G. Szafranski, "Practical aspects of trirotor mav development," in *International Micro Air Vehicle conference and competitions (IMAV 2011)*, 't Harde, The Netherlands, September 2011.
- [14] J. Cristofol, Y. Hertienne, M. Lafleur, B. Verguet, and S. Vitu, "Tri-rotors uav stabilization for vertical takeoff and hovering," in *16th International Conference on Mechatronics Technology*, Tianjin, China, OCTOBER 2012.
- [15] I. Astrov and A. Pedai, "Flight control of a trirotor mini-uav for enhanced situational awareness," in *International Conference on Aeronautical and Astronautical Engineering (ICAAE 2010)*, Amsterdam, Netherlands, September 2010.
- [16] A. Haider and M. Sajjad, "Structural design and non-linear modeling of a highly stable multi-rotor hovercraft," *IISTE*, vol. 2, no. 4, p. 24 – 35, 2012.
- [17] A. Merheb, H. Noura, and F. Bateman, "Active fault tolerant control of quadrotor uav using sliding mode control," in *International Conference on Unmanned Aircraft Systems (ICUAS'14)*, Orlando, Florida, USA, May 2014.