



HAL
open science

Fast optical recording of neuronal activity by three-dimensional custom-access serial holography

Walther Akemann, Sébastien Wolf, Vincent Vilette, Benjamin Mathieu,
Astou Tangara, Jozsua Fodor, Cathie Ventalon, Jean-François Léger,
Stéphane Dieudonné, Laurent Bourdieu

► To cite this version:

Walther Akemann, Sébastien Wolf, Vincent Vilette, Benjamin Mathieu, Astou Tangara, et al.. Fast optical recording of neuronal activity by three-dimensional custom-access serial holography. *Nature Methods*, 2022, 19 (1), pp.100-110. 10.1038/s41592-021-01329-7 . hal-03606564

HAL Id: hal-03606564

<https://hal.science/hal-03606564v1>

Submitted on 11 Mar 2022

HAL is a multi-disciplinary open access archive for the deposit and dissemination of scientific research documents, whether they are published or not. The documents may come from teaching and research institutions in France or abroad, or from public or private research centers.

L'archive ouverte pluridisciplinaire **HAL**, est destinée au dépôt et à la diffusion de documents scientifiques de niveau recherche, publiés ou non, émanant des établissements d'enseignement et de recherche français ou étrangers, des laboratoires publics ou privés.

Fast Optical Recording of Neuronal Activity by 3D Custom-Access Serial Holography

Walther Akemann¹, Sébastien Wolf^{1,2,*}, Vincent Villette^{1,*}, Benjamin Mathieu^{1,*},
Astou Tangara¹, Jozsua Fodor¹, Cathie Ventalon¹,
Jean-François Léger^{1,#}, Stéphane Dieudonné^{1,#,+}, Laurent Bourdieu^{1,#,+}

¹Institut de Biologie de l'ENS (IBENS), École Normale Supérieure, CNRS, INSERM

²Laboratoire de Physique de l'ENS (LPENS), École Normale Supérieure, CNRS

Université PSL, 75005 Paris, France

*) contributed equally

#) shared senior authorship

+) corresponding authors

Correspondence:

laurent.bourdieu@ens.fr

stephane.dieudonne@ens.fr

1 **Abstract**

2 Optical recording of neuronal activity in 3D brain circuits at cellular and millisecond resolution
3 *in-vivo* is essential for probing information flow in the brain. While random-access
4 multiphoton microscopy permits fast optical access to neuronal targets in 3D, the method is
5 challenged by motion artefacts when recording from behaving animals. Therefore, we
6 developed 3D custom-access serial holography (3D-CASH). Built upon a fast acousto-optic light
7 modulator, 3D-CASH performs serial sampling at 40 kHz from neurons at freely selectable 3D
8 locations. Motion artefacts are eliminated by targeting each neuron with a size-optimized
9 pattern of excitation light covering the cell body and its anticipated displacement field. Spike
10 rates inferred from GCaMP6f recordings in visual cortex of awake mice tracked the phase of a
11 moving bar stimulus with higher spike correlation between intra- compared to inter-laminar
12 neuron pairs. 3D-CASH offers access to the millisecond correlation structure of *in-vivo*
13 neuronal activity in 3D microcircuits.

14

15 **Introduction**

16 Large scale *in-vivo* imaging of neuronal activity^{1,2} using multi-photon microscopy aims to
17 decipher neural encoding and processing in distributed brain circuits during animal behaviors.
18 However, the 3D structure of neuronal circuits operating on a time scale of milliseconds poses
19 problem to conventional scanning microscopy as volumetric and millisecond acquisition are
20 difficult to reconcile³. Volumetric multi-plane imaging⁴⁻⁸ is limited to low sampling rates and
21 low axial sampling densities as voxel acquisition is ultimately limited by the laser pulse rate.
22 Spatial excitation multiplexing⁹⁻¹³ improves 3D sampling, but extensive multiplexing degrades
23 the signal-to-noise ratio, through accumulation of background fluorescence, and escalates
24 brain heating^{14,15}.

25 Random-access multiphoton (RAMP) acquisition is a way to speed up sampling from
26 distributed objects beyond image scanning^{16,17}. RAMP targets a sequence of disjointed points
27 of interest (POIs) in a non-contiguous 3D scan raster and thereby truncates spatial sampling
28 for accelerated sampling in the time domain. 3D-RAMP has been implemented with acousto-
29 optic deflectors (AODs), which control the 3D position of the excitation focus through tilt and
30 defocus phase modulation of the scan beam¹⁸. RAMP recordings, however, were limited to *in-*
31 *vitro* preparations^{17,19,20} and to anesthetized animals²¹⁻²³, as recordings in awake animals
32 suffered from brain motion-induced recording artefacts. To alleviate this problem, dedicated

33 AOD scan modes, such as patch scan^{21,22} and scan of 3D hyper-surfaces²⁴, were deployed to
34 acquire sufficient spatial information for *post-hoc* movement correction, but at the expense
35 of temporal resolution. A recent solution to this problem applied on-line motion correction by
36 tracking reference objects and adjusting the scan coordinates of an AOD-scanner in real
37 time²⁵.

38 Here, we demonstrate a robust solution to the problem of motion artefacts in 3D-
39 RAMP without interleaved imaging of reference objects, therefore offering faster sampling
40 from neuronal populations. Previously, we demonstrated acousto-optic light modulation by a
41 single pair of XY-AODs²⁶. Here, we implement acousto-optic pulse-to-pulse light patterning
42 and present a microscope for 3D-RAMP with holographic shaping of the two-photon
43 excitation volume at 40 kHz. Using 3D custom-access serial holography (3D-CASH), we show
44 that targeting single cells with an extended focus pattern imparts tolerance against tissue
45 motion, while boosting the fluorescence yield. We illustrate 3D-CASH in recordings at high
46 data throughput (20000 neurons per second) and high sampling rate (> 200 Hz) of GCaMP6f-
47 expressing cortical neurons in layers 2/3 and 5 of primary visual cortex in behaving mice on a
48 treadmill.

49

50 **Results**

51 **Design of the 3DScope**

52 The 3DScope (Fig. 1 and Extended Data Fig. 1) combines a 40 kHz chirped pulse laser amplifier,
53 followed by a parametric wavelength converter (800-1300 nm), with two AODs (X-AOD and Y-
54 AOD) of 15 mm aperture size and 23 μ s cycle time. In each AOD, the laser beam is Bragg-
55 diffracted from a 3D acousto-optic (AO) density grating formed by a propagating planar
56 acoustic wave in a birefringent crystal. AO wave generation is carried out in a time-locked
57 mode²⁶, in which frequency and amplitude-modulated (FM/AM) waves are generated under
58 control of the laser clock and written anew for every laser pulse (Supplementary Fig. 1). This
59 synchronous mode abolishes the focus drift associated with chirped AO gratings in earlier
60 AOD-based 3D microscopes in asynchronous mode^{20,22,27} and permits pulse-to-pulse linear
61 (tilt) and quadratic (defocus) phase modulation for 3D access in sample space (Fig. 1a), as well
62 as phase modulations of higher order (Supplementary Fig. 2).

63

64

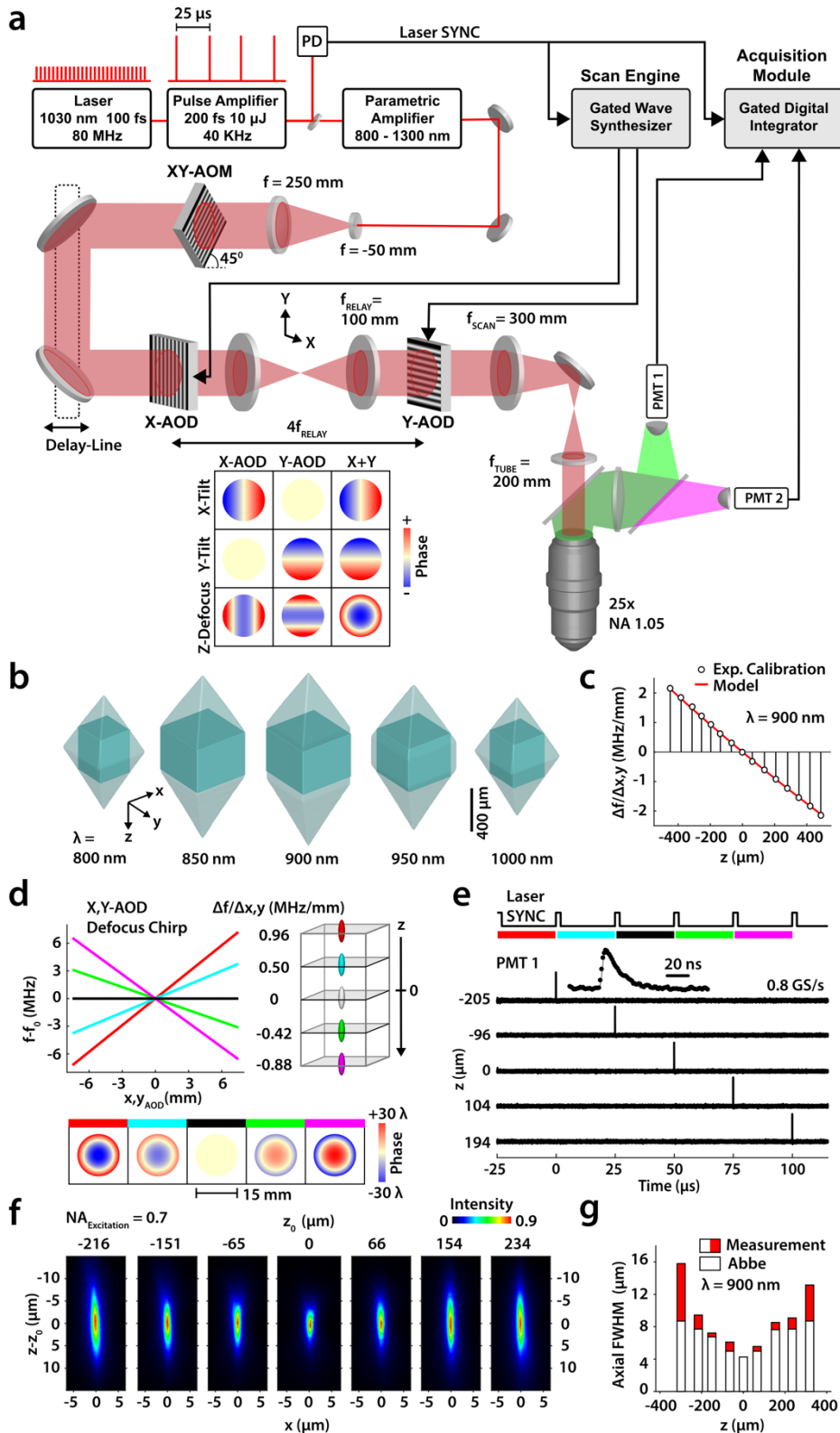

65

66 **Fig. 1 Principle of the 3DScope**

67 The 3DScope is a mirror-less scanning microscope for multi-photon excitation with full-frame, micro-frame and
 68 random address scan modes. **(a)** Schematic of the microscope: photo-multiplier tube (PMT), photodiode (PD),
 69 focal length (f), acousto-optic modulator (AOM), acousto-optic deflector (AOD), numerical aperture (NA) and
 70 laser emission synchronous timing signal (SYNC). Inset: Cartoon of spatial light modulation (x-tilt, y-tilt and z-

71 defocus) by an X-AOD/Y-AOD tandem in 4f-configuration. **(b)** Total addressable 3D volume (semi-transparent)
72 with embedded cuboid sub-volume of 400 μm height (solid color) modeled for a 25x objective. **(c)** Measured
73 (black circles) and modelled (red line) calibration at 900 nm of AO linear frequency chirps producing z defocus
74 up to $\pm 500 \mu\text{m}$ from the objective focal plane ($z = 0$). **(d)** Linear frequency chirps of -0.88 to +0.96 MHz/mm (left)
75 together with resulting defocus phase modulation (0.75, 1.44, 0, -1.72 and -0.82 m defocus, respectively;
76 bottom), same for both AODs, with each pulse targeting different depth (right). **(e)** Fluorescence measurement
77 of a color plastic slide (500 nm thick) placed at axial target distances between -205 and +194 μm . For each target
78 distance the defocus series (d) is repeated with every pulse given a different defocus chirp. Inset: detector signal
79 at extended scale. **(f)** Maximum projection of the measured point-spread function (PSF) in the x-z plane for
80 frequency chirps, from left to right, of 1.2, 0.77, 0.39, 0, -0.39, -0.77, -1.2 MHz/mm. **(g)** Full width at half
81 maximum (FWHM) of the measured axial PSF (white and red bars combined) for axial targets at -400 to +400 μm
82 and expected FWHM from an ideal Abbe objective (white bar).

83

84 The addressable volume is delimited by a bipyramidal boundary set by the AOD frequency
85 bandwidth and the laser wavelength (Fig. 1b), offering a 500 x 500 μm^2 field of view under 25x
86 objective magnification (Supplementary Fig. 3a). The measured axial focus shift is a linear
87 function of the acoustic wave frequency chirp in agreement with the theory (Fig. 1c). We
88 demonstrate pulse-to-pulse phase modulation by subjecting five consecutive laser pulses to
89 AO frequency ramps of different slopes (Fig. 1d), which resulted in each pulse being focused
90 to a different plane, about 100 μm apart (Fig. 1e). At zero chirp the point-spread function (PSF)
91 had an axial full width at half maximum (FWHM) of $4.2 \pm 0.8 \mu\text{m}$ (Supplementary Fig. 3b)
92 consistent with a reduced excitation numerical aperture ($\text{NA}_{\text{ex}} 0.7$). In the presence of chirp,
93 the FWHM broadened with distance of the focus from the objective focal plane (Fig. 1f).
94 Within a distance of 200 μm the FWHM remains below 8 μm and is to 90 % explained by
95 spherical aberration of an ideal Abbe objective receiving wave fronts with quadratic
96 curvature²⁸ (Fig. 1g).

97 **Acousto-optic patterning of light by single pulse holography**

98 Susceptibility to target-motion-induced recording artefacts is the major setback of *in-vivo*
99 RAMP recording. In addition, because of the low laser rate, the 3DScope is bound to low signal-
100 to-noise ratios with diffraction-limited single focus excitation given that every molecule in the
101 focal volume can emit at most one photon per laser cycle. We reasoned that both issues may
102 be solved by extending the focal volume to sample a larger portion of each cell including its
103 excursion space. For this, we first explored the light patterning function of the 3DScope. We

104 derived biaxial phase and intensity holograms from the desired target pattern using a
105 Gerchberg-Saxton algorithm²⁹ (Fig. 2a). By designing patterns of equidistant diffraction-
106 limited foci we intended to multiplex the excitation volume, while limiting laser power dilution
107 (Fig. 2b). To confirm designed patterns, we imaged the two-photon fluorescence emission of
108 a thin fluorescein layer (Fig. 2c). We found good agreement between intended (Fig. 2b) and
109 measured patterns (Fig. 2d) in the FM/AM mode. In FM only mode, however, the intensity
110 became unequally distributed among spots, and side lobes appeared (Fig. 2d), in agreement
111 with fast Fourier transform (FFT) reconstruction of the hologram (Supplementary Fig. 4).
112 Therefore, the FM/AM mode provides higher fidelity to the target pattern than the FM mode,
113 albeit at reduced power transmission. The size of single spots in a multi-spot array equals the
114 focus size in the absence of holographic modulation, independent of the number of spots (Fig.
115 2e) and axial broadening in the presence of defocus is also identical (Fig. 2f). Finally, we
116 devised holograms creating 3x3, 5x5 and 2x5 spot patterns (Fig. 2g, h) consistent with FFT
117 reconstruction (Supplementary Fig. 5). The freedom to program spot density and distances
118 and adapt these patterns on a pulse-to-pulse basis is the core element behind 3D-CASH.
119

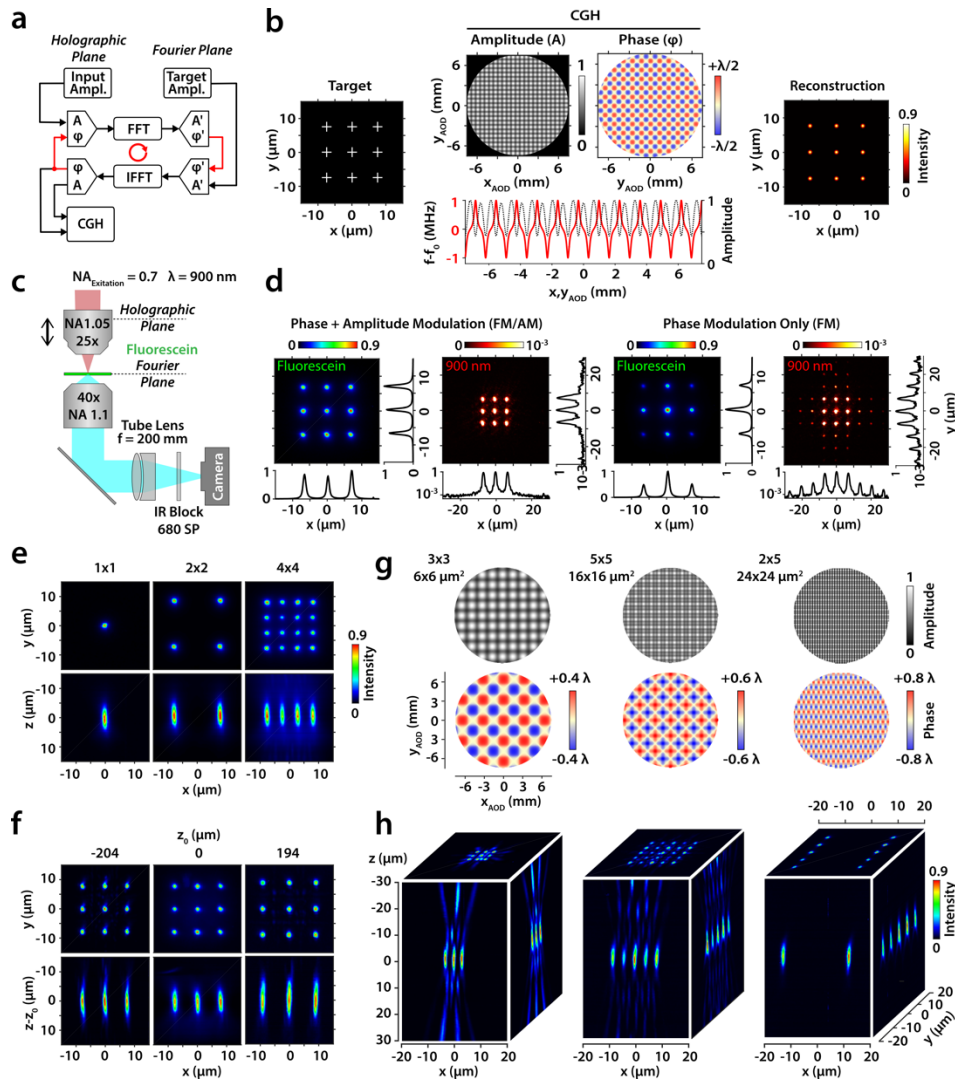

120

121

122 **Fig. 2 Acousto-optic patterning of light**

123 The 3DScope integrates spatial light modulation for holographic patterning of excitation light. **(a)** Computer-

124 generated holograms (CGHs) are derived from a desired target intensity pattern by iterative phase retrieval

125 through forward (FFT) and inverse (IFFT) fast Fourier transformation of the light fields (amplitude A and phase

126 ϕ) in the holographic and Fourier planes. The iteration loop indicated in red. **(b)** Example of a 3x3 (15x15 μm^2)

127 target pattern (left), the CGH derived from the target (middle, top), the FM/AM acousto-optic modulation,

128 identical for X- and Y-AODs, with f_0 , the carrier frequency (middle, bottom) and reconstruction of the CGH by

129 2D-Fourier transform (right). **(c)** Experimental configuration for experimental reconstruction of the CGHs. **(d)**

130 From left to right: Two-photon fluorescence image of a 10-20 μm thin aqueous fluorescein solution with

131 holographic illumination (900 nm) using the CGH in (b) together with saturated infrared intensity image, after

132 removal of the IR block, for FM/AM (left) and FM only (right). Intensity projections are shown next to each image.

133 **(e)** Measured fluorescein fluorescence without hologram (1x1) and with (2x2)- and (4x4)-hologram. **(f)** Measured

134 fluorescein fluorescence with (3x3)-hologram and with (left and right) and without (middle) defocus. **(g)** CGHs

135 for the 3x3 (6x6 μm^2), 5x5 (16x16 μm^2) and 2x5 (24x24 μm^2) patterns. **(h)** Images obtained from the experimental

136 reconstruction of CGHs in (g). All images represent maximum projections with respect to the perpendicular
137 dimension.

138

139 **Imparting motion tolerance to *in-vivo* 3D-RAMP recording**

140 We then asked whether grid spot illumination can aid to stabilize RAMP point recordings
141 against *in-vivo* brain tissue motion in awake mice (Fig. 3a). We first quantified from time lapse
142 movies the lateral movements of cell bodies in head-fixed mice expressing EGFP under the
143 GAD65 promoter (Fig. 3b). We found complex patterns of movement, with considerable cell
144 displacements also in the absence of locomotion (Fig. 3b). In-plane motion was limited to a
145 displacement space of 2 to 6 μm diameter, depending on the depth below pia (Fig. 3b,c), akin
146 for axial motion (Supplementary Fig. 6). To test whether covering this space by a large enough
147 grid pattern could counteract motion artefacts in RAMP recordings, we recorded EGFP
148 fluorescence from cell body-centered POIs in the RAMP mode at 2.5 kHz while targeting each
149 POI with a single spot focus and a 5x5 (15x15 μm^2) grid focus in pulse-to-pulse alternation (Fig.
150 3d). In the single-spot mode, the RAMP signal exhibited large-amplitude fluctuations giving
151 rise to skewed noise distributions (Fig. 3e,f), while under grid-spot illumination this noise was
152 diminished to low residual excess kurtosis (0.57 ± 0.43 , mean \pm standard deviation (SD)
153 throughout, unless stated otherwise; 37 cells; Fig. 3f,g) approaching photonic shot noise.
154 Patterned illumination therefore proves efficient in preventing motion-induced noise in *in-*
155 *vivo* RAMP recordings. Next, we asked whether holographic illumination also entails gain in
156 signal-to-noise ratio. In anesthetized mice, to minimize tissue movement, the fluorescence
157 signal as a function of excitation power followed the gain curve of a two-photon absorption
158 process, reaching half-saturation at 0.21 and 0.78 mW for a 1x1 and a 3x3 (4x4 μm) focal
159 pattern, respectively, and with the 3x3 pattern yielding 3.4 times higher fluorescence (Fig. 3h).
160 From the signal-to-noise ratio (SNR) we obtain a lower estimate of the number of detected
161 photons per laser pulse (equal to SNR^2 , Fig. 3h) reaching 1000 photons at saturation. EGFP
162 photobleaching occurred with $4.3 \cdot 10^{-6}$ quantum yield (115 ± 142 s time constant at 2 kHz, 55
163 ± 22 % amplitude, 20 cells) at 25 % saturation, in agreement with reported data of GFP under
164 low pulse rate excitation³⁰.

165

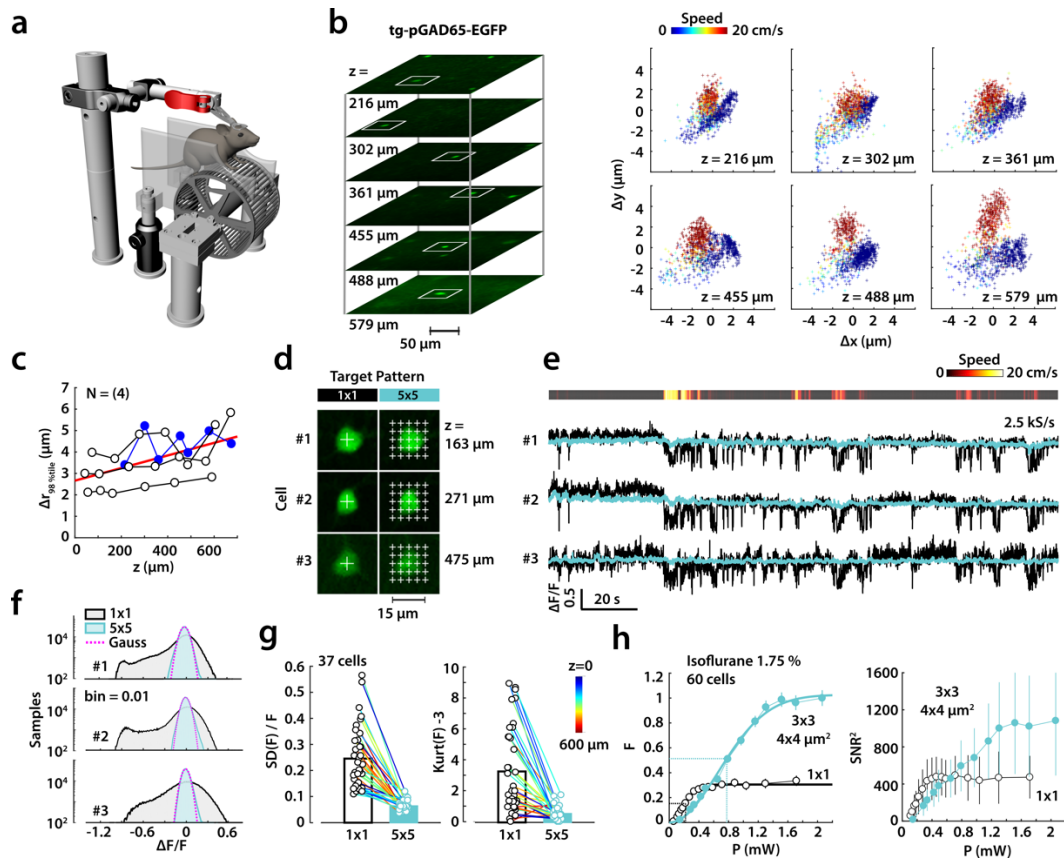

166

167

168 **Fig. 3 Holographic illumination for stable RAMP recording in awake mice**

169 **(a)** Head-fixation for mice implanted with a 5 mm cranial window over primary visual cortex walking on a
 170 treadmill. **(b)** Left: Optical sections from a two-photon fluorescence z-stack with selected cell bodies marked as
 171 white rectangles in a pGAD65-EGFP transgenic mouse. Right: x,y-Positions of selected cells given as deviation
 172 from the barycenter from time lapse movies recorded at 6 frames/s. Every data point is color-coded for
 173 simultaneously recorded walking speed. **(c)** Summary of cellular displacements (98 percentile of radial deviation
 174 from the barycenter; N = 4 animals) versus z-depth below pia. Linear fit to the data (slope 0.3 %) in red. Data of
 175 example (b) in blue. **(d)** Fluorescence images of three cell bodies overlaid with a 1x1 and a 5x5 target pattern. **(e)**
 176 Bottom: RAMP fluorescence traces obtained from cells in (d) during 180 s with pulse-to-pulse alternation
 177 between 1x1 (black) and 5x5 (cyan) pattern excitation at 2.5 kHz sampling rate (2.5 kS/s). Top: Speed of the
 178 animal. **(f)** Histograms of the fluorescence traces in (e) including Gaussian fit to data obtained under 5x5
 179 excitation. **(g)** Analysis of data like in (f) including 37 cells. Left: Relative noise defined as standard deviation (SD)
 180 of the time series data divided by the median of the fluorescence (F). Right: Excess kurtosis (Kurt). **(h)**
 181 Measurement of fluorescence yield under 1x1 and 3x3 (4x4 μm^2) excitation measured under isoflurane
 182 anesthesia (60 cells). Left: Normalized mean fluorescence during 2 s recordings versus mean excitation power
 183 (P; measured under the objective) with fits to the gain curve of two-photon absorption (solid lines). Right:
 184 Squared signal-to-noise ratio (SNR) of the same data. Error bars represent SD.

185

186 **Removing neuropil activity from GCaMP6f CASH recordings**

187 Grid illumination of neurons expressing a neuronal activity indicator will yield a mixed signal
188 of single-cell and multicellular activity, with the latter originating from the surrounding
189 neuropil covered by the grid and from out-of-focus excitation. To extract the single-cell signal,
190 we record a neuropil reference signal from an excitation pattern composed of two lines of foci
191 outside of the grid target (Fig. 4a). The two patterns are then toggled from pulse to pulse such
192 that two laser pulses are deployed to each cell before moving on to the next cell. We tested
193 this protocol in layer 2/3 (L2/3) and layer 5 (L5) neurons of primary visual cortex (V1)
194 expressing GCaMP6f and tdTomato in presence of Cre recombinase. From an imaging stack
195 we selected CaMP6f-positive neurons (Fig. 4b,c), with some of them co-expressing tdTomato,
196 and recorded GCaMP6f and tdTomato fluorescence signals in 3D-CASH mode. GCaMP6f
197 photobleaching was negligible during 300 s recording trials, which were equivalent to an
198 exposure to 72,000 laser pulses, except for a fast initial bleaching transient of $9.5 \cdot 10^{-5}$
199 quantum yield (44 ± 15 s time constant at 0.24 kHz, 10 ± 5 % amplitude, 84 cells) appearing
200 only in the very first trial. The fluorescence signals of the cell body (CB) and neuropil (NP) were
201 strongly correlated, while the tdTomato signal remained flat (Fig. 4d). To estimate the true
202 cellular signal, we subtracted the neuropil signal from the CB signal using a global weight
203 factor (α). Noise regression yielded similar α values as correlation regression^{31,32}, which
204 increased with depth (Fig. 4e and Supplementary Fig. 7). Both regressions descended to the
205 same level of residual baseline noise in this example (3.1 ± 0.4 %; 74 cells; Fig. 4f) and in pooled
206 data (3.3 ± 0.5 %; 4 animals; Fig. 4h). After neuropil correction, pairwise correlations of the
207 fluorescence signals were reduced six-fold to a residual value of 0.13 in one example (Fig. 4g)
208 and 0.15 ± 0.08 in pooled data (Fig. 4h) suggesting that holographic illumination does not
209 impart higher neuropil contamination than standard imaging techniques^{32,33}. Furthermore,
210 simultaneous CASH and image acquisition revealed consistent GCaMP6f signaling (0.95 ± 0.1
211 median trace correlation; 19 cells; Extended Data Fig. 2). The GCaMP6f signal rises in many
212 cells during locomotion (Fig. 4i), consistent with increased spike rates in V1 neurons during
213 locomotion in the dark³⁴; and overlay of the fluorescence traces with MLspike³⁵-inferred
214 spikes (Fig. 4j) showed an increased spike rate during locomotion (Supplementary Fig. 8). As a
215 control for possible locomotion artefacts, MLspike detected only one false event in
216 simultaneously recorded tdTomato traces (10 cells; 50 min recording time).

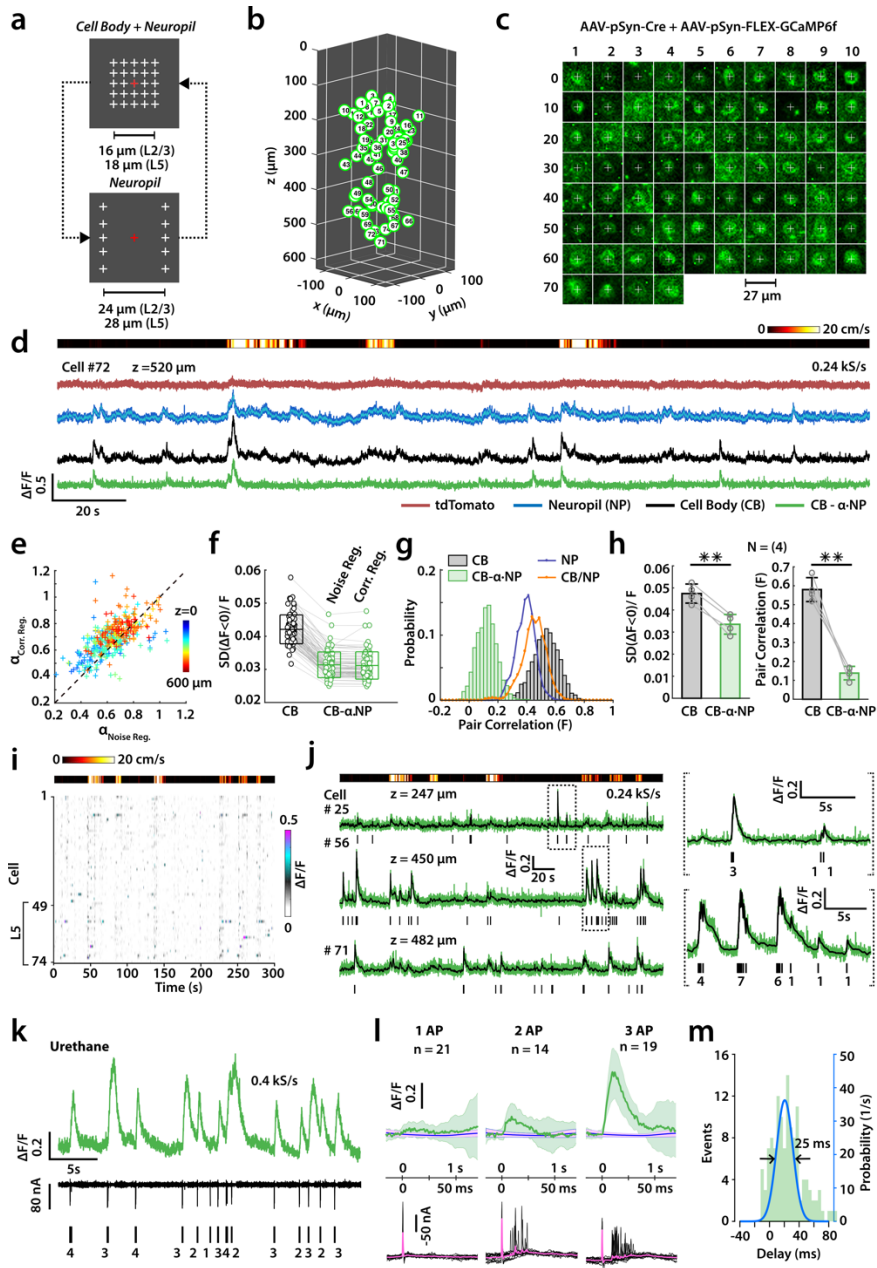

218 **Fig. 4 Neuropil correction of GCaMP6f-RAMP recordings**

219 **(a)** CASH target patterns for sampling a cellular signal with a neuropil component. Target center marked as red
220 cross. **(b)** 3D coordinates of 74 cells selected from a full-frame z-stack obtained from a mouse expressing
221 GCaMP6f in cortical neurons in layers L2/3 and 5. **(c)** Fluorescence images of cells in (b). **(d)** Example recordings
222 of, from top to down, motion speed, tdTomato fluorescence (red), GCaMP6f neuropil fluorescence (NP, blue),
223 cellular GCaMP6f signal (CB, black) and the corrected GCaMP6f signal after global noise regression (CB- α NP,
224 green). **(e)** Regression parameter obtained from correlation versus noise regression of 300 s recordings (5
225 repetitions) with identity line (red dashes). **(f)** Baseline noise for raw and corrected data in 300 s recordings with
226 box width representing SD. **(g)** Pearson pairwise correlation. **(h)** Mean baseline noise (left) and mean pair
227 correlation (right) of paired (gray lines) raw (black) and corrected data (green). Paired t-test (two-sided) $p = 0.003$
228 (**; $N = 4$ experiments; 4 animals). Error bars represent SD. **(i)** False-color representation of fluorescence traces
229 after noise regression for all cells, shown in (b) and (c) with walking speed (top). **(j)** Left: Fluorescence traces
230 (green), overlaid with MLspike-deconvoluted traces (black) and inferred spikes (black bars; below). Right:
231 Extended views with numbers of spikes (below). **(k)** Simultaneous CASH (green) and electrode recording (loose
232 patch; black) of a spontaneously active cell (L2/3; $z = 225 \mu\text{m}$) under urethane anesthesia with burst spike counts
233 (bottom). **(l)** Top row: Spike triggered average GCaMP6f responses (green; \pm SD) for single spikes (1 AP; 21
234 events), spike doublets (2 AP; two spikes within a 30 ms window; 14 events) and triple spikes (3 AP; 30 ms
235 window; 19 events) together with bootstrap noise (blue/magenta; \pm SD). Bottom row: Electrode currents (black)
236 with the first spike at time zero and current average (magenta). **(m)** Histogram of latency (green) of MLspike-
237 inferred relative to electrode-detected spikes within a 0.2 s time window and Gaussian density (blue; 25 ms
238 FWHM; 23 ms mean).

239

240 To estimate the goodness of spike inference, we applied spike deconvolution to simulated
241 data. The combined error rate of spike detection decreased with increasing sampling rate,
242 attaining 25 % or 10 % for SNR 2 or 4, respectively, at 200 Hz, provided neuropil correction
243 was included (Extended Data Fig. 3). To test these predictions, we recorded the membrane
244 activity through a cell-attached electrode simultaneously with CASH under urethane
245 anesthesia (Fig. 4k, Extended Data Fig. 4). Event sorting revealed the spike-triggered average
246 waveform of the GCaMP6f response to 1 to 3 action potential (APs) events within a 30 ms
247 summation window (Fig. 4l). These events were detected by MLspike with probabilities of 0.46
248 (1 AP), 0.73 (2 AP) and 1 (3 AP), respectively (104 events, 1 cell, Extended Data Fig. 4e), with
249 latencies of detected versus true spikes centering at 23 ms with a 25 ms distribution width
250 (Fig. 4m). Receiver operating analysis with a probability discriminant (Extended Data Fig. 4e,f)
251 revealed $\Delta F/F$ amplitude responses of 0.076 ± 0.01 (1 AP), 0.24 ± 0.02 (2 AP) and 0.46 ± 0.02

252 (3 AP), implying 1.64 ± 0.01 Hill non-linearity (Extended Data Fig. 4g) in agreement with the
253 literature³⁶.

254

255 **Tuning of V1 neurons to oriented visual contrast**

256 Providing large volumetric depth ($> 400 \mu\text{m}$), 3D-CASH affords access to the columnar extent
257 of cortical neuronal activity. We simultaneously recorded GCaMP6f activity of neurons in
258 layers 2/3 and 5 of V1 cortex in response to moving contrast gratings in awake mice. For
259 selection of active cells, we manually chose cells from a stack recorded during presentation of
260 visual noise (Fig. 5a). Single-trial responses to contrast gratings displayed gain-modulation by
261 motor activity³⁷ (Extended Data Fig. 5 and 6). To discount the effect of locomotion on
262 measured tuning properties, we averaged the responses over 20 stimulus repetitions (Fig. 5b).
263 In this experiment, 53 of 57 selected cells responded significantly ($p < 0.002$, bootstrap test)
264 to the stimulus and among these 32 cells displayed significant orientation tuning ($p \leq 0.03$;
265 Fig. 5c-f). The global tuning index (gOSI) ranged from 0.1 to 0.7 and was more pronounced
266 than directional tuning (Fig. 5c). Projection of tuning angle on cell position indicates an
267 absence of orientation clusters (Fig. 5d and Supplementary Fig. 9). Single-trial responses
268 showed large variability including oscillatory, ramp-like and failure responses (Fig. 5g,h). In
269 pooled data (3 animals), about 70 % of selected cells were responsive and 50 % orientation-
270 tuned (Fig. 5i). The tuning angle obtained from the tuning curve (OSI, orientation sensitivity
271 index; Fig. 5f) was consistent with the angle obtained from the vector sum (Fig. 5j). Across
272 tuned cells, tuning angles were homogeneously distributed between 0° and 180° ,
273 independent of depth (Fig. 5k) and of layer, and visual responses were positively correlated to
274 locomotion (Fig. 5l). In one experiment, we recorded visual responses in the same cells (L2/3,
275 36 cells) in the awake and anesthetized state (Extended Data Fig. 7). Under isoflurane, layer
276 2/3 cells showed higher response probability with 3-fold larger mean response and lower
277 inter-trial variance compared to the awake condition (Extended Data Fig. 7d-g), as well as
278 higher spontaneous spike rates (Extended Data Fig. 8).

279

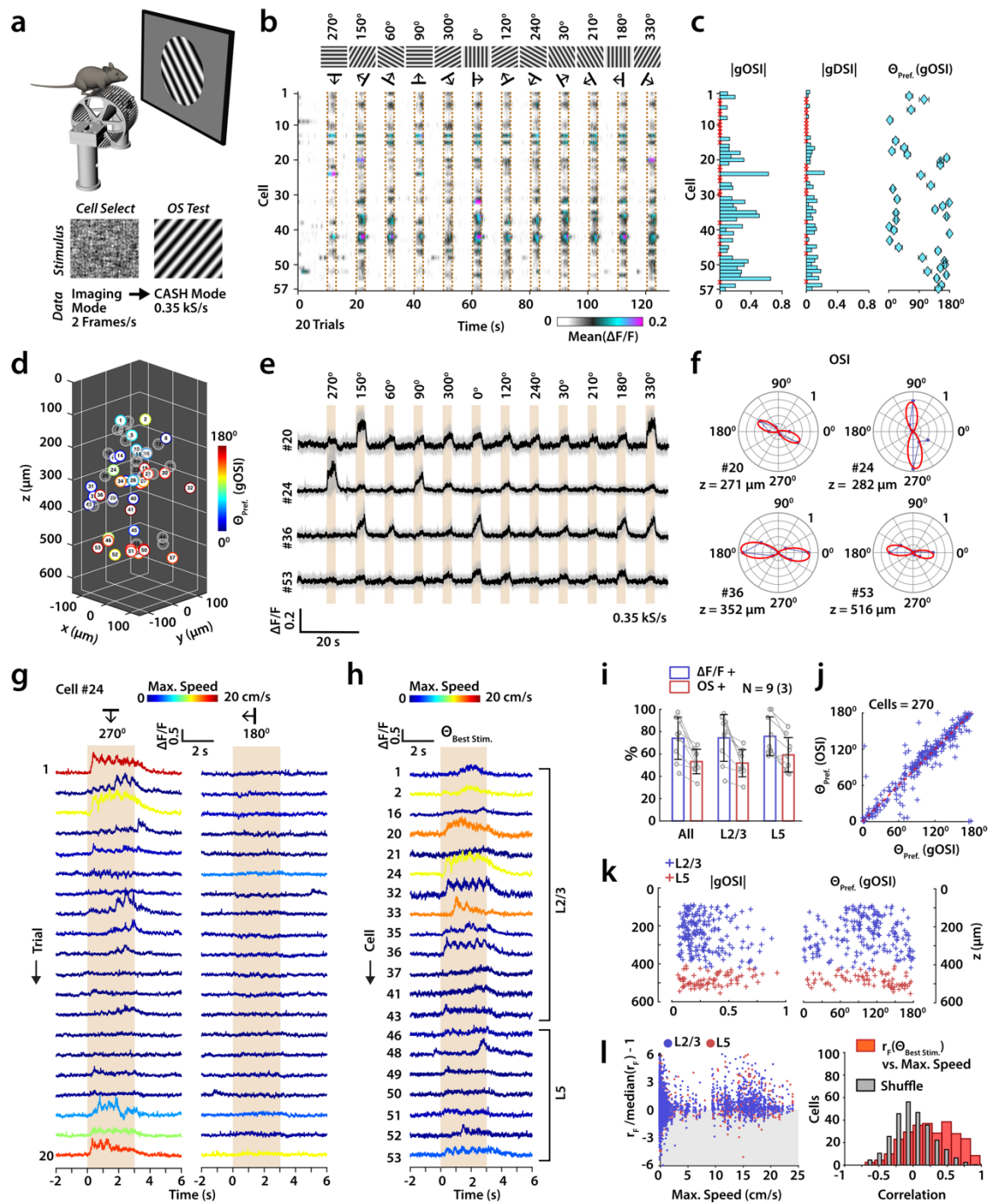

280
281

282 **Fig. 5 Orientation tuning of neurons in V1 cortex**

283 **(a)** Awake mouse on a treadmill with visual stimuli presented in the left visual field. The stimulus is a filtered
 284 noise movie (imaging mode) or moving contrast gratings (CASH mode; OS, Orientation Sensitivity). **(b)** Trial-
 285 averaged fluorescence traces of 57 neurons (20 trials; 350 Hz sampling) with grating stimuli of varying orientation
 286 (top). **(c)** Magnitude of global orientation selectivity index (gOSI), global direction selectivity index (gDSI) and
 287 gOSI tuning angle, evaluated for neurons exhibiting significant response and orientation tuning. Neurons that
 288 failed statistical testing marked as red crosses. **(d)** 3D coordinates of recorded neurons with color coding for
 289 tuning angle. Unresponsive neurons in gray. Z-axis aligned to the pia mater ($z = 0$). **(e)** Trial-averaged fluorescence
 290 traces (black) with SD (gray) of four example neurons. **(f)** Orientation selectivity index (OSI) calculated from the

291 fluorescence responses in (e). **(g)** Single-trial fluorescence responses of cell #24 to the preferred orientation
292 (270°) and orthogonal orientation (180°) with traces color-coded for the maximum speed of locomotion. **(h)**
293 Montage of single-trial fluorescence responses of 20 cells selected from 36 tuned cells by choosing for each cell
294 the stimulus trial of maximum integral response, using the same color code as in (g). Putative laminar cell position
295 in layer 2/3 (L2/3) or layer 5 (L5) indicated by brackets. **(i)** Fractions of visual responsive (blue) and orientation-
296 tuned cells (red). Paired data from 9 experiments (514 cells in total; 3 animals) connected by gray lines. Error
297 bars represent SD. **(j)** Correlation diagram of gOSI- and OSI-derived tuning angles. **(k)** Amplitude of orientation
298 tuning ($|gOSI|$) and gOSI-derived tuning angle for the whole dataset (270 cells; 3 animals) versus z-position and
299 assignment to cortical layers 2/3 (blue) and 5 (red). **(l)** Left: Single-trial fluorescence amplitude (r_f) in response
300 to the best stimulus normalized by the median of responses across all trials as function of maximum speed. Right:
301 Histogram of correlation coefficient between single-trial response amplitude to the best stimulus and the
302 maximum speed (red).

303

304 **Temporal structure of the visual response and pairwise correlations**

305 Finally, exploiting the temporal resolution of 3D-CASH (0.5 to 10 ms in the 3DScope,
306 depending on sample size), we aimed to extract the temporal information present in single-
307 cell GCaMP6f responses and across the entirety of simultaneously recorded cells. First, to test
308 the dependence of the GCaMP6f response on a temporal stimulus parameter, we varied the
309 stimulus frequency between 1 and 4 Hz for two orthogonal stimulus directions (0° and 90° ;
310 Fig. 6a). In the example cell (Fig. 6b,c), the GCaMP6f signal tracked the phase of the stimulus
311 (Fig. 6b) and the time-resolved FFT spectrum exhibits an amplitude peak at each stimulus
312 frequency tested (Fig. 6c) in absence of stimulus artefacts (Supplementary Fig. 10). For a set
313 of orientation-sensitive cells we constructed the peri-stimulus time histogram (PSTH) of
314 inferred spikes for the preferred angle and calculated for every PSTH the ratio of the first
315 harmonic with respect to the mean rate (R_1/R_0 ; Fig. 6 d-f and Extended Data Fig. 9). The pooled
316 data (Fig. 6g) show a broad distribution with weak bimodality, ranging from non-phasic to
317 phasic responses (Extended Data Fig. 10).

318

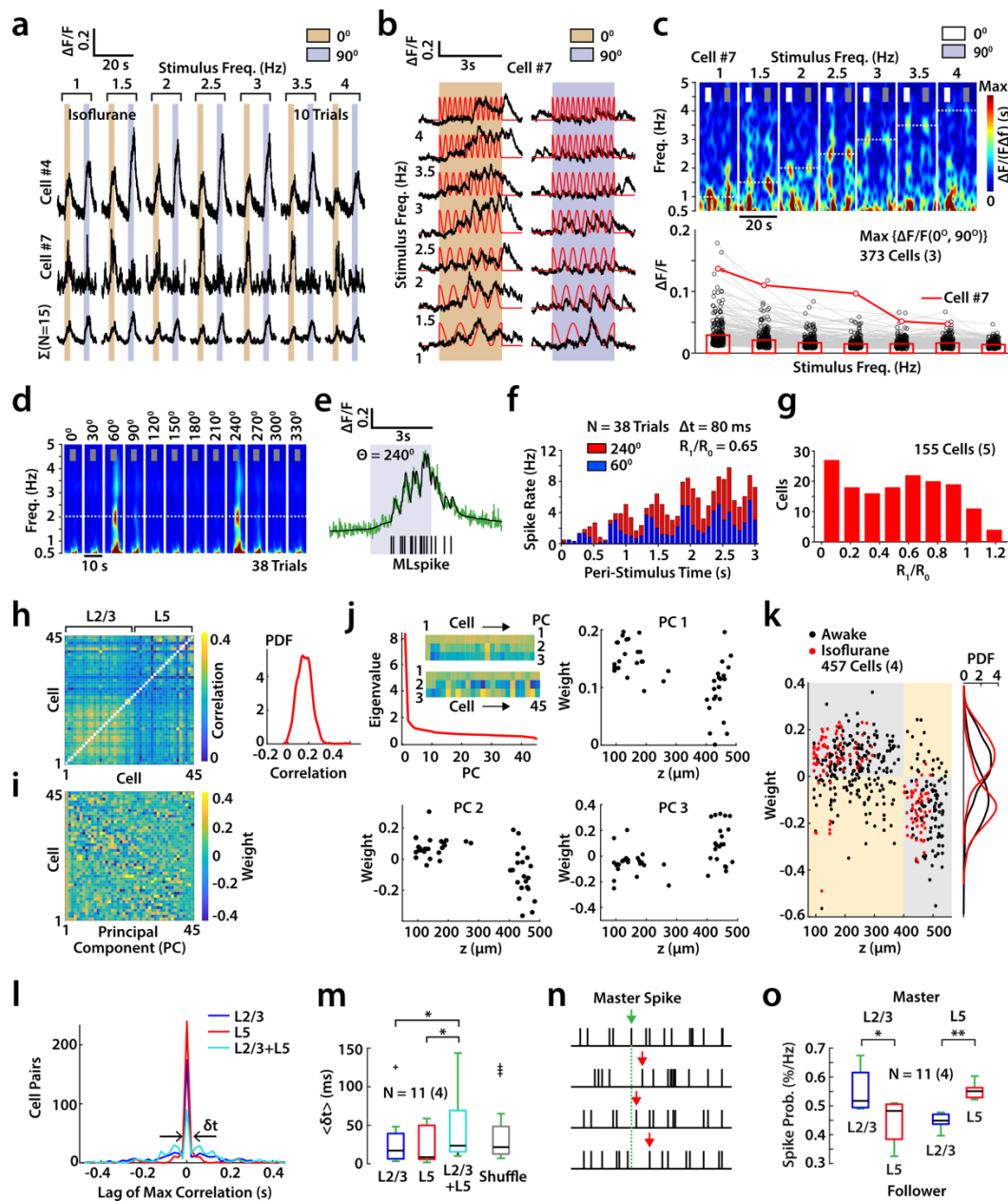

319

320

321

Figure 6: Temporal response properties and population correlation analysis

322

(a) Trial-averaged fluorescence responses (10 trials; 445 Hz sampling) to contrast gratings of 0° and 90° orientation and 1 to 4 Hz frequency for two example cells (top) and a 15-cell average (bottom) under isoflurane.

323

324

(b) GCaMP6f responses (cell #7) overlaid with the temporal phase of the stimulus (red lines).

325

(c) Top: Short time Fourier transform (STFT) of the trial-averaged stimulus response (cell #7) for 1 to 4 Hz stimuli (white dashed lines). Bottom: Maximum Fourier amplitude (0° and 90° orientation) of the GCaMP6f response versus stimulus frequency (10 trials; 373 cells; L2/3) with population mean (red bar).

326

(d) STFT of the GCaMP6f response at constant temporal (2 Hz; dashed white line) and spatial (0.04 cpd, cycles per degree) frequency (example cell; 38 trials).

327

(e) Single-trial GCaMP6f response (green) to the best stimulus (240° ; gray) together with MLspike-reconstructed response (black) and inferred spikes (vertical bars, black).

328

(f) Peri-stimulus time stacked histogram (PSTH) of the spike rate of the stimulus response to 240° (red) and 60° (blue) orientation (38 Trials, R_1/R_0).

329

330

331

332 harmonic ratio). **(g)** R_1/R_0 histogram (155 cells; L2/3; 5 animals). **(h)** Left: Pearson correlation matrix of GCaMP6f
333 data (45 cells; awake state) during visual stimulation (protocol Fig. 5b; 444 Hz sampling; 130 s). Correlation
334 means: 0.25 (L2/3), 0.14 (L5) and 0.17 (interlaminar pairs). Right: Probability density function. **(i)** Principal
335 Components (PCs) of the correlation matrix in descending order of eigenvalue. **(j)** Top left: Eigenvalues and (inset)
336 the first three PCs. Bottom left and right: Weights of PCs 1 to 3 as a function of z-depth. **(k)** Pooled data (457
337 cells; 4 animals), including experiments under isoflurane (red) showing PC weights versus z-depth. **(l)** Time lag
338 histogram of maximum cross-correlation between cell in L2/3 (blue), L5 (red) and inter-layer pairs (black). **(m)**
339 Width, δt , of the zero lag correlation peak (SD; 11 recordings, 4 animals). Unpaired t-test (two-sided) of cross-
340 laminar (L2/3+L5) neuron pairs versus pairs within L2/3 ($p = 0.03$) and L5 ($p = 0.04$). As control, cells were z-
341 shuffled. Boxplot shows median (bar; black) 1st and 3rd quartile (box), ± 2.7 SD range (green) and outliers (black).
342 **(n)** Schematic showing spike delays between a master spike (green) and follower spikes in three neurons (red).
343 **(o)** Probability that the neuron to spike first following a spike in a master neuron is located in L2/3 or L5,
344 normalized by cell count and mean firing rate in the follower layer. P-values $3 \cdot 10^{-2}$ (*) for L2/3 masters and $2.4 \cdot 10^{-3}$ (**)
345 for L5 masters (unpaired t-test; two-sided; N=11 experiments; 4 animals; $8 \cdot 10^5$ spikes). Boxplot analogous
346 to (m).

347

348 We then asked how GCaMP6f signals of V1 neurons are correlated among cells distributed
349 across layers 2/3 and 5. Pairwise correlations evaluated from entire trials are higher among
350 layer 2/3 than among layer 5 cells or pairs between the two layers (Fig. 6h). Principal
351 component analysis of the correlation matrix (Fig. 6i) revealed a highest-ranking component
352 (PC1) with uniform weights across neurons (Fig. 6j), suggesting global correlation, and a
353 second-ranking component (PC2) with weights of opposite signs for neurons in layer 2/3
354 versus layer 5 (Fig. 6j and Fig. 6k for pooled data; 4 animals). From this we hypothesized higher
355 spike synchronicity between intra-laminar versus inter-laminar neuron pairs. Indeed, the zero-
356 peak width, δt , of the cross-correlation histogram (Fig. 6l) was significantly lower for intra-
357 laminar compared to inter-laminar pairs ($p = 0.03$ and 0.04 , t-test; Fig. 6m). Next, we asked
358 how this observation is represented in the temporal structure of spike activity. For every cell,
359 we calculated for every BSD³⁸-inferred spike as master spike the time delay to the closest
360 follower spike among all other cells (Fig. 6n). This analysis showed that spikes emitted from
361 neurons in a given layer are more likely followed by a closest spike in a neuron of the same
362 layer with a mean latency of 17 ± 60 ms (Fig. 6o and Supplementary Fig. 11).

363

364 Discussion

365 The present data highlight the utility of CASH to speed up *in-vivo* calcium measurement from
366 cell somata in optically accessible 3D neuron populations. With a throughput of 20,000
367 neurons per second in CASH mode, the 3DScope constitutes a substantial gain over earlier 3D-
368 AOD microscopes ($< 1,000$ neurons/s)^{24,39}. In CASH, the number of single-cell POIs, n_{cells} , is
369 given by $n_{cells} = r_{data}/r_{acq}$ with r_{data} , the data throughput of the microscope, and r_{acq} , the
370 sampling rate. Larger sample size therefore entails lower sampling rate, while the GCaMP6f
371 response-to-noise ratio (RNR) scales with $\sqrt{r_{acq}}$ (Supplementary Discussion). This trade-off
372 between sample size and RNR ultimately defines how many POIs can be sampled at a given
373 level of spike inference error. In the case of densely distributed cortical cells, we expect CASH
374 to yield similar effective SNR as standard 2D two-photon imaging, whereas superior SNR is
375 obtained for sparsely distributed targets (Supplementary Discussion). At the same time,
376 sparse cell labeling helps to isolate single cells within the patterned excitation volume and, by
377 minimizing background fluorescence, maintain high probe sensitivity under 2-photon
378 excitation.

379 Earlier AOD-based 3D microscopes employed counterpropagating sibling gratings in
380 two AODs in series to cancel focus drift induced by linear frequency chirp in asynchronous
381 mode²⁰⁻²². This scheme, however, does not prevent focus drift for non-linear chirps⁴⁰ and
382 suffers from low power transmission, because of the second AOD receiving input in mismatch
383 with the Bragg angle, and from vanishing duty cycle for large defocus¹⁸. Resonant 3D mirror
384 scanners, on the other hand, are limited to low sampling rate (< 20 Hz) in few planes^{8,41} in
385 spite of high nominal throughput (> 10 megapixels/s) as only a minority of pixels contribute
386 useful information. While recent smart sampling methods achieve up to kHz speed, these
387 methods were limited to 2D-distributed targets in the focal plane⁴²⁻⁴⁴. To achieve similar
388 sampling speed, but from 3D-distributed targets, 3D-CASH takes a fundamentally different
389 approach. In CASH, the principal source of speed gain is random access, not large-scale
390 multiplexing. Single-shot excitation volumes remain confined to individual cells and their
391 immediate environments, which results in non-mixed cellular data at low laser power (< 0.4
392 mW per spot in the 5x5 grid) safely below known thresholds of heating damage¹⁵.

393 Our data reproduce observations in the rodent visual system, in particular similar
394 orientation tuning of neurons in layers 2/3 and 5⁴⁵, absence of spatial orientation clusters⁴⁶
395 and modulation by locomotion³⁷, while *a priori* selection of cells in CASH assessed a larger

396 population of visual responsive V1 cells than previously reported³⁶. Phase sensitivity of the
397 visual response reflects excitation modulation of V1 neurons by contrast bars moving across
398 neuronal receptive fields⁴⁷. At fixed stimulus periodicity, and without distinguishing excitatory
399 and inhibitory cells, we find a continuous distribution of non-phasic (complex) to phasic
400 (simple) responses in line with receptive field diversity of V1 neurons⁴⁸⁻⁵¹. Analysis of pairwise
401 response correlations revealed the existence of a collective response, which segregates
402 neurons of layer 2/3 and 5, in spite of similar orientation tuning, and involves layer-dependent
403 millisecond spike delays. Given the present proof-of-principle, 3D-CASH acquisition supplies a
404 handle to assess correlations of neuronal activity between 3D-distributed cells, like those of
405 the mammalian columnar cortical circuit, on the true time scale of neuronal electrical activity.
406
407

408 **Acknowledgments**

409 We wish to acknowledge expert technical help by Gérard Paresys for electronic designs, Yvon
410 Cabirou for mechanical engineering, El Mehdi Afif for advice on FPGA programming, François
411 Le Fouiller for explanations of acousto-optic device design, the IBENS transgenesis platform
412 and Caroline Maihes-Hamon for help with virus injections, Clara Dussaux (Institut Pasteur,
413 Paris) for spin-coated fluorescent micro-slides, Philippe Rostaing for ultramicrotome
414 sectioning of fluorescent nano-slides, Christophe Auger for help with pharmacology and the
415 IBENS animal facility for animal care. We also want to thank Nathalie Rochefort, Frederic
416 Chavane, Sylvain Gigan and David Ferster for discussions. Funding was provided by ANR
417 (ALPINS ANR-15-CE19-0011-01, ANR-15-CE19-0011-02, EXPECT ANR-17-CE37-0022-01),
418 Région Île de France (DIM Cerveau & Pensée, ALPINS), NIH BRAIN Initiative (1U01NS103464),
419 Fondation pour l’Audition (FPA RD-2018-6), Institut de Convergence Qlife (Q-life ANR-17-
420 CONV-0005) and the program Investissements d’Avenir launched by the French government
421 and implemented by the ANR, with the references: ANR-10-LABX-54 (Memolife), ANR-11-
422 IDEX-0001-02 (Université PSL) and ANR-10-INSB-04- 01 (France-Biolmaging Infrastructure).
423 SW was supported by postdoctoral fellowship SPF201809007064 from the Fondation pour la
424 Recherche Médicale France.

425

426 **Author Contributions**

427 LB, SD and JFL initiated research and obtained funding, WA built the 3DScope, WA and BM
428 coded the software, BM developed the user interface, JF and WA designed the detection unit,
429 AT set up the transmission microscope, JF designed the tower head post, VV set up the
430 treadmill, WA set up the visual stimulator and isoflurane anesthesia, VV and WA performed
431 animal surgery, VV performed virus injections, WA performed experiments, SD and VV
432 performed cell-attached recordings, WA and SW analyzed data and created figures, LB, SD,
433 JFL, CV, VV, SW and WA discussed research, WA, LB, SD and JFL wrote the manuscript with
434 contributions from all authors.

435

436 **Competing interests**

437 BM and SD are co-founders of the company Karthala System and hold shares in this company.

438

439 JFL, LB and SD are inventors in accordance with United States Patents 10423017 and 10191268
440 jointly owned by the Institut National de la Santé et de la Recherche Médicale (INSERM), the
441 Centre National de la Recherche Scientifique (CNRS) and the École Normale Supérieure de
442 Paris (ENS).

443

444 All other authors declare that they do not have competing interests.

445

446 **Data Availability Statement**

447 Data used for the main figures are available on

448 <https://www.opendata.bio.ens.psl.eu/3D-CASH/>.

449 Further data are available from the authors upon request.

450

451 **Code Availability Statement**

452 Codes for hologram retrieval are available on <https://github.com/walther007/3D-CASH>. Other

453 codes will be provided by the authors upon request.

454 **References**

- 455 1. Svoboda, K. & Yasuda, R. Principles of Two-Photon Excitation Microscopy and Its
456 Applications to Neuroscience. *Neuron* **50**, 823–839 (2006).
- 457 2. Dombeck, D. A., Khabbaz, A. N., Collman, F., Adelman, T. L. & Tank, D. W. Imaging Large-
458 Scale Neural Activity with Cellular Resolution in Awake, Mobile Mice. *Neuron* **56**, 43–57
459 (2007).
- 460 3. Göbel, W., Kampa, B. M. & Helmchen, F. Imaging cellular network dynamics in three
461 dimensions using fast 3D laser scanning. *Nat. Methods* **4**, 73–79 (2007).
- 462 4. Grewe, B. F., Voigt, F. F., van 't Hoff, M. & Helmchen, F. Fast two-layer two-photon imaging
463 of neuronal cell populations using an electrically tunable lens. *Biomed. Opt. Express* **2**,
464 2035–2046 (2011).
- 465 5. Kong, L. *et al.* Continuous volumetric imaging via an optical phase-locked ultrasound lens.
466 *Nat. Methods* **12**, 759 (2015).
- 467 6. Yang, W. *et al.* Simultaneous Multi-plane Imaging of Neural Circuits. *Neuron* **89**, 269–284
468 (2016).
- 469 7. Botcherby, E. J. *et al.* Aberration-free three-dimensional multiphoton imaging of neuronal
470 activity at kHz rates. *Proc. Natl. Acad. Sci.* **109**, 2919 (2012).
- 471 8. Liu, R. *et al.* Aberration-free multi-plane imaging of neural activity from the mammalian
472 brain using a fast-switching liquid crystal spatial light modulator. *Biomed. Opt. Express* **10**,
473 5059–5080 (2019).
- 474 9. Quirin, S., Peterka, D. S. & Yuste, R. Instantaneous three-dimensional sensing using spatial
475 light modulator illumination with extended depth of field imaging. *Opt. Express* **21**, 16007–
476 16021 (2013).

- 477 10. Ducros, M., Houssen, Y. G., Bradley, J., de Sars, V. & Charpak, S. Encoded multisite two-
478 photon microscopy. *Proc. Natl. Acad. Sci.* **110**, 13138 (2013).
- 479 11. Thériault, G., Cottet, M., Castonguay, A., McCarthy, N. & De Koninck, Y. Extended tw-
480 photon microscopy in live samples with Bessel beams: steadier focus, faster volume scans,
481 and simpler stereoscopic imaging. *Front. Cell. Neurosci* (2014).
- 482 12. Song, A. *et al.* Volumetric two-photon imaging of neurons using stereoscopy (vTwINS).
483 *Nat. Methods* **14**, 420 (2017).
- 484 13. Cheng, A., Gonçalves, J. T., Golshani, P., Arisaka, K. & Portera-Cailliau, C. Simultaneous
485 two-photon calcium imaging at different depths with spatiotemporal multiplexing. *Nat.*
486 *Methods* **8**, 139 (2011).
- 487 14. Picot, A. *et al.* Temperature Rise under Two-Photon Optogenetic Brain Stimulation. *Cell*
488 *Rep.* **24**, 1243-1253.e5 (2018).
- 489 15. Podgorski, K. & Ranganathan, G. Brain heating induced by near-infrared lasers during
490 multiphoton microscopy. *J. Neurophysiol.* **116**, 1012–1023 (2016).
- 491 16. Bullen, A., Patel, S. S. & Saggau, P. High-speed, random-access fluorescence
492 microscopy: I. High-resolution optical recording with voltage-sensitive dyes and ion
493 indicators. *Biophys. J.* **73**, 477–491 (1997).
- 494 17. Salomé, R. *et al.* Ultrafast random-access scanning in two-photon microscopy using
495 acousto-optic deflectors. *J. Neurosci. Methods* **154**, 161–174 (2006).
- 496 18. Reddy, G. D. & Peter Saggau. Fast three-dimensional laser scanning scheme using
497 acousto-optic deflectors. *J. Biomed. Opt.* **10**, 1–10 (2005).
- 498 19. Otsu, Y. *et al.* Optical monitoring of neuronal activity at high frame rate with a digital
499 random-access multiphoton (RAMP) microscope. *J. Neurosci. Methods* **173**, 259–270
500 (2008).

- 501 20. Reddy, G., Kelleher, K., Fink, R. & Saggau, P. Three-dimensional random access
502 multiphoton microscopy for functional imaging of neuronal activity. *Nat. Neurosci.* **11**, 713
503 (2008).
- 504 21. Katona, G. *et al.* Fast two-photon in vivo imaging with three-dimensional random-
505 access scanning in large tissue volumes. *Nat. Methods* **9**, 201 (2012).
- 506 22. Fernández-Alfonso, T. *et al.* Monitoring synaptic and neuronal activity in 3D with
507 synthetic and genetic indicators using a compact acousto-optic lens two-photon
508 microscope. *J. Neurosci. Methods* **222**, 69–81 (2014).
- 509 23. Grewe, B. F., Langer, D., Kasper, H., Kampa, B. M. & Helmchen, F. High-speed in vivo
510 calcium imaging reveals neuronal network activity with near-millisecond precision. *Nat.*
511 *Methods* **7**, 399 (2010).
- 512 24. Szalay, G. *et al.* Fast 3D Imaging of Spine, Dendritic, and Neuronal Assemblies in
513 Behaving Animals. *Neuron* **92**, 723–738 (2016).
- 514 25. Griffiths, V. A. *et al.* Real-time 3D movement correction for two-photon imaging in
515 behaving animals. *Nat. Methods* **17**, 741–748 (2020).
- 516 26. Akemann, W. *et al.* Fast spatial beam shaping by acousto-optic diffraction for 3D non-
517 linear microscopy. *Opt. Express* **23**, 28191–28205 (2015).
- 518 27. Kaplan, A., Friedman, N. & Davidson, N. Acousto-optic lens with very fast focus
519 scanning. *Opt. Lett.* **26**, 1078–1080 (2001).
- 520 28. Botcherby, E. J., Juškaitis, R., Booth, M. J. & Wilson, T. An optical technique for remote
521 focusing in microscopy. *Opt. Commun.* **281**, 880–887 (2008).
- 522 29. Wyrowski, F. & Bryngdahl, O. Iterative Fourier-transform algorithm applied to
523 computer holography. *J. Opt. Soc. Am. A* **5**, 1058–1065 (1988).

- 524 30. Donnert, G., Eggeling, C. & Hell, S. W. Major signal increase in fluorescence microscopy
525 through dark-state relaxation. *Nat. Methods* **4**, 81–86 (2007).
- 526 31. Dipoppa, M. *et al.* Vision and Locomotion Shape the Interactions between Neuron
527 Types in Mouse Visual Cortex. *Neuron* **98**, 602–615.e8 (2018).
- 528 32. Kerr, J. N. D. *et al.* Spatial Organization of Neuronal Population Responses in Layer 2/3
529 of Rat Barrel Cortex. *J. Neurosci.* **27**, 13316 (2007).
- 530 33. Smith, S. L. & Häusser, M. Parallel processing of visual space by neighboring neurons
531 in mouse visual cortex. *Nat. Neurosci.* **13**, 1144–1149 (2010).
- 532 34. Saleem, A. B., Ayaz, A., Jeffery, K. J., Harris, K. D. & Carandini, M. Integration of visual
533 motion and locomotion in mouse visual cortex. *Nat. Neurosci.* **16**, 1864 (2013).
- 534 35. Deneux, T. *et al.* Accurate spike estimation from noisy calcium signals for ultrafast
535 three-dimensional imaging of large neuronal populations in vivo. *Nat. Commun.* **7**, 12190
536 (2016).
- 537 36. Chen, T.-W. *et al.* Ultrasensitive fluorescent proteins for imaging neuronal activity.
538 *Nature* **499**, 295 (2013).
- 539 37. Niell, C. M. & Stryker, M. P. Modulation of Visual Responses by Behavioral State in
540 Mouse Visual Cortex. *Neuron* **65**, 472–479 (2010).
- 541 38. Tubiana, J., Wolf, S., Panier, T. & Debregeas, G. Blind deconvolution for spike inference
542 from fluorescence recordings. *J. Neurosci. Methods* **342**, 108763 (2020).
- 543 39. Nadella, K. M. N. S. *et al.* Random-access scanning microscopy for 3D imaging in awake
544 behaving animals. *Nat. Methods* **13**, 1001 (2016).
- 545 40. Kirkby, P. A., Srinivas Nadella, K. M. N. & Silver, R. A. A compact acousto-optic lens for
546 2D and 3D femtosecond based 2-photon microscopy. *Opt. Express* **18**, 13720–13744 (2010).

- 547 41. Weisenburger, S. *et al.* Volumetric Ca²⁺ Imaging in the Mouse Brain Using Hybrid
548 Multiplexed Sculpted Light Microscopy. *Cell* **177**, 1050-1066.e14 (2019).
- 549 42. Zhang, T. *et al.* Kilohertz two-photon brain imaging in awake mice. *Nat. Methods* **16**,
550 1119–1122 (2019).
- 551 43. Kazemipour, A. *et al.* Kilohertz frame-rate two-photon tomography. *Nat. Methods* **16**,
552 778–786 (2019).
- 553 44. Wu, J. *et al.* Kilohertz two-photon fluorescence microscopy imaging of neural activity
554 *in vivo*. *Nat. Methods* **17**, 287–290 (2020).
- 555 45. de Vries, S. E. J. *et al.* A large-scale standardized physiological survey reveals functional
556 organization of the mouse visual cortex. *Nat. Neurosci.* **23**, 138–151 (2020).
- 557 46. Ohki, K., Chung, S., Ch'ng, Y. H., Kara, P. & Reid, R. C. Functional imaging with cellular
558 resolution reveals precise micro-architecture in visual cortex. *Nature* **433**, 597 (2005).
- 559 47. Skottun, B. C. *et al.* Classifying simple and complex cells on the basis of response
560 modulation. *Vision Res.* **31**, 1078–1086 (1991).
- 561 48. Yunzab, M., Cloherty, S. L. & Ibbotson, M. R. Comparison of contrast-dependent phase
562 sensitivity in primary visual cortex of mouse, cat and macaque. *NeuroReport* **30**, 960–965
563 (2019).
- 564 49. Niell, C. M. & Stryker, M. P. Highly Selective Receptive Fields in Mouse Visual Cortex. *J.*
565 *Neurosci.* **28**, 7520 (2008).
- 566 50. Chance, F. S., Nelson, S. B. & Abbott, L. F. Complex cells as cortically amplified simple
567 cells. *Nat. Neurosci.* **2**, 277–282 (1999).
- 568 51. Bonin, V., Histed, M. H., Yurgenson, S. & Reid, R. C. Local Diversity and Fine-Scale
569 Organization of Receptive Fields in Mouse Visual Cortex. *J. Neurosci.* **31**, 18506 (2011).

570 **Methods**

571 *Optical Layout*

572 The 3DScope (Supplementary Fig. 1) was set up on a 250 x 150 cm isolator table (Melles Griot
573 070T1035). The laser system (Pharos SP6, Light Conversion, Vilnius, Lithuania) consists of a
574 diode-pumped Yb:KGW mode-locked seed oscillator (1028 nm emission, 76 MHz repetition,
575 90 fs pulse duration, 1 W power), a diode-pumped Yb:KGW chirped-pulse amplifier (80 kHz
576 repetition, 190 fs duration, 75 μ J pulse energy, 6 W power) and an optical parametric amplifier
577 (630-2600 nm tuning range, Orpheus OPA, Light Conversion) delivering 400 mW of signal
578 output (800-1000 nm). Signal and idler beams are separated by a dichroic mirror of 1030 nm
579 cut-off in a double pass configuration at Brewster angle and collimated to a 13 mm beam waist
580 ($\sim 1/e^2$) by 5x (signal) and 2.6x (idler) Galilean telescopes using AR-coated BK7 plano-spherical
581 lenses. The acousto-optic (AO) devices of 15 mm active aperture were custom-made from
582 TeO₂ monocrystals by AA Opto-Electronic (Orsay, France) with a surface cut for
583 autocollimation of the input and coaxial direction of the first-order beam at the acoustic
584 carrier frequency. The cycle time $t_c = d/v$ is 24.6 μ s, with $d = 16$ mm, the crystal diameter, and
585 $v = 650$ m/s, the velocity for acoustic wave propagation in non-rotated biaxial TeO₂⁵². The AO
586 diffraction efficiency reaches at least 70 % at 36 MHz (800-1000 nm) and 28 MHz (1050-1300
587 nm) bandwidth through quasi-tangential phase match in anisotropic Bragg diffraction⁵². Two
588 AODs are oriented with their active axis parallel to the horizontal (X-AOD) and vertical (Y-AOD)
589 direction and 4f-conjugated by two achromats ($f = 100$ mm, $d = 30$ mm, Thorlabs). An AO
590 modulator (AOM) in 45° orientation is set up to fully compensate the angular dispersion in the
591 AODs at the carrier frequency and partially at side band frequencies⁵³. The distance between
592 the AOM and the AODs is adjustable through a two-mirror retro-reflection unit on a motorized
593 translator (150 mm travel, VT-80, PI Instruments) for tuning of temporal dispersion
594 correction⁵³. The AODs are conjugated to the optical back aperture (OBA) of the objective
595 (Olympus XLPlan N 25x 1.05 WMP; 8 mm focal length; 15.2 mm OBA diameter) through an
596 achromatic scan lens ($f = 300$ mm, $d = 2''$, Thorlabs) and a tube lens ($f = 200$ mm, $d = 36$ mm,
597 Nikon MXA 20696), yielding 1.5 angular magnification and 0.66 radial OBA fill factor. The
598 maximum mean power available behind the objective was 25 mW at 940 nm (40 kHz). The
599 microscope head uses the movable objective microscope (MOM; Sutter, Novato, CA)
600 configuration, which permits (x y z)-translations (± 12 mm) and rotation of the objective, and
601 an Olympus BX-RFA epifluorescence unit with a three-color light source (ScopeLED B 190). The

602 detection unit was *de-novo* designed. Using a light diffusion model⁵⁴, we derived a 9° half-
603 angle of diffusion-induced spread of emission light at the OBA for an assumed 1 mm thick
604 tissue volume, which defined the collection power of the downstream optics⁵⁵ equal to a
605 Helmholtz-Lagrange parameter of 45 mm². The detection unit features two detection
606 channels for green and red emission light, a 42 x 35 x 2.5 mm dichroic mirror (Chroma 720dxxr)
607 followed by IR block (d = 40 mm, Chroma ET750sp-1500), a large aperture collimator lens (f =
608 80 mm, d = 40, Edmund #48-239), a 46 x 34 x 1 mm secondary dichroic mirror (Chroma
609 T562lpxr), emission filters (d = 30 mm, ET520/60 and ET575lp, Chroma), an aspheric
610 condenser lens for each channel (f = 26.5 mm, d = 30 mm, Thorlabs ACL3026A) and two GaAsP
611 hybrid detectors (Hamamatsu R11322U-40). Optical layout was based on ray optics using
612 transfer matrices with subsequent refinement by ray tracing (OpticStudio; Zemax). The
613 microscope, excluding the wide-field imaging path, was coded in Rhinoceros 5 (McNeel) using
614 component CAD files from Thorlabs, Newport, Linos, Turbo Squid, Light Conversion and AA
615 Optoelectronic.

616 *Electronic layout*

617 In Bragg diffraction, the diffraction angle of the first order beam, Θ , is given by $\Theta = \lambda f / v$,
618 with λ , the optical wavelength in air, f , the acoustic carrier frequency, and v , the acoustic
619 velocity in TeO₂. To preserve this angle between different wavelengths of excitation, our
620 design keeps λf constant by adapting the carrier frequency according to $f_{AOD}(\lambda) =$
621 $81 \text{ MHz} \cdot 1000 \text{ nm} / \lambda$ and $f_{AOM}(\lambda) = \sqrt{2} \cdot f_{AOD}(\lambda)$. While the AOM operates at constant RF
622 frequency (MDS1, AA Opto-Electronic), the AODs operate on the basis of real-time RF
623 frequency and power update in time-locked FM/AM mode using fast-switching direct digital
624 synthesizer (DDS) circuits with 2.5 W power amplifiers (DDSPA, AA Opto-Electronic). A
625 synchronisation signal is generated with a Schmitt trigger (74VHC123A, Fairchild
626 Semiconductors) from the output of a fast photodiode at the exit of the Pharos pulse
627 compressor by picking every second pulse from the initial 80 kHz laser output. This timing
628 signal (Laser SYNC) then triggers two clock signals on a timer counter board (14 MHz, 345
629 cycle; NI PXIe-6612, National Instruments) to clock the real-time data transfer between digital
630 I/O channels (50 MHz; NI PXIe 6537, National Instruments) as the sender and the AOD DDS
631 boards (23 bit frequency resolution, 8 bit power resolution, 64 ns sweeping time) as receivers.
632 The FM/AM data are calculated on the host computer for every laser pulse and streamed with
633 forerun to the output devices through first-in-first-out (FIFO) memory stacks using direct

634 memory access (DMA). Data acquisition is gated by the laser SYNC to reject detector dark
635 noise during 25 μs inter-pulse intervals. As the expected photon flux amounts to several 100
636 emitted photons per laser pulse, and because the R11322U-40 photomultiplier has a
637 picosecond response time, 0.45 quantum efficiency and up to 2×10^5 gain, the expected
638 detector signal is a 3 ns anode current pulse of the order of 200 μA , or 10 mV at 50 Ω , when
639 assuming a 3 ns excited state decay time of EGFP⁵⁶. The detection chain consists of a 200 MHz
640 RC filter, a programmable low noise voltage amplifier (DHPVA, Femto, Berlin, Germany) and a
641 two-channel 800 MHz AC analog-to-digital converter (ADC) with ± 1 V input range at 12 bit
642 resolution (NI-5772, FLEX-RIO, National Instruments) in combination with a 50,950 slice field-
643 programmable gate array (FPGA) (NI PXIe 7971R, National Instruments). While the ADC runs
644 continuously, the FPGA circuit was set up to pick the wanted data from the data stream and
645 send them to the host. For this, the circuit runs a 200 MHz loop in phase with the 800 MHz
646 converter clock to read the ADC data (4 data words per cycle and channel) and keeps them in
647 a circular buffer. Once the laser SYNC trigger is received, pre-trigger samples (195 ns
648 pretrigger) of fixed length (75 ns gate window), to account for the delay of the SYNC signal
649 relative to the laser pulse, are retrieved from the buffer, summed and written to output FIFOs.
650 The amplifier gain (10 to 100) was adapted to match the ± 1 V ADC input range. The anode
651 output of the R11322U-40 was a linear function of the input light up to 10 μA mean and 30
652 mA peak anode current (measured with 200 MHz bandwidth). Low-incidence (< 0.001 per
653 sample) detector popcorn noise, possibly by bremsstrahlung-induced spurious photoelectron
654 emission, was removed in post-processing by outlier filtering with negligible loss of
655 information. The software operating the 3DScope was coded in LabVIEW 2015 (National
656 Instruments). The FPGA circuit was created with the Vivado 2014.4 compiler (Xilinx) under NI
657 RIO 17.0 (National Instruments).

658 *Iterative Fourier-Transform Algorithm*

659 In complex notation, the light electrical field is given by $A(x, y) e^{i\varphi(x, y)}$, with A, the amplitude,
660 and φ , the phase. In the iterative Fourier-Transform algorithm (Gerchberg-Saxton) the electric
661 field is transformed between the holographic plane (the back focal plane of the microscope
662 objective) and the Fourier plane (the front focal plane,) by forward and inverse Fourier
663 transforms under the constraint of a fixed constant amplitude in the holographic plane and
664 the wanted target amplitude distribution in the Fourier plane (Fig. 2a). Since the hologram

665 needs to be separable along the x- and y-coordinates⁵⁷, $A(x, y) = A_x(x) \cdot A_y(y)$ and
666 $\varphi(x, y) = \varphi_x(x) + \varphi_y(y)$, we performed independent searches for 1D holograms on the two
667 axes using a 10,000 point discretization grid of 30 mm length. The search loop was initiated in
668 the Fourier plane with a random phase. We then recovered the 2D hologram by combining
669 the two solutions in x-y coordinate space and reconstructed the intensity distribution in
670 Fourier space which included a non-linear propagator to obtain the light field outside of the
671 Fourier plane. However, valid holograms are not univocally defined by the target intensity
672 distribution in the focal plane. By looping through a number of searches (~10), we selected for
673 low FM and AM bandwidths to maximize the remaining modulation bandwidth and power
674 transmission of the system, respectively. As a consequence of AM modulation, the
675 transmission dropped by 45 %, 65 % and 65 % in AM/FM versus FM only mode for 3x3, 5x5
676 and 2x5 spot grids, respectively. In about a third of the experiments AM modulation was
677 prohibited because of insufficient laser power. In this case we used the FM-only mode with a
678 modified target pattern which included side lobes up to 5th order with up to 30 % primary
679 target spot intensity to achieve homogeneous intensity in primary target spots comparable to
680 the FM/AM mode. Finally, the RF signal to drive the AODs is obtained as the derivative of the
681 unwrapped holographic phase in x- and y-direction⁵⁷.

682 *Point-Spread-Function Measurement*

683 We used a custom-made transmission microscope to directly image the intensity distribution
684 in the focal plane from a thin fluorescent layer in the xy plane (Fig. 2c) through a high NA
685 objective (LEICA HC PL APO 40x/1.1 W) used with synthetic water immersion fluid (ZEISS
686 Immersol W). Samples were a fluorescein-doped spin-coated PMMA layer, a nano-plastic
687 slide⁵⁸ and a bulk layer of aqueous fluorescein (20 mM) of 10-20 μm thickness under a cover
688 slip. While the nano-slide was the only sample to provide a sub-resolution nominal thickness
689 (500 nm), the axial FWHMs of the measured PSF (0.25 μm z-steps) were consistent among the
690 three samples (Supplementary Fig. 3b), presumably because of the large NA difference of
691 focusing and imaging objective.

692 *Cell Motion Measurements*

693 To estimate x,y movements of brain cells during mouse behavior under our experimental
694 conditions we recorded time-lapse movies of EGFP-expressing neurons at 6-16 Hz frame rate
695 and registered the frames using NoRMCorre⁵⁹ which yielded cell displacements Δx , Δy with
696 respect to a fixed reference frame. For estimating axial movement, we additionally recorded

697 a reference z-stack of the same cell at 0.25 μm axial resolution, but with the animal held under
698 isoflurane anesthesia to suppress cell movement. In this case we used the focal image frame
699 of the z-stack as registration reference for the t-stack and calculated the correlation
700 coefficients between all t- and z-frames. For each t-frame a Δz -displacement is estimated as
701 the z-position of the z-frame yielding maximal correlation.

702 *Visual Stimulation*

703 Visual stimulus movies were generated in Matlab (R2013b, Mathworks) as a 8 bit gray scale
704 image stack at 500 x 400 pixel resolution. During run time, images were resized to 1280 x 1024
705 screen resolution of a 17" LED back-illuminated computer monitor (Dell E1715S) and played
706 at 30 Hz in sync with the vertical display retrace clock of the monitor using synchronization
707 tools from the Psychtoolbox (PTB-3) for Matlab. In addition, the screen back-illumination was
708 gated at 40 kHz under control of the laser SYNC such that the screen was off during a 20 μs
709 time window which included the acquisition gate (see Supplementary Fig. 11a). The screen
710 was placed at ~ 12 cm distance from the left eye of the animal such that the eye axis was
711 approximately normal and central to the screen covering a 110° (h) x 100° (v) lateral eye field.
712 We used three stimulus movies. A noise movie, shown to the animal during image stack
713 acquisition, was created by inverse Fourier transformation of a random spatial-temporal
714 frequency spectrum subject to a temporal cutoff of 4 cycles per second (cps) and a $1/f$ spatial
715 frequency envelope with half maximum value of 0.04 cycles per degree (cpd) and 0.15 cpd
716 cutoff⁶⁰. The second movie was composed of a sequence of moving sinusoidal gratings with
717 different orientations and fixed temporal (2 cps) and spatial frequency (0.04 cpd) at high
718 contrast (0.8). Each grating was shown for 3 s followed by 7 s of gray screen. Stimulus
719 sequences were repeated in following trails after a 30 s pause showing a black screen and in
720 each case started with 10 s of gray screen. The third movie showed sinusoidal gratings in pairs
721 of 0° and 90° orientation with each pair given another temporal frequency between 0.5 and 4
722 cps, at constant 0.04 cpd. The movies were shown on a gray background within a circular field
723 of 75° centered to a position on the screen which elicited largest activation of cells within the
724 imaged brain region ($\sim 250 \times 250 \mu\text{m}^2$). Stimulus on- and offset-times were annotated by
725 logging the CPU time and by recording the signal of a photodiode placed at the right lower
726 corner of the screen to record the contrast switch upon stimulus on- and offset. The
727 photodiode signal was acquired at 5 kHz on a PCIe-6351 ADC board (National Instruments)
728 using the microscope acquisition flag as a start trigger.

729 *Animal Welfare*

730 Experimental procedures were conducted in compliance with French and European laws,
731 including the “European Convention for the Protection of Vertebrate Animals used for
732 Experimental and other Scientific Purposes” (ETS 123), and following INSERM and NIH
733 institutional guidelines. All procedures were approved by the “Charles Darwin”-Ethics
734 Committee of École Normale Supérieure under project number 04828.02 and 12007.

735 *Surgical Procedures*

736 This work includes data from five female heterozygous pGAD65-EGFP⁶¹ mice (C57BL/6
737 background), aged 7-9 months, and 12 wild-type male C57BL/6 mice (Janvier Labs, France),
738 aged 3-6 months (ventilated home cage; $23 \pm 1^\circ$ C; 50 ± 5 % humidity; 12 h light/dark). The
739 animals received surgery for implantation of an optical cranial window. The skin over the
740 cranial bone was incised along the midline and retracted to both sides. The bone was treated
741 with hydrogen peroxide solution and adhesion primers (Optibond, Kerr), before a 6 mm
742 craniotomy of the parietal bone was performed over primary visual cortex of the right
743 hemisphere at -2.8 mm antero-posterior and 2.5 mm medio-lateral of Bregma. In the case of
744 the wild-type mice, 0.5 μ L virus solution was injected (Legato 130, KD Scientific) at 0.1 μ L/min
745 under stereotaxic control (# 942, Knopf) 300 μ m below the pia mater using quartz electrodes
746 (~20 μ m tip size) with a 10 μ L Hamilton syringe. Per animal, up to 3 injections were done with
747 lateral offsets of 200 to 500 μ m. Solutions were made up of AAV2/1-pSyn(h)-Cre-WPRE-GH
748 ($1.9 \cdot 10^{13}$ GC/mL; 1:1000) and AAV2/1-pSyn(h)-FLEX-GCaMP6f-WPRE-SV40 ($1.4 \cdot 10^{13}$ GC/mL;
749 1:30) using a Ringer base solution. In two mice, AAV2/1-pCAG-FLEX-tdTomato-WPRE-SV40
750 ($8.52 \cdot 10^{12}$ GC/mL 1:150) was added as a third virus. All viruses were supplied by the Vector
751 Core Facility of the University of Pennsylvania (Penn Vector Core, USA). Finally, the craniotomy
752 was covered with a 5 mm BK cover glass (0.15 mm thickness; Warner Instruments) and sealed
753 with UV-curable dental cement (Tetric Evoflow, Ivoclar Vivadent). In the last step, a headpost
754 was fixed to the skull with dental cement. The headpost was either an inox plate or a titan-
755 printed tower (Fig. 3a), both providing comparable mechanical rigidity. Virus-injected mice
756 were used for experiments during a time window of 1 to 4 weeks after injection.

757 *Additional procedures for in-vivo electrophysiology*

758 A total of seventeen 2-4 weeks old C57BL/6 mice (both genders; Charles River) were prepared
759 for simultaneous optical and cell-attached (loose patch) electrophysiological recordings. At
760 P17-30 a small injection craniotomy was performed over visual cortex and 250 nL of a virus

761 mixture of AAV2/1-pSyn(h)-Cre-WPRE-GH ($1 \cdot 10^{10}$ GC/mL) and AAV2/1-pSyn(h)-FLEX-
762 GCaMP6f-WPRE-SV40 ($2 \cdot 10^{12}$ GC/mL) was injected at 75 nL/min with an angle of 64° against
763 the normal at 2.8 mm posterior and 2.7 mm lateral of Bregma in the right hemisphere. After
764 1-2 weeks, the bone was thinned over the injection site and a head plate was cemented to
765 the skull. Under wide field excitation, the site of GCaMP6f expression was determined and a
766 craniotomy of approximately $0,7 \times 1$ mm was performed over the indicated region, followed
767 by a small durectomy about $450 \mu\text{m}$ lateral of the intended recording site. Under the 3DScope,
768 anesthetized mice (1.65 g/kg urethane in 0.9 % NaCl i.p.) were kept on a heating pad under
769 continuous monitoring of the breathing rhythm. A 5-15 MOhm borosilicate patch pipette filled
770 with artificial cerebral spinal fluid (ACSF) solution (in mM: 140 NaCl, 2.5 KCl, 1.5 CaCl_2 , 1.5
771 MgCl_2 , 30 Hepes, pH 7.3 with NaOH, 0.1 Alexa 954 hydrazide) and a supplement to increase
772 cell firing during membrane approach (3.5 mM potassium gluconate or 20 nM kainate) was
773 lowered into the durectomized area and slowly advanced towards the target region (PatchStar
774 Micromanipulator, Scientifica) under an angle of $\sim 70^\circ$ versus normal at positive electrode
775 pressure. During experiments, the craniotomy was superfused with HEPES-buffered ACSF of
776 34°C at 2 ml/min using a peristaltic pump (IPC, Ismatec) with an in-line solution heater (SF-28,
777 Warner). Membrane sealing was helped by hyperpolarizing the electrode to -70 to -40 mV in
778 voltage-clamp mode (MultiCamp 700 B, Molecular Devices). A frame sync signal was recorded
779 together with the electrode current (20 kHz; Digidata 1440 A, Molecular Devices) for post-
780 alignment of optical and electrophysiological recordings.

781 *Experimental Protocol*

782 Four days before start of recording sessions novice mice were accustomed to human handling,
783 head fixation and walking on a treadmill. The custom-made treadmill⁶² featured a PLA-printed
784 outward treadmill of 7.7 cm diameter with grip bars fitting the size of the mouse paw, side
785 barriers to safeguard the animal on the track and an optoelectronic rotation decoder to report
786 the walking distance (HEDS-5645#A06, Broadcom). The decoder signal (two phase-shifted
787 pulse trains of 500 counts per rotation (cpr) and 1 cpr, respectively) were digitized at 10 kHz
788 on a USB-ADC unit (USB-6259 BNC, National Instruments) and decoded for locomotion
789 direction and speed by a custom virtual instrument in LabVIEW 2017. In 21 experiments, we
790 anesthetized the animal under head clamp with a custom-designed anesthesia mask effusing
791 3 % isoflurane with 20 % O_2 and 80 % N_2O (1 L/min). Following induction, we reduced to 1.2
792 to 1.5 % isoflurane, installed a heat pad for homeothermic control to 37°C (H-800156, Harvard

793 Instruments) and began monitoring the respiration rate using a piezoelectric diaphragm (7BB-
794 20-6, Murata). After administration of a sedative (Astenodex, 0.1 mL/kg i.p.) isoflurane was
795 further reduced to 0.25 to 0.5 %. At this stage, the respiratory rhythm was low (1-2 beats/s),
796 vibrissae were inactive, the animal was not reacting to whisker touch or body squeezes, but
797 would weakly react to strong paw pinches. This condition was stable for at least one hour. For
798 longer recordings, a second Astenodex dose was given. Experimental sessions were limited to
799 a maximum of two hours.

800 *Data Acquisition*

801 Image stacks were acquired at 300 x 300 pixel resolution at 2 to 2.5 μm z-steps and using one
802 laser pulse per pixel resulting in 2.25 frames/s acquisition speed. Every stack extended 200
803 μm above and below the focal plane which was set at 300 to 380 μm below the pia mater in
804 layer 4. From these stacks, cell bodies were manually selected as POIs using custom tools in
805 the 3DScope GUI to add the (xyz) center coordinates to a job list for the scan engine together
806 with the laser power and hologram to be applied, making these parameters freely eligible for
807 every POI and laser pulse. In this work we used point grids (5x5 and 2x5) for all POIs, but
808 adapted the size depending on laminar position of target cells in layer 2/3, 16x16 μm^2 (5x5)
809 and 24x24 μm^2 (2x5), or layer 5, 18x18 μm^2 (5x5) and 28x28 μm^2 (2x5). The laser power was
810 adapted assuming a scattering length of 200 μm . After every experiment performed in the
811 CASH mode, we verified the cell coordinates by acquiring micro-frame images of 25x25 pixel
812 size centered at the programmed cell coordinates. In cases where we found a drift, we
813 discarded the CASH data and repeated the measurement. All GCaMP6f recordings were using
814 940 nm excitation.

815 *Data Analysis*

816 Fluorescence traces were normalized by the median using a running window of 50 s and
817 detector popcorn noise was removed with a three-point Hampel filter. Our infection protocol
818 yielded expression in neurons of layer 2/3 and layer 5 close to the injection site whereas
819 neurons in intermediate layer 4 were generally not infected. Our assignment of neurons to
820 layer 2/3 or 5 was therefore unambiguous in most cases. However, in a few cases, GCaMP6f-
821 expressing cell bodies were found in positions that seemed to belong to the granular rather
822 than the supra-granular layer. In our assignment we did not distinguish these cells and labeled
823 them layer 2/3 throughout. For evaluating the effect of locomotion on GCaMP6f visual
824 responses we determined the maximum velocity of the animal during a time window starting

825 6 s before presentation of the stimulus onset and ending at stimulus offset (3 s after stimulus
826 onset). This ad-hoc choice was motivated by the observation that locomotion episodes often
827 lasted longer than the stimulus (3s) and that the effect of neuromodulation may last over
828 several seconds⁶³. In case of EGFP signal-to-noise (SNR) was calculated as $SNR := \langle F \rangle / SD(F)$
829 and in case of GCaMP6f as $SNR := S_{peak} / SD_{baseline}$ with S_{peak} , the peak response amplitude,
830 and $SD_{baseline}$, the standard deviation of the baseline defined as width of the negative tail of
831 the $\Delta F/F$ trace histogram or, alternatively, as the standard deviation of the $\Delta F/F$ trace after
832 high-pass filtering with 4 Hz cutoff. Central tendency and spread of measured data are given
833 as mean \pm SD, unless stated otherwise. Sampling rates are given in Hertz or, for avoidance of
834 ambiguity, in kilo samples per second (kS/s).

835 *Neuropil Correction*

836 Corrections for neuropil activity were obtained by subtracting the neuropil traces (NP) from
837 the traces obtained from the cell body (CB) using a global weight factor alpha, $[\Delta F/F](t; \alpha) =$
838 $[\Delta F/F]_{CB} - \alpha [\Delta F/F]_{NP}$. We used two different algorithms to determine the α parameter. In noise
839 regression, we minimized the width of the negative tail of the trace histogram, departing from
840 the idea that low frequency baseline fluctuation is a consequence of population calcium
841 activity as reported in $[\Delta F/F]_{NP}$, thus $\alpha = argmin\{SD(\Delta F/F(t; \alpha) \leq 0)\}$. Alternatively, we
842 performed correlation regression seeking to decorrelate the baselines of the cellular and the
843 neuropil traces, e.g. $\alpha = argmin\{corr(\Delta F/F(t; \alpha) \leq 0, [\Delta F/F]_{NP}(t) \leq 0)\}$. In this case,
844 we obtained the alpha value as the slope of a linear fit to $[\Delta F/F(t)]_{NP}$ and $[\Delta F/F(t)]_{CB}$ data pairs
845 presented as xy-plot (Supplementary Fig. 7c). To exclude the contribution of neuronal activity,
846 we divided the $[\Delta F/F]_{CB}$ axis into 50 bins and included into the fit only those pairs with $[\Delta F/F]_{CB}$
847 values smaller or equal to the 10 %-tile of $[\Delta F/F]_{CB}$ in every bin. Corrected traces were
848 smoothed with a three-point running average filter.

849 *Deconvolution of GCaMP6f recordings*

850 For MLspike event detection, we used as template for the GCaMP6f response: τ_{on} (50 ms), τ_{off}
851 (300 ms), $\Delta F/F$ amplitude (0.075) for a single spike and a hill coefficient (1.7) based on data
852 given in³⁶, together with maximal baseline drift (0.02/s). For the analysis of the dataset with
853 synchronous membrane current recording the template was updated to:

854 τ_{on} (90 ms), τ_{off} (370 ms), $\Delta F/F$ amplitude (0.075) for a single spike and a hill coefficient (1.7).

855 Spike-triggered average GCaMP6f waveforms were fitted with a bi-exponential response

856 function $f(t; a, b, \tau_{on}, \tau_{off}) := b + a \cdot (1 - \exp[-(t - t_{spike})/\tau_{on}]) \cdot$
857 $\exp[-(t - t_{spike})/\tau_{off}]$, with τ_{on}, τ_{off} , the rise and decay time constants of the GCaMP6f
858 response, respectively, and t_{spike} , the MLspike-inferred spike time.

859 *Visual Stimulus Response*

860 For neuron response to a contrast-grating stimulus, we defined the fluorescence stimulus
861 response $r_F(\Theta) := 1/n \sum_{i=1}^n [\Delta F/F](i; \Theta)$ with n , the number of samples from onset to
862 offset of the stimulus, and Θ , the stimulus orientation. We judged a response significant
863 ($\Delta F/F+$), if among all orientations of a given grating the mean response to at least one
864 orientation surpassed three times the baseline noise given by the standard error of the mean
865 (SEM) of the signal during a 3s pre-stimulus period. For ($\Delta F/F+$) neurons, we calculated the
866 global orientation selectivity index, gOSI, as vector sum of the responses over all orientations:
867 $gOSI := \sum_{\Theta} r_F(\Theta) e^{i2\Theta} / \sum_{\Theta} r_F(\Theta)$. Likewise, the global direction selectivity index: $gDSI :=$
868 $\sum_{\Theta} r_F(\Theta) e^{i\Theta} / \sum_{\Theta} r_F(\Theta)$. To judge statistical significance of orientation selectivity, we
869 calculated gOSI from bootstrap data by drawing bootstrap responses for every orientation of
870 the grating by random selection with replacement from the set of responses of the same
871 neuron across all orientations and stimulus repetitions. We then evaluated the SD of $|gOSI|$
872 from 10^4 bootstraps as an estimate of $|gOSI|$ variance of isotropic responses and defined
873 orientation-selective neurons (OS+) as neurons with $|gOSI|$ equal or larger than two times the
874 SD of the index in the isotropic case. For (OS+) neurons, we evaluated the preferred
875 orientation as $\Theta_{pref} = 0.5 \cdot \text{atan}(\text{Im}(gOSI)/\text{Re}(gOSI))$ and the specific orientation
876 selectivity index $OSI(\Theta) := [r_F(\Theta) - r_{\perp}(\Theta)]/[r_F(\Theta) + r_{\perp}(\Theta)]$ with $r_{\perp}(\Theta)$, the mean response
877 to orientations orthogonal to Θ . From OSI we obtained a second estimate for the preferred
878 orientation by global fit to a biphasic von Mises function $OSI_{fit}(\Theta; \theta_{pref}, c_1, c_2, c_3) = c_1 \cdot$
879 $e^{(\cos(\Theta - \theta_{pref}) - 1)/c_2} + c_3 \cdot e^{(\cos(\Theta - \theta_{pref} + 180^\circ) - 1)/c_2}$. The R_1/R_0 ratio was calculated from R_1 ,
880 the peak-to-peak amplitude of the Fourier component at stimulus frequency, ν_{stim} , of the
881 spike PSTH $R_1 := 2 \cdot \sum_{\nu_{stim} - 0.5\text{Hz}}^{\nu_{stim} + 0.5\text{Hz}} [FFT\{PSTH(R; \Delta t)\}(\nu)]$, with R , the spike rate, and Δt , the
882 binning width (80 ms) and the mean spike rate $R_0 := \text{mean}\{PSTH(R; \Delta t)\}$. We determined
883 R_1/R_0 separately for the forward and counterpropagating stimulus of preferred orientation to
884 identify the larger of the two.

885 *Evaluation of Spike Detection Error*

886 To simulate a fluorescence signal $F(t)$, we generated poisson trains of spikes $N(t)$ at a firing
887 rate of 0.2 Hz, we sampled the signal at 250 Hz, convolved it with a kernel modeling GCaMP6f
888 kinetics $K(\tau) := \exp(-\tau/\tau_{decay})(1 - \exp(-\tau/\tau_{rise}))$ with a rising time (τ_{rise}) and decay
889 time (τ_{decay}) of, respectively, 100 ms and 300 ms, and added Gaussian photonic noise $\epsilon(t)$.
890 In order to model the neuropil component, we added a neuropil signal $FNP(t)$ extracted from
891 the experiments, to obtain the the simulated fluorescence $F(t) = \int K(\tau)N(t - \tau)d\tau +$
892 $\epsilon(t) + FNP(t)$. To probe the neuropil correction estimator, we first corrected $F(t)$ using
893 noise regression or correlation regression and inferred spike trains from the corrected
894 fluorescence signal using MLspike and BSD. Spikes were considered as detected, if they were
895 found in a fixed incidence time window of either 12 or 20 ms around the true spike. The
896 estimation accuracy was quantified by the error rate (ER), the complement of the F-score:
897 $ER = 1 - 2 \cdot \text{Sensitivity} * \text{precision} / (\text{Sensitivity} + \text{Precision})$, with sensitivity and
898 precision defined as:
899 sensitivity = (number of detected true spikes)/(total number of true spikes)
900 and precision = (number of detected true spikes)/(total number of detected spikes).
901 ER, sensitivity and precision were evaluated for SNRs from 2 to 5 from 600 spikes in simulated
902 trials of 3000 s duration.

903 *Correlation analysis*

904 To characterize the structure of pairwise neuronal correlation, we performed principal
905 component analysis (PCA) on the Pearson correlation matrix calculated from GCaMP6f traces.
906 For each data set, the first three eigen vectors (principal components, PCs), sorted by their
907 eigenvalues, were kept for explanation of largest variance. For these three PCs, we extracted
908 the weights of individual cells and correlated the weights of all cells with their z-position
909 obtained from the imaging stack. Among the three highest PCs we identified for each dataset
910 the PC that showed the highest correlation of weight and z-position. To analyze synchronicity,
911 we computed the cross-correlation of $\Delta F/F$ traces between all cells and extracted the time lag
912 from -500 to 500 ms yielding the highest correlation coefficient. From these data we
913 calculated the histograms of the maximal time lags for cell pairs within layer 2/3, within layer
914 5 and across the two layers. We used the widths of these distributions, given by their standard
915 deviation, δt , as a measure of synchronicity among cells in each group.

916 *Spike propagation analysis*

917 We reconstructed spike trains from the GCaMP6f traces using blind sparse deconvolution
 918 (BSD). For every neuron i and every emitted spike s at time $t_{i,s}$ we searched for all neurons j
 919 the spike s' such that $t_{j,s'} - t_{i,s}$ is minimal with $d_{i,j,s} := \min_s(t_{j,s'} - t_{i,s} > 0)$, the
 920 corresponding time delay, see Fig. 6n. To distinguish intra- and inter-laminar temporal spike
 921 order, we computed N_i^j , the number of spikes emitted by neuron i having a closest follower
 922 spike in a neuron j , $n_k^l := \sum_{i \in L_k} \sum_{j \in L_l} N_i^j$, the number of spikes emitted by neurons in layer k
 923 having first follower spikes in layer l , and $n_k^T := \sum_l n_k^l$, the total number of spikes emitted by
 924 neurons in layer k , with L_k , the subset of cells in layer k , $k = [2/3,5]$. From these numbers we
 925 calculated $p_k^l := n_k^l/n_k^T$, the probability of a spike emitted by a neuron in layer k having a first
 926 follower spike in layer l (Supplementary Fig. 11b). We also calculated the normalized
 927 probabilities $\hat{p}_k^l := p_k^l/(f_l \cdot N_l)$, the probabilities p_k^l divided by the number of cells in the
 928 follower layer l , N_l , and the mean spike rate, f_l , in the follower layer l (Fig. 6o). Data analysis
 929 was performed in Matlab R2019b (Mathworks).

930

931 **References Methods**

- 932 52. Xu, J. & Stroud, R. *Acousto-Optic Devices*. (John Wiley, 1992).
- 933 53. Kremer, Y. *et al.* A spatio-temporally compensated acousto-optic scanner for two-photon
 934 microscopy providing large field of view. *Opt. Express* **16**, 10066–10076 (2008).
- 935 54. Beaupaire, E. & Mertz, J. Epifluorescence collection in two-photon microscopy. *Appl.*
 936 *Opt.* **41**, 5376–5382 (2002).
- 937 55. Oheim, M., Beaupaire, E., Chaigneau, E., Mertz, J. & Charpak, S. Two-photon microscopy
 938 in brain tissue: parameters influencing the imaging depth. *J. Neurosci. Methods* **111**, 29–
 939 37 (2001).
- 940 56. Striker, G., Subramaniam, V., Seidel, C. A. M. & Volkmer, A. Photochromicity and
 941 Fluorescence Lifetimes of Green Fluorescent Protein. *J. Phys. Chem. B* **103**, 8612–8617
 942 (1999).
- 943 57. Akemann, W. *et al.* Fast spatial beam shaping by acousto-optic diffraction for 3D non-
 944 linear microscopy. *Opt. Express* **23**, 28191–28205 (2015).
- 945 58. Antonini, A., Liberale, C. & Fellin, T. Fluorescent layers for characterization of sectioning
 946 microscopy with coverslip-uncorrected and water immersion objectives. *Opt. Express* **22**,
 947 14293–14304 (2014).

- 948 59. Pnevmatikakis, E. A. & Giovannucci, A. NoRMCorre: An online algorithm for piecewise
949 rigid motion correction of calcium imaging data. *J. Neurosci. Methods* **291**, 83–94 (2017).
- 950 60. Niell, C. M. & Stryker, M. P. Highly Selective Receptive Fields in Mouse Visual Cortex. *J.*
951 *Neurosci.* **28**, 7520 (2008).
- 952 61. Erdélyi, F. *et al.* Preferential Origin and Layer Destination of GAD65-GFP Cortical
953 Interneurons. *Cereb. Cortex* **14**, 1122–1133 (2004).
- 954 62. Villette, V., Levesque, M., Miled, A., Gosselin, B. & Topolnik, L. Simple platform for chronic
955 imaging of hippocampal activity during spontaneous behaviour in an awake mouse. *Sci.*
956 *Rep.* **7**, 43388 (2017).
- 957 63. Reimer, J. *et al.* Pupil fluctuations track rapid changes in adrenergic and cholinergic
958 activity in cortex. *Nat. Commun.* **7**, 13289 (2016).
- 959

Extended Data Figures

3DScope

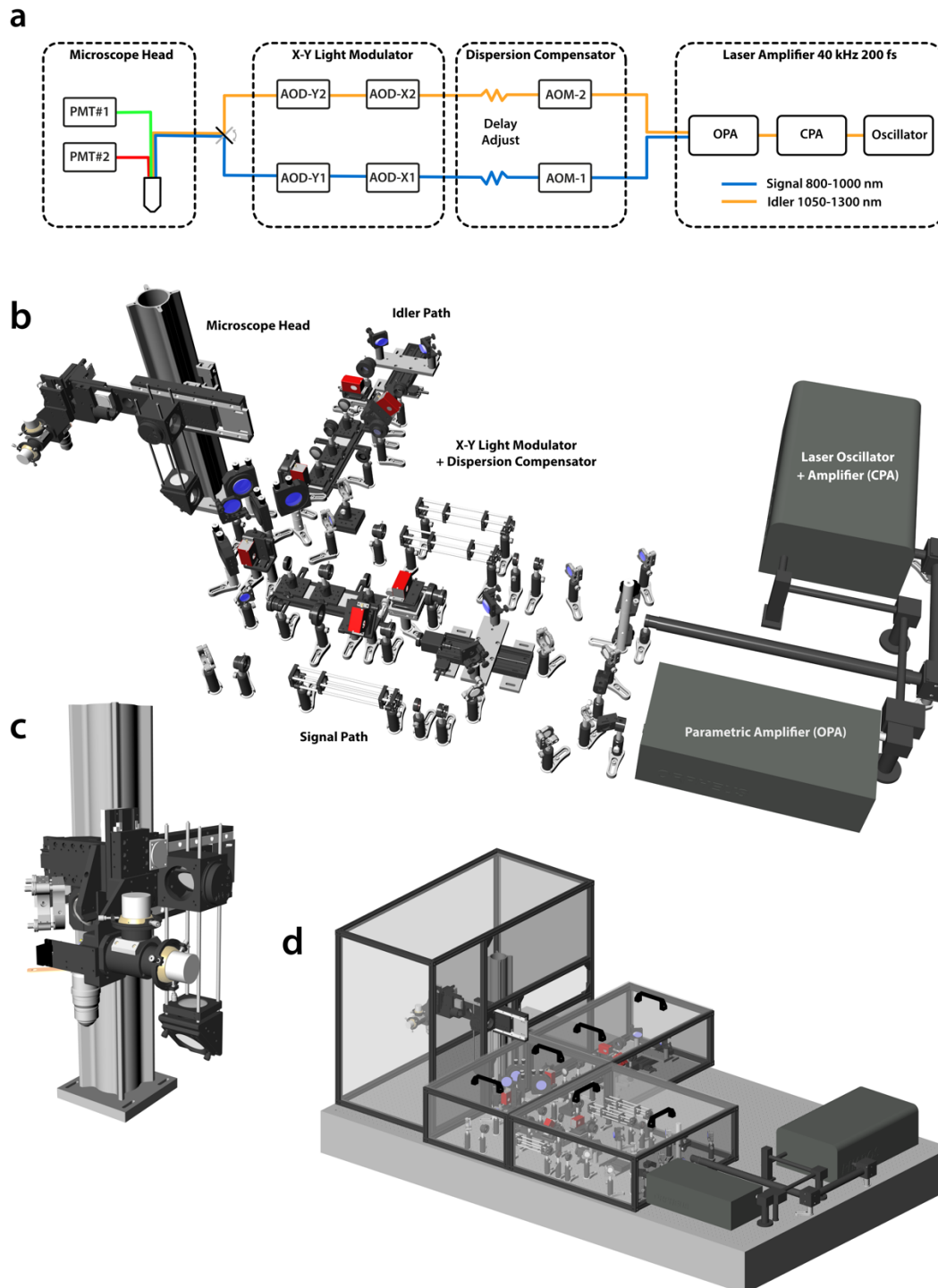

Extended Data Fig. 1 Optical hardware (3DScope)

a) Schematic representation of the active components in the signal and idler paths of the microscope (PMT: photomultiplier tube detector; AOD: acousto-optic deflector; AOM: acousto-optic modulator; OPA: optical parametric amplifier; CPA: chirped pulse amplifier). **(b-d)** 3D-rendered views of the microscope. **(b)** Top view without table and safety walls. **(c)** Microscope head with XYZ-movable objective (modified Movable Objective Microscope, MOM, Sutter Instruments) with added 2" periscope and custom-designed relay optics and detection unit. **(d)** Complete view with transparent safety walls for the purpose of visualization.

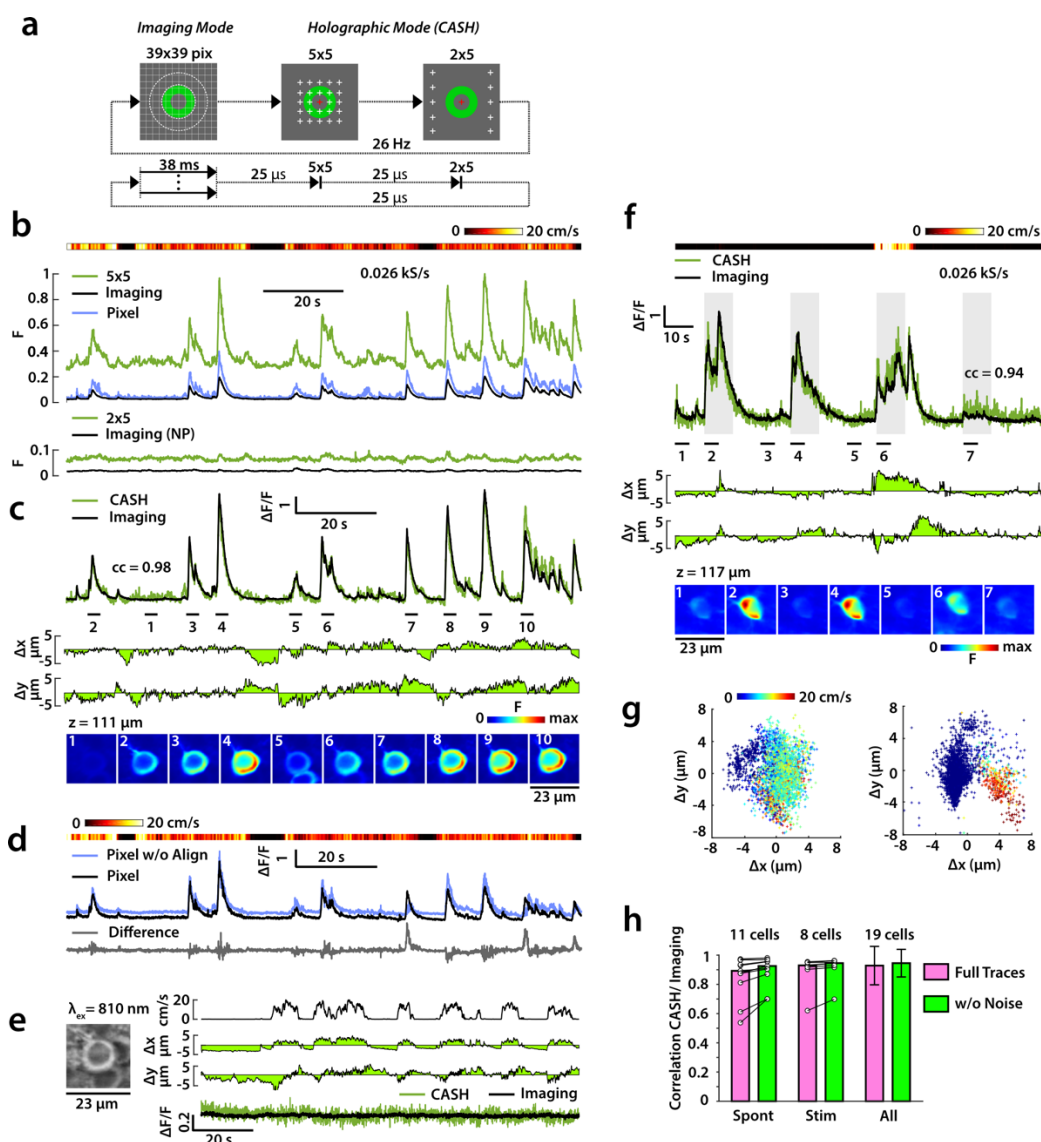

Extended Data Fig. 2 Simultaneous CASH and image-scan recording

(a) Experimental design: A single GCaMP6f-expressing cell is targeted first with a cell-centered image scan (39x39 pixels, 38 ms scan time) followed by a two-shot CASH acquisition (50 μ s) resulting in 26 Hz loop rate. **(b)** Example recording (130 s) of spontaneous activity showing (*top to bottom*) the motion of the animal, absolute fluorescence signal obtained from 5x5 CASH (green), imaging (black; pixel mean after image stack alignment), the brightest pixel of the aligned image stack (blue), the 2x5 CASH signal (green) and the imaging-derived neuropil signal (black; pixel mean across a concentric region around the cell body). **(c)** *Top*: Overlay of $\Delta F/F$ fluorescence traces after neuropil (NP) correction and normalization minimizing the global mean squared difference. The alignment yields 0.98 coefficient of correlation (cc). *Middle*: amplitudes of cell motion in x and y direction from alignment of image frames. *Bottom*: fluorescence images of the targeted cell at different instants as marked above (black lines). **(d)** Overlay of the single pixel trace before (blue) and after (black) x,y-alignment of the time lapse image sequence. **(e)** Overlay of a CASH (green) and imaging (black; same cell as above), but with 810 nm excitation for Ca^{2+} -independent fluorescence (*bottom*), with x,y cell motion (*middle*) and running speed of the animal (*top*). **(f)** *Top*: overlay of single-trial CASH (green) and imaging (black) recordings (different cell) during presentation of a visual noise stimulus (gray bars) yielding 0.94 correlation. *Middle*: x,y cell motions. *Bottom*: Snapshot fluorescence images of the cell at instants indicated by bars above (black). **(g)** 2D representation of x,y cell motion during recordings in (b; *left*) and (f; *right*) with moving speed of the animal in false color. **(h)** Coefficient of correlation of GCaMP6f traces of simultaneous CASH and imaging recordings, analogous to (b) and (f), for all recorded cells (violet bars; median) and of the same traces after removal of photon noise by MLspike deconvolution fit (green bars; median). The number of observed cells are indicated above. Error bars represent SD.

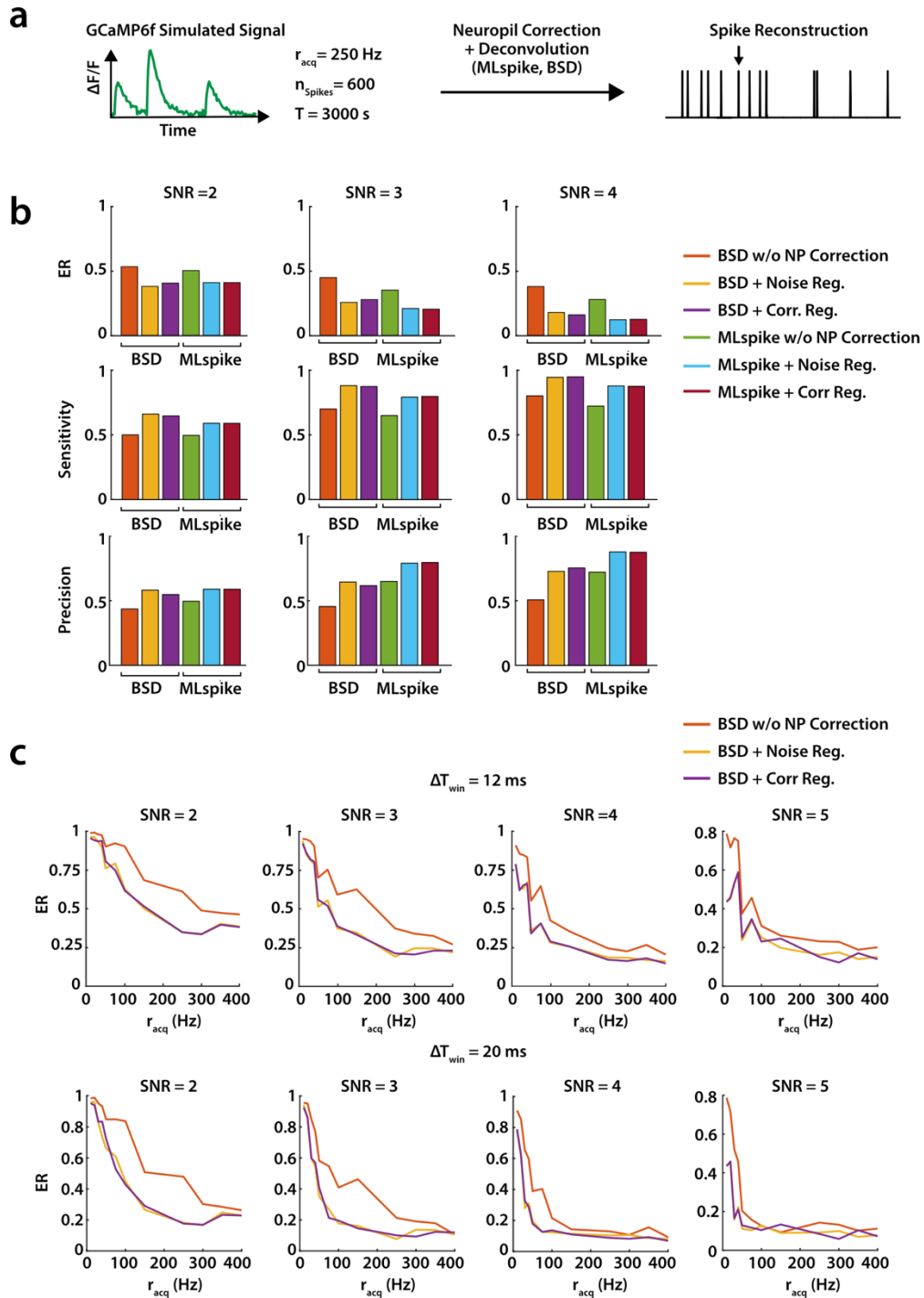

Extended Data Fig. 3 Event Detection accuracy evaluated on simulated data

a) Workflow schematic: We generated GCaMP6f-like neural calcium activity ($r_{acq} = 250$ Hz, 600 spikes, mean firing rate 0.2 Hz, 3000 s) contaminated with a neuropil signal. After neuropil correction, we deconvoluted the data and from inferred spikes evaluated the error rate (ER), the sensitivity and the precision of inference. **(b)** Error rates for artificial data (SNR 2, 3 and 4) according to neuropil correction (noise- or correlation regression) and inference algorithm (MLspike and BSD). **(c)** Error rate as function of acquisition rate, r_{acq} , for data with SNR between two and five obtained with the BSD algorithm for two window sizes ΔT_{win} (12 and 20 ms). A spike is rated as detected, if the spike falls within this time window centered around the time of the true spike.

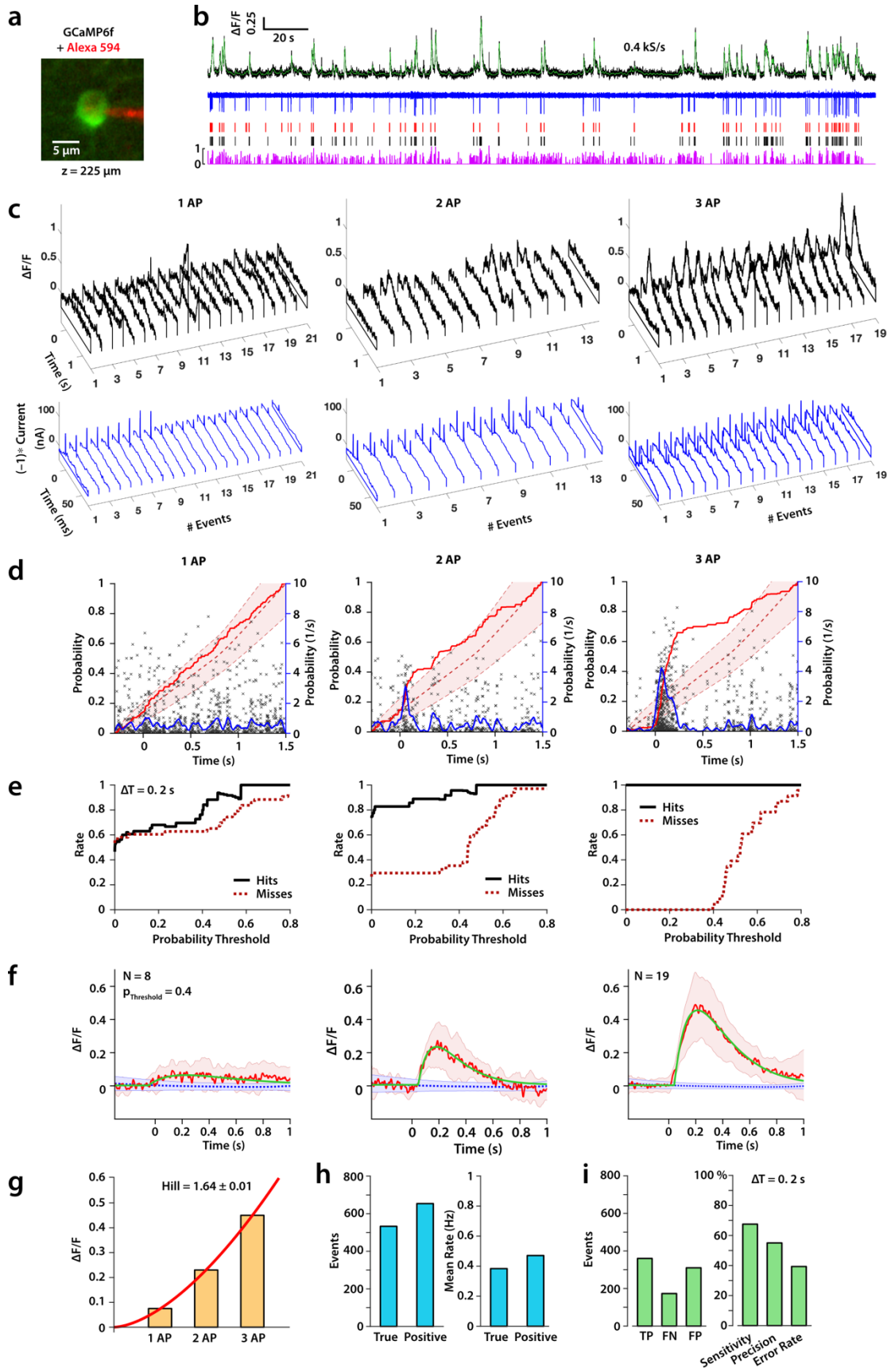

Extended Data Fig. 4 Simultaneous CASH and cell-attached patch recording

(a) Image of patch electrode-targeted neuron expressing GCaMP6f (green) and membrane-attached electrode filled with Alexa 594 (red). **(b)** Five minutes example recording from the neuron shown in (a) with GCaMP6f signal (black), MLspike-retrieved GCaMP6f signal (green), electrode current at -65 mV holding potential (blue), position of spikes inferred from the current trace (red), spikes obtained from MLspike deconvolution (black) and MLspike-estimated spike probability (magenta). **(c)** Spike-sorted GCaMP6f transients in black (first row) and electrode-measured spikes in blue (second row) for single (1 AP; 21 events), double (2 AP; 14 events) and triple (3 AP; 19 events) action potential events with the first spike at time zero and drawn from 23 minutes total recording time. Detection was subject to the condition that no further event is found during 0.6 s before the first spike and 0.7 s after the last spike. The incidence window was 30 ms. **(d)** MLspike-estimated spike probability (black crosses) for events shown in (c) in the -0.3 to 1.5 s from the electrode-detected spike event at time zero, together with the normalized cumulative probability (red) and probability density calculated with a gaussian kernel (20 ms; blue). Dotted curve (red) represents the cumulative ensemble probability at \pm SD confidence (dotted red band) bootstrapped from segments of the recordings (10^4 repetitions) where no spikes were detected. **(e)** Diagnostic of optical spike detection for 1-3 AP events as function of a probability threshold with a 0.2 s detection window following an electrode-detected spike. The true positive (hit) and false negative (misses) rate was calculated from the MLspike-detected events reaching a probability beyond threshold anywhere within the detection window. **(f)** Spike-triggered average of the GCaMP6f transient for 1 AP (8 events), 2 AP (6 events) and 3 AP (19 events) which surpassed a 0.4 probability threshold (red) with \pm 1 SD (red band), biexponential fit to the mean (green; 0.33 ± 0.4 decay time constant) and the \pm 1 SD bootstrap distribution of GCaMP6f transients in absence of spike events (blue). **(g)** Mean GCaMP6f response amplitude for 1-3 AP events obtained from the thresholded spike response in (f), together with polynomial fit (red). **(h)** *Left*: Total number of electrode-detected spike events (true events) and MLspike-detected events (positive events). *Right*: Mean firing rate across the whole data set evaluated from true or from positive events, respectively. **(i)** *Left*: True positives (TP), false negatives (FN) and false positives (FP) counts across the whole data set when applying a 0.2 s detection window. *Right*: MLspike inference sensitivity, precision and error rate evaluated from the counts in (h, *left*) and (i, *left*).

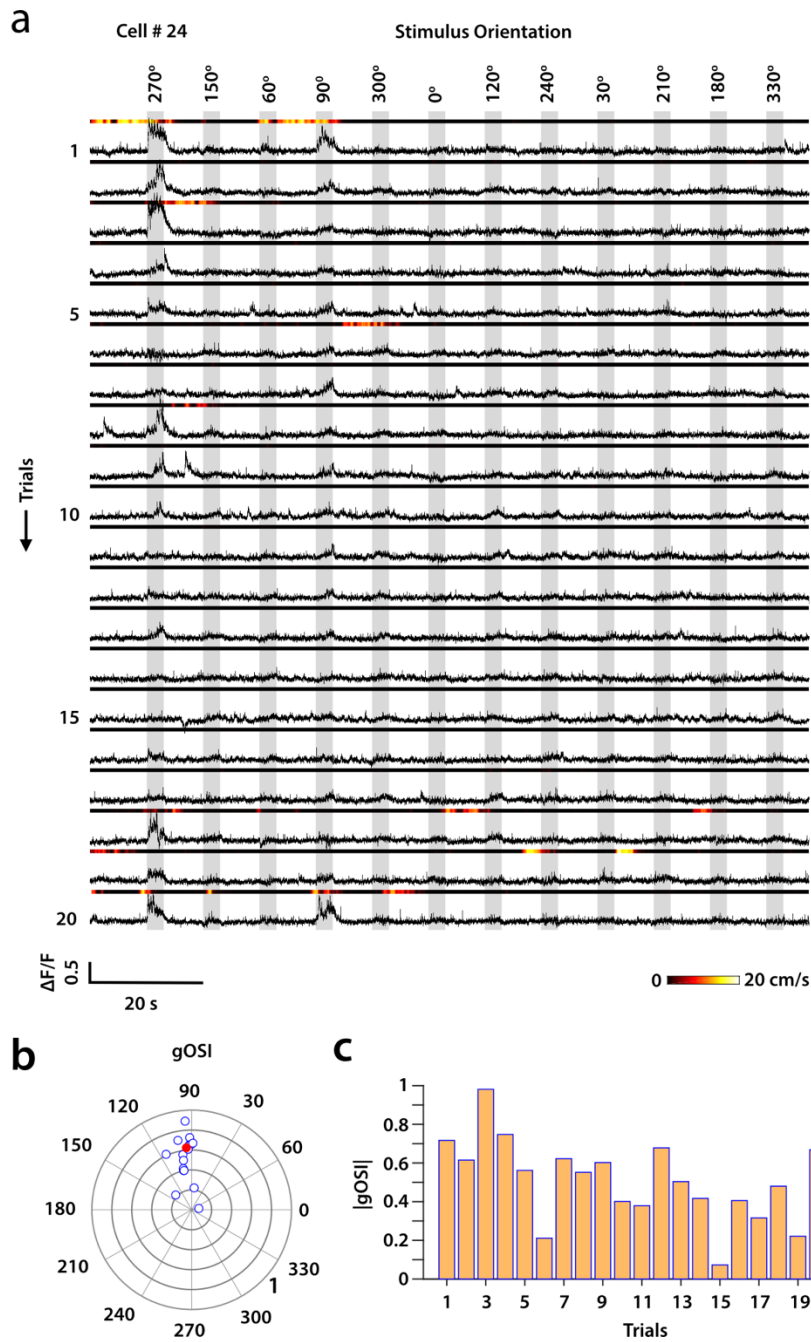

Extended Data Fig. 5 Example cell with orientation-tuned response

GCaMP6f orientation-sensitive visual responses (cell # 24 in Fig. 5d-f). **(a)** GCaMP6f fluorescence signal in response to the repeated presentation (20 repeats) of the same stimulus series (gray bars) with orientations indicated on the top of the figure. The moving speed of the animal is shown for every trial as a false-color bar together with the GCaMP6f trace (black). **(b)** Global orientation sensitivity index (gOSI) derived from single trials (blue dots) and from the trial average (red dot). **(c)** gOSI amplitude for all trials.

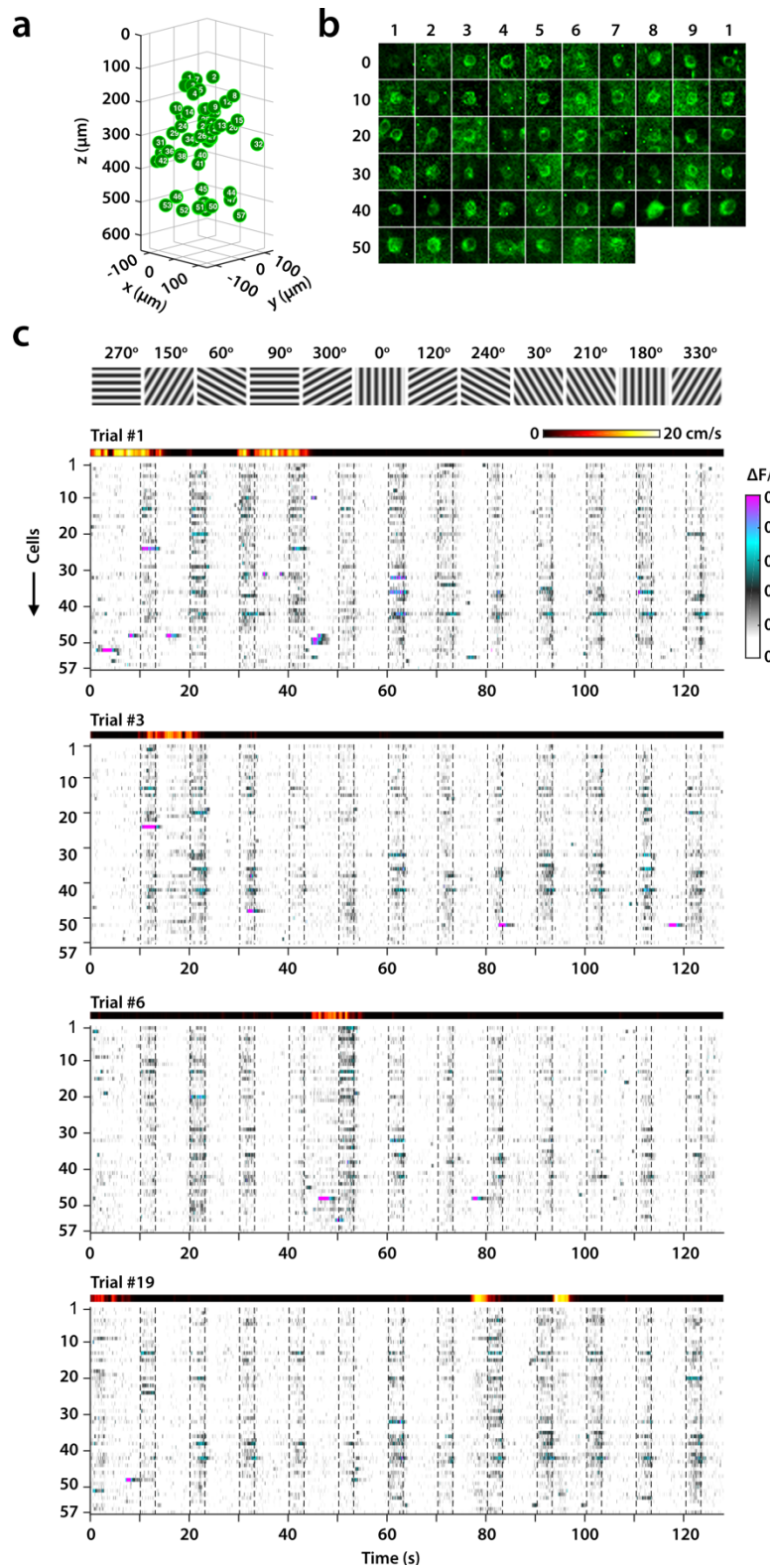

Extended Data Fig. 6 Single trial visual responses in a cell population

(a) 3D coordinates of cells in the dataset (same as in Fig. 5b-h). **(b)** GCaMP6f fluorescence images of all cells in the dataset. **(c)** False-color representation of GCaMP6f fluorescence responses to visual contrast grating stimuli (vertical dotted lines). Shown are the responses in trials n° 1, 3, 6 and 19 of a total of 20 trials (trial average shown in Fig. 5b) together with the locomotion velocity as horizontal color bar. The orientation of stimulus gratings, same for all trials, are shown on the very top.

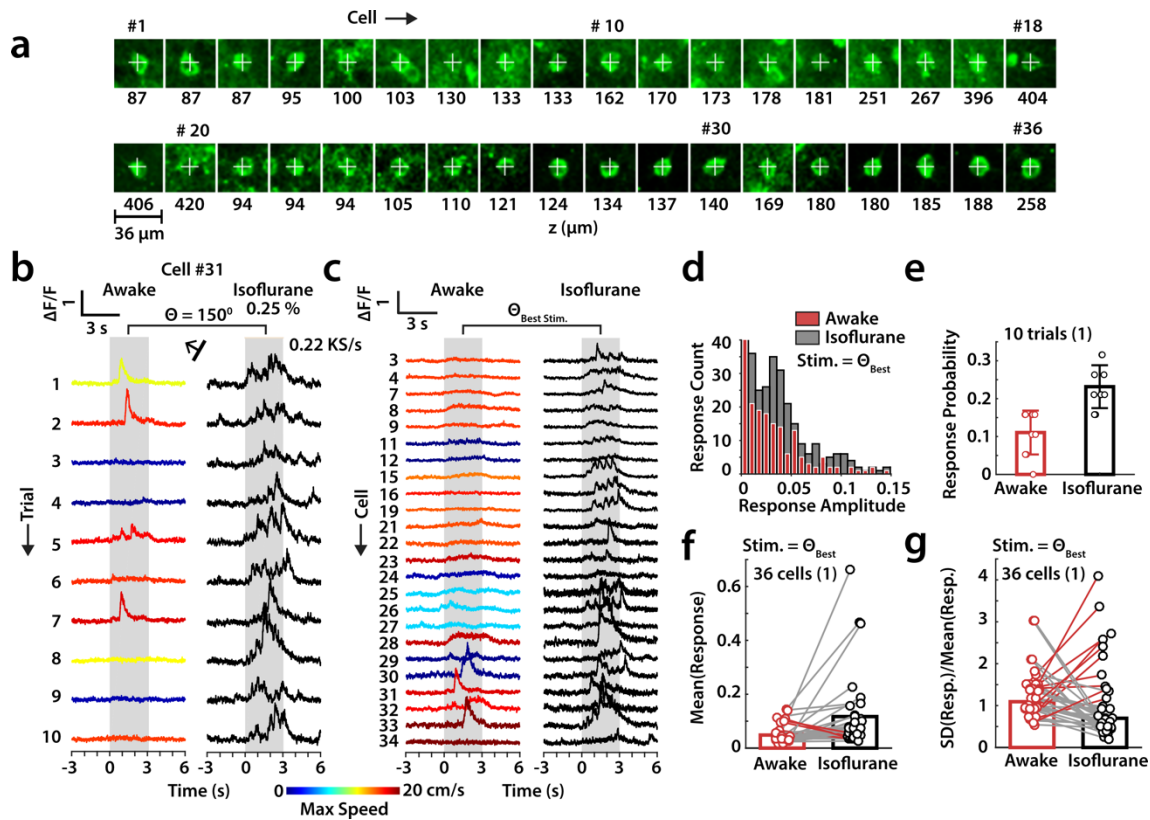

Extended Data Fig. 7

GCaMP6f responses of V1 cells in the awake versus the anesthetized state

(a) Fluorescence images of 36 cells (L2/3; two experiments; one animal) that passed the test for significant tuning response in both states ($p \leq 0.03$, bootstrap test). Values below indicate the z position below pia. **(b)** Single-trial fluorescence responses of cell #31 to the preferred orientation (150°) in the awake state (*left*) and in the anesthetized state under 0.25 % isoflurane (*right*). Traces in the awake state are color-coded according to the maximum speed of locomotion of the animal. **(c)** Single-trial fluorescence responses of 24 cells by choosing for each cell the stimulus trial of maximum integral response in the awake (*left*) and anesthetized (*right*) state, using the same color code as in (b). **(d)** Overlaid histograms of response amplitude for the best stimulus across all trials and all cells in the awake (red) and anesthetized (gray) state. Responses with amplitude above 0.15 have low counts and are omitted from the figure. The zero-response bar was cropped at the top. **(e)** Measured cell-averaged response probability in single trials (mean; 10 repetitions; SD error). Trial responses to the best stimulus, as judged from the average response, were considered as positive when their amplitude was at least three times larger than baseline noise, otherwise as failures. Number of animals given in brackets. **(f)** Trail-averaged integral response amplitude for the best stimulus for all cells when recorded in the awake (red) and anesthetized (black) state. Connecting lines indicate data belonging to the same cell with red lines for cells featuring larger response in the awake state. **(g)** Standard Deviation (SD) of trial responses for the best stimulus normalized to the mean of the response for cells when recorded in the awake (red) and (black).

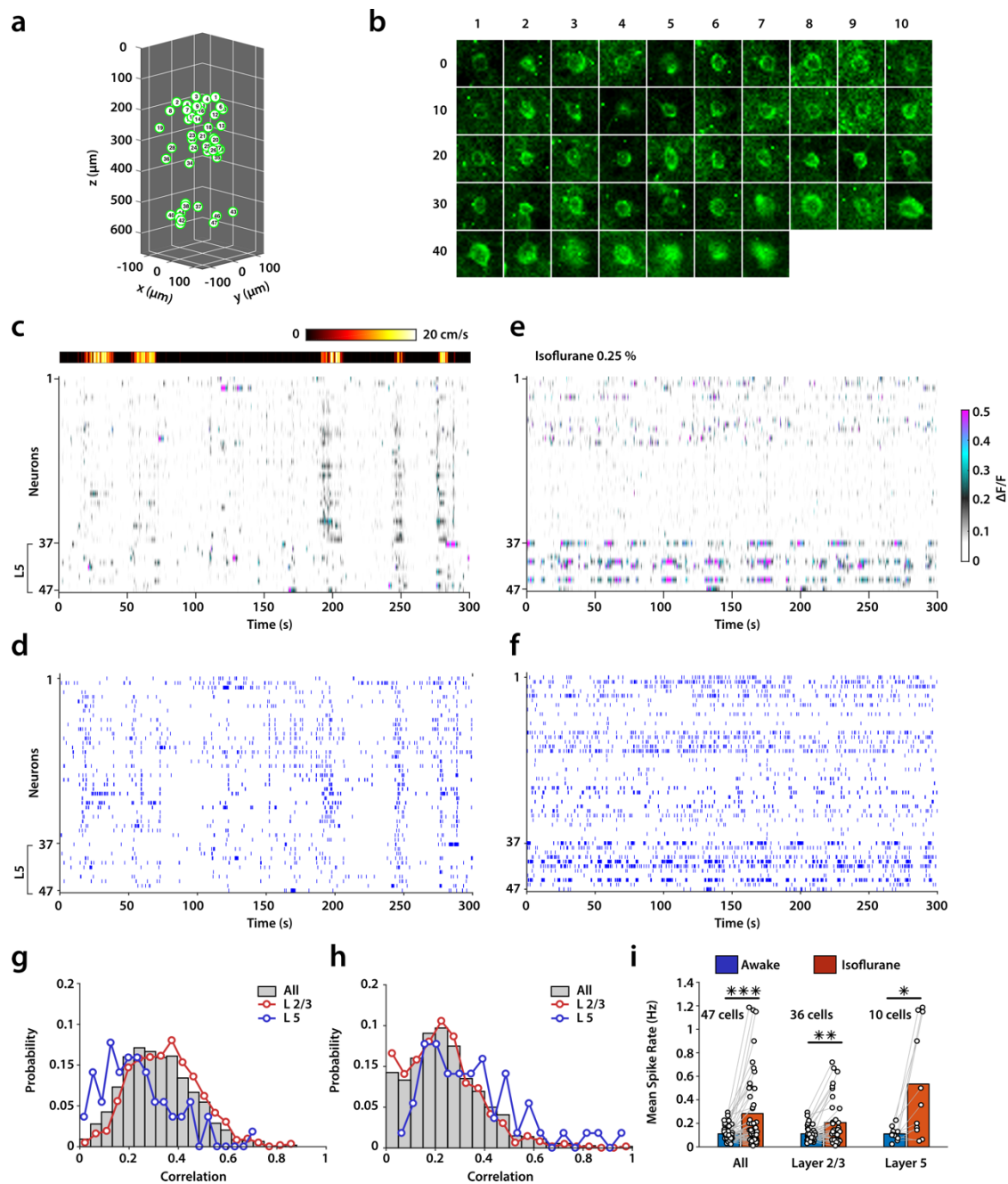

Extended Data Fig. 8 Spontaneous Ca^{2+} activity in the awake versus anesthetized state

a) 3D coordinates of cells in the dataset (47 cells). **(b)** GCaMP6f Fluorescence images of all cells. **(c)** Fluorescence traces in false colors, according to the color bar on the right side of (e) recorded in the awake state. Color bar on the top indicates locomotion velocity of the animal. **(d)** Spikes found in (c) by MLspike. **(e)** Fluorescence traces from the same cells as in (c), but with the mouse under 0.25 % isoflurane anesthesia. **(f)** Spikes found in (e) by MLspike. **(g)** Histogram of pairwise spike correlations in (d) between all cells (black), between layer 2/3 cells (red) and between layer 5 cells (blue). Spikes were counted as synchronous if they fall within a 10 ms time window. **(h)** Same as in (g), but evaluated from the dataset in (f). **(i)** Mean spike rates calculated from the spike maps in (d) and (f). Paired t-test, $p = 2 \cdot 10^{-4}$ (***, 47 cells), $2 \cdot 10^{-3}$ (**; 36 cells), $1 \cdot 10^{-2}$ (*; 10 cells). Pairs of same cells connected by lines (gray).

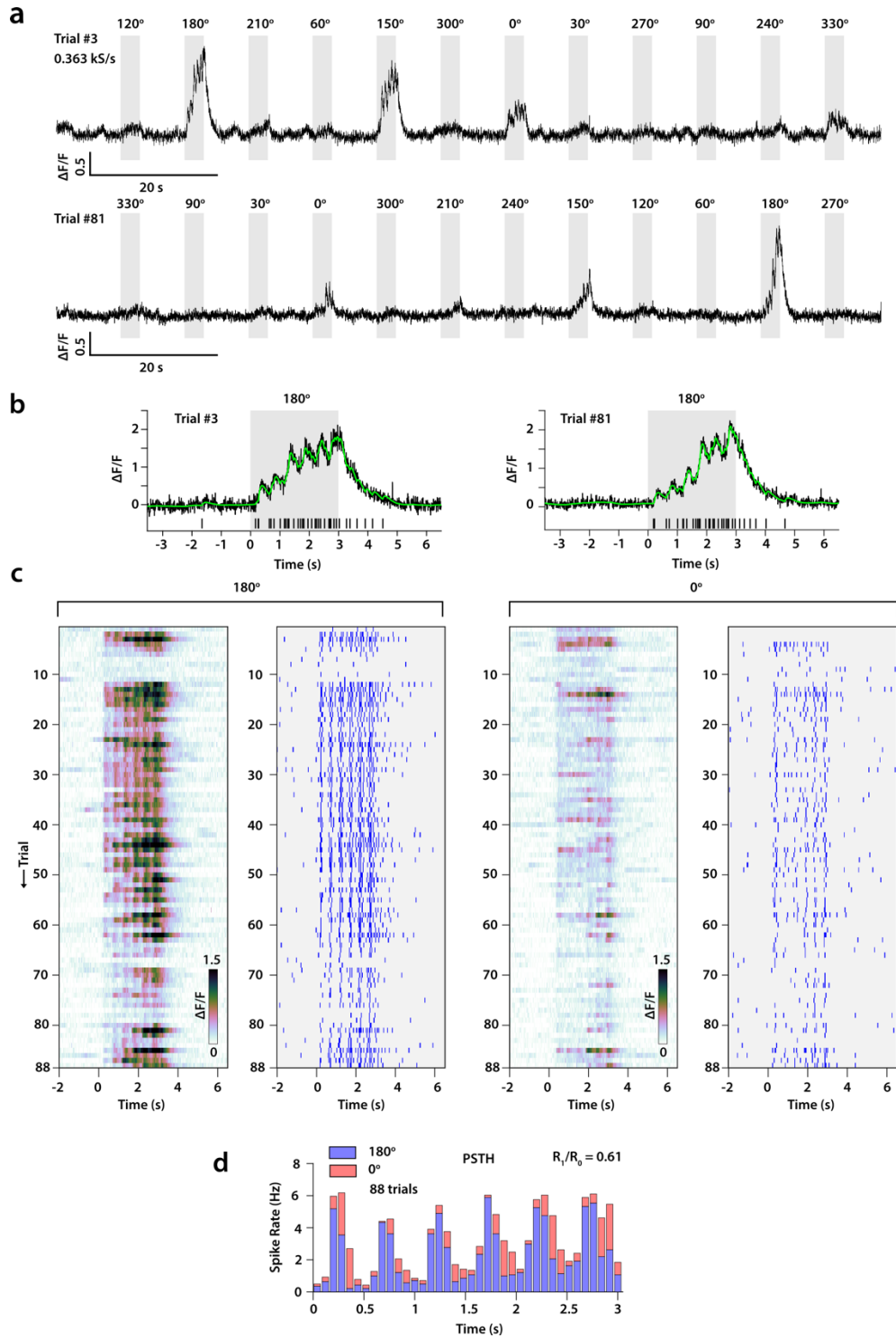

Extended Data Fig. 9 Example cell with phase-sensitive response

(a) GCaMP6f response of a layer 2/3 example cell to a stimulus series of contrast gratings with grating orientations between 0° and 360° randomized between trials and moving at a speed of 2 cycles per second (cps) under isoflurane (0.25-0.5 %) anesthesia. Sampling with 363 Hz. *Top*: Trial #3. *Bottom*: Trail # 81 (Gaussian-filtered, sigma 2.5 ms). **(b)** Responses to 180° stimulus orientation of trial #3 (*left*) and # 81 (*right*) with MLspike-inferred spikes indicated as black vertical marks (*bottom*) and convolution of inferred spikes with the GCaMP6f response template (green curve). **(c)** False-color representation of the GCaMP6f responses to the 180° (*left*) and 0° counterpropagating stimulus (*right*) for 88 consecutive trials together with MLspike-inferred spikes (blue vertical lines). **(d)** Stacked peristimulus time histogram (PSTH).

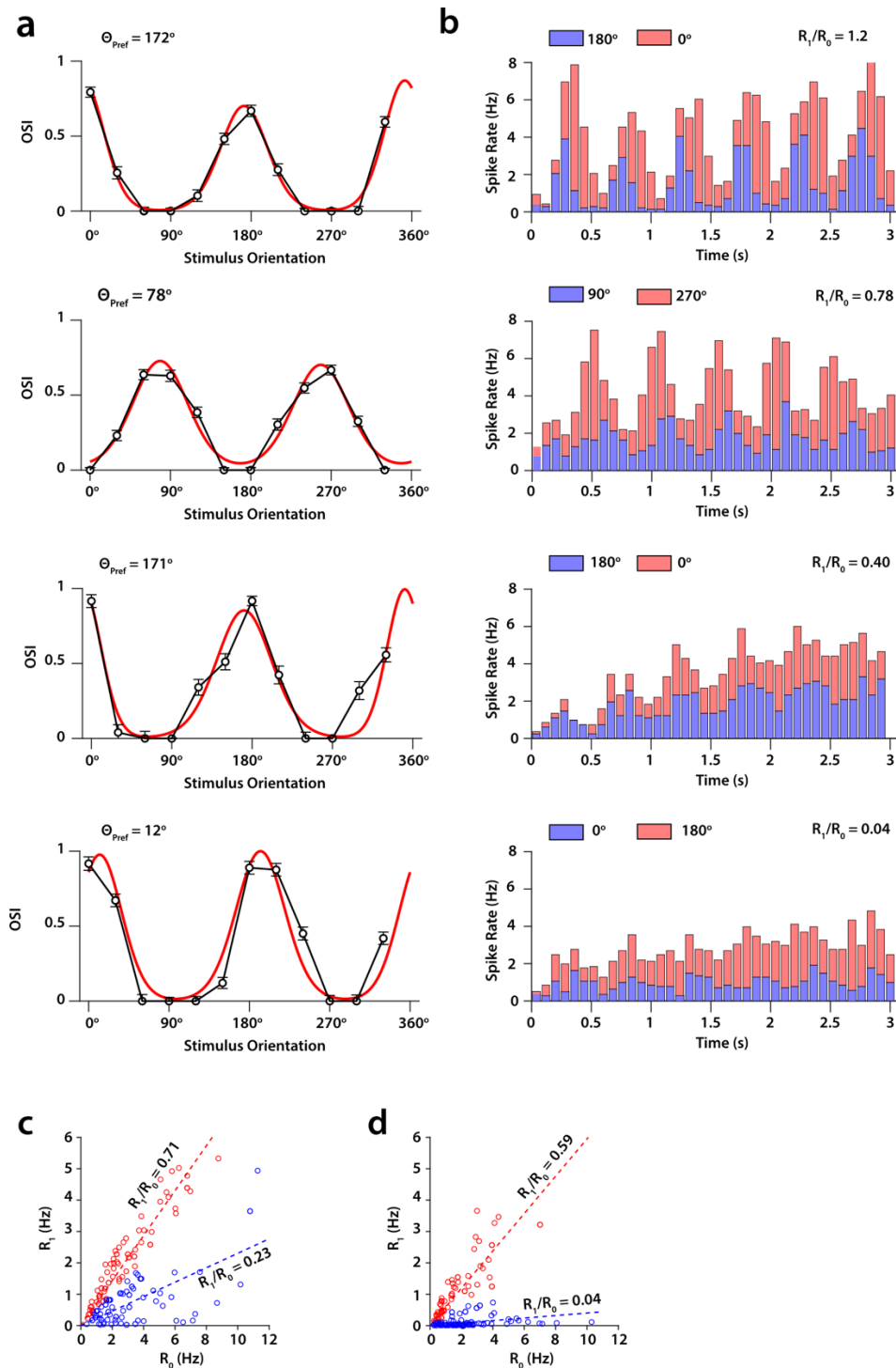

Extended Data Fig. 10 Orientation and phase sensitive responses(a) Orientation sensitivity index (OSI) for four example neurons with orientation preferences (Θ_{Pref}) 178° , 78° , 171° and 12° (top to bottom). Experimental (black) with biphasic fit (red). Error bars indicate SEM. (b) Stacked peristimulus time stacked histograms (PSTH) obtained for the neurons in (a) from 80 (# 1, #2, #4) or 50 (# 3) trials with 80 ms binning width resulting in R_1/R_0 ratios ranging from 1.2 to 0.04 (top to bottom). (c) Harmonic spike Rate R_1 as function of the mean rate R_0 in response to the preferred stimulus orientation and preferred direction for 155 neurons in layer 2/3. Responses classified according to R_1/R_0 larger (red) or lower (blue) than the R_1/R_0 ensemble mean. Linear fits to the data given as dashed lines. (d) Same as (a) for the counterpropagating direction of the preferred stimulus.

SUPPLEMENTARY MATERIAL

Fast Optical Recording of Neuronal Activity by 3D Custom-Access Serial Holography

Walther Akemann, Sébastien Wolf, Vincent Villette, Benjamin Mathieu, Astou Tangara, Jozsua Fodor, Cathie Ventalon, Jean-François Léger, Stéphane Dieudonné, Laurent Bourdieu

Supplementary Figures

- Supp. Fig. 1** 3DScope: optical and electronic layout
- Supp. Fig. 2** Ortho-normal phase functions for biaxial spatial light modulation
- Supp. Fig. 3** Optical characteristics of the 3DScope
- Supp. Fig. 4** Holography in FM/AM versus FM mode
- Supp. Fig. 5** 3D-Reconstruction of 3x3, 5x5, 2x5 target CGHs
- Supp. Fig. 6** Estimation of in vivo 3D movement of supra-granular neuron cell bodies
- Supp. Fig. 7** Correction for neuropil signaling
- Supp. Fig. 8** Event detection from GCaMP6f CASH recordings
- Supp. Fig. 9** 3D distribution of orientation sensitivity
- Supp. Fig. 10** Suppression of stimulus artifacts in recordings of visual responses (Control)
- Supp. Fig. 11** Master-follower spike propagation analysis (Controls)

Supplementary Discussion

Response-to-noise ratio of the GCaMP6f response

- Supp. Fig. 12** GCaMP6f response-to-noise ratio

Signal-to-noise ration of GCaMP-CASH recordings

- Supp. Fig. 13** The case of CASH acquisition
- Supp. Fig. 14** The case of imaging acquisition
- Supp. Fig. 15** SNR of CASH and imaging compared

Spatial resolution of the 3DScope acousto-optic light modulator

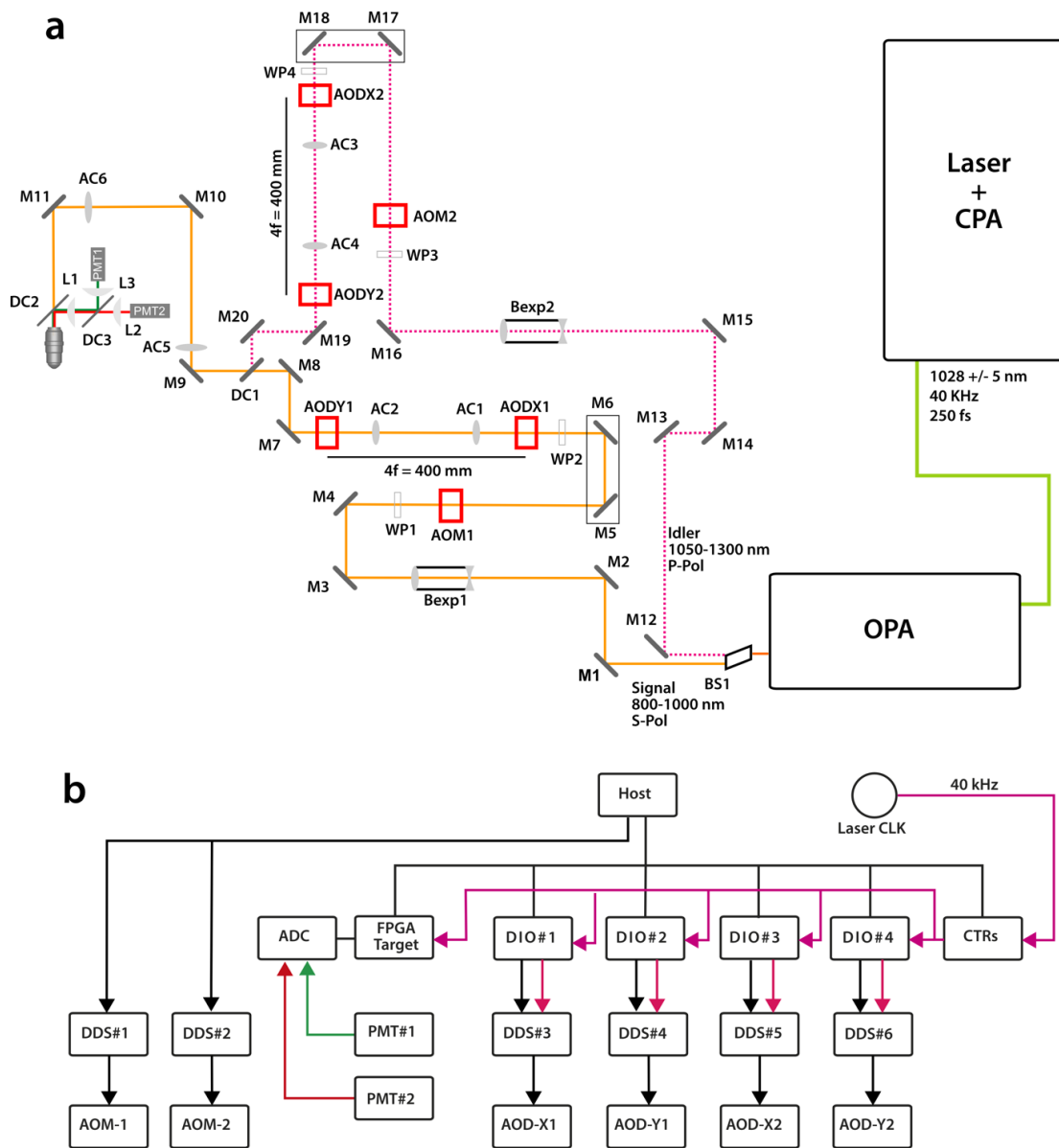

Supp. Fig. 1 3DScope: optical and electronic layout

(a) Optical layout using the following abbreviations: CPA, chirped pulse amplifier, OPA, optical parametric amplifier, M, mirror, DC, dichroic mirror, AC, achromat, L, lens, BS, beam splitter, Bexp, beam expander, WP, $\lambda/2$ waveplate, P-Pol, horizontal polarization, S-Pol, vertical polarization. **(b)** Schematic of the control layout: DDS, direct digital synthesizer, ADC, analog to digital converter, DIO, digital I/O, PMT, photomultiplier tube, CLK, laser synchronous clock signal, CTR, digital counter. Connections serve data transfer (black), timing signals (pink) and detector signals (green, red).

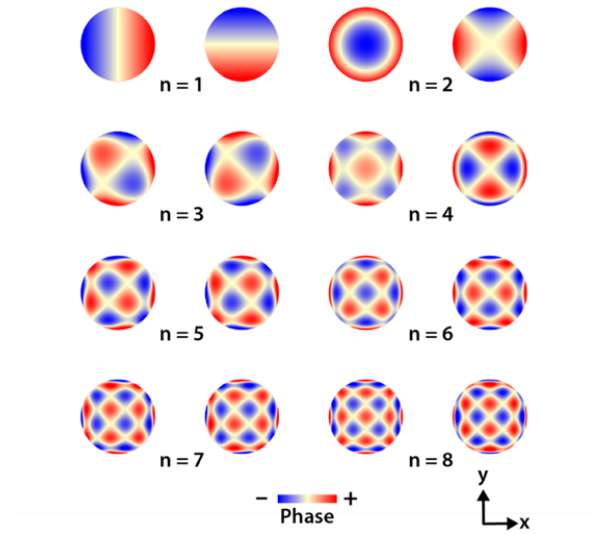

Supp. Fig. 2 Ortho-normal phase functions for biaxial spatial light modulation

Circular polynomial phase functions compatible with the geometry of a two-axis spatial light modulator (XY-SLM) up to 8th polynomial order. The functions, separable with respect to x- and y-coordinates, of the form $\varphi_n^\pm(x, y) = c_\pm(n) + \sum_{i=1}^n (a_\pm(i) \cdot x^i \pm b_\pm(i) \cdot y^i)$ are numerically constructed by successive Gram-Schmidt orthogonalization starting from $\varphi_0(x, y) = 1/\sqrt{\pi}$, $\varphi_1^+(x, y) = 2/\sqrt{\pi} \cdot x$ and $\varphi_1^-(x, y) = 2/\sqrt{\pi} \cdot y$ and $\varphi_n^\pm(x, y) = x^n \pm y^n, n \geq 2$. The zero-order mode of constant amplitude (Piston) is omitted. The total number of normal modes grows with polynomial order n as $2n+1$. These modes are the two-axis equivalents to the Zernike polynomials to 8th order, used in optics to characterize aberrations in instruments with circular aperture.

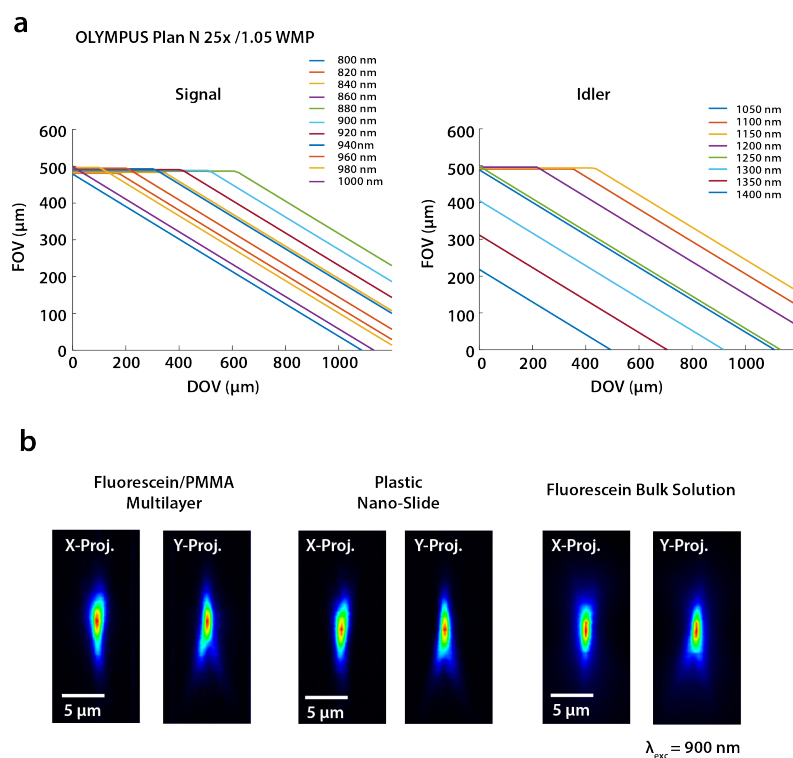

	Fluorescein/PMMA Multilayer	Color Plastic Slide D = 500 nm	Aqueous Fluorescein Layer D = 10-20 μm	Diffraction Limit
Axial FWHM	4.3 μm	4.7 μm	4.2 ± 0.8 μm	4.4 μm
Lateral FWHM	1.0 μm	1.1 μm	1.1 ± 0.2 μm	0.8 μm

Supp. Fig. 3 Optical characteristics of the 3DScope

(a) Modeled relationship between depth of view (DOV) and field of view (FOV) in the 3DScope taking into account the objective magnification (25x) and the acoustic bandwidths available at different excitation wavelengths in the signal and the idler paths. **(b)** Measurement of the fluorescence point focus in the 3DScope under two-photon excitation (900 nm) using three different fluorescence samples, a cover slip spin-coated with a Fluorescein/ PMMA layer, a plastic slide (Chroma) cut to a thickness of 0.5 μm with a microtome using a diamond knife and an aqueous 20 mM solution of fluorescein sandwiched between a glass slide and a coverslip.

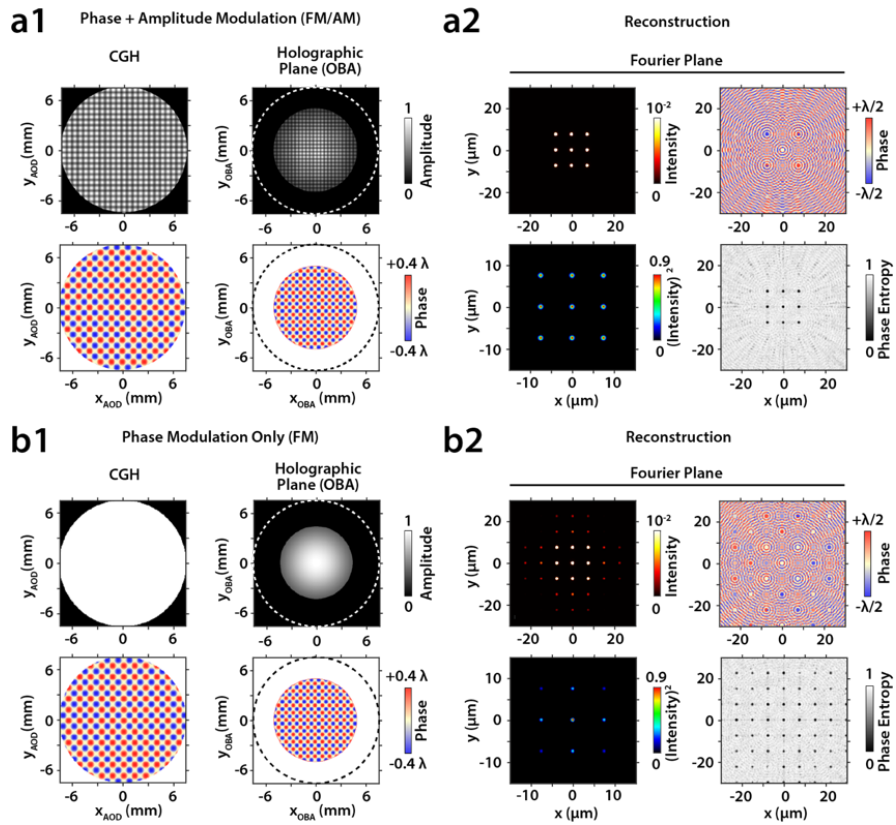

Supp. Fig. 4 Holography in the FM/AM versus FM mode

FFT reconstruction of the computer-generated hologram (CGH) given in Fig. 2b in either FM/AM mode (a) or FM mode (b). **(a1)** *Left Column*: CGH. *Right column*: Light field in the plane of the objective back aperture (OBA) of a Gaussian laser beam carrying FM/AM modulation given by the CGH. Size of the OBA indicated with a dashed line. **(a2)** Light field in the Fourier (focal) plane obtained by FFT of the OBA light field. *Left column*: Intensity and the intensity squared, with the squared intensity as a proxy for the two-photon fluorescence intensity distribution. *Right column*: Phase and phase entropy. **(b1)** and **(b2)** same as (a1) and (a2), but without AM. Notably, the reconstructed phase in the Fourier plane exhibits disc-like regions of constant phase and minimal entropy at the target sites in the FM/AM mode, while the phase outside the target sites is scrambled, indicating destructive interference. In the FM only mode, on the other hand, the reconstructed phase exhibits local flatness at side lobe positions.

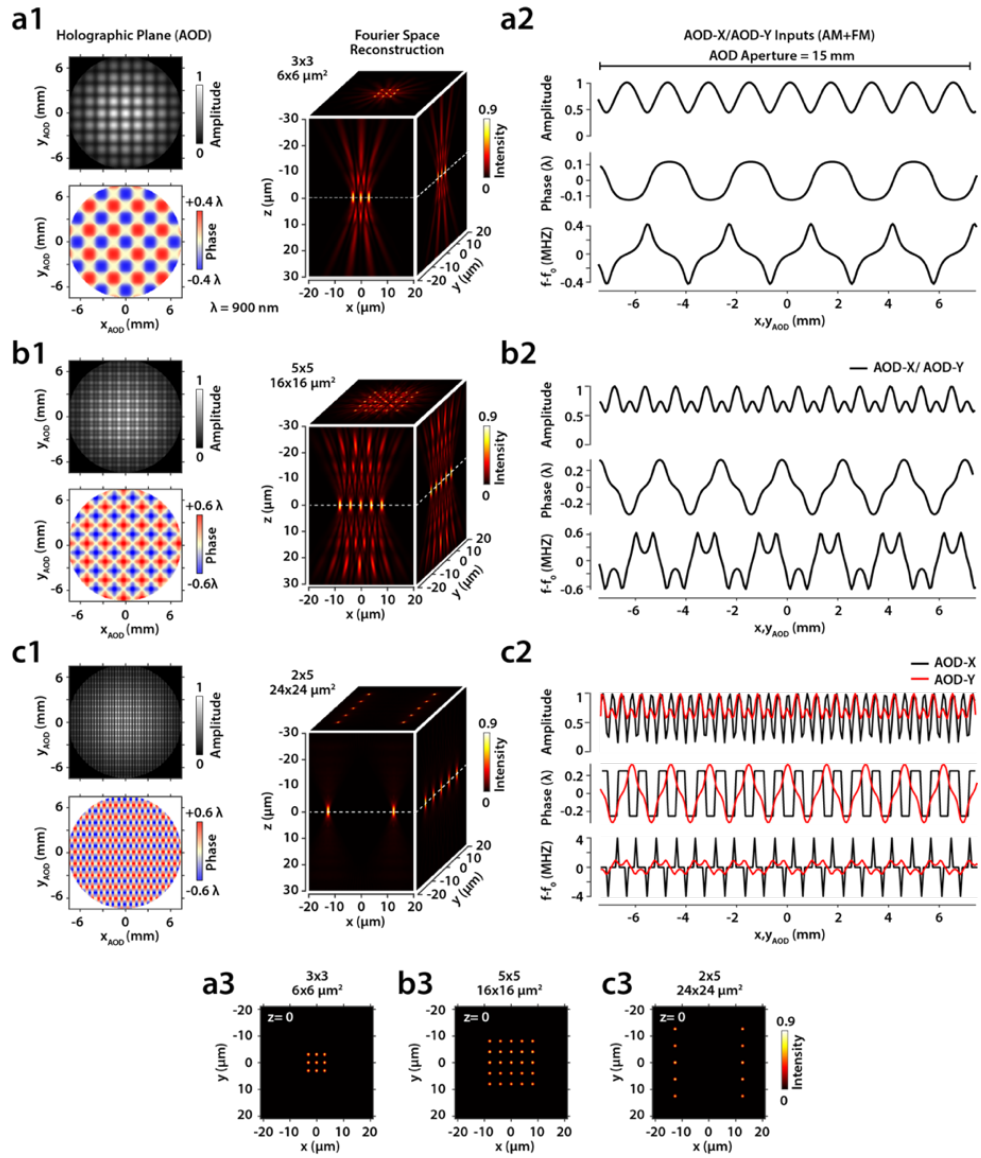

Supp. Fig. 5 3D reconstructions of 3x3, 5x5, 2x5 target CGHs

(a) 3x3 ($6 \times 6 \mu\text{m}^2$) target. **(a1)** Left Column: Light field in the AOD plane. Right: Intensity reconstruction in Fourier space using Fourier transform and a linear phase propagator. **(a2)** AOD phase and RF input signals: AM signal (top), phase (middle) and FM signal (bottom). **(a3)** Intensity distribution in the focal plane. **(b1-3)** 5x5 ($16 \times 16 \mu\text{m}^2$) target. **(c1-3)** 2x5 ($24 \times 24 \mu\text{m}^2$) target.

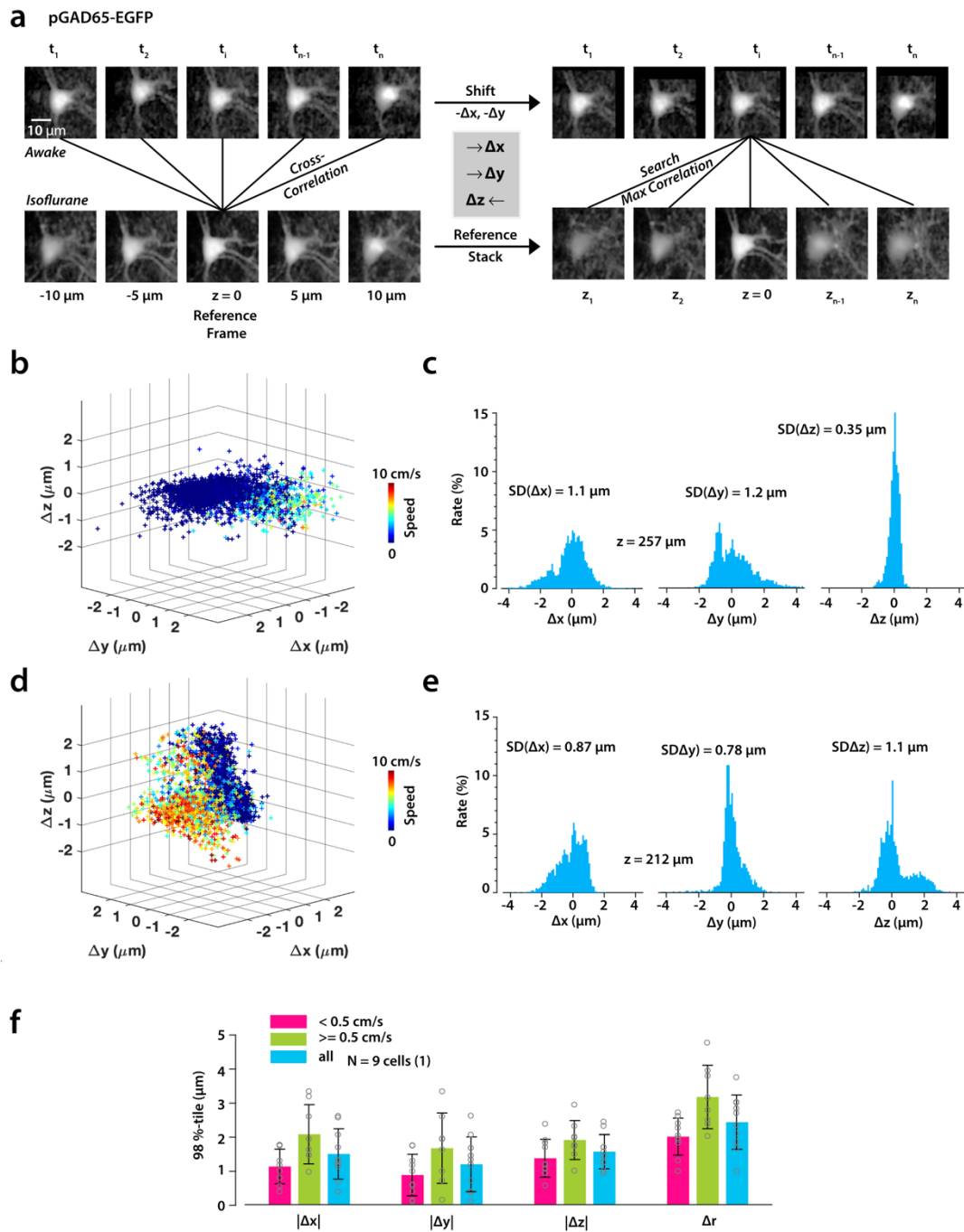

Supp. Fig. 6: Estimation of in vivo 3D movement of supra-granular neuronal cell bodies

(a) Experimental design: first, a time-lapse image stack from a recording of a single EGFP-expressing cell in a pGAD65-EGFP transgenic mouse (50x50 pixels; 16 frames/s) is x,y-aligned by frame-wise cross-correlation with the focal image of a z-image stack (50x50 pixels, $\Delta z = 0.25 \mu\text{m}$) of the same cell in the anesthetized animal. In a second step, the 2D-correlation between every t-frame and all z-frames is calculated and the z-position is assigned to the z-frame of highest correlation. **(b)** x-, y- and z-displacement amplitude of the cell represented in (a), color-coded according to the motion speed of the animal. **(c)** x-, y-, z-displacement histograms of the same data indicating the SD of each distribution. **(d, e)** Same estimation for a different cell in a different recording session (38 days earlier; 14 days after surgery) in the same animal. **(f)** Pooled displacement data (mean \pm SD of the 98 percentile of x-, y-, z- and radial displacements; N = 9 cells; 1 animal) discriminated according to those movements that occur in the resting animal (red; motion speed < 0.5 cm/s) and the moving animal (green; motion speed \geq 0.5 cm/s). Data taken from 14 to 55 days post surgery. Number of animals given in brackets.

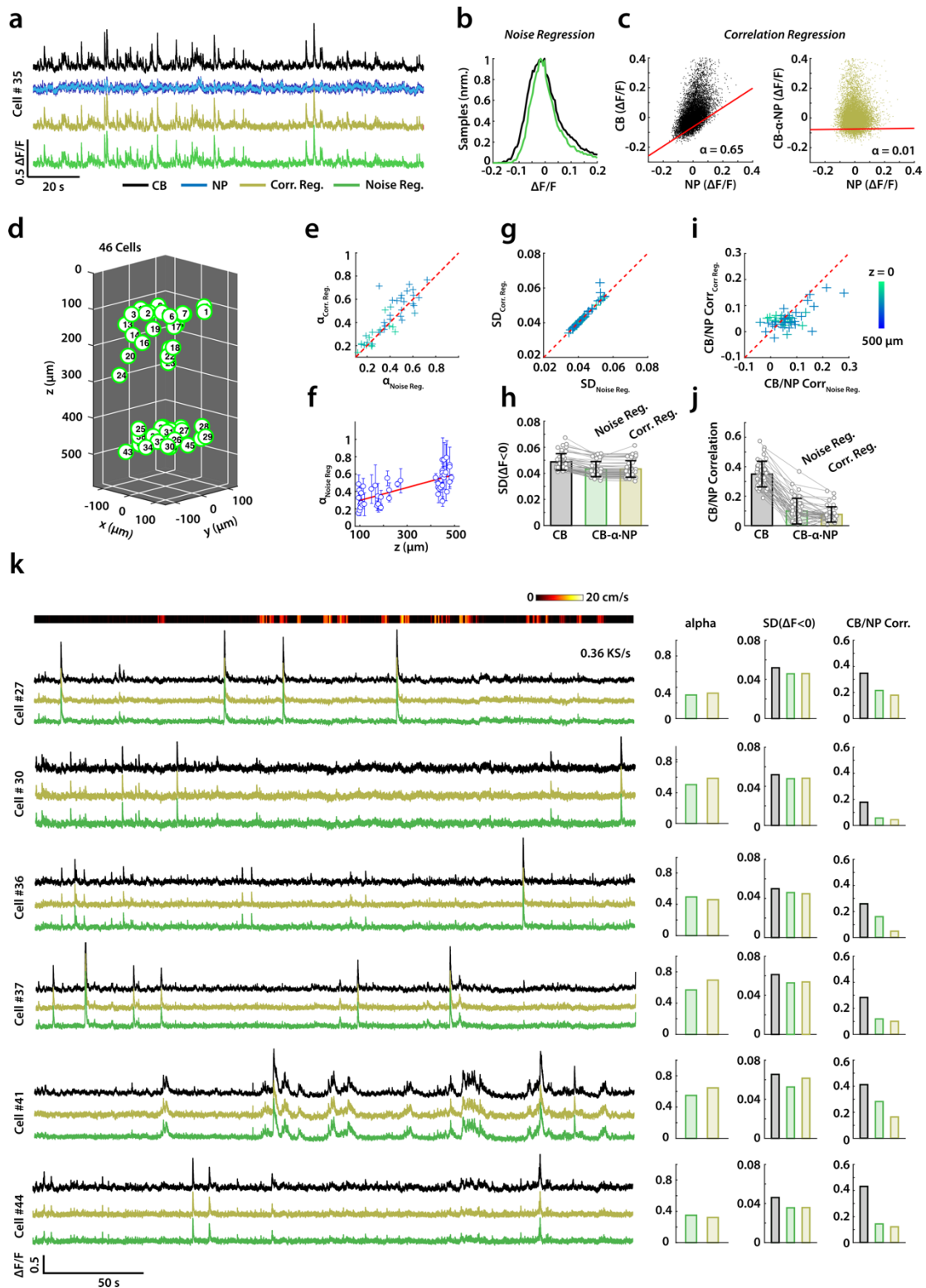

Supp. Fig. 7 Correction of neuropil signaling

Legend continues next page.

Supp. Fig. 7

Subtraction of neuropil signaling

(a) Example traces with the CB signal (black), the NP signal (dark blue), the NP signal smoothed with a 50 ms window (light blue) and the corrected signal using correlation regression (yellow) or noise regression (green). **(b)** Trace histogram of the CB trace (black) and the corrected trace using noise regression (green). **(c)** *Left*: XY-plot of NP and CB data with linear fit (red) excluding data points with large CB values owing to cellular activity, with the slope (0.65) identical to the α value. *Right*: XY-plot of NP and corrected CB data with linear fit (red) excluding cellular activity, with residual correlation reduced to 0.01. **(d)** Coordinates of 46 neurons of the data set shown in this figure. **(e)** α regression parameters (mean and SD; 3 repetitions; 46 cells) for all cells in the data set obtained from noise regression (x-axis) and correlation regression (y-axis). Dashed red line indicates the identity manifold. **(f)** Noise regression-derived α values for all cells, plotted as function of the z coordinates. Red line indicates a linear fit to the data. Error bars represent SD. **(g)** Residual baseline noise, $SD(\Delta F/F < 0)$, after noise regression (x-axis) and correlation regression (y-axis). **(h)** Baseline noise, mean and SD for all cells, of the CB raw data (black) and after noise (green) and correlation (yellow) regression. Error indicated as SD. Lines (gray) connect same cells. **(i)** Residual correlation coefficient of CB and NP trace, for all cells in the data set, after noise regression (x-axis) and correlation regression (y-axis). Error indicated as SD. **(j)** Correlation of CB and NP trace, mean and SD for all cells in the dataset, before regression (black), after noise (green) and correlation (yellow) regression. CB parameter obtained with noise regression. **(k)** Six example cells (#27, #30, #36, #37, #41, #44). *Left column*: CB raw trace (black), and same trace after noise (green) and correlation (yellow) regression. Color bar on top indicates walking speed of the animal. *Right column*: Regression parameter (*left*), baseline noise $SD(\Delta F < 0)$ (*middle*) and correlation coefficient of CB and NP trace (*right*) with the same color code as for the traces on the left side.

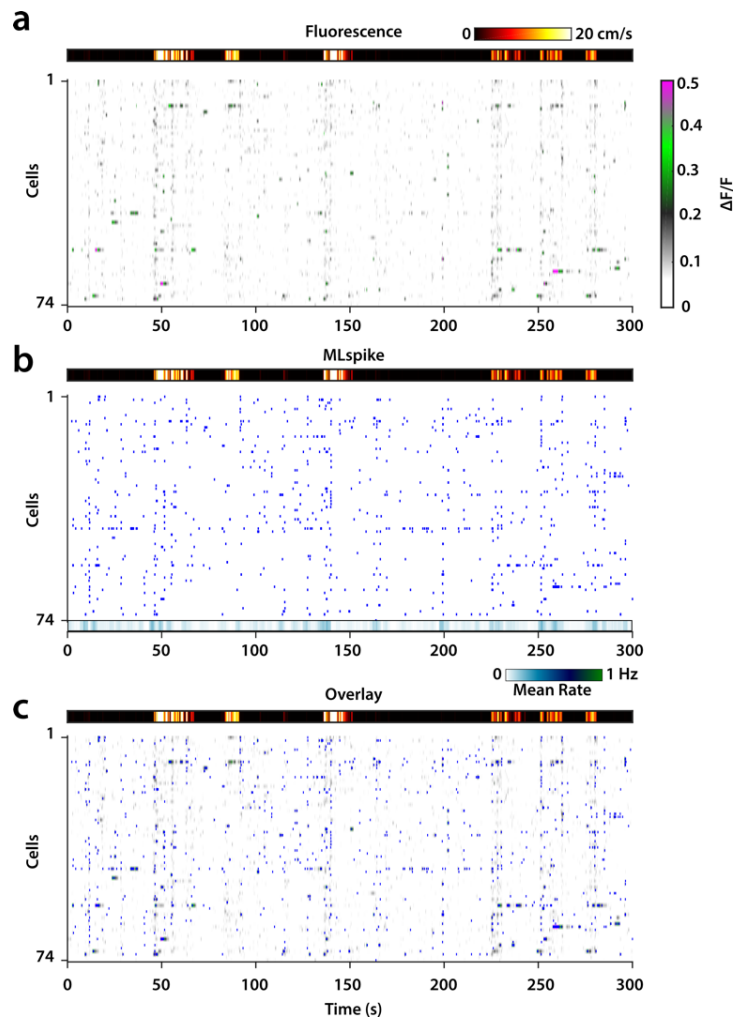

Supp. Fig. 8 Event detection from GCaMP6f CASH recordings

(a) GCaMP6f fluorescence traces from 74 cells in false-color representation according to color bar on the left. Same dataset as in Fig. 4. Color bar on the top represents locomotion velocity of the animal. **(b)** MLspike-detected spike events with mean spike rate (74 cells; 0.2 s bin width; *bottom*). **(c)** Overlay of (a) and (b).

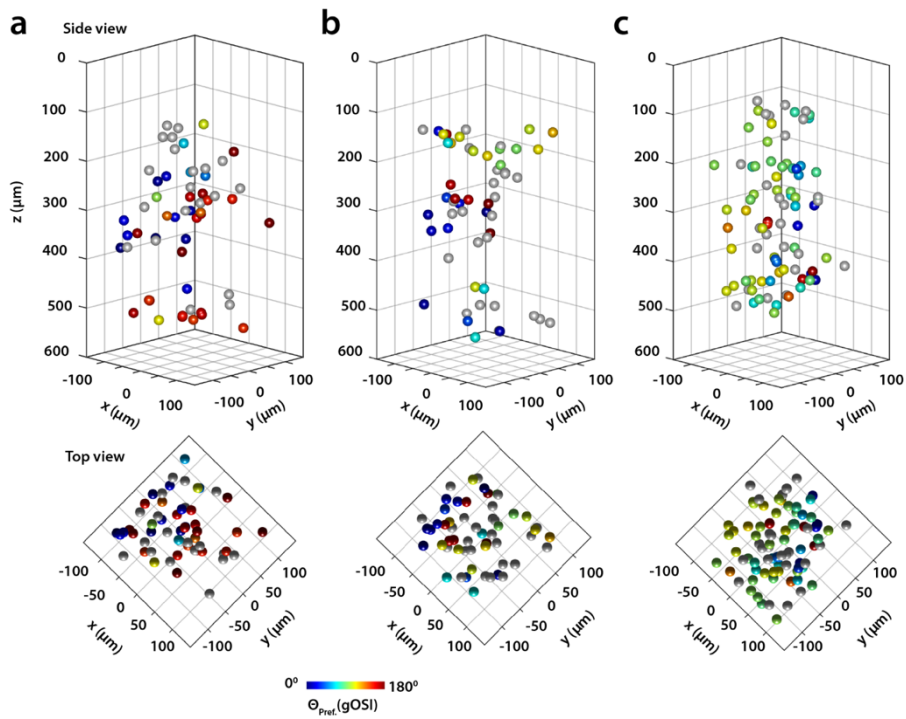

Supp. Fig. 9 3D distribution of orientation sensitivity

Measured angles of orientation tuning of neurons obtained from the vector sum of responses across all stimulus orientations, gOSI, in three different experiments in the painted ball representation in side view (top) and top view (bottom). **(a)** Same data as given in Fig. 5d. **(b)** and **(c)** display data from two different experiments in the awake state performed in the same mouse, but different selections of cells.

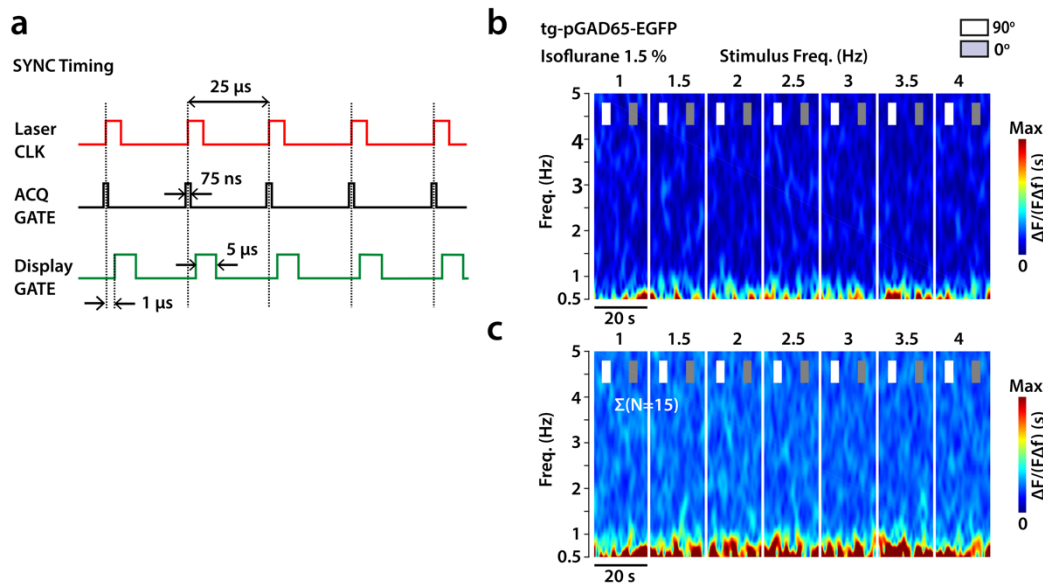

Supp. Fig. 10 Suppression of stimulus artifacts in recordings of visual responses (Control)

(a) Timing protocol for gated stimulus presentation. The screen is switched on and off in sync with the laser clock in such a way that the screen gate is off at least 18 μ s before the acquisition gate opens. (b) Control experiment using the same stimulus protocol as in Fig. 6c, but with a mouse expressing EGFP instead of GCaMP6f (1.5 % isoflurane). *Top*: STFT calculated from the 10 trial average of the data of one cell. *Bottom*: Average STFT average including data from 15 cells.

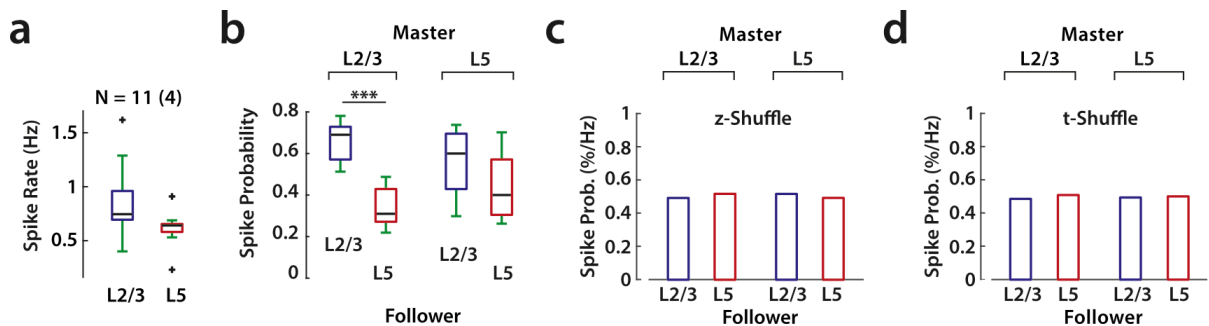

Supp. Fig. 11 Master-follower spike propagation analysis (Controls)

(a) Median rate (black bar; N = 11 experiments; 4 animals) of BSD-inferred spikes of layer 2/3 (L2/3) and 5 (L5) neurons including awake and anesthetized conditions with 1st and 3rd quartile (box), \pm 2.7 SD range (green whiskers) and outliers (black crosses). (b) Probability, p_k^l (median; black bar), of a spike emitted in a cell of layer k (master) having the first follower spike emitted in a neuron in layer l (follower). Same data as in (a). P-value $p = 1.8 \cdot 10^{-4}$ (***, T-test, unpaired, two-sided t-test) between layer 2/3 versus layer 5 follower cells if cells in layer 2/3 were the master, whereas the difference was not significant if cells in layer 5 were the master. The probability p_k^l is equivalent to the probability \hat{p}_k^l shown in panel Fig. 6o, but without normalization with regard to cell count and mean firing rate. (c-d) Spike probability (mean) obtained from master-follower analysis analogous to Fig. 6o of the same dataset after shuffling the z-positions of cells (c) or shuffling the spike trains for each follower cell (d).

Supplementary Discussion

Response-to-noise ratio of the GCaMP6f response

Signal-to-noise ratio (SNR) specifies the amplitude of the probe response relative to the amplitude of the noise in a given recording. In this way, SNR evaluates the information present in single data points close to the maximum of the response rather than the information carried by the entirety of sample points covering the response transient. In consequence, SNR underestimates the information available in highly oversampled signals. As a measure of the effective signal-to-noise ratio of the integral response, we define the response-to-noise ratio (RNR) as the integrated response above baseline noise divided by the standard error of the noise signal. Assuming a biexponential time course of the GCaMP6f response with fixed rise (50 ms) and decay (300 ms) time constants and fixed single-spike response amplitude (7.5 %), numerical integration of the response at variable level of noise (SNR from 1 to 3.5) reveals the RNR gain to be expected from accelerated sampling (Supp. Fig. 12).

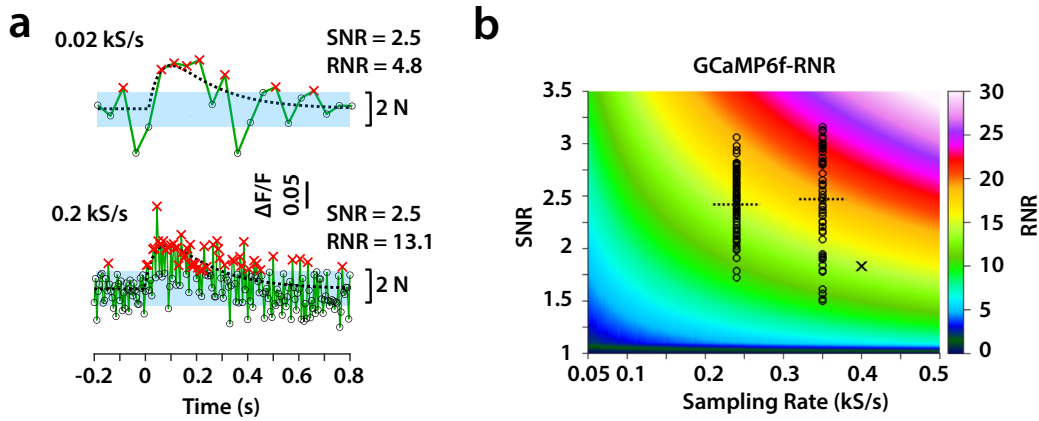

Supp. Fig. 12: GCaMP6f response-to-noise ratio (RNR)

(a) Schematic of an isolated GCaMP6f spike response ($\tau_{ON} = 0.05$ s, $\tau_{OFF} = 0.3$ s, $\Delta F/F = 0.075$; dashed line) when sampled at 0.02 kHz (top) and 0.2 kHz (bottom) with N , the baseline noise (SD). In green: GCaMP6f response with simulated Gaussian noise (SNR 2.5). The response-to-noise ratio (RNR) is defined as the mean of samples (red crosses) above baseline noise (blue horizontal band) divided by the error of the mean of the noise. (b) RNR for the GCaMP6f response to single spikes as function of SNR and sampling rate (in kilo samples/s). Presumed single spike RNR of recordings shown in Fig. 4b-j (0.24 kHz; first trial) and Fig. 5a-h (0.35 kHz; first trial) as black circles (single cells; horizontal dashed line: ensemble mean). RNR of the recording with simultaneous electrophysiology (0.4 kHz; Fig. 4k-m) indicated as black cross.

The relationship between SNR and RNR follows from the following estimation. Because of the fast onset and slow decay of the GCaMP6f response, the response may be approximated by an instantaneous step onset followed by an exponential decay with time constant τ_{off} giving rise to a $FWHM \approx \ln(2) * \tau_{off}$. By considering response values above half maximum, the integrated mean response, R , and the the standard error of the noise, SEM_{noise} , are then given as:

$$R \approx f_R \cdot S_{peak} \quad \text{with} \quad f_R := (\ln(2) \tau_{off})^{-1} \int_0^{\ln(2)\tau_{off}} e^{-t/\tau_{off}} dt$$

$$SEM_{noise} = SD_{baseline} / \sqrt{\ln(2)\tau_{off} r_{acq}}$$

with $r_{acq} = r_{data}/n_{cells}$, the sampling rate, $r_{data} = 2 \cdot 10^4/s$, the total data throughput of the 3DScope, and n_{cells} , the number of sampled cells (POIs). The response-to-noise ratio, $RNR = R/SEM_{noise}$, therefore follows as:

$$RNR \approx f_R \cdot \sqrt{\ln(2)\tau_{off}r_{acq}} \cdot SNR$$

Therefore, with SNR fixed by the experimental conditions of the recording, RNR increases with the square root of the applied sampling rate. With τ_{off} (0.33 s), f_R (0.72) and the measured single spike peak response S_{peak} ($\approx 7.5\%$) and baseline noise $SD_{baseline}$ ($\approx 3.3\%$, see Fig. 4f) this results in the following estimates, valid under recording conditions in this work: $SNR \approx 2.3$ and $RNR \approx 0.83 \sqrt{r_{acq}/Hz} = 116/\sqrt{n_{cells}}$.

Signal-to-noise ratio of GCaMP-CASH recordings

The 3DScope was designed to perform fluorescence recording close to the photon shot noise limit, thus:

$$SNR \leq SNR_{shot\ noise} = \Delta F/F \cdot \sqrt{n_{ph}} \quad (\text{Eq. 1})$$

with $\Delta F/F$, the effective fluorescence response amplitude of the probe (APs < 4; Ext. Fig. 4g), and n_{ph} , the mean number of baseline photons detected during sampling time bins. In the following, we estimate n_{ph} in GCaMP-CASH from given experimental parameters in comparison to standard 2-photon imaging.

Abbreviations

Two-photon excitation and optical detection

λ_0	Laser wavelength in vacuum
n	Index of refraction of water ($n = 1.33$)
τ_L	Laser pulse FWHM
T_L	Laser pulse repetition time interval
P_L	Mean laser power applied in one focal spot
E_L	Pulse Energy
d_L	Laser duty cycle $d_L = \tau_L/T_L$
f_C	Geometrical collection yield of the objective
f_F	Optical filter and lens transmission of the detection optics
q_{det}	Quantum yield of the detector
C_{probe}	Cytosolic concentration of the probe
V_{ex}	Single spot two-photon excitation volume
q_{em}	Fluorescence quantum yield of the probe
p_{TPA}	Probability of molecular two-photon absorption of the probe
σ_2	Two-photon cross section of the probe in the resting state
Φ_{ex}	Instantaneous laser photon flux in the focal plane
NA	Numerical aperture (NA = 1.05; OLYMPUS XLPlan WMP 25x)
f_{obj}	Objective focal length
D	Size of objective entrance pupil (Diameter)
f_{fill}	Radial fill factor of the objective pupil in the excitation path ($f_{fill} = 0.66$ in the 3DScope)
w_0	Gaussian beam waist in the objective focal plane $w_0 \cong 2\lambda_0 f_{obj}/(\pi n f_{fill} D)$
z_R	Rayleigh length of a Gaussian beam $z_R \cong \pi w_0^2 n/\lambda_0$

Data acquisition

r_{acq}	Sampling rate
n_{Cell}	Number of cells sampled
n_{acq}	Number of laser pulses contributing to one sampling bin of one cell
ρ_C	Volume density of cells in the population of interest
A_C	Surface area of the cytosolic compartment of cells of interest (cell body) in the focal plane

Abbreviations continued

CASH mode

n_{holo}	Number of focal spots generated by the hologram
f_{holo}	Holographic yield; fraction of focal spots contributing to the cellular signal
n_{foci}	Number of focal spots contributing to the cellular signal; $n_{\text{foci}} = f_{\text{holo}} n_{\text{holo}}$
l_x	Feed size of the focal grid in x-direction (generated by the X-AOD)
l_y	Feed size of the focal grid in y-direction (generated by the Y-AOD)
\hat{P}_L	Total laser power $\hat{P}_L = n_{\text{holo}} P_L$
r_{data}	Data throughput of the microscope (number of sampled neurons per second)

Imaging mode

f_{pix}	Pixel yield; fraction of pixels in a frame used to extract the fluorescence signal of single cells
l_z	Axial segmentation length

As n_{ph} depends on details of the sampling protocol applied in each case, it is useful to first estimate, n_{ph}^1 , the number of detected photons per laser pulse emanating from one focal spot:

$$n_{ph}^1 = \frac{1}{2} c_{\text{probe}} V_{\text{ex}} f_C f_F q_{\text{det}} q_{\text{em}} p_{\text{TPA}} \quad (\text{Eq. 2})$$

Approximating the spatial-temporal profile of the laser pulse within the two-photon excitation volume by a square hat function of temporal width τ_L , p_{TPA} is given by¹:

$$p_{\text{TPA}} \cong 1 - \exp(-\sigma_2 \phi_{\text{ex}}^2 \tau_L) \quad (\text{Eq. 3})$$

which simplifies to $p_{\text{TPA}} \cong \sigma_2 \phi_{\text{ex}}^2 \tau_L$ for $p_{\text{TPA}} < 0.5$. Making use of $\phi_{\text{ex}} \cong \frac{\lambda_0 \tau_L}{hc \tau_L \pi w_0^2} P_L$ gives:

$$p_{\text{TPA}} \cong \sigma_2 \left(\frac{\lambda_0}{hc} \right)^2 \frac{\tau_L}{d_L^2} \frac{1}{(\pi w_0^2)^2} P_L^2 \quad (\text{Eq. 4})$$

and using² $V_{\text{ex}} \cong \pi w_0^2 \cdot 2z_R \cong 2(\pi w_0^2)^2 n / \lambda_0$:

$$n_{ph}^1 \cong c_{\text{probe}} f_C f_F q_{\text{det}} q_{\text{em}} \sigma_2 \frac{n \lambda_0}{(hc)^2} \frac{\tau_L}{d_L^2} P_L^2 \quad (\text{Eq. 5})$$

Notably, n_{ph}^1 does not depend on the actual size of the excitation volume as long as the excitation falls into the cytosolic space of the target cell. Once n_{ph}^1 is known, n_{ph} follows from:

$$n_{ph} = n_{\text{acq}} n_{\text{foci}} n_{ph}^1 \quad (\text{Eq. 6})$$

where n_{foci} is the number of grid spots contributing to excitation of the probe in cells of interest. In general, $n_{\text{foci}} \leq n_{\text{holo}}$.

The case of CASH acquisition

In CASH, cells are sampled with one laser pulse per sample bin, thus $n_{\text{acq}} = 1$, using amplified laser pulses for excitation, to maximize the photon yield per pulse, and distributing the pulse energy equally among the grid spots, to avoid saturation of the probe. In the following we assume excitation at 30 % saturation ($p_{\text{TPA}} = 0.3$), which according to Eq. 3 implies 17 μW mean laser power (E_L 0.42 nJ) per focal spot, and hence 0.42 mW in case of the 5x5 grid pattern (Fig. 4a), by using the two-photon cross section of EGFP of $3 \cdot 10^{-57} \text{ m}^4\text{s}$ (940 nm; pH 8)³. From Eq. 6 we calculate n_{ph} and SNR as function of c_{probe} and n_{foci} (Supp. Fig. 13), while regarding all other

quantities as fixed parameters defined either by the optical design (3DScope) or the molecular properties of the probe (GCaMP6f).

Parameters used in evaluating SNR in CASH mode

f_C	0.2 (NA 1.05)	p_{TPA}	0.3	f_{obj}	8 mm
f_F	0.8	T_L	25 μ s	D	15.12 mm
q_{det}	0.45	τ_L	200 fs	f_{fill}	0.66
q_{em}	0.6	d_L	$8 \cdot 10^{-9}$	n_{acq}	1
σ_2	$3 \cdot 10^{-57}$ m ⁴ s	λ_0	940 nm		

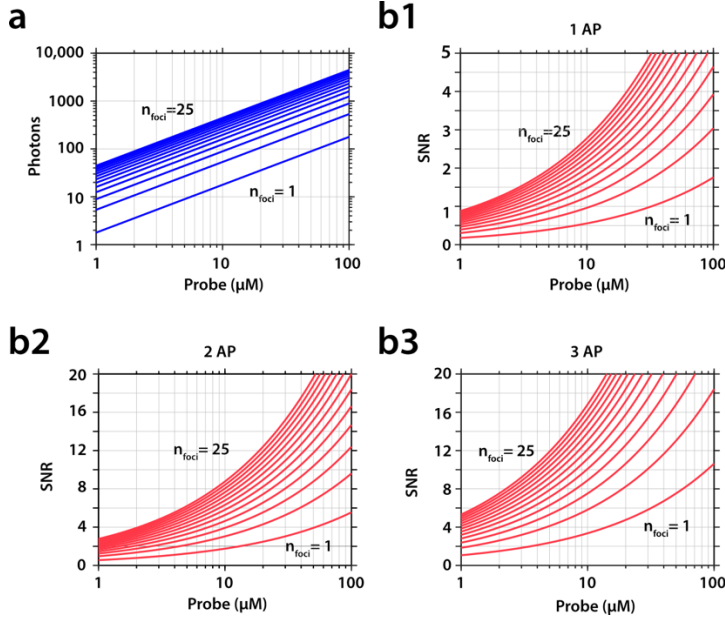

Supp. Fig. 13

(a) Number of estimated baseline photons n_{ph} per sample bin as function of cytosolic concentration of the probe and the number of focal spots, $n_{foci} = 1, 3, \dots, 25$. **(b1-3)** Estimated signal-to-noise ratios for the GCaMP6f response to single (1 AP), double (2 AP) and triple action potentials (3 AP) using the data in (a) and the response amplitudes given in Ext. Fig. 4g. For consistency with the experimental CASH data, the SNR calculation includes the effect of a three-point smoothing filter.

The case of imaging acquisition

In imaging mode, $n_{holo} = 1$ and $n_{acq} = f_{pix} / (r_{acq} T_L)$. Because of the large difference in duty cycle between a standard 2-photon microscope, with 80 MHz pulse rate and 200 fs pulse width ($d_L = 1.6 \cdot 10^{-5}$), and the 3DScope ($d_L = 8 \cdot 10^{-9}$) saturation occurs at much higher laser power (Supp. Fig. 14a), at 34 mW to reach 30 % saturation (Eq. 3), for instance, which is unsustainable because of tissue heating (see Discussion). For estimation we therefore reduced the laser power to 8 mW (E_L 0.1 nJ) equivalent to 2 % probe saturation (Eq. 3). Using Eq. 5 and Eq. 6 we estimate n_{ph} and SNR as function of c_{probe} and f_{pix} .

Parameters used in evaluating SNR in imaging mode

f_C	0.2 (NA 1.05)	P_L	8 mW	f_{obj}	8 mm
f_F	0.8	T_L	12.5 ns	D	15.12 mm
q_{det}	0.45	τ_L	200 fs	f_{fill}	0.66
q_{em}	0.6	d_L	$1.6 \cdot 10^{-5}$	n_{holo}	1
σ_2	$3 \cdot 10^{-57}$ m ⁴ s	λ_0	940 nm	r_{acq}	20 Hz

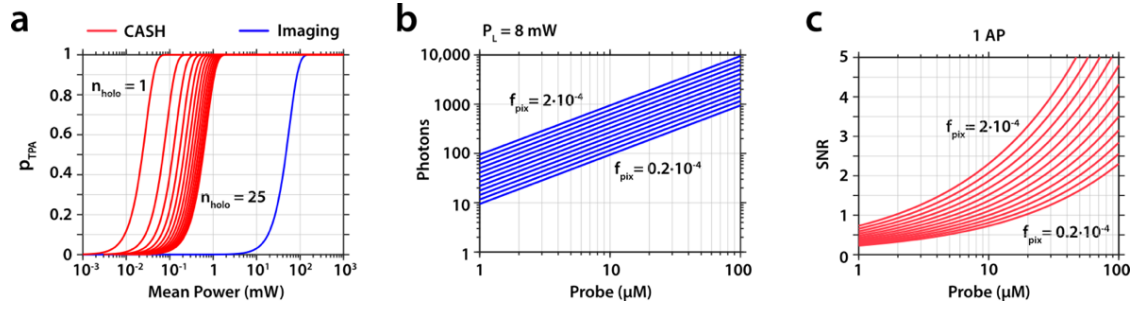

Supp. Fig. 14

(a) Probability of 2-photon absorption (pTPA) as function of mean power of excitation in the focal volume according to Eq. 3 in the imaging case (16 · 10⁻⁶ duty cycle) as compared to CASH (8 · 10⁻⁹ duty cycle; 1, 3, ..., 25 spots). **(b)** Number of estimated baseline photons (n_{ph}) per sample bin in the imaging case as function of cytosolic concentration of the probe and the fraction of pixels in the imaging frame (f_{pix}) used for extracting single cell responses. Values of f_{pix} vary 2, 1.6, 1.3, 1.1, 0.86, 0.7, 0.57, 0.46, 0.37, 0.3, 0.25 and 0.2 ($\times 10^{-4}$). **(c)** Expected SNR of the GCaMP6f response to single action potentials (1 AP) in the imaging case as function of probe concentration and f_{pix} . In the case of 500 × 500 pixels imaging frame size, the given values of f_{pix} correspond to ROI sizes of 50, 40, 33, 27, 22, 18, 14, 12, 9, 7, 6, and 5 pixels. The assumed sampling rate is 20 frames/s.

SNR of CASH and imaging compared

The relationship of SNR between CASH and imaging acquisition follows immediately from Eqs. 1, 5 and 6:

$$\frac{SNR^C}{SNR^{Im}} = \alpha_{Im}^C \cdot \frac{\hat{P}_L^C}{P_L^{Im}} \quad \text{with} \quad \alpha_{Im}^C := \sqrt{\frac{f_{holo} r_{acq}^{Im} T_L^{Im}}{n_{holo} f_{pix}}} \frac{d_L^{Im}}{d_L^C} \quad (\text{Eq. 7})$$

with superscripts: Im = imaging and C = CASH. \hat{P}_L^C = the total excitation power summed over all grid spots.

Eq. 7 has the advantage of eliminating the shared molecular and experimental parameters difficult to estimate, notably the two-photon cross section and cytosolic concentration of GCaMP. Since in CASH the SNR is independent of the sampling rate, α_{Im}^C in Eq. 7 does not explicitly depend on the sampling rate r_{acq}^C . However, $r_{acq}^C \gg r_{acq}^{Im}$ and therefore the GCaMP-CASH signal is, in general, highly oversampled with respect to the GCaMP imaging signal.

For a fair comparison of the noise, and thus SNR, we equalize the sampling rate by summing r_{acq}^C/r_{acq}^{Im} data bins of the CASH signal and impose $n_{Cell}^C = n_{Cell}^{Im}$:

$$\left[\frac{SNR^C}{SNR^{Im}} \right]_{eq} = \beta_{Im}^C \cdot \frac{\hat{P}_L^C}{P_L^{Im}} \quad \text{with} \quad \beta_{Im}^C := \sqrt{\frac{r_{acq}^C}{r_{acq}^{Im}}} \cdot \alpha_{Im}^C \quad (\text{Eq. 8})$$

In an imaging experiment, the pixel yield f_{pix} scales inversely with n_{Cell}^{Im} , the number of simultaneously imaged cells, according to $f_{pix} = \rho_C A_C l_z / n_{Cell}^{Im}$ with the segmentation length l_z measuring the axial length of the volume containing all cells positively segmented from the image frame. We estimate this length to correspond to the sum of the optical sectioning length of the microscope and the mean diameter of the nucleus in the cell population of interest. The holographic yield in CASH, on the other hand, equals $f_{holo} = A_C / (l_x l_y)$.

Substituting for f_{pix} and f_{holo} in Eq. 7 and Eq. 8 and making use of $r_{acq}^C = r_{data}^C/n_{cell}^C$:

$$\alpha_{Im}^C = \sqrt{\frac{r_{acq}^{Im}}{r_{acq}^C}} \sqrt{\frac{n_{cell}^{Im}}{n_{cell}^C}} \sqrt{\frac{r_{data}^C T_L^{Im}}{n_{holo} l_x l_y l_z \rho_C} \frac{d_L^{Im}}{d_L^C}} \quad (\text{Eq. 9})$$

and using $n_{cell}^C = n_{cell}^{Im}$:

$$\beta_{Im}^C = \sqrt{\frac{r_{data}^C T_L^{Im}}{n_{holo} l_x l_y l_z \rho_C} \frac{d_L^{Im}}{d_L^C}} \quad (\text{Eq. 10})$$

As f_{pix} , and thus α_{Im}^C and β_{Im}^C , depends on ρ_C , evaluation of Eqs. 9 and 10 needs a morphological model of the target cell distribution in the imaged field of interest.

The following table reproduces values of ρ_C from neuron reconstructions in mouse somato-sensory cortex (SS1) found in the literature⁴.

Species	Brain Region	Neuron Type	ρ_C ($\times 10^{-5} \mu\text{m}^{-3}$)
Mouse	SS1	L2/3 pyramid	8.24 ± 0.9
	SS1	L2/3 interneuron	1.122 ± 0.15
	SS1	L4 pyramid	13.78 ± 0.7
	SS1	L4 interneuron	1.16 ± 0.8
	SS1	L5 pyramid	5.13 ± 0.5
	SS1	L5 interneuron	1.04 ± 0.1

We calculate the scale factors α_{Im}^C and β_{Im}^C as function of cell density ρ_C from Eqs. 9 and 10. With β_{Im}^C known and using Eq. 8, we then estimate the ratio of the SNR offered by CASH and imaging under equalized conditions of sampling as function of cell density ρ_C and relative excitation power \hat{P}_L^C/P_L^{Im} .

Parameters used in evaluating α_{Im}^C , β_{Im}^C and $[SNR^C/SNR^{Im}]$:

r_{acq}^{Im}	20 Hz	n_{Holo}	25	l_z	7 μm
r_{data}^C	40,000/s	l_x	16 μm	d_L^C	$8 \cdot 10^{-9}$
T_L^{Im}	12.5 ns	l_y	16 μm	d_L^{Im}	$16 \cdot 10^{-6}$

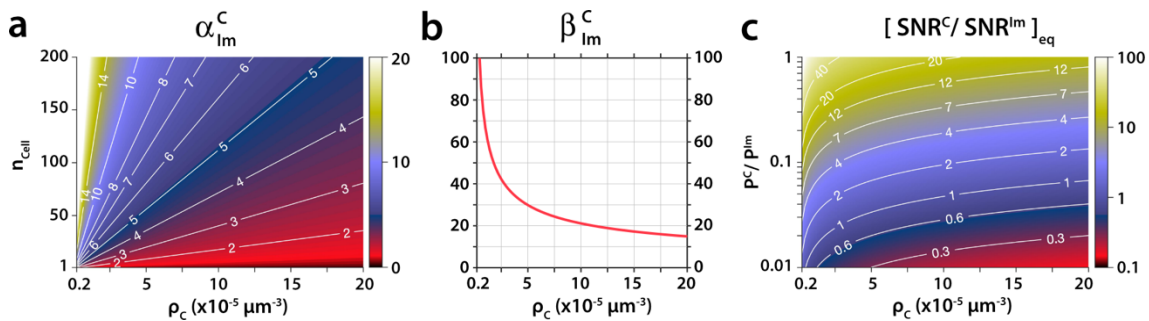

Supp. Fig. 15

(a) Scale factor α_{Im}^C as function of the cell density, ρ_C , and number of imaged cells, n_{cell}^{Im} , for a 5x5 spot grid covering a $16 \times 16 \mu\text{m}^2$ space. **(b)** Scale factor β_{Im}^C as function of the cell density ρ_C . **(c)** Ratio of expected SNRs in CASH versus imaging with equalized sampling as function of cell density ρ_C and the ratio of the mean excitation power in CASH (5x5 grid) versus imaging, \hat{P}_L^C/P_L^{Im} .

β_{Im}^C exceeds α_{Im}^C up to one order of magnitude (Supp. Fig. 15a,b) as expected from the temporal oversampling of the GCaMP signal in CASH with respect to the assumed 20 Hz rate of image frame acquisition. By taking into account maximally sustainable excitation level, limited in CASH by onset of probe saturation (Supp. Fig. 13 and associated text) and in imaging by tissue heating (Supp. Fig. 14 and associated text), and not withstanding other possible limiting effects, we consider as useful power range $0.03 < \hat{P}_L^C / P_L^{Im} < 0.3$. In this range, the estimated effective SNR_{eq} in CASH may exceed the SNR in imaging by up to a factor twelve (Supp. Fig. 15c).

In our estimation above (Supp. Fig. 13 and 14), in particular, the power ratio was 0.05 ($\hat{P}_L^C = 0.42 \text{ mW}$, $P_L^{Im} = 8 \text{ mW}$). This results in SNR of similar magnitude ($[\text{SNR}^C / \text{SNR}^{Im}]_{\text{eq}} = 1.2$) in case of a target cell density resembling the pyramidal neuron population in the supra-granular layer of mouse cortex⁴ ($\rho_C = 8.2 \cdot 10^{-5} \mu\text{m}^{-3}$), and about three times higher SNR in case of the same layer interneuron population⁴ ($[\text{SNR}^C / \text{SNR}^{Im}]_{\text{eq}} = 3.1$; $\rho_C = 1.1 \cdot 10^{-5} \mu\text{m}^{-3}$), for instance.

Spatial resolution of the 3DScope acousto-optic light modulator

The spatial resolution of an AOD defines the maximum number of distinct spots the AOD permits to create in the far field or, equivalently, in the focal plane of an added ideal focusing element which is: $N = \Delta\theta_{\text{scan}} / \Delta\theta_{\text{beam}}$, where $\Delta\theta_{\text{scan}}$ is the AOD angular tuning range and $\Delta\theta_{\text{beam}}$, the angular spread of the laser beam⁵. $\Delta\theta_{\text{scan}}$ can be expressed as $\Delta\theta_{\text{scan}} = M_{\text{ang}} \lambda / v \Delta f = 4.2^\circ$, with Δf , the total scan bandwidth (36 MHz), M_{ang} , the angular magnification (1.5) of the AOD-objective relay, and λ , the wavelength (900 nm). In the diffraction limit, $\Delta\theta_{\text{beam}} = M_{\text{ang}} \cdot 1.22 \lambda / D_{\text{AOD}}$, with D_{AOD} , the AOD aperture diameter (15 mm). Therefore, $N_{\text{diff}} \approx 680$ for $\lambda = 900 \text{ nm}$. In the 3DScope, the laser beam is additionally broadened by angular chromatic dispersion at AOD side band frequencies while angular dispersion is compensated for the acoustic carrier wave. In this case, $\Delta\theta_{\text{beam}} \leq M_{\text{ang}} \cdot \Delta\lambda / v \cdot \Delta f / 2$, with $\Delta\lambda = 0.44 \lambda^2 \cdot \tau_{\text{laser}} / c$, the FWHM wavelength broadening of a Gaussian laser pulse (6 nm for $\tau_{\text{laser}} = 200 \text{ fs}$) and $\pm \Delta f / 2$, the extremal frequencies in the side bands. Thus, $N_{\text{disp}} \geq 2 c \tau_{\text{laser}} / (0.44 \cdot \lambda) \approx 300$. Notably, the diffraction and dispersion limits, N_{diff} and N_{disp} are far below the digital frequency resolution ($N_{\text{digital}} = 6 \cdot 10^5$) of the DDS (59.6 Hz/bit; 23 bit; 36 MHz AO bandwidth). Finally, the FM resolution depends on the pixelization of the AOD-shaped wavefront as a consequence of RF-AOD being synthesized on a 14 MHz DDS write clock. Given the 15 mm size of the aperture, the discretization grid has a size of $n_{\text{pix}} = 324$. The digital pixelization limits the FM spatial frequency in the AOD pupil to $\pm 0.5 n_{\text{pix}} / D_{\text{AOD}}$. Therefore, the maximal spot number N_{pix} due to the pixelation limit becomes $N_{\text{pix}} < 0.5 n_{\text{pix}} \approx 162$.

Supplementary References

1. Xu, C. & Webb, W. W. Multiphoton excitation of molecular fluorophores and nonlinear laser microscopy. in *Topics in Fluorescence Spectroscopy* vol. 5 471–540 (Plenum Press, 1997).
2. Tsai, P. S. & Kleinfeld, D. In Vivo Two-Photon Laser Scanning Microscopy with Concurrent Plasma-Mediated Ablation Principles and Hardware Realization. in *In Vivo Optical Imaging of Brain Function* (ed. Frostig, R. D.) (CRC Press/Taylor & Francis, 2009).
3. Drobizhev, M., Makarov, N. S., Tillo, S. E., Hughes, T. E. & Rebane, A. Two-photon absorption properties of fluorescent proteins. *Nat. Methods* **8**, 393–399 (2011).
4. Lefort, S., Tomm, C., Floyd Sarria, J.-C. & Petersen, C. C. H. The Excitatory Neuronal Network of the C2 Barrel Column in Mouse Primary Somatosensory Cortex. *Neuron* **61**, 301–316 (2009).
5. Iyer, V., Losavio B.E., & Saggau, P. Compensation of spatial and temporal dispersion for acousto-optic multiphoton laser-scanning microscopy. *J. Biomed. Opt.* **8**, 460–471 (2003).