



HAL
open science

Process operating mode monitoring: switching online the right controller

Philippe Charbonnaud, Frédéric Rotella, Smaïn Médar

► **To cite this version:**

Philippe Charbonnaud, Frédéric Rotella, Smaïn Médar. Process operating mode monitoring: switching online the right controller. *IEEE Transactions on Systems, Man, and Cybernetics, Part C: Applications and Reviews*, 2001, 3 (1), pp.77-86. 10.1109/5326.923270 . hal-03604751

HAL Id: hal-03604751

<https://hal.science/hal-03604751>

Submitted on 10 Mar 2022

HAL is a multi-disciplinary open access archive for the deposit and dissemination of scientific research documents, whether they are published or not. The documents may come from teaching and research institutions in France or abroad, or from public or private research centers.

L'archive ouverte pluridisciplinaire **HAL**, est destinée au dépôt et à la diffusion de documents scientifiques de niveau recherche, publiés ou non, émanant des établissements d'enseignement et de recherche français ou étrangers, des laboratoires publics ou privés.



Open Archive Toulouse Archive Ouverte (OATAO)

OATAO is an open access repository that collects the work of some Toulouse researchers and makes it freely available over the web where possible.

This is an author's version published in: <https://oatao.univ-toulouse.fr/58>

Official URL : <http://dx.doi.org/10.1109/5326.923270>

To cite this version :

Charbonnaud, Philippe and Rotella, Frédéric and Médar, Smaïn *Process operating mode monitoring : switching online the right controller* (2001) IEEE Transactions on Systems, Man, and Cybernetics, Part C: Applications and Reviews, 3 (1). 77-86. ISSN 1094-6977

Any correspondence concerning this service should be sent to the repository administrator:

tech-oatao@listes-diff.inp-toulouse.fr

Process Operating Mode Monitoring: Switching Online the Right Controller

Philippe Charbonnaud, Frédéric Rotella, and Smain Médar

Abstract—This paper presents a structure which deals with process operating mode monitoring and allows the control law reconfiguration by switching online the right controller. After a short review of the advances in switching based control systems during the last decade, we introduce our approach based on the definition of operating modes of a plant. The control reconfiguration strategy is achieved by online selection of an adequate controller, in a case of active accommodation. The main contribution lies in settling up the design steps of the multicontroller structure and its accurate integration in the operating mode detection and accommodation loop. Simulation results show the effectiveness of the operating mode detection and accommodation (OMDA) structure for which the design steps propose a method to study the asymptotic stability, switching performances improvement, and the tuning of the multimodel based detector.

Index Terms—Accommodation, control monitoring, detection, hybrid control, operating mode, reconfiguration.

I. INTRODUCTION

INACCURATE plant models and process faulty behaviors are two strong problems which restrict the closed-loop performance during the lifetime of a system. Fault-tolerant control deals with *a priori* well known faulty behavior of the controlled process. An efficient controller has to maintain the objective of the process with the best performances. According to the exogenous events, the detection of operating mode becomes a crucial point. Fault detection, isolation techniques, and control methods may be combined together to propose an integrated approach to accommodate the controller to noise and disturbances.

Iserman and Ballé [1] proposed a supervision architecture to monitor a physical system and to take appropriate actions to maintain its functioning in a faulty environment. Maximizing system life and performances while minimizing maintenance induces a more “intelligent” controller architecture. This architecture of knowledge-based fault detection and diagnosis aims at exploiting analytic and heuristic symptoms and at combining them together to make a fault diagnosis. The type and location of the fault are determined by analytical methods or by reasoning based approaches. Musgrave [2] introduced a real-time controller accommodation based on improved control and monitoring algorithms combined together with additional sensing and actuation. In this approach, control reconfiguration consists in switching and tuning among a set of controllers according

to the appropriate plant model. The reconfigurable controller scheme makes the system more autonomous. Some industrial applications of real-time accommodation to actuator faults on a reusable rocket engine [2] or to autonomous control reconfiguration for high-speed ship with four submerged hulls [3], demonstrate the effectiveness of these approaches.

For supervisory control of hybrid dynamical systems Morse proposed a state-shared estimator-based supervisor to compute the output estimation errors that determine the best performance signal [4]–[7]. Then the appropriate set point controller is selected. Therein, the supervisor is a simple “high level” controller using logic-based switching. The selection is achieved according to some predefined strategies based on hysteresis, prerouted, cyclic, or dwell-time switching [8]. In the context of model reference adaptive control (MRAC) of LTI systems, Narendra and Balakrishnan presented a survey on switching and tuning scheme for adaptive control using multiple models [9]. They distinguished between direct switching based on a predetermined sequence of controllers and indirect switching which asks for when and what is the next best controller to select. An intelligent controller is able to adapt to any operating environment by taking into account stability and by improving the transient response performance [10].

In our approach an operating mode detection and accommodation (OMDA) structure is introduced to deal with an active supervisory control integrating an additional detection–accommodation loop (see Fig. 1). The active control is based on indirect switching strategy in the sense that it deals with the detection of the switching time and the selection of the right controller.

Then, a multicontroller structure is required to control a process with several operating modes (OMs). Very often, the OMs are well known. If not, they may be identified from the measured inputs and outputs. An analytical expression of the process output y can be approached as

$$y \simeq \hat{y} = \delta_m^1 y_1 + \delta_m^2 y_2 + \dots + \delta_m^g y_g = \sum_{j=1}^g \delta_m^j y_j \quad (1)$$

where

- g number of process operating modes;
- m actual operating mode;
- δ_m^j equal to 1 if $m = j$ and 0 otherwise.

Each y_j is an estimate of the process output for a given control input u_r . The main problem of OM detection (see Fig. 2) lies in the real-time estimation of m at the boundary between two OM, i.e., the present behavior of the physical process in order to determine among a set of controllers the best fitted one. The design of the detection function is a crucial step which ensures

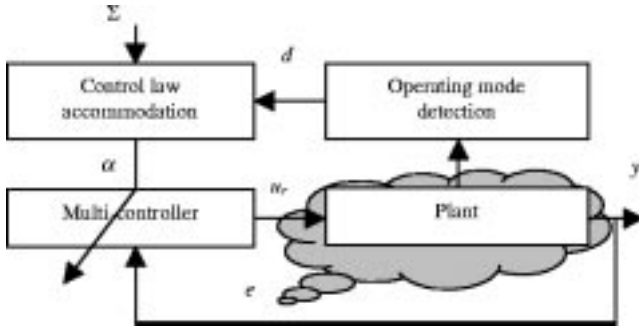

Fig. 1. OMDA structure of a feedback system.

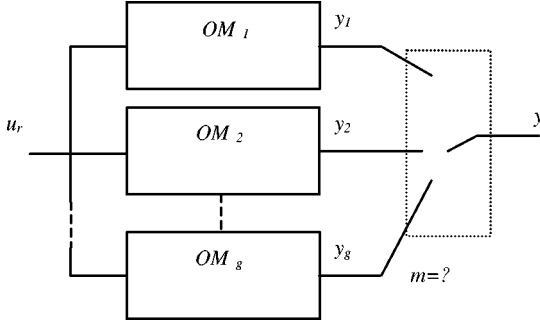

Fig. 2. Operating mode detection problem.

the efficiency of the switching strategy. Then, the detection algorithm has to figure out the OM current value of the monitored process and has also to compare it with the OM previously detected.

The aforementioned structure allows performing the plant mission in the presence of exogenous events e . The supervision set-point Σ describes the objectives, e.g., change in the reference set-point, change in the control objective, to be achieved and the performances associated to the controller. The accommodation information vector α settles the set-points computed for the selected controller. The monitoring loop efficiency is linked to the detection time delay of an OM change given by the detection vector d . The accommodation strategy is selected according to the information vector compared to the supervision set-points. Before the next switching time, if the active controller does not allow achieving the performances for the given objective, the actual OM of the process must be identified to be accommodated by the right controller.

However, switching between controllers induces a bump discontinuity of the control input which in turn results in closed loop performances deterioration and large overshoots in the output and sometimes instability. This is referred to as control input substitution [11]. Also, actuator saturation may cause the same degradation, which is referred to as control input limitation [11]. To take into account these drawbacks, antiwindup bumpless transfer (AWBT) compensators are introduced. The OMDA structure is designed to compensate the substitution and limitation nonlinearities of the multicontroller by associating an AWBT compensator to each controller to improve transient response at the switching time. Several methods are available to design such compensators. Hanus *et al.* [12] proposed a conditioning technique to design a self-conditioned

controller which ensures antiwindup and bumpless transfer. A comparison between different AWBT schemes was proposed in [13], where the advantages and drawbacks of the associated algorithms were discussed. Kothare and Morari [15] presented an application of the passivity theorem with the appropriate choice of design parameters to develop sufficient conditions for stability of the general AWBT framework.

In this paper, an active supervisory control of OMs integrating an additional detection–accommodation loop is presented. The operating modes concept is defined in the second section. OM representation is a common way to establish the link between the plant operator skills and the minimal knowledge for the design of supervision system. Also, we will explain the motivation of using OM online monitoring. This monitoring structure consists of two combined blocks: one for the model-based detection, which allows detecting a given process operating mode, and the other one for the accommodation decision, which selects the right controller. In the third section, a control accommodation strategy is modeled and verified by a hybrid automation. The fourth section presents a canonical form for an indirect switching approach of the accommodation strategy which is based on the multicontroller structure. The fifth section introduces the design steps involved in constructing the multicontroller structure. In the sixth section, the presented ideas are exemplified through an application to multiple operating modes revealing that the OMDA structure is an interesting way to improve the performance even in presence of plant disturbances.

II. OPERATING MODE MONITORING

Intuitively the notion of operating mode is linked to the tracking objective and also to its connected closed-loop performances. The fitted operating modes of a plant are always *a priori* well defined. In presence of important disturbances, the process objective is held while the associated criterion is satisfied. When less constrained performances may be acceptable, a reconfiguration of the controller is required. When the objective is also changed, a restructuring of the feedback process is made.

A given plant is usually defined by its actuators, process, and sensors (see Fig. 3). Exogenous discrete events $\{e_k\}$ cause several kinds of disturbances on the plant behavior. Each component may be subjected to specific inherent perturbations. Actuator windup, sensors drift, and process thermal effects, respectively, denoted (e_A, e_P, e_S) , are examples of such inherent perturbation events.

The process transforms the input stream into the output stream with an additional value. The plant objective is to make the output stream with a total quality and dependability.¹ In order to achieve this objective, the OMDA structure is proposed to supervise the plant.

The plant P is a set of possible behaviors $P = \{P_i, i \in N^*\}$. According to the discrete events set $\{e_k\}$, the output is controlled by the effective law u_r . When the OMs are not *a priori*

¹The dependability can be expressed by the mean time between failure (MTBF) and the mean time between repair (MTTR) as $D = MTBF/MTTR + MTBF$.

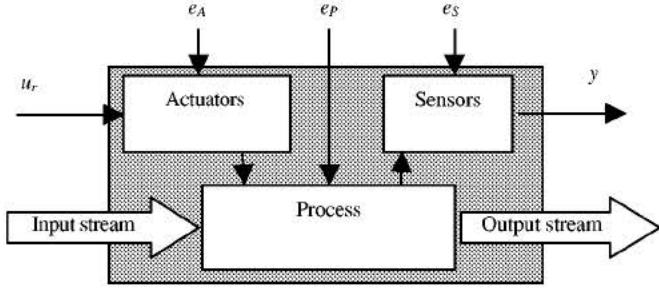

Fig. 3. Plant functional representation.

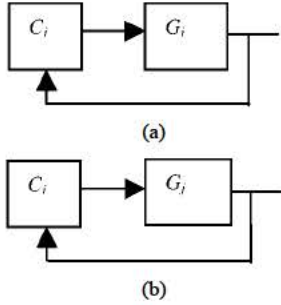

Fig. 4. Feedback plant. (a) Fitted OM (b) Nonfitted OM.

known the first step is to isolate the main operating modes and the second step is to identify the corresponding models. These modes induce a partition of the process model G of the plant P into a finite class of linear models $G = \{G_1, G_2, \dots, G_g\}$, where the i th linear model of the plant P is denoted G_i and $g = \text{card}(G)$, to which is associated a controller family C . The corresponding designed controller achieves the best performance of the closed-loop (C_i, G_i) . Let us define now an operating mode matrix M such as

$$M = \{M_{i,j} = (C_i, G_j), (i, j) \in I^2\} \quad (2)$$

where I is a finite set of integer $I = \{1, \dots, g\}$. If $j = i$, then $M_{i,j}$ represents the i th fitted operating mode [see Fig. 4(a)], else if $j \neq i$, then $M_{i,j}$ corresponds to one of the nonfitted operating modes [see Fig. 4(b)].

In order to determine when and to which controller one should switch, a detection method is detailed in the following. The latest uses a test which computes a detection vector from the residues derived according to the principle shown in Fig. 5. The detector consists of three functions.

- 1) the simulation of the models $G = \{G_j, j \in I\}$ controlled by the signal u_r , which is output by the active controller;
- 2) the residue evaluation for each output model according to the fixed criterion;
- 3) the function mode isolation based on the detection rule.

For each $j \in I$, the criterion is expressed by

$$J_j(k) = \sum_{n=1}^N w_n \varepsilon_{j,n}(k) \quad (3)$$

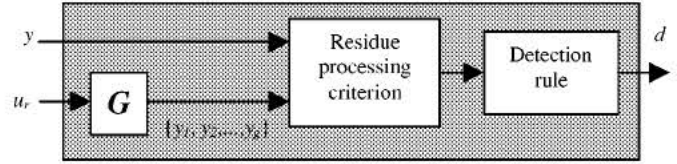

Fig. 5. Multimodel based detector.

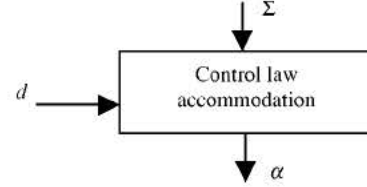

Fig. 6. Accommodation block.

where N is the size of the sliding window, $\varepsilon_{j,n}(k)$ is the j th identification error, $k > N$, and

$$w_n = \frac{1}{N-1} \quad \text{and} \quad \varepsilon_{j,n}(k) = (y(k+n) - y_j(k+n))^2. \quad (4)$$

The multimodel output recursive square error (MORSE) criterion $J(k) = [J_1(k) J_2(k) \dots J_j(k) \dots]$ is computed with the recursive formula

$$J_j(k+1) = J_j(k) + w_n(\varepsilon_j(k+1) - \varepsilon_j(k-N+1)). \quad (5)$$

The couple (d, t_d) defines the detection test which describes each OM detected $d(k)$ and the detection time $t_d(k)$. The detection rule is computed online by

$$d(k) = \left\{ P = G_m, m = \arg \min_{1 \leq j \leq g} J_j(k) \right\}. \quad (6)$$

At each sampling period, a minimization of the criterion given by (3) is carried out to activate the controller corresponding to the model with the smallest index J_j . At the starting time, it is assumed that $d(0) = G_1$. The detection time is defined by

$$t_d(k) = \{kT_d, d(k) \neq d(k-1)\} \quad (7)$$

where T_d is the sampling period of the detection-accommodation loop.

When the OM are somehow close in the sense of the $\|\cdot\|_2$ norm, the problem of fast switching may occur. Morse [8] introduced the "dwell time" which is a lower bound of the set of time differences between each two successive switching periods. Narendra and Balakrishnan [9] introduced a positive waiting period to elapse after every switch. In our approach, the OM are chosen sufficiently distant in the sense of the $\|\cdot\|_2$ norm to avoid such fast switching. For a correct signal-to-noise ratio a good choice of N and T_d allows a good tuning of the multimodel based detector.

III. SWITCHING ONLINE THE RIGHT CONTROLLER

The accommodation block (see Fig. 6) selects the adequate controller according to the supervision set-point Σ and to the

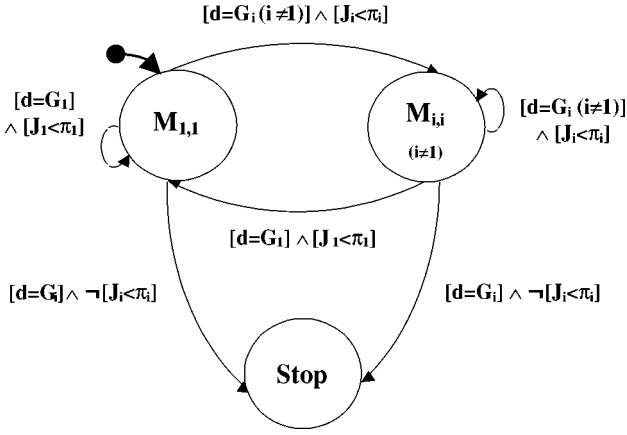

Fig. 7. Hybrid automaton model of the accommodation block.

detection vector d . The supervision set-point Σ is defined by the pair (O, Π^T) where O is the set of objectives to be achieved and $\Pi = [\pi_1, \pi_2, \dots, \pi_g]$ is the performance vector associated to the g modes, $\Pi \in \mathbb{R}^n$. In this paper, we consider only one objective, i.e., tracking the output of a SISO system to a constant reference input signal. The accommodation vector α is a piecewise continuous switching signal which represents the series of the successive activated controllers. For the time kT_d , the activated controller is $C_{\alpha(k)}$, where the accommodation information vector α is expressed by

$$\alpha(k) = \{l, [d(k) = G_l] \wedge [J_l < \pi_l]\}. \quad (8)$$

If the performance condition $J_l < \pi_l$ is not satisfied, an emergency shutdown procedure is activated and a maintenance operation is carried out on the damaged area of the system.

The functioning of the accommodation block can be modeled and verified by the hybrid automaton [25] depicted in Fig. 7. The states of this automaton are continuous in the sense that they describe the OM (closed-loop response) and its transitions describe the switching between different modes according to the accommodation rule.

The functioning of this hybrid automaton is roughly as follows. The initial state is $M_{1,1}$, i.e., without loss of generality we assume the process to be in the first OM at the starting time. Whenever there exists a model G_i whose related criterion minimizes the performance index J and satisfies the performance π_i at a time k , the state of the system switches to $M_{i,i}$; otherwise, if it does not satisfy the performance π_i , the state of the system switches to the stop state. Therefore, the supervisor under consideration is a hybrid system in the sense that it involves both continuous dynamics (closed-loop response) and a discrete phenomenon which is switching among a bank of controllers according to the exogenous event e .

IV. MULTICONTROLLER STRUCTURE

The multicontroller structure is a finite set of candidate controller as shown in Fig. 8. It integrates two nonlinearities: 1) substitution type (switching) and 2) limitation type (actuator saturation).

To avoid a possible destabilization due to control input switching or saturation, an AWBT W_i is designed to com-

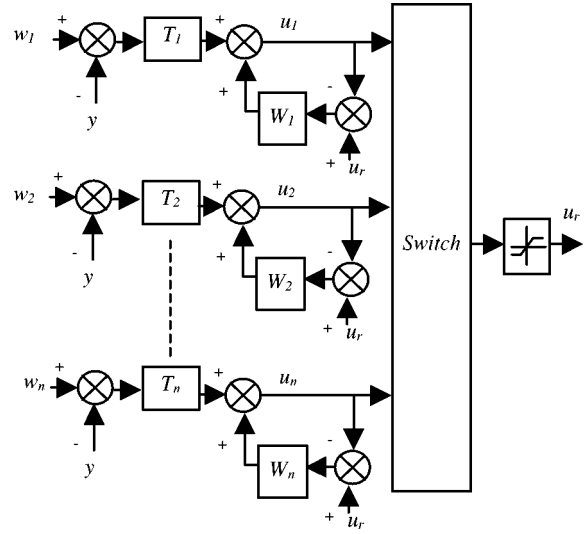

Fig. 8. Multicontroller structure.

pensate these nonlinearities which are introduced by the multicontroller structure. Here, (T_i, W_i) represents the active controller T_i with its AWBT W_i .

Let us consider the expression of the actual control input u_r .

$$u_r(k) = \sum_{i=1}^g \delta_{\alpha(k)}^i u_i, \quad |u_i| < u_{\max}. \quad (9)$$

Also, the control input of the i th controller is expressed by the generic formula

$$u_i = T_i(w_i - y) + W_i(u_r - u_i). \quad (10)$$

When $u_i = u_r$, the selected C_i controller is the T_i controller with its corresponding AWBT W_i , and more generally, the control input of C_i controllers are expressed by the following relation:

$$u_i = \frac{T_i}{1 + W_i}(w_i - y) + \frac{W_i}{1 + W_i}u_r. \quad (11)$$

In order to find a canonical form for this multimodel structure, (11) can be rewritten as

$$(1 + W_i)u_i = T_i w_i + W_i u_r - T_i y. \quad (12)$$

Then, the generalized relation (13) is derived from (12)

$$u = \text{diag} \left\{ \frac{T_i}{1 + W_i} \right\} w + \text{vec} \left\{ \frac{W_i}{1 + W_i} \right\} u_r - \text{vec} \left\{ \frac{T_i}{1 + W_i} \right\} y \quad (13)$$

where $w = [w_1 w_2 \dots w_g]^T$, $\text{diag} \{ \}$ is an operator which creates diagonal matrix from a given set of data, and $\text{vec} \{ \}$ is an operator that creates a vector from a given set of data [27]. Let us denote

$$T = \text{diag} \{ T_i \} \quad R = \text{diag} \{ 1 + W_i \} \quad S = T \begin{bmatrix} 1 \\ 1 \\ 1 \end{bmatrix}. \quad (14)$$

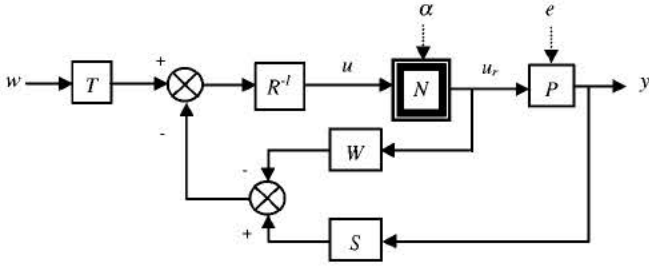

Fig. 9. Canonical multicontroller structure.

The multicontroller MC is a set of four matrices

$$MC = (R, S, T, W). \quad (15)$$

The canonical MC structure is represented in Fig. 9. The simulation of the multicontroller (see Fig. 8) can be implemented from the MC canonical structure (see Fig. 9) which satisfies the particular relations (15). The MC design steps and simulation are more developed in the next sections to show the efficiency of the OMDA structure.

V. MC STRUCTURE DESIGN STEPS

This section deals with the design steps of the MC structure. Although hybrid and switched systems are well treated theoretically in the literature, there is a lack of practical and design issues concerning these methods. That is why we have made an attempt to settle up the design steps involved in such methods. In the first step, we will talk about G_i operating modes modeling. In a second step, we will design a controller T_i for each operating mode of the process according to the desired performances of the closed-loop $T_i G_i$. The third step discusses the MC structure asymptotic stability issues. The fourth step deals with the switching performances improvement by W_i AWBT design. The four first steps allow the design of the MC structure. Finally, in the fifth part, we will verify the accommodation performances in presence of “nonconsecutive” exogenous events and an additive white noise.

A. First Step: G_i Operating Modes Modeling

The process to be controlled is considered to be single-input single-output linear time-invariant with large parametric uncertainties. Its transfer function is a member of a well known family of transfer functions G_j , $j \in I$. This family represents the j th operating mode with its unmodeled dynamics, i.e., additive and multiplicative uncertainties. When the process OM are *a priori* well known, the settlement of the G_j , $j \in I$ models is trivial. Otherwise, each G_j model must be identified according to the strategy of control monitoring. Morse [4] considers for the state-shared estimator a set of several classes of transfer functions, with bounded parameters, which are *centered* on nominal transfer functions, so that only models called *centers* of the corresponding classes are considered in controllers design.

In the sequel, we will use the following nonlinear time varying differential equation to represent the switched system realized by the feedback connection of $T_i G_j$

$$\dot{x}(t) = A(t)x(t) \quad x(0) = x_0 \quad (16)$$

where $A(t)$ switches between the matrices belonging to the set $\{A_{i,j}, (i, j) \in I^2\}$, $A_{i,j}$ represents the system matrix of state space realization of the closed loop of $T_i G_j$, and $x(0) = x_0$ is the equilibrium state of the switched system. The set of the latest matrices represent g^2 modes, where g are the nominal OM, i.e., $(i = j)$, and $(g^2 - g)$ are the transient modes, i.e., $(i \neq j)$, that must be detected to accommodate the actual OM. Also, this set of matrices will help us study the stability of the switched system in the sequel.

B. Second Step: T_i Controllers Design

In the following, $H(s)$ will denote the closed loop transfer function. The specifications for $H(s)$ settle the plant dynamics. The roots of $1 + T_i G_i$ must satisfy the desired closed-loop performances. We have also to ensure that each T_i stabilizes asymptotically each G_i . The design of $T_i(s)$ may be realized by linear robust control synthesis methods [16], [20]. It is also possible to design T_i using adaptive control design methods [18], [19]. Narendra and Balakrishnan [9], [10] worked on a switching scheme in the context of MRAC, where they used both fixed and adaptive parameters controllers. On the other hand, in [4] and [5], only fixed parameters controllers, which are designed with robust control laws, were used.

C. Third Step: MC Structure Asymptotic Stability

The stability analysis of the switched systems proceeds in two steps: 1) stability analysis of each subsystem, i.e., each controller must asymptotically stabilize each process operating mode, and 2) stability analysis of the overall system for arbitrary switching signals.

Liberzon and Morse [17] presented a survey of basic problems in stability and design of switched systems. Recent results are exposed therein and three basic problems are studied in terms of arbitrary and slow switching schemes:

- 1) to find conditions on each switching signal that guarantee the asymptotic stability of (16);
- 2) to identify the switching signals for which (16) is asymptotically stable;
- 3) to construct a switching signal that makes (16) asymptotically stable.

Most works on stability of hybrid and switched systems are based on Lyapunov theory [21]–[24]. In [22], Shorten and Narendra gave necessary and sufficient conditions for the existence of quadratic common Lyapunov function for a pair of second-order asymptotically stable linear systems. However, the property of admissible switching can be used to conclude on asymptotic stability of (16) even though it does not possess a common Lyapunov function [23].

For the first step, there are many methods form control systems to analyze the stability of each subsystem, or one can find a Lyapunov function $V_{i,j}(x)$, $(i, j) \in I^2$, associated to each $A_{i,j}$ to establish a sufficient condition that each T_i stabilizes asymptotically each G_j , $j \in I$. Then, we have to find a symmetric positive definite matrix $R_{i,j} = [r_{l,m}]$ which makes $V_{i,j}(x)$ positive definite.

$$V_{i,j}(x) = x^T R_{i,j} x. \quad (17)$$

Let us denote $Q_{i,j}$ a positive definite matrix such that $\dot{V}_{i,j}(x)$ will be negative definite.

$$\dot{V}_{i,j}(x) = -x^T Q_{i,j} x. \quad (18)$$

If the linear system associated to the nonlinear one is asymptotically stable, then the latest is asymptotically stable. The controller T_i stabilizes asymptotically each G_j , i and $j \in I$, if there exist positive definite matrices $R_{i,j}$ and $Q_{i,j}$, such that

$$A_{i,j}^T R_{i,j} + R_{i,j} A_{i,j} = -Q_{i,j}. \quad (19)$$

If one can find some conditions on the positive definiteness of $R_{i,j}$, we can conclude on the asymptotic stability.

For the second step, one has to find a common Lyapunov function for the linear systems described by the matrices $A_{i,j}$, $(i, j) \in I^2$, to conclude on asymptotic stability of (16). If the systems of (16) share a common Lyapunov function, i.e., if there exist two symmetric positive definite matrices R and Q such that

$$A_{i,j}^T R + R A_{i,j} \leq -Q \quad \forall (i, j) \in I^2 \quad (20)$$

then, the switched system is asymptotically stable [17].

D. Fourth Step: Switching Performances Improvement by W_i AWBT Design

In the previous section, we pointed out the loss of performances that could result from switching between controllers. Usually the performances of a transient response to a reference step input are measured in terms of overshoot and settling time. Here, in addition to considering the latest performances, we have to take into account the performances of the transient response at the switching time that will be called “switching transient response performances.” The loss of performances lies in large bumps and long settling times of the switching transient response, due to the discontinuities of the control input signal u_r . Moreover, these large bumps might not be supported by the actuator. This results in control input saturation.

We propose to add an AWBT compensator to each controller in the MC structure to enhance the switching transient response performances. All known LTI AWBT [11]–[15] schemes are designed in two steps: 1) design the controllers ignoring the substitution and saturation nonlinearities; and 2) add AWBT compensators to minimize the effects of any control input discontinuities on the closed-loop performances.

E. Fifth Step: Accommodation in Presence of “Nonconsecutive” Exogenous Events and an Additive White Noise

The purpose of this section is to show the interesting properties of the detector and hence the accommodation algorithm in the presence of an additive white noise and when the process is evolving in a randomized operating mode sequence. The detection can be enhanced by tuning the size of the sliding window N and the sampling period T_d of the detection and accommodation loop.

VI. MULTIPLE OPERATING MODES CONTROL ACCOMMODATION

The application of MC structure is well suited when the order of the process is not always well known and when it changes. This section gives an example on the use of the MC structure for a first order system with an integration. We will first design a controller for each operating mode of the process, then we analyze the performances of the switching scheme when the process parameters change in a deterministic manner in their uncertainty regions, and finally when they change in random manner with the presence of an additive white noise in the process output.

A. First Step: G_i Operating Modes Modeling

It is proposed to study the application of the OMDA structure on a process described by the following transfer function:

$$P_\theta(s) = \frac{s + b}{s(s + a)} \quad (21)$$

where $\theta = [b, a]$ is the process parameter vector, a and b are unknown but take values in predefined and compact intervals in \mathcal{R} . In the sequel, we will assume that the set of these transfer functions \mathcal{P} is denoted by

$$\mathcal{P} = \bigcup_{\theta \in L} P_\theta(s) \quad (22)$$

where $L = (0, 1] \times (1, 2]$. The interval L is divided into four distinct regions where each one represents the uncertainty domain of an operating mode. Also, the transfer function of this operating mode is considered to be the *center* of the family of transfer functions whose parameters belong to the corresponding uncertain region. In this example, 51 process models are used, from which four represent the main OM, $(G_1(s), G_2(s), G_3(s), G_4(s))$ which are given by the following transfer functions:

$$\begin{aligned} G_1(s) &= \frac{s + 0.20}{s(s + 1.20)} & G_2(s) &= \frac{s + 0.25}{s(s + 1.25)} \\ G_3(s) &= \frac{s + 0.50}{s(s + 1.50)} & G_4(s) &= \frac{s + 1.00}{s(s + 2.00)}. \end{aligned} \quad (23)$$

B. Second Step: T_i Controllers Design

According to the chosen design specifications, the closed-loop transfer function must be of the form

$$H(s) = \frac{1}{s + 1} \quad (24)$$

to track the process output to a step reference input signal with unit amplitude. A possible controller which can satisfy these requirements, can be given by the following transfer function:

$$T_\theta(s) = \frac{s + a}{s + b}. \quad (25)$$

The four associated controllers are given by (25) where

$$\begin{aligned} \theta_1 &= [1.20, 0.20] & \theta_2 &= [1.25, 0.25] \\ \theta_3 &= [1.50, 0.50] & \theta_4 &= [2.00, 1.00]. \end{aligned} \quad (26)$$

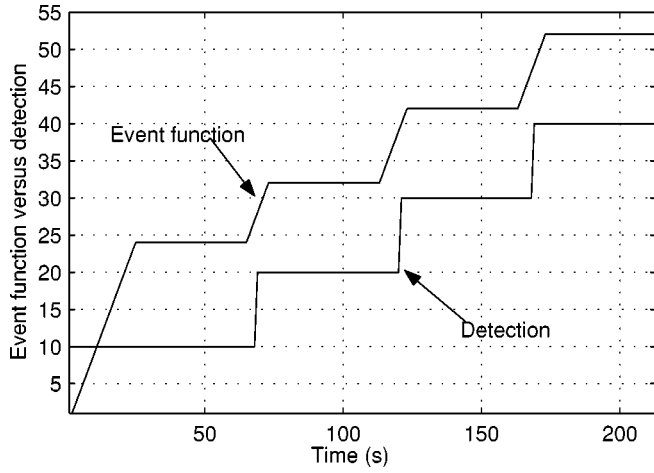

Fig. 10. Event function and detected operating modes.

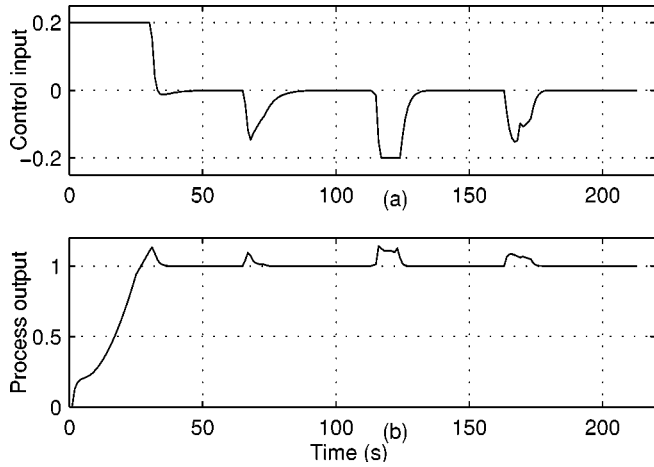

Fig. 11. (a) Control input without AWBT. (b) Process output without AWBT.

In the following, we will see the behavior of the MC structure when the process is evolving in a deterministic manner, i.e., ascending order of operating modes. The process is disturbed by a perturbing event which is detected as shown in Fig. 10. The control input u_r and the process output y , without introducing an AWBT, are depicted, respectively, on Figs. 11(a) and 11(b). Here, one can see the saturation of the control input u_r between $t = 0$ s and $t = 30$ s, $t = 22$ s and $t = 28$ s, and $t = 117$ s and $t = 124$ s. These saturations are due to the control input discontinuity at each switching instant between controllers. Moreover, they are also due to the evolution of the process from the neighborhood of an operating mode to its transfer function, i.e., the transition of the process from one transfer function to another cannot be achieved without direct consequences on the control input and hence on the process output. To take into account this controller windup, AWBT compensators will be designed.

C. Third Step: MC Structure Asymptotic Stability

An alternative issue to show the stability of each single system (16), where $A(t)$ is the system matrix of the feedback connection of the controller T_i and the process model G_j , is to evaluate its largest eigenvalue with respect to the process parameter vector θ . Since the number of controllers is four, it

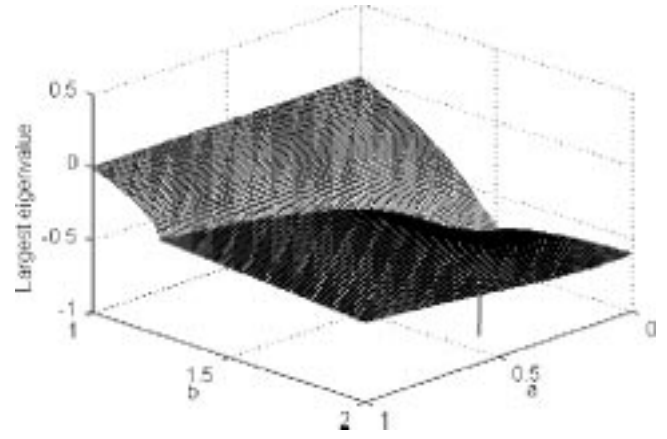

Fig. 12. Largest eigenvalues corresponding to the first controller.

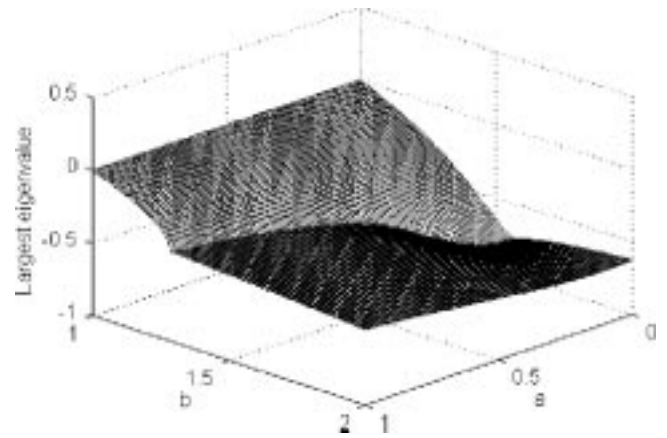

Fig. 13. Largest eigenvalues corresponding to the second controller.

will be shown that each controller T_i stabilizes asymptotically each G_j ; (Figs. 12 –15) show the largest eigenvalue associated to each pair (a, b) .

On these figures, we can see that instability occurs when the parameter b is equal to 1 independently from the value of the parameter a . However, the latest parameter varies in $[1.2, 2]$; thus, we can conclude that each controller stabilizes asymptotically the process. The second step is to ensure the stability of the overall system, i.e., when switching occurs between each subsystem. To do this, one has to construct a common Lyapunov function for the switched system. We have used the algorithm proposed in [26]. The overall system, i.e., the combination of the four controllers with the four operating modes, was found to be globally asymptotically stable and its common Lyapunov function is $V(x) = x^T R x$ where

$$R = \begin{bmatrix} 1.9716 & 2.3781 & 1.5652 \\ 2.3781 & 5.8662 & 3.6517 \\ 1.5652 & 3.6517 & 4.4116 \end{bmatrix}. \quad (27)$$

D. Fourth Step: Switching Performances Improvement by W_i AWBT Design

We propose to add an AWBT compensator to each controller in the MC structure to enhance the switching transient response

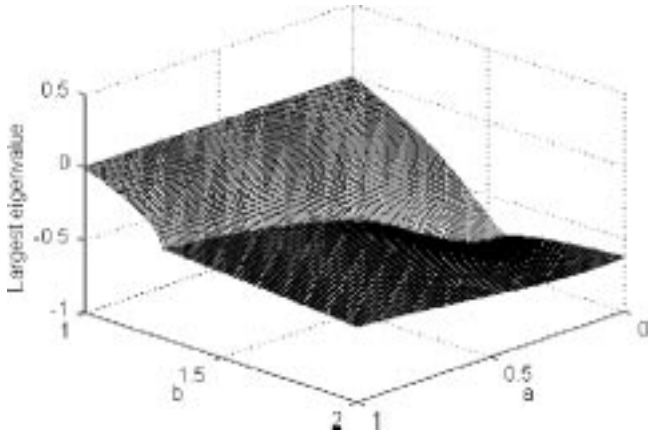

Fig. 14. Largest eigenvalues corresponding to the third controller.

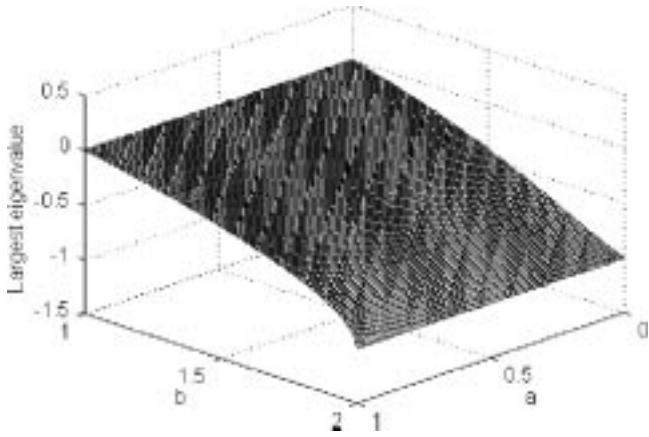

Fig. 15. Largest eigenvalues corresponding to the fourth controller.

performances. To do this, let us consider the antiwindup bumpless pole-gain transfer function W_i

$$W_i(s) = \frac{k_i}{Q_i(s)} \quad i \in \{1, 2, 3, 4\}. \quad (28)$$

The rule to design $W_i(s)$ is based on the choice of the gain k_i and the roots of $Q_i(s)$. Figs. 16(b) and 17(b) show, respectively, the control input and the process output when adding an AWBT compensator to each controller, where: $k_i = 1$, $Q_i(s) = s$, $i \in \{1, 2, 3, 4\}$. Although there is an enhancement in the transient response between $t = 0$ s and $t = 25$ s by the anti-windup action which occurred at the same time, the process output did not reach the desired steady-state. Therefore, another set of AWBT compensators has to be designed.

An interesting AWBT compensators set was found to be $k_i = 1$, $Q_1(s) = s + 0.2$, $Q_2(s) = s + 0.25$, $Q_3(s) = s + 0.5$, and $Q_4(s) = s + 1$. In comparison with the latest results, there is a good enhancement in the performances of the control input and process output (see Figs. 16(c) and 17(c), respectively).

One can discern the effect of the antiwindup action on the control input between $t = 15$ s and $t = 28$ s. Of course in designing AWBT compensators, one has to take into account the internal stability of the system. By proper design of these compensators it is meant to ensure good performances of the process

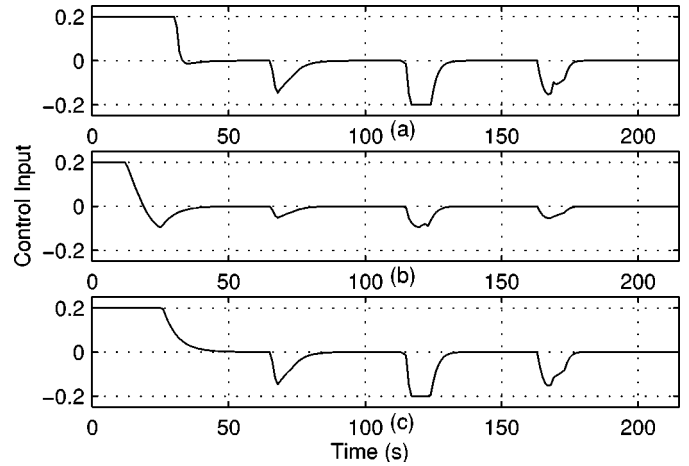

Fig. 16. Control input.

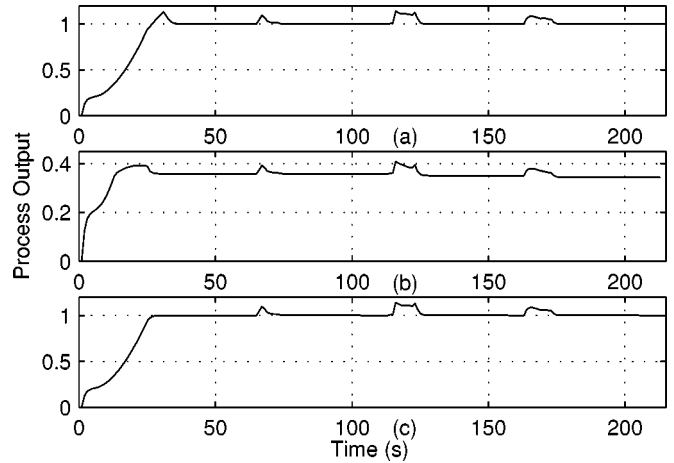

Fig. 17. Process output.

output at the switching times and at the same time ensuring the stability of the whole system.

E. Fifth Step: Accommodation in Presence of "Nonconsecutive" Exogenous Events and an Additive White Noise

The same process is used in the following but with a different disturbing event which is shown in Fig. 18. The purpose of this subsection is to show the interesting properties of the detector and hence the accommodation algorithm in the presence of an additive white noise and when the process is evolving in a randomized operating mode sequence. Whereas, in the last example the process was evolving in an "ordered" sequence, i.e., in an ascending order of operating modes, here, it is evolving in a nonconsecutive order of operating modes. Without loss of generality, the following example shows a "1-2-1-4-3" evolving sequence, where the process starts operating in the first OM and ends up in the third one. One can see that the detector is well detecting the evolution of the process operating modes.

Fig. 19 shows the process output and control input in presence of an additive white noise with 1/1000 variance. Here again, the process output is well accommodated to the exogenous events e . An interesting AWBT compensators set was found to be $k_i = 1$,

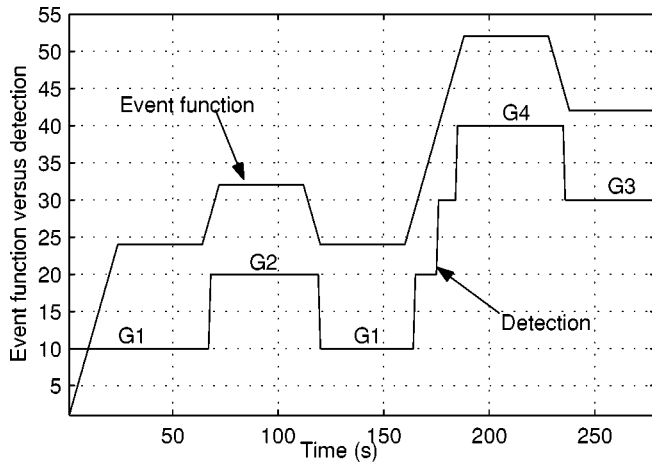

Fig. 18. Random event function and detected operating modes.

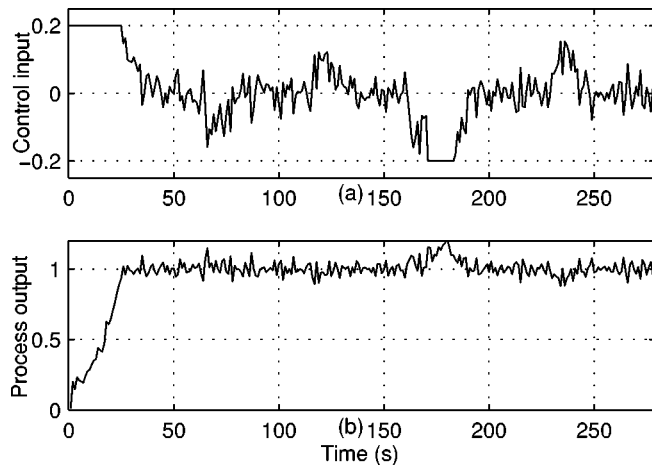

Fig. 19. (a) Control input versus (b) process output with $k_i = 1$, $Q_1(s) = s + 0.2$, $Q_2(s) = s + 0.25$, $Q_3(s) = s + 0.5$, $Q_4(s) = s + 1$.

$$Q_1(s) = s + 0.2, Q_2(s) = s + 0.25, Q_3(s) = s + 0.5, Q_4(s) = s + 1.$$

VII. CONCLUSION

Switching among a set of controllers to ensure stability and robustness with respect to plant environment abrupt changes and disturbances, is very developed in control systems literature [1]–[10]. Control law based on multicontroller structure is very simple to design. This idea was introduced to achieve a fast and accurate response in comparison with other adaptive techniques [4], [9].

The OMDA structure is proposed to complete the conventional control closed-loop to detect the different operating modes of the process, and to accommodate the control law by selecting the right controller. The detection function is achieved by calculating a set of residues generated by an adequate design of the operating modes observers.

We have set up the design steps involved in constructing the MC structure which are summarized as follows:

- 1) the modeling of the process operating modes;
- 2) the appropriate design of the controllers corresponding to each operating mode;

- 3) the stability analysis of the switched system to arbitrary switching sequences;
- 4) the switching performances improvement by AWBT design;
- 5) the validation of the accommodation performances in presence of “nonconsecutive” exogenous events and an additive white noise.

Simulation results, reported in this paper, have shown very good performances of the OMDA structure. When a possible loss of performances is allowed, it will be of great interest to study the control restructuration when several objectives may be tracked.

REFERENCES

- [1] R. Isermann and P. Ballé, “Trends in the application of model based fault detection and diagnosis of technical processes,” in *Proc. 13th IFAC World Congr.*, San Francisco, CA, June 30, 1996.
- [2] J. L. Musgrave, T. H. Guo, E. Wong, and A. Duyar, “Real-time accommodation of actuator faults on a reusable rocket engine,” *IEEE Trans. Contr. Syst. Technol.*, vol. 5, pp. 100–109, Jan. 1997.
- [3] H. E. Rauch, “Autonomous control reconfiguration,” *IEEE Contr. Syst.*, vol. 15, pp. 37–48, Dec. 1995.
- [4] A. S. Morse, “Supervisory control of families of linear set-point controllers, Part I: exact matching,” *IEEE Trans. Automat. Contr.*, vol. 41, pp. 1413–1431, Oct. 1996.
- [5] —, “Supervisory control of families of linear set-point controllers — Part 2 : robustness,” *IEEE Trans. Automat. Contr.*, vol. 42, pp. 1500–1515, Nov. 1997.
- [6] —, “A bound for the disturbance — to — tracking — error gain of a supervised set point control system,” in *Perspective in Control Theory and Applications*, D. Norm-Cyrot, Ed. New York: Springer-Verlag, 1998, pp. 23–41.
- [7] J. P. Hespanha and A. S. Morse, “Supervisory control of integral-input-to-state stabilizing controllers,” in *Proc. Euro. Contr. Conf.*, Karlsruhe, Germany, Aug. 31, 1999.
- [8] A. S. Morse, “Control using logic-based switching,” in *Trends in Control A European Perspective*, A. Isidori, Ed. New York: Springer-Verlag, 1995, pp. 69–113.
- [9] K. S. Narendra and J. Balakrishnan, “Adaptive control using multiple models,” *IEEE Trans. Automat. Contr.*, vol. 42, pp. 171–187, Feb. 1997.
- [10] —, “Improving transient response of adaptive control systems using multiple models and switching,” *IEEE Trans. Automat. Contr.*, vol. 39, pp. 1861–1866, Sept. 1994.
- [11] K. Aström, *Computer Controlled Systems*. Englewood Cliffs, NJ: Prentice-Hall, 1994.
- [12] R. Hanus, M. Kinnnaert, and J. L. Henrotte, “Conditioning technique, a general anti-windup and bumpless transfer method,” *Automatica*, vol. 23, no. 6, pp. 729–739, 1987.
- [13] C. Edwards and I. Postlethwaite, “Anti-windup and bumpless-transfer schemes,” *Automatica*, vol. 34, no. 2, pp. 199–210, 1998.
- [14] M. V. Kothare and M. Morari, “Multiplier theory for stability of anti-windup control systems,” 2,96-08, IFA Tech. Rep., 1996.
- [15] M. Morari, “Some control problems in the process industries,” in *Essays in Control Perspectives in Theory and its Applications*, H. L. Trentelman, J. C. Willems, and Birkhauser, Eds. Cambridge, MA, 1993, pp. 55–77.
- [16] K. Zhou and J. C. Doyle, *Essentials of Robust Control*. Englewood Cliffs, NJ: Prentice-Hall, 1998.
- [17] D. Liberzon and A. S. Morse, “Basic problems in stability and design of switched systems,” *IEEE Contr. Syst.*, vol. 19, pp. 59–70, May 1999.
- [18] S. Sastry and M. Bodson, *Adaptive Control Stability, Convergence and Robustness*. Englewood Cliffs, NJ: Prentice-Hall, 1989.
- [19] P. A. Ioannou and J. Sun, *Robust Adaptive Control*. Englewood Cliffs, NJ: Prentice-Hall, 1996.
- [20] M. Morari and E. Zafiriou, *Robust Process Control*. Englewood Cliffs, NJ: Prentice-Hall, 1996.
- [21] K. S. Narendra and J. Balakrishnan, “A common Lyapunov function for stable LTI systems with commuting A -matrices,” *IEEE Trans. Automat. Contr.*, vol. 39, pp. 2469–2471, 1994.
- [22] R. N. Shorten and K. S. Narendra, “A sufficient condition for the existence of common Lyapunov function for two second-order linear systems,” in *Proc. 36th Conf. Decision Contr.*, 1997, pp. 3521–3522.

- [23] P. Peleties and R. A. DeCarlo, "Asymptotic stability of m-switched systems using Lyapunov-like functions," in *Proc. Amer. Contr. Conf.*, 1991, pp. 1679–1684.
- [24] M. S. Branicky, "Studies in hybrid systems: Modeling, analysis, and control," Ph.D dissertation, Mass. Inst. Technol., Cambridge, LIDS, 1995.
- [25] M. D. Lemmon, K. X. He, and I. Markovskiy, "Supervisory hybrid systems," *IEEE Contr. Syst.*, vol. 19, pp. 42–55, Mar. 1999.
- [26] P. Gahinet, P. Apkarian, and M. Chilali, "Affine parameter-dependent Lyapunov functions for real parametric uncertainty," in *Proc. Conf. Decision Contr.*, 1994, pp. 2026–2031.
- [27] W. J. Vetter, "Matrix calculus operations and Taylor expansions," *SIAM Rev.*, vol. 15, no. 2, pp. 352–369, 1973.



Philippe Charbonnaud was born in France in 1962. He received the Ph.D. degree in automatic control from the University Bordeaux I, Bordeaux, France, in 1991.

Since 1992, he has been a Researcher in the Department Production Automatisée of the Laboratoire Génie de Production, Ecole Nationale d'Ingénieurs, Tarbes, France. He is also Assistant Professor of the Ecole Nationale d'Ingénieurs, France, where he gives lectures on digital signal processing, supervision, diagnosis and monitoring, and hybrid dynamical systems.

His current research interests include modeling, analysis, and synthesis of real-time decision systems.

Dr. Charbonnaud is a member of the Club EEA.



Frédéric Rotella (A'96–M'95–SM'00) was born in France in 1957. In 1981, he received the Diploma in engineering from the Institut Industriel du Nord, Lille, France. He received the Ph.D. and Doctorat d'Etat degrees from the University of Science and Technology, Lille-Flandres-Artois, France, in 1983 and 1987, respectively.

From 1981 to 1994, he was with the Laboratoire d'Automatique et d'Informatique Industrielle, Lille, where his research interests focused on modelization and control of nonlinear systems. During this period,

he served at the Ecole Centrale de Lille (ex. Institut Industriel du Nord) as Assistant Professor in Automatic Control. In 1994, he joined the Ecole Nationale d'Ingénieurs, (ENIT), Tarbes, France, as Professor of Automatic Control. Since 1994, he has been in charge of the Department of Electrical Engineering at ENIT. Currently, he is with the Laboratoire de Génie de Production of the ENIT, where he manages the Control Systems Research Group. His research interests include identification and control of nonlinear systems.

Dr. Rotella is coauthor of six textbooks on automatic control and mathematics. *Analyse et régulation des processus industriels*, (Paris, France: Technip, 1993) tome 1: *régulation continue*, tome 2: *régulation numérique*, *Modélisation et identification des processus* (1992), tomes 1 et 2, *Commande et optimisation des processus* (1990), and *Théorie et pratique du calcul matriciel* (1995).

Dr. Rotella is a Member of the Club EEA.



Smain Médar was born in Algiers, Algeria, in 1974. He received the D. Eng. degree from the National Institute of Electricity and Electronics, Boumerdès, Algeria, in 1997 and the DEA degree in control systems from the University of Paul Sabatier, Toulouse, France, in 1999.

He is currently pursuing the Ph.D. degree at the Laboratoire de Génie de Production of the National Engineering School, Tarbes, France.

His research interests include switching control, supervision, fault detection and isolation, and control

reconfiguration.