



**HAL**  
open science

# Effects of Hydraulic Loading History on Suffusion Susceptibility of Cohesionless Soils

Abdul Rochim, Didier Marot, Luc Sibille, Van Thao Le

► **To cite this version:**

Abdul Rochim, Didier Marot, Luc Sibille, Van Thao Le. Effects of Hydraulic Loading History on Suffusion Susceptibility of Cohesionless Soils. *Journal of Geotechnical and Geoenvironmental Engineering*, 2017, 143 (7), pp.04017025. 10.1061/(ASCE)GT.1943-5606.0001673 . hal-03600111

**HAL Id: hal-03600111**

**<https://hal.science/hal-03600111>**

Submitted on 7 Mar 2022

**HAL** is a multi-disciplinary open access archive for the deposit and dissemination of scientific research documents, whether they are published or not. The documents may come from teaching and research institutions in France or abroad, or from public or private research centers.

L'archive ouverte pluridisciplinaire **HAL**, est destinée au dépôt et à la diffusion de documents scientifiques de niveau recherche, publiés ou non, émanant des établissements d'enseignement et de recherche français ou étrangers, des laboratoires publics ou privés.



35

## 36 **Abstract**

37 Suffusion is a selective erosion of fine particles under the effect of seepage  
38 flow within the matrix of coarser particles. This complex phenomenon appears as a  
39 combination of three processes: detachment, transport and possible filtration of  
40 finer fraction. It can induce a change in particle size distribution, porosity and  
41 hydraulic conductivity of the material. With the objective to characterize the  
42 suffusion susceptibility, downward seepage flow tests were conducted. Four  
43 different cohesionless soils were tested under hydraulic gradient controlled  
44 conditions or under flow rate controlled conditions. This study shows the significant  
45 effect of hydraulic loading history on the value of critical hydraulic gradient.  
46 Moreover, method characterizing the erosion susceptibility based on rate of erosion  
47 does not lead to a unique characterization of suffusion process for different types  
48 of hydraulic loading. The new analysis is based on energy expended by the  
49 seepage flow and the cumulative eroded dry mass. The results demonstrate that  
50 this approach is more effective to characterize suffusion susceptibility for  
51 cohesionless soils.

52 **Key words** : Dam safety – Cohesionless soils – Erodimeter – Suffusion – Water  
53 seepage energy

54

## 55 INTRODUCTION

56 Hydraulic earth structures can suffer from instabilities induced by internal erosion  
57 processes. Fry et al. (2012) indicated that overtopping and internal erosion are the two  
58 main causes of failure of embankment dams and dikes.

59 Fell and Fry (2013) distinguished four forms of internal erosion: concentrated leak  
60 erosion, backward erosion, contact erosion and suffusion. This paper deals with  
61 suffusion which can induce a change in particle size distribution, porosity and hydraulic  
62 conductivity of the soil. Moreover, although the suffusion development may be difficult  
63 to detect in situ, it has to be considered with attention as it can evolve towards a  
64 second phase of erosion, characterized by a blowout and an extensive erosion of fine  
65 particles, inducing both a large settlement of specimen and a relatively strong increase  
66 in the hydraulic conductivity (Sibille et al., 2015a). Thus to ensure the safety  
67 assessment of hydraulic earth structures, the characterization of suffusion  
68 susceptibility is required. Nevertheless, it was only recently that a method for  
69 classifying the suffusion susceptibility of soils based on experimental results was  
70 proposed (Marot et al., 2016).

71 Soils that are likely to suffer from suffusion, have a grain-size distribution curve either  
72 discontinuous or upwardly concave (Fell and Fry, 2007), and even with a slight  
73 variation of the initial gradation, an abrupt transition appears between internally stable  
74 and unstable states (Skempton and Brogan, 1994).

75 It is worth stressing that in comparison with time scale in laboratory, in-situ the  
76 hydraulic loading can be applied on soils, constituting the hydraulic earth structures  
77 and its foundations, during a very long duration. The upstream head applied on an  
78 earth structure can increase by several cm per hour in case of flood, a rapid reservoir

79 filling or heavy rain seasons, but only a few mm per day under normal flow conditions.  
80 The corresponding values of increment of hydraulic gradient depend on the earth  
81 structure's design and also on the studied position in this structure. Moreover the  
82 seepage flow depends on aforementioned parameters but also on hydraulic  
83 conductivity of soils. Thus to optimize the test duration and to take into account this  
84 large range of possible hydraulic loadings, researchers performed internal erosion  
85 tests under various hydraulic loading conditions. Suffusion tests described in literature,  
86 were mostly performed under multi-staged hydraulic gradient conditions in upward  
87 direction with hydraulic gradient ranging from 0.02 to 1.4 (Skempton and Brogan,  
88 1994; Ke and Takahashi, 2012; Indraratna et al., 2015) or in downward direction with  
89 the hydraulic gradient range from 0.15 to 9.4 (Moffat and Fannin, 2006; Chang and  
90 Zhang, 2011). But other tests were also realized under single staged hydraulic  
91 gradient with values between 5 and 140 (Bendahmane et al., 2008; Wan and Fell,  
92 2008; Nguyen et al., 2012). Nguyen et al. (2012) and Ke and Takahashi (2014, 2015)  
93 performed suffusion tests under flow rate controlled conditions with a range of  
94 discharge per unit cross section from  $10^{-3}$  to  $0.13 \text{ cm.s}^{-1}$ . Kenney and Lau (1985)  
95 described their test conditions as severe because the values of discharge per unit  
96 cross section were larger than those usually encountered in engineering practice with  
97 similarly graded materials ( $0.37$  to  $1.67 \text{ cm.s}^{-1}$ ). However, facing this variability of  
98 hydraulic loading conditions, no clear influence on suffusion susceptibility of hydraulic  
99 loading history could be drawn. Even with the same type of hydraulic loading (i.e.  
100 hydraulic gradient controlled conditions) Luo et al. (2013) showed that for the tested  
101 soil, the suffusion susceptibility seems to be influenced by the increment of hydraulic  
102 gradient and by the duration of each stage. This soil appears more resistant when

103 facing suffusion process in the “short-term experiment” (multi-staged hydraulic  
104 gradient with increment ranging from 0.06 to 0.54 and with stage duration from 10 to  
105 30 min) than that in the “long-term large hydraulic head experiment” (large single  
106 staged hydraulic gradient remained constant up to eight days).

107 The main objective of this paper is to investigate (1) the suffusion susceptibility of gap  
108 and widely graded soils showing a slight variation of the initial gradation, and (2) the  
109 hydraulic loading history effects on this susceptibility. A series of downward seepage  
110 flow tests was realized under hydraulic gradient and flow rate controlled conditions.  
111 Moreover different increments of hydraulic gradient, different flow rates and different  
112 test durations were used. The results are discussed in terms of gradation of suffusion  
113 susceptibility. Hydraulic loading history effects on the value of critical hydraulic  
114 gradient and on the rate of erosion are studied. Finally the suffusion susceptibility is  
115 also assessed by a new energy based method and recommendations for suffusion  
116 tests are given.

## 117 **CONTROL PARAMETERS FOR LIKELIHOOD OF SUFFUSION**

118 Three criteria are distinguished for suffusion to occur (Fell and Fry, 2013): (i) the size  
119 of the fine soil particles must be smaller than the size of the constrictions between the  
120 coarser particles, which form the basic skeleton of the soil. (ii) The volume of fine soil  
121 particles must be less than the volume of voids between coarser particles, and (iii) the  
122 velocity of flow through the soil matrix must be high enough to move the loose fine soil  
123 particles through the pore. The first two criteria are associated with the fabric of  
124 granular soils, which mainly depends on the grain size distribution. Thus to assess the  
125 potential susceptibility of a soil to suffusion, several researchers proposed methods  
126 that are only based on the study of soil gradation (US Army Corps of Engineers, 1953;

127 Kenney and Lau, 1985; Li and Fannin, 2008; Chang and Zhang, 2013 among others).  
128 However, the modification of the effective stress (Moffat and Fannin, 2006;  
129 Bendahmane et al. 2008; Chang and Zhang, 2011) and the relative density (Indraratna  
130 et al., 2015) can also influence the suffusion susceptibility. Finally, for a given grain  
131 size distribution and a given value of effective stress, angularity of coarse fraction  
132 grains contributes to increase the suffusion resistance (Marot et al., 2012). The third  
133 criterion is related to the action of the fluid phase with respect to seepage loading  
134 required to detach and then to transport the fine particles. Skempton and Brogan  
135 (1994), Ke and Takahashi (2012), Indraratna et al. (2015) proposed to relate the onset  
136 of suffusion with an increase of hydraulic conductivity. Skempton and Brogan  
137 proposed to characterize the corresponding hydraulic loading by the critical hydraulic  
138 gradient. However a fraction of the detached particles can re-settle or be filtered at the  
139 bulk of the porous network (Reddi et al. 2000; Bendahmane et al. 2008; Marot et al.  
140 2009; 2011a; Nguyen et al. 2012; Luo et al., 2013). These processes can eventually  
141 induce local clogging, accompanied by variations of fluid velocity and interstitial  
142 pressure. Therefore, variations of both seepage flow and pressure gradient have to be  
143 taken into account to evaluate the hydraulic loading. By considering these both  
144 parameters, Reddi et al. (2000) assumed that hydraulic loading can be represented  
145 by the viscous shear stress at fluid-solid interface. They expressed this shear stress,  
146  $\tau$ , for a horizontal flow in the porous medium, and it can be reformulated for a vertical  
147 flow by:

$$148 \quad \tau = \left( \frac{\Delta h \gamma_w}{\Delta z} \right) \frac{r}{2} \quad (1)$$

149 where  $\Delta h$  is the drop of hydraulic head between upstream section A and downstream  
150 section B,  $\gamma_w$  is the unit weight of water,  $\Delta z = z_A - z_B$ ,  $z_A$  and  $z_B$  are altitudes of sections  
151 A and B respectively. The equivalent radius,  $r$ , is representing the effects of all pores.  
152 In the case of cohesive soils, Reddi et al. (2000) proposed to estimate the equivalent  
153 radius of pores by:

$$154 \quad r = \sqrt{\frac{8 k \eta}{n \gamma_w}} \quad (2)$$

155 where  $n$  is the porosity,  $k$  is the hydraulic conductivity and  $\eta$  the dynamic viscosity.  
156 Consequently, the hydraulic shear stress along vertical system of capillary tubes can  
157 be expressed by:

$$158 \quad \tau = \left( \frac{\Delta h}{\Delta z} \right) \sqrt{\frac{2 k \eta \gamma_w}{n}} \quad (3)$$

159 For erodibility characterization, a commonly used interpretative method for hole  
160 erosion tests (Wan and Fell, 2004) consists in describing the erosion rate from the  
161 excess shear stress equation, defined by:

$$162 \quad \dot{m} = k_d (\tau - \tau_c) \quad \text{for } \tau \geq \tau_c \quad (4)$$

163 where  $k_d$  is the erosion coefficient, and  $\tau_c$  is the critical hydraulic shear stress. The  
164 considered soil-water interface is the hole surface which is assumed to be cylindrical.  
165 Reddi et al. (2000) considered that the surface of pores is more representative for  
166 suffusion process, thus they expressed the erosion rate of soils per unit pore ( $\dot{m}$ ) by:

$$167 \quad \dot{m} = \frac{m(\Delta t)}{N_p S_p \Delta t} \quad (5)$$



168 where  $m$  is eroded dry mass during the elapsed time  $\Delta t$ ,  $N_p$  the number of average  
169 pores, and  $S_p$  the average pore area. Assuming an equivalent pore radius  $r$  as defined  
170 in Eq.2,  $N_p$  and  $S_p$  can be computed respectively by:

$$171 \quad N_p = \frac{S n}{\pi r^2} \quad (6)$$

$$172 \quad S_p = 2 \pi r L \quad (7)$$

173 where  $S$  is the cross section area of the specimen and  $L$  is the length of the specimen.

174 Another way to consider variations of both seepage velocity and pressure gradient,  
175 consists in expressing the power expended by the seepage flow (Marot et al., 2011b;  
176 Marot et al., 2016). Three assumptions are used: the fluid temperature is assumed  
177 constant, the system is considered as adiabatic and only a steady state is considered.  
178 The energy conservation equation permits to express the total flow power as the  
179 summation of the power transferred from the fluid to the solid particles and the power  
180 dissipated by viscous stresses in the fluid. As the transfer between fluid and solid  
181 appears negligible in suffusion process (Sibille et al., 2015b), the authors suggest to  
182 characterize the fluid loading from the total flow power,  $P_{\text{flow}}$  which is expressed by:

$$183 \quad P_{\text{flow}} = Q \gamma_w \Delta h \quad (8)$$

184 where  $Q$  is the fluid flow rate.

185 Marot at al. (2011b) expressed the erosion resistance index by:

$$186 \quad I_\alpha = -\log \left( \frac{m_{\text{dry}}}{E_{\text{flow}}} \right) \quad (9)$$

187 where  $E_{\text{flow}}$  is the expended energy, computed by time integration of the instantaneous  
188 flow power, and  $m_{\text{dry}}$  is the cumulative eroded dry mass. From this energy based

189 method, six categories of suffusion soil sensibility are proposed: from highly resistant  
190 to highly erodible (Marot et al., 2016).

## 191 **LABORATORY EXPERIMENTS**

### 192 **Main characteristics of testing apparatus**

193 The device is designed to apply downward seepage on fine soil specimens (50 mm in  
194 diameter and heights up to 100 mm) (Fig. 1). The hydraulic gradient of this seepage  
195 is controlled thanks to an injection cell equipped with pressure sensor, and connected  
196 to an air/water interface cylinder. The system to generate seepage flow in flow-rate-  
197 controlled conditions comprises a gear pump connected to a pressure sensor at its  
198 outlet. The fluid passes through the top cap which contains a layer of glass beads to  
199 diffuse the fluid uniformly on the specimen top surface. The funnel-shaped draining  
200 system is connected to an effluent tank by a glass pipe. The effluent tank is equipped  
201 with an overflow outlet (to control the downstream hydraulic head) and a rotating  
202 sampling system containing 8 beakers for the sampling of eroded particles carried with  
203 the effluent. In the case of clay or silt suffusion, a multi-channel optical sensor can be  
204 placed around the glass pipe (Marot et al., 2011a), and thanks to a preliminary  
205 calibration, clay or silt concentration in the effluent can be computed. At the overflow  
206 outlet of the effluent tank, water falls in a beaker which is continuously weighed in  
207 order to determine injected flow rate. The sample is supported by a lower mesh screen  
208 and the mesh screen opening size is selected with the objective to reproduce in-situ  
209 earth structures without filter, as a dike for example.

## 210 **Testing materials**

211 Three gap graded soils and one widely graded soil, composed of sand and gravel  
212 were tested. A laser diffraction particle-size analyser was used to measure the grain  
213 size distribution of these soils (Fig. 2). Tests were performed with demineralised water  
214 and without deflocculation agent. Table 1 summarizes the properties of soils used in  
215 the laboratory tests. These soils were selected in order to obtain internally unstable  
216 soils. Their gradations slightly differ, mainly with respect to the fine content ranging  
217 from 20% to less than 30% (Fig. 2). According to grain size based criteria these soils  
218 are, indeed internally unstable, but close to the stability limits defined by several  
219 methods currently available and detailed hereafter. For all studied soils, the uniformity  
220 coefficient  $C_u$  is around 20 (i.e. the stability boundary proposed by US Army Corps of  
221 Engineers, 1953). Minimum values of Kenney and Lau's (1985) ratio (H/F) are lower  
222 than 1 for all tested soils, thus according to this criterion, they are considered as  
223 internally unstable. As the percentage of fine  $P$  is smaller than 5%, and the gap ratio  
224  $G_r$  is higher than 3, Chang and Zhang's (2013) method assessed widely graded soil R  
225 and gap graded soils A, B, C as internally unstable. However,  $G_r$  value for soils A and  
226 B, is slightly higher than 3, corresponding to the stability boundary proposed by Chang  
227 and Zhang. The method proposed by Indraratna et al. (2015) combines the particle  
228 size distribution and the relative density. In Table 1 values of ratio  $D_{c35}^c/d_{85,SA}^f$  were  
229 computed with the highest value of specimen initial dry density discussed later in this  
230 paper. According to this method, all specimens are considered to be internally  
231 unstable.

## 232 **Specimen preparation and testing program**

233 The specimen preparation phase is divided into three steps: production, installation  
234 and then saturation of the specimen. The repeatability of the production is achieved  
235 by the following procedure. First sand grains and gravel are mixed with a moisture  
236 content of 7.8%. To prepare these specimens, a single layer semi-static compaction  
237 technique is used, until the initial fixed dry density is reached with 50 mm specimen  
238 height. Two values of initial dry density are targeted: 90% and 97% of the optimum  
239 Proctor density. As recommended by Kenney and Lau (1985), in order to reduce  
240 preferential flow, each specimen is wrapped in a latex sleeve, then put inside a metal  
241 mould. The downstream filter is composed of a 4 mm pore opening grid. Such a pore  
242 opening allows the migration of all sand particles as in the case of earth structures  
243 without any filter. The saturation phase begins with an upward injection of carbon  
244 dioxide during 5 minutes to improve dissolution of gases into water, afterwards  
245 demineralized water is injected under low hydraulic gradient. The saturation process  
246 takes twelve hours until water trickles over the top cap. With this preparation technique  
247 (Nguyen, 2012), the final saturation ratio was determined by measuring density and  
248 water content and reached 95%. Finally, the specimen is subjected to a downward  
249 flow, using demineralized water and three kinds of hydraulic loading. The choice of  
250 these hydraulic loading programs constitutes a compromise between hydraulic  
251 loadings representative of real hydraulic conditions in the field, and the possibility to  
252 characterize the sensibility of a soil to suffusion in a couple of hours. Test duration is  
253 indeed decisive from an engineering point of view, in particular during an earth  
254 structure construction. Figure 3 shows the time evolution of the applied hydraulic  
255 gradients. Multi-staged hydraulic gradients represent different increases of hydraulic

256 loading which are more or less severe. First multi-staged hydraulic gradient condition  
257 (named a) consists of increasing the hydraulic gradient by steps of 0.1 until 2, then by  
258 steps of 0.5 between 2 and 4 and by steps of 1 beyond. For the second kind of  
259 hydraulic loading (b), hydraulic gradient increment is directly equal to 1. For both  
260 hydraulic loadings, each stage of hydraulic gradient is kept constant during 10 min.  
261 For hydraulic loading (k) with hydraulic gradient increment of 0.5, the duration of  
262 hydraulic gradient stage is 12 hours. Hydraulic loading (c) represents a constant  
263 hydraulic gradient of 4 in order to represent the constant hydraulic head occurring for  
264 instance in the cases of large reservoirs or canals during normal flow conditions. For  
265 this type of hydraulic loading the hydraulic gradient is voluntarily chosen quite high to  
266 try to force the occurrence of suffusion (this point is based on the a priori assumption,  
267 but not always verified a posteriori, that the higher the hydraulic gradient is the more  
268 suffusion is prone to occurring). Finally with the objective to recreate the same  
269 hydraulic loading condition as used by Kenney and Lau (1985), Nguyen et al. (2012)  
270 and Ke and Takahashi (2014, 2015) in their suffusion tests, two constant flow rates  
271 are used ( $q_1=1.247 \text{ ml.min}^{-1}$  and  $q_2=1.641 \text{ ml.min}^{-1}$ , corresponding value of discharge  
272 per unit cross section  $10^{-3} \text{ cm.s}^{-1}$  and  $1.4 \cdot 10^{-3} \text{ cm.s}^{-1}$  respectively).

273 With the objective to improve the readability, the first letter of each test name is related  
274 to the gradation (Fig. 2), the last letter indicates the type of hydraulic loading type and  
275 the number details the initial relative density. Table 2 indicates the initial dry density of  
276 sixteen tested specimens, the values of applied hydraulic gradient or injected flow rate  
277 and the duration for each test.

278 The repeatability of tests was verified by performing 2 tests under identical conditions:  
279 A-a and A-a\_rep.

## 280 **RESULTS AND DISCUSSION**

### 281 **Hydraulic behavior of tested specimens**

282 The hydraulic conductivity of tested specimens are shown on Fig. 4 and Fig. 5 in the  
283 case of hydraulic loadings (a) and (b). For these types of hydraulic loadings, the  
284 hydraulic conductivity first decreases with a kinetic depending on the hydraulic loading  
285 type and also on the relative density. In the case of hydraulic loading (b), the duration  
286 of this first decreasing step is from 10 min (tests C-b, B97-b, R90-b) to 20 min (tests  
287 A-b, R97-b). Whereas under hydraulic loading (a), the hydraulic conductivity  
288 decreases for a much longer time (50 min for test R90-a; 80 min for test B90-a;  
289 120 min for tests A-a, A-a\_rep, C-a and even 150 min for B97-a). For a given gradation  
290 and a given hydraulic loading, this decreasing phase is longer for a denser specimen  
291 (for example: R90-b in comparison with R97-b; and B90-a in comparison with B97-a).  
292 The second phase of hydraulic conductivity evolution is characterized by a rapid  
293 increase by a factor between 4 (test A-b) and 20 (test A-a\_rep). Finally the hydraulic  
294 conductivity reaches a constant value which is pointed out by black spots on Fig. 4  
295 and Fig. 5. The repeatability of the seepage test can be validated by comparing the  
296 initial and final values of hydraulic conductivity for tests A-a and A-a\_rep which are in  
297 good agreement. However, irregular deviation of hydraulic conductivity appears in the  
298 middle of test. Only a few data exist in literature concerning suffusion test repeatability.  
299 Ke and Takahashi (2014) observed same hydraulic conductivity deviation which they  
300 attributed to the difference in homogeneity among the reconstituted soil specimens. In

301 addition the complexity of suffusion process, highlighted by the identification of  
302 predominant processes discussed in the following section may explain the deviation  
303 of hydraulic conductivity evolution during the suffusion development.

304 Figure 6 shows the slow and monotonous decrease with time of the hydraulic  
305 conductivity which is measured during single staged hydraulic gradient tests (tests A-  
306 c, B90-c, and test B90-k during the first hydraulic stage with a duration of 720 min) or  
307 under flow rate controlled tests (tests B90-q2 and R97-q1). Thus some variations in  
308 the hydraulic loading appear necessary in order to initiate the second increasing phase  
309 of the hydraulic conductivity, even after several hours of seepage as during test B90-  
310 k (Fig. 3).

### 311 **Identification of predominant processes**

312 The comparison of time evolution of hydraulic conductivity with time evolution of  
313 erosion rate and measurement of post suffusion-test soil grading constitute a way to  
314 improve the understanding of suffusion process.

315 Figure 7 shows the erosion rate per unit pore area (computed by Eq. 5) for tests B90-  
316 a, c, q2. The erosion rate is depending on hydraulic conductivity and porosity, which  
317 evolve in time. For the computation of porosity during time, the specimen height is  
318 assumed constant and the eroded mass measurement is taken into account.

319 The decrease of hydraulic conductivity is systematically accompanied by a decrease  
320 of erosion rate, which suggests that some detached particles can be filtered within the  
321 soil itself. This filtration may induce a clogging of several pores followed by a decrease  
322 of the hydraulic conductivity. Under multi staged hydraulic gradient conditions, a rough

323 increase of the erosion rate occurs simultaneously with the increase of the hydraulic  
324 conductivity. These simultaneous increases confirm that a clogging firstly restricting  
325 the water flow can be blown away by a sudden increase of the hydraulic loading. Thus  
326 the predominant process during this second phase seems to be the detachment and  
327 transport of solid particles. Finally hydraulic conductivity tends to stabilize while the  
328 erosion rate decreases. This third phase could be explained by the presence of  
329 preferential flows created by the erosion process leading to a steady state.

330 At the end of suffusion tests A-a and B90-a, specimens were divided in two parts  
331 named upstream and downstream parts and their grain size distributions were  
332 measured. Figures 8(a) and 8(b) show the initial gradation and the gradation of  
333 downstream and upstream parts of soils A and B respectively. For both specimens, it  
334 can be noted that the loss of fine particles is higher in the upstream part. This result is  
335 in agreement with results of Ke and Takahashi (2012). The transport of detached  
336 particles from upstream to downstream parts can partly offset the loss of particles in  
337 the downstream part. Moreover in downstream part of specimen A, the final  
338 percentage of fine exceeds the initial percentage, which confirms the process of  
339 filtration. In the upstream part, the percentage of fine particles corresponds only to half  
340 of the initial fine percentage of specimen A, whereas it represents about 80% of the  
341 initial fine percentage in specimen B. Thus filtration process appears to be raised by  
342 the amount of detached particles which come from the upstream part. Furthermore  
343 specimens A and B90 have the same initial density (see Table 2), but different  
344 percentage of fine. For a given density, a lower fine content is accompanied with a  
345 larger amount of coarse particles and a smaller constriction size within the porous  
346 network, which facilitates the filtration process.



347 It is worth noting that for a given soil, a multi staged hydraulic loading with higher  
348 increments induces a higher final value of hydraulic conductivity. Final hydraulic  
349 conductivity is higher under hydraulic loading (b) than under hydraulic loading (a)  
350 (tests A-a, A-a\_rep, A-b, R90-a and R90-b on Fig. 4 and tests B97-a, B97-b, C-a and  
351 C-b on Fig. 5) and also higher than in the case of hydraulic loading (k) (test B90-a on  
352 Fig. 5 and test B90-k on Fig. 6). Thus an application of higher increments may limit the  
353 filtration process.

354 The loading by multi staged hydraulic gradient which was applied for test B90-a  
355 permits to obtain the three aforementioned phases and the steady state which follows  
356 an extensive erosion is reached for  $i=4$  (Fig. 5). This same value of hydraulic gradient  
357  $i=4$  was continuously applied during test B90-c, but this hydraulic loading leads only  
358 to the predominant process of filtration (Fig. 6). Therefore, the history for reaching that  
359 final hydraulic gradient has a significant influence on the hydraulic behavior of  
360 specimens and on the development of suffusion.

361 Finally, the complex erosion phenomenon of suffusion appears as a combination of  
362 three processes: detachment, transport and possible filtration of finer fraction. This  
363 combination results in strong heterogeneities in soil grading and large evolutions of  
364 hydraulic conductivity and erosion rate. The development of these coupled processes  
365 depends on the grain size distribution, the density but also the evolution of hydraulic  
366 loading which in turns is influenced by the suffusion development.

### 367 **Characterization of suffusion onset**

368 Figure 9 shows the flow velocity versus the hydraulic gradient for tests on soil B. With  
369 the objective to determine with accuracy the onset of suffusion, the relative evolution

370 of hydraulic conductivity is computed and the onset of suffusion is systematically  
371 defined by the first relative increase of 10%. First, it can be observed that under single  
372 staged hydraulic gradient conditions and under flow rate controlled conditions (tests  
373 B90-c and B90-q2 respectively, on Fig. 9), the determination with such approach of  
374 the suffusion onset is not possible. For tests realized under multi staged hydraulic  
375 gradient conditions, the values of the critical hydraulic gradient are indicated in Table  
376 3. The critical hydraulic gradient appears higher with the hydraulic loading (b) than  
377 with the hydraulic loading (a) for soils A, B97 and R90. In consequence, for a given  
378 soil the critical hydraulic gradient seems to depend on the history of hydraulic loading.  
379 This influence of hydraulic loading history was also observed by Luo et al. (2013) who  
380 compared the results obtained with two test durations. They notably concluded that a  
381 long-term large hydraulic head reduces the hydraulic gradient needed for major  
382 suffusion development.

383 For both hydraulic loadings, the comparison of critical hydraulic gradient obtained for  
384 tested soils shows that soil A requires a larger hydraulic gradient to initiate the  
385 suffusion process. The initial gradation of this soil has a lower fine content (20%) in  
386 comparison with soil B (initial fine content of 25%), and soils C and R (initial fine  
387 content about 29%). These results are in good agreement with the test results  
388 presented by Ke and Takahashi (2012) on cohesionless soils with three different initial  
389 fine contents from 16.7% to 25%.

### 390 **Characterization of suffusion development**

391 As for other internal erosion processes, a first interpretative method for suffusion tests  
392 could consist in representing the erosion rate as a function of the hydraulic shear  
393 stress. As for erosion rate computation (Eq. 5), the computation of hydraulic shear

394 stress (Eq. 3) takes into account the time evolutions of hydraulic conductivity and  
395 porosity. Value of porosity corresponds to an average value which characterizes the  
396 whole specimen, without distinction between upstream and downstream parts.  
397 However, thanks to the hydraulic conductivity evolutions, Eq. 3 takes partially into  
398 account the development of specimen heterogeneities during experiment time.  
399 Figure 10 shows the erosion rate versus the hydraulic shear stress for tests on soil A.  
400 Thanks to the aforementioned identification of suffusion onset, based on hydraulic  
401 conductivity increase, it is possible to define the initiation of suffusion development  
402 phase. The end of this phase is assumed to be reached at the stabilization of the  
403 hydraulic conductivity. Now by considering only tests realized under hydraulic loadings  
404 (a) and (b), a linear approximation representing Eq. 4 is computed. Figure 10 shows  
405 the corresponding equation with values of  $k_d$ ,  $\tau_c$  and correlation coefficient  $R^2$  for tests  
406 A-a, A-a\_rep and A-b. The erosion rate versus the hydraulic shear stress are basically  
407 close for tests A-a, A-a\_rep which might imply the good repeatability of the suffusion  
408 test. Table 4 details the values of erosion coefficient and correlation coefficient for  
409 tested specimens under multi staged hydraulic gradient conditions. First, it is worth  
410 noting the weak values of correlation coefficient (between 0.01 for test B97-a, and 0.77  
411 for test A-a) highlighting the difficulty to describe the erosion rate from this approach.  
412 These low values of correlation coefficient cannot be attributed to the imprecision of  
413 the determination of erosion rate and hydraulic shear stress which can be valued at  
414  $\pm 3 \cdot 10^{-11} \text{ kg}\cdot\text{s}^{-1}\cdot\text{m}^{-2}$  and  $\pm 0.02 \text{ Pa}$  respectively. Moreover, the erosion coefficient  
415 values obtained with hydraulic loading (b) are systematically higher (with a factor  
416 between 1.4 and 3.3) than in the case of hydraulic loading (a). Thus the  
417 characterization of suffusion susceptibility based on this interpretative method

418 depends on the history of hydraulic loading. Moreover, in the case of flow rate  
419 controlled condition tests or single staged hydraulic gradient tests (A-c on Fig. 10) and  
420 even under hydraulic loading ( $k$ ), a single value of hydraulic shear stress can be  
421 associated with a large range of erosion rate. In consequence, it is not possible to  
422 describe with accuracy the erosion rate by such interpretative method.

423 With the objective to take into account the history of hydraulic loading, the energy  
424 expended by the seepage flow  $E_{\text{flow}}$  is determined by the time integration of total flow  
425 power,  $P_{\text{flow}}$  (computed by Eq. 8) for the test duration. Figures 11 to 14 show the  
426 cumulative loss dry mass,  $m_{\text{dry}}$ , versus the cumulative expended energy for all kinds  
427 of hydraulic loading.

428 For characterizing the erosion susceptibility, the erosion resistance index is computed  
429 at the end of the test which is determined by the stabilization of the hydraulic  
430 conductivity, pointed out by black spots on Figures 11 to 14. If the test is stopped  
431 before the stabilization of the hydraulic conductivity, the erosion resistance index is  
432 computed with the last realized measurements. Table 5 indicates the values of erosion  
433 resistance index for all realized tests.

434 It is worth noting that when the stabilization of the hydraulic conductivity is reached,  
435 the corresponding value of erosion resistance index, written in bold in Table 5, can be  
436 determined with accuracy for the different hydraulic loadings.  $I_{\alpha}$  is between 3.40 and  
437 3.64 for tests B97 (i.e. this soil is moderately erodible according to the suffusion  
438 susceptibility classification proposed by Marot et al., 2016), between 3.03 and 3.09 for  
439 tests C (moderately erodible), between 2.93 and 2.98 for tests B90 (erodible), and  $I_{\alpha}$   
440 is equal to 2.94 for tests R90 (erodible). On the contrary, if the test is stopped before  
441 the stabilization of the hydraulic conductivity, the interpretation can lead to a higher

442 value of erosion resistance index and thus an overestimation of the soil resistance.  
443 This shows the necessity to perform suffusion tests by increasing the applied hydraulic  
444 gradient in order to have the possibility to follow the development of all possible  
445 processes and to continue the test as far as hydraulic conductivity becomes constant.  
446 The comparison of erosion resistance index obtained for tests B90 and B97 on one  
447 hand, and for tests R90 and R97 on the other hand permits to highlight the positive  
448 influence of density on soil resistance face suffusion process (both soils are erodible  
449 with initial dry density of  $17.39\text{kN/m}^3$  and moderately erodible with initial dry density of  
450  $18.74\text{kN/m}^3$ ). These results are in good agreement with the results obtained by  
451 Indraratna et al. (2015) who showed that the increase of relative density permits to  
452 transform unstable specimens into stable ones. By considering tests characterized by  
453 a constant final hydraulic conductivity, it can also be noted that for soils B, C and R  
454 the erosion resistance index is between 2.93 and 3.64, whereas it reaches 4.65 for  
455 test A-b (corresponding suffusion susceptibility classification: moderately resistant).  
456 Thus soil A which contains less fine particles (initial fine content: 20%) appears more  
457 resistant than soils B (initial fine content: 25%), C and R (initial fine content about  
458 29%). Thanks to the aforementioned interpretation of post-test grading, it is possible  
459 to conclude that the higher resistance of soil A is mainly due to the raise of filtration in  
460 specimen downstream part.  
461 Finally even if tested soils were unstable according to grain size distribution based  
462 criteria, the suffusion susceptibility classification for tested specimens is between  
463 erodible (B90-a, R90-a and R90-b) and moderately resistant (A).

## 464 **Recommendations for testing**

465 According to the aforementioned results, several recommendations can be drawn to  
466 perform suffusion tests.

467 1. Even if grain size distribution based criteria lead to internally unstable state for  
468 all studied soils, a gradation of soil suffusion susceptibility can be obtained  
469 according to slight variations of initial soil grading and density. Thus suffusion  
470 tests have to be performed.

471 2. Suffusion is the result of the combination of three processes: detachment,  
472 transport and filtration, which in particular depend on history of hydraulic  
473 loading. With the objective to follow the development of all possible  
474 combinations, tests must be realized by increasing the applied hydraulic  
475 gradient and it should be carried on until the stabilization of the hydraulic  
476 conductivity.

477 3. The hydraulic loading on one hand, and the induced erosion on the other hand  
478 must be independently characterized. Thus the energy dissipated by the water  
479 seepage,  $E_{\text{flow}}$  and the cumulative loss dry mass are computed respectively.  
480 Finally at the end of each test, which corresponds to the invariability of the  
481 hydraulic conductivity, the erosion sensibility classification can be evaluated by  
482 the value of the erosion resistance index.

## 483 **CONCLUSION**

484 The characterization of suffusion susceptibility is an important issue for contributing to  
485 the safety assessment of hydraulic earth structures. Tests realized under different  
486 hydraulic loading histories highlight the complexity of suffusion which can be  
487 understood as the process by which the finest soil particles are detached and

488 transported within the porous soil network. Detached particles can be filtered out with  
489 an increasing rate depending on initial gradation, density and evolution of hydraulic  
490 loading.

491 According to the type of hydraulic loading, the predominant process can be either  
492 filtration or erosion. Thus even if a transport of particles is geometrically possible, the  
493 action of hydraulic loading must be studied.

494 The analysis of the suffusion onset can be carried out by determining the critical  
495 hydraulic gradient. However, the realized study shows that the type of hydraulic  
496 loading can substantially modify the value of critical hydraulic gradient at which  
497 suffusion occurs. For other erosion processes, the interpretative method can consist  
498 in describing the erosion rate by using the excess shear stress equation. In the case  
499 of suffusion, the influence of the hydraulic loading history on the erosion coefficient  
500 value and the weak values of correlation coefficient show that such approach does not  
501 permit to determine a unique suffusion susceptibility characterization.

502 A new interpretative method is proposed, linking the cumulative eroded dry mass to  
503 the energy dissipated by the fluid flow. This method is efficient to determine the  
504 suffusion susceptibility for cohesionless material. This study also shows the necessity  
505 to perform suffusion tests by increasing the applied hydraulic gradient and to continue  
506 tests until hydraulic conductivity becomes constant.

## 507 **ACKNOWLEDGEMENT**

508 The authors thank the Indonesian Directorate General of Higher Education (DIKTI),  
509 the Sultan Agung Islamic University Indonesia, the Ministry of Education and Training  
510 of Vietnam and the University of Danang Vietnam, the company IMSRN France, for  
511 providing financial support for this work.

## 512 REFERENCES

- 513 Bendahmane, F., Marot, D. and Alexis, A. (2008). "Experimental parametric Study of  
514 Suffusion and Backward Erosion." *J. Geotech. Geoenviron. Eng.*, 134(1), 57-67.
- 515 Chang, D.S. and Zhang, L.M. (2011). "A Stress-controlled erosion apparatus for  
516 studying internal erosion in soils." *J. ASTM Geotech Test.*, 34(6), 579-589
- 517 Chang, D.S. and Zhang, L.M. (2013). "Extended internal stability criteria for soils under  
518 seepage." *Soils Found.*, 53(4), 569-583.
- 519 Fell, R. and Fry, J.J. (eds) (2007). "Internal erosion of dams and their foundations."  
520 Taylor & Francis, London.
- 521 Fell, R. and Fry, J.J. (2013). "Erosion in geomechanics applied to dams and levees."  
522 1-99. Bonelli S. Editor. ISTE – Wiley.
- 523 Fry, J.J., Vogel, A., Royet, P. and Courivaud, J.R. (2012). "Dam failures by erosion:  
524 lessons from ERINOH data bases." *Proc. 6th Int. Conference on Scour and*  
525 *Erosion (ICSE-6)*, 27-31 August, Paris, France, 273-280.
- 526 Indraratna, B., Israr J. and Rujikiatkamjorn, C. (2015). "Geometrical method for  
527 evaluating the internal instability of granular filters based on constriction size  
528 distribution." *J. Geotech. Geoenviron. Eng.*, 141(10), 04015045.
- 529 Ke, L. and Takahashi, A. (2012). "Strength reduction of cohesionless soil due to  
530 internal erosion induced by one dimensional upward seepage flow." *Soils Found.*,  
531 52(2012), 698–711.
- 532 Ke, L., and Takahashi, A. (2014). "Triaxial erosion test for evaluation of mechanical  
533 consequences of internal erosion." *Geotech. Test. J.*, 37(2), 20130049.
- 534 Ke, L. and Takahashi, A. (2015). "Drained monotonic responses of suffusional  
535 cohesionless soils." *J. Geotech. Geoenviron. Eng.*, 141(8), 04015033.



- 536 Kenney, T.C. and Lau, D. (1985). "Internal stability of granular filters". *Can. Geotech.*  
537 *J.*, 22, 215-225.
- 538 Li, M. and Fannin, J. (2008). "Comparison of two criteria for internal stability of granular  
539 soil." *Can. Geotech. J.*, 45, 1303-1309.
- 540 Luo, Y.L., Qiao, L., Liu, X.X., Zhan, M.L. and Sheng, J.C. (2013). "Hydro-mechanical  
541 experiments on suffusion under long-term large hydraulic heads." *Nat. Hazards*,  
542 65, 1361–1377.
- 543 Marot, D., Bendahmane, F., Rosquoët, F. and Alexis, A. (2009). "Internal flow effects  
544 on isotropic confined sand-clay mixtures." *Soil & Sediment Contamination, an*  
545 *International Journal*, 18(3), 294-306.
- 546 Marot, D., Bendahmane, F. and Konrad, J.M. (2011a). "Multi-channel optical sensor  
547 to quantify particle stability under seepage flow." *Can. Geotech. J.*, 48, 1772-1787.
- 548 Marot, D., Regazzoni, P.L. and Wahl, T. (2011b). "Energy based method for providing  
549 soil surface erodibility rankings." *J. Geotech. Geoenviron. Eng.*, 137(12), 1290-  
550 1294.
- 551 Marot, D., Bendahmane, F. and Nguyen, H.H. (2012). "Influence of angularity of  
552 coarse fraction grains on internal erosion process." *La Houille Blanche*,  
553 *International Water Journal*, 6, 47-53.
- 554 Marot, D., Rochim, A., Nguyen, H.H., Bendahmane, F. and Sibille L. (2016).  
555 "Assessing the susceptibility of gap graded soils to internal erosion: proposition of  
556 a new experimental methodology." *Nat. Hazards*, Volume 83, Issue 1, pp 365-388.
- 557 Moffat, R. and Fannin, J. (2006). "A large permeameter for study of internal stability in  
558 cohesionless soils." *J. ASTM Geotech Test.*, 29(4), 273-279.

- 559 Nguyen, H.H. (2012). "Caractérisation de mécanismes d'érosion interne: confrontation  
560 d'érodimètres et d'approches." Ph.D. Thesis. Université de Nantes.
- 561 Nguyen, H.H., Marot, D. and Bendahmane, F. (2012). "Erodibility characterisation for  
562 suffusion process in cohesive soil by two types of hydraulic loading." *La Houille  
563 Blanche, International Water Journal*, 6, 54-60.
- 564 Reddi, L.N., Lee, I. and Bonala, M.V.S. (2000). "Comparison of internal and surface  
565 erosion using flow pump test on a sand-kaolinite mixture." *J. ASTM Geotech Test.*,  
566 23(1), 116-122.
- 567 Sibille, L., Marot, D. and Sail, Y. (2015a). "A description of internal erosion by suffusion  
568 and induced settlements on cohesionless granular matter." *Acta Geotechnica*, 10,  
569 735-748.
- 570 Sibille, L., Lominé, F., Poullain, P., Sail, Y. and Marot, D. (2015b). "Internal erosion in  
571 granular media: direct numerical simulations and energy interpretation." *Hydrol.  
572 Processes*, 29(9), 2149-2163.
- 573 Skempton, A.W. and Brogan, J.M. (1994). "Experiments on piping in sandy gravels."  
574 *Géotechnique*, 44(3), 440-460.
- 575 U.S. Army Corps of Engineers (1953). "Filter experiments and design criteria."  
576 *Technical Memorandum No. 3-360*, Waterways Experiment Station, Vicksburg.
- 577 Wan, C.F. and Fell, R. (2004). "Investigation of rate of erosion of soils in embankment  
578 dams." *J. Geotech. Geoenviron. Eng.*, 130(4), 373-380.
- 579 Wan, C.F. and Fell, R. (2008). "Assessing the potential of internal instability and  
580 suffusion in embankment dams and their foundations." *J. Geotech. Geoenviron.  
581 Eng* 134(3); 401-407.

582 **FIGURE CAPTIONS**

583 **Fig. 1** Sketch of the experimental bench

584 **Fig. 2** Grain size distribution of tested soils

585 **Fig. 3** Time evolution of multi-staged and single staged hydraulic gradients

586 **Fig. 4** Time evolution of hydraulic conductivity, soils A and R, hydraulic loadings a and

587 b

588 **Fig. 5** Time evolution of hydraulic conductivity, soils B and C, hydraulic loadings a

589 and b. Identification of predominant processes during test B90-a

590 **Fig. 6** Time evolution of hydraulic conductivity, tests A-c, B90-c, B90-q2, B90-k, and

591 R97-q1

592 **Fig. 7** Time evolution of erosion rate, tests B90-a, B90-c and B90-q2

593 **Fig. 8** Initial soil gradation and gradations of upstream and downstream parts after

594 suffusion test for (a) test A-a; (b) test B90-a

595 **Fig. 9** Flow velocity versus hydraulic gradient, critical hydraulic gradient, soil B

596 **Fig. 10** Erosion rate versus hydraulic shear stress, soil A

597 **Fig. 11** Cumulative loss dry mass versus cumulative expended energy, soil A

598 **Fig. 12** Cumulative loss dry mass versus cumulative expended energy, tests B90-a,

599 B90-c, B90-k and B90-q2

600 **Fig. 13** Cumulative loss dry mass versus cumulative expended energy, tests B97-a,  
601 B97-b, C-a and C-b

602 **Fig. 14** Cumulative loss dry mass versus cumulative expended energy, soil R

603

604

605

606 **Table 1** Properties of tested gradations

Properties	Tested gradations			
	A	B	C	R
P (%)	1.227	1.533	1.779	1.200
$G_r$	3.2	3.2	4	WG
$C_u$	17.06	19.52	21.07	24.46
$d_{15}/d_{85}$	8.761	8.741	8.724	9.653
$(H/F)_{\min}$	0.038	0.035	0.033	0.165
D $(H/F)_{\min}$ (mm)	0.400	0.400	0.400	0.212
$D_{c35}^c/d_{85,SA}^f$	3.295	3.295	3.295	2.903

607

608 P : percentage of particle smaller than 0.063mm;  $G_r = d_{\max}/d_{\min}$  ( $d_{\max}$  and  $d_{\min}$ : maximal  
609 and minimal particle sizes characterizing the gap in the grading curve);  $C_u$ : uniformity  
610 coefficient;  $d_{15}$  and  $d_{85}$  are the sieve sizes for which 15% and 85% respectively of the  
611 weighed soil is finer; F and H are the mass percentages of the grains with a size, lower  
612 than a given particle diameter d and between d and 4d respectively; D  $(H/F)_{\min}$  is the  
613 corresponding diameter with the minimum value of ratio H/F ;  $D_{c35}^c$  is the controlling  
614 constriction for coarser fraction from constriction size distribution by surface area  
615 technique;  $d_{85,SA}^f$  is the representative size for finer fraction by surface area technique;  
616 WG: widely graded soil.

617

618 **Table 2** Properties of tested specimens

					619
Soil reference in paper	Specimen reference in paper	Initial dry density $\gamma_d$ (kN/m <sup>3</sup> )	Applied hydraulic gradient i	Injected flow q (ml/min)	Test duration (min)
A	A-a	17.39	From 0.1 to 15	-	270
	A-a_rep	17.39	From 0.1 to 15	-	250
	A-b	17.39	From 1 to 13	-	130
	A-c	17.39	4	-	300
B	B90-a	17.39	From 0.1 to 6	-	180
	B90-c	17.39	4	-	300
	B90-k	17.39	From 0.5 to 1	-	1440
	B90-q2	17.39	-	1.641	270
	B97-a	18.74	From 0.1 to 12	-	240
	B97-b	18.74	From 1 to 9	-	90
C	C-a	18.74	From 0.1 to 9	-	210
	C-b	18.74	From 1 to 7	-	70
R	R90-a	17.39	From 0.1 to 6	-	180
	R90-b	17.39	From 1 to 8	-	80
	R97-b	18.74	From 1 to 12	-	120
	R97-q1	18.74	-	1.247	210

620 **Table 3** Critical hydraulic gradient, multi staged hydraulic gradient conditions

Tested specimens	Critical hydraulic gradient $i_c$	
	Hydraulic loading (a)	Hydraulic loading (b)
A	3.5 – 3.9	4.5
B90	1.5	
B97	0.5	2
C	2.5	2.5
R90	0.6	1.8
R97		3.4

621

622 **Table 4** Erosion coefficient and correlation coefficient, multi staged hydraulic gradient

623 conditions

Tested specimens	Hydraulic loading (a)		Hydraulic loading (b)	
	Erosion coefficient $k_d$ (s/m)	Correlation coefficient $R^2$	Erosion coefficient $k_d$ (s/m)	Correlation coefficient $R^2$
A	$10^{-8}$ - $9 \cdot 10^{-9}$	0.77-0.59	$3 \cdot 10^{-8}$	0.23
B90	$10^{-6}$	0.54		
B97	$4 \cdot 10^{-7}$	0.01	$7 \cdot 10^{-7}$	0.05
C	$6 \cdot 10^{-7}$	0.08	$10^{-6}$	0.04
R90	$8 \cdot 10^{-7}$	0.15	$2 \cdot 10^{-6}$	0.06
R97			$2 \cdot 10^{-7}$	0.02

624

625

626

627 **Table 5** Erosion resistance index

Tested specimens	Erosion resistance index $I_{\alpha}$ (-)				
	Hydraulic loading (a)	Hydraulic loading (b)	Hydraulic loading (c)	Hydraulic loading (k)	Hydraulic loading (q1 - q2)
A	5.06 – 5.12	<b>4.65</b>	5.00		
B90	<b>2.93</b>		3.25	<b>2.98</b>	3.47
B97	<b>3.64</b>	<b>3.40</b>			
C	<b>3.03</b>	<b>3.09</b>			
R90	<b>2.94</b>	<b>2.94</b>			
R97		<b>3.52</b>			3.29



Figure 1

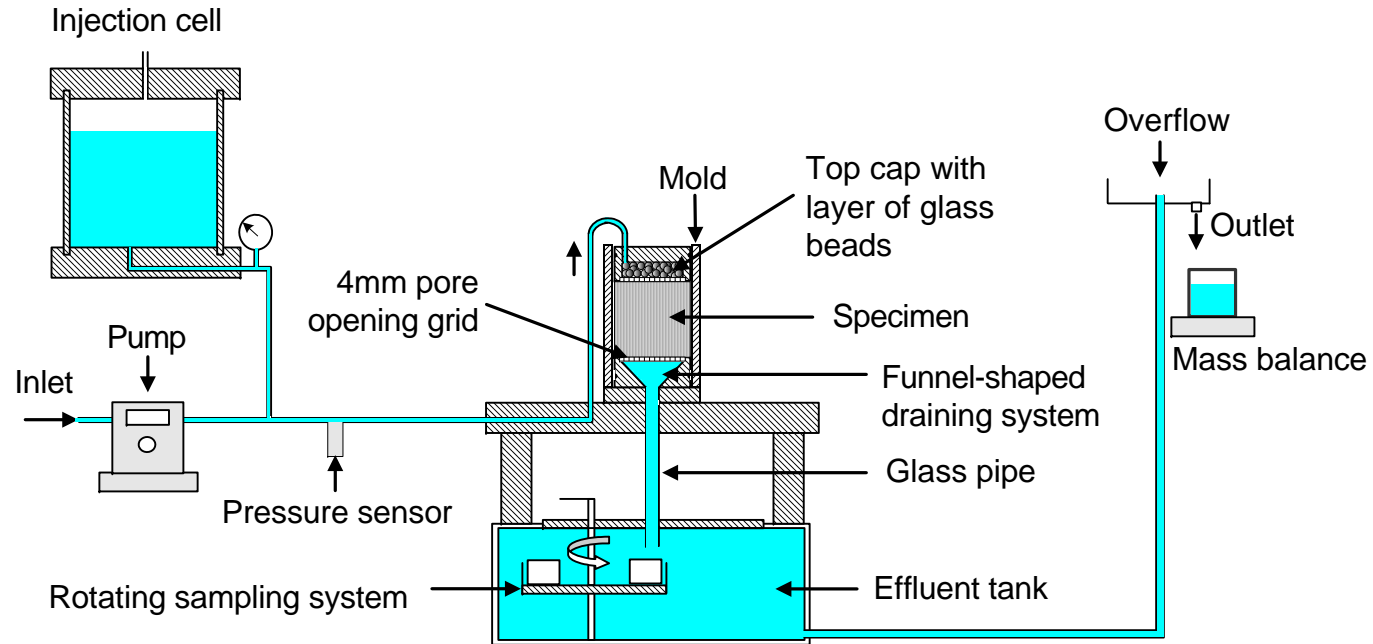

Figure 2

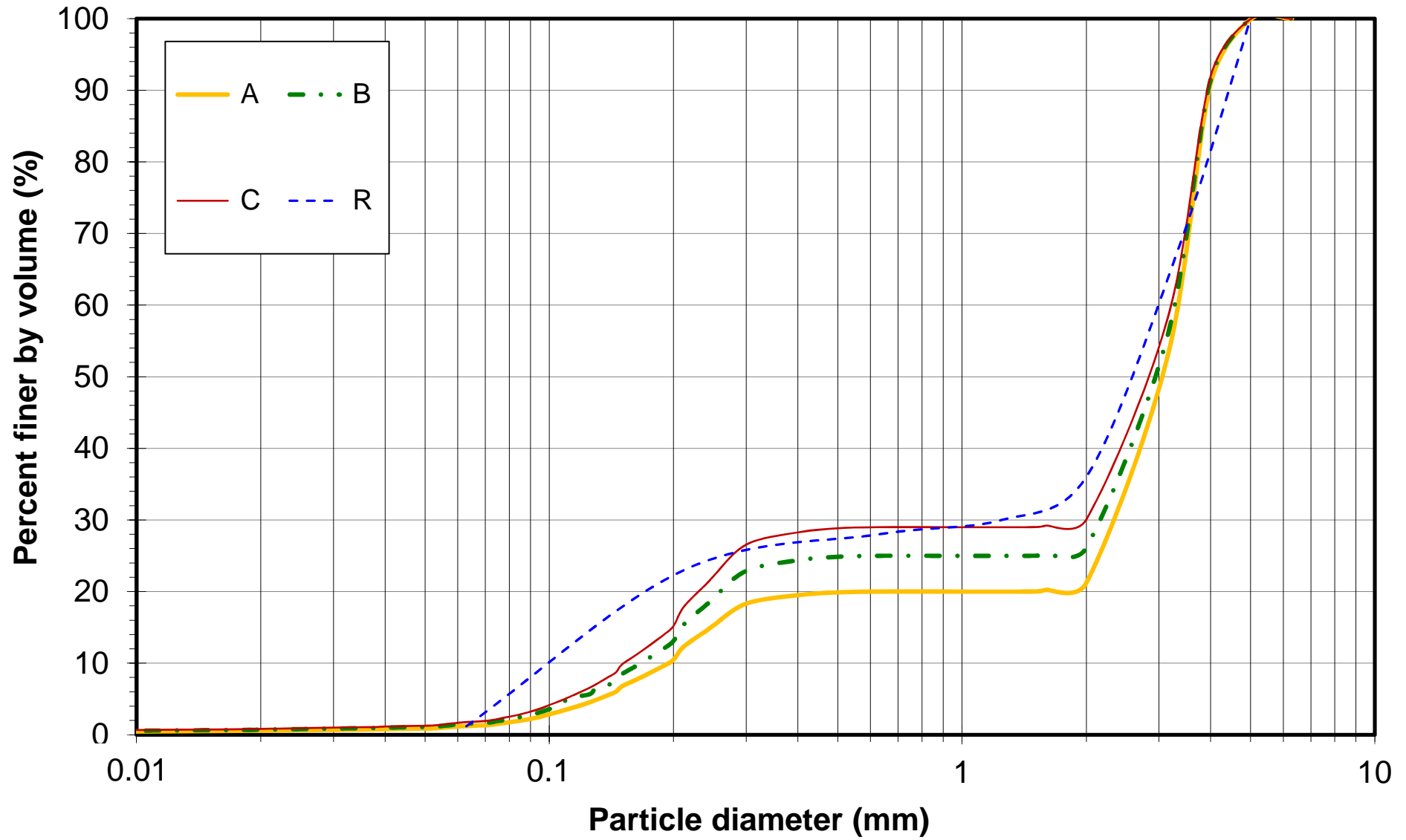

Figure 3

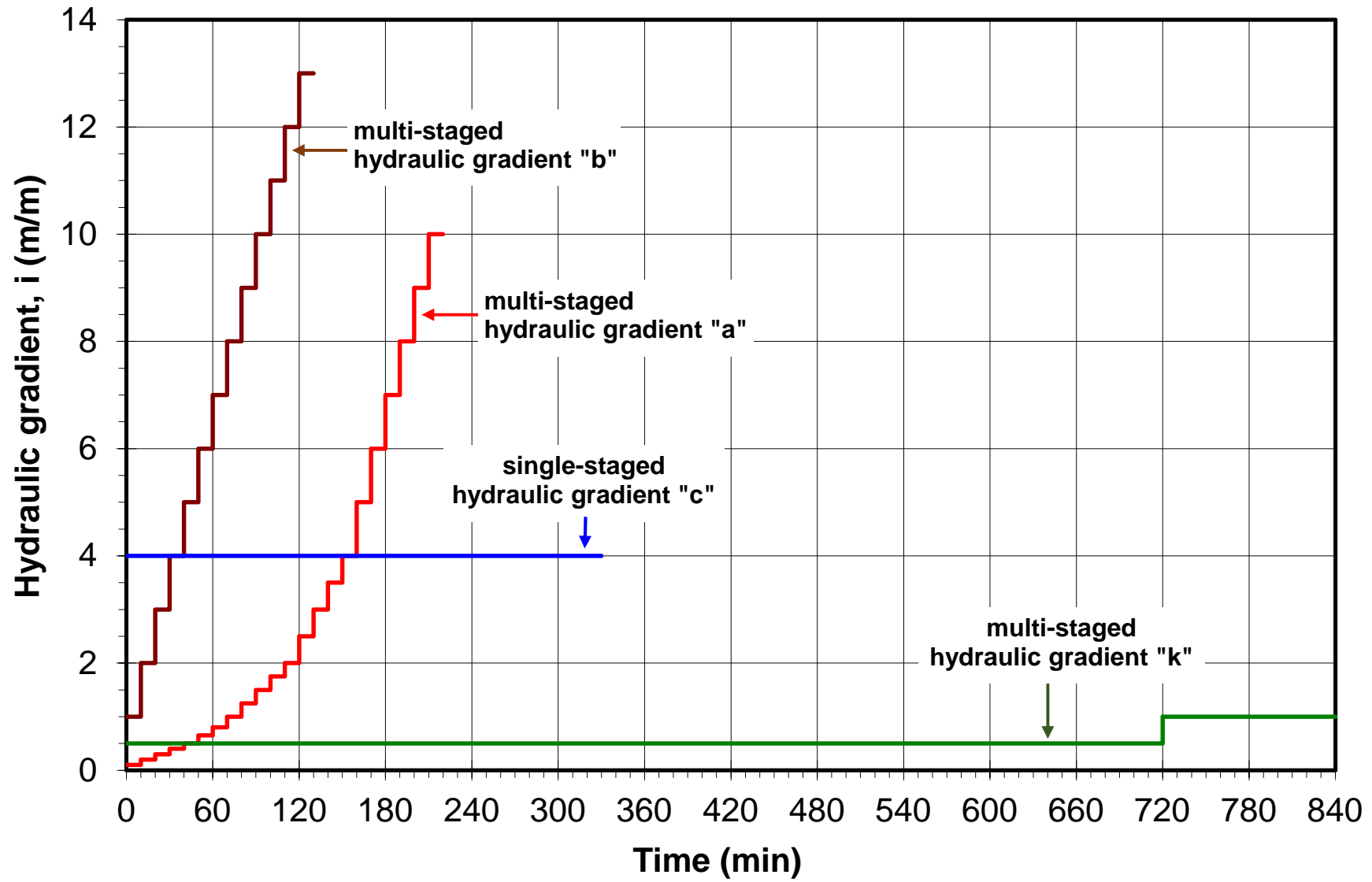

Figure 4

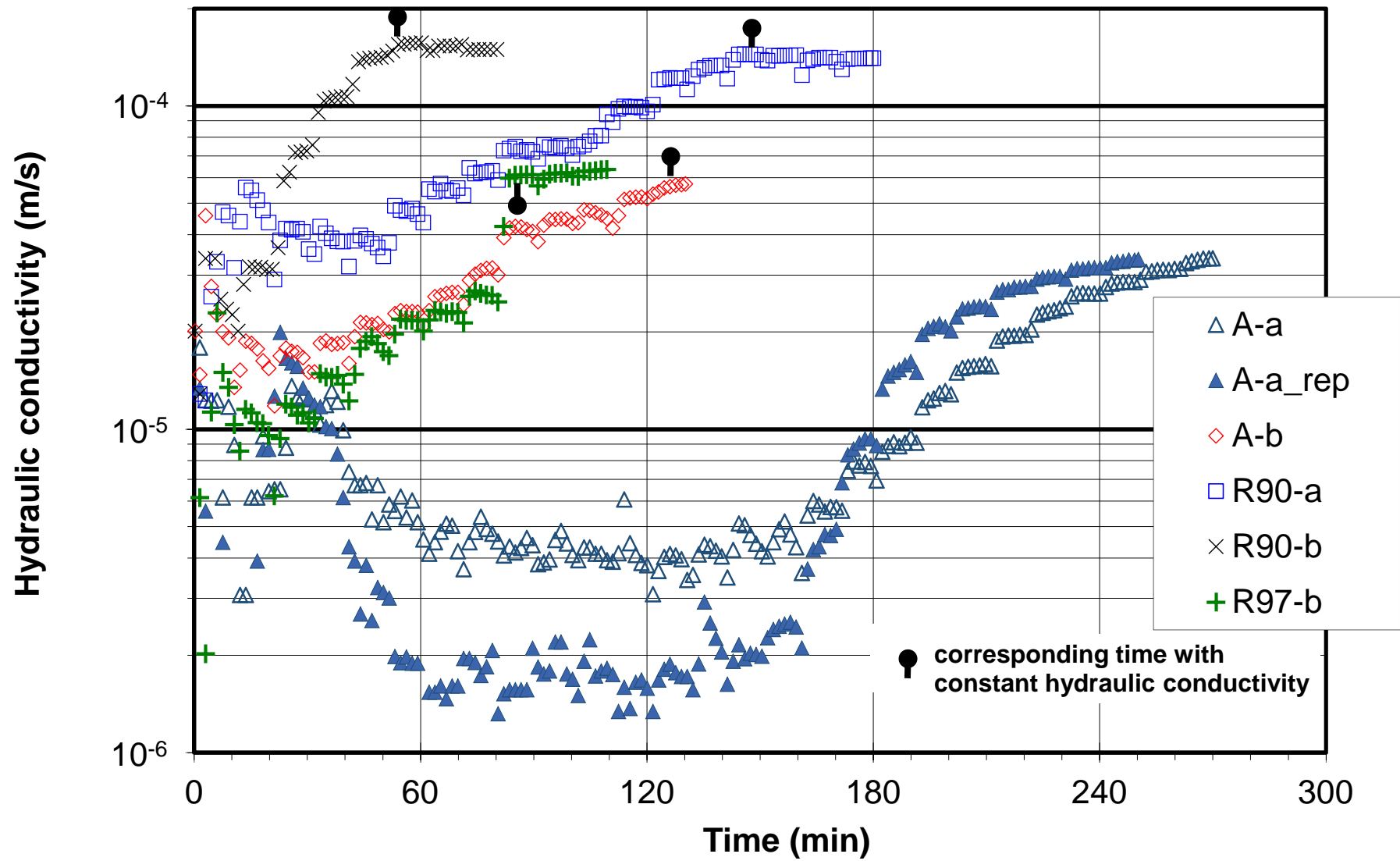

Figure 5

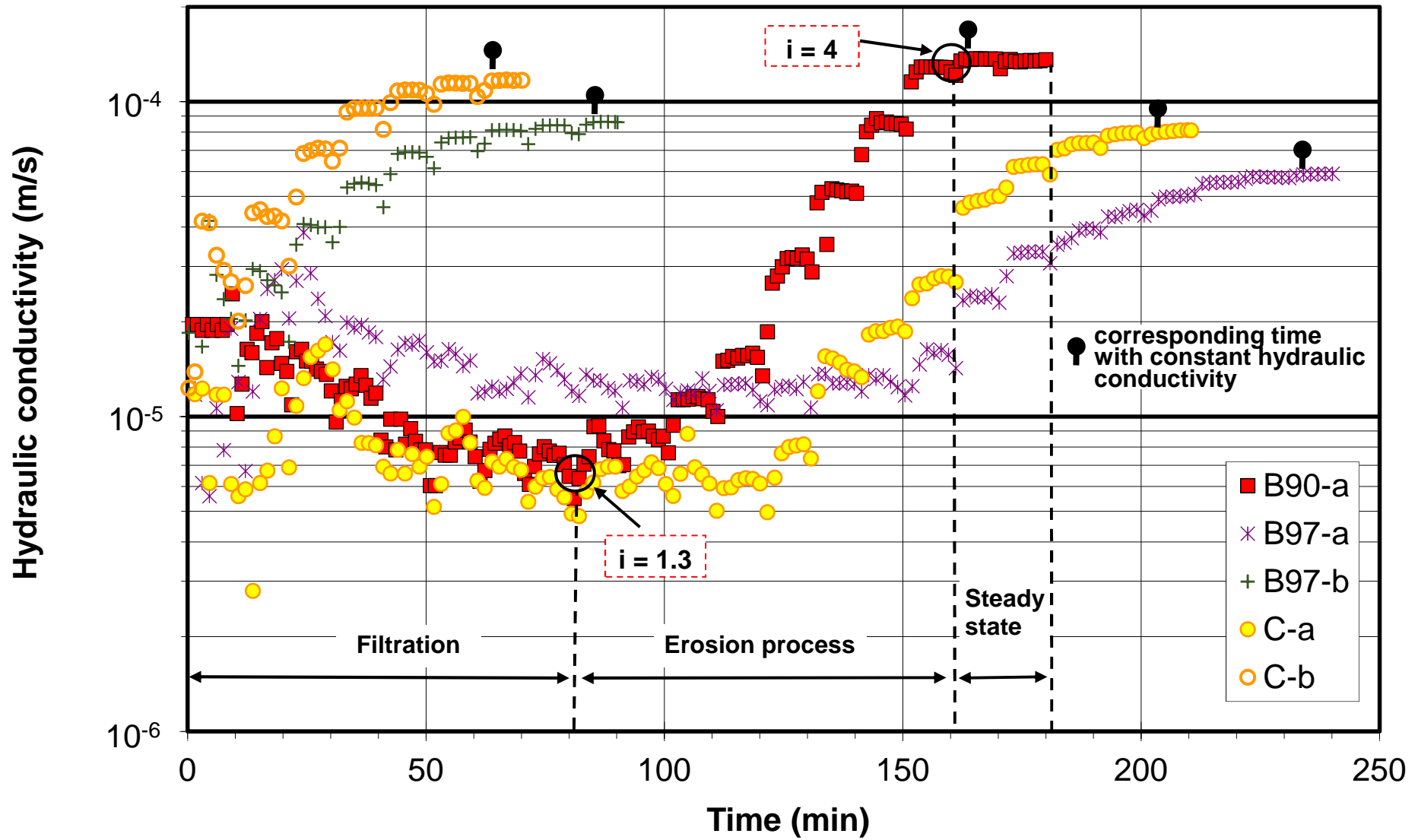

Figure 6

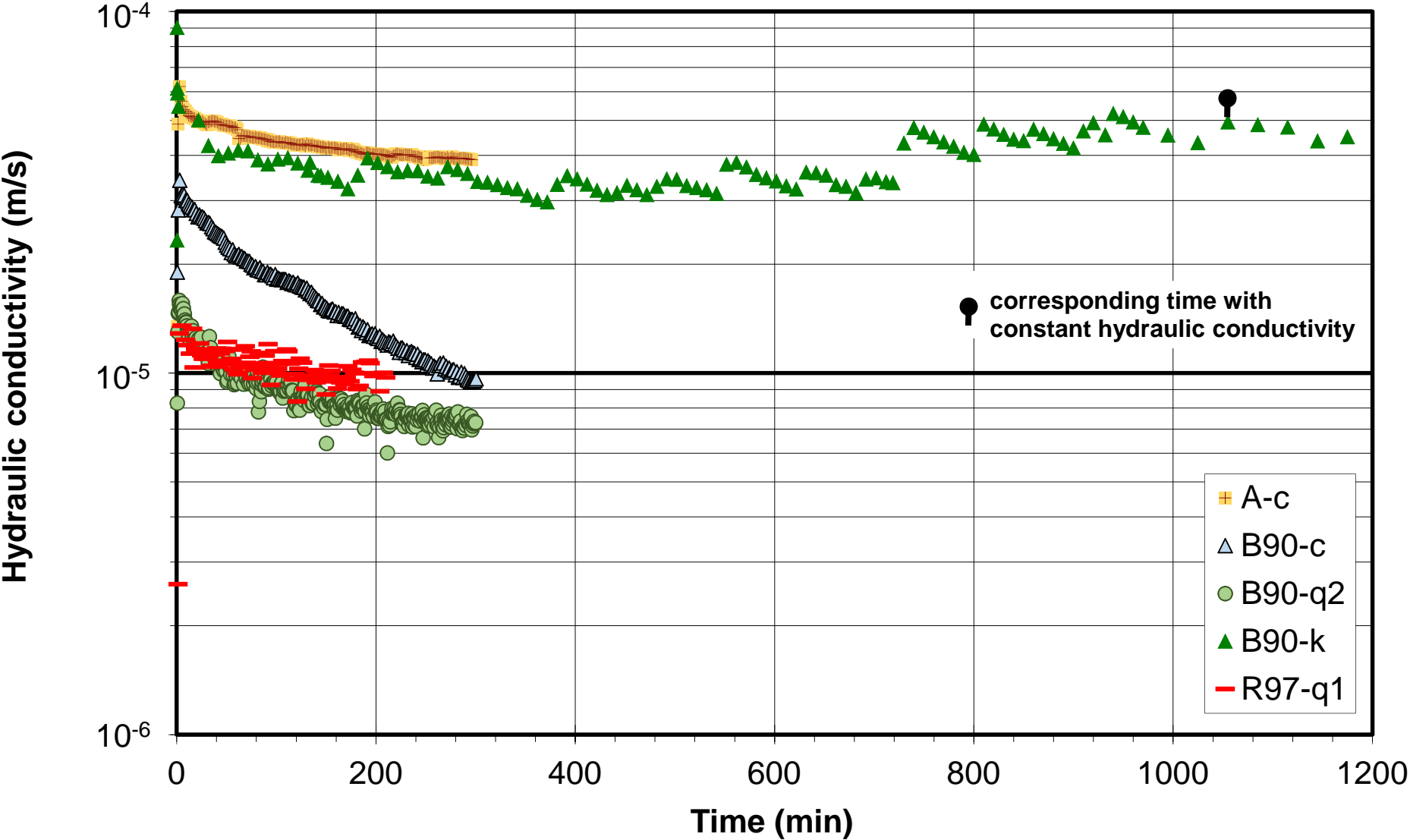

Figure 7

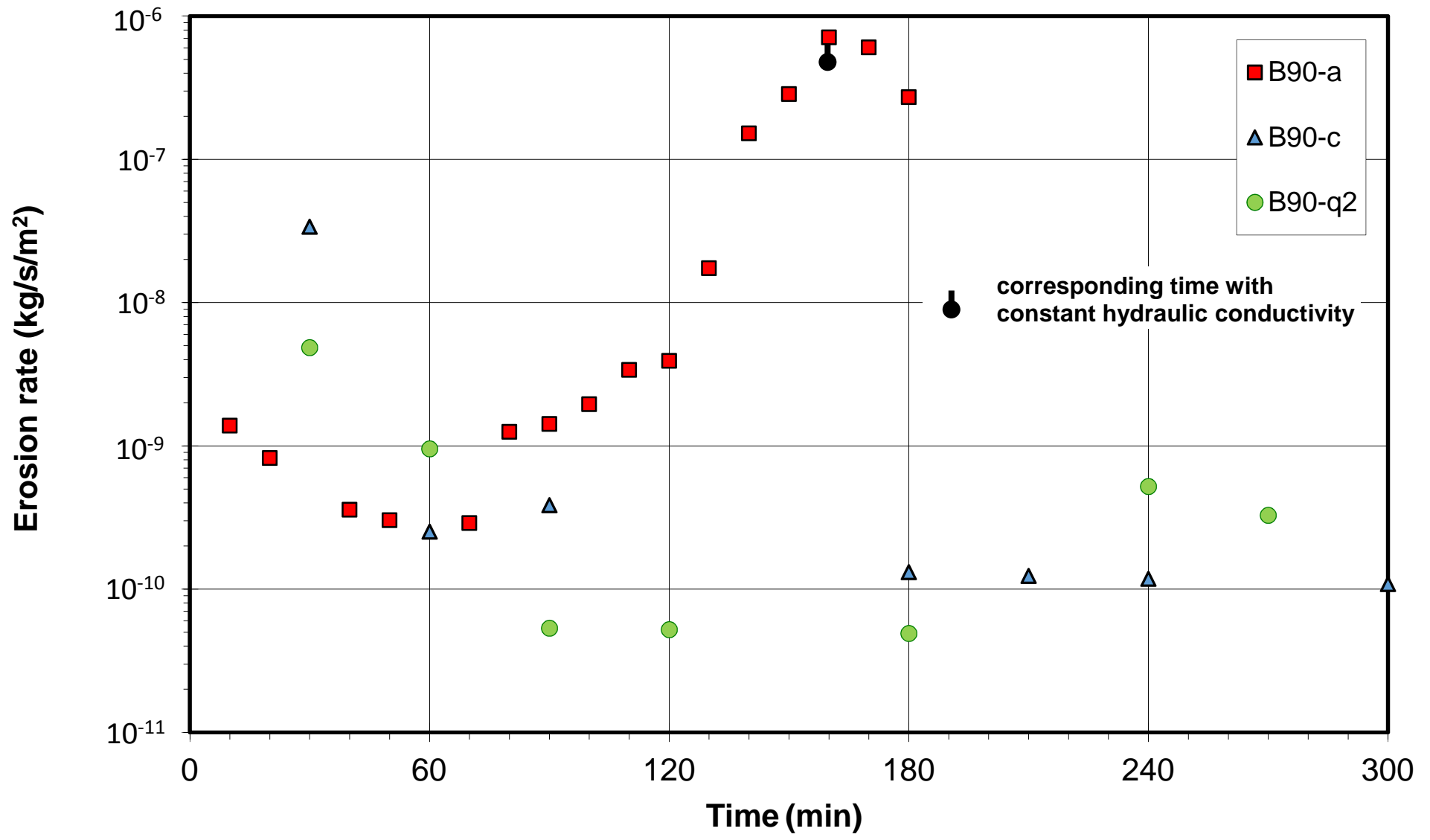

Figure 8a

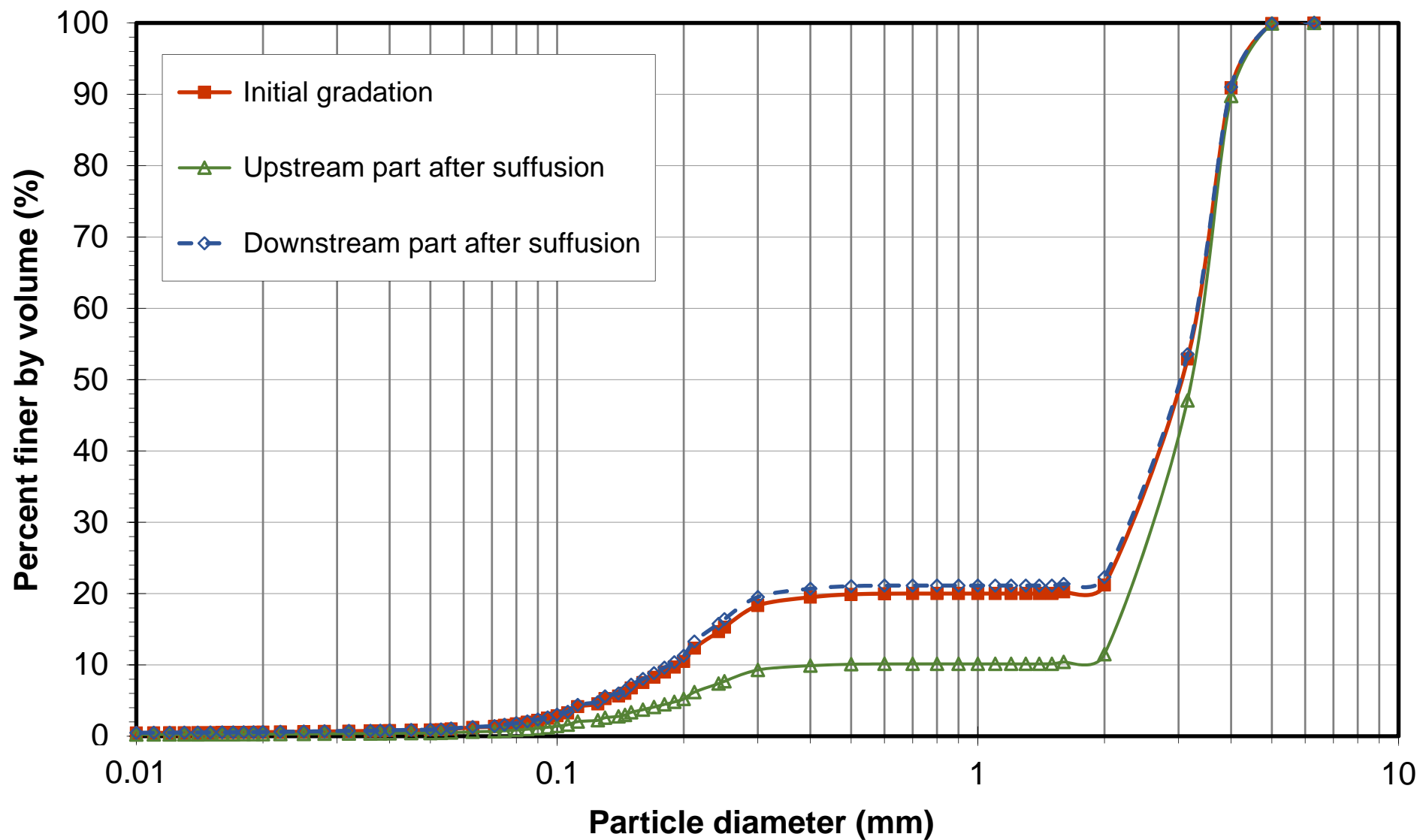



Figure 8b

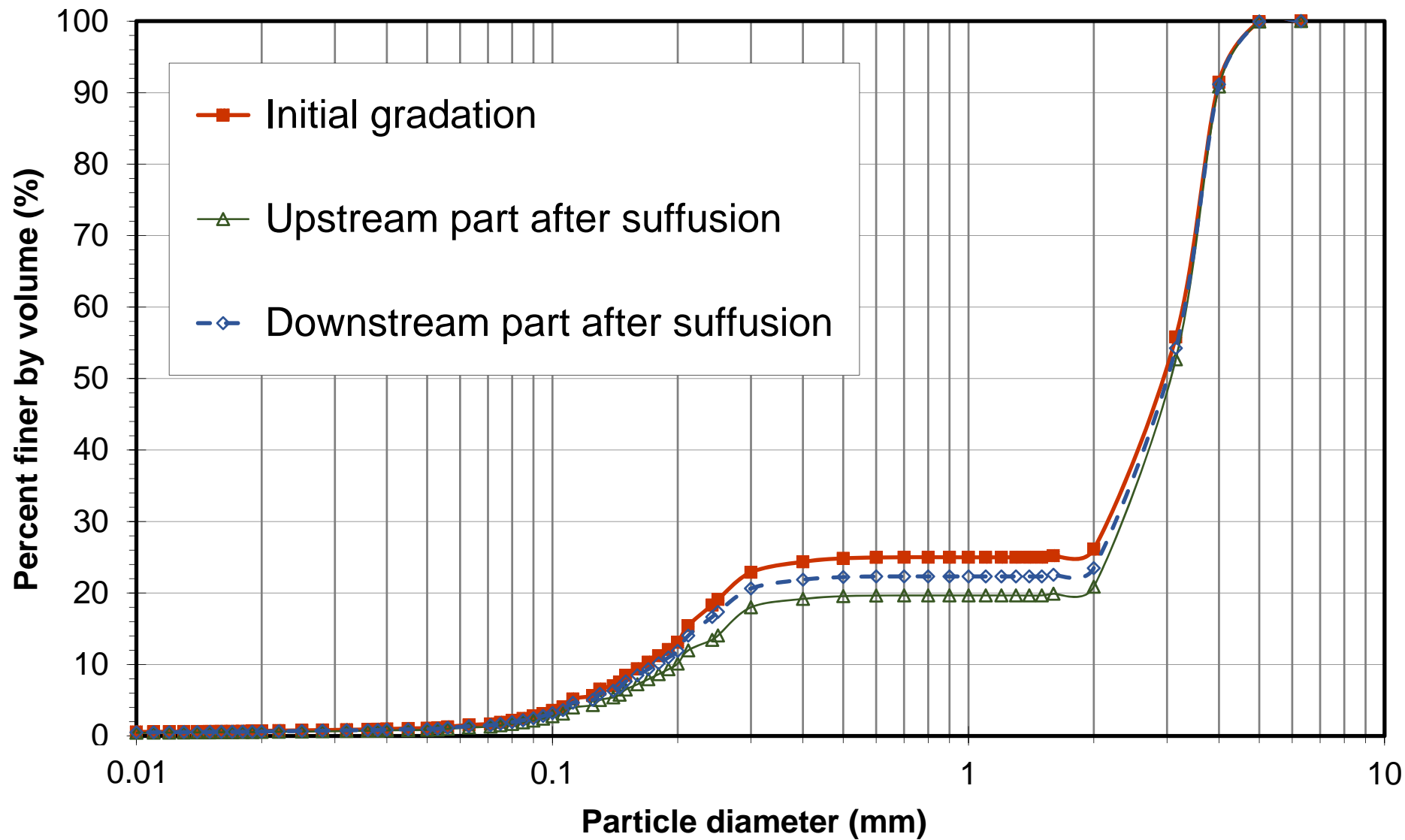

Figure 9

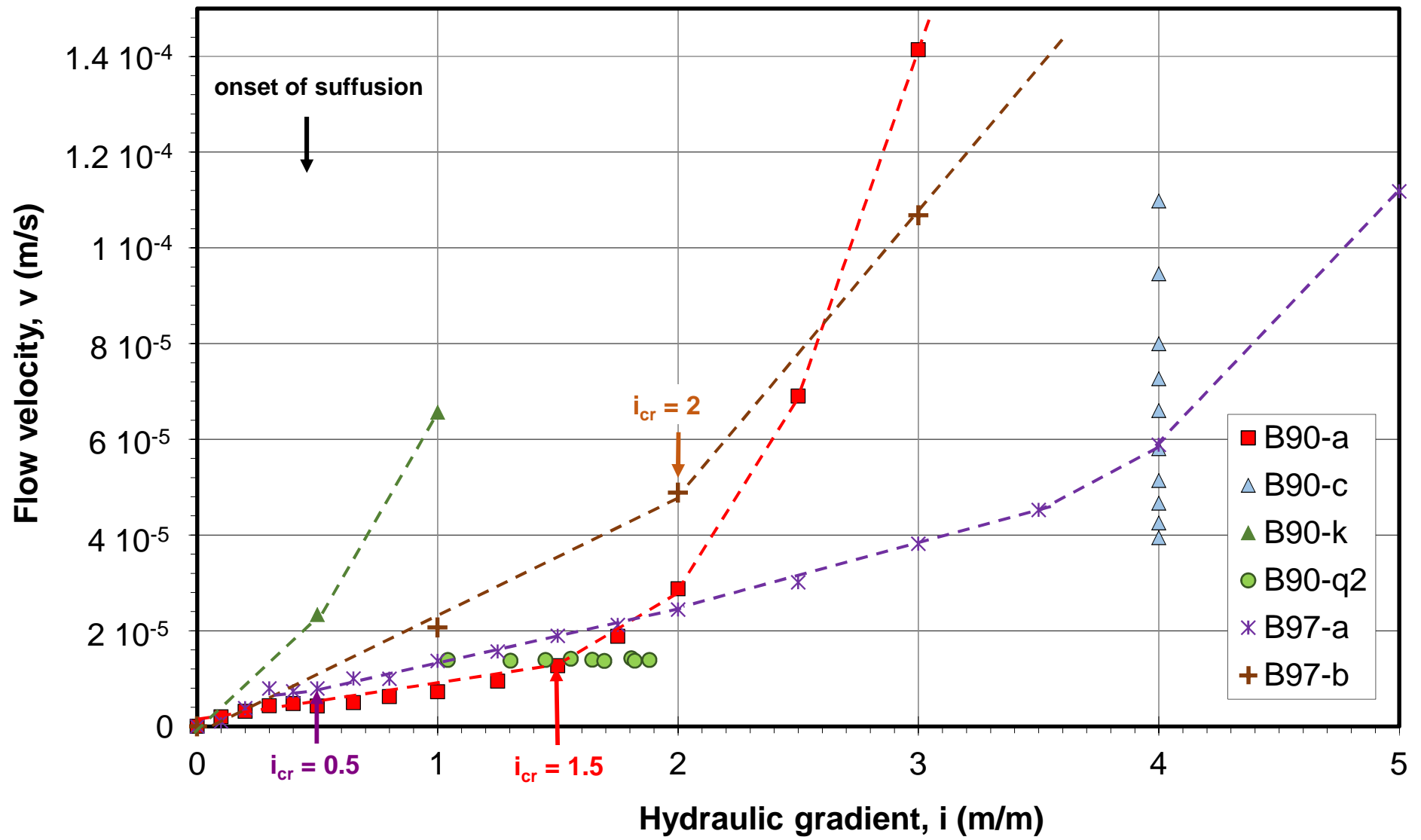

Figure 10

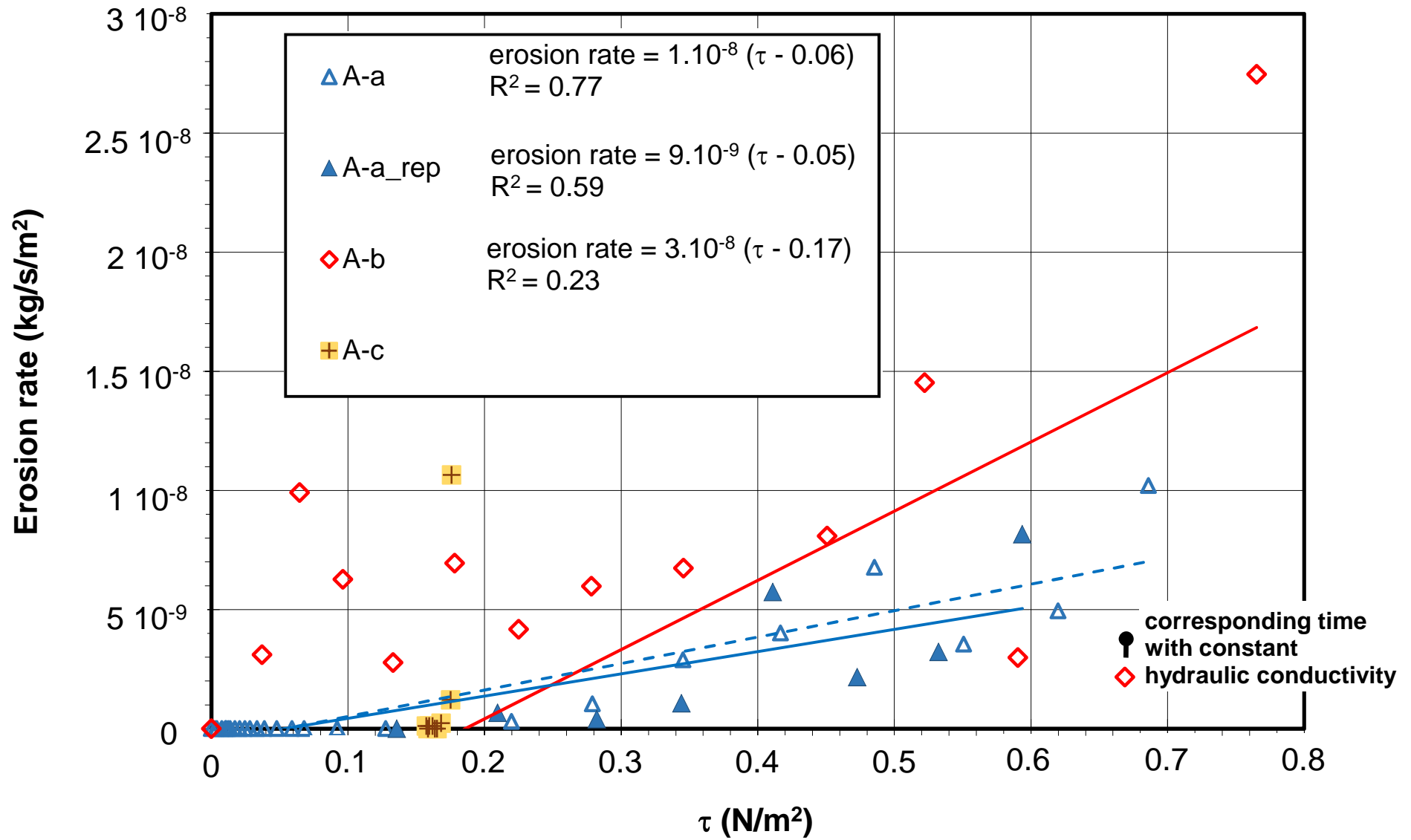

Figure 11

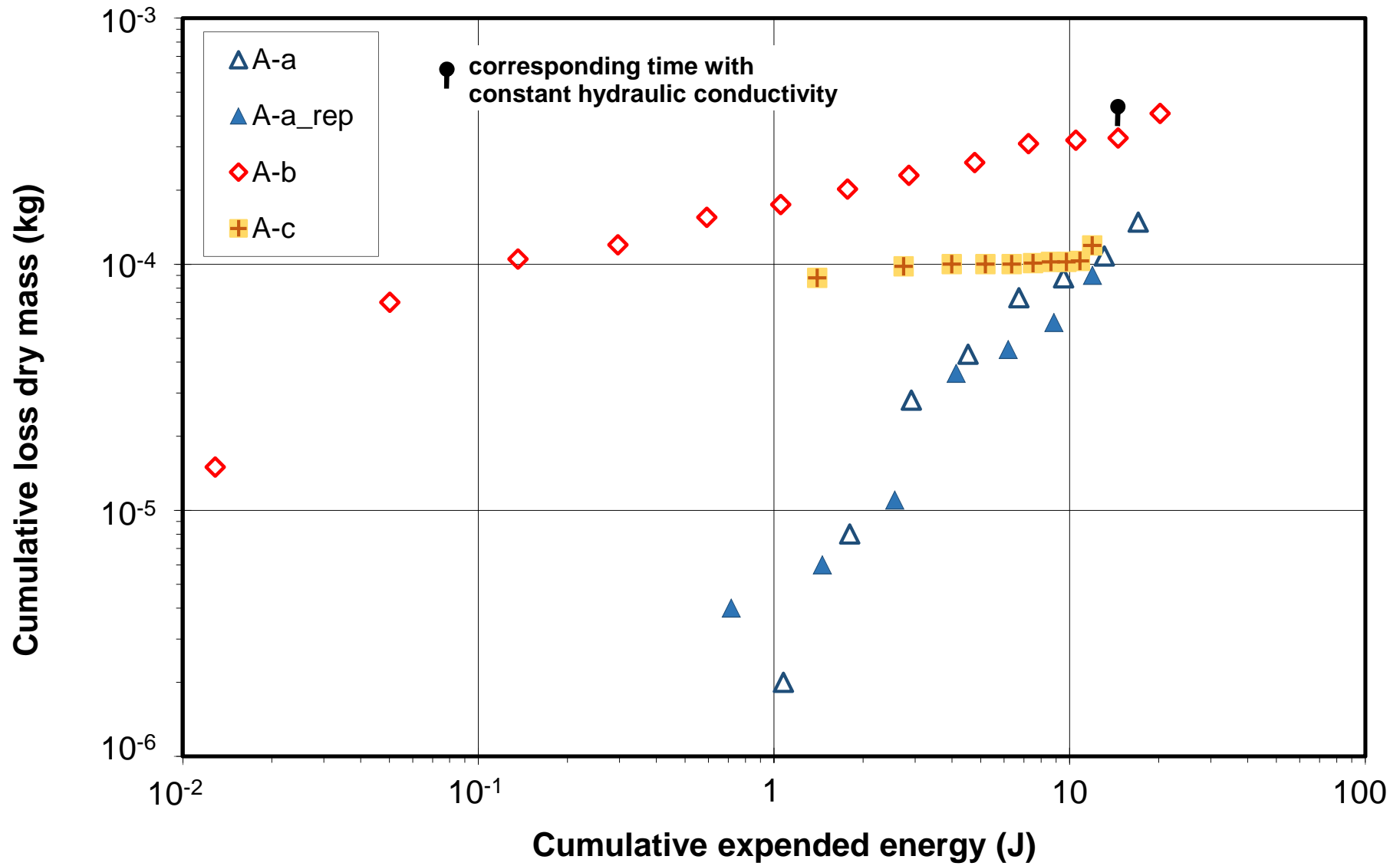

Figure 12

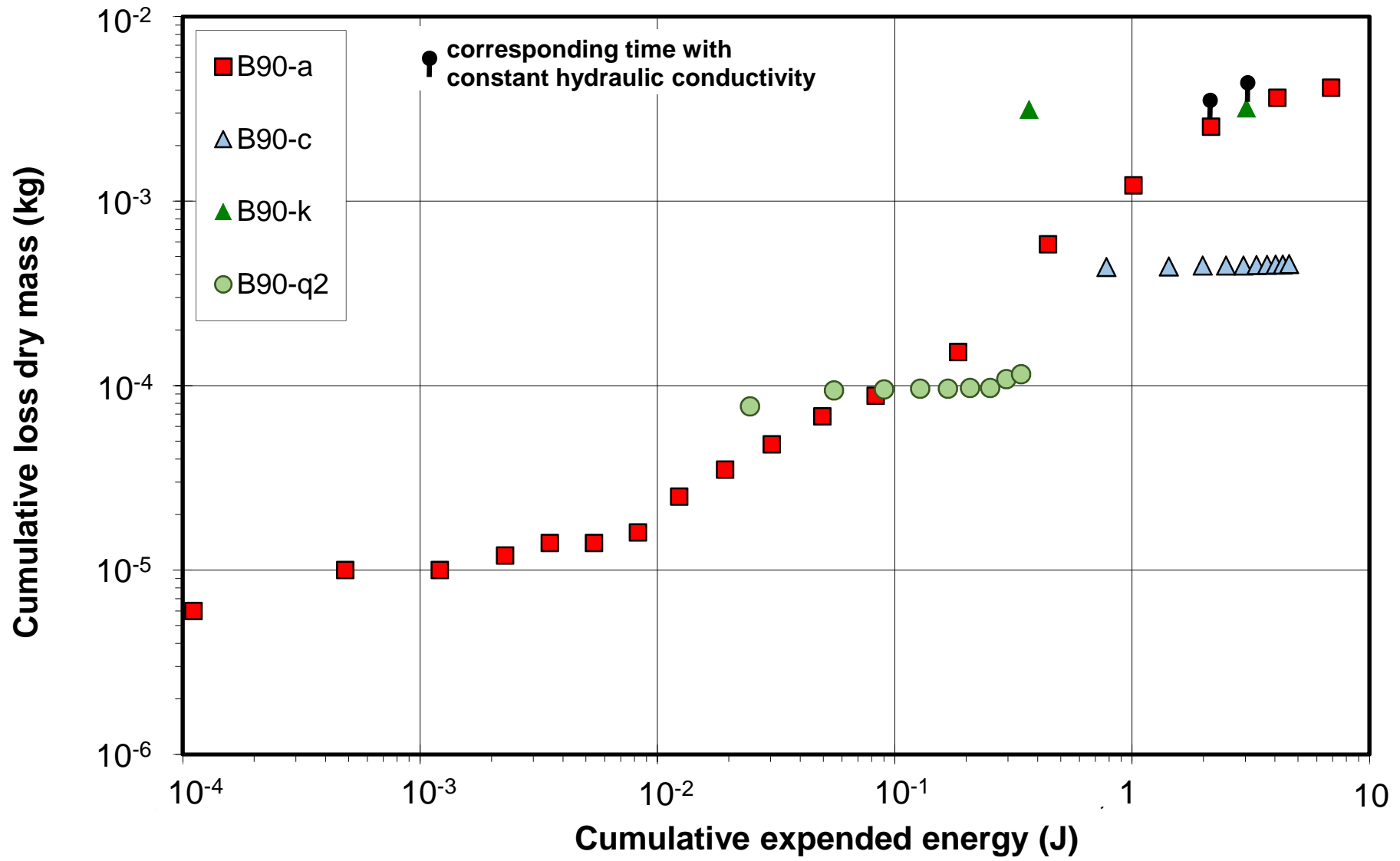

Figure 13

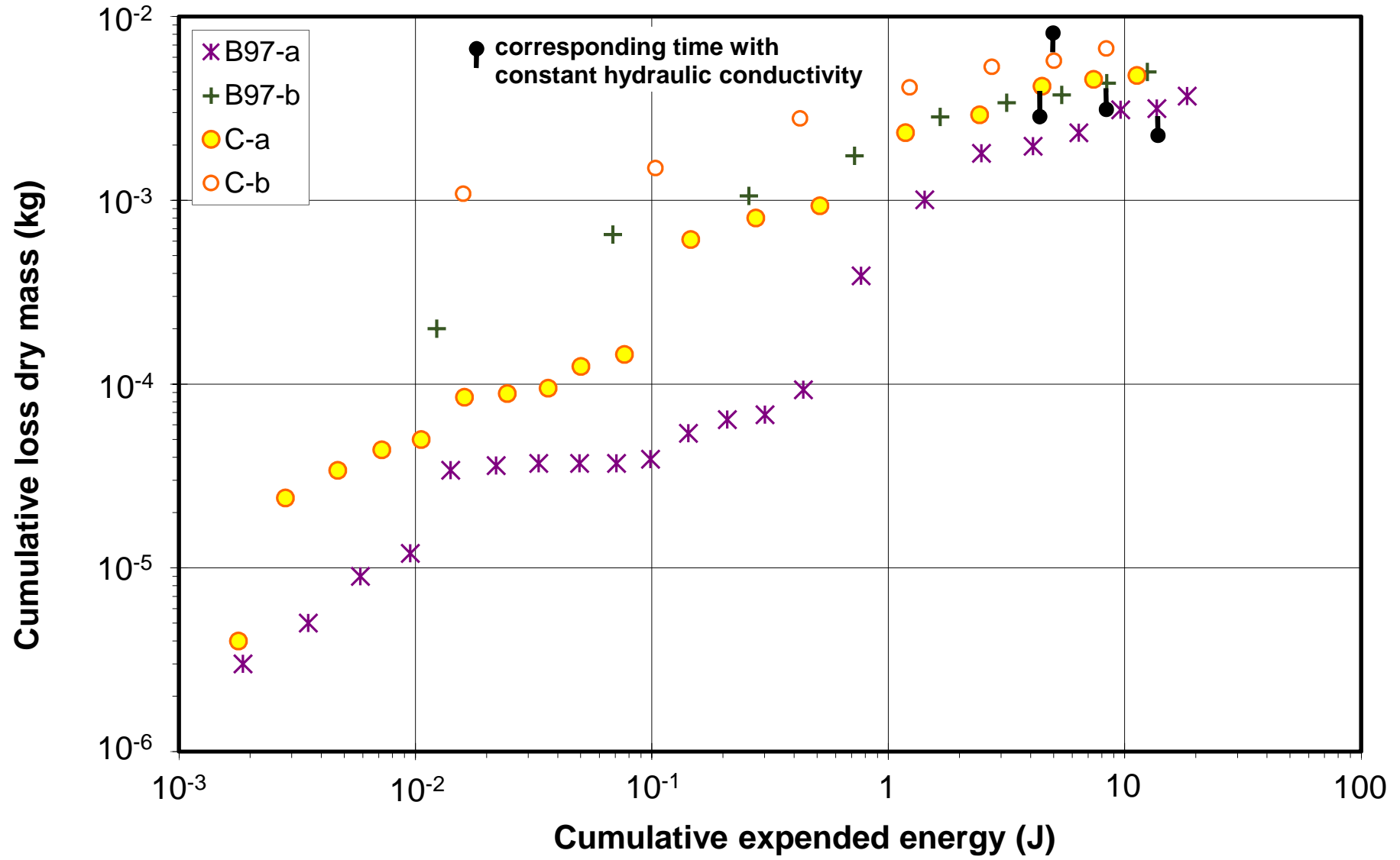

Figure 14

