



HAL
open science

Dynamics and Computed-Torque Control of a 2-DOF manipulator: Mathematical Analysis

Abdel-Nasser Sharkawy, Panagiotis Koustoumpardis

► **To cite this version:**

Abdel-Nasser Sharkawy, Panagiotis Koustoumpardis. Dynamics and Computed-Torque Control of a 2-DOF manipulator: Mathematical Analysis. *International Journal of Advanced Science and Technology*, 2019, 28 (12), pp.201-212. hal-03598924

HAL Id: hal-03598924

<https://hal.science/hal-03598924>

Submitted on 6 Mar 2022

HAL is a multi-disciplinary open access archive for the deposit and dissemination of scientific research documents, whether they are published or not. The documents may come from teaching and research institutions in France or abroad, or from public or private research centers.

L'archive ouverte pluridisciplinaire **HAL**, est destinée au dépôt et à la diffusion de documents scientifiques de niveau recherche, publiés ou non, émanant des établissements d'enseignement et de recherche français ou étrangers, des laboratoires publics ou privés.

Dynamics and Computed-Torque Control of a 2-DOF manipulator: Mathematical Analysis

Abdel-Nasser Sharkawy^{1,2*}, Panagiotis N. Koustoumpardis²

¹Mechanical Engineering Department, Faculty of Engineering, South Valley University,
Qena 83523, Egypt

²Department of Mechanical Engineering and Aeronautics, University of Patras, Rio 26504,
Greece

E-mail: eng.abdelnassersharkawy@gmail.com; koust@upatras.gr

*Corresponding Author

Abstract

In this paper, the dynamics of the 2-DOF manipulators are presented. The mathematical analysis for these dynamics for two cases is carried out: in the first case, the manipulator is moving without any collision (external forces) with its environment, whereas the second case the manipulator is collided. The Computed-Torque Control is used for these dynamic of the manipulator. A simulation study is executed using a sinusoidal motion commanded simultaneously to the two joints of the manipulator. The actual and desired signals of the joints' positions, velocities, accelerations and torques of the 2-DOF robot are compared whether there is a collision or no. The results prove that the computed-torque control is effectively minimizing the error between the actual signals and the desired signals. In addition, the dynamic coupling between the joints is presented from the results.

Keywords: Robot-Manipulator, Joints Dynamics, Dynamic Coupling, Collision, Computed-Torque Control.

1. Introduction

The robot manipulators are highly nonlinear, dynamically coupled and time-varying systems which are used extensively in industrial applications [1]. The benefit of the dynamic model of the manipulator is to compute the torque and force required in order to execute the typical work cycle and to give vital information for the design of the links, the joints, the drives, and the actuators as well as for the control scheme. The manipulator dynamic behaviour gives a relationship between the joint actuator torques and the links motion for simulation and design of control algorithms. Dynamics analysis of robot manipulator is investigated by many researchers in [2]–[5] and the dynamic coupling between the joints of the manipulator is investigated experimentally in [6].

Computed-Torque Control is an effective motion control strategy for robotic manipulator systems [7]. Computed Torque Control [8] is worth noting because of the easiness to be understood and of its good performances. Computed Torque Control is a method for linearizing and decoupling the robotic dynamics by using perfect dynamical models of robotic manipulator systems in order to each joint motion can individually be controlled using other well-developed linear control strategies [7]. Computed-Torque controller was proposed by many researchers for a parallel manipulator [9], for a

master-slave robot manipulator system [10], and stable computed-torque control was proposed in [11] of robot manipulators via fuzzy self-tuning.

In this paper, the mathematical analysis for the dynamics of 2-DOF Manipulator is presented. The computed-torque control law is used for these dynamics. The dynamic coupling between the manipulator joints is investigated and presented. Indeed, the main benefit from this procedure is that the dynamic coupling between the joints should be taken into account during the design and the implementation of the human-robot collision detection method and the collided link identification which contribute to the safety of the human-robot interaction.

2. Dynamics of Multiple Joints Motion

For the presented case study, it is assumed that the commanded motion is applied to the 4th (A3) and 6th (A5) joint of the KUKA LWR manipulator (collaborative robot), as shown in Fig. 1. The case when the two joints during the planar horizontal motion is studied and analyzed (Fig. 1b). In all the paper, joint 1 and joint 2 will represent A3 and A5 joints respectively. It should be noted that the all other joints of the manipulator are fixed.

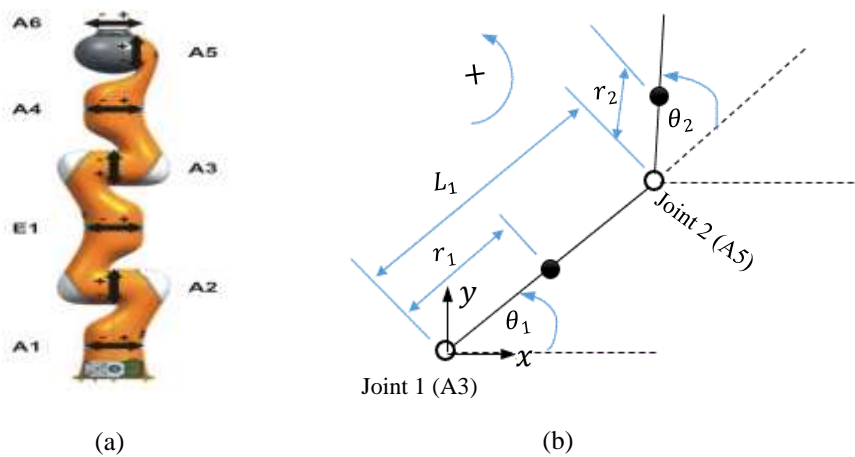

Figure 1. Kuka LWR manipulator. (a) The all joints of the kuka robot. (b) Motion of Joint A3 and A5 (The black spot means the center of mass) in a horizontal plane.

The second-order vector differential equation for the motion of the manipulator as a function of the applied joint torques when there is no external forces (collisions) affecting on the end-effector or the link between the two joints is given by [12]

$$M(\theta)\ddot{\theta} + C(\theta, \dot{\theta})\dot{\theta} = \tau \quad (1)$$

In another form, the equation can be rewritten as [12]

$$\begin{bmatrix} \alpha + 2\beta c_2 & \delta + \beta c_2 \\ \delta + \beta c_2 & \delta \end{bmatrix} \begin{bmatrix} \ddot{\theta}_1 \\ \ddot{\theta}_2 \end{bmatrix} + \begin{bmatrix} -\beta s_2 \dot{\theta}_2 & -\beta s_2 (\dot{\theta}_1 + \dot{\theta}_2) \\ \beta s_2 \dot{\theta}_1 & 0 \end{bmatrix} \begin{bmatrix} \dot{\theta}_1 \\ \dot{\theta}_2 \end{bmatrix} = \begin{bmatrix} \tau_1 \\ \tau_2 \end{bmatrix} \quad (2)$$

where

$$\alpha = I_{z1} + I_{z2} + m_1 r_1^2 + m_2 (L_1^2 + r_2^2)$$

$$\beta = m_2 L_1 r_2$$

$$\delta = I_{z2} + m_2 r_2^2$$

where $\theta_i, \dot{\theta}_i, \ddot{\theta}_i$ is the actual angular position of the center of mass for the i th link and their corresponding time derivatives. r_i is the distance from the joint i to the center of mass for link i . I_{zi} is the moment of inertia about the z -axes of the i th link frame. $M(\theta) \in R^{2 \times 2}$ is the inertia matrix that depends on the variable θ , and $C(\theta, \dot{\theta}) \in R^{2 \times 2}$ is the matrix containing the Coriolis and centrifugal terms. $G(\theta) \in R^2 = 0.0$ is the gravity vector and it is equal to zero due to that the motion in horizontal plane. $\tau_i \in R^2$ is the joint torque for i th joint. m_i is the mass of i th link, L_i is the length of i th link, $s_i = \sin\theta_i$, $c_i = \cos\theta_i$, $s_{ij} = \sin(\theta_i + \theta_j)$, and $c_{ij} = \cos(\theta_i + \theta_j)$.

From (2), it is easy to derive the torque at joint1 and 2 as the following equations

$$\tau_1 = (\alpha + 2\beta c_2)\ddot{\theta}_1 + (\delta + \beta c_2)\ddot{\theta}_2 - \beta s_2 \dot{\theta}_1 \dot{\theta}_2 - \beta s_2 (\dot{\theta}_1 + \dot{\theta}_2) \dot{\theta}_2 \quad (3)$$

$$\tau_2 = (\delta + \beta c_2)\ddot{\theta}_1 + \delta \ddot{\theta}_2 + \beta s_2 \dot{\theta}_1^2 \quad (4)$$

2.1. External Force is perpendicular to link 1 (L_1)

If there is an external force exerted perpendicularly on the link 1 as shown in Fig. 2, the dynamic equation is derived by the following steps,

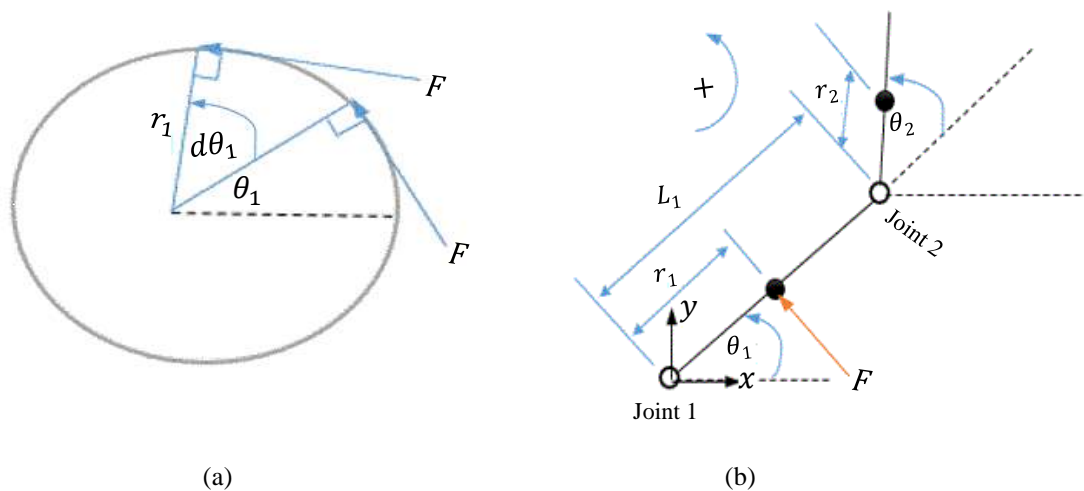

Figure 2. Effect of external force (collision) on the joints torque. (a) Link after rotating by the effect of the external force. (b) External perpendicular force (collision) on link 1.

The work done by force F is given by

$$dW = Fr_1 d\theta_1 \quad (5)$$

The potential energy $V(\theta)$ is equal to the work done by force F so

$$V(\theta) = dW = Fr_1 d\theta_1 \quad (6)$$

Taking the derivative of (6) according to θ_1 and θ_2

$$\frac{\partial V}{\partial \theta_1} = Fr_1, \quad \frac{\partial V}{\partial \theta_2} = 0 \quad (7)$$

So the equation for the motion of the manipulator is converted from (2) into the following equation

$$\begin{bmatrix} \alpha + 2\beta c_2 & \delta + \beta c_2 \\ \delta + \beta c_2 & \delta \end{bmatrix} \begin{bmatrix} \ddot{\theta}_1 \\ \ddot{\theta}_2 \end{bmatrix} + \begin{bmatrix} -\beta s_2 \dot{\theta}_2 & -\beta s_2 (\dot{\theta}_1 + \dot{\theta}_2) \\ \beta s_2 \dot{\theta}_1 & 0 \end{bmatrix} \begin{bmatrix} \dot{\theta}_1 \\ \dot{\theta}_2 \end{bmatrix} + \begin{bmatrix} Fr_1 \\ 0 \end{bmatrix} = \begin{bmatrix} \tau_1 \\ \tau_2 \end{bmatrix} \quad (8)$$

It is noted from (8) that the torque at joint 1 is more affected than the torque at joint 2.

2.2. External Force is perpendicular to link 2 (L_2)

In case of the perpendicular external force on link 2 as shown in Fig. 3, the dynamic equation is derived as the following steps,

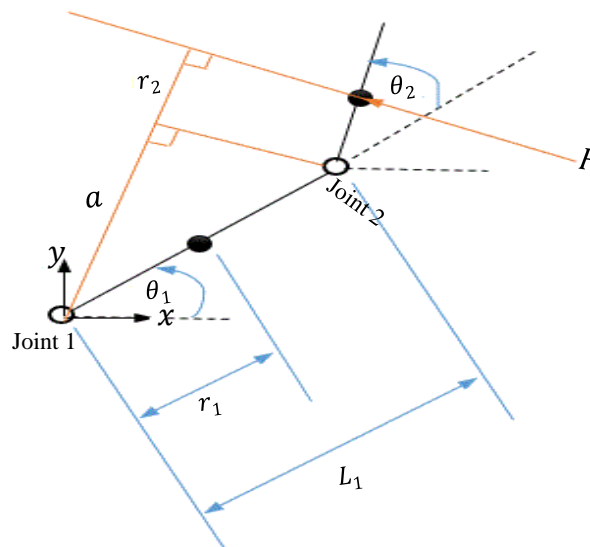

Figure 3. External perpendicular force (collision) exerted on link 2

The potential energy $V(\theta)$ is equal to the work done by force F

$$V(\theta) = dW_1 + dW_2 \quad (9)$$

The work done by force F at joint 2

$$dW_1 = Fr_2 d(\theta_1 + \theta_2) \quad (10)$$

where

$$d(\theta_1 + \theta_2) = (\theta_1 + \theta_2)_{\text{after rotating the link}} - (\theta_1 + \theta_2)_{\text{before rotating the link}}$$

The work done by force F at joint 1

$$\begin{aligned} dW_2 &= F(r_2 + a)d(\theta_1 + \theta_2) = F(r_2 + L_1 \cos(\theta_2))d(\theta_1 + \theta_2) \\ &= Fr_2 d(\theta_1 + \theta_2) + FL_1 \cos(\theta_2) d(\theta_1 + \theta_2) \end{aligned} \quad (11)$$

By substituting (10) and (11) into (9), the potential energy is

$$\begin{aligned} V(\theta) &= Fr_2 d(\theta_1 + \theta_2) + Fr_2 d(\theta_1 + \theta_2) + FL_1 \cos(\theta_2) d(\theta_1 + \theta_2) \\ &= 2Fr_2 d(\theta_1 + \theta_2) + FL_1 \cos(\theta_2) d(\theta_1 + \theta_2) \end{aligned} \quad (12)$$

Taking the derivative of (12) according to θ_1 and θ_2

$$\frac{\partial V}{\partial \theta_1} = 2Fr_2 + FL_1 \cos(\theta_2), \quad \frac{\partial V}{\partial \theta_2} = 2Fr_2 + FL_1 \cos(\theta_2) - FL_1 \sin(\theta_2) d(\theta_1 + \theta_2) \quad (13)$$

So the dynamic equation for the motion of the manipulator is converted from (2) into the following equation

$$\begin{aligned} \begin{bmatrix} \alpha + 2\beta c_2 & \delta + \beta c_2 \\ \delta + \beta c_2 & \delta \end{bmatrix} \begin{bmatrix} \ddot{\theta}_1 \\ \ddot{\theta}_2 \end{bmatrix} + \begin{bmatrix} -\beta s_2 \dot{\theta}_2 & -\beta s_2 (\dot{\theta}_1 + \dot{\theta}_2) \\ \beta s_2 \dot{\theta}_1 & 0 \end{bmatrix} \begin{bmatrix} \dot{\theta}_1 \\ \dot{\theta}_2 \end{bmatrix} + \\ \begin{bmatrix} 2Fr_2 + FL_1 \cos(\theta_2) \\ 2Fr_2 + FL_1 \cos(\theta_2) - FL_1 \sin(\theta_2) d(\theta_1 + \theta_2) \end{bmatrix} = \begin{bmatrix} \tau_1 \\ \tau_2 \end{bmatrix} \end{aligned} \quad (14)$$

It is noted from eq. (14) that the torque at joint 1 is more affected than joint 2 because of the higher lever-arm.

Note: To derive the dynamic equation when there is an external force on link 1 and in the same time another force on link 2, the same previous steps can be followed.

3. Computed Torque Control

Computed torque is a special application of feedback linearization of nonlinear systems, which has gained popularity in modern systems theory [13], [14]. Computed-Torque Control is used in this paper to simulate the reality as working with a real robot to show the effects on the variables; position, velocity, acceleration and torque whether there is external force or no. The following steps derive the equation of the computed-Torque Control law.

If the desired trajectory $\theta_d(t)$ is selected for the arm manipulation so the tracking error is

$$e(t) = \theta_d(t) - \theta(t) \quad (15)$$

By taking the first and second derivative of the error is

$$\dot{e} = \dot{\theta}_d - \dot{\theta}, \quad \ddot{e} = \ddot{\theta}_d - \ddot{\theta} \quad (16)$$

From (1), $\ddot{\theta}$ is given by

$$\ddot{\theta} = M(\theta)^{-1}(\tau - C(\theta, \dot{\theta})\dot{\theta}) \quad (17)$$

By substituting $\ddot{\theta}$ from (17) into (16) so

$$\ddot{e} = \ddot{\theta}_d + M(\theta)^{-1}(C(\theta, \dot{\theta})\dot{\theta} - \tau) \quad (18)$$

Defining the control input function as [15]

$$u = \ddot{e} = \ddot{\theta}_d + M(\theta)^{-1}(C(\theta, \dot{\theta})\dot{\theta} - \tau) \quad (19)$$

From (19), the computed joint torque τ is given by

$$\tau = M(\theta)(\ddot{\theta}_d - u) + C(\theta, \dot{\theta})\dot{\theta} \quad (20)$$

Select the control signal u as the proportional-Derivative (PD) Feedback

$$u = -K_d \dot{e} - K_p e \quad (21)$$

By substituting (21) into (20), the computed joint torque which is the robot arm input becomes

$$\tau = M(\theta)(\ddot{\theta}_d + K_d \dot{e} + K_p e) + C(\theta, \dot{\theta})\dot{\theta} \quad (22)$$

Which called the *computed-Torque Control* law. The PD gains are usually selected for critical damping $\xi = 1$ [15], [16]. In this case:

$$K_d = 2\sqrt{K_p} \quad \text{and} \quad K_p = \frac{K_d^2}{4} \quad (23)$$

The computed-torque control depends on the inversion of the robot dynamics, and indeed is called inverse dynamics control and it results the real joint acceleration vector after calculating τ from eq. (22) and substituting its value in eq. (17).

The equation for the entire system can be derived from (1) and (22) by

$$\begin{aligned} M(\theta)\ddot{\theta} + C(\theta, \dot{\theta})\dot{\theta} &= M(\theta)(\ddot{\theta}_d + K_d \dot{e} + K_p e) + C(\theta, \dot{\theta})\dot{\theta} \\ \ddot{\theta} &= \ddot{\theta}_d + K_d \dot{e} + K_p e \end{aligned}$$

Therefore,

$$\ddot{e} + K_d \dot{e} + K_p e = 0.0 \quad (24)$$

Equation (24) means that there is not any external disturbance. The block diagram of the computed-torque control is shown in Fig. 4

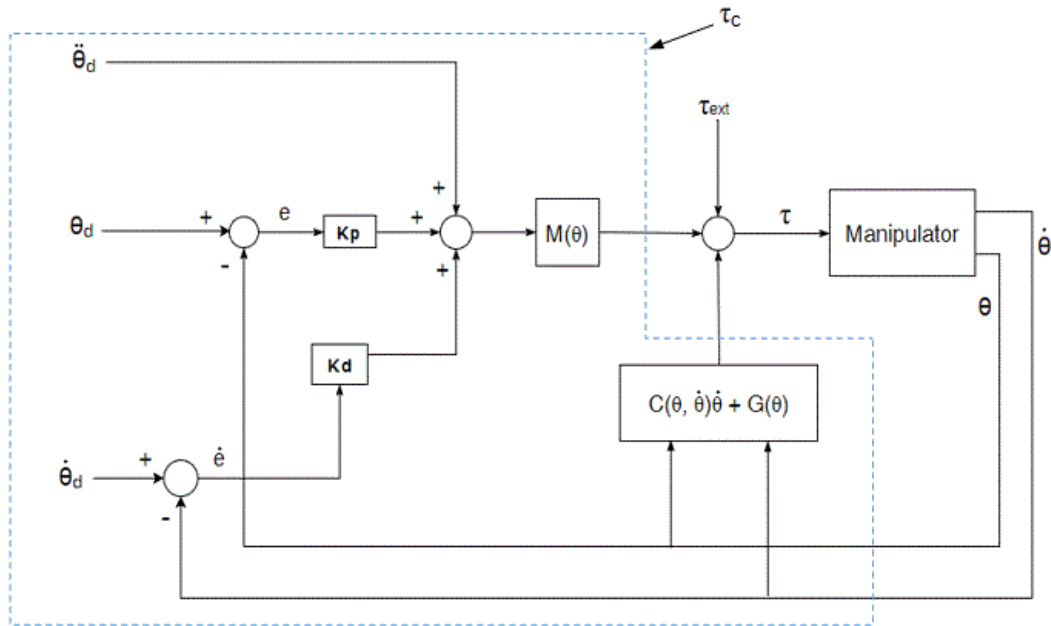

Figure 4. Computed-torque control scheme. In our case, $G(\theta) = 0.0$ because of the motion is in horizontal plane.

3.1. Computed Torque Control for Multiple joints motion

The torque from the PD-controller based on Fig. 4 is given by the following equation

$$\begin{bmatrix} \alpha + 2\beta c_2 & \delta + \beta c_2 \\ \delta + \beta c_2 & \delta \end{bmatrix} \begin{bmatrix} \ddot{\theta}_{1d} + K_{d1}\dot{e}_1 + K_{p1}e_1 \\ \ddot{\theta}_{2d} + K_{d2}\dot{e}_2 + K_{p2}e_2 \end{bmatrix} + \begin{bmatrix} -\beta s_2 \dot{\theta}_2 & -\beta s_2(\dot{\theta}_1 + \dot{\theta}_2) \\ \beta s_2 \dot{\theta}_1 & 0 \end{bmatrix} \begin{bmatrix} \dot{\theta}_1 \\ \dot{\theta}_2 \end{bmatrix} = \begin{bmatrix} \tau_{c1} \\ \tau_{c2} \end{bmatrix} \quad (25)$$

A. If there is no external force

When there are no external disturbances, the computed joint torque is equal to the torque resulted from the controller as

$$\tau_1 = \tau_{c1} \text{ and } \tau_2 = \tau_{c2} \quad (26)$$

By substituting (26) into (25) and make the equality with (2), the equation for the entire system is derived as

$$\begin{bmatrix} \ddot{e}_1 + K_{d1}\dot{e}_1 + K_{p1}e_1 \\ \ddot{e}_2 + K_{d2}\dot{e}_2 + K_{p2}e_2 \end{bmatrix} = 0.0 \quad (27)$$

B. If there is external force that is perpendicular to link 1

According to the equations (5-8) and (25), the computed joint torques for the two joints are derived as

$$\begin{bmatrix} \tau_1 \\ \tau_2 \end{bmatrix} = \begin{bmatrix} \tau_{c1} \\ \tau_{c2} \end{bmatrix} + \begin{bmatrix} Fr_1 \\ 0 \end{bmatrix} \quad (28)$$

By substituting (25) into (28) and make the equality with (2), then the equation for the entire system is derived as

$$\begin{bmatrix} \ddot{e}_1 + K_{d1}\dot{e}_1 + K_{p1}e_1 \\ \ddot{e}_2 + K_{d2}\dot{e}_2 + K_{p2}e_2 \end{bmatrix} = - \begin{bmatrix} \alpha + 2\beta c_2 & \delta + \beta c_2 \\ \delta + \beta c_2 & \delta \end{bmatrix}^{-1} \begin{bmatrix} Fr_1 \\ 0 \end{bmatrix} \quad (29)$$

C. If there is external force that is perpendicular to link 2

From equations (9-14) and (25), the computed joint torques for the two joints are calculated by

$$\begin{bmatrix} \tau_1 \\ \tau_2 \end{bmatrix} = \begin{bmatrix} \tau_{c1} \\ \tau_{c2} \end{bmatrix} + \begin{bmatrix} 2Fr_2 + FL_1 \cos(\theta_2) \\ 2Fr_2 + FL_1 \cos(\theta_2) - FL_1 \sin(\theta_2) d(\theta_1 + \theta_2) \end{bmatrix} \quad (30)$$

By substituting (25) into (30) and make the equality with (2), then the equation for the entire system is derived as

$$\begin{bmatrix} \ddot{e}_1 + K_{d1}\dot{e}_1 + K_{p1}e_1 \\ \ddot{e}_2 + K_{d2}\dot{e}_2 + K_{p2}e_2 \end{bmatrix} = - \begin{bmatrix} \alpha + 2\beta c_2 & \delta + \beta c_2 \\ \delta + \beta c_2 & \delta \end{bmatrix}^{-1} \begin{bmatrix} 2Fr_2 + FL_1 \cos(\theta_2) \\ 2Fr_2 + FL_1 \cos(\theta_2) - FL_1 \sin(\theta_2) d(\theta_1 + \theta_2) \end{bmatrix} \quad (31)$$

After calculating the joint torques τ_1 and τ_2 whether there is disturbance or no, then substituting their values into (2) to calculate the actual acceleration as

$$\begin{bmatrix} \ddot{\theta}_1 \\ \ddot{\theta}_2 \end{bmatrix} = \begin{bmatrix} \alpha + 2\beta c_2 & \delta + \beta c_2 \\ \delta + \beta c_2 & \delta \end{bmatrix}^{-1} \left(\begin{bmatrix} \tau_1 \\ \tau_2 \end{bmatrix} - \begin{bmatrix} -\beta s_2 \dot{\theta}_2 & -\beta s_2 (\dot{\theta}_1 + \dot{\theta}_2) \\ \beta s_2 \dot{\theta}_1 & 0 \end{bmatrix} \begin{bmatrix} \dot{\theta}_1 \\ \dot{\theta}_2 \end{bmatrix} \right) \quad (32)$$

By make the integral for $\ddot{\theta}_1$ and $\ddot{\theta}_2$, the actual velocity and position are determined.

4. Simulation Study

A program in Matlab is implemented based on the computed torque control for the multiple joints motion to simulate the reality and show the differences between the actual and the reference positions, velocities, accelerations, and torques of the two joints whether there is external force or no.

4.1. Determining the Parameters

The parameters used during the simulation are real data and collected from the KUKA LWR robot datasheet [17] as shown in table I. A sinusoidal motion is commanded to the two joints as

$$\theta_d(t) = A - A \cos(2\pi ft) \quad (33)$$

where A is the range of the sinusoidal motion in radians $= \frac{\pi}{4}$,
 f is the frequency of the sinusoidal motion.

Using Zeigler-Nichols rules, the PD gains that give the best performance are given as

$$K_{p1} = 4, K_{d1} = 4, K_{p2} = 4, K_{d2} = 4$$

Table I. The values of the parameters used in the simulation [17]

Parameter	Value
L_1	0.39 m
r_1	0.195 m
r_2	0.078 m
m_1	3.3 kg
m_2	0.3 kg
I_{z1}	$m_1 r_1^2 \approx 0.1255 \text{ kg.m}^2$
I_{z2}	$m_2 r_2^2 \approx 0.00183 \text{ kg.m}^2$

4.2. The Results

The diagrams of the actual and desired joints positions, velocities, accelerations and the computed joint torques τ_1 and τ_2 whether there is external force or no are shown from Fig. 5 to Fig. 7.

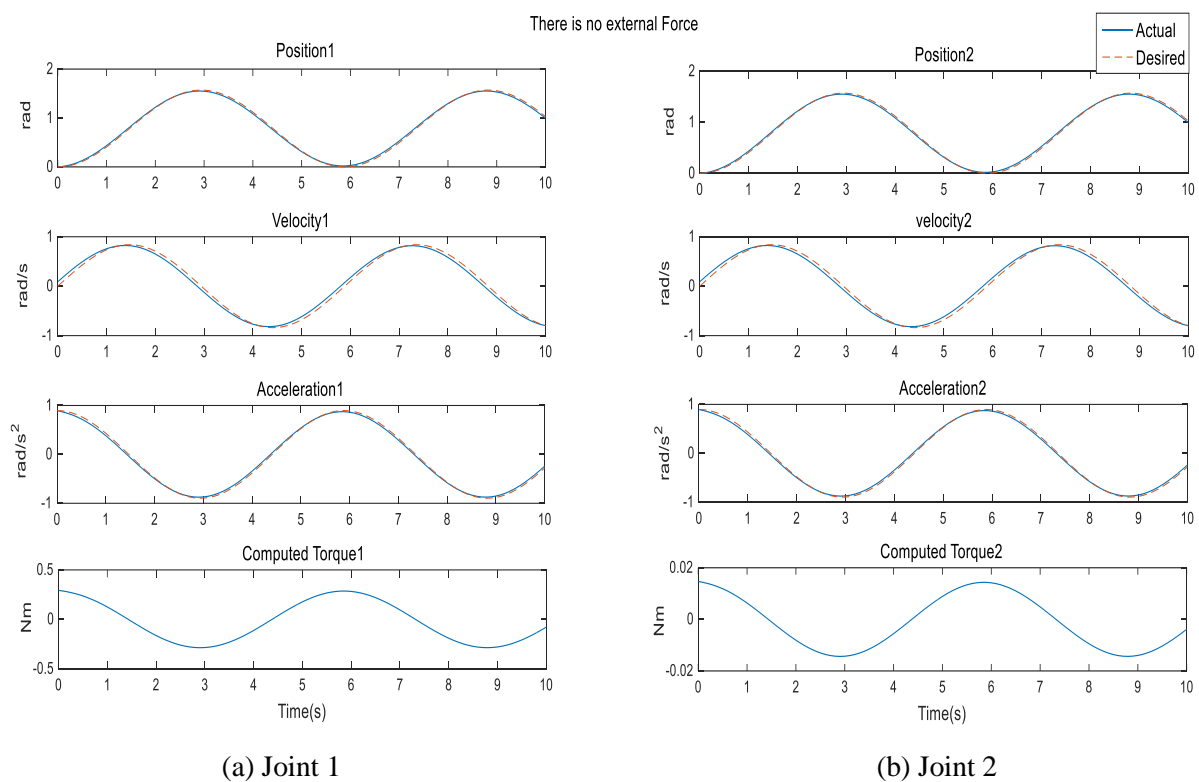

Figure 5. The actual and desired joints' positions, velocities, accelerations and the computed torques when there is no external forces.

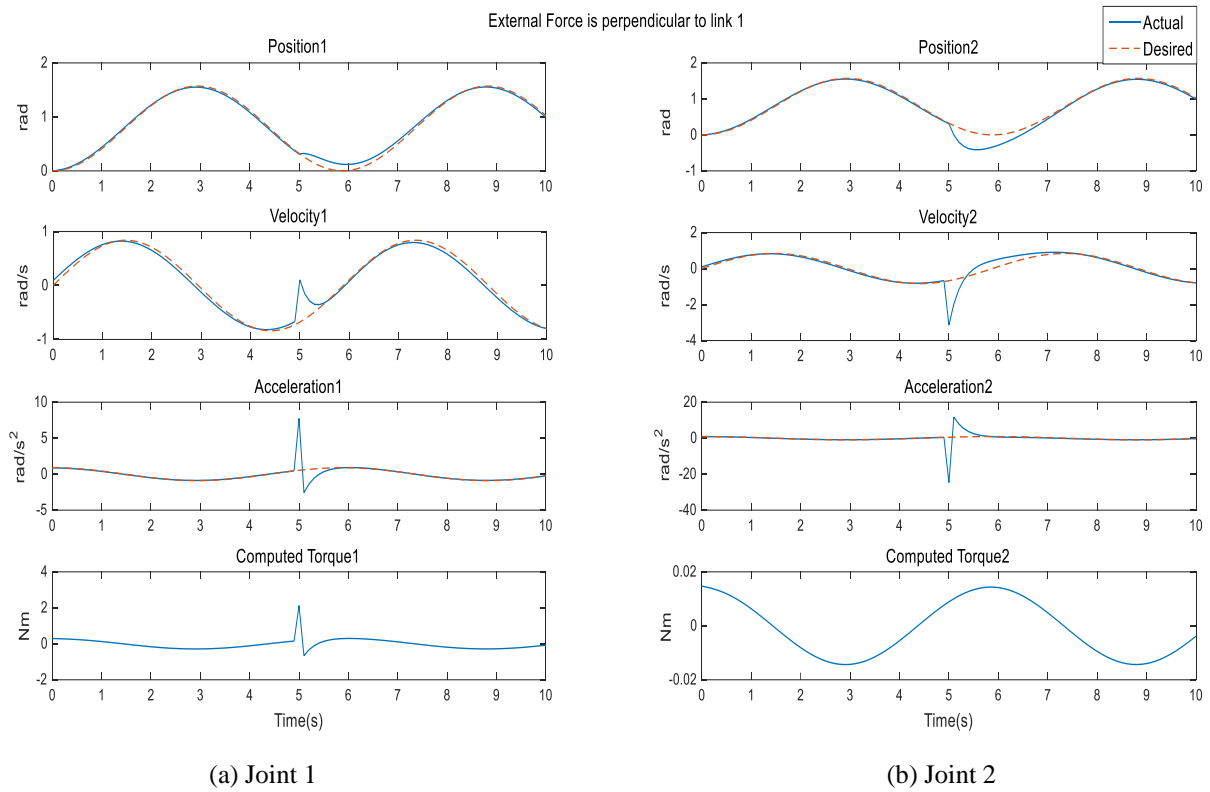

Figure 6. The actual and desired joints' positions, velocities, accelerations and the computed torques when there is external force perpendicular to link 1 and equal to 10 N at time = 5 sec.

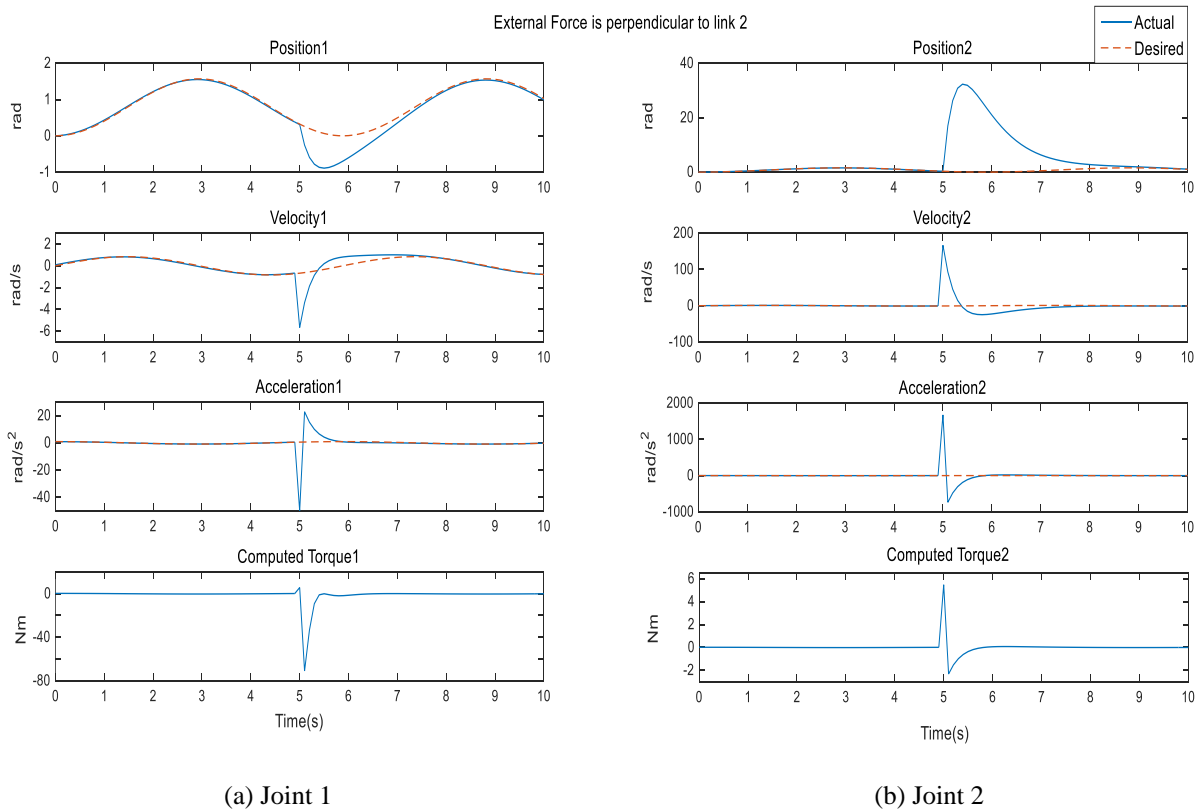

Figure 7. The actual and desired joints' positions, velocities, accelerations and the computed torques when there is external force perpendicular to link 2 and equal to 10 N at time = 5 sec.

As shown from the results the actual joint position, velocity and acceleration are approximately coincide with the desired (reference) signals (Fig. 5) because of using the PD-controller. The errors between the actual signals and desired ones are very small (neglected), therefore, we can conclude that the PD-controller works very well and is a robust controller.

When there is external force or disturbance, the actual signal is affected by this force at the time when the force exerts on the link (time = 5 s in Fig.6 and Fig. 7) then the PD-controller tries to coincide again the actual signal with the desired signal after the force effect finishes.

The dynamic coupling between the joints of the manipulators are presented from the figures (Fig. 6 and Fig. 7) and discussed as following:

- When there is external force (or in another words collision) whether on link 1 or link 2, these variables; position, velocity and acceleration of joint 2 are more affected than of joint 1. When the force exerts on link 2 the effect of this force on these variables is more than when it exerts on link 1 and this is observed also from the mathematical calculations.
- The computed torque of joint 1 is higher than of joint 2 in any case whether there is collision or no. In the case where the force is perpendicular to link 1, there is no change on the computed torque of joint 2 (Fig. 6b) whereas the computed torque of joint 1 is affected at the time when the force exerts on the link (Fig. 6a). When the collision on link 2, both the computed torques are affected at the time when the force exerts on the link whereas the computed torque of joint 1 is affected more than of joint 2 because of the higher lever-arm (Fig. 7).

5. Conclusions

In this paper, the mathematical modelling of the 2-DOF manipulator dynamics is presented. The analysis is presented in two cases; the first one without collisions applied to the links of the manipulator, whereas the second one is the collided applied case. The Computed-Torque Control is also presented and a simulation study is executed using a sinusoidal motion commanded simultaneously to the two joints of the manipulator. The results prove that the computed-torque control is effectively minimizing the error between the actual signals and the desired signals of the joints' positions, velocities, accelerations and torques of the manipulator. Moreover, the dynamic coupling between the joints is presented. The dynamic coupling between the manipulator joints should be considered during the design and implementing the human-robot collision detection method and collided link identification which contribute to the safety of the human-robot interaction.

References

- [1] J. Shah, S. S. Rattan, and B. C. Nakra, "DYNAMIC ANALYSIS OF TWO LINK ROBOT MANIPULATOR FOR CONTROL DESIGN USING COMPUTED TORQUE CONTROL," *Int. J. Res. Comput. Appl. Robot.*, vol. 3, no. 1, pp. 52–59, 2015.
- [2] R. Di Gregorio, "Dynamic model and performances of 2-DOF manipulators," *Robotica*, vol. 24, no. 2006, pp. 51–60, 2019.
- [3] D. Naderi, A. Meghdari, and M. Durali, "Dynamic modeling and analysis of a two d . o . f . mobile manipulator," *Robotica*, vol. 19, pp. 177–185, 2001.

- [4] H. Høifødt, “Dynamic Modeling and Simulation of Robot Manipulators,” Norwegian University of Science and Technology Department, 2011.
- [5] M. Shahab, *2DOF Robotic Manipulator: Control Design & Simulation*, vol. 20, December. 2008.
- [6] A. Sharkawy, P. N. Koustoumpardis, and N. Aspragathos, “Human – robot collisions detection for safe human – robot interaction using one multi-input – output neural network,” *Soft Comput.*, vol. 7, 2019.
- [7] Z. Song, J. Yi, D. Zhao, and X. Li, “A computed torque controller for uncertain robotic manipulator systems : Fuzzy approach,” *Fuzzy Sets Syst.*, vol. 154, pp. 208–226, 2005.
- [8] R. H. MIDDLETON and G. C. GOODWIN, “Adaptive computed torque control for rigid link manipulations,” *Syst. Control Lett.*, vol. 10, pp. 9–16, 1988.
- [9] Z. Yang, J. Wu, J. Mei, J. Gao, and T. Huang, “Mechatronic Model Based Computed Torque Control of a Parallel Manipulator,” *Int. J. Adv. Robot. Syst.*, vol. 5, no. 1, pp. 123–128, 2008.
- [10] O. O. Obadina, M. Thaha, K. Althoefer, and M. H. Shaheed, “A Modified Computed Torque Control Approach for a Master-Slave Robot Manipulator System,” in *Towards Autonomous Robotic Systems. TAROS 2018. Lecture Notes in Computer Science*, vol. vol 10965, M. Giuliani, T. Assaf, and M. Giannaccini, Eds. Springer, Cham, 2018, pp. 28–39.
- [11] M. A. Llama, R. Kelly, and V. Santibañez, “Stable Computed-Torque Control of Robot Manipulators via Fuzzy Self-Tuning,” *IEEE Trans. Syst. MAN, Cybern. B*, vol. 30, no. 1, pp. 143–150, 2000.
- [12] R. M. Murray, Z. Li, and S. S. Sastry, *A Mathematical Introduction to Robotic Manipulation*. CRC Press, 1994.
- [13] L. R. HUNT, R. SU, and G. MEYER, “Global Transformations of Nonlinear Systems,” *IEEE TRANSACTIONS Autom. Control*, vol. AC-28, no. I, pp. 24–31, 1983.
- [14] E. G. Gilbert and I. J. HA, “An Approach to Nonlinear Feedback Control with Applications to Robotics,” *IEEE Trans. ONSYSTEMS, MAN, Cybern.*, vol. SMC-14, no. 6, pp. 879–884, 1984.
- [15] F. L. LEWIS, D. M. Dawson, and C. T. Abdallah, *Manipulator Control Theory and Practice*. NEW YORK • BASEL: MARCEL DEKKER, INC., 2004.
- [16] D. Receanu, “Modeling and Simulation of the Nonlinear Computed Torque Control in Simulink / MATLAB for an Industrial Robot,” *SL*, vol. 10, no. 2, pp. 95–106, 2013.
- [17] KUKA Roboter GmbH, *Lightweight Robot 4+, Specification*. D-86165 Augsburg, Germany, 2010.